

SIEMENS

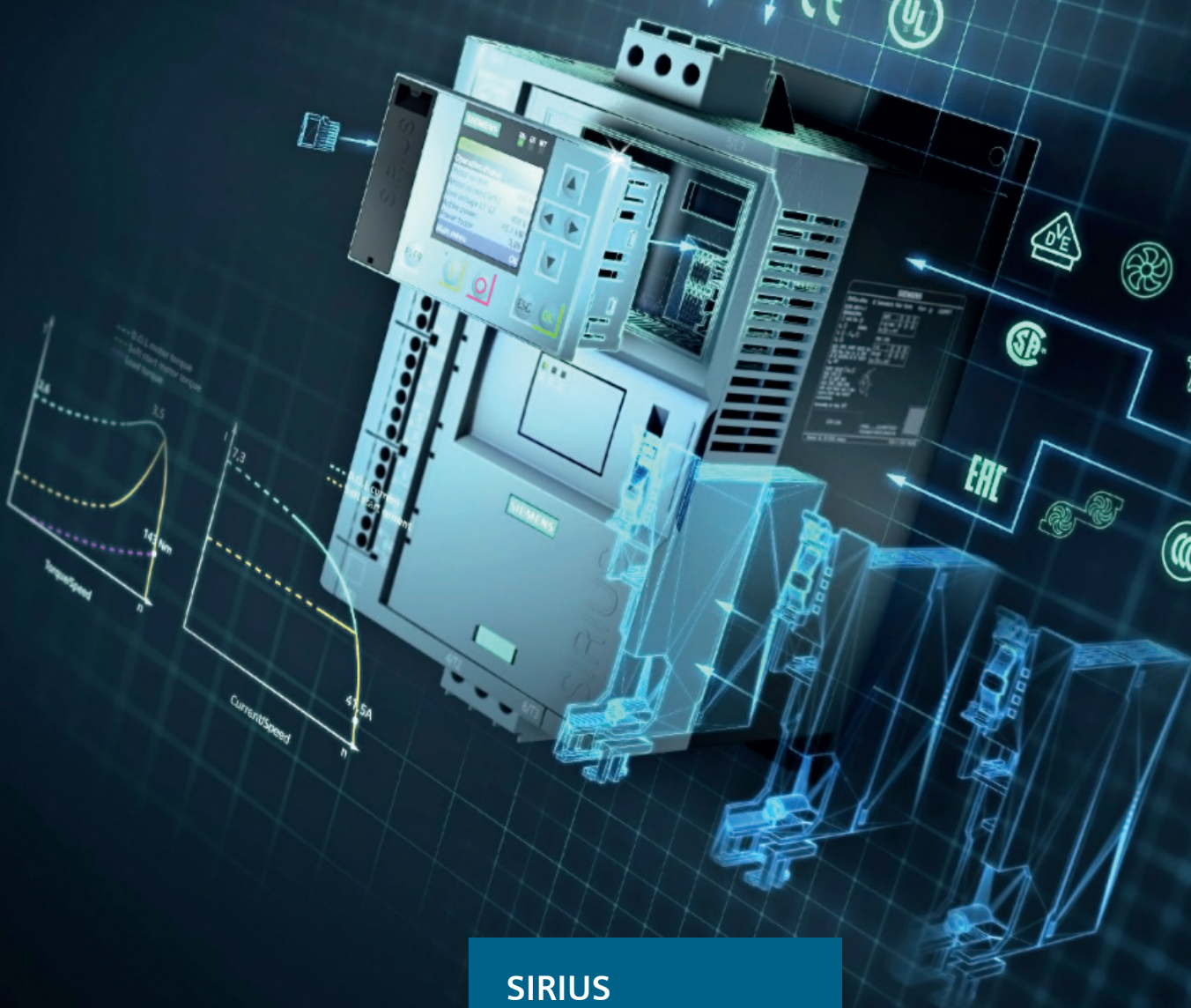

SIRIUS

Industrial Controls

SIRIUS 3RW soft starters

Catalog
Abridged
IC 10 A

Edition
April
2018

siemens.com/soft-starter

Related catalogs

Industrial Controls SIRIUS

IC 10



PDF (E86060-K1010-A101-A8-7600)

Industrial Controls SIRIUS Classic

IC 10 AO



PDF (E86060-K1010-A191-A5-7600)

Industrial Communication SIMATIC NET

IK PI



E86060-K6710-A101-B8-7600

SIMATIC

Products for
Totally Integrated Automation

ST 70



E86060-K4670-A101-B6-7600

Low-Voltage Power Distribution and Electrical Installation Technology

LV 10

SENTRON • SIVACON • ALPHA
Protection, Switching, Measuring and Monitoring
Devices, Switchboards and Distribution Systems

PDF/print (E86060-K8280-A101-A6-7600)

SIMOTICS GP, SD, XP, DP Low-Voltage Motors

D 81.1

Type series 1FP1, 1LE1, 1MB1 and 1PC1
Frame sizes 71 to 315
Power range 0.09 to 200 kW
E86060-K5581-A111-A9-7600

SITOP

SITOP
Power supply

KT 10.1



E86060-K2410-A101-B3-7600

SITRAIN

Training for Industry

www.siemens.com/sitrain

Miscellaneous

Products for Automation and Drives

CA 01

Interactive Catalog
Downloadwww.siemens.com/ca01download

Industry Mall

Information and Ordering Platform
on the Internet:www.siemens.com/industrymall

Siemens TIA Selection Tool

for the selection, configuration and ordering of
TIA products and deviceswww.siemens.com/tst

Information and Download Center

Digital versions of the catalogs are available
on the Internetwww.siemens.com/sirius/catalogs

Contact

Your personal contact can be found in our
Contacts Database at:www.siemens.com/automation-contact

Trademarks

All product designations may be registered trademarks or product names of Siemens AG or other supplying companies. Third parties using these trademarks or product names for their own purposes may infringe upon the rights of the trademark owners.

Further information about industrial controls:
www.siemens.com/sirius

Technical Assistance

Expert technical assistance
for Industrial controls:
Tel.: +49 (911) 895-5900
Fax: +49 (911) 895-5907

E-Mail: technical-assistance@siemens.com



Industrial Controls

SIRIUS



Catalog IC 10 A · 04/2018

With prices valid from April 1, 2018

The Catalog Abridged IC 10 A · 04/2018 is an extract from the Catalog IC 10 · 2018 with updated contents. This abridged version replaces the corresponding contents of Catalog IC 10 · 2018.

Refer to the Industry Mall for regular updates of all contents of Catalog IC 10:
www.siemens.com/industrymall

Please contact your local Siemens branch.

© Siemens AG 2018



The products and systems described in this catalog are manufactured/distributed under application of a certified quality management system in accordance with EN ISO 9001 (for the Certified Registration Nos. see www.siemens.com/system-certificates/cp). The certificate is recognized by all IQNet countries.

1	Introduction	
2	Industrial Communication	
3	Switching Devices – Contactors and Contactor Assemblies – for Switching Motors	
4	Switching Devices – Contactors and Contactor Assemblies – Special Applications	
5	Switching Devices – Contactors and Contactor Assemblies – Contactor Relays and Relays	
6	Switching Devices – Soft Starters and Solid-State Switching Devices	
7	Protection Equipment	
8	Load Feeders and Motor Starters for Use in the Control Cabinet	
9	Motor starters for Use in the Field, High Degree of Protection	
10	Monitoring and Control Devices	
11	Safety Technology	
12	Position and Safety Switches	
13	Commanding and Signaling Devices	
14	Parameterization, Configuration and Visualization with SIRIUS	
15	Power Supply	
16	Appendix	

Industrial Controls

Ordering notes

Things you should know about Catalog Abridged IC 10 A

Catalog Abridged IC 10 contains all selection and order-relevant data.

Ordering notes

Ordering special versions

When ordering products that differ from the versions listed in the catalog, the article number specified in the catalog must be supplemented with "-Z"; the required features must be specified by means of the alphanumeric order codes or in plain text.

Small orders

When small orders are placed, the costs associated with order processing are greater than the order value. We recommend therefore that you combine several small orders. Where this is not possible, we unfortunately have to charge a processing supplement of € 20.– to cover our costs for order processing and invoicing for all orders with a net goods value of less than € 250.–.

Standard delivery time (SD)

SD in days (d)

► Preferred type

X On request

Preferred types are available immediately from stock, i.e. are dispatched within 24 hours.

Normal quantities of the products are usually delivered within the specified time following receipt of your order at our branch.

In exceptional cases, the actual delivery time may differ from that specified.

The delivery times apply up to the ramp at Siemens AG (products ready for dispatch). The transport times depend on the destination and type of shipping. The standard transport time for Germany is one day.

The delivery times specified here represent the situation in March 2018. They are continuously optimized. For more up-to-the-minute information, please visit www.siemens.com/sirius/mall.

Price units (PU)

The price unit defines the number of units, sets or meters to which the specified price applies.

Packaging sizes (PS)

The packaging size defines the number, e.g. of units, sets or meters, contained in an outer packaging.

Only the quantity defined by the packaging size or a multiple thereof can be ordered.

For multi-unit packing and reusable packaging, see page 16/5.

Price groups (PG)

Each product is assigned to a price group.

Example

3RA2110-0FA15-1AP0

SD: 2 working days

PG: 41D

Order quantity 1 unit or a multiple thereof

3RV1901-0H

SD: Preferred type

PG: 41E

Order quantity 10 units or a multiple thereof

3SU1900-0AB71-0AB0

SD: 5 working days

PG: 41J

Order quantity 10 units or a multiple thereof

SD	Article No.	Price per PU	PU (UNIT, SET, M)	PS*	PG
d					
2	3RA2110-0FA15-1AP0		1	1 unit	41D
►	3RV1901-0H		1	10 units	41E
5	3SU1900-0AB71-0AB0		100	10 units	41J

Dimensions

All dimensions in mm.

Switching Devices – Soft Starters and Solid-State Switching Devices

**NEW**

Click on an article number in the catalog PDF to call it up in the Industry Mall and you will have access to all the required information.

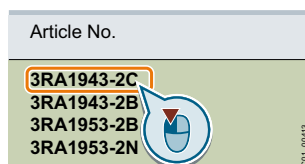

Or directly on the Internet, e.g.
www.siemens.com/product?3RA1943-2C

	Price groups PG 14O, 41B, 41C, 41E, 41F, 41H, 41J, 42G, 42H, 42J, 42S		
6/2	Introduction		
	SIRIUS 3RW soft starters		
6/4	General data <u>High Performance soft starters</u>		
6/11	<u>3RW55 soft starters</u> NEW		
6/15	- Inline circuit NEW		
6/17	- Inside-delta circuit NEW		
6/19	- Accessories NEW		
6/21	3RW44 soft starters		
6/30	- Inline circuit		
6/33	- Inside-delta circuit		
6/35	- Accessories		
	<u>General Performance soft starters</u>		
6/36	<u>3RW52 soft starters</u> NEW		
6/40	- Inline circuit NEW		
6/42	- Inside-delta circuit NEW		
6/44	- Accessories NEW		
	<u>Basic Performance soft starters</u>		
6/46	3RW40 soft starters		
6/54	- Inline circuit		
6/57	- Accessories		
6/60	3RW30 soft starters		
6/68	- Inline circuit		
6/69	- Accessories		
	<u>Spare parts</u>		
6/71	- for 3RW55 NEW		
6/74	- for 3RW44		
6/77	- for 3RW52 NEW		
6/80	- for 3RW40		
14/1	<u>Software</u>		
		Solid-state switching devices for resistive/inductive loads	
6/59	General data <u>Solid-state relays</u>		
6/64	General data		
6/65	SIRIUS 3RF21 solid-state relays, single-phase, 22.5 mm		
6/70	SIRIUS 3RF20 solid-state relays, single-phase, 45 mm		
6/74	SIRIUS 3RF22 solid-state relays, three-phase, 45 mm <u>Solid-state contactors</u>		
6/77	General data		
6/78	SIRIUS 3RF23 solid-state contactors, single-phase		
6/88	SIRIUS 3RF24 solid-state contactors, three-phase <u>Function modules</u>		
6/92	General data		
6/99	SIRIUS converters for 3RF2		
6/100	SIRIUS load monitoring for 3RF2		
6/101	SIRIUS heating current monitoring for 3RF2		
6/102	SIRIUS power controllers for 3RF2		
6/103	SIRIUS power regulators for 3RF2		
		Solid-state switching devices for switching motors	
		<u>Solid-state contactors</u>	
6/104	General data		
6/108	SIRIUS 3RF34 solid-state contactors, three-phase		
6/112	SIRIUS 3RF34 solid-state reversing contactors, three-phase		

Switching Devices – Soft Starters and Solid-State Switching Devices

Introduction

Overview

More information

Homepage, see www.siemens.com/soft-starter
 Industry Mall, see www.siemens.com/product?3RW

Online configurator, see www.siemens.com/sirius/configurators
 Simulation Tool for Soft Starters (STS), see page 14/5 or
<https://support.industry.siemens.com/cs/ww/en/view/101494917>



3RW55



3RW44



3RW52



3RW40



3RW30

Page

3RW soft starters

High Performance soft starters

3RW55 soft starters

- TIA integration optional
- Plug-in communication modules for PROFINET, PROFIBUS and Modbus TCP
- Removable HMI module with color display, local interface and slot for a micro SD memory card
- Extended protection functions
- Up to 560 kW at 400 V (can be used in supply systems up to 690 V)
- Automatic parameterization for easy commissioning and reliability even under changing load conditions
- Hybrid switching devices and three-phase motor control for minimum power loss and optimum/symmetrical motor control
- Pump stop for reduced mechanical stress and optimum pump stop control

6/11

3RW44 soft starters

- TIA Integration optional
- PROFIBUS and PROFINET
- Integrated display
- External Display/control module optional
- Extended protection functions
- Up to 1200 kW at 400 V (can be used in supply systems up to 690 V)

6/21

General Performance soft starters

3RW52 soft starters

- TIA integration optional
- Plug-in communication modules for PROFINET, PROFIBUS and Modbus
- HMI modules optional
- Soft starting and stopping
- Current limiting
- Motor overload protection
- Up to 560 kW at 400 V (can be used in supply systems up to 600 V)
- Hybrid switching devices and three-phase motor control
- Soft Torque for reduced mechanical loading and optimum pump stop control
- Parameterization using potentiometers

6/36

Basic Performance soft starters

3RW40 soft starters

- Soft starting and stopping
- Current limiting
- Motor overload protection
- Up to 250 kW at 400 V (can be used in supply systems up to 600 V)

6/46

3RW30 soft starters

- Soft starting with voltage ramp
- Up to 55 kW at 400 V (can be used in supply systems up to 480 V)

6/60

Use of soft starters in conjunction with IE3/IE4 motors

Note:

For the use of SIRIUS 3RW soft starters in conjunction with highly energy-efficient IE3/IE4 motors, please observe the information on dimensioning and configuring, see [Application Manual](#).

For more information, see [page 1/7](#).

More information

Homepage, see www.siemens.com/solid-state-switching-devices
 Industry Mall, see www.siemens.com/product?3RF

Online configurator, see www.siemens.com/sirius/configurators



		Article No.	Page
SIRIUS solid-state switching devices for switching resistive/inductive loads			
Solid-state relays			
Solid-state relays	<ul style="list-style-type: none"> • Widths of 22.5 mm and 45 mm • Compact and space-saving design • "Zero-point switching" version • Mounting onto existing heat sinks 	3RF21 3RF20 3RF22	6/65 6/70 6/74
Solid-state contactors			
Solid-state contactors	<ul style="list-style-type: none"> • Complete units comprising a solid-state relay and an optimized heat sink, "ready to use" • Compact and space-saving design • Versions for resistive loads "zero-point switching" and inductive loads "instantaneous switching" • Special versions "Low Noise" and "Short-Circuit Proof" 	3RF23 3RF24	6/78 6/88
Function modules			
Converters	For extending the functionality of the 3RF21 solid-state relays and the 3RF23 solid-state contactors for many different applications: <ul style="list-style-type: none"> • For converting an analog input signal into an on/off ratio; can also be used on 3RF22 and 3RF24 three-phase switching devices 	3RF2900-0EA18	6/99
Load monitoring	<ul style="list-style-type: none"> • For load monitoring of one or more loads (partial loads) 	3RF29...0FA08, 3RF29.0-0GA..	6/100
Heating current monitoring	<ul style="list-style-type: none"> • For load monitoring of one or more loads (partial loads); remote teach 	3RF29...0JA..	6/101
Power controllers	<ul style="list-style-type: none"> • For setting the current by means of a solid-state switching device depending on a setpoint value set by the power controller. There is a choice of full-wave control and generalized phase control. 	3RF29...0KA.	6/102
Power regulators	<ul style="list-style-type: none"> • For regulating the current by means of a solid-state switching device, depending on a setpoint value set by the power regulator. Closed-loop control: full-wave control or generalized phase control 	3RF29.0-0HA..	6/103
SIRIUS solid-state switching devices for switching motors			
Solid-state contactors			
Solid-state contactors, solid-state reversing contactors	<ul style="list-style-type: none"> • Complete units in the insulated enclosure with integrated heat sink, "ready to use" • Compact and space-saving design • Version for motors, "instantaneous switching" 	3RF34	6/108, 6/112

Use of SIRIUS solid-state switching devices for switching motors in conjunction with IE3/IE4 motors

Note:

For the use of SIRIUS 3RF solid-state switching devices for switching motors in conjunction with highly energy-efficient IE3/IE4 motors, please observe the information on dimensioning and configuring, see [Application Manual](#).

For more information, see [page 1/7](#).

SIRIUS 3RW Soft Starters

General data

Overview

More information

Homepage, see www.siemens.com/soft-starter
 Industry Mall, see www.siemens.com/product?3RW
 SIOS, see <https://support.industry.siemens.com/cs/ww/en/view/109747404>

Simulation Tool for Soft Starters (STS), see <https://support.industry.siemens.com/cs/ww/en/view/101494917>

SIRIUS 3RW soft starters - as versatile as your application

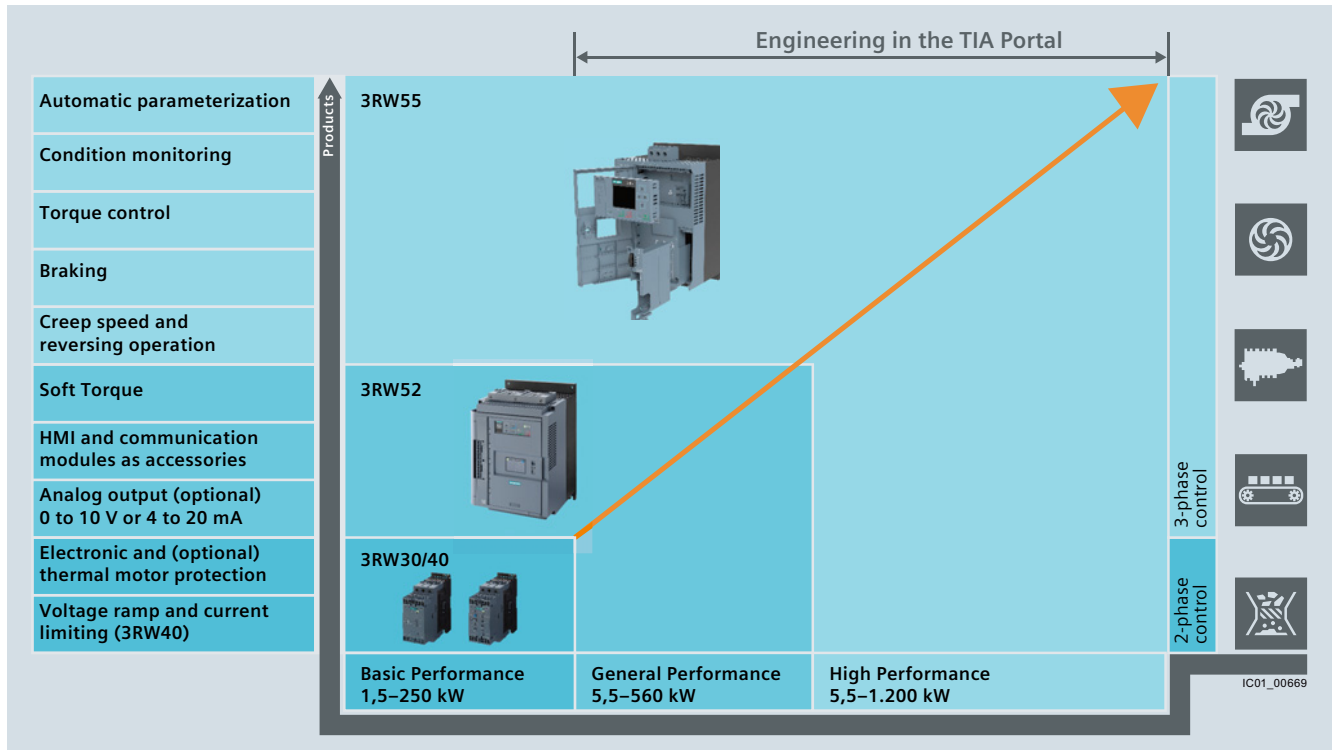

6



Applications	High Performance		General Performance	Basic Performance	
	3RW55	3RW44	3RW52	3RW40	3RW30
Selection aid for soft starters					
Normal starting (CLASS 10)					
Pumps	●	●	●	●	●
Pumps with special pump stop (to prevent water hammer)	●	●	○		
Heat pumps	●	●	●	●	●
Hydraulic pumps	●	●	●	●	○
Presses	●	●	●	●	○
Conveyor belts	●	●	●	●	○
Roller conveyors	●	●	●	●	○
Screw conveyors	●	●	●	●	○
Escalators	●	●	●	●	
Piston compressors	●	●	●	●	
Screw compressors	●	●	●	●	
Small fans ¹⁾	●	●	●	●	
Centrifugal blowers	●	●	●	●	
Bow thrusters	●	●	●	●	
Heavy starting (CLASS 20)					
Stirrers	●	●	○	○	
Extruders	●	●	○	○	
Lathes	●	●	○	○	
Milling machines	●	●	○	○	
Very heavy starting (CLASS 30)					
Large fans ²⁾	●	●			
Circular saws/bandsaws	●	●			
Centrifuges	●	●			
Mills	●	●			
Crushers	●	●			

- Recommended soft starter
○ Possible soft starter

- ¹⁾ The mass inertia of the fan is <10 times the mass inertia of the motor.
²⁾ The mass inertia of the fan is ≥10 times the mass inertia of the motor.

SIRIUS 3RW Soft Starters

General data



SIRIUS soft starters	High Performance		General Performance	Basic Performance		
	3RW55	3RW44	3RW52	3RW40	3RW30	
General technical specifications						
Operational current at 40 °C	A	13 ... 987	29 ... 1214	13 ... 987	12.5 ... 432	3 ... 106
Operational voltage	V	200 ... 690 ¹⁾	200 ... 690 ¹⁾	200 ... 600	200 ... 600	200 ... 480
Operating power for three-phase motors						
• At 400 V, at 40 °C	- Inline circuit	kW	5.5 ... 315	15 ... 710	5.5 ... 315	1.5 ... 55
	- Inside-delta circuit	kW	11 ... 560	22 ... 1 200	11 ... 560	--
• At 460/480 V at 50 °C	- Inline circuit	hp	7.5 ... 400	15 ... 950	7.5 ... 400	1.5 ... 75
	- Inside-delta circuit	hp	10 ... 750	30 ... 1 700	10 ... 750	--
Ambient temperature ²⁾	°C	-25 ... +60	0 ... +60	-25 ... +60	-25 ... +60	-25 ... +60
Soft starting/ramp-down		✓	✓	✓	✓	✓ ³⁾
Voltage ramp		✓	✓	✓	✓	✓
Starting voltage	%	20 ... 100	20 ... 100	30 ... 100	40 ... 100	40 ... 100
Ramp-up and ramp-down time	s	0 ... 360	0 ... 360	0 ... 20	0 ... 20	0 ... 20 ³⁾
Pump stop (torque control) ⁴⁾		✓	✓	--	--	--
• Starting torque	%	10 ... 100	20 ... 100	--	--	--
• Torque limit	%	20 ... 200	20 ... 200	--	--	--
Soft Torque (torque limit)		--	--	✓	--	--
Integral bypass contact system		✓	✓	✓	✓	✓
Intrinsic device protection		✓	✓	✓	✓	--
Motor overload protection		✓	✓	✓	✓ ⁵⁾	--
Thermistor motor protection evaluation		✓	✓	✓ ⁶⁾	✓ ⁶⁾	--
Analog output		✓	--	✓ ⁶⁾	--	--
Remote RESET		✓	✓	✓	✓ ⁶⁾	--
Adjustable current limiting		✓	✓	✓	✓	--
Inside-delta circuit ¹⁾		✓	✓	✓	--	--
Breakaway pulse		✓	✓	--	--	--
Automatic parameterization		✓	--	--	--	--
Pump cleaning		✓	--	--	--	--
Reversing duty		✓	--	--	--	--
Condition monitoring		✓	--	--	--	--
User account administration ⁸⁾		✓	--	--	--	--
Creep speed in both directions of rotation		✓	✓	--	--	--
DC braking ^{4) 7)}		✓	✓	--	--	--
Combined braking ^{4) 7)}		✓	✓	--	--	--
Motor heating		✓	✓	--	--	--
Communication function ⁹⁾		✓	✓	✓	--	--
HMI module installable in the cabinet door		✓	✓ ⁹⁾	✓ ⁹⁾	--	--
Operating measured value display		✓	✓	✓ ⁹⁾	--	--
Logbooks		✓	✓ ⁸⁾	✓ ⁹⁾	--	--
Event list		✓	✓	--	--	--
Slave pointer function		✓	✓	--	--	--
Trace function ⁸⁾		✓	✓	--	--	--
Programmable control inputs and outputs		✓	✓	--	--	--
Number of parameter sets		3	3	1	1	1
• Parameterizable via software ⁸⁾		✓	✓	--	--	--
Number of controlled phases		3	3	3	2	2
Heavy starting CLASS 30 ⁴⁾		✓	✓	--	--	--

✓ Function available

-- Function not available

1) Inside-delta circuit only up to line voltage 600 V.

2) Note derating above 40 °C.

3) Only soft starting available for 3RW30.

4) Calculate soft starter and motor with size allowance where required.

5) When using the motor overload protection according to ATEX, an upstream contactor is required.

6) Special device versions only.

7) Not possible in inside-delta circuit.

8) With software Soft Starter ES (TIA Portal)

9) Only in conjunction with special accessories.

Boundary conditions

The 3RW soft starter should always be designed on the basis of the required rated operational current of the motor. The motor ratings listed in the selection and ordering data are rough guide values and designed for basic starting conditions (CLASS 10). For other starting conditions we recommend the Simulation Tool for Soft Starters (STS).

Motor rating data in kW and hp is based on IEC 60947-4-1.

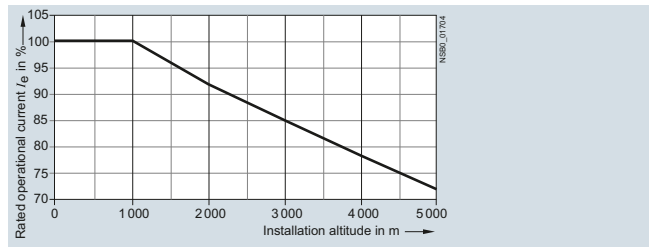

At an installation altitude above 2 000 m, max. permissible operational voltage is reduced to 480 V.

The selection and ordering data were determined for the following boundary conditions (stand-alone installation without additional fan)



SIRIUS soft starters	High Performance	General Performance	Basic Performance		
	3RW55	3RW44	3RW52		
			3RW40		
			3RW30		
Boundary conditions					
Maximum starting time	s	20	10	10	3
Maximum starting current in % of motor current	I_c	300			
Maximum number of starts per hour	1/h	5			20

Simulation Tool for Soft Starters (STS)

The Simulation Tool for Soft Starters (STS) provides a convenient means of designing soft starters using a simple, quick and easy-to-use interface. Entering the motor and load data will simulate the application and prompt suggestions for suitable soft starters.

Link to the free download of the [Simulation Tool for Soft Starters \(STS\)](#).

- Simple, quick and user-friendly interface
- Detailed and up-to-date Siemens motor database, including IE3 and IE4 motors.
- Simulation of heavy starting up to CLASS 30
- Update-capable (e.g. motors, load types, functions)
- Fast simulations with minimum input data
- Immediate, graphical curve charts of start operations with limit values
- Table view of suitable soft starters for the application

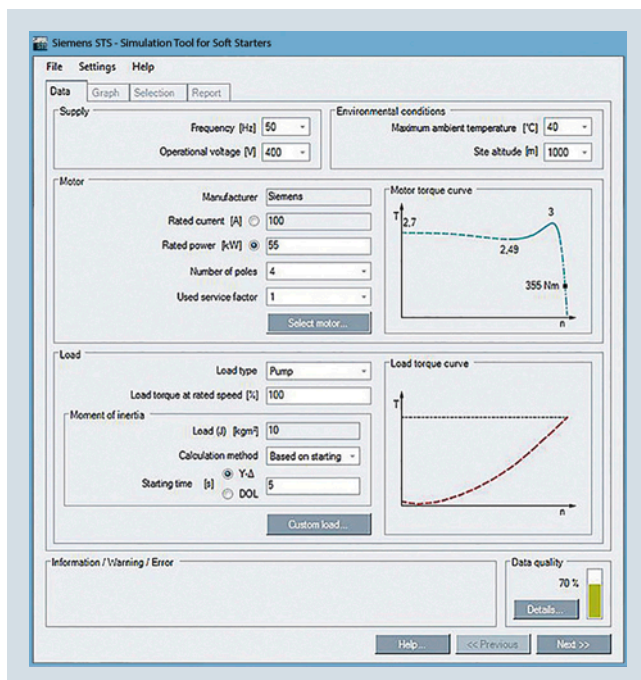

Easy input of motor and load data



Graphic display of start operations

SIRIUS 3RW Soft Starters

General data

Circuit concept

Three-phase controlled SIRIUS 3RW soft starters can be operated in two different types of circuit:

- **Inline circuit**
The controls for isolating and protecting the motor are simply connected in series with the soft starter. The motor is connected to the soft starter with three leads.
- **Inside-delta circuit**
The wiring is similar to that of wye-delta starters. The phases of the soft starter are connected in series with the individual motor windings. The soft starter then only has to carry the phase current, amounting to about 58% of the rated motor current (conductor current).

Comparison of the types of circuit:

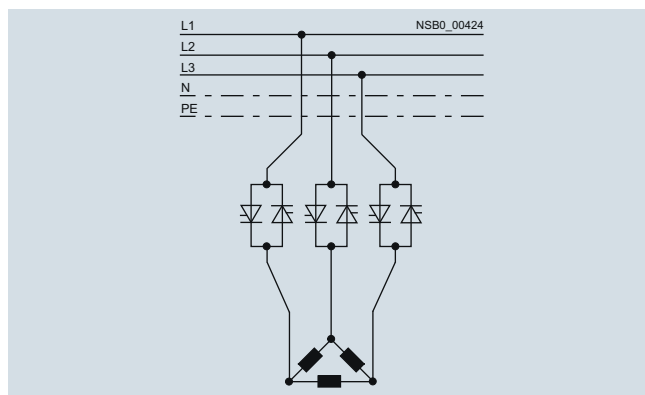

Inline circuit: Rated current I_e corresponds to the rated motor current I_n , three cables to the motor

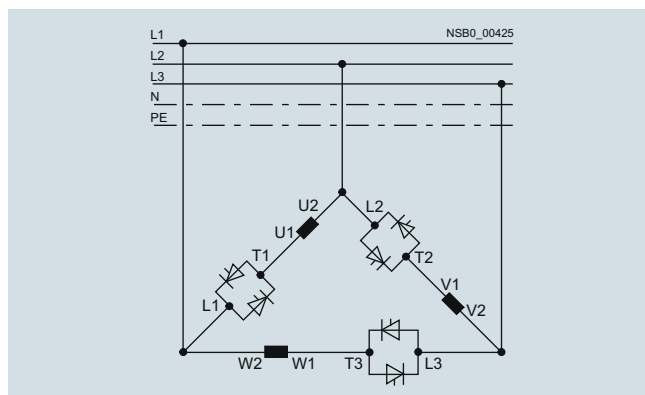

Inside-delta circuit: Rated current I_e corresponds to approx. 58% of the rated motor current I_n , six cables to the motor (as for wye-delta starters)

Which circuit?

Using the inline circuit involves the lowest wiring outlay. If the soft starter to motor connections are long, this circuit is preferable.

The wiring complexity is twice as high when using the inside-delta circuit, but a smaller device can be used with the same rating. Thanks to the choice of operating mode between the inline circuit and inside-delta circuit, it is always possible to select the most favorable solution.

The braking function is possible only in the inline circuit. The inside-delta circuit cannot be used in 690 V line supplies.

Configuration

The solid-state 3RW soft starters are designed for normal starting. In case of heavy starting or increased starting frequency, a larger unit must be selected. The 3RW44 and 3RW52 soft starters may be used in isolated supply networks (IT systems) up to 600 V AC and the 3RW55 soft starter even up to 690 V.

For long starting times it is recommended to have a PTC sensor or temperature switch in the motor. This also applies for the "torque control", "pump stop" and "DC braking" ramp-down modes, because during the ramp-down time in these modes, an additional current loading applies in contrast to free ramp-down.

No capacitive elements are permitted in the motor feeder between the SIRIUS 3RW soft starter and the motor (e.g. no reactive-power compensation equipment). In addition, neither static systems for reactive-power compensation nor dynamic PFC (Power Factor Correction) must be operated in parallel during starting and ramp-down of the soft starter. This is important to prevent faults arising on the compensation equipment and/or the soft starter.

All elements of the main circuit (such as fuses and controls) should be dimensioned for direct-on-line starting, following the load short-circuit conditions. Fuses and switching devices must be ordered separately. The harmonic component load for starting currents must be taken into consideration for the selection of motor starter protectors (selection of release). Please observe the maximum switching frequencies specified in the technical specifications.

Notes:

When three-phase motors are switched on, voltage drops occur as a rule on starters of all types (direct-on-line starters, wye-delta starters, soft starters). The infeed transformer must always be dimensioned such that the voltage dip when starting the motor remains within the permissible tolerance. If the infeed transformer is dimensioned with only a small margin, it is best for the control voltage to be supplied from a separate circuit (independently of the main voltage) in order to avoid the potential switching off of the soft starter.

For dimensioning soft starters, we recommend our Simulation Tool for Soft Starters (STS), see page 6/7.

or our Technical Assistance:

Phone: +49 911 895-5900,

email: technical-assistance@siemens.com.

Recommended parameters for the initial commissioning of our SIRIUS 3RW soft starters are listed in every report of our Simulation Tool for Soft Starters (STS). In addition, our High Performance soft starters provide support by means of their commissioning wizards.

Article No. scheme

Product versions		Article number								
Device type	High Performance soft starters	3RW55	<input type="checkbox"/>	<input type="checkbox"/>	-	<input type="checkbox"/>	<input type="checkbox"/>	<input type="checkbox"/>	<input type="checkbox"/>	<input type="checkbox"/>
		3RW44	<input type="checkbox"/>	<input type="checkbox"/>	-	<input type="checkbox"/>	<input type="checkbox"/>	<input type="checkbox"/>	<input type="checkbox"/>	<input type="checkbox"/>
	General Performance soft starters	3RW52	<input type="checkbox"/>	<input type="checkbox"/>	-	<input type="checkbox"/>	<input type="checkbox"/>	<input type="checkbox"/>	<input type="checkbox"/>	<input type="checkbox"/>
		Basic Performance soft starters	3RW40	<input type="checkbox"/>	<input type="checkbox"/>	-	<input type="checkbox"/>	<input type="checkbox"/>	<input type="checkbox"/>	<input type="checkbox"/>
	3RW30		<input type="checkbox"/>	<input type="checkbox"/>	-	<input type="checkbox"/>	<input type="checkbox"/>	<input type="checkbox"/>	<input type="checkbox"/>	<input type="checkbox"/>
Size/rated operational current I_e	e. g. 15 = 25 A in size S1	<input type="checkbox"/>	<input type="checkbox"/>							
Connection type	e.g. 1 = screw terminal					<input type="checkbox"/>				
Soft starter functionality	e.g. AC = with bypass and analog output, three-phase controlled						<input type="checkbox"/>	<input type="checkbox"/>		
Rated control supply voltage U_s	e.g. 0 = 24 V AC/DC								<input type="checkbox"/>	
Rated operational voltage U_e	e.g. 4 = 200 ... 480 V AC									<input type="checkbox"/>
Example		3RW52	1	5	-	1	A	C	0	4

Note:

The Article No. scheme shows an overview of product versions for better understanding of the logic behind the article numbers.

For your orders please use the article numbers quoted in the selection and ordering data.

SIRIUS 3RW Soft Starters

General data

Benefits

Can be flexibly deployed in many applications

Strong portfolio:
comprehensive, coordinated soft starter portfolio

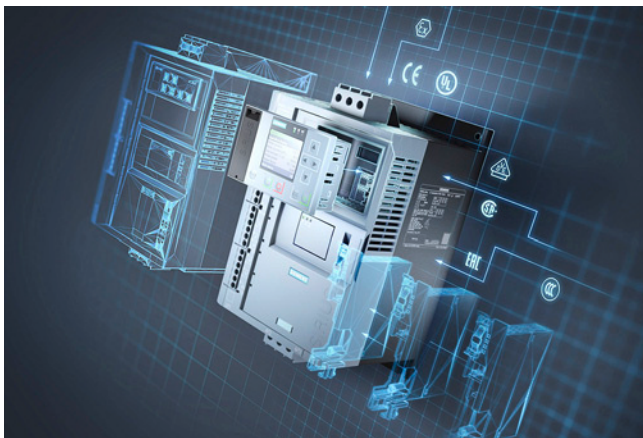

- The right hardware for all requirements, soft starters for tasks ranging from simple to demanding starting in Basic, General and High Performance versions
- Extensive portfolio for individual expansion:
Optional HMIs for installation in the device or mounting on the control cabinet door
Communication via PROFINET/PROFIBUS and Modbus
- Designer enclosure with removable terminals, space-saving thanks to compact design and rugged thanks to coated printed circuit boards
- Can be used worldwide thanks to numerous certificates and approvals, IEC, UL, CSA, CCC

Intelligent operation:
concentrated, application-specific functionality

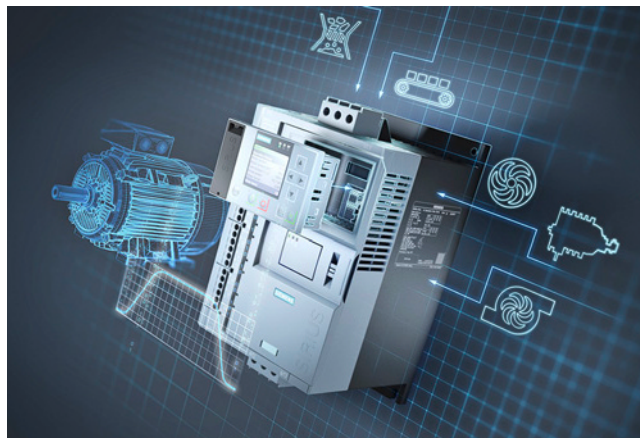

- Can be used in a wide variety of applications:
Pumping, ventilating, compressing, moving and processing
- Integrated, self-learning automatic parameterization depending on motor starting conditions
- Application-specific functionality such as pump cleaning and pump stop
- Condition monitoring:
Current and energy monitoring with warning and alarm limits, starting time monitoring

Efficient switching:
hybrid switching technology on board

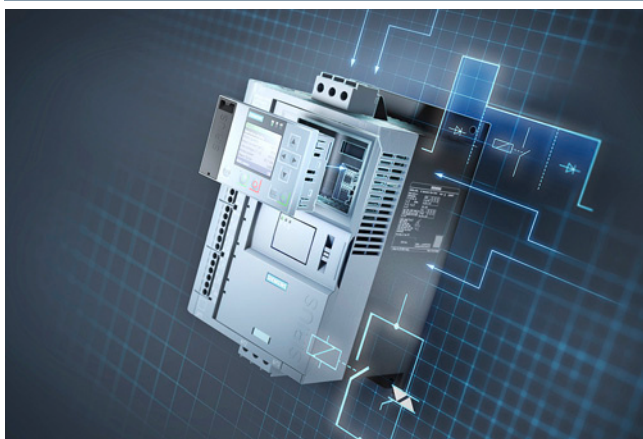

- Energy-efficient switching and mechanical protection of the drive train thanks to soft starters with hybrid switching technology
- Low-wear switching extends the service life of the devices
- Soft starting prevents current spikes, thereby increasing the network stability
- Protection against disturbances in the application.
Mechanical protection for the drive train

Ready for a digital future:
data available whenever and wherever needed

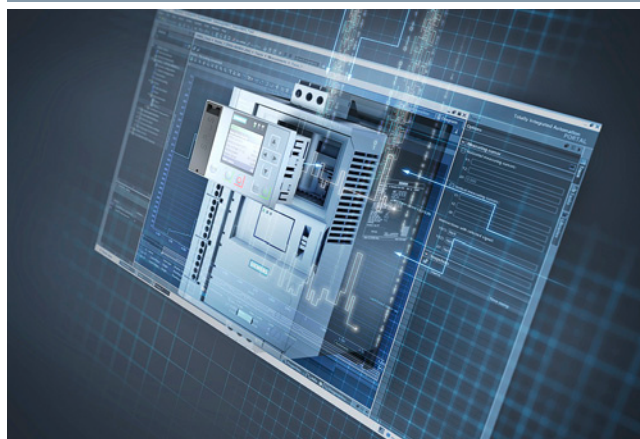

- Support from tools and data during engineering
- Simulation Tool for Soft Starters for support during product selection
- Very simple, standardized commissioning and configuration via Soft Starter ES in TIA Portal
- Integration in the automation system via communication interfaces
- Data availability and analysis: large volumes of data at any time and anywhere, even into MindSphere

Overview

More information

Homepage, see www.siemens.com/soft-starter
 Industry Mall, see www.siemens.com/product?3RW

Simulation Tool for Soft Starters (STS), see page 6/7 or <https://support.industry.siemens.com/cs/ww/en/view/101494917>
 SIRIUS Soft Starter ES (TIA Portal), see pages 14/6 and 14/9



Equipped with the utmost functionality, the SIRIUS 3RW55 High Performance soft starters confidently handle even difficult starting and stopping operations. Thanks to innovative torque control, the device can be used for drives with an output between 5.5 kW and 560 kW (at 400 V).

The functions have been specially designed to offer maximum user friendliness. By means of the detachable HMI (with color display, local interface and a slot for MicroSD memory card) and plug-in communication modules (PROFINET, PROFIBUS, Modbus), they ensure maximum flexibility. With their modern hybrid switching technology, the SIRIUS 3RW55 soft starters offer efficient switching for long-term, energy-saving use.

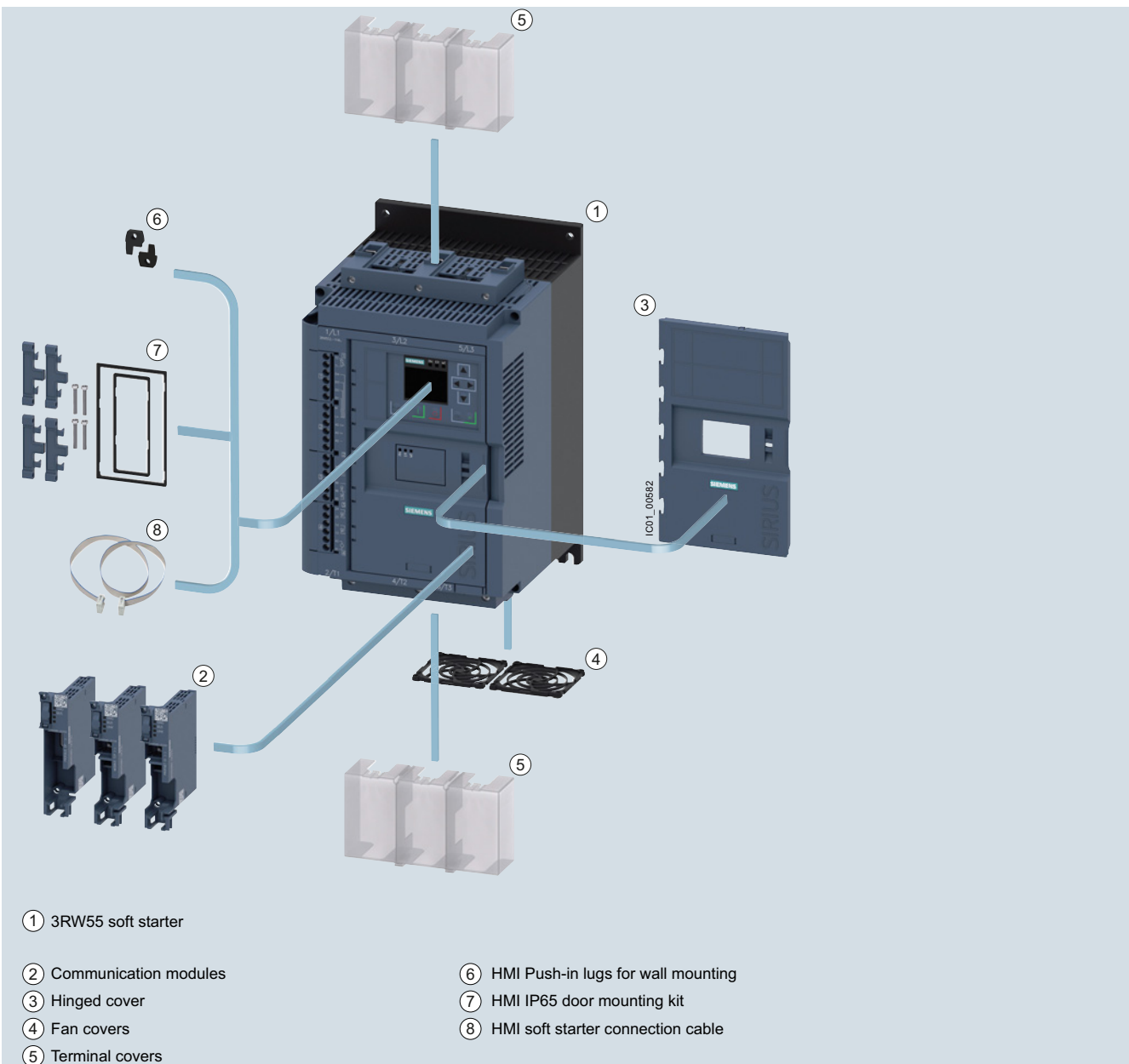

① 3RW55 soft starter

② Communication modules

③ Hinged cover

④ Fan covers

⑤ Terminal covers

⑥ HMI Push-in lugs for wall mounting

⑦ HMI IP65 door mounting kit

⑧ HMI soft starter connection cable

3RW55 High Performance soft starters - accessories, see page 6/19.

SIRIUS 3RW Soft Starters

High Performance Soft Starters

3RW55 Soft Starters

General data **NEW**

Benefits

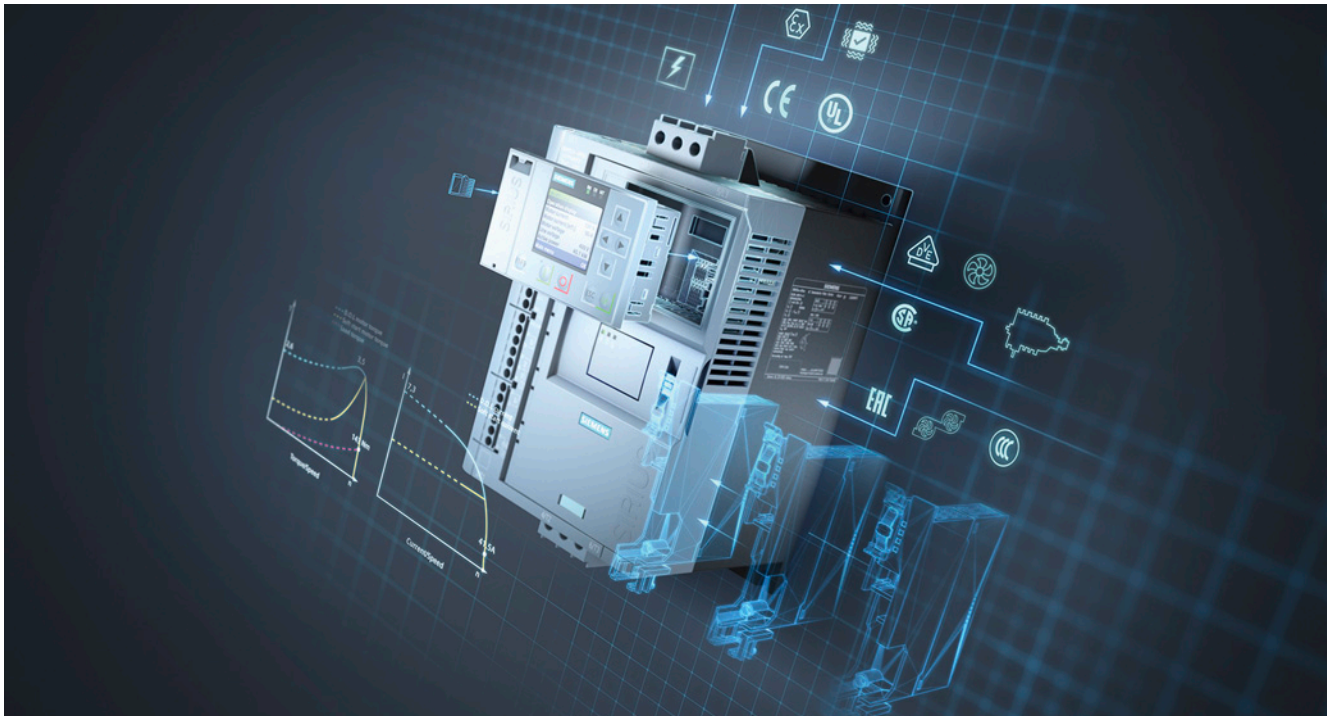

Product characteristics / function

Automatic parameterization

Hybrid switching devices and three-phase motor control

Integration into TIA Portal – communication modules optional

Detachable HMI with color display, local interface, slot for micro SD card

Pump stop and torque control

Performance features / benefits

Extremely easy commissioning and reliability even under changing load conditions

Minimum power loss and optimum/symmetrical motor control

Efficient configuration and maximum flexibility in automation engineering

Maximum flexibility with regard to user interface and intuitive menu guidance

Reduced mechanical loading and optimum pump stop control

Technical specifications

More information

For "SIRIUS 3RW55 Soft Starter" Manual, see <https://support.industry.siemens.com/cs/ww/en/view/109753752>
 FAQs, see <https://support.industry.siemens.com/cs/ww/en/ps/25099/faq>

Simulation Tool for Soft Starters (STS), see page 14/5 or <https://support.industry.siemens.com/cs/ww/en/view/101494917>

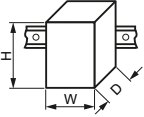
Type		3RW551.-.HA.4 3RW551.-.HA.5	3RW552.-.HA.6 3RW553.-.HA.6	3RW552.-.HA.4 3RW553.-.HA.4	3RW554.-.HA.4	3RW554.-.HA.6
Installation/fixing/dimensions:						
Width x height x depth		mm	170 × 275 × 152	185 × 306 × 203		210 × 393 × 203
Type of fixing			Screw fixing			
Mounting position			Vertical (can be rotated +/-90° and tilted +/- 22.5° forward or backward)			
Distance to be maintained with side-by-side mounting						
• Above	mm	100				
• At the side	mm	5				
• Below	mm	75				
Installation altitude at height above sea level, maximum¹⁾	m	5 000	2 000	5 000		2 000
Ambient conditions						
Ambient temperature						
• During operation ²⁾	°C	-25 ... +60				
• During storage	°C	-40 ... +80				
Environmental category according to IEC 60721						
• During operation		3K6 (no ice formation, no condensation), 3C3 (no salt mist), 3S2 (sand must not get into the devices), 3M6				
• During storage		1K6 (only occasional condensation), 1C2 (no salt mist), 1S2 (sand must not get inside the devices), 1M4				
• During transport		2K2, 2C1, 2S1, 2M2 (max. fall height 0.3 m)				

¹⁾ Derating from 1000 m, see Manual or characteristic curve on page 6/7.

²⁾ Note derating above 40 °C.

SIRIUS 3RW Soft Starters

High Performance Soft Starters

3RW55 Soft Starters

General data **NEW**

Type		3RW55...-HA0.	3RW55...-HA1.
Control circuit/control			
Control supply voltage			
• At AC/DC, rated value	V	24/24	--/--
• At AC	V	--/--	110 ... 250
• Relative negative tolerance/ relative positive tolerance with DC	%	-20/20	--/--
• Relative negative tolerance/ relative positive tolerance with AC	%	-20/20	-15/10
Frequency of the control supply voltage	Hz	50 ... 60	
• Relative negative tolerance/ relative positive tolerance	%	-10/10	
Type of overvoltage protection		Varistors	
Type of short-circuit protection for control circuit¹⁾		Fuse 4 A gG ($I_{cu} = 1$ kA), fuse 6 A quick-response ($I_{cu} = 1$ kA), MCB C1 ($I_{cu} = 600$ A), MCB C6 ($I_{cu} = 300$ A)	

¹⁾ Not included in scope of supply

Type		3RW55...-HA.4	3RW55...-HA.5	3RW55...-HA.6
Power electronics				
Operational voltage rated value	V	200 ... 480	200 ... 600	200 ... 690
• Relative negative tolerance/ relative positive tolerance	%	-15/10		
Operational voltage for inside-delta circuit rated value	V	200 ... 480	200 ... 600	--
• Relative negative tolerance/ relative positive tolerance	%	-15/10		--/--
Operating frequency, rated value	Hz	50 ... 60		
• Relative negative tolerance/ relative positive tolerance	%	-10/10		
Minimum load [% of I_M]¹⁾	%	10		
Maximum cable length between soft starter and motor	m	800		
Power loss [W] at 40 °C				
• At rated value current after startup	W	4		8

¹⁾ Relative to set I_e

SIRIUS 3RW Soft Starters

High Performance Soft Starters

3RW55 Soft Starters

NEW **IE3/IE4 ready** **Inline circuit**

Selection and ordering data

For normal starting (CLASS 10E)

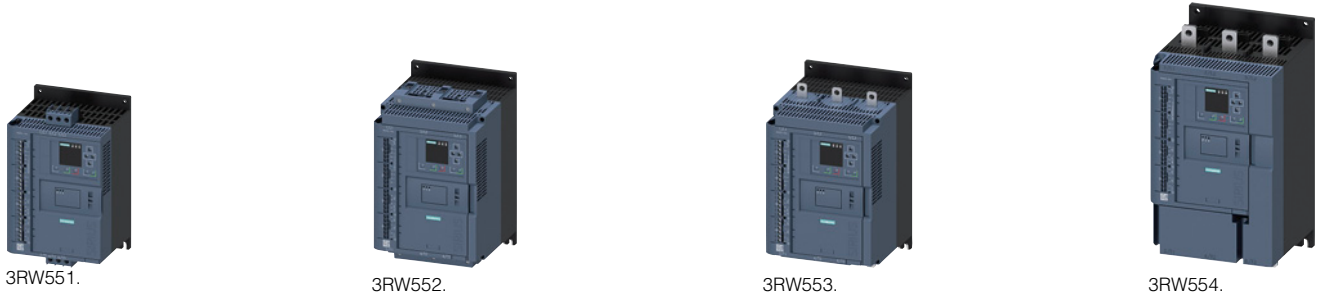

At 40 °C					At 50 °C					SD ¹⁾	Article No.	Price per PU	PU (UNIT, SET, M)	PS*	PG
Operational current	Operating power for three-phase motors				Operational current	Rating [hp] for three-phase motors									
	at 230 V	at 400 V	at 500 V	at 690 V		at 200/208 V	at 220/230 V	at 460/480 V	at 575/600 V	d					
A	kW	kW	kW	kW	A	hp	hp	hp	hp						
Operational voltage 200 ... 480 V															
13	3	5.5	--	--	11.5	3	3	7.5	--	5	3RW5513-□HA□4		1	1 unit	42S
18	4	7.5	--	--	15.9	3	3	10	--	5	3RW5514-□HA□4		1	1 unit	42S
25	5.5	11	--	--	22.3	5	5	15	--	5	3RW5515-□HA□4		1	1 unit	42S
32	7.5	15	--	--	28.4	7.5	7.5	15	--	5	3RW5516-□HA□4		1	1 unit	42S
38	11	18.5	--	--	33.5	10	10	20	--	5	3RW5517-□HA□4		1	1 unit	42S
47	11	22	--	--	41.6	10	15	30	--	5	3RW5524-□HA□4		1	1 unit	42S
63	18.5	30	--	--	55.5	15	20	40	--	5	3RW5525-□HA□4		1	1 unit	42S
77	22	37	--	--	68	20	20	50	--	5	3RW5526-□HA□4		1	1 unit	42S
93	22	45	--	--	82.5	25	25	60	--	5	3RW5527-□HA□4		1	1 unit	42S

Type of electrical connection for the control circuit

Screw terminals
Spring-type terminals

Control supply voltage

24 V AC/DC
110 ... 250 V AC

¹⁾ 3RW55 soft starter with screw terminals for operational voltage up to 480 V:
Standard delivery time SD = 1 day (d).

1
3

0
1

At 40 °C					At 50 °C					SD ¹⁾	Article No.	Price per PU	PU (UNIT, SET, M)	PS*	PG
Operational current	Operating power for three-phase motors				Operational current	Rating [hp] for three-phase motors									
	At 230 V	At 400 V	At 500 V	At 690 V		At 200/208 V	At 220/230 V	At 460/480 V	At 575/600 V	d					
A	kW	kW	kW	kW	A	hp	hp	hp	hp						
Operational voltage 200 ... 480 V															
113	30	55	--	--	101	30	30	75	--	5	3RW5534-□HA□4		1	1 unit	42S
143	37	75	--	--	128	30	40	75	--	5	3RW5535-□HA□4		1	1 unit	42S
171	45	90	--	--	153	40	50	100	--	5	3RW5536-□HA□4		1	1 unit	42S
210	55	110	--	--	186	50	60	125	--	5	3RW5543-□HA□4		1	1 unit	42S
250	75	132	--	--	220	60	75	150	--	5	3RW5544-□HA□4		1	1 unit	42S
315	90	160	--	--	279	75	100	200	--	5	3RW5545-□HA□4		1	1 unit	42S
370	110	200	--	--	328	100	125	250	--	5	3RW5546-□HA□4		1	1 unit	42S
470	132	250	--	--	416	125	150	300	--	5	3RW5547-□HA□4		1	1 unit	42S
570	160	315	--	--	504	150	200	400	--	5	3RW5548-□HA□4		1	1 unit	42S

Type of electrical connection for the control circuit

Spring-type terminals
Screw terminals

Control supply voltage

24 V AC/DC
110 ... 250 V AC

¹⁾ 3RW55 soft starter with screw terminals for operational voltage up to 480 V:
Standard delivery time SD = 1 day (d).

2
6

0
1

Note:

For the boundary conditions for the motor outputs specified here, see page 6/7.



SIRIUS 3RW Soft Starters

High Performance Soft Starters

3RW55 Soft Starters

Inline circuit **IE3/IE4 ready** **NEW**

For normal starting (CLASS 10E)



3RW551.



3RW552.



3RW553.



3RW554.

At 40 °C					At 50 °C					SD ¹⁾	Article No.	Price per PU	PU (UNIT, SET, M)	PS*	PG
Operational current	Operating power for three-phase motors				Operational current	Rating [hp] for three-phase motors									
	At 230 V	At 400 V	At 500 V	At 690 V		At 200/208 V	At 220/230 V	At 460/480 V	At 575/600 V						
A	kW	kW	kW	kW	A	hp	hp	hp	hp	d					
Operational voltage 200 ... 600 V															
13	3	5.5	7.5	--	11.5	3	3	7.5	10	5	3RW5513-□HA□5		1	1 unit	42S
18	4	7.5	11	--	15.9	3	3	10	15	5	3RW5514-□HA□5		1	1 unit	42S
25	5.5	11	15	--	22.3	5	5	15	20	5	3RW5515-□HA□5		1	1 unit	42S
32	7.5	15	18.5	--	28.4	7.5	7.5	15	25	5	3RW5516-□HA□5		1	1 unit	42S
38	11	18.5	22	--	33.5	10	10	20	30	5	3RW5517-□HA□5		1	1 unit	42S
Operational voltage 200 ... 690 V															
25	5.5	11	15	22	22.3	5	5	15	20	5	3RW5521-□HA□6		1	1 unit	42S
47	11	22	30	45	41.6	10	15	30	40	5	3RW5524-□HA□6		1	1 unit	42S
63	18.5	30	37	55	55.5	15	20	40	50	5	3RW5525-□HA□6		1	1 unit	42S
77	22	37	45	75	68	20	20	50	60	5	3RW5526-□HA□6		1	1 unit	42S
93	22	45	55	90	82.5	25	25	60	75	5	3RW5527-□HA□6		1	1 unit	42S

Type of electrical connection for the control circuit

Screw terminals
Spring-type terminals

Control supply voltage

24 V AC/DC
110 ... 250 V AC

¹⁾ 3RW55 soft starter with screw terminals for operational voltage up to 690 V:
Standard delivery time SD = 2 days (d).

1
3

0
1

At 40 °C					At 50 °C					SD ¹⁾	Article No.	Price per PU	PU (UNIT, SET, M)	PS*	PG
Operational current	Operating power for three-phase motors				Operational current	Rating [hp] for three-phase motors									
	At 230 V	At 400 V	At 500 V	At 690 V		At 200/208 V	At 220/230 V	At 460/480 V	At 575/600 V						
A	kW	kW	kW	kW	A	hp	hp	hp	hp	d					
Operational voltage 200 ... 690 V															
113	30	55	75	110	101	30	30	75	75	5	3RW5534-□HA□6		1	1 unit	42S
143	37	75	90	132	128	30	40	75	100	5	3RW5535-□HA□6		1	1 unit	42S
171	45	90	110	160	153	40	50	100	125	5	3RW5536-□HA□6		1	1 unit	42S
210	55	110	132	200	186	50	60	125	150	5	3RW5543-□HA□6		1	1 unit	42S
250	75	132	160	250	220	60	75	150	200	5	3RW5544-□HA□6		1	1 unit	42S
315	90	160	200	315	279	75	100	200	250	5	3RW5545-□HA□6		1	1 unit	42S
370	110	200	250	355	328	100	125	250	300	5	3RW5546-□HA□6		1	1 unit	42S
470	132	250	315	400	416	125	150	300	400	5	3RW5547-□HA□6		1	1 unit	42S
570	160	315	355	560	504	150	200	400	500	5	3RW5548-□HA□6		1	1 unit	42S

Type of electrical connection for the control circuit

Spring-type terminals
Screw terminals

Control supply voltage

24 V AC/DC
110 ... 250 V AC

¹⁾ 3RW55 soft starter with screw terminals for operational voltage up to 690 V:
Standard delivery time SD = 2 days (d).

2
6

0
1

Note:

For the boundary conditions for the motor outputs specified here, see page 6/7.

SIRIUS 3RW Soft Starters

High Performance Soft Starters

3RW55 Soft Starters

NEW IE3/IE4 ready Inside-delta circuit

Selection and ordering data

For normal starting (CLASS 10E)



3RW551.



3RW552.



3RW553.



3RW554.

At 40 °C for inside-delta circuit				At 50 °C for inside-delta circuit				SD ¹⁾	Article No.	Price per PU	PU (UNIT, SET, M)	PS*	PG	
Operational current	Operating power for three-phase motors			Operational current	Rating [hp] for three-phase motors									
	At 230 V	At 400 V	At 500 V		At 200/208 V	At 220/230 V	At 460/480 V	At 575/600 V	d					
A	kW	kW	kW	A	hp	hp	hp	hp						
Operational voltage for inside-delta circuit 200 ... 480 V														
22.5	5.5	11	--	19.9	5	5	15	--	5	3RW5513-□HA□4		1	1 unit	42S
31.2	7.5	15	--	28	5	5	15	--	5	3RW5514-□HA□4		1	1 unit	42S
43.3	11	18.5	--	39	7.5	7.5	20	--	5	3RW5515-□HA□4		1	1 unit	42S
55.4	15	22	--	49	10	10	30	--	5	3RW5516-□HA□4		1	1 unit	42S
65.8	18.5	30	--	58	15	15	40	--	5	3RW5517-□HA□4		1	1 unit	42S
81.4	22	45	--	72	20	25	50	--	5	3RW5524-□HA□4		1	1 unit	42S
109	30	55	--	96	25	30	60	--	5	3RW5525-□HA□4		1	1 unit	42S
133	37	75	--	118	30	40	75	--	5	3RW5526-□HA□4		1	1 unit	42S
161	45	90	--	143	40	50	100	--	5	3RW5527-□HA□4		1	1 unit	42S

Type of electrical connection for the control circuit

Screw terminals
Spring-type terminals

Control supply voltage

24 V AC/DC
110 ... 250 V AC

¹⁾ 3RW55 soft starter with screw terminals for operational voltage up to 480 V:
Standard delivery time SD = 1 day (d).

1
3
0
1

At 40 °C for inside-delta circuit				At 50 °C for inside-delta circuit				SD ¹⁾	Article No.	Price per PU	PU (UNIT, SET, M)	PS*	PG	
Operational current	Operating power for three-phase motors			Operational current	Rating [hp] for three-phase motors									
	At 230 V	At 400 V	At 500 V		At 200/208 V	At 220/230 V	At 460/480 V	At 575/600 V	d					
A	kW	kW	kW	A	hp	hp	hp	hp						
Operational voltage for inside-delta circuit 200 ... 480 V														
195	55	110	--	175	50	60	125	--	5	3RW5534-□HA□4		1	1 unit	42S
247	75	132	--	222	60	75	150	--	5	3RW5535-□HA□4		1	1 unit	42S
296	90	160	--	265	75	100	200	--	5	3RW5536-□HA□4		1	1 unit	42S
363	110	200	--	322	100	125	250	--	5	3RW5543-□HA□4		1	1 unit	42S
433	132	250	--	381	125	150	300	--	5	3RW5544-□HA□4		1	1 unit	42S
545	160	315	--	483	150	200	400	--	5	3RW5545-□HA□4		1	1 unit	42S
640	200	355	--	568	150	200	450	--	5	3RW5546-□HA□4		1	1 unit	42S
814	250	400	--	721	200	250	600	--	5	3RW5547-□HA□4		1	1 unit	42S
987	315	560	--	873	300	350	750	--	5	3RW5548-□HA□4		1	1 unit	42S

Type of electrical connection for the control circuit

Spring-type terminals
Screw terminals

Control supply voltage

24 V AC/DC
110 ... 250 V AC

¹⁾ 3RW55 soft starter with screw terminals for operational voltage up to 480 V:
Standard delivery time SD = 1 day (d).

2
6
0
1

Note:

For the boundary conditions for the motor outputs specified here, see page 6/7.

SIRIUS 3RW Soft Starters

High Performance Soft Starters

3RW55 Soft Starters

Inside-delta circuit **IE3/IE4 ready** **NEW**

For normal starting (CLASS 10E)



3RW551.



3RW552.



3RW553.



3RW554.

At 40 °C for inside-delta circuit				At 50 °C for inside-delta circuit				SD ¹⁾	Article No.	Price per PU	PU (UNIT, SET, M)	PS*	PG
Operational current	Operating power for three-phase motors			Operational current	Rating [hp] for three-phase motors								
	At 230 V	At 400 V	At 500 V		At 200/208 V	At 220/230 V	At 460/480 V	At 575/600 V	d				
A	kW	kW	kW	A	hp	hp	hp	hp					
Operational voltage for inside-delta circuit 200 ... 600 V													
22.5	5.5	11	15	19.9	5	5	15	20	5	3RW5513-□HA□5	1	1 unit	42S
31.2	7.5	15	18.5	28	5	5	15	25	5	3RW5514-□HA□5	1	1 unit	42S
43.3	11	18.5	22	39	7.5	7.5	20	30	5	3RW5515-□HA□5	1	1 unit	42S
55.4	15	22	30	49	10	10	30	40	5	3RW5516-□HA□5	1	1 unit	42S
65.8	18.5	30	37	58	15	15	40	50	5	3RW5517-□HA□5	1	1 unit	42S
43.3	11	18.5	22	39	7.5	7.5	20	30	5	3RW5521-□HA□6	1	1 unit	42S
81.4	22	45	45	72	20	25	50	60	5	3RW5524-□HA□6	1	1 unit	42S
109	30	55	55	96	25	30	60	75	5	3RW5525-□HA□6	1	1 unit	42S
133	37	75	90	118	30	40	75	100	5	3RW5526-□HA□6	1	1 unit	42S
161	45	90	110	143	40	50	100	125	5	3RW5527-□HA□6	1	1 unit	42S

Type of electrical connection for the control circuit

Screw terminals
Spring-type terminals

1
3

0
1

Control supply voltage

24 V AC/DC
110 ... 250 V AC

¹⁾ 3RW55 soft starter with screw terminals for operational voltage up to 600 V:
Standard delivery time SD = 2 days (d).

At 40 °C for inside-delta circuit				At 50 °C for inside-delta circuit				SD ¹⁾	Article No.	Price per PU	PU (UNIT, SET, M)	PS*	PG
Operational current	Operating power for three-phase motors			Operational current	Rating [hp] for three-phase motors								
	At 230 V	At 400 V	At 500 V		At 200/208 V	At 220/230 V	At 460/480 V	At 575/600 V	d				
A	kW	kW	kW	A	hp	hp	hp	hp					
Operational voltage for inside-delta circuit 200 ... 600 V													
195	55	110	132	175	50	60	125	150	5	3RW5534-□HA□6	1	1 unit	42S
247	75	132	160	222	60	75	150	200	5	3RW5535-□HA□6	1	1 unit	42S
296	90	160	200	265	75	100	200	250	5	3RW5536-□HA□6	1	1 unit	42S
363	110	200	250	322	100	125	250	300	5	3RW5543-□HA□6	1	1 unit	42S
433	132	250	315	381	125	150	300	350	5	3RW5544-□HA□6	1	1 unit	42S
545	160	315	355	483	150	200	400	500	5	3RW5545-□HA□6	1	1 unit	42S
640	200	355	450	568	150	200	450	600	5	3RW5546-□HA□6	1	1 unit	42S
814	250	400	500	721	200	250	600	750	5	3RW5547-□HA□6	1	1 unit	42S
987	315	560	630	873	300	350	750	950	5	3RW5548-□HA□6	1	1 unit	42S

Type of electrical connection for the control circuit

Spring-type terminals
Screw terminals

2
6

0
1

Control supply voltage



24 V AC/DC
110 ... 250 V AC

¹⁾ 3RW55 soft starter with screw terminals for operational voltage up to 600 V:
Standard delivery time SD = 2 days (d).

Note:

For the boundary conditions for the motor outputs specified here, see page 6/7.

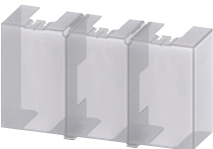
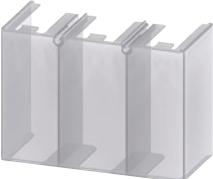
Selection and ordering data



Product designation	Manufacturer's Article No. of the soft starter	Type of product	Application	SD	Article No.	Price per PU	PU (UNIT, SET, M)	PS*	PG
Fan covers									
 3RW5983-0FC00	Fan cover	3RW551(1x), 3RW552, 3RW553 (2x)	--	--	1	3RW5983-0FC00	1	1 unit	42S
		3RW554	--	--	1	3RW5984-0FC00	1	1 unit	42S
Terminal covers									
 3RW5983-0TC20	Terminal cover	3RW552, 3RW553 (2x)	--	--	1	3RW5983-0TC20	1	1 unit	42S
		3RW554 (2x)	--	--	1	3RW5984-0TC20	1	1 unit	42S
 3RW5984-0TC20									
Enclosure components									
 3RW5950-0GL20	Hinged cover	3RW55	Without cutout	--	1	3RW5950-0GL20	1	1 unit	42S
Communication modules									
 3RW5980-0CS00	Communication module	3RW55	PROFINET Standard	--	1	3RW5980-0CS00	1	1 unit	42S
			PROFIBUS	--	1	3RW5980-0CP00	1	1 unit	42S
			Modbus TCP	--	1	3RW5980-0CT00	1	1 unit	42S

SIRIUS 3RW Soft Starters

High Performance Soft Starters

3RW55 Soft Starters

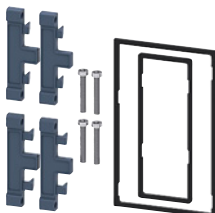
Accessories **NEW**

Product designation	Manufacturer's Article No. of the soft starter	Type of product	Application	SD	Article No.	Price per PU	PU (UNIT, SET, M)	PS*	PG	
HMI modules										
	Door mounting kit	3RW55	IP65	For HMI modules	1	3RW5980-0HD00		1	1 unit	42S
Connection cables										
	HMI connection cable	3RW55	5 m	For door mounting	1	3RW5980-0HC60		1	1 unit	42S
	Connection cables	--	Length 2.5 m, round	For connection of the system components	▶	3UF7933-0BA00-0		1	1 unit	42J
			Length 1.0 m, round	For connection of the system components	▶	3UF7937-0BA00-0		1	1 unit	42J
			Length 0.5 m, round	For connection of the system components	▶	3UF7932-0BA00-0		1	1 unit	42J
Further accessories										
	Push-in lugs for wall mounting		Two lugs are required per device	--	2	3ZY1311-0AA00		1	10 units	41L

6

Overview

More information

Homepage, see www.siemens.com/soft-starter
 Industry Mall, see www.siemens.com/product?3RW
 Online configurator, see www.siemens.com/sirius/configurators

Simulation Tool for Soft Starters (STS), see page 6/7 or <https://support.industry.siemens.com/cs/ww/en/view/101494917>
 SIRIUS Soft Starter ES (TIA Portal), see pages 14/6 and 14/9
 SIRIUS 3RW44 Soft Starter block library for SIMATIC PCS 7, see page 14/11



The SIRIUS 3RW44 High Performance soft starters are suitable for the torque-controlled soft starting and stopping as well as braking of three-phase asynchronous motors.

In addition to soft starting and stopping, the SIRIUS 3RW44 soft starters provide numerous functions for higher-level requirements. Soft starters are available in a performance range up to 710 kW (at 400 V) in the inline circuit and up to 1200 kW (at 400 V) in the inside-delta circuit.

Combinations of various starting, operating and ramp-down possibilities ensure an optimum adaptation to the application-specific requirements.

Benefits



3RW442.



3RW443.



3RW444.



3RW445.



3RW446.

Product characteristics / function	Performance features / benefits
Soft starting with breakaway pulse, torque control or adjustable current limiting	Optimum adaptation to the requirements of the application
Keypad with a menu-prompted, multi-line graphic display with background lighting	Simple and fast commissioning and maintenance
Various setting options for the starting parameters such as starting torque, starting voltage, starting and ramp-down time, and much more in three separate parameter sets	Efficient configuration and maximum flexibility in automation engineering
Integral bypass contact system	Reduction of power loss during operation
Communication interface to the PC	More accurate setting of the parameters as well as control and monitoring
Connection to PROFIBUS and PROFINET with optional PROFIBUS DP or PROFINET module	Simple integration into higher-level controls

SIRIUS 3RW Soft Starters

High Performance Soft Starters

3RW44 Soft Starters

General data

Technical specifications

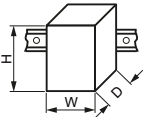
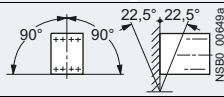
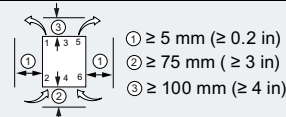
More information							
Manual "SIRIUS 3RW44 soft starters", see https://support.industry.siemens.com/cs/ww/en/view/21772518		Catalog LV 10, see www.siemens.com/lowvoltage/lv10					
FAQs, see https://support.industry.siemens.com/cs/ww/en/ps/16214/faq							
Type		3RW442.	3RW443.	3RW444.	3RW445.	3RW446.	
Mechanics and environment							
Mounting dimensions (W x H x D)							
<ul style="list-style-type: none"> • Screw terminals • Spring-type terminals 							
		mm	170 x 184 x 270	170 x 198 x 270	210 x 230 x 298	510 x 638.5 x 290	576 x 667 x 290
		mm	170 x 184 x 270	170 x 198 x 270	210 x 230 x 298	510 x 638.5 x 290	576 x 667 x 290
Permissible ambient temperature							
During operation		°C	0 ... +60; (derating from +40)				
During storage		°C	-25 ... +80				
Weight		kg	6.5	7.9	11.5	50	78
Permissible mounting position							
Installation type		Stand-alone installation 					
Permissible installation altitude		m	5 000 (derating from 1 000, see characteristic curve on page 6/7)				
Degree of protection		IP00					

Type	Terminal	3RW44...BC3.	3RW44...BC4.
Control electronics			
Rated values			
Rated control supply voltage	A1/A2/PE	V	115 AC
• Tolerance		%	-15/+10
Rated frequency		Hz	50 ... 60
• Tolerance		%	± 10
			230 AC

Type		3RW44...BC.4	3RW44...BC.5	3RW44...BC.6
Power electronics				
Rated operational voltage for inline circuit¹⁾	V AC	200 ... 460	400 ... 600	400 ... 690
Tolerance	%	-15/+10		
Maximum blocking voltage (thyristor)	V AC	1 400	1 800	
Rated operational voltage for inside-delta circuit	V AC	200 ... 460	400 ... 600	
Tolerance	%	-15/+10		
Rated frequency	Hz	50 ... 60		
Tolerance	%	± 10		
Uninterrupted duty at 40 °C (% of I_e)	%	115		
Minimum load (% of set motor current I_M)	%	8		
Maximum cable length between soft starter and motor	m	500 ²⁾		

¹⁾ 3RW44 soft starters may be used in isolated supply networks (IT systems) up to 600 V AC.

²⁾ At the project configuration stage, it is important to make allowance for the voltage drop on the motor cable up to the motor connection. If necessary, higher values for the rated operational voltage or current must be calculated accordingly for the soft starter.

SIRIUS 3RW Soft Starters

High Performance Soft Starters

3RW44 Soft Starters

General data

Type		3RW4422	3RW4423	3RW4424	3RW4425	3RW4426	3RW4427
Power electronics							
Rated operational current I_e	A	29	36	47	57	77	93
Load rating with rated operational current I_e							
• According to IEC and UL/CSA ¹⁾ , for individual mounting, AC-53a - At 40/50/60 °C	A	29/26/23	36/32/29	47/42/37	57/51/45	77/68/59	93/82/72
Smallest adjustable rated motor current I_M For the motor overload protection	A	5	7	9	11	15	18
Power loss							
• In operation after completed starting with uninterrupted rated operational current (40/50/60 °C) approx.	W	8/7.5/7	10/9/8.5	32/31/29	36/34/31	45/41/37	55/51/47
• During starting with current limit set to 350% I_M (40/50/60 °C)	W	400/345/290	470/410/355	600/515/440	725/630/525	940/790/660	1160/980/830
Permissible rated motor current and starts per hour at 40/50/60 °C							
• For normal starting (CLASS 10)							
- Rated motor current $I_M^{(2)}$, ramp-up time 10 s - Starts per hour ³⁾	A 1/h	29/26/23 20	36/32.5/29 15	47/42/37 20	57/51/45 20	77/68/59 20	93/82/72 20
- Rated motor current $I_M^{(2)}$, ramp-up time 20 s - Starts per hour ³⁾	A 1/h	29/26/23 10	36/32.5/29 6	47/42/37 10	57/51/45 10	77/68/59 8	93/82/72 8

¹⁾ Measurement at 60 °C according to UL/CSA not required.

²⁾ Current limit on soft starter set to 350% I_M , ON period = 70%.
Maximum adjustable rated motor current I_M dependent on CLASS setting.

³⁾ For intermittent duty S4 with ON period = 70%, $T_U = 40/50/60$ °C, stand-alone installation, vertical. The quoted switching frequencies do not apply for automatic mode.

Type		3RW4434	3RW4435	3RW4436
Power electronics				
Rated operational current I_e	A	113	134	162
Load rating with rated operational current I_e				
• According to IEC and UL/CSA ¹⁾ , for individual mounting, AC-53a - At 40/50/60 °C	A	113/100/88	134/117/100	162/145/125
Smallest adjustable rated motor current I_M For the motor overload protection	A	22	26	32
Power loss				
• In operation after completed starting with uninterrupted rated operational current (40/50/60 °C) approx.	W	64/58/53	76/67/58	95/83/71
• During starting with current limit set to 350% I_M (40/50/60 °C)	W	1 350/1 140/970	1 700/1 400/1 140	2 460/1 980/1 620
Permissible rated motor current and starts per hour at 40/50/60 °C				
• For normal starting (CLASS 10)				
- Rated motor current $I_M^{(2)}$, ramp-up time 10 s - Starts per hour ³⁾	A 1/h	113/100/88 20	134/117/100 15	162/145/125 20
- Rated motor current $I_M^{(2)}$, ramp-up time 20 s - Starts per hour ³⁾	A 1/h	113/100/88 9	134/117/100 6	162/145/125 7

¹⁾ Measurement at 60 °C according to UL/CSA not required.

²⁾ Current limit on soft starter set to 350% I_M , ON period = 70%.
Maximum adjustable rated motor current I_M dependent on CLASS setting.

³⁾ For intermittent duty S4 with ON period = 70%, $T_U = 40/50/60$ °C, stand-alone installation, vertical. The quoted switching frequencies do not apply for automatic mode.

Type		3RW4443	3RW4444	3RW4445	3RW4446	3RW4447
Power electronics						
Rated operational current I_e	A	203	250	313	356	432
Load rating with rated operational current I_e						
• According to IEC and UL/CSA ¹⁾ , for individual mounting, AC-53a - At 40/50/60 °C	A	203/180/156	250/215/185	313/280/250	356/315/280	432/385/335
Smallest adjustable rated motor current I_M For the motor overload protection	A	40	50	62	71	86
Power loss						
• In operation after completed starting with uninterrupted rated operational current (40/50/60 °C) approx.	W	89/81/73	110/94/83	145/126/110	174/147/126	232/194/159
• During starting with current limit set to 350% I_M (40/50/60 °C)	W	3350/2600/2150	4000/2900/2350	4470/4000/3400	5350/4050/3500	5860/5020/4200
Permissible rated motor current and starts per hour at 40/50/60 °C						
• For normal starting (CLASS 10)						
- Rated motor current $I_M^{(2)}$, ramp-up time 10 s - Starts per hour ³⁾	A 1/h	203/180/156 20	250/215/185 20	313/280/250 19	356/315/280 17	432/385/335 16
- Rated motor current $I_M^{(2)}$, ramp-up time 20 s - Starts per hour ³⁾	A 1/h	203/180/156 9	250/215/185 10	313/280/250 6	356/315/280 4	432/385/335 5

¹⁾ Measurement at 60 °C according to UL/CSA not required.

²⁾ Current limit on soft starter set to 350% I_M , ON period = 70%.
Maximum adjustable rated motor current I_M dependent on CLASS setting.

³⁾ For intermittent duty S4 with ON period = 70%, $T_U = 40/50/60$ °C, stand-alone installation, vertical. The quoted switching frequencies do not apply for automatic mode.

SIRIUS 3RW Soft Starters

High Performance Soft Starters

3RW44 Soft Starters

General data

Type		3RW4453	3RW4454	3RW4455	3RW4456	3RW4457	3RW4458
Power electronics							
Rated operational current I_e	A	551	615	693	780	880	970
Load rating with rated operational current I_e							
• According to IEC and UL/CSA ¹⁾ , for individual mounting, AC-53a - At 40/50/60 °C	A	551/494/438	615/551/489	693/615/551	780/693/615	880/780/693	970/850/760
Smallest adjustable rated motor current I_M	A	110	123	138	156	176	194
For the motor overload protection							
Power loss							
• In operation after completed starting with uninterrupted rated operational current (40/50/60 °C) approx.	W	159/135/113	186/156/130	220/181/152	214/176/146	250/204/168	270/215/179
• During starting with current limit set to 350% I_M							
- At 40 °C	W	7 020	8 100	9 500	11 100	13 100	15 000
- At 50 °C	W	6 111	7 020	8 100	9 500	11 000	12 500
- At 60 °C	W	5 263	5 996	7 020	8 100	8 100	10 700
Permissible rated motor current and starts per hour at 40/50/60 °C							
• For normal starting (CLASS 10)							
- Rated motor current $I_M^{(2)}$, ramp-up time 10 s	A	551/494/438	615/551/489	693/615/551	780/693/615	880/780/693	970/850/760
- Starts per hour ³⁾	1/h	20	20	16	13	8	5
- Rated motor current $I_M^{(2)}$, ramp-up time 20 s	A	551/494/438	615/551/489	693/615/551	780/693/615	880/780/693	970/850/760
- Starts per hour ³⁾	1/h	10	9	6	4	0.3	0.3

1) Measurement at 60 °C according to UL/CSA not required.
2) Current limit on soft starter set to 350% I_M , ON period = 70%.
Maximum adjustable rated motor current I_M dependent on CLASS setting.
3) For intermittent duty S4 with ON period = 70%, $T_U = 40/50/60$ °C, stand-alone installation, vertical. The quoted switching frequencies do not apply for automatic mode.

Type		3RW4465	3RW4466
Power electronics			
Rated operational current I_e	A	1076	1214
Load rating with rated operational current I_e			
• According to IEC and UL/CSA ¹⁾ , for individual mounting, AC-53a - At 40/50/60 °C	A	1076/970/880	1214/1076/970
Smallest adjustable rated motor current I_M	A	215	242
For the motor overload protection			
Power loss			
• In operation after completed starting with uninterrupted rated operational current (40/50/60 °C) approx.	W	510/420/360	630/510/420
• During starting with current limit set to 350% I_M			
- At 40 °C	W	15 000	17 500
- At 50 °C	W	13 000	15 000
- At 60 °C	W	11 500	13 000
Permissible rated motor current and starts per hour at 40/50/60 °C			
• For normal starting (CLASS 10)			
- Rated motor current $I_M^{(2)}$, ramp-up time 10 s	A	1076/970/880	1214/1076/970
- Starts per hour ³⁾	1/h	11	6
- Rated motor current $I_M^{(2)}$, ramp-up time 20 s	A	1076/970/880	1214/1076/970
- Starts per hour ³⁾	1/h	3	0.5

1) Measurement at 60 °C according to UL/CSA not required.
2) Current limit on soft starter set to 350% I_M , ON period = 70%.
Maximum adjustable rated motor current I_M dependent on CLASS setting.
3) For intermittent duty S4 with ON period = 70%, $T_U = 40/50/60$ °C, stand-alone installation, vertical. The quoted switching frequencies do not apply for automatic mode.

Motor feeders with soft starters

The type of coordination according to which the motor feeder with soft starter is mounted depends on the application-specific requirements. Normally, fuseless mounting (combination of motor starter protector and soft starter) is sufficient.

If type of coordination "2" is to be fulfilled, then semiconductor fuses must be fitted in the motor feeder.

ToC 1

Type of coordination "1" according to IEC 60947-4-1: After a short-circuit incident, the unit is defective and therefore unsuitable for further use (protection of persons and system guaranteed).

ToC 2

Type of coordination "2" according to IEC 60947-4-1: After a short-circuit incident the unit is suitable for further use (protection of persons and system guaranteed).

The type of coordination refers to soft starters in combination with the stipulated protective device (motor starter protector/fuse), not to any additional components in the feeder.

The types of coordination are indicated in the corresponding tables by the symbols shown on orange backgrounds.

Inline circuit fuseless version

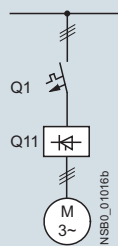

Soft starters

ToC 1

Q11 Type	Rated current A
----------	-----------------

Motor starter protectors¹⁾

Q1 Type	I_q kA	Rated current A
---------	----------	-----------------

Type of coordination "1"

Soft starter	Rated current A	Motor starter protector	I_q kA	Rated current A
3RW4422	29	3RV2021-4EA10	42	32
3RW4423	36	3RV2021-4FA10	42	40
3RW4424	47	3RV2031-4WA10	32	52
3RW4425	57	3RV2031-4JA10	32	65
3RW4426	77	3RV2031-4RA10	32	80
3RW4427	93	3RV2042-4MA10	32	100
3RW4434	113	3VA2216-5MN32	55	160
3RW4435	134	3VA2216-5MN32	55	160
3RW4436	162	3VA2220-7MN32	55	200
3RW4443	203	3VA2325-7MN32	110	250
3RW4444	250	3VA2325-7MN32	110	250
3RW4445	313	3VA2440-7MN32	110	400
3RW4446	356	3VA2450-7MN32	110	500
3RW4447	432	3VA2450-7MN32	110	500
3RW4453	551	3VL6780-3SB36	65	800
3RW4454	615	3VL6780-3SB36	65	800
3RW4455	693	3VL6780-3SB36	65	800
3RW4456	780	3VL7710-3SB36	65	1 000
3RW4457	880	3VL7710-3SB36	65	1 000
3RW4458	970	3VL7712-3SB36	65	1 250
3RW4465	1 076	3VL7712-3SB36	65	1 250
3RW4466	1 214	3VL7712-3SB36	65	1 250

¹⁾ The rated motor current must be considered when selecting the devices.

SIRIUS 3RW Soft Starters

High Performance Soft Starters

3RW44 Soft Starters

General data

Inline circuit fused version (line protection only)

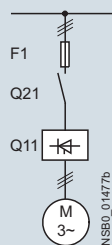

Soft starters		Line protection, maximum				Braking contactors ¹⁾²⁾	
Q11 Type	Rated current A	690 V + 5% F1 Type	Rated current A	Size	(optional) Q21 Type	(example circuit, see Manual 3RW44) Q91 Type Q92 Type	
Type of coordination "1"³⁾: $I_q = 65 \text{ kA}$							
3RW4422	29	3NA3820-6	50	00	3RT2027	3RT2526	--
3RW4423	36	3NA3822-6	63	00	3RT2028	3RT2526	--
3RW4424	47	3NA3824-6	80	00	3RT2036	3RT2535	--
3RW4425	57	3NA3830-6	100	00	3RT2037	3RT2535	--
3RW4426	77	3NA3132-6	125	1	3RT2038	3RT2024	3RT2035
3RW4427	93	3NA3136-6	160	1	3RT2046	3RT2025	3RT2036
3RW4434	113	3NA3244-6	250	2	3RT1054	3RT2027	3RT2037
3RW4435	134	3NA3244-6	250	2	3RT1055	3RT2036	3RT2038
3RW4436	162	3NA3365-6	500	3	3RT1056	3RT2037	3RT2038
3RW4443	203	2 x 3NA3354-6	2 x 355	3	3RT1064	3RT2037	3RT1054
3RW4444	250	2 x 3NA3354-6	2 x 355	3	3RT1065	3RT2037	3RT1055
3RW4445	313	2 x 3NA3365-6	2 x 500	3	3RT1075	3RT1054	3RT1056
3RW4446	356	2 x 3NA3365-6	2 x 500	3	3RT1075	3RT1054	3RT1056
3RW4447	432	2 x 3NA3365-6	2 x 500	3	3RT1076	3RT1055	3RT1064
3RW4453	551	2 x 3NA3365-6	2 x 500	3	3TF68	3RT1064	3RT1066
3RW4454	615	2 x 3NA3365-6	2 x 500	3	3TF68	3RT1064	3RT1075
3RW4455	693	2 x 3NA3365-6	2 x 500	3	3TF69	3RT1065	3RT1075
3RW4456	780	2 x 3NA3365-6	2 x 500	3	3TF69	3RT1065	3RT1075
3RW4457	880	2 x 3NA3365-6	2 x 500	3	--	3RT1075	3RT1076
3RW4458	970	3 x 3NA3365-6	3 x 500	3	--	3RT1075	3RT1076
3RW4465	1 076	3 x 3NA3365-6	3 x 500	3	--	3RT1075	3TF68
3RW4466	1 214	3 x 3NA3365-6	3 x 500	3	--	3RT1076	3TF68

¹⁾ If the ramp-down function "Combined braking" is selected, no braking contactor is required.
If the ramp-down function "DC braking" is selected, a braking contactor must be used in addition (type, see table).
For applications with large centrifugal masses ($J_{\text{Load}} > J_{\text{Motor}}$) the function "DC braking" is recommended.

²⁾ Additional auxiliary relay K4:
LZS:RT4A4T30
(3RW44 soft starter with rated control supply voltage 230 V AC),
LZS:RT4A4S15
(3RW44 soft starter with rated control supply voltage 115 V AC).

³⁾ The type of coordination "1" refers to soft starters in combination with the stipulated protective device (motor starter protector/fuse), not to any additional components in the feeder.

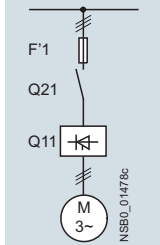
Inline circuit fused version with 3NE1 SITOR all-range fuse (semiconductor and line protection)

 For matching fuse bases, see [Catalog LV 10](#):

- "Fuse systems" →
"SITOR Semiconductor Fuses"
or www.siemens.com/sitor
- "Switch disconnectors"

Soft starters		All-range fuses				Line contactors up to 400 V (optional)	Braking contactors ¹⁾²⁾	
Q11 Type	Rated current A	F'1 Type	Rated current A	Voltage V	Size	Q21 Type	Q91 Type	Q92 Type
Type of coordination "2"³⁾: $I_q = 65 \text{ kA}$								
3RW4422	29	3NE 1020-2	80	690 + 5%	00	3RT2027	3RT2526	--
3RW4423	36	3NE 1020-2	80	690 + 5%	00	3RT2028	3RT2526	--
3RW4424	47	3NE 1021-2	100	690 + 5%	00	3RT2036	3RT2535	--
3RW4425	57	3NE 1022-2	125	690 + 5%	00	3RT2037	3RT2535	--
3RW4426	77	3NE 1022-2	125	690 + 5%	00	3RT2038	3RT2024	3RT2035
3RW4427	93	3NE 1224-2	160	690 + 5%	1	3RT2046	3RT2025	3RT2036
3RW4434	113	3NE 1225-2	200	690 + 5%	1	3RT1054	3RT2027	3RT2037
3RW4435	134	3NE 1227-2	250	690 + 5%	1	3RT1055	3RT2036	3RT2038
3RW4436	162	3NE 1227-2	250	690 + 5%	1	3RT1056	3RT2037	3RT2038
3RW4443	203	3NE 1230-2	315	600 + 10%	1	3RT1064	3RT2037	3RT1054
3RW4444	250	3NE 1331-2	350	460 + 10%	2	3RT1065	3RT2037	3RT1055
3RW4445	313	3NE 1333-2	450	690 + 5%	2	3RT1075	3RT1054	3RT1056
3RW4446	356	3NE 1334-2	500	690 + 5%	2	3RT1075	3RT1054	3RT1056
3RW4447	432	3NE 1435-2	560	690 + 5%	3	3RT1076	3RT1055	3RT1064
3RW4453	551	2 x 3NE 1334-2	500	690 + 10%	2	3TF68	3RT1064	3RT1066
3RW4454	615	2 x 3NE 1334-2	500	690 + 10%	2	3TF68	3RT1064	3RT1075
3RW4455	693	2 x 3NE 1334-2	500	690 + 10%	2	3TF69	3RT1065	3RT1075
3RW4456	780	2 x 3NE 1435-2	560	690 + 10%	3	3TF69	3RT1065	3RT1075
3RW4457	880	2 x 3NE 1435-2	560	690 + 10%	3	--	3RT1075	3RT1076
3RW4458	970	2 x 3NE 1435-2	560	690 + 10%	3	--	3RT1075	3RT1076
3RW4465	1 076	3 x 3NE 1334-2	500	690 + 10%	2	--	3RT1075	3TF68
3RW4466	1 214	3 x 3NE 1435-2	560	690 + 10%	3	--	3RT1076	3TF68

1) If the ramp-down function "Combined braking" is selected, no braking contactor is required.
If the ramp-down function "DC braking" is selected, a braking contactor must be used in addition (type, see table).
For applications with large centrifugal masses ($J_{Load} > J_{Motor}$) the function "DC braking" is recommended.

2) Additional auxiliary relay K4:
LZS:RT4A4T30
(3RW44 soft starter with rated control supply voltage 230 V AC),
LZS:RT4A4S15
(3RW44 soft starter with rated control supply voltage 115 V AC).

3) The type of coordination "2" refers to soft starters in combination with the stipulated protective device (motor starter protector/fuse), not to any additional components in the feeder.

SIRIUS 3RW Soft Starters

High Performance Soft Starters

3RW44 Soft Starters

General data

Inline circuit fused version with 3NE or 3NC SITOR semiconductor fuse

(semiconductor protection by fuse, line and overload protection by motor starter protector)

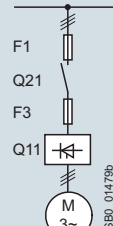
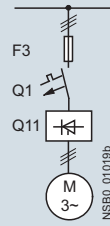

For matching fuse bases, see Catalog LV 10:

- "Fuse systems" → "SITOR Semiconductor Fuses" or www.siemens.com/sitor
- "Switch disconnectors"

Soft starters		Semiconductor fuses, minimum			Semiconductor fuses (cylinder)		
Q11 Type	Rated current A	690 V + 10% F3 Type	Rated current A	Size	F3 Type	Rated current A	Size
Type of coordination "2"¹⁾: I_q = 65 kA							
3RW4422	29	3NE4120	80	0	3NC2280	80	22 x 58
3RW4423	36	3NE4121	100	0	3NC2200	100	22 x 58
3RW4424	47	3NE4121	100	0	3NC2200	100	22 x 58
3RW4425	57	3NE4122	125	0	--	--	--
3RW4426	77	3NE4124	160	0	--	--	--
3RW4427	93	3NE3224	160	1	--	--	--
3RW4434	113	3NE3225	200	1	--	--	--
3RW4435	134	3NE3225	200	1	--	--	--
3RW4436	162	3NE3227	250	1	--	--	--
3RW4443	203	3NE3230-0B	315	1	--	--	--
3RW4444	250	3NE3230-0B	315	1	--	--	--
3RW4445	313	3NE3233	450	1	--	--	--
3RW4446	356	3NE3333	450	2	--	--	--
3RW4447	432	3NE3335	560	2	--	--	--
3RW4453	551	2 x 3NE3335	560	2	--	--	--
3RW4454	615	2 x 3NE3335	560	2	--	--	--
3RW4455	693	2 x 3NE3335	560	2	--	--	--
3RW4456	780	2 x 3NE3336	630	2	--	--	--
3RW4457	880	2 x 3NE3336	630	2	--	--	--
3RW4458	970	2 x 3NE3336	630	2	--	--	--
3RW4465	1 076	2 x 3NE3340-8	900	2	--	--	--
3RW4466	1 214	2 x 3NE3340-8	900	2	--	--	--

Soft starters		Line contactors up to 400 V		Braking contactors ²⁾³⁾		Motor starter protectors		Line protection, maximum		
Q11 Type	Rated current A	Q21 Type	(optional)	Q91 Type	Q92 Type	Q1 Type	Rated current A	F1 Type	Rated current A	Size
Type of coordination "2"¹⁾: I_q = 65 kA										
3RW4422	29	3RT2027		3RT2526	--	3RV2021-4EA10	32	3NA3820-6	50	00
3RW4423	36	3RT2028		3RT2526	--	3RV2021-4FA10	40	3NA3822-6	63	00
3RW4424	47	3RT2036		3RT2535	--	3RV2031-4WA10	52	3NA3824-6	80	00
3RW4425	57	3RT2037		3RT2535	--	3RV2031-4JA10	65	3NA3830-6	100	00
3RW4426	77	3RT2038		3RT2024	3RT2035	3RV2031-4RA10	80	3NA3132-6	125	1
3RW4427	93	3RT2046		3RT2025	3RT2036	3RV2042-4MA10	100	3NA3136-6	160	1
3RW4434	113	3RT1054		3RT2027	3RT2037	3VA2216-5MN32	160	3NA3244-6	250	2
3RW4435	134	3RT1055		3RT2036	3RT2038	3VA2216-5MN32	160	3NA3244-6	250	2
3RW4436	162	3RT1056		3RT2037	3RT2038	3VA2220-7MN32	200	3NA3365-6	500	3
3RW4443	203	3RT1064		3RT2037	3RT1054	3VA2325-7MN32	250	2 x 3NA3354-6	2 x 355	3
3RW4444	250	3RT1065		3RT2037	3RT1055	3VA2325-7MN32	250	2 x 3NA3354-6	2 x 355	3
3RW4445	313	3RT1075		3RT1054	3RT1056	3VA2440-7MN32	400	2 x 3NA3365-6	2 x 500	3
3RW4446	356	3RT1075		3RT1054	3RT1056	3VA2450-7MN32	500	2 x 3NA3365-6	2 x 500	3
3RW4447	432	3RT1076		3RT1055	3RT1064	3VA2450-7MN32	500	2 x 3NA3365-6	2 x 500	3
3RW4453	551	3TF68		3RT1064	3RT1066	3VL6780	800	2 x 3NA3365-6	2 x 500	3
3RW4454	615	3TF68		3RT1064	3RT1075	3VL6780	800	2 x 3NA3365-6	2 x 500	3
3RW4455	693	3TF69		3RT1065	3RT1075	3VL6780	800	2 x 3NA3365-6	2 x 500	3
3RW4456	780	3TF69		3RT1065	3RT1075	3VL7710	1 000	2 x 3NA3365-6	2 x 500	3
3RW4457	880	--		3RT1075	3RT1076	3VL7710	1 000	2 x 3NA3365-6	2 x 500	3
3RW4458	970	--		3RT1075	3RT1076	3VL7712	1 250	3 x 3NA3365-6	3 x 500	3
3RW4465	1 076	--		3RT1075	3TF68	3VL7712	1 250	3 x 3NA3365-6	3 x 500	3
3RW4466	1 214	--		3RT1076	3TF68	3VL7712	1 250	3 x 3NA3365-6	3 x 500	3

¹⁾ The type of coordination "2" refers to soft starters in combination with the stipulated protective device (motor starter protector/fuse), not to any additional components in the feeder.

²⁾ If the ramp-down function "Combined braking" is selected, no braking contactor is required. If the ramp-down function "DC braking" is selected, a braking contactor must be used in addition (type, see table).

For applications with large centrifugal masses ($J_{Load} > J_{Motor}$) the function "DC braking" is recommended.

³⁾ Additional auxiliary relay K4:
LZS:RT4A4T30 (3RW44 soft starter with rated control supply voltage 230 V AC),
LZS:RT4A4S15 (3RW44 soft starter with rated control supply voltage 115 V AC).

Inside-delta circuit fused version with 3NE or 3NC SITOR fuses
(semiconductor protection by fuse, line and overload protection by motor starter protector)

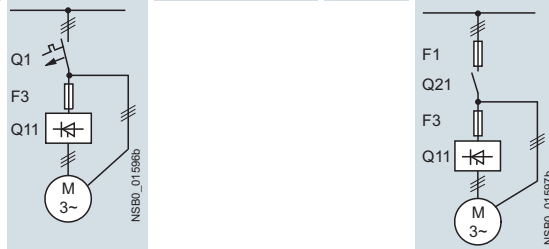

For matching fuse bases, see Catalog LV 10:

- "Fuse systems" → "SITOR Semiconductor Fuses" or www.siemens.com/sitor
- "Switch disconnectors"

Soft starters		Semiconductor fuses, minimum			Semiconductor fuses (cylinder)		
Q11 Type	Rated current A	F3 Type	Rated current A	Size	F3 Type	Rated current A	Size
Type of coordination "2"¹⁾							
3RW4422	50	3NE4120	80	0	3NC2280	80	22 x 58
3RW4423	62	3NE4121	100	0	3NC2200	100	22 x 58
3RW4424	81	3NE4121	100	0	3NC2200	100	22 x 58
3RW4425	99	3NE4122	125	0	--	--	--
3RW4426	133	3NE4124	160	0	--	--	--
3RW4427	161	3NE3224	160	1	--	--	--
3RW4434	196	3NE3225	200	1	--	--	--
3RW4435	232	3NE3225	200	1	--	--	--
3RW4436	281	3NE3227	250	1	--	--	--
3RW4443	352	3NE3230-0B	315	1	--	--	--
3RW4444	433	3NE3230-0B	315	1	--	--	--
3RW4445	542	3NE3233	450	1	--	--	--
3RW4446	617	3NE3333	450	2	--	--	--
3RW4447	748	3NE3335	560	2	--	--	--
3RW4453	954	2 x 3NE3335	560	2	--	--	--
3RW4454	1 065	2 x 3NE3335	560	2	--	--	--
3RW4455	1 200	2 x 3NE3335	560	2	--	--	--
3RW4456	1 351	2 x 3NE3336	630	2	--	--	--
3RW4457	1 524	2 x 3NE3336	630	2	--	--	--
3RW4458	1 680	2 x 3NE3336	630	2	--	--	--
3RW4465	1 864	2 x 3NE3340-8	900	2	--	--	--
3RW4466	2 103	2 x 3NE3340-8	900	2	--	--	--

Soft starters		Line contactors up to 400 V		Motor starter protectors		Line protection, maximum		
Q11 Type	Rated current A	(optional) Q21 Type	400 V +10% Type	Rated current A	F1 Type	Rated current A	Size	
Type of coordination "2"¹⁾								
3RW4422	50	3RT2036-1AP04	3RV2032-4VA10	45	3NA3824-6	80	00	
3RW4423	62	3RT2037-1AP04	3RV2032-4JA10	65	3NA3830-6	100	00	
3RW4424	81	3RT2038-1AP04	3RV2042-4YA10	93	3NA3132-6	125	1	
3RW4425	99	3RT1054-1AP36	3RV2042-4MA10	100	3NA3136-6	160	1	
3RW4426	133	3RT1055-6AP36	3VA2216-.MS32-0AA0	160	3NA3240-6	200	2	
3RW4427	161	3RT1056-6AP36	3VA2220-.MS32-0AA0	200	3NA3244-6	250	2	
3RW4434	196	3RT1064-6AP36	3VA2325-.MS32-0AA0	250	3NA3360-6	400	3	
3RW4435	232	3RT1065-6AP36	3VA2325-.MS32-0AA0	250	3NA3360-6	400	3	
3RW4436	281	3RT1066-6AP36	3VA2440-.MS32-0AA0	400	2 x 3NA3360-6	2 x 400	3	
3RW4443	352	3RT1075-6AP36	3VA2440-.MS32-0AA0	400	2 x 3NA3365-6	2 x 500	3	
3RW4444	433	3RT1076-6AP36	3VA2450-.MS32-0AA0	500	2 x 3NA3365-6	2 x 500	3	
3RW4445	542	3TF6844-0CM7	3VL5763	630	3 x 3NA3365-6	3 x 500	3	
3RW4446	617	3TF6844-0CM7	3VL6780	800	3 x 3NA3365-6	3 x 500	3	
3RW4447	748	3TF69	3VL6780	800	3 x 3NA3365-6	3 x 500	3	
3RW4453	954	--	3VL7710	1 000	3 x 3NA3365-6	3 x 500	3	
3RW4454	1 065	--	3VL7712	1 250	3 x 3NA3365-6	3 x 500	3	
3RW4455	1 200	--	3VL8716	1 600	3 x 3NA3365-6	3 x 500	3	
3RW4456	1 351	--	3VL8716	1 600	3 x 3NA3372	3 x 630	3	
3RW4457	1 524	--	3VL8716	1 600	3 x 3NA3372	3 x 630	3	
3RW4458	1 680	--	3WL1220	2 000	2 x 3NA3480	2 x 1 000	4	
3RW4465	1 864	--	3WL1225	2 500	2 x 3NA3482	2 x 1 250	4	
3RW4466	2 103	--	3WL1225	2 500	2 x 3NA3482	2 x 1 250	4	

¹⁾ The type of coordination "2" refers to soft starters in combination with the stipulated protective device (motor starter protector/fuse), not to any additional components in the feeder. If the F3 semiconductor fuse is not used, the type of coordination "2" is reduced to type of coordination "1" for soft starters in combination with the stipulated protective device.



SIRIUS 3RW Soft Starters

High Performance Soft Starters

3RW44 Soft Starters

Inline circuit **IE3/IE4 ready**

Selection and ordering data

For normal starting (CLASS 10)



3RW ambient temperature 40 °C				3RW ambient temperature 50 °C				SD ¹⁾	Article No.	Price per PU	PU (UNIT, SET, M)	PS*	PG
Rated values of three-phase motors													
Operational current I_e	Rating at operational voltage U_e			Operational current I_e	Rating at operational voltage U_e			d					
	230 V	400 V	500 V		200 V	230 V	460 V						575 V
A	kW	kW	kW	A	hp	hp	hp						
Inline circuit, rated operational voltage 200 ... 460 V													
29	5.5	15	--	26	7.5	7.5	15	--	5	3RW4422-□BC□4	1	1 unit	42H
36	7.5	18.5	--	32	10	10	20	--	5	3RW4423-□BC□4	1	1 unit	42H
47	11	22	--	42	10	15	25	--	5	3RW4424-□BC□4	1	1 unit	42H
57	15	30	--	51	15	15	30	--	5	3RW4425-□BC□4	1	1 unit	42H
77	18.5	37	--	68	20	20	50	--	5	3RW4426-□BC□4	1	1 unit	42H
93	22	45	--	82	25	25	60	--	5	3RW4427-□BC□4	1	1 unit	42H

Article No. supplement for connection types

- With screw terminals
- With spring-type terminals

113	30	55	--	100	30	30	75	--	5	3RW4434-□BC□4	1	1 unit	42H
134	37	75	--	117	30	40	75	--	5	3RW4435-□BC□4	1	1 unit	42H
162	45	90	--	145	40	50	100	--	5	3RW4436-□BC□4	1	1 unit	42H
203	55	110	--	180	50	60	125	--	5	3RW4443-□BC□4	1	1 unit	42H
250	75	132	--	215	60	75	150	--	5	3RW4444-□BC□4	1	1 unit	42H
313	90	160	--	280	75	100	200	--	5	3RW4445-□BC□4	1	1 unit	42H
356	110	200	--	315	100	125	250	--	5	3RW4446-□BC□4	1	1 unit	42H
432	132	250	--	385	125	150	300	--	5	3RW4447-□BC□4	1	1 unit	42H
551	160	315	--	494	150	200	400	--	15	3RW4453-□BC□4	1	1 unit	42H
615	200	355	--	551	150	200	450	--	15	3RW4454-□BC□4	1	1 unit	42H
693	200	400	--	615	200	250	500	--	15	3RW4455-□BC□4	1	1 unit	42H
780	250	450	--	693	200	250	600	--	15	3RW4456-□BC□4	1	1 unit	42H
880	250	500	--	780	250	300	700	--	15	3RW4457-□BC□4	1	1 unit	42H
970	315	560	--	850	300	350	750	--	15	3RW4458-□BC□4	1	1 unit	42H
1 076	355	630	--	970	350	400	850	--	15	3RW4465-□BC□4	1	1 unit	42H
1 214	400	710	--	1 076	350	450	950	--	15	3RW4466-□BC□4	1	1 unit	42H

Article No. supplement for connection types

- With spring-type terminals
- With screw terminals

Article No. supplement for rated control supply voltage U_s ²⁾

- 115 V AC
- 230 V AC

¹⁾ 3RW442. to 3RW444. soft starters with screw terminals:
Standard delivery time SD = 1 day (d).

²⁾ Control by way of the internal 24 V DC supply and direct control via PLC possible.

Note:

For the boundary conditions for the motor outputs specified here, see page 6/7.

SIRIUS 3RW Soft Starters

High Performance Soft Starters

3RW44 Soft Starters

IE3/IE4 ready **Inline circuit**
For normal starting (CLASS 10)

3RW442.



3RW443.



3RW444.



3RW445.



3RW446.

3RW ambient temperature 40 °C				3RW ambient temperature 50 °C				SD ¹⁾	Article No.	Price per PU	PU (UNIT, SET, M)	PS*	PG	
Rated values of three-phase motors														
Operational current I_e	Rating at operational voltage U_e				Operational current I_e	Rating at operational voltage U_e								
	230 V	400 V	500 V	690 V		200 V	230 V	460 V	575 V					
A	kW	kW	kW	kW	A	hp	hp	hp	hp	d				
Inline circuit, rated operational voltage 400 ... 600 V														
29	--	15	18.5	--	26	--	--	15	20	5	3RW4422-□BC□5	1	1 unit	42H
36	--	18.5	22	--	32	--	--	20	25	5	3RW4423-□BC□5	1	1 unit	42H
47	--	22	30	--	42	--	--	25	30	5	3RW4424-□BC□5	1	1 unit	42H
57	--	30	37	--	51	--	--	30	40	5	3RW4425-□BC□5	1	1 unit	42H
77	--	37	45	--	68	--	--	50	50	5	3RW4426-□BC□5	1	1 unit	42H
93	--	45	55	--	82	--	--	60	75	5	3RW4427-□BC□5	1	1 unit	42H

Article No. supplement for connection types

- With screw terminals
- With spring-type terminals

113	--	55	75	--	100	--	--	75	75	5	3RW4434-□BC□5	1	1 unit	42H
134	--	75	90	--	117	--	--	75	100	5	3RW4435-□BC□5	1	1 unit	42H
162	--	90	110	--	145	--	--	100	125	5	3RW4436-□BC□5	1	1 unit	42H
203	--	110	132	--	180	--	--	125	150	5	3RW4443-□BC□5	1	1 unit	42H
250	--	132	160	--	215	--	--	150	200	5	3RW4444-□BC□5	1	1 unit	42H
313	--	160	200	--	280	--	--	200	250	5	3RW4445-□BC□5	1	1 unit	42H
356	--	200	250	--	315	--	--	250	300	5	3RW4446-□BC□5	1	1 unit	42H
432	--	250	315	--	385	--	--	300	400	5	3RW4447-□BC□5	1	1 unit	42H
551	--	315	355	--	494	--	--	400	500	15	3RW4453-□BC□5	1	1 unit	42H
615	--	355	400	--	551	--	--	450	600	15	3RW4454-□BC□5	1	1 unit	42H
693	--	400	500	--	615	--	--	500	700	15	3RW4455-□BC□5	1	1 unit	42H
780	--	450	560	--	693	--	--	600	750	15	3RW4456-□BC□5	1	1 unit	42H
880	--	500	630	--	780	--	--	700	850	15	3RW4457-□BC□5	1	1 unit	42H
970	--	560	710	--	850	--	--	750	900	15	3RW4458-□BC□5	1	1 unit	42H
1 076	--	630	800	--	970	--	--	850	1 100	15	3RW4465-□BC□5	1	1 unit	42H
1 214	--	710	900	--	1 076	--	--	950	1 200	15	3RW4466-□BC□5	1	1 unit	42H

Article No. supplement for connection types

- With spring-type terminals
- With screw terminals

Article No. supplement for rated control supply voltage U_s ²⁾

- 115 V AC
- 230 V AC

¹⁾ Soft starter with screw terminals:
3RW442. to 3RW444. Standard delivery time SD = 2 days (d),
3RW445. to 3RW446. Standard delivery time SD = 5 days (d).

²⁾ Control by way of the internal 24 V DC supply and direct control via PLC possible.

Note:

For the boundary conditions for the motor outputs specified here, see page 6/7.

SIRIUS 3RW Soft Starters

High Performance Soft Starters

3RW44 Soft Starters

Inline circuit **IE3/IE4 ready**

For normal starting (CLASS 10)



3RW442.



3RW443.



3RW444.



3RW445.



3RW446.

3RW ambient temperature 40 °C				3RW ambient temperature 50 °C				SD	Article No.	Price per PU	PU (UNIT, SET, M)	PS*	PG	
Rated values of three-phase motors				Rated values of three-phase motors										
Operational current I_e	Rating at operational voltage U_e			Operational current I_e	Rating at operational voltage U_e			d						
	230 V	400 V	500 V		690 V	200 V	230 V							460 V
A	kW	kW	kW	kW	A	hp	hp	hp	hp					
Inline circuit, rated operational voltage 400 ... 690 V														
29	--	15	18.5	30	26	--	--	15	20	5	3RW4422-□BC□6	1	1 unit	42H
36	--	18.5	22	37	32	--	--	20	25	5	3RW4423-□BC□6	1	1 unit	42H
47	--	22	30	45	42	--	--	25	30	5	3RW4424-□BC□6	1	1 unit	42H
57	--	30	37	55	51	--	--	30	40	5	3RW4425-□BC□6	1	1 unit	42H
77	--	37	45	75	68	--	--	50	50	5	3RW4426-□BC□6	1	1 unit	42H
93	--	45	55	90	82	--	--	60	75	5	3RW4427-□BC□6	1	1 unit	42H

Article No. supplement for connection types

- With screw terminals
- With spring-type terminals

113	--	55	75	110	100	--	--	75	75	5	3RW4434-□BC□6	1	1 unit	42H
134	--	75	90	132	117	--	--	75	100	5	3RW4435-□BC□6	1	1 unit	42H
162	--	90	110	160	145	--	--	100	125	5	3RW4436-□BC□6	1	1 unit	42H
203	--	110	132	200	180	--	--	125	150	5	3RW4443-□BC□6	1	1 unit	42H
250	--	132	160	250	215	--	--	150	200	5	3RW4444-□BC□6	1	1 unit	42H
313	--	160	200	315	280	--	--	200	250	5	3RW4445-□BC□6	1	1 unit	42H
356	--	200	250	355	315	--	--	250	300	5	3RW4446-□BC□6	1	1 unit	42H
432	--	250	315	400	385	--	--	300	400	5	3RW4447-□BC□6	1	1 unit	42H
551	--	315	355	560	494	--	--	400	500	15	3RW4453-□BC□6	1	1 unit	42H
615	--	355	400	630	551	--	--	450	600	15	3RW4454-□BC□6	1	1 unit	42H
693	--	400	500	710	615	--	--	500	700	15	3RW4455-□BC□6	1	1 unit	42H
780	--	450	560	800	693	--	--	600	750	15	3RW4456-□BC□6	1	1 unit	42H
880	--	500	630	900	780	--	--	700	850	15	3RW4457-□BC□6	1	1 unit	42H
970	--	560	710	1 000	850	--	--	750	900	15	3RW4458-□BC□6	1	1 unit	42H
1 076	--	630	800	1 100	970	--	--	850	1 100	15	3RW4465-□BC□6	1	1 unit	42H
1 214	--	710	900	1 200	1 076	--	--	950	1 200	15	3RW4466-□BC□6	1	1 unit	42H

Article No. supplement for connection types

- With spring-type terminals
- With screw terminals

Article No. supplement for rated control supply voltage U_s ¹⁾

- 115 V AC
- 230 V AC

¹⁾ Control by way of the internal 24 V DC supply and direct control via PLC possible.

Note:

For the boundary conditions for the motor outputs specified here, see page 6/7.

SIRIUS 3RW Soft Starters

High Performance Soft Starters

3RW44 Soft Starters

IE3/IE4 ready Inside-delta circuit

Selection and ordering data

For normal starting (CLASS 10)



3RW ambient temperature 40 °C					3RW ambient temperature 50 °C					SD ¹⁾	Article No.	Price per PU	PU (UNIT, SET, M)	PS*	PG
Rated values of three-phase motors										d					
Operational current I _e					Operational current I _e										
Rating at operational voltage U _e					Rating at operational voltage U _e										
A	230 V	400 V	500 V	690 V	A	200 V	230 V	460 V	575 V						
	kW	kW	kW	kW		hp	hp	hp	hp						
Inside-delta circuit, rated operational voltage 200 ... 460 V															
50	15	22	--	--	45	10	15	30	--	5	3RW4422-□BC□4		1	1 unit	42H
62	18.5	30	--	--	55	15	20	40	--	5	3RW4423-□BC□4		1	1 unit	42H
81	22	45	--	--	73	20	25	50	--	5	3RW4424-□BC□4		1	1 unit	42H
99	30	55	--	--	88	25	30	60	--	5	3RW4425-□BC□4		1	1 unit	42H
133	37	75	--	--	118	30	40	75	--	5	3RW4426-□BC□4		1	1 unit	42H
161	45	90	--	--	142	40	50	100	--	5	3RW4427-□BC□4		1	1 unit	42H

Article No. supplement for connection types

- With screw terminals
- With spring-type terminals

1
3

196	55	110	--	--	173	50	60	125	--	5	3RW4434-□BC□4		1	1 unit	42H
232	75	132	--	--	203	60	75	150	--	5	3RW4435-□BC□4		1	1 unit	42H
281	90	160	--	--	251	75	100	200	--	5	3RW4436-□BC□4		1	1 unit	42H
352	110	200	--	--	312	100	125	250	--	5	3RW4443-□BC□4		1	1 unit	42H
433	132	250	--	--	372	125	150	300	--	5	3RW4444-□BC□4		1	1 unit	42H
542	160	315	--	--	485	150	200	400	--	5	3RW4445-□BC□4		1	1 unit	42H
617	200	355	--	--	546	150	200	450	--	5	3RW4446-□BC□4		1	1 unit	42H
748	250	400	--	--	667	200	250	600	--	5	3RW4447-□BC□4		1	1 unit	42H
954	315	560	--	--	856	300	350	750	--	15	3RW4453-□BC□4		1	1 unit	42H
1 065	355	630	--	--	954	350	400	850	--	15	3RW4454-□BC□4		1	1 unit	42H
1 200	400	710	--	--	1 065	350	450	950	--	15	3RW4455-□BC□4		1	1 unit	42H
1 351	450	800	--	--	1 200	450	500	1 050	--	15	3RW4456-□BC□4		1	1 unit	42H
1 524	500	900	--	--	1 351	450	600	1 200	--	15	3RW4457-□BC□4		1	1 unit	42H
1 680	560	1 000	--	--	1 472	550	650	1 300	--	15	3RW4458-□BC□4		1	1 unit	42H
1 864	630	1 100	--	--	1 680	650	750	1 500	--	15	3RW4465-□BC□4		1	1 unit	42H
2 103	710	1 200	--	--	1 864	700	850	1 700	--	15	3RW4466-□BC□4		1	1 unit	42H

2
6

Article No. supplement for connection types

- With spring-type terminals
- With screw terminals

Article No. supplement for rated control supply voltage U_s²⁾

- 115 V AC
- 230 V AC

3
4

¹⁾ 3RW442. to 3RW444. soft starters with screw terminals:
Standard delivery time SD = 1 day (d).

²⁾ Control by way of the internal 24 V DC supply and direct control via PLC possible.

Note:

For the boundary conditions for the motor outputs specified here, see page 6/7.

SIRIUS 3RW Soft Starters

High Performance Soft Starters

3RW44 Soft Starters

Inside-delta circuit **IE3/IE4 ready**

For normal starting (CLASS 10)



3RW442.



3RW443.



3RW444.



3RW445.



3RW446.

3RW ambient temperature 40 °C				3RW ambient temperature 50 °C				SD ¹⁾	Article No.	Price per PU	PU (UNIT, SET, M)	PS*	PG		
Rated values of three-phase motors								d							
Operational current I_e				Operational current I_e											
Rating at operational voltage U_e				Rating at operational voltage U_e											
	230 V	400 V	500 V	690 V		200 V	230 V	460 V	575 V						
A	kW	kW	kW	kW	A	hp	hp	hp	hp						
Inside-delta circuit, rated operational voltage 400 ... 600 V															
50	--	22	30	--	45	--	--	30	40	5	3RW4422-□BC□5	1	1 unit	42H	
62	--	30	37	--	55	--	--	40	50	5	3RW4423-□BC□5	1	1 unit	42H	
81	--	45	45	--	73	--	--	50	60	5	3RW4424-□BC□5	1	1 unit	42H	
99	--	55	55	--	88	--	--	60	75	5	3RW4425-□BC□5	1	1 unit	42H	
133	--	75	90	--	118	--	--	75	100	5	3RW4426-□BC□5	1	1 unit	42H	
161	--	90	110	--	142	--	--	100	125	5	3RW4427-□BC□5	1	1 unit	42H	

Article No. supplement for connection types

- With screw terminals
- With spring-type terminals

196	--	110	132	--	173	--	--	125	150	5	3RW4434-□BC□5	1	1 unit	42H
232	--	132	160	--	203	--	--	150	200	5	3RW4435-□BC□5	1	1 unit	42H
281	--	160	200	--	251	--	--	200	250	5	3RW4436-□BC□5	1	1 unit	42H
352	--	200	250	--	312	--	--	250	300	5	3RW4443-□BC□5	1	1 unit	42H
433	--	250	315	--	372	--	--	300	350	5	3RW4444-□BC□5	1	1 unit	42H
542	--	315	355	--	485	--	--	400	500	5	3RW4445-□BC□5	1	1 unit	42H
617	--	355	450	--	546	--	--	450	600	5	3RW4446-□BC□5	1	1 unit	42H
748	--	400	500	--	667	--	--	600	750	5	3RW4447-□BC□5	1	1 unit	42H
954	--	560	630	--	856	--	--	750	950	15	3RW4453-□BC□5	1	1 unit	42H
1 065	--	630	710	--	954	--	--	850	1 050	15	3RW4454-□BC□5	1	1 unit	42H
1 200	--	710	800	--	1 065	--	--	950	1 200	15	3RW4455-□BC□5	1	1 unit	42H
1 351	--	800	900	--	1 200	--	--	1 050	1 350	15	3RW4456-□BC□5	1	1 unit	42H
1 524	--	900	1 000	--	1 351	--	--	1 200	1 500	15	3RW4457-□BC□5	1	1 unit	42H
1 680	--	1 000	1 200	--	1 472	--	--	1 300	1 650	15	3RW4458-□BC□5	1	1 unit	42H
1 864	--	1 100	1 350	--	1 680	--	--	1 500	1 900	15	3RW4465-□BC□5	1	1 unit	42H
2 103	--	1 200	1 500	--	1 864	--	--	1 700	2 100	15	3RW4466-□BC□5	1	1 unit	42H

Article No. supplement for connection types

- With spring-type terminals
- With screw terminals

Article No. supplement for rated control supply voltage U_s ²⁾

- 115 V AC
- 230 V AC

¹⁾ Soft starter with screw terminals:

3RW442. to 3RW444. Standard delivery time SD = 2 days (d),
3RW445. to 3RW446. Standard delivery time SD = 5 days (d).

²⁾ Control by way of the internal 24 V DC supply and direct control via PLC possible.

Note:

For the boundary conditions for the motor outputs specified here, see page 6/7.

Selection and ordering data

More information

Manual "SIRIUS 3RW44 soft starters", see
<https://support.industry.siemens.com/cs/ww/en/view/21772518>

Version	SD	Article No.	Price per PU	PU (UNIT, SET, M)	PS*	PG
USB PC cables						
 3UF7941-0AA00-0		For PC/PG communication with SIRIUS 3RW44 soft starters Through the system interface, for connecting to the USB interface of the PC/PG	▶	3UF7941-0AA00-0	1	1 unit 42J
Communication modules						
 3RW4900-0KC00		PROFIBUS communication module For 3RW44 soft starter integration in the PROFIBUS network with DPV1 slave functionality. With firmware version E04 and higher (or date of manufacture 01.05.2009 and later) of the module, DPV1 operation of the soft starter on a Y-link is also possible (only DPV0 operation possible with < E04).	▶	3RW4900-0KC00	1	1 unit 42H
 3RW4900-0NC00		PROFINET communication module For 3RW44 soft starter integration in the PROFINET network, suitable for devices with firmware version E12 or higher	▶	3RW4900-0NC00	1	1 unit 42H
External display and operator module						
 3RW4900-0AC00		For indicating and operating the functions provided by the soft starter using an externally mounted display and operator module in degree of protection IP54 (e.g. in the control cabinet door)	▶	3RW4900-0AC00	1	1 unit 42H
Connection cables						
		From the device interface (serial) of the 3RW44 soft starter to the external display and operator module				
		• Length 0.5 m, flat	▶	3UF7932-0AA00-0	1	1 unit 42J
		• Length 0.5 m, round	▶	3UF7932-0BA00-0	1	1 unit 42J
		• Length 1.0 m, round	▶	3UF7937-0BA00-0	1	1 unit 42J
		• Length 2.5 m, round	▶	3UF7933-0BA00-0	1	1 unit 42J
Box terminal blocks for soft starters						
 3RT1956-4G		Box terminal block (2 units are required for each device)				
	3RW442.	Included in the scope of supply				
	3RW443.	• Up to 70 mm ²	▶	3RT1956-4G	1	1 unit 41B
		• Up to 120 mm ²	▶	3RT1956-4G	1	1 unit 41B
		Auxiliary conductor connection for box terminals	5	3TX7500-0A	1	1 unit 41B
	3RW444.	• Up to 240 mm ² (with auxiliary conductor connection)	▶	3RT1966-4G	1	1 unit 41B
Covers for soft starters						
Terminal covers for box terminals						
Additional touch protection to be fitted at the box terminals (2 units required per device)						
	3RW442. and 3RW443.		▶	3RT1956-4EA2	1	1 unit 41B
	3RW444.		▶	3RT1966-4EA2	1	1 unit 41B
Terminal covers for cable lugs and busbar connections						
 3RT1956-4EA1		For complying with the voltage clearances and as touch protection (2 units required per contactor) Also fits on mounted box terminals.				
	3RW442. and 3RW443.		▶	3RT1956-4EA1	1	1 unit 41B
	3RW444.		▶	3RT1966-4EA1	1	1 unit 41B

SIRIUS 3RW Soft Starters

General Performance Soft Starters

3RW52 Soft Starters

General data **NEW**

Overview

More information

Homepage, see www.siemens.com/soft-starter
 Industry Mall, see www.siemens.com/product?3RW

Online configurator, see www.siemens.com/sirius/configurators
 Simulation Tool for Soft Starters (STS), see page 6/7 or
<https://support.industry.siemens.com/cs/ww/en/view/101494917>



SIRIUS 3RW52 General Performance soft starters are the ideal solution for standard applications. With ideal 3-phase motor control, they cover the performance range from 5.5 kW to 560 kW (at 400 V).

With optional HMI modules, plug-in communication modules (PROFINET, PROFIBUS, Modbus) and either an analog output or thermistor motor protection, they ensure maximum flexibility. With their modern hybrid switching technology, the SIRIUS 3RW52 soft starters offer efficient switching for long-term, energy-saving use.

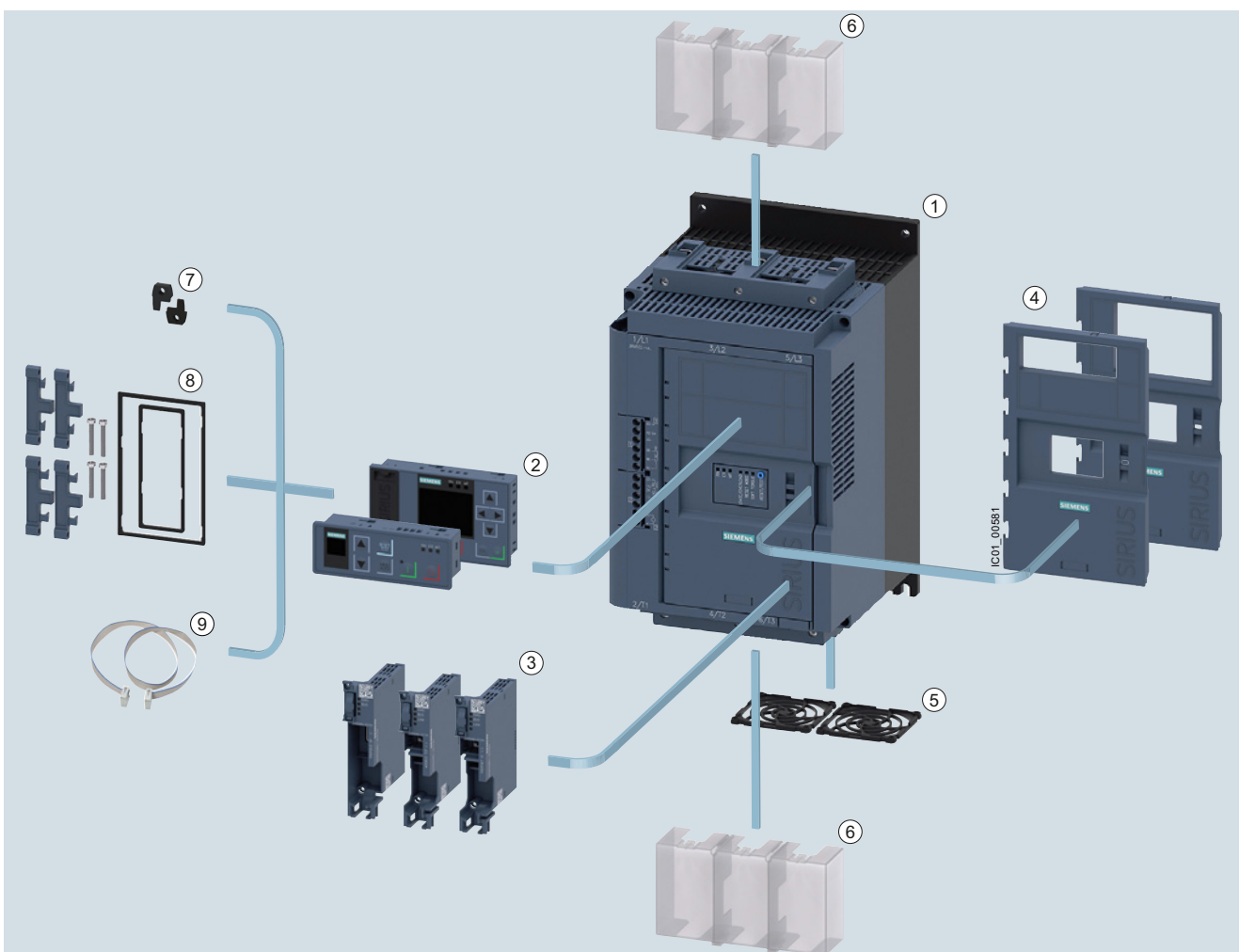

① 3RW52 soft starter

② HMI modules

③ Communication modules

④ Hinged cover

⑤ Fan covers

⑥ Terminal covers

⑦ Push-in lugs for wall mounting

⑧ IP65 door mounting kit

⑨ HMI soft starter connection cable

General Performance soft starters with accessories, for expansion with HMI module or communication modules, see [Accessories](#), page 6/44

Benefits

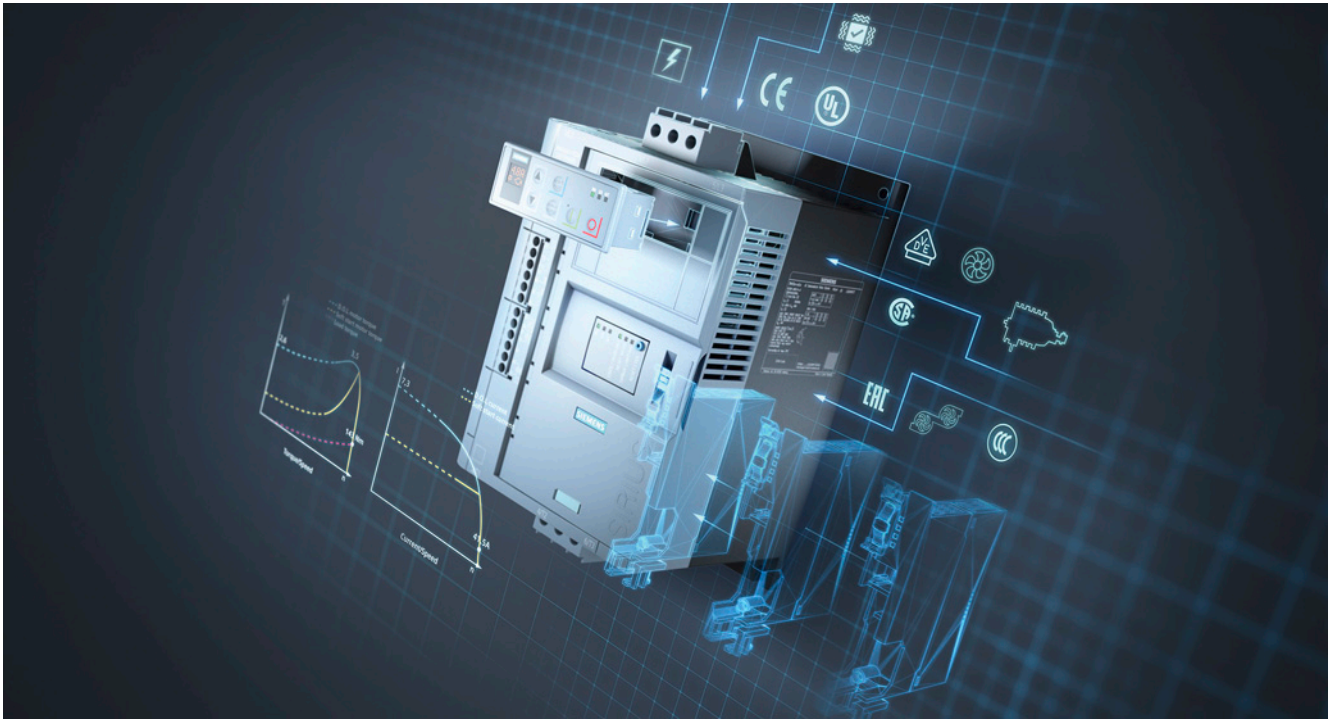

Product characteristics / function

Hybrid switching devices and three-phase motor control

TIA-Integration – communication modules and HMI modules optional

Soft Torque

Parameterization using potentiometers

Wide range for control supply and main voltage

Performance features / benefits

Minimum power loss and optimum/symmetrical motor control

Efficient configuration and maximum flexibility in automation engineering

Reduced mechanical loading and optimum pump stop

Simple and fast commissioning

Low variance, high system availability even with weak supply networks

SIRIUS 3RW Soft Starters

General Performance Soft Starters

3RW52 Soft Starters

General data **NEW**

Technical specifications

More information

Technical specifications, see <https://support.industry.siemens.com/cs/ww/en/ps/25100/td>
 Manual, see <https://support.industry.siemens.com/cs/ww/en/view/109753751>
 FAQs, see <https://support.industry.siemens.com/cs/ww/en/ps/25100/faq>

Simulation Tool for Soft Starters (STS), see page 6/7 or <https://support.industry.siemens.com/cs/ww/en/view/101494917>

Type	3RW5213 3RW5214 3RW5215	3RW5216 3RW5217	3RW5224 3RW5225	3RW5226 3RW5227 3RW5234 3RW5235 3RW5236	3RW5243 3RW5244 3RW5245 3RW5246 3RW5247 3RW5248
------	-------------------------------	--------------------	--------------------	---	--

Installation/fixing/dimensions

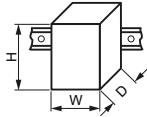
Width x height x depth	mm	170 × 275 × 152	185 × 306 × 203	210 × 393 × 203
				

Type of fixing	Screw fixing				
Mounting position	For vertical mounting surface can be rotated +/-10° and tilted forward or backward	For vertical mounting surface can be rotated +/-90°, for vertical mounting surface can be tilted +/- 22.5° forward or backward	For vertical mounting surface can be rotated +/-10° and tilted forward or backward	For vertical mounting surface can be rotated +/-90°, for vertical mounting surface can be tilted +/- 22.5° forward or backward	

Distance to be maintained with side-by-side mounting				
• Above	mm	100		
• At the side	mm	5		
• Below	mm	75		
Maximum installation altitude above sea level ¹⁾	m	5 000		

Ambient conditions

Ambient temperature				
• During operation ²⁾	°C	-25 ... +60		
• During storage	°C	-40 ... +80		

Environmental category according to IEC 60721				
• During operation		3K6 (no ice formation, no condensation), 3C3 (no salt mist), 3S2 (sand must not get into the devices), 3M6		
• During storage		3K6 (no ice formation, no condensation), 3C3 (no salt mist), 3S2 (sand must not get into the devices), 3M6		
• During transport		3K6 (no ice formation, no condensation), 3C3 (no salt mist), 3S2 (sand must not get into the devices), 3M6		

¹⁾ Derating above 1000 m, see Manual or characteristic curve on page 6/7.

²⁾ Note derating above 40 °C

Type		3RW521.-..C0.	3RW521.-..C1.	3RW522.-..C0. 3RW523.-..C0.	3RW522.-..C1. 3RW523.-..C1.	3RW524.-..C0.	3RW524.-..C1.
Control circuit/control							
Control supply voltage							
• At AC/DC, rated value	V	24/24	--/--	24/24	--/--	24/24	--/--
• At AC	V	--	110 ... 250	--	110 ... 250	--	110 ... 250
• Relative negative tolerance/ relative positive tolerance with AC	%	-20/20	-15/10	-20/20	-15/10	-20/20	-15/10
• Relative negative tolerance/ relative positive tolerance with DC	%	-20/20	--/--	-20/20	--/--	-20/20	--/--
Frequency of the control supply voltage							
• Relative negative tolerance/relative positive tolerance	Hz	50 ... 60					
	%	-10/10					
Control supply current in standby mode							
Rated value	mA	160	30	160	30	160	30
Holding current in bypass mode							
Rated value	mA	360	75	380	75	470	100
Maximum locked-rotor current on closing the bypass contacts							
	A	0.75	0.17	7.6	2.5	7.6	2.2
Maximum inrush current peak on applying the control supply voltage							
	A	3.3	12.2	3.3	12.2	3.3	12.2
Duration of inrush current peak on applying the control supply voltage							
	ms	12.1	2.2	12.1	2.2	12.1	2.2
Type of overvoltage protection							
		Varistors					
Type of short-circuit protection for control circuit¹⁾							
		Fuse 4 A gG ($I_{cu}=1$ kA), fuse 6 A quick-response ($I_{cu}=1$ kA), MCB C1 ($I_{cu} = 600$ A), MCB C6 ($I_{cu} = 300$ A)					

¹⁾ Not included in scope of supply

Type		3RW52.-..C.4	3RW52.-..C.5
Power electronics			
Operational voltage rated value			
• Relative negative tolerance/ relative positive tolerance	V	200 ... 480	
	%	-15/10	
Operational voltage for inside-delta circuit rated value			
• Relative negative tolerance/ relative positive tolerance	V	200 ... 480	
	%	-15/10	
Operating frequency			
• Relative negative tolerance/ relative positive tolerance	Hz	50 ... 60	
	%	-10/10	
Minimum load [% of I_M]¹⁾			
	%	15	
Length of cable between soft starter and motor			
	m	800	
Power loss [W] at 40 °C			
• At rated value current after startup	W	4	

¹⁾ Relative to set I_e

SIRIUS 3RW Soft Starters

General Performance Soft Starters

3RW52 Soft Starters

Inline circuit **IE3/IE4 ready** **NEW**

Selection and ordering data

For normal starting (CLASS 10A)



3RW521.



3RW522.



3RW523.



3RW524.

At 40 °C				At 50 °C				SD ¹⁾	Article No.	Price per PU	PU (UNIT, SET, M)	PS*	PG
Operational current	Operating power for three-phase motors			Operational current	Rating [hp] for three-phase motors								
	At 230 V	At 400 V	At 500 V		At 200/208 V	At 220/230 V	At 460/480 V	At 575/600 V	d				
A	kW	kW	kW	A	hp	hp	hp	hp					
Operational voltage 200 ... 480 V													
13	3	5.5	--	11.5	2	3	7.5	--	5	3RW5213-□□C□4	1	1 unit	42S
18	4	7.5	--	15.9	3	5	10	--	5	3RW5214-□□C□4	1	1 unit	42S
25	5.5	11	--	22.3	5	7.5	15	--	5	3RW5215-□□C□4	1	1 unit	42S
32	7.5	15	--	28.4	7.5	10	20	--	5	3RW5216-□□C□4	1	1 unit	42S
38	11	18.5	--	33.5	10	10	20	--	5	3RW5217-□□C□4	1	1 unit	42S
47	11	22	--	41.6	10	10	30	--	5	3RW5224-□□C□4	1	1 unit	42S
63	18.5	30	--	55.5	15	20	40	--	5	3RW5225-□□C□4	1	1 unit	42S
77	22	37	--	68	20	25	50	--	5	3RW5226-□□C□4	1	1 unit	42S
93	22	45	--	82.5	25	30	60	--	5	3RW5227-□□C□4	1	1 unit	42S

Type of electrical connection for the control circuit

Screw terminals
Spring-type terminals

Product function

Analog output
Thermistor motor protection

Control supply voltage

24 V AC/DC
110 ... 250 V AC



¹⁾ 3RW52 soft starter with screw terminals for operational voltage up to 480 V:
Standard delivery time SD = 1 day (d).

At 40 °C				At 50 °C				SD ¹⁾	Article No.	Price per PU	PU (UNIT, SET, M)	PS*	PG
Operational current	Operating power for three-phase motors			Operational current	Rating [hp] for three-phase motors								
	At 230 V	At 400 V	At 500 V		At 200/208 V	At 220/230 V	At 460/480 V	At 575/600 V	d				
A	kW	kW	kW	A	hp	hp	hp	hp					
Operational voltage 200 ... 480 V													
113	30	55	--	101	30	30	75	--	5	3RW5234-□□C□4	1	1 unit	42S
143	37	75	--	128	40	40	100	--	5	3RW5235-□□C□4	1	1 unit	42S
171	45	90	--	153	50	50	100	--	5	3RW5236-□□C□4	1	1 unit	42S
210	55	110	--	186	60	60	150	--	5	3RW5243-□□C□4	1	1 unit	42S
250	75	132	--	220	60	75	150	--	5	3RW5244-□□C□4	1	1 unit	42S
315	90	160	--	279	75	100	200	--	5	3RW5245-□□C□4	1	1 unit	42S
370	110	200	--	328	100	125	250	--	5	3RW5246-□□C□4	1	1 unit	42S
470	132	250	--	416	150	150	350	--	5	3RW5247-□□C□4	1	1 unit	42S
570	160	315	--	504	150	200	400	--	5	3RW5248-□□C□4	1	1 unit	42S

Type of electrical connection for the control circuit

Spring-type terminals
Screw terminals

Product function

Analog output
Thermistor motor protection

Control supply voltage

24 V AC/DC
110 ... 250 V AC



¹⁾ 3RW52 soft starter with screw terminals for operational voltage up to 480 V:
Standard delivery time SD = 1 day (d).

Note:
For the boundary conditions for the motor outputs specified here, see page 6/7.

SIRIUS 3RW Soft Starters

General Performance Soft Starters

3RW52 Soft Starters

NEW IE3/IE4 ready Inline circuit

For normal starting (CLASS 10A)



3RW5213.



3RW522.



3RW523.



3RW524.

At 40 °C				At 50 °C				SD ¹⁾	Article No.	Price per PU	PU (UNIT, SET, M)	PS*	PG
Operational current	Operating power for three-phase motors			Operational current	Rating [hp] for three-phase motors								
	At 230 V	At 400 V	At 500 V		At 200/208 V	At 220/230 V	At 460/480 V	At 575/600 V	d				
A	kW	kW	kW	A	hp	hp	hp	hp					
Operational voltage 200 ... 600 V													
13	3	5.5	7.5	11.5	2	3	7.5	10	5	3RW5213-□□□□5	1	1 unit	42S
18	4	7.5	11	15.9	3	5	10	10	5	3RW5214-□□□□5	1	1 unit	42S
25	5.5	11	15	22.3	5	7.5	15	20	5	3RW5215-□□□□5	1	1 unit	42S
32	7.5	15	18.5	28.4	7.5	10	20	25	5	3RW5216-□□□□5	1	1 unit	42S
38	11	18.5	22	33.5	10	10	20	30	5	3RW5217-□□□□5	1	1 unit	42S
47	11	22	30	41.6	10	10	30	40	5	3RW5224-□□□□5	1	1 unit	42S
63	18.5	30	37	55.5	15	20	40	50	5	3RW5225-□□□□5	1	1 unit	42S
77	22	37	45	68	20	25	50	60	5	3RW5226-□□□□5	1	1 unit	42S
93	22	45	55	82.5	25	30	60	75	5	3RW5227-□□□□5	1	1 unit	42S

Type of electrical connection for the control circuit

Screw terminals
Spring-type terminals

Product function

Analog output
Thermistor motor protection

Control supply voltage

24 V AC/DC
110 ... 250 V AC



¹⁾ 3RW52 soft starter with screw terminals for operational voltage up to 600 V:
Standard delivery time SD = 2 days (d).

At 40 °C				At 50 °C				SD ¹⁾	Article No.	Price per PU	PU (UNIT, SET, M)	PS*	PG
Operational current	Operating power for three-phase motors			Operational current	Rating [hp] for three-phase motors								
	At 230 V	At 400 V	At 500 V		At 200/208 V	At 220/230 V	At 460/480 V	At 575/600 V	d				
A	kW	kW	kW	A	hp	hp	hp	hp					
Operational voltage 200 ... 600 V													
113	30	55	75	101	30	30	75	100	5	3RW5234-□□□□5	1	1 unit	42S
143	37	75	90	128	40	40	100	125	5	3RW5235-□□□□5	1	1 unit	42S
171	45	90	110	153	50	50	100	150	5	3RW5236-□□□□5	1	1 unit	42S
210	55	110	132	186	60	60	150	150	5	3RW5243-□□□□5	1	1 unit	42S
250	75	132	160	220	60	75	150	200	5	3RW5244-□□□□5	1	1 unit	42S
315	90	160	200	279	75	100	200	250	5	3RW5245-□□□□5	1	1 unit	42S
370	110	200	250	328	100	125	250	300	5	3RW5246-□□□□5	1	1 unit	42S
470	132	250	315	416	150	150	350	450	5	3RW5247-□□□□5	1	1 unit	42S
570	160	315	355	504	150	200	400	500	5	3RW5248-□□□□5	1	1 unit	42S

Type of electrical connection for the control circuit

Spring-type terminals
Screw terminals

Product function

Analog output
Thermistor motor protection

Control supply voltage

24 V AC/DC
110 ... 250 V AC



¹⁾ 3RW52 soft starter with screw terminals for operational voltage up to 600 V:
Standard delivery time SD = 2 days (d).

Note:

For the boundary conditions for the motor outputs specified here, see page 6/7.



SIRIUS 3RW Soft Starters

General Performance Soft Starters

3RW52 Soft Starters

Inside-delta circuit **IE3/IE4 ready** **NEW**

Selection and ordering data

For normal starting (CLASS 10A)

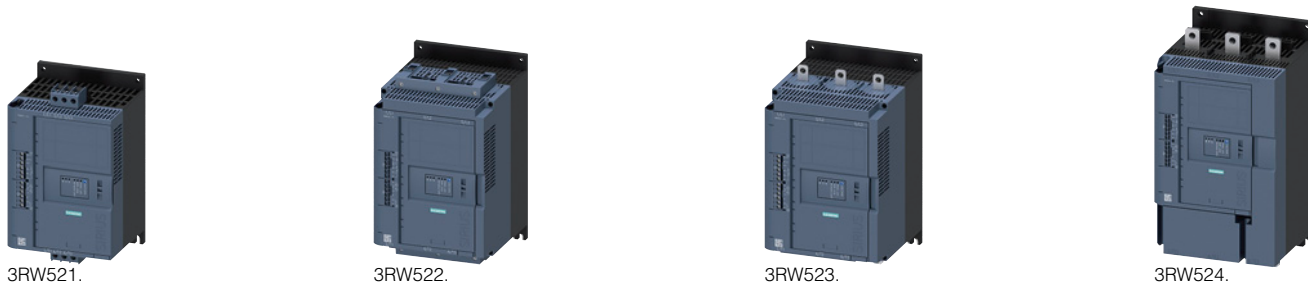

At 40 °C for inside-delta circuit				At 50 °C for inside-delta circuit				SD ¹⁾	Article No.	Price per PU	PU (UNIT, SET, M)	PS*	PG
Operational current	Operating power for three-phase motors			Operational current	Rating [hp] for three-phase motors								
	At 230 V	At 400 V	At 500 V		At 200/208 V	At 220/230 V	At 460/480 V	At 575/600 V	d				
A	kW	kW	kW	A	hp	hp	hp	hp					
Operational voltage 200 ... 480 V													
22.5	5.5	11	--	19.9	5	5	10	--	5	3RW5213-□□C□4	1	1 unit	42S
31.5	7.5	15	--	28	7.5	7.5	20	--	5	3RW5214-□□C□4	1	1 unit	42S
43.3	11	18.5	--	39	10	10	25	--	5	3RW5215-□□C□4	1	1 unit	42S
55.4	15	22	--	49	15	15	30	--	5	3RW5216-□□C□4	1	1 unit	42S
65.8	18.5	30	--	58	15	20	40	--	5	3RW5217-□□C□4	1	1 unit	42S
81.4	22	45	--	72	20	25	50	--	5	3RW5224-□□C□4	1	1 unit	42S
109	30	55	--	96	30	30	75	--	5	3RW5225-□□C□4	1	1 unit	42S
133	37	75	--	118	30	40	75	--	5	3RW5226-□□C□4	1	1 unit	42S
161	45	90	--	143	40	50	100	--	5	3RW5227-□□C□4	1	1 unit	42S

Type of electrical connection for the control circuit

Screw terminals
Spring-type terminals

Product function

Analog output
Thermistor motor protection

Control supply voltage

24 V AC/DC
110 ... 250 V AC



¹⁾ 3RW52 soft starter with screw terminals for operational voltage up to 480 V:
Standard delivery time SD = 1 day (d).

At 40 °C for inside-delta circuit				At 50 °C for inside-delta circuit				SD ¹⁾	Article No.	Price per PU	PU (UNIT, SET, M)	PS*	PG
Operational current	Operating power for three-phase motors			Operational current	Rating [hp] for three-phase motors								
	At 230 V	At 400 V	At 500 V		At 200/208 V	At 220/230 V	At 460/480 V	At 575/600 V	d				
A	kW	kW	kW	A	hp	hp	hp	hp					
Operational voltage 200 ... 480 V													
196	55	110	--	175	50	60	125	--	5	3RW5234-□□C□4	1	1 unit	42S
248	75	132	--	222	75	75	150	--	5	3RW5235-□□C□4	1	1 unit	42S
296	90	160	--	265	75	100	200	--	5	3RW5236-□□C□4	1	1 unit	42S
364	110	200	--	322	100	125	250	--	5	3RW5243-□□C□4	1	1 unit	42S
433	132	250	--	381	125	150	300	--	5	3RW5244-□□C□4	1	1 unit	42S
546	160	315	--	483	150	200	400	--	5	3RW5245-□□C□4	1	1 unit	42S
641	200	355	--	568	200	200	450	--	5	3RW5246-□□C□4	1	1 unit	42S
814	250	400	--	721	250	250	600	--	5	3RW5247-□□C□4	1	1 unit	42S
987	315	560	--	873	300	350	750	--	5	3RW5248-□□C□4	1	1 unit	42S

Type of electrical connection for the control circuit

Spring-type terminals
Screw terminals

Product function

Analog output
Thermistor motor protection

Control supply voltage

24 V AC/DC
110 ... 250 V AC



¹⁾ 3RW52 soft starter with screw terminals for operational voltage up to 480 V:
Standard delivery time SD = 1 day (d).

Note:
For the boundary conditions for the motor outputs specified here, see page 6/7.

SIRIUS 3RW Soft Starters

General Performance Soft Starters

3RW52 Soft Starters

NEW IE3/IE4 ready Inside-delta circuit

For normal starting (CLASS 10A)



3RW521.



3RW522.



3RW523.



3RW524.

At 40 °C for inside-delta circuit				At 50 °C for inside-delta circuit				SD ¹⁾	Article No.	Price per PU	PU (UNIT, SET, M)	PS*	PG
Operational current	Operating power for three-phase motors			Operational current	Rating [hp] for three-phase motors								
	At 230 V	At 400 V	At 500 V		At 200/208 V	At 220/230 V	At 460/480 V	At 575/600 V	d				
A	kW	kW	kW	A	hp	hp	hp	hp					
Operational voltage 200 ... 600 V													
22.5	5.5	11	15	19.9	5	5	10	15	5	3RW5213-□□□□5	1	1 unit	42S
31.5	7.5	15	18.5	28	7.5	7.5	20	25	5	3RW5214-□□□□5	1	1 unit	42S
43.3	11	18.5	22	39	10	10	25	30	5	3RW5215-□□□□5	1	1 unit	42S
55.4	15	22	30	49	15	15	30	40	5	3RW5216-□□□□5	1	1 unit	42S
65.8	18.5	30	37	58	15	20	40	50	5	3RW5217-□□□□5	1	1 unit	42S
81.4	22	45	45	72	20	25	50	60	5	3RW5224-□□□□5	1	1 unit	42S
109	30	55	55	96	30	30	75	75	5	3RW5225-□□□□5	1	1 unit	42S
133	37	75	90	118	30	40	75	100	5	3RW5226-□□□□5	1	1 unit	42S
161	45	90	110	143	40	50	100	125	5	3RW5227-□□□□5	1	1 unit	42S

Type of electrical connection for the control circuit

Screw terminals
Spring-type terminals

Product function

Analog output
Thermistor motor protection

Control supply voltage

24 V AC/DC
110 ... 250 V AC

¹⁾ 3RW52 soft starter with screw terminals for operational voltage up to 600 V:
Standard delivery time SD = 2 days (d).



At 40 °C for inside-delta circuit				At 50 °C for inside-delta circuit				SD ¹⁾	Article No.	Price per PU	PU (UNIT, SET, M)	PS*	PG
Operational current	Operating power for three-phase motors			Operational current	Rating [hp] for three-phase motors								
	At 230 V	At 400 V	At 500 V		At 200/208 V	At 220/230 V	At 460/480 V	At 575/600 V	d				
A	kW	kW	kW	A	hp	hp	hp	hp					
Operational voltage 200 ... 600 V													
196	55	110	132	175	50	60	125	150	5	3RW5234-□□□□5	1	1 unit	42S
248	75	132	160	222	75	75	150	200	5	3RW5235-□□□□5	1	1 unit	42S
296	90	160	200	265	75	100	200	250	5	3RW5236-□□□□5	1	1 unit	42S
364	110	200	250	322	100	125	250	300	5	3RW5243-□□□□5	1	1 unit	42S
433	132	250	315	381	125	150	300	350	5	3RW5244-□□□□5	1	1 unit	42S
546	160	315	355	483	150	200	400	500	5	3RW5245-□□□□5	1	1 unit	42S
641	200	355	450	568	200	200	450	600	5	3RW5246-□□□□5	1	1 unit	42S
814	250	400	500	721	250	250	600	800	5	3RW5247-□□□□5	1	1 unit	42S
987	315	560	630	873	300	350	750	950	5	3RW5248-□□□□5	1	1 unit	42S

Type of electrical connection for the control circuit

Spring-type terminals
Screw terminals

Product function

Analog output
Thermistor motor protection

Control supply voltage

24 V AC/DC
110 ... 250 V AC

¹⁾ 3RW52 soft starter with screw terminals for operational voltage up to 600 V:
Standard delivery time SD = 2 days (d).



Note:

For the boundary conditions for the motor outputs specified here, see page 6/7.



SIRIUS 3RW Soft Starters







General Performance Soft Starters

3RW52 Soft Starters

Accessories **NEW**

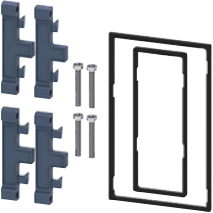
Selection and ordering data

Product designation	Manufacturer's Article No. of the soft starter	Type of product	Application	SD	Article No.	Price per PU	PU (UNIT, SET, M)	PS*	PG	
Fan covers										
	Fan cover	3RW5216/17 (1x), 3RW5226/27, 3RW523 (2x)	--	--	1	3RW5983-0FC00		1	1 unit	42S
3RW5983-0FC00		3RW524	--	--	1	3RW5984-0FC00		1	1 unit	42S
Terminal covers										
	Terminal cover	3RW522, 3RW523 (2x)	--	--	1	3RW5983-0TC20		1	1 unit	42S
3RW5983-0TC20		3RW524 (2x)	--	--	1	3RW5984-0TC20		1	1 unit	42S
										
3RW5984-0TC20										
Enclosure components										
	Hinged cover	3RW52	With cutout for HMI module High Feature	--	1	3RW5950-0GL30		1	1 unit	42S
3RW5950-0GL30										
			With cutout for HMI module Standard	--	1	3RW5950-0GL40		1	1 unit	42S
3RW5950-0GL40										
Communication modules										
	Communication module	3RW52	PROFINET Standard	--	1	3RW5980-0CS00		1	1 unit	42S
			PROFIBUS	--	1	3RW5980-0CP00		1	1 unit	42S
			Modbus TCP	--	1	3RW5980-0CT00		1	1 unit	42S
3RW5980-0CS00										

Product designation	Manufacturer's Article No. of the soft starter	Type of product	Application	SD	Article No.	Price per PU	PU (UNIT, SET, M)	PS*	PG
HMI modules									
	HMI module	3RW52	High Feature	--	1	3RW5980-0HF00	1	1 unit	42S
3RW5980-0HF00									
			Standard	--	1	3RW5980-0HS00	1	1 unit	42S
3RW5980-0HS00									
	Door mounting kit	3RW52	IP65	For HMI modules	1	3RW5980-0HD00	1	1 unit	42S
3RW5980-0HD00									
Connection cables									
	HMI connection cable	3RW52	5 m	For door mounting	1	3RW5980-0HC60	1	1 unit	42S
	Connection cables	--	Length 2.5 m, round	For connection of the system components	▶	3UF7933-0BA00-0	1	1 unit	42J
3UF7933-0BA00-0									
			Length 1.0 m, round	For connection of the system components	▶	3UF7937-0BA00-0	1	1 unit	42J
			Length 0.5 m, round	For connection of the system components	▶	3UF7932-0BA00-0	1	1 unit	42J
			Length 0.1 m, flat	For connection of the system components	▶	3UF7931-0AA00-0	1	1 unit	42J
									
3UF7931-0AA00-0									
Further accessories									
	Push-in lugs for wall mounting	--	Two lugs are required per device	--	2	3ZY1311-0AA00	1	10 units	41L
3ZY1311-0AA00									

SIRIUS 3RW Soft Starters

Basic Performance Soft Starters

3RW40 Soft Starters

General data

Overview

More information

Homepage, see www.siemens.com/soft-starter
 Industry Mall, see www.siemens.com/product?3RW

Online configurator, see www.siemens.com/sirius/configurators
 Simulation Tool for Soft Starters (STS), see page 6/7 or
<https://support.industry.siemens.com/cs/ww/en/view/101494917>



The SIRIUS 3RW40 Basic Performance soft starters are suitable for soft starting and stopping of three-phase asynchronous motors.

Due to two-phase control, the current is kept at minimum values in all three phases throughout the entire starting time and disturbing direct current components are eliminated in addition. This not only enables the two-phase starting of motors up to 250 kW (at 400 V) but also avoids the current and torque peaks which occur e.g. with wye-delta starters.

The SIRIUS 3RW40 soft starters are suitable for the starting of explosion-proof motors with "increased safety" type of protection EEx e according to ATEX Directive 94/9/EC.

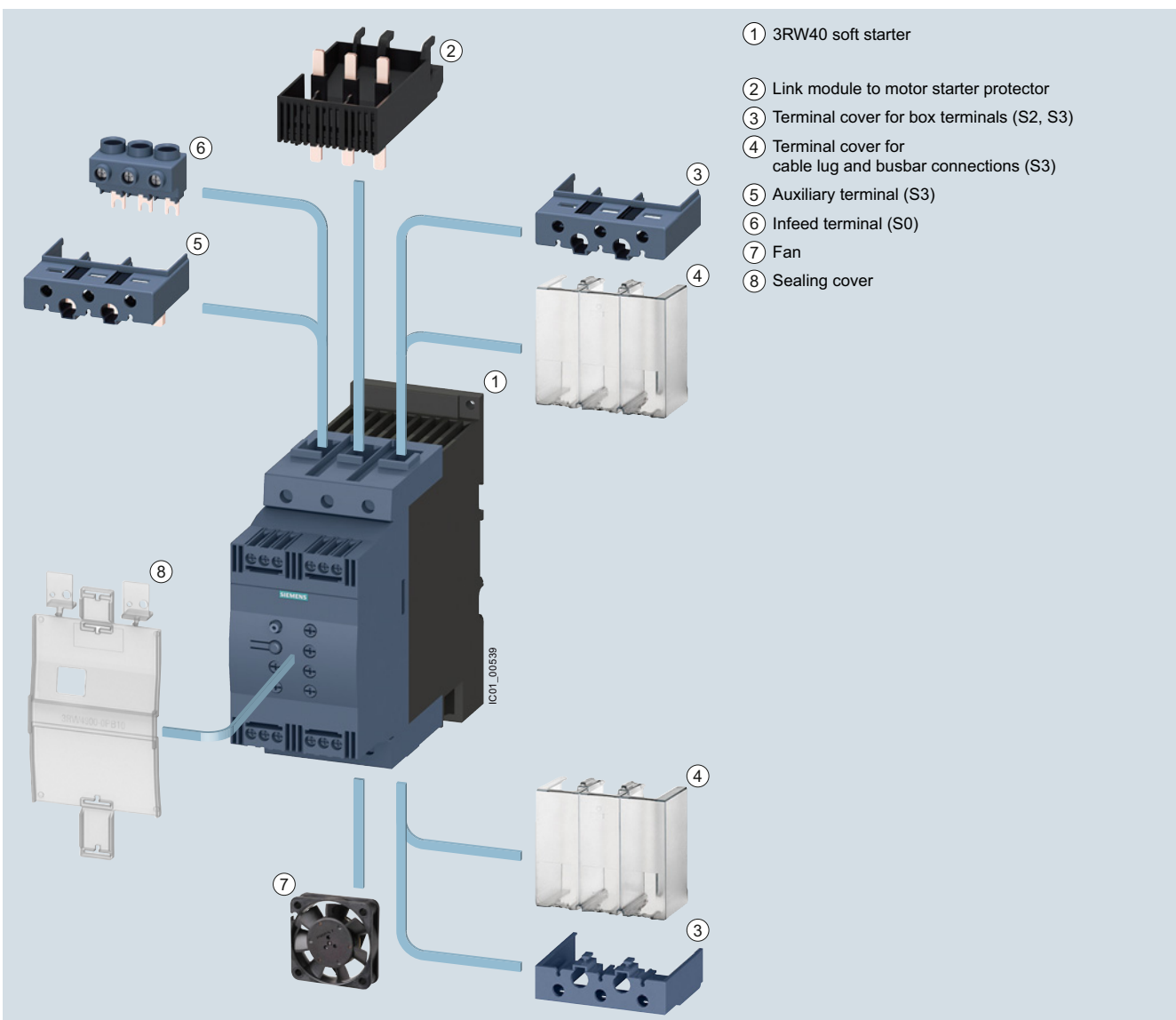

- ① 3RW40 soft starter
- ② Link module to motor starter protector
- ③ Terminal cover for box terminals (S2, S3)
- ④ Terminal cover for cable lug and busbar connections (S3)
- ⑤ Auxiliary terminal (S3)
- ⑥ Infeed terminal (S0)
- ⑦ Fan
- ⑧ Sealing cover

3RW40 Basic Performance soft starters, accessories, see page 6/57.

Benefits



3RW402.



3RW403.



3RW404.



3RW405.



3RW407.

Product characteristics / function	Performance features / benefits
Small and compact design	Space-saving, clearly arranged control panel layout
Motor overload and intrinsic device protection without additional wiring	Adjustable trip classes, integrated diagnostics functions
Integrated bypass contact system	Reduction of power loss during operation
Certified according to ATEX Directive 94/9/EC	Suitable for the starting of explosion-proof motors with "increased safety" type of protection EEx e.
Optional thermistor motor protection up to a rating of 55 kW	Full motor protection

SIRIUS 3RW Soft Starters

Basic Performance 3RW40 Soft Starters

General data

Technical specifications

More information

Manual "SIRIUS 3RW30/3RW40 Soft Starters", see <https://support.industry.siemens.com/cs/ww/en/view/38752095>

Catalog LV 10, see www.siemens.com/lowvoltage/lv10

FAQs, see <https://support.industry.siemens.com/cs/ww/en/ps/25251/faq>

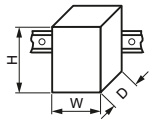
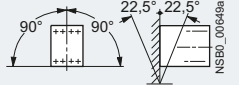
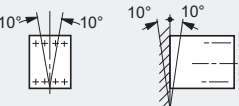
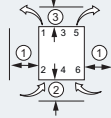
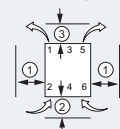
Type		3RW402.	3RW403.	3RW404.	3RW405.	3RW407.	
Mechanics and environment							
Mounting dimensions (W x H x D)							
<ul style="list-style-type: none"> • Screw terminals • Spring-type terminals 		mm	45 x 125 x 154	55 x 144 x 170	70 x 160 x 188	120 x 198 x 250	160 x 230 x 278
		mm	45 x 150 x 154	55 x 144 x 170	70 x 160 x 188	120 x 198 x 250	160 x 230 x 278
Permissible ambient temperature							
During operation	°C	-25 ... +60; (derating from +40)					
During storage	°C	-40 ... +80					
Weight							
	kg	0.77	1.35	1.9	4.9 (3RW4055) 6.9 (3RW4056)	8.9	
Permissible mounting position¹⁾							
<ul style="list-style-type: none"> • With auxiliary fan (for 3RW402. ... 3RW404.) 							
	<ul style="list-style-type: none"> • Without auxiliary fan (for 3RW402. ... 3RW404.) 			-- (fan integrated in the soft starter)			
Installation type¹⁾							
Stand-alone installation		3RW402.	 <ul style="list-style-type: none"> ① ≥ 15 mm (≥ 0.59 in) ② ≥ 40 mm (≥ 1.56 in) ③ ≥ 60 mm (≥ 2.36 in) 			3RW405., 3RW407.	<ul style="list-style-type: none"> ① ≥ 5 mm (≥ 0.2 in) ② ≥ 75 mm (≥ 3 in) ③ ≥ 100 mm (≥ 4 in)
		3RW403., 3RW404.	 <ul style="list-style-type: none"> ① ≥ 30 mm (≥ 1.18 in) ② ≥ 40 mm (≥ 1.56 in) ③ ≥ 60 mm (≥ 2.36 in) 				
Permissible installation altitude							
	m	5 000 (Derating from 1 000, see characteristic curve on page 6/7)					
Degree of protection							
IP20 for 3RW402.; all others IP00							

¹⁾ In the case of deviations, please observe derating, see [Manual in the chapter "Configuring"](#).

Type	Terminal	3RW402., 3RW403., 3RW404.	3RW405., 3RW407.
Control electronics			
Rated values			
Rated control supply voltage	A1/A2	V	24 DC/AC 110 ... 230 AC/DC
• Tolerance		%	±20 -15/+10
Rated frequency		Hz	50/60
• Tolerance		%	±10

SIRIUS 3RW Soft Starters

Basic Performance

3RW40 Soft Starters

General data

Type		3RW402.-..B.4, 3RW403.-..B.4, 3RW404.-..B.4	3RW402.-..B.5, 3RW403.-..B.5, 3RW404.-..B.5	3RW405.-.BB.4, 3RW407.-.BB.4	3RW405.-.BB.5, 3RW407.-.BB.5
Power electronics					
Rated operational voltage	V AC	200 ... 480	400 ... 600	200 ... 460	400 ... 600
Tolerance	%	-15/+10			
Maximum blocking voltage (thyristor)	V AC	1600		1400	1800
Rated frequency	Hz	50/60			
Tolerance	%	± 10			
Uninterrupted duty at 40 °C (% of I_e)	%	115			
Minimum load (% of smallest adjustable rated motor current I_M)	%	20 (at least 2 A)			
Maximum cable length between soft starter and motor	m	300			

Type		3RW4024	3RW4026	3RW4027	3RW4028
Power electronics					
Load rating with rated operational current I_e					
• According to IEC and UL/CSA ¹⁾ , for individual mounting, AC-53a					
- At 40 °C	A	12.5	25.3	32.2	38
- At 50 °C	A	11	23	29	34
- At 60 °C	A	10	21	26	31
Smallest adjustable rated motor current I_M					
For the motor overload protection	A	5	10	17	23
Power loss					
• In operation after completed starting with uninterrupted rated operational current (40 °C) approx.	W	2	8	13	19
• During starting with current limit set to 300% I_M (40 °C)	W	68	188	220	256
Permissible rated motor current and starts per hour at 40 °C / 50 °C					
• For normal starting (CLASS 10)					
- Rated motor current $I_M^{(2)}$, ramp-up time 3 s	A	12.5/11	25/23	32/29	38/34
- Starts per hour ³⁾	1/h	50/50	23/23	23/23	19/19
- Rated motor current $I_M^{(2)}$, ramp-up time 4 s	A	12.5/11	25/23	32/29	38/34
- Starts per hour ³⁾	1/h	36/36	15/15	16/16	12/12

¹⁾ Measurement at 60 °C according to UL/CSA not required.

²⁾ Current limit on soft starter set to 300% I_M , $T_U = 40 °C / 50 °C$. Maximum adjustable rated motor current I_M dependent on CLASS setting.

³⁾ For intermittent duty S4 with ON period = 30%, $T_U = 40 °C / 50 °C$, stand-alone installation vertical. The quoted switching frequencies do not apply for automatic mode. Factors for permissible switching frequency in other mounting position, direct mounting, side-by-side mounting, and implementation of optional auxiliary fan, see [Manual in the chapter "Configuring"](#).

SIRIUS 3RW Soft Starters

Basic Performance

3RW40 Soft Starters

General data

Type		3RW4036	3RW4037	3RW4038	3RW4046	3RW4047
Power electronics						
Load rating with rated operational current I_e						
• According to IEC and UL/CSA ¹⁾ , for individual mounting, AC-53a						
- At 40 °C	A	45	63	72	80	106
- At 50 °C	A	42	58	62.1	73	98
- At 60 °C	A	39	53	60	66	90
Smallest adjustable rated motor current I_M						
For the motor overload protection						
	A	23	26	35	43	46
Power loss						
• In operation after completed starting with uninterrupted rated operational current (40 °C) approx.						
	W	6	12	15	12	21
• During starting with current limit set to 300% I_M (40 °C)						
	W	316	444	500	576	768
Permissible rated motor current and starts per hour at 40 °C / 50 °C						
• For normal starting (CLASS 10)						
- Rated motor current $I_M^{(2)}$, ramp-up time 3 s						
	A	45/42	63/58	72/62	80/73	106/98
- Starts per hour ³⁾						
	1/h	38/38	23/23	22/22	22/22	15/15
- Rated motor current $I_M^{(2)}$, ramp-up time 4 s						
	A	45/42	63/58	72/62	80/73	106/98
- Starts per hour ³⁾						
	1/h	26/26	15/15	15/15	15/15	10/10

¹⁾ Measurement at 60 °C according to UL/CSA not required.

²⁾ Current limit on soft starter set to 300% I_M , $T_U = 40$ °C / 50 °C. Maximum adjustable rated motor current I_M dependent on CLASS setting.

³⁾ For intermittent duty S4 with ON period = 30%, $T_U = 40$ °C / 50 °C, stand-alone installation vertical. The quoted switching frequencies do not apply for automatic mode. Factors for permissible switching frequency in other mounting position, direct mounting, side-by-side mounting, and implementation of optional auxiliary fan, see [Manual in the chapter "Configuring"](#).

Type		3RW4055	3RW4056	3RW4073	3RW4074	3RW4075	3RW4076
Power electronics							
Load rating with rated operational current I_e							
• According to IEC and UL/CSA ¹⁾ , for individual mounting, AC-53a							
- At 40 °C	A	134	162	230	280	356	432
- At 50 °C	A	117	145	205	248	315	385
- At 60 °C	A	100	125	180	215	280	335
Smallest adjustable rated motor current I_M							
For the motor overload protection							
	A	59	87	80	130	131	207
Power loss							
• In operation after completed starting with uninterrupted rated operational current (40 °C) approx.							
	W	60	75		90	125	165
• During starting with current limit set to 350% ²⁾ I_M (40 °C)							
	W	1043	1355	2448	3257	3277	3600
Permissible rated motor current and starts per hour at 40 °C / 50 °C							
• For normal starting (CLASS 10)							
- Rated motor current $I_M^{(2)}$, ramp-up time 10 s							
	A	134/117	162/145	230/205	280/248	356/315	432/385
- Starts per hour ³⁾							
	1/h	20/20	8/8	14/14	20/20	16/16	17/17
- Rated motor current $I_M^{(2)}$, ramp-up time 20 s							
	A	134/117	162/145	230/205	280/248	356/315	432/385
- Starts per hour ³⁾							
	1/h	7/7	1.4/1.4	3/3	8/8	5/5	5/5

¹⁾ Measurement at 60 °C according to UL/CSA not required.

²⁾ Current limit on soft starter set to 350% I_M , $T_U = 40$ °C / 50 °C. Maximum adjustable rated motor current I_M dependent on CLASS setting.

³⁾ For intermittent duty S4 with ON period = 70%, $T_U = 40$ °C / 50 °C, stand-alone installation vertical. The quoted switching frequencies do not apply for automatic mode.

Motor feeders with soft starters

The type of coordination according to which the motor feeder with soft starter is mounted depends on the application-specific requirements. Normally, fuseless mounting (combination of motor starter protector and soft starter) is sufficient.

If type of coordination "2" is to be fulfilled, then semiconductor fuses must be fitted in the motor feeder.

ToC 1

Type of coordination "1" according to IEC 60947-4-1: After a short-circuit incident, the unit is defective and therefore unsuitable for further use (protection of persons and system guaranteed).

ToC 2

Type of coordination "2" according to IEC 60947-4-1: After a short-circuit incident the unit is suitable for further use (protection of persons and system guaranteed).

The type of coordination refers to soft starters in combination with the stipulated protective device (motor starter protector/fuse), not to any additional components in the feeder.

The types of coordination are indicated in the corresponding tables by the symbols shown on orange backgrounds.

Fuseless version

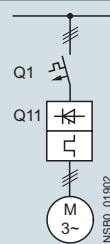

Soft starters

ToC 1

Motor starter protectors¹⁾

Q11	Rated current	Q1	I_q	Rated current
Type	A	Type	kA	A

Type of coordination "1"

3RW4024	12.5	3RV2021-4AA/ 3RV2011-4AA (in size S00)	55	16
3RW4026	25	3RV2021-4DA	55	25
3RW4027	32	3RV2021-4EA	55	32
3RW4028	38	3RV2021-4FA	55	40
3RW4036	45	3RV2031-4WA10	10	45
3RW4037	63	3RV2031-4JA10	10	63
3RW4038	72	3RV2031-4KA10	10	75
3RW4046	80	3RV2042-4RA10	11	84
3RW4047	106	3RV2042-4MA10	11	100
3RW4055	134	3VA2216-5MN32	55	160
3RW4056	162	3VA2220-5MN32	55	200
3RW4073	230	3VA2325-7MN32	100	250
3RW4074	280	3VA2440-7MN32	110	400
3RW4075	356	3VA2450-7MN32	110	500
3RW4076	432	3VA2450-7MN32	110	500

¹⁾ The rated motor current must be considered when selecting the devices.

SIRIUS 3RW Soft Starters

Basic Performance 3RW40 Soft Starters

General data

Fused version (line protection only)

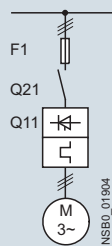

Soft starters		Line protection, maximum			Line contactor
Q11 Type	Rated current A	F1 Type	Rated current A	Size	(optional) Q21 Type
Type of coordination "1"¹⁾: $I_q = 65 \text{ kA at } 600 \text{ V} + 5\%$					
3RW4024	12.5	3NA3820-6	50	00	3RT2025/ 3RT2018 (in size S00)
3RW4026	25	3NA3822-6	63	00	3RT2026
3RW4027	32	3NA3824-6	80	00	3RT2027
3RW4028	38	3NA3824-6	80	00	3RT2028
3RW4036	45	3NA3130-6	100	1	3RT2036
3RW4037	63	3NA3132-6	125	1	3RT2037
3RW4038	72	3NA3132-6	125	1	3RT2038
3RW4046	80	3NA3136-6	160	1	3RT2038
3RW4047	106	3NA3136-6	160	1	3RT2046
3RW4055	134	3NA3244-6	250	2	3RT1055-6A.36
3RW4056	162	3NA3244-6	250	2	3RT1056-6A.36
3RW4073	230	2 x 3NA3354-6	2 x 355	3	3RT1065-6A.36
3RW4074	280	2 x 3NA3354-6	2 x 355	3	3RT1066-6A.36
3RW4075	356	2 x 3NA3365-6	2 x 500	3	3RT1075-6A.36
3RW4076	432	2 x 3NA3365-6	2 x 500	3	3RT1076-6A.36

¹⁾ The type of coordination "1" refers to soft starters in combination with the stipulated protective device (motor starter protector/fuse), not to any additional components in the feeder.

Fused version with 3NE1 SITOR fuses (semiconductor and line protection)

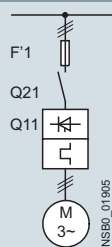

For matching fuse bases, see Catalog LV 10:

- "Fuse systems" → "SITOR Semiconductor Fuses" or www.siemens.com/sitor
- "Switch disconnectors"

Soft starters		All-range fuses			Line contactor
Q11 Type	Rated current A	F1 Type	Rated current A	Size	(optional) Q21 Type
Type of coordination "2"¹⁾: $I_q = 65 \text{ kA at } 600 \text{ V} + 5\%$					
3RW4024	12.5	3NE1814-0	20	000	3RT2025/ 3RT2018 (in size S00)
3RW4026	25	3NE1803-0	35	000	3RT2026
3RW4027	32	3NE1020-2	80	00	3RT2027
3RW4028	38	3NE1020-2	80	00	3RT2028
3RW4036	45	3NE1020-2	80	00	3RT2036
3RW4037	63	3NE1820-0	80	000	3RT2037
3RW4038	72	3NE1820-0	80	000	3RT2038
3RW4046	80	3NE1021-0	100	00	3RT2038
3RW4047	106	3NE1022-0	125	00	3RT2046
3RW4055	134	3NE1227-2	250	1	3RT1055-6A.36
3RW4056	162	3NE1227-2	250	1	3RT1056-6A.36
3RW4073	230	3NE1331-2	350	2	3RT1065-6A.36
3RW4074	280	3NE1333-2	450	2	3RT1066-6A.36
3RW4075	356	3NE1334-2	500	2	3RT1075-6A.36
3RW4076	432	3NE1435-2	560	3	3RT1076-6A.36

¹⁾ The type of coordination "2" refers to soft starters in combination with the stipulated protective device (motor starter protector/fuse), not to any additional components in the feeder.

Fused version with 3NE3 SITOR fuses (semiconductor protection by fuse, line and overload protection by motor starter protector; alternatively, installation with contactor and overload relay possible)

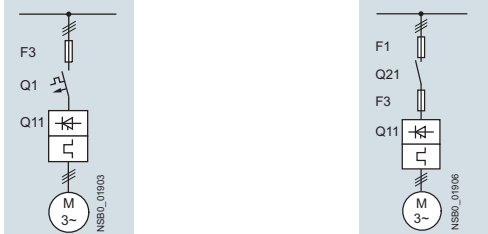

For matching fuse bases, see [Catalog LV 10](#):

- "Fuse systems" → "SITOR Semiconductor Fuses" or www.siemens.com/sitor
- "Switch disconnectors"

Soft starters		Semiconductor fuses, minimum			Semiconductor fuses, minimum			Semiconductor fuses, minimum		
Q11 Type	Rated current A	F3 Type	Rated current A	Size	F3 Type	Rated current A	Size	F3 Type	Rated current A	Size
Type of coordination "2"¹⁾: I_q = 65 kA at 600 V + 5%										
3RW4024	12.5	--	--	--	3NE4101	32	0	3NE8015-1	25	00
3RW4026	25	--	--	--	3NE4102	40	0	3NE8017-1	50	00
3RW4027	32	--	--	--	3NE4118	63	0	3NE8018-1	63	00
3RW4028	38	--	--	--	3NE4118	63	0	3NE8020-1	80	00
3RW4036	45	--	--	--	3NE4120	80	0	3NE8020-1	80	00
3RW4037	63	--	--	--	3NE4121	100	0	3NE8021-1	100	00
3RW4038	72	3NE3221	100	1	--	--	--	3NE8022-1	125	00
3RW4046	80	3NE3222	125	1	--	--	--	3NE8022-1	125	00
3RW4047	106	3NE3224	160	1	--	--	--	3NE8024-1	160	00
3RW4055	134	3NE3227	250	1	--	--	--	--	--	--
3RW4056	162	3NE3227	250	1	--	--	--	--	--	--
3RW4073	230	3NE3232-0B	400	1	--	--	--	--	--	--
3RW4074	280	3NE3233	450	1	--	--	--	--	--	--
3RW4075	356	3NE3335	560	2	--	--	--	--	--	--
3RW4076	432	3NE3337-8	710	2	--	--	--	--	--	--

Soft starters		Cylindrical fuses		Line contactor	Motor starter protectors		Line protection, maximum		
Q11 Type	Rated current A	F3 Type	Rated current A	(optional) Q21 Type	400 V + 10% Q1 Type	Rated current A	F1 Type	Rated current A	Size
Type of coordination "2"¹⁾: I_q = 65 kA at 600 V + 5%									
3RW4024	12.5	3NC2240	40	3RT2025/ 3RT2018 (in size S00)	3RV2021-4AA/ 3RV2011-4AA (in size S00)	16	3NA3820-6	50	00
3RW4026	25	3NC2263	63	3RT2026	3RV2021-4DA	25	3NA3822-6	63	00
3RW4027	32	3NC2280	80	3RT2027	3RV2021-4EA	32	3NA3824-6	80	00
3RW4028	38	3NC2280	80	3RT2028	3RV2021-4FA	40	3NA3824-6	80	00
3RW4036	45	3NC2280	80	3RT2036	3RV2031-4WA10	45	3NA3130-6	100	1
3RW4037	63	--	--	3RT2037	3RV2031-4JA10	63	3NA3132-6	125	1
3RW4038	72	--	--	3RT2038	3RV2031-4KA10	75	3NA3132-6	125	1
3RW4046	80	--	--	3RT2038	3RV2042-4RA10	84	3NA3136-6	160	1
3RW4047	106	--	--	3RT2046	3RV2042-4MA10	100	3NA3136-6	160	1
3RW4055	134	--	--	3RT1055-6A.36	3VA2216-5MN32	160	3NA3244-6	250	2
3RW4056	162	--	--	3RT1056-6A.36	3VA2220-5MN32	200	3NA3244-6	250	2
3RW4073	230	--	--	3RT1065-6A.36	3VA2325-7MN32	250	2 x 3NA3354-6	2 x 355	3
3RW4074	280	--	--	3RT1066-6A.36	3VA2440-7MN32	400	2 x 3NA3354-6	2 x 355	3
3RW4075	356	--	--	3RT1075-6A.36	3VA2450-7MN32	500	2 x 3NA3365-6	2 x 500	3
3RW4076	432	--	--	3RT1076-6A.36	3VA2450-7MN32	500	2 x 3NA3365-6	2 x 500	3

¹⁾ The type of coordination "2" refers to soft starters in combination with the stipulated protective device (motor starter protector/fuse), not to any additional components in the feeder.



SIRIUS 3RW Soft Starters

Basic Performance

3RW40 Soft Starters

Inline circuit **IE3/IE4 ready**

Selection and ordering data

For normal starting (CLASS 10)



3RW402.



3RW403.



3RW404.

3RW ambient temperature 40 °C				3RW ambient temperature 50 °C				Size	SD ¹⁾	Article No.	Price per PU	PU (UNIT, SET, M)	PS*	PG
Rated values of three-phase motors				Rated values of three-phase motors										
Operational current I_e	Rating at operational voltage U_e			Operational current I_e	Rating at operational voltage U_e									
	230 V	400 V	500 V		200 V	230 V	460 V	575 V						
A	kW	kW	kW	A	hp	hp	hp	hp	d					
Rated operational voltage U_e 200 ... 480 V														
12.5	3	5.5	--	11	3	3	7.5	--	S0	2	3RW4024-□BB□4	1	1 unit	42G
25	5.5	11	--	23	5	5	15	--	S0	2	3RW4026-□BB□4	1	1 unit	42G
32	7.5	15	--	29	7.5	7.5	20	--	S0	2	3RW4027-□BB□4	1	1 unit	42G
38	11	18.5	--	34	10	10	25	--	S0	2	3RW4028-□BB□4	1	1 unit	42G
45	11	22	--	42	10	15	30	--	S2	2	3RW4036-□BB□4	1	1 unit	42G
63	18.5	30	--	58	15	20	40	--	S2	2	3RW4037-□BB□4	1	1 unit	42G
72	22	37	--	62	20	20	40	--	S2	2	3RW4038-□BB□4	1	1 unit	42G
80	22	45	--	73	20	25	50	--	S3	2	3RW4046-□BB□4	1	1 unit	42G
106	30	55	--	98	30	30	75	--	S3	2	3RW4047-□BB□4	1	1 unit	42G
Rated operational voltage U_e 400 ... 600 V														
12.5	--	5.5	7.5	11	--	--	7.5	10	S0	5	3RW4024-□BB□5	1	1 unit	42G
25	--	11	15	23	--	--	15	20	S0	5	3RW4026-□BB□5	1	1 unit	42G
32	--	15	18.5	29	--	--	20	25	S0	5	3RW4027-□BB□5	1	1 unit	42G
38	--	18.5	22	34	--	--	25	30	S0	5	3RW4028-□BB□5	1	1 unit	42G
45	--	22	30	42	--	--	30	40	S2	5	3RW4036-□BB□5	1	1 unit	42G
63	--	30	37	58	--	--	40	50	S2	5	3RW4037-□BB□5	1	1 unit	42G
72	--	37	45	62	--	--	40	60	S2	5	3RW4038-□BB□5	1	1 unit	42G
80	--	45	55	73	--	--	50	60	S3	5	3RW4046-□BB□5	1	1 unit	42G
106	--	55	75	98	--	--	75	75	S3	5	3RW4047-□BB□5	1	1 unit	42G

Article No. supplement for connection types

- With screw terminals
- With spring-type terminals²⁾

Article No. supplement for rated control supply voltage U_s

- 24 V AC/DC
- 110 ... 230 V AC/DC

¹⁾ Soft starter U_e 200 to 480 V with screw terminals:
Standard delivery time SD = 1 day (d).

²⁾ Main connection from size S2: screw terminals.

Note:

For the boundary conditions for the motor outputs specified here, see page 6/7.

1
2

0
1

SIRIUS 3RW Soft Starters

Basic Performance

3RW40 Soft Starters

IE3/IE4 ready Inline circuit

For normal starting (CLASS 10)

3RW402.



3RW403.



3RW404.

3RW ambient temperature 40 °C				3RW ambient temperature 50 °C				Size	SD ¹⁾	Article No.	Price per PU	PU (UNIT, SET, M)	PS*	PG
Rated values of three-phase motors				Rated values of three-phase motors										
Operational current I_e	Rating at operational voltage U_e			Operational current I_e	Rating at operational voltage U_e			d						
	230 V	400 V	500 V		200 V	230 V	460 V		575 V					
A	kW	kW	kW	A	hp	hp	hp	hp						
Rated operational voltage U_e 200 ... 480 V, with thermistor motor protection, rated control supply voltage U_s 24 V AC/DC														
12.5	3	5.5	--	11	3	3	7.5	--	S0	5	3RW4024-□TB04	1	1 unit	42G
25	5.5	11	--	23	5	5	15	--	S0	5	3RW4026-□TB04	1	1 unit	42G
32	7.5	15	--	29	7.5	7.5	20	--	S0	5	3RW4027-□TB04	1	1 unit	42G
38	11	18.5	--	34	10	10	25	--	S0	5	3RW4028-□TB04	1	1 unit	42G
45	11	22	--	42	10	15	30	--	S2	5	3RW4036-□TB04	1	1 unit	42G
63	18.5	30	--	58	15	20	40	--	S2	5	3RW4037-□TB04	1	1 unit	42G
72	22	37	--	62	20	20	40	--	S2	5	3RW4038-□TB04	1	1 unit	42G
80	22	45	--	73	20	25	50	--	S3	5	3RW4046-□TB04	1	1 unit	42G
106	30	55	--	98	30	30	75	--	S3	5	3RW4047-□TB04	1	1 unit	42G
Rated operational voltage U_e 400 ... 600 V, with thermistor motor protection, rated control supply voltage U_s 24 V AC/DC														
12.5	--	5.5	7.5	11	--	--	7.5	10	S0	5	3RW4024-□TB05	1	1 unit	42G
25	--	11	15	23	--	--	15	20	S0	5	3RW4026-□TB05	1	1 unit	42G
32	--	15	18.5	29	--	--	20	25	S0	5	3RW4027-□TB05	1	1 unit	42G
38	--	18.5	22	34	--	--	25	30	S0	5	3RW4028-□TB05	1	1 unit	42G
45	--	22	30	42	--	--	30	40	S2	5	3RW4036-□TB05	1	1 unit	42G
63	--	30	37	58	--	--	40	50	S2	5	3RW4037-□TB05	1	1 unit	42G
72	--	37	45	62	--	--	40	60	S2	5	3RW4038-□TB05	1	1 unit	42G
80	--	45	55	73	--	--	50	60	S3	5	3RW4046-□TB05	1	1 unit	42G
106	--	55	75	98	--	--	75	75	S3	5	3RW4047-□TB05	1	1 unit	42G

Article No. supplement for connection types

- With screw terminals
- With spring-type terminals²⁾

¹⁾ Soft starter U_e 200 to 480 V with screw terminals:
Standard delivery time SD = 1 day (d).

²⁾ Main connection from size S2: screw terminals.

Note:

For the boundary conditions for the motor outputs specified here, see page 6/7.

1
2

SIRIUS 3RW Soft Starters

Basic Performance

3RW40 Soft Starters

Inline circuit **IE3/IE4 ready**

For normal starting (CLASS 10)



3RW405.



3RW407.

3RW ambient temperature 40 °C				3RW ambient temperature 50 °C					Size	SD ¹⁾	Article No.	Price per PU	PU (UNIT, SET, M)	PS*	PG
Rated values of three-phase motors				Rated values of three-phase motors											
Operational current I_e	Rating at operational voltage U_e			Operational current I_e	Rating at operational voltage U_e				d						
	230 V	400 V	500 V		200 V	230 V	460 V	575 V							
A	kW	kW	kW	A	hp	hp	hp	hp							
Rated operational voltage U_e 200 ... 460 V															
134	37	75	--	117	30	40	75	--	S6	5	3RW4055-□BB□4	1	1 unit	42G	
162	45	90	--	145	40	50	100	--		5	3RW4056-□BB□4	1	1 unit	42G	
230	75	132	--	205	60	75	150	--	S12	5	3RW4073-□BB□4	1	1 unit	42G	
280	90	160	--	248	75	100	200	--		5	3RW4074-□BB□4	1	1 unit	42G	
356	110	200	--	315	100	125	250	--		5	3RW4075-□BB□4	1	1 unit	42G	
432	132	250	--	385	125	150	300	--		5	3RW4076-□BB□4	1	1 unit	42G	
Rated operational voltage U_e 400 ... 600 V															
134	--	75	90	117	--	--	75	100	S6	5	3RW4055-□BB□5	1	1 unit	42G	
162	--	90	110	145	--	--	100	150		5	3RW4056-□BB□5	1	1 unit	42G	
230	--	132	160	205	--	--	150	200	S12	5	3RW4073-□BB□5	1	1 unit	42G	
280	--	160	200	248	--	--	200	250		5	3RW4074-□BB□5	1	1 unit	42G	
356	--	200	250	315	--	--	250	300		5	3RW4075-□BB□5	1	1 unit	42G	
432	--	250	315	385	--	--	300	400		5	3RW4076-□BB□5	1	1 unit	42G	

Article No. supplement for connection types²⁾

- With spring-type terminals
- With screw terminals

Article No. supplement for rated control supply voltage U_s ³⁾

- 115 V AC
- 230 V AC

¹⁾ Soft starter U_e 200 to 460 V with screw terminals:
Standard delivery time SD = 1 day (d),
soft starter U_e 400 to 600 V with screw terminals:
Standard delivery time SD = 2 days (d).

²⁾ Main circuit connection: busbar connection.

³⁾ Control by way of the internal 24 V DC supply and direct control via PLC possible.





Note:

For the boundary conditions for the motor outputs specified here, see page 6/7.

2
6

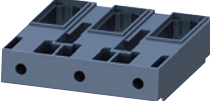
3
4

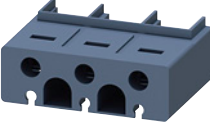
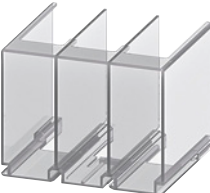
Selection and ordering data

Conductor cross-section		Tightening torque	For soft starters size	SD	Article No.	Price per PU	PU (UNIT, SET, M)	PS*	PG
Solid or stranded	Finely stranded with end sleeve								
mm ²	mm ²	AWG	Nm	d					
Three-phase infeed terminals									
	2.5 ... 25	2.5 ... 16	10 ... 4	3 ... 4	S0 (3RW402.)		1	1 unit	41E
3RW2925-5AB									
Box terminal blocks for soft starters									
For soft starters Type		Version Size		SD	Article No.	Price per PU	PU (UNIT, SET, M)	PS*	PG
				d					
	For round and ribbon cables (2 units required for each device)								
3RT1956-4G	3RW405.	S6	<ul style="list-style-type: none"> Up to 70 mm² Up to 120 mm² 	▶	3RT1955-4G		1	1 unit	41B
				▶	3RT1956-4G		1	1 unit	41B
			Auxiliary conductor connection for box terminals	5	3TX7500-0A		1	1 unit	41B
	3RW407.	S12	<ul style="list-style-type: none"> Up to 240 mm² (with auxiliary conductor connection) 	▶	3RT1966-4G		1	1 unit	41B
Auxiliary terminals									
	Auxiliary terminals, 3-pole								
3RT2946-4F	3RW404.	S3		5	3RT2946-4F		1	1 unit	41B
Covers for soft starters									
	Terminal covers for box terminals								
	Additional touch protection to be fitted at the box terminals (2 units required per device)								
3RT2936-4EA2	3RW403.	S2		▶	3RT2936-4EA2		1	1 unit	41B
	3RW404.	S3		▶	3RT2946-4EA2		1	1 unit	41B
	3RW405.	S6		▶	3RT1956-4EA2		1	1 unit	41B
	3RW407.	S12		▶	3RT1966-4EA2		1	1 unit	41B
	Terminal covers for cable lugs and busbar connections								
3RT1946-4EA1	3RW404.	S3	For complying with the voltage clearances and as touch protection if box terminal is removed	▶	3RT1946-4EA1		1	1 unit	41B
	3RW405.	S6		▶	3RT1956-4EA1		1	1 unit	41B
	3RW407.	S12	(2 units required per device)	▶	3RT1966-4EA1		1	1 unit	41B
	Also fits in case of S6 and S12 on mounted box terminals								
	Sealing covers								
3RW4900-0PB10	3RW402. to 3RW404.	S0, S2, S3		▶	3RW4900-0PB10		1	1 unit	42G
	3RW405. and 3RW407.	S6, S12		▶	3RW4900-0PB00		1	1 unit	42G

SIRIUS 3RW Soft Starters

Basic Performance 3RW40 Soft Starters

Accessories

For motor starter protectors	For soft starters	Version	SD	Article No.	Price per PU	PU (UNIT, SET, M)	PS*	PG
Size	Size		d					

Standard mounting rail adapters



3RA2932-1CA00

		For mechanical fixing of motor starter protector and soft starter; for snapping onto standard mounting rail or for screw fixing						
S2	S2	Single-unit packaging	▶	3RA2932-1CA00		1	1 unit	41B

For soft starters	SD	Article No.	Price per PU	PU (UNIT, SET, M)	PS*	PG
Type	Size					
	d					

Fans (to increase switching frequency and for device mounting in positions different to the standard position)

3RW4928-8VB00,
3RW4947-8VB00

3RW402.	S0	▶	3RW4928-8VB00	1	1 unit	42G
3RW403., 3RW404.	S2, S3	▶	3RW4947-8VB00	1	1 unit	42G

For soft starters	Motor starter protectors	SD	Article No.	Price per PU	PU (UNIT, SET, M)	PS*	PG
Type	Size	Size					
		d					

Link modules to motor starter protectors¹⁾

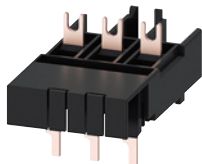

3RA2921-1BA00

• With screw terminals								
3RW402.	S0	S00/S0	2	3RA2921-1BA00		1	1 unit	41B
3RW4036.	S2	S2	▶	3RA2931-1AA00		1	1 unit	41B
3RW4046., 3RW4047.	S3	S3	▶	3RA1941-1AA00		1	1 unit	41B

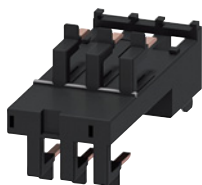

3RA2921-2GA00

• With spring-type terminals								
3RW402.	S0	S0	▶	3RA2921-2GA00		1	1 unit	41B

¹⁾ Can be used in size S0 up to maximum 32 A.
Can be used in size S2 up to maximum 65 A in combination with 3RA2932-1CA00 standard mounting rail adapter (specially for soft starters).
Can be used in size S3 only with mounting plate.

Version	SD	Article No.	Price per PU	PU (UNIT, SET, M)	PS*	PG
	d					

Tools for opening spring-type terminals in sizes S00 and S0



3RA2908-1A

Screwdrivers

For all SIRIUS devices with spring-type terminals
Length approx. 200 mm, 3.0 mm x 0.5 mm,
titanium gray/black, partially insulated

SD	Article No.	Price per PU	PU (UNIT, SET, M)	PS*	PG
2	3RA2908-1A		1	1 unit	41B

Blank labels

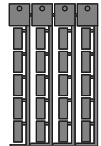

3RT2900-1SB20

Unit labeling plates¹⁾

For SIRIUS devices

- 20 mm x 7 mm, titanium gray

SD	Article No.	Price per PU	PU (UNIT, SET, M)	PS*	PG
20	3RT2900-1SB20		100	340 units	41B

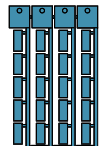

3RT1900-1SB20

- 20 mm x 7 mm, pastel turquoise

SD	Article No.	Price per PU	PU (UNIT, SET, M)	PS*	PG
20	3RT1900-1SB20		100	340 units	41B

¹⁾ PC labeling systems for individual inscription of unit labeling plates are available from: murrplastik Systemtechnik GmbH, see page 16/16.

SIRIUS 3RW Soft Starters

Basic Performance Soft Starters

3RW30 Soft Starters

General data

Overview

More information

Homepage, see www.siemens.com/soft-starter
 Industry Mall, see www.siemens.com/product?3RW

Online configurator, see www.siemens.com/sirius/configurators
 Simulation Tool for Soft Starters (STS), see page 6/7 or
<https://support.industry.siemens.com/cs/ww/en/view/101494917>



The SIRIUS 3RW30 Basic Performance soft starters are suitable for soft starting of three-phase asynchronous motors.

Due to two-phase control, the current is kept at minimum values in all three phases throughout the entire starting time and disturbing direct current components are eliminated in addition. This not only enables the two-phase starting of motors up to 55 kW (at 400 V) but also avoids the current and torque peaks which occur, for example, with wye-delta starters.

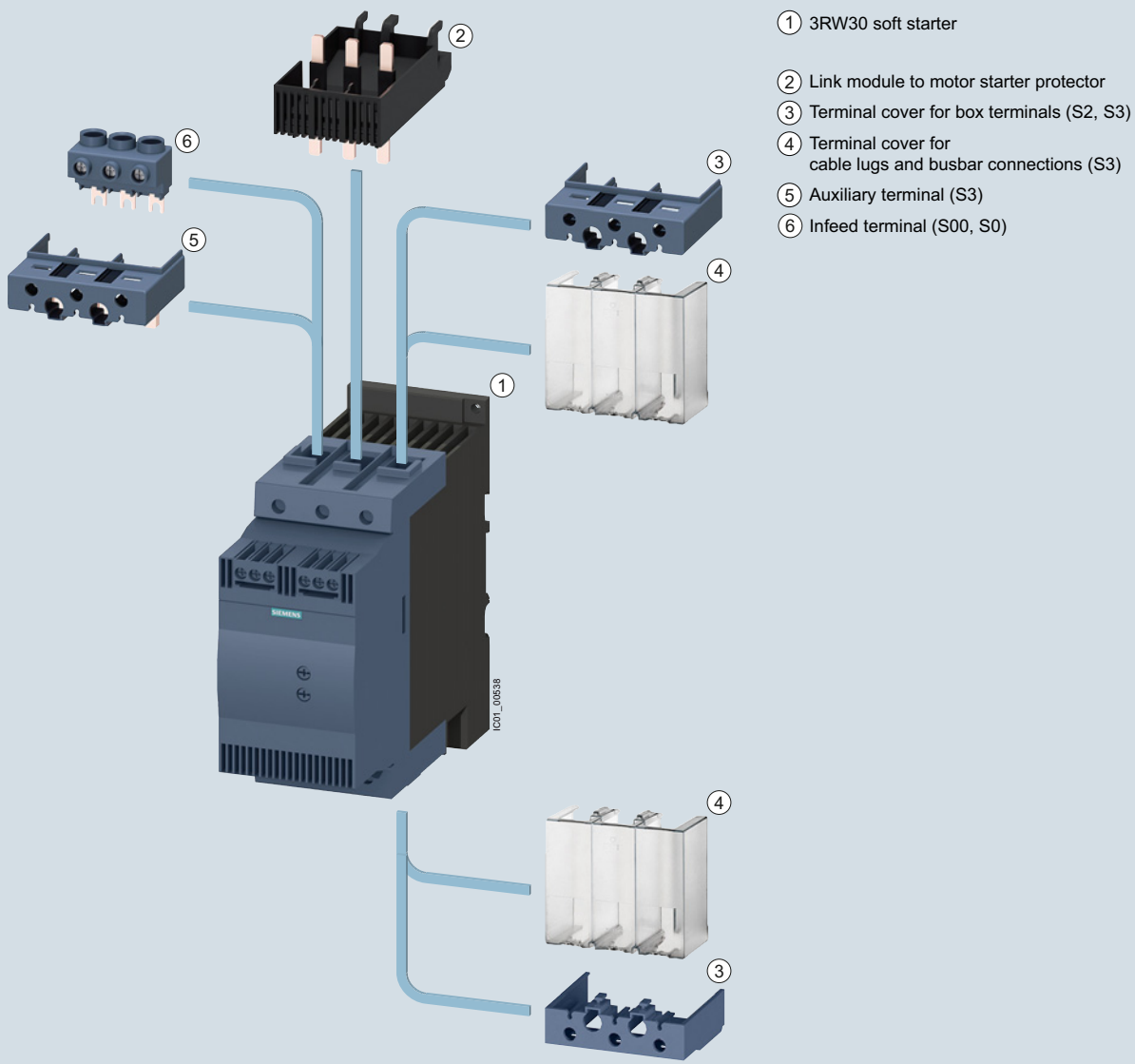

- ① 3RW30 soft starter
- ② Link module to motor starter protector
- ③ Terminal cover for box terminals (S2, S3)
- ④ Terminal cover for cable lugs and busbar connections (S3)
- ⑤ Auxiliary terminal (S3)
- ⑥ Infeed terminal (S00, S0)

3RW30 Basic Performance soft starters, accessories, see page 6/69.

Benefits



3RW301.



3RW302.



3RW303.



3RW304.



3RW3003-2CB54

Product characteristics / function	Performance features / benefits
Small and compact design	Space-saving, clearly arranged control panel layout
Parameterization using potentiometers	Simple and fast commissioning
Integrated bypass contact system	Reduction of power loss during operation
"Polarity balancing" control method	Avoidance of direct current components in two-phase controlled soft starters.

SIRIUS 3RW Soft Starters

Basic Performance Soft Starters

3RW30 Soft Starters

General data

Technical specifications

More information

Manual "SIRIUS 3RW30/3RW40 Soft Starters", see <https://support.industry.siemens.com/cs/ww/en/view/38752095>
 FAQs, see <https://support.industry.siemens.com/cs/ww/en/ps/16213/faq>

Catalog LV 10, see www.siemens.com/lowvoltage/lv10

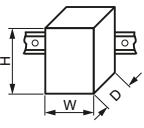
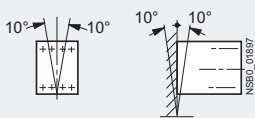
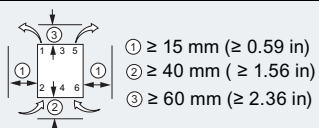
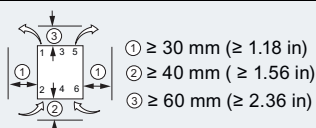
Type		3RW301.	3RW302.	3RW303.	3RW304.	
Mechanics and environment						
Mounting dimensions (W x H x D)						
<ul style="list-style-type: none"> • Screw terminals • Spring-type terminals 		mm	45 x 95 x 151	45 x 125 x 151	55 x 144 x 168	70 x 160 x 186
		mm	45 x 117 x 151	45 x 150 x 151	55 x 144 x 168	70 x 160 x 186
Permissible ambient temperature						
During operation	°C	-25 ... +60; (derating from +40)				
During storage	°C	-40 ... +80				
Weight	kg	0.58	0.69	1.20	1.71	
Permissible mounting position¹⁾ (auxiliary fan not available)						
						
Installation type¹⁾						
Stand-alone installation						
		① ≥ 15 mm (≥ 0.59 in) ② ≥ 40 mm (≥ 1.56 in) ③ ≥ 60 mm (≥ 2.36 in)		① ≥ 30 mm (≥ 1.18 in) ② ≥ 40 mm (≥ 1.56 in) ③ ≥ 60 mm (≥ 2.36 in)		
Permissible installation altitude						
		m 5 000 (Derating from 1 000, see characteristic curve on page 6/7)				
Degree of protection						
IP20 for 3RW301. and 3RW302.; IP00 for 3RW303. and 3RW304.						

¹⁾ In the case of deviations, please observe derating, see Manual in the chapter "Configuring".

Type	Terminal	3RW301., 3RW302.	3RW303., 3RW304.			
Control electronics						
Rated values						
Rated control supply voltage	A1/A2	V	24	110 ... 230	24	110 ... 230
• Tolerance		%	± 20	-15/+10	± 20	-15/+10
Rated frequency		Hz	50/60			
• Tolerance		%	± 10			

Type		3RW301.	3RW302.	3RW303.	3RW304.
Power electronics					
Rated operational voltage					
	V AC	200 ... 480			
Tolerance	%	-15/+10			
Rated frequency					
	Hz	50/60			
Tolerance	%	± 10			
Uninterrupted duty at 40 °C (% of I_e)					
		%			
		115			
Minimum load (% of I_e)					
		%			
		10 (at least 1 A)			
Maximum cable length between soft starter and motor					
		m			
		300			

SIRIUS 3RW Soft Starters

Basic Performance Soft Starters

3RW30 Soft Starters

General data

Type		3RW3013	3RW3014	3RW3016	3RW3017	3RW3018
Power electronics						
Load rating with rated operational current I_e						
• According to IEC and UL/CSA ¹⁾ , for individual mounting, AC-53a						
- At 40 °C	A	3.6	6.5	9	12.5	17.6
- At 50 °C	A	3.3	6	8	12	17
- At 60 °C	A	3	5.5	7	11	14
Power loss						
• in operation after completed starting with uninterrupted rated operational current (40 °C) approx.						
	W	0.25	0.5	1	2	4
• during starting with 300% I_M (40 °C)						
	W	24	52	80	80	116
Permissible rated motor current and starts per hour						
• For normal starting (CLASS 10) at 40 °C/50 °C						
- Rated motor current $I_M^{(2)}$, ramp-up time 3 s	A	3.6/3.3	6.5/6.0	9/8	12.5/12.0	17.6/17.0
- Starts per hour ³⁾	1/h	200/150	87/60	50/50	85/70	62/46
- Rated motor current $I_M^{(2)}$, ramp-up time 4 s	A	3.6/3.3	6.5/6.0	9/8	12.5/12.0	17.6/17.0
- Starts per hour ³⁾	1/h	150/100	64/46	35/35	62/47	45/32

1) Measurement at 60 °C according to UL/CSA not required.

2) At 300% I_M , $T_u = 40$ °C / 50 °C.

3) For intermittent duty S4 with ON period = 30%, $T_u = 40$ °C / 50 °C, stand-alone installation vertical. The quoted switching frequencies do not apply for automatic mode.

Type		3RW3026	3RW3027	3RW3028
Power electronics				
Load rating with rated operational current I_e				
• According to IEC and UL/CSA ¹⁾ , for individual mounting, AC-53a				
- At 40 °C	A	25.3	32.2	38
- At 50 °C	A	23	29	34
- At 60 °C	A	21	26	31
Power loss				
• in operation after completed starting with uninterrupted rated operational current (40 °C) approx.				
	W	8	13	19
• during starting with 300% I_M (40 °C)				
	W	188	220	256
Permissible rated motor current and starts per hour				
• For normal starting (CLASS 10) at 40 °C/50 °C				
- Rated motor current $I_M^{(2)}$, ramp-up time 3 s	A	25/23	32/29	38/34
- Starts per hour ³⁾	1/h	23/23	23/23	19/19
- Rated motor current $I_M^{(2)}$, ramp-up time 4 s	A	25/23	32/29	38/34
- Starts per hour ³⁾	1/h	15/15	16/16	12/12

1) Measurement at 60 °C according to UL/CSA not required.

2) At 300% I_M , $T_u = 40$ °C / 50 °C.

3) For intermittent duty S4 with ON period = 30%, $T_u = 40$ °C / 50 °C, stand-alone installation vertical. The quoted switching frequencies do not apply for automatic mode. Factors for permissible switching frequency with deviating mounting position, direct mounting, side-by-side mounting, see Manual in the chapter "Configuring".

Type		3RW3036	3RW3037	3RW3038	3RW3046	3RW3047
Power electronics						
Load rating with rated operational current I_e						
• According to IEC and UL/CSA ¹⁾ , for individual mounting, AC-53a						
- At 40 °C	A	45	65	72	80	106
- At 50 °C	A	42	58	62.1	73	98
- At 60 °C	A	39	53	60	66	90
Power loss						
• in operation after completed starting with uninterrupted rated operational current (40 °C) approx.						
	W	6	12	15	12	21
• during starting with 300% I_M (40 °C)						
	W	316	444	500	576	768
Permissible rated motor current and starts per hour						
• For normal starting (CLASS 10) at 40 °C/50 °C						
- Rated motor current $I_M^{(2)}$, ramp-up time 3 s	A	45/42	63/58	72/62	80/73	106/108
- Starts per hour ³⁾	1/h	38/38	23/23	22/22	22/22	15/15
- Rated motor current $I_M^{(2)}$, ramp-up time 4 s	A	45/42	63/58	72/62	80/73	106/98
- Starts per hour ³⁾	1/h	26/26	15/15	15/15	15/15	10/10

1) Measurement at 60 °C according to UL/CSA not required.

2) At 300% I_M , $T_u = 40$ °C / 50 °C.

3) For intermittent duty S4 with ON period = 30%, $T_u = 40$ °C / 50 °C, stand-alone installation vertical. The quoted switching frequencies do not apply for automatic mode.

SIRIUS 3RW Soft Starters

Basic Performance Soft Starters

3RW30 Soft Starters

General data

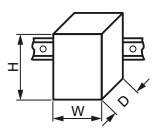
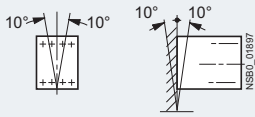
Type		3RW3003-1CB54	3RW3003-2CB54
Mechanics and environment			
Mounting dimensions (W x H x D)			
<ul style="list-style-type: none"> Screw terminals Spring-type terminals 		mm	22.5 x 100 x 120
		mm	--
			22.5 x 101.6 x 120
Permissible ambient temperature			
During operation	°C	-25 ... +60; (derating from +40)	
During storage	°C	-40 ... +80	
Weight	kg	0.207	0.188
Permissible mounting position			
			
Permissible installation altitude			
	m	5 000 (Derating from 1 000, see characteristic curve on page 6/7)	
Degree of protection acc. to IEC 60529			
		IP20 (IP00 terminal compartment)	
Control electronics			
Rated values			
Rated control supply voltage	V	24 ... 230 AC/DC	
• Tolerance	%	± 10	
Rated frequency at AC	Hz	50/60	
• Tolerance	%	± 10	
Power electronics			
Rated operational voltage			
	V AC	200 ... 400	
Tolerance	%	± 10	
Rated frequency			
	Hz	50/60	
Tolerance	%	± 10	
Uninterrupted duty (% of I_e)			
	%	100	
Minimum load¹⁾ (% of I_e); at 40 °C			
	%	9	
Maximum conductor length between soft starter and motor			
	m	100 ²⁾	
Load rating with rated operational current I_e			
• According to IEC and UL/CSA for individual mounting at 40/50/60 °C, AC-53a	A	3/2.6/2.2	
• According to IEC and UL/CSA for side-by-side-mounting at 40/50/60 °C, AC-53a	A	2.6/2.2/1.8	
Power loss			
• In operation after completed starting with uninterrupted rated operational current (40 °C) approx.	W	6.5	
• With utilization of maximum switching frequency	W	3	
Permissible starts per hour (cannot be increased by using a fan)			
• For intermittent duty S4 $T_{ij} = 40$ °C, stand-alone installation vertical	1/h	1 500	
• ON period = 70% for 300% I_e	1/s	0.2	
Dead time after uninterrupted duty			
With I_e before restart	s	0	

¹⁾ The rated motor current (specified on the motor's name plate) should at least amount to the specified percentage of the SIRIUS soft starter unit's rated operational current I_e .

²⁾ If this value is exceeded, problems with line capacities may arise, which can result in false firing.

Motor feeders with soft starters

The type of coordination according to which the motor feeder with soft starter is mounted depends on the application-specific requirements. Normally, fuseless mounting (combination of motor starter protector and soft starter) is sufficient.

If type of coordination "2" is to be fulfilled, then semiconductor fuses must be fitted in the motor feeder.

ToC
1

Type of coordination "1" according to IEC 60947-4-1: After a short-circuit incident, the unit is defective and therefore unsuitable for further use (protection of persons and system guaranteed).

ToC
2

Type of coordination "2" according to IEC 60947-4-1: After a short-circuit incident the unit is suitable for further use (protection of persons and system guaranteed).

The type of coordination refers to soft starters in combination with the stipulated protective device (motor starter protector/fuse), not to any additional components in the feeder.

The types of coordination are indicated in the corresponding tables by the symbols shown on orange backgrounds.

Fuseless version

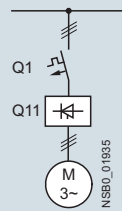

Soft starters

ToC
1

Motor starter protectors¹⁾

Soft starters		Motor starter protectors ¹⁾		
Q11	Rated current	Q1	I_q	Rated current
Type	A	Type	kA	A
Type of coordination "1"				
3RW3003	3	3RV2011-1EA	50	4
3RW3013	3.6	3RV2011-1FA	5	5
3RW3014	6.5	3RV2011-1HA	5	8
3RW3016	9	3RV2011-1JA	5	10
3RW3017	12.5	3RV2011-1KA	5	12.5
3RW3018	17.6	3RV2021-4BA	5	20
3RW3026	25	3RV2021-4DA	55	25
3RW3027	32	3RV2021-4EA	55	32
3RW3028	38	3RV2021-4FA	55	40
3RW3036	45	3RV2031-4WA10	10	45
3RW3037	63	3RV2031-4JA10	10	63
3RW3038	72	3RV2031-4KA10	10	75
3RW3046	80	3RV2042-4RA10	11	84
3RW3047	106	3RV2042-4MA10	11	100

¹⁾ The rated motor current must be considered when selecting the devices.

SIRIUS 3RW Soft Starters

Basic Performance Soft Starters

3RW30 Soft Starters

General data

Fused version (line protection only)

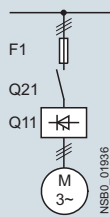

Soft starters		Line protection, maximum			Line contactor
Q11 Type	Rated current A	F1 Type	Rated current A	Size	(optional) Q21 Type
Type of coordination "1"¹⁾: $I_q = 65 \text{ kA at } 480 \text{ V} + 10\%$					
3RW3003 ²⁾	3	3NA3805 ³⁾	20	000	3RT2015
3RW3013	3.6	3NA3803-6	10	000	3RT2015
3RW3014	6.5	3NA3805-6	16	000	3RT2015
3RW3016	9	3NA3807-6	20	000	3RT2016
3RW3017	12.5	3NA3810-6	25	000	3RT2018
3RW3018	17.6	3NA3814-6	35	000	3RT2026
3RW3026	25	3NA3822-6	63	00	3RT2026
3RW3027	32	3NA3824-6	80	00	3RT2027
3RW3028	38	3NA3824-6	80	00	3RT2028
3RW3036	45	3NA3130-6	100	1	3RT2036
3RW3037	63	3NA3132-6	125	1	3RT2037
3RW3038	72	3NA3132-6	125	1	3RT2038
3RW3046	80	3NA3136-6	160	1	3RT2038
3RW3047	106	3NA3136-6	160	1	3RT2046

¹⁾ The type of coordination "1" refers to soft starters in combination with the stipulated protective device (motor starter protector/fuse), not to any additional components in the feeder.

²⁾ $I_q = 50 \text{ kA at } 400 \text{ V}$.

³⁾ 3NA3805-1 (NH00), 5SB261 (DIAZED), 5SE2201-6 (NEOZED).

Fused version with 3NE1 SITOR fuses (semiconductor and line protection)

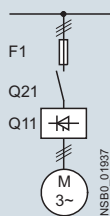

For matching fuse bases, see [Catalog LV 10](#):

- "Fuse systems" → "SITOR Semiconductor Fuses" or www.siemens.com/sitor
- "Switch disconnectors"

Soft starters		All-range fuses			Line contactor
Q11 Type	Rated current A	F1 Type	Rated current A	Size	(optional) Q21 Type
Type of coordination "2"¹⁾: $I_q = 65 \text{ kA at } 480 \text{ V} + 10\%$					
3RW3003 ²⁾	3	3NE1813-0 ³⁾	16	000	3RT2015
3RW3013	3.6	3NE1813-0	16	000	3RT2015
3RW3014	6.5	3NE1813-0	16	000	3RT2015
3RW3016	9	3NE1813-0	16	000	3RT2016
3RW3017	12.5	3NE1813-0	16	000	3RT2018
3RW3018	17.6	3NE1814-0	20	000	3RT2026
3RW3026	25	3NE1803-0	35	000	3RT2026
3RW3027	32	3NE1020-2	80	00	3RT2027
3RW3028	38	3NE1020-2	80	00	3RT2028
3RW3036	45	3NE1020-2	80	00	3RT2036
3RW3037	63	3NE1820-0	80	000	3RT2037
3RW3038	72	3NE1820-0	80	000	3RT2038
3RW3046	80	3NE1021-0	100	00	3RT2038
3RW3047	106	3NE1022-0	125	00	3RT2046

¹⁾ The type of coordination "2" refers to soft starters in combination with the stipulated protective device (motor starter protector/fuse), not to any additional components in the feeder.

²⁾ $I_q = 50 \text{ kA at } 400 \text{ V}$.

³⁾ No SITOR fuse required!
Alternatively: 3NA3803 (NH00), 5SB221 (DIAZED), 5SE2206 (NEOZED).

Fused version with 3NE3 SITOR fuses (semiconductor protection by fuse, line and overload protection by motor starter protector; alternatively, installation with contactor and overload relay possible)

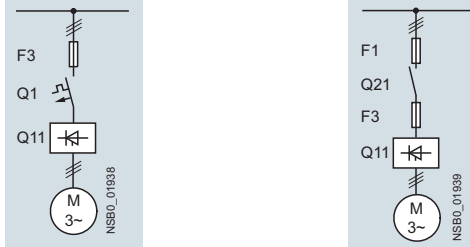

For matching fuse bases, see Catalog LV 10:

- "Fuse systems" → "SITOR Semiconductor Fuses" or www.siemens.com/sitor
- "Switch disconnectors"

Soft starters		Semiconductor fuses, minimum			Semiconductor fuses, minimum			Semiconductor fuses, minimum		
Q11 Type	Rated current A	F3 Type	Rated current A	Size	F3 Type	Rated current A	Size	F3 Type	Rated current A	Size
Type of coordination "2"¹⁾: $I_q = 65 \text{ kA at } 480 \text{ V} + 10\%$										
3RW3003 ²⁾	3	--	--	--	--	--	--	3NE8015-1	25	00
3RW3013	3.6	--	--	--	3NE4101	32	0	3NE8015-1	25	00
3RW3014	6.5	--	--	--	3NE4101	32	0	3NE8015-1	25	00
3RW3016	9	--	--	--	3NE4101	32	0	3NE8015-1	25	00
3RW3017	12.5	--	--	--	3NE4101	32	0	3NE8015-1	25	00
3RW3018	17.6	--	--	--	3NE4101	32	0	3NE8003-1	35	00
3RW3026	25	--	--	--	3NE4102	40	0	3NE8017-1	50	00
3RW3027	32	--	--	--	3NE4118	63	0	3NE8018-1	63	00
3RW3028	38	--	--	--	3NE4118	63	0	3NE8020-1	80	00
3RW3036	45	--	--	--	3NE4120	80	0	3NE8020-1	80	00
3RW3037	63	--	--	--	3NE4121	100	0	3NE8021-1	100	00
3RW3038	72	3NE3221	100	1	--	--	--	3NE8022-1	125	00
3RW3046	80	3NE3222	125	1	--	--	--	3NE8022-1	125	00
3RW3047	106	3NE3224	160	1	--	--	--	3NE8024-1	160	00

Soft starters		Cylindrical fuses		Line contactor	Motor starter protectors		Line protection, maximum			
Q11 Type	Rated current A	F3 Type	Rated current A	(optional) Q21	400 V + 10% Q1 Type	Rated current A	F1 Type	Rated current A	Size	
Type of coordination "2"¹⁾: $I_q = 65 \text{ kA at } 480 \text{ V} + 10\%$										
3RW3003 ²⁾	3	3NC1010	10	3RT2015	3RV2011-1EA	4	3NA3805 ³⁾	20	000	
3RW3013	3.6	3NC2220	20	3RT2015	3RV2011-1FA	5	3NA3803-6	10	000	
3RW3014	6.5	3NC2220	20	3RT2015	3RV2011-1HA	8	3NA3805-6	16	000	
3RW3016	9	3NC2220	20	3RT2016	3RV2011-1JA	10	3NA3807-6	20	000	
3RW3017	12.5	3NC2250	50	3RT2018	3RV2011-1KA	12.5	3NA3810-6	25	000	
3RW3018	17.6	3NC2263	63	3RT2026	3RV2021-4BA	20	3NA3814-6	35	000	
3RW3026	25	3NC2263	63	3RT2026	3RV2021-4DA	25	3NA3822-6	63	00	
3RW3027	32	3NC2280	80	3RT2027	3RV2021-4EA	32	3NA3824-6	80	00	
3RW3028	38	3NC2280	80	3RT2028	3RV2021-4FA	40	3NA3824-6	80	00	
3RW3036	45	3NC2280	80	3RT2036	3RV2031-4WA10	45	3NA3130-6	100	1	
3RW3037	63	--	--	3RT2037	3RV2031-4JA10	63	3NA3132-6	125	1	
3RW3038	72	--	--	3RT2038	3RV2031-4KA10	75	3NA3132-6	125	1	
3RW3046	80	--	--	3RT2038	3RV2042-4RA10	84	3NA3136-6	160	1	
3RW3047	106	--	--	3RT2046	3RV2042-4MA10	100	3NA3136-6	160	1	

¹⁾ The type of coordination "2" refers to soft starters in combination with the stipulated protective device (motor starter protector/fuse), not to any additional components in the feeder.

²⁾ $I_q = 50 \text{ kA at } 400 \text{ V}$.

³⁾ 3NA3805-1 (NH00), 5SB261 (DIAZED).



Accessories

More information

Manual "SIRIUS 3RW30/3RW40 Soft Starters", see
<https://support.industry.siemens.com/cs/ww/en/view/38752095>.

Conductor cross-section			Tightening torque	For soft starters size	SD	Article No.	Price per PU	PU (UNIT, SET, M)	PS*	PG
Solid or stranded	Finely stranded with end sleeve	AWG cables, solid or stranded								
mm ²	mm ²	AWG	Nm		d					

Three-phase infeed terminals



3RV2925-5AB

2.5 ... 25	2.5 ... 16	10 ... 4	3 ... 4	S00 (3RW301.) S0 (3RW302.)	▶	3RV2925-5AB		1	1 unit	41E
------------	------------	----------	---------	-------------------------------	---	--------------------	--	---	--------	-----

For soft starters Type	Size	SD	Article No.	Price per PU	PU (UNIT, SET, M)	PS*	PG
		d					

Auxiliary terminals



3RT2946-4F

Auxiliary terminals, 3-pole			SD	Article No.	Price per PU	PU (UNIT, SET, M)	PS*	PG
3RW304.	Size							

3RW304.	S3		5	3RT2946-4F		1	1 unit	41B
---------	-----------	--	---	-------------------	--	---	--------	-----

Covers for soft starters



3RT2936-4EA2

Terminal covers for box terminals			SD	Article No.	Price per PU	PU (UNIT, SET, M)	PS*	PG
3RW303.	Size							

Additional touch protection to be fitted at the box terminals (2 units required per device)								
3RW303.	S2		2	3RT2936-4EA2		1	1 unit	41B
3RW304.	S3		▶	3RT2946-4EA2		1	1 unit	41B



3RT1946-4EA1

Terminal covers for cable lugs and busbar connections			SD	Article No.	Price per PU	PU (UNIT, SET, M)	PS*	PG
3RW304.	Size							

For complying with the voltage clearances and as touch protection if box terminal is removed (2 units required per device)								
3RW304.	S3		5	3RT1946-4EA1		1	1 unit	41B

For motor starter protectors Size	For soft starters Size	Version	SD	Article No.	Price per PU	PU (UNIT, SET, M)	PS*	PG
			d					

Mounting rails for mounting contactors for the customer assembly of 3RA21 load feeders with busbar adapters for 60 mm systems



8US1998-7CB45

--	S0	For the discrete configuration of direct-on-line starters, an additional mounting rail is needed for the contactor in addition to the existing mounting rail on the busbar adapter for the motor starter protector.	2	8US1998-7CB45		1	10 units	14O
		For pushing onto the device adapter, including fixing screws						

Standard mounting rail adapters



3RA2932-1CA00

S2	S2	For mechanical fixing of motor starter protector and soft starter; for snapping onto standard mounting rail or for screw fixing	▶	3RA2932-1CA00		1	1 unit	41B
		Single-unit packaging						

SIRIUS 3RW Soft Starters

Basic Performance Soft Starters

3RW30 Soft Starters

Accessories

For soft starters	Motor starter protectors	SD	Article No.	Price per PU	PU (UNIT, SET, M)	PS*	PG
Type	Size	Size					
							d

Link modules to motor starter protectors¹⁾

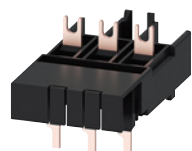

3RA2921-1BA00

- With screw terminals

3RW301.	S00	S00	2
3RW302.	S0	S00/S0	2
3RW3036.	S2	S2	▶
3RW3046.,	S3	S3	▶
3RW3047.			

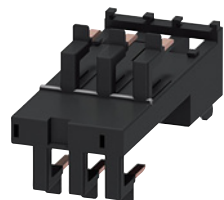

3RA2921-2GA00

- With spring-type terminals

3RW301.	S00	S00	▶
3RW302.	S0	S0	▶

Screw terminals



3RA2921-1BA00	1	1 unit	41B
3RA2921-1BA00	1	1 unit	41B
3RA2931-1AA00	1	1 unit	41B
3RA1941-1AA00	1	1 unit	41B

Spring-type terminals



3RA2911-2GA00	1	1 unit	41B
3RA2921-2GA00	1	1 unit	41B

- ¹⁾ Can be used in size S0 up to maximum 32 A.
 Can be used in size S2 up to maximum 65 A in combination with 3RA2932-1CA00 standard mounting rail adapter (specially for soft starters).
 Can be used in size S3 only on mounting plate.

Version	Functionality Functions	Use	SD	Article No.	Price per PU	PU (UNIT, SET, M)	PS*	PG
								d

Covers and push-in lugs (only for 3RW3003)



3RP1902

Sealable covers For securing against unauthorized adjustment of setting knobs For devices with 1 or 2 CO contacts

5 **3RP1902** 1 5 units 41H



3RP1903

Push-in lugs for screw fixing -- For devices with 1 or 2 CO contacts

5 **3RP1903** 1 10 units 41H

Version	SD	Article No.	Price per PU	PU (UNIT, SET, M)	PS*	PG
						d

Tools for opening spring-type terminals in sizes S00 and S0



3RA2908-1A

Screwdrivers For all SIRIUS devices with spring-type terminals Length approx. 200 mm, 3.0 mm x 0.5 mm, titanium gray/black, partially insulated

Spring-type terminals



2 **3RA2908-1A** 1 1 unit 41B

Blank labels

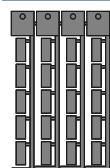

3RT2900-1SB20

Unit labeling plates¹⁾

For SIRIUS devices

- 20 mm x 7 mm, titanium gray

20 **3RT2900-1SB20** 100 340 units 41B

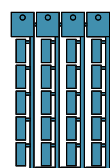

3RT1900-1SB20

- 20 mm x 7 mm, pastel turquoise

20 **3RT1900-1SB20** 100 340 units 41B

- ¹⁾ PC labeling systems for individual inscription of unit labeling plates are available from: murrplastik Systemtechnik GmbH, see page 16/16.



Overview

More information

Homepage, see www.siemens.com/soft-starter
Industry Mall, see www.siemens.com/product?3RW

Online configurator, see www.siemens.com/sirius/configurators
Simulation Tool for Soft Starters (STS), see page 6/7 or
<https://support.industry.siemens.com/cs/ww/en/view/101494917>







Selection and ordering data

Product designation	Manufacturer's Article No. of the soft starter	Type of product	SD	Article No.	Price per PU	PU (UNIT, SET, M)	PS*	PG
Power semiconductor modules								
	Power semiconductor module	3RW5524-.HA.4 (3x)	480 V, 47 A	1	3RW5952-0SF04		1	1 unit 42S
		3RW5525-.HA.4, 3RW5526-.HA.4 (3x)	480 V, 77 A	1	3RW5952-0SH04		1	1 unit 42S
		3RW5527-.HA.4 (3x)	480 V, 93 A	1	3RW5952-0SJ04		1	1 unit 42S
		3RW5534-.HA.4, 3RW5535-.HA.4 (3x)	480 V, 143 A	1	3RW5953-0SL04		1	1 unit 42S
		3RW5536-.HA.4 (3x)	480 V, 171 A	1	3RW5953-0SM04		1	1 unit 42S
		3RW5543-.HA.4 (3x)	480 V, 210 A	1	3RW5954-0SN04		1	1 unit 42S
		3RW5544-.HA.4 (3x)	480 V, 250 A	1	3RW5954-0SP04		1	1 unit 42S
		3RW5545-.HA.4, 3RW5546-.HA.4 (3x)	480 V, 370 A	1	3RW5954-0SR04		1	1 unit 42S
		3RW5547-.HA.4, 3RW5548-.HA.4 (3x)	480 V, 570 A	1	3RW5954-0ST04		1	1 unit 42S
		3RW5521-.HA.6, 3RW5524-.HA.6 (3x)	690 V, 47 A	1	3RW5952-0SF06		1	1 unit 42S
		3RW5525-.HA.6, 3RW5526-.HA.6 (3x)	690 V, 77 A	1	3RW5952-0SH06		1	1 unit 42S
		3RW5527-.HA.6 (3x)	690 V, 93 A	1	3RW5952-0SJ06		1	1 unit 42S
3RW5534-.HA.6, 3RW5535-.HA.6 (3x)	690 V, 143 A	1	3RW5953-0SL06		1	1 unit 42S		
3RW5536-.HA.6 (3x)	690 V, 171 A	1	3RW5953-0SM06		1	1 unit 42S		
3RW5543-.HA.6 (3x)	690 V, 210 A	1	3RW5954-0SN06		1	1 unit 42S		
3RW5544-.HA.6 (3x)	690 V, 250 A	1	3RW5954-0SP06		1	1 unit 42S		
3RW5545-.HA.6, 3RW5546-.HA.6 (3x)	690 V, 370 A	1	3RW5954-0SR06		1	1 unit 42S		
3RW5547-.HA.6, 3RW5548-.HA.6 (3x)	690 V, 570 A	1	3RW5954-0ST06		1	1 unit 42S		
Bypass units								
	Bypass unit	3RW552, 3RW553	--	1	3RW5953-0BY00		1	1 unit 42S
		3RW5543, 3RW5544, 3RW5545	210 A to 315 A	1	3RW5954-0BP00		1	1 unit 42S
		3RW5546, 3RW5547, 3RW5548	370 A to 570 A	1	3RW5954-0BT00		1	1 unit 42S
Control units								
	Control unit	3RW55...-HA0.	24 V	1	3RW5950-1UY00		1	1 unit 42S
		3RW55...-HA1.	110 - 250 V	1	3RW5950-1UY10		1	1 unit 42S

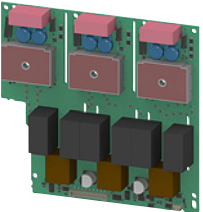
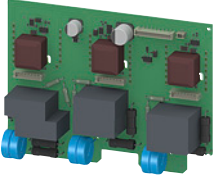
SIRIUS 3RW Soft Starters

Spare Parts

for 3RW55 **NEW**

Product designation	Manufacturer's Article No. of the soft starter	Type of product	SD	Article No.	Price per PU	PU (UNIT, SET, M)	PS*	PG		
Printed-circuit boards										
 3RW5951-0PA04  3RW5951-0PY06	Printed circuit board	3RW5513-.HA.4	480 V, 13 A	1	3RW5951-0PA04		1	1 unit	42S	
		3RW5514-.HA.4	480 V, 18 A	1	3RW5951-0PB04		1	1 unit	42S	
		3RW5515-.HA.4	480 V, 25 A	1	3RW5951-0PC04		1	1 unit	42S	
		3RW5516-.HA.4	480 V, 32 A	1	3RW5951-0PD04		1	1 unit	42S	
		3RW5517-.HA.4	480 V, 38 A	1	3RW5951-0PE04		1	1 unit	42S	
		3RW552-.HA.4, 3RW553-.HA.4	480 V	1	3RW5953-0PY04		1	1 unit	42S	
		3RW554-.HA.4	480 V	1	3RW5954-0PY04		1	1 unit	42S	
		3RW5513-.HA.5	600 V, 13 A	1	3RW5951-0PA05		1	1 unit	42S	
		3RW5514-.HA.5	600 V, 18 A	1	3RW5951-0PB05		1	1 unit	42S	
		3RW5515-.HA.5	600 V, 25 A	1	3RW5951-0PC05		1	1 unit	42S	
		3RW5516-.HA.5	600 V, 32 A	1	3RW5951-0PD05		1	1 unit	42S	
		3RW5517-.HA.5	600 V, 38 A	1	3RW5951-0PE05		1	1 unit	42S	
		3RW552-.HA.6, 3RW553-.HA.6	690 V	1	3RW5953-0PY06		1	1 unit	42S	
		3RW554-.HA.6	690 V	1	3RW5954-0PY06		1	1 unit	42S	
	Fans									
	 3RW5983-0FF00	Fans	3RW551 (1x), 3RW552, 3RW553 (2x)	--	1	3RW5983-0FF00		1	1 unit	42S
			3RW554	--	1	3RW5984-0FF00		1	1 unit	42S
	Terminals									
 3RW5982-0TB00  3RW5980-1TR00	Box terminal block	3RW552 (2x)	--	1	3RW5982-0TB00		1	1 unit	42S	
	Removable control terminals	3RW551.-1HA..., 3RW552.-1HA..., 3RW553.-6HA..., 3RW554.-6HA.. (2x)	With screw terminals, contains 2 blocks each with 6 terminals	1	3RW5980-1TR00		1	1 unit	42S	
		3RW551.-3HA..., 3RW552.-3HA..., 3RW553.-2HA..., 3RW554.-2HA.. (2x)	With spring-type terminals, contains 2 blocks each with 6 terminals	1	3RW5980-2TR00		1	1 unit	42S	
Enclosure components										
 3RW5953-0GB00  3RW5950-0GD20	Enclosure base	3RW552, 3RW553 3RW554	--	1	3RW5953-0GB00		1	1 unit	42S	
				1	3RW5954-0GB00		1	1 unit	42S	
	Cover for control cable duct	3RW55	Titanium gray	1	3RW5950-0GD20		1	1 unit	42S	

SIRIUS 3RW Soft Starters

Spare Parts

NEW for 3RW55



Product designation	Manufacturer's Article No. of the soft starter	Type of product	SD	Article No.	Price per PU	PU (UNIT, SET, M)	PS*	PG
 3RW5954-0GF00	3RW554	--	1	3RW5954-0GF00		1	1 unit	42S
 3RW5950-0GL30	3RW55	With cutout for HMI module High Feature	1	3RW5950-0GL30		1	1 unit	42S
HMI modules								
 3RW5980-0HF00	3RW55	High Feature	1	3RW5980-0HF00		1	1 unit	42S
 3RW5980-0HL00	3RW55	--	1	3RW5980-0HL00		1	1 unit	42S
Connection cables								
 3UF7931-0AA00-0	--	Length 0.1 m, flat	▶	3UF7931-0AA00-0		1	1 unit	42J
Transport packaging								
 3RW5953-0VY00	3RW551	--	1	3RW5951-0VY00		1	1 unit	42S
	3RW552, 3RW553	--	1	3RW5953-0VY00		1	1 unit	42S
	3RW554	--	1	3RW5954-0VY00		1	1 unit	42S

SIRIUS 3RW Soft Starters

Spare Parts

for 3RW44

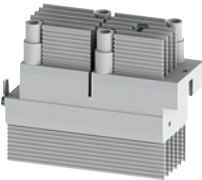
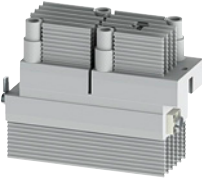

Selection and ordering data

	For soft starters	Version	SD	Article No.	Price per PU	PU (UNIT, SET, M)	PS*	PG
	Type		d					
Power semiconductor modules								
	3RW4443	690 V, 203 A (2 units required per device)	1	3RW4743-0LC00		1	1 unit	42H
	3RW4444, 3RW4445	690 V, 313 A (2 units required per device)	1	3RW4745-0LC00		1	1 unit	42H
	3RW4446	690 V, 356 A (2 units required per device)	1	3RW4746-0LC00		1	1 unit	42H
	3RW4447	690 V, 432 A (2 units required per device)	1	3RW4747-0LC00		1	1 unit	42H
	3RW4453, 3RW4454, 3RW4455	690 V, 693 A (2 units required per device)	3	3RW4755-0LC00		1	1 unit	42H
	3RW4456, 3RW4457, 3RW4458	690 V, 970 A (2 units required per device)	3	3RW4758-0LC00		1	1 unit	42H
	3RW4465, 3RW4466	690 V, 1214 A (2 units required per device)	3	3RW4766-0LC00		1	1 unit	42H
NTC power semiconductor modules								
	3RW4443	690 V, 203 A	1	3RW4743-0NC00		1	1 unit	42H
	3RW4444, 3RW4445	690 V, 313 A	1	3RW4745-0NC00		1	1 unit	42H
	3RW4446	690 V, 356 A	1	3RW4746-0NC00		1	1 unit	42H
	3RW4447	690 V, 432 A	1	3RW4747-0NC00		1	1 unit	42H
	3RW4453, 3RW4454, 3RW4455	690 V, 693 A	3	3RW4755-0NC00		1	1 unit	42H
	3RW4456, 3RW4457, 3RW4458	690 V, 970 A	3	3RW4758-0NC00		1	1 unit	42H
	3RW4465, 3RW4466	690 V, 1214 A	3	3RW4766-0NC00		1	1 unit	42H
Bypass units								
	3RW4453, 3RW4454, 3RW4455	--	2	3RW4755-0KC00		1	1 unit	42H
	3RW4456, 3RW4457	--	2	3RW4766-0KC00		1	1 unit	42H
	3RW4458, 3RW4465, 3RW4466	--	2	3RW4766-0KC01		1	1 unit	42H
Control units with screw terminals								
	3RW4422-.BC4.	230 V	1	3RW4722-1SC44		1	1 unit	42H
	3RW4423-.BC4.	230 V	1	3RW4723-1SC44		1	1 unit	42H
	3RW4424-.BC4.	230 V	1	3RW4724-1SC44		1	1 unit	42H
	3RW4425-.BC4.	230 V	1	3RW4725-1SC44		1	1 unit	42H
	3RW4426-.BC4.	230 V	1	3RW4726-1SC44		1	1 unit	42H
	3RW4427-.BC4.	230 V	1	3RW4727-1SC44		1	1 unit	42H
	3RW4434-.BC4.	230 V	1	3RW4734-6SC44		1	1 unit	42H
	3RW4435-.BC4.	230 V	1	3RW4735-6SC44		1	1 unit	42H
	3RW4436-.BC4.	230 V	1	3RW4736-6SC44		1	1 unit	42H
	3RW4443-.BC4.	230 V	1	3RW4743-6SC44		1	1 unit	42H
	3RW4444-.BC4.	230 V	1	3RW4744-6SC44		1	1 unit	42H
	3RW4445-.BC4.	230 V	1	3RW4745-6SC44		1	1 unit	42H
	3RW4446-.BC4.	230 V	1	3RW4746-6SC44		1	1 unit	42H
	3RW4447-.BC4.	230 V	1	3RW4747-6SC44		1	1 unit	42H
	3RW4453-.BC4.	230 V	1	3RW4753-6SC44		1	1 unit	42H
	3RW4454-.BC4.	230 V	1	3RW4754-6SC44		1	1 unit	42H
	3RW4455-.BC4.	230 V	1	3RW4755-6SC44		1	1 unit	42H
	3RW4456-.BC4.	230 V	1	3RW4756-6SC44		1	1 unit	42H
	3RW4457-.BC4.	230 V	1	3RW4757-6SC44		1	1 unit	42H
	3RW4458-.BC4.	230 V	1	3RW4758-6SC44		1	1 unit	42H
3RW4465-.BC4.	230 V	1	3RW4765-6SC44		1	1 unit	42H	
3RW4466-.BC4.	230 V	1	3RW4766-6SC44		1	1 unit	42H	

SIRIUS 3RW Soft Starters

Spare Parts

for 3RW44

	For soft starters	Version	SD	Article No.	Price per PU	PU (UNIT, SET, M)	PS*	PG	
	Type		d						
TSE printed circuit boards									
 3RW4756-0WC70	3RW4453.-.BC.4, 3RW4454.-.BC.4, 3RW4455.-.BC.4, 3RW4456.-.BC.4	460 V	2	3RW4756-0WC70		1	1 unit	42H	
	3RW4457.-.BC.4, 3RW4458.-.BC.4, 3RW4465.-.BC.4, 3RW4466.-.BC.4	460 V	2	3RW4766-0WC70		1	1 unit	42H	
	3RW4453.-.BC.5, 3RW4453.-.BC.6, 3RW4454.-.BC.5, 3RW4454.-.BC.6, 3RW4455.-.BC.5, 3RW4455.-.BC.6, 3RW4456.-.BC.5, 3RW4456.-.BC.6	690 V	2	3RW4756-0WC50		1	1 unit	42H	
	3RW4457.-.BC.5, 3RW4457.-.BC.6, 3RW4458.-.BC.5, 3RW4458.-.BC.6, 3RW4465.-.BC.5, 3RW4465.-.BC.6, 3RW4466.-.BC.5, 3RW4466.-.BC.6	690 V	2	3RW4766-0WC50		1	1 unit	42H	
	Firing printed circuit boards								
	 3RW4727-0VC70	3RW442.-.BC.4	460 V	2	3RW4727-0VC70		1	1 unit	42H
		3RW443.-.BC.4, 3RW4443.-.BC.4	460 V	2	3RW4743-0VC70		1	1 unit	42H
		3RW4444.-.BC.4, 3RW4445.-.BC.4	460 V	2	3RW4745-0VC70		1	1 unit	42H
		3RW4446.-.BC.4, 3RW4447.-.BC.4	460 V	2	3RW4747-0VC70		1	1 unit	42H
		3RW445.-.BC.4, 3RW446.-.BC.4	460 V	2	3RW4766-0VC70		1	1 unit	42H
		3RW442.-.BC.5	600 V	2	3RW4727-0VC80		1	1 unit	42H
		3RW443.-.BC.5, 3RW4443.-.BC.5	600 V	2	3RW4743-0VC80		1	1 unit	42H
3RW442.-.BC.6		690 V	2	3RW4727-0VC50		1	1 unit	42H	
3RW443.-.BC.6, 3RW4444.-.BC.5, 3RW4445.-.BC.5		690 V	2	3RW4745-0VC50		1	1 unit	42H	
3RW4443.-.BC.6, 3RW4446.-.BC.5, 3RW4447.-.BC.5, 3RW4447.-.BC.6		690 V	2	3RW4746-0VC50		1	1 unit	42H	
3RW4444.-.BC.6, 3RW4445.-.BC.6, 3RW4446.-.BC.6		690 V	2	3RW4747-0VC50		1	1 unit	42H	
3RW445.-.BC.5, 3RW445.-.BC.6, 3RW446.-.BC.5, 3RW446.-.BC.6		690 V	2	3RW4766-0VC50		1	1 unit	42H	
Fans									
 3RW4957-8VX.0, 3RW4966-8VX.0		3RW442.-.BC3. ¹⁾ , 3RW443.-.BC3.	115 V	▶	3RW4936-8VX30		1	1 unit	42G
		3RW442.-.BC4. ¹⁾ , 3RW443.-.BC4.	230 V	▶	3RW4936-8VX40		1	1 unit	42G
		3RW444.-.BC3.	115 V	▶	3RW4947-8VX30		1	1 unit	42G
		3RW444.-.BC4.	230 V	▶	3RW4947-8VX40		1	1 unit	42G
		3RW445.-.BC3., 3RW446.-.BC3. ²⁾	115 V	▶	3RW4957-8VX30		1	1 unit	42H
	3RW445.-.BC4., 3RW446.-.BC4. ²⁾	230 V	▶	3RW4957-8VX40		1	1 unit	42H	
	3RW446.-.BC3. ³⁾	115 V	▶	3RW4966-8VX30		1	1 unit	42H	
	3RW446.-.BC4. ³⁾	230 V	▶	3RW4966-8VX40		1	1 unit	42H	

¹⁾ The 3RW4422 and 3RW4423 soft starters do not need fans.
These devices are adequately designed for natural convection.







²⁾ 3RW446. mounting on output side.

³⁾ For mounting on front side.

SIRIUS 3RW Soft Starters





Spare Parts

for 3RW44

For soft starters	Version	SD	Article No.	Price per PU	PU (UNIT, SET, M)	PS*	PG
Type							
Removable control terminals							
 3RW4766-6HC00	With screw terminals		Screw terminals  3RW4766-6HC00		1	1 unit	42H
	3RW44	4 blocks each with 6 terminals					
 3RW4766-2HC00	With spring-type terminals		Spring-type terminals  3RW4766-2HC00		1	1 unit	42H
	3RW44	4 blocks each with 6 terminals					
Box terminal block							
 3RW4727-0RC00	3RW442.	--	5	3RW4727-0RC00	1	10 units	42H
Enclosure base							
 3RW4747-0UC00	3RW444.	--	3	3RW4747-0UC00	1	1 unit	42H

NEW for 3RW52





Selection and ordering data

Product designation	Manufacturer's Article No. of the soft starter	Type of product	SD	Article No.	Price per PU	PU (UNIT, SET, M)	PS*	PG
Power semiconductor modules								
	Power semiconductor module	3RW5224-..C.4 (3x)	480 V, 47 A	1	3RW5952-0SF04		1	1 unit 42S
		3RW5225-..C.4, 3RW5226-..C.4 (3x)	480 V, 77 A	1	3RW5952-0SH04		1	1 unit 42S
		3RW5227-..C.4 (3x)	480 V, 93 A	1	3RW5952-0SJ04		1	1 unit 42S
		3RW5234-..C.4, 3RW5235-..C.4 (3x)	480 V, 143 A	1	3RW5953-0SL04		1	1 unit 42S
		3RW5236-..C.4 (3x)	480 V, 171 A	1	3RW5953-0SM04		1	1 unit 42S
		3RW5224-..C.5 (3x)	600 V, 47 A	1	3RW5952-0SF05		1	1 unit 42S
		3RW5225-..C.5, 3RW5226-..C.5 (3x)	600 V, 77 A	1	3RW5952-0SH05		1	1 unit 42S
		3RW5227-..C.5 (3x)	600 V, 93 A	1	3RW5952-0SJ05		1	1 unit 42S
		3RW5234-..C.5, 3RW5235-..C.5 (3x)	600 V, 143 A	1	3RW5953-0SL05		1	1 unit 42S
		3RW5236-..C.5 (3x)	600 V, 171 A	1	3RW5953-0SM05		1	1 unit 42S
		3RW5243 (3x)	600 V, 210 A	1	3RW5924-0SN05		1	1 unit 42S
		3RW5244, 3RW5245 (3x)	600 V, 315 A	1	3RW5924-0SQ05		1	1 unit 42S
		3RW5246, 3RW5247 (3x)	600 V, 470 A	1	3RW5924-0SS05		1	1 unit 42S
		3RW5248 (3x)	600 V, 570 A	1	3RW5924-0ST05		1	1 unit 42S
								
Bypass units								
	Bypass unit	3RW522, 3RW523	--	1	3RW5953-0BY00		1	1 unit 42S
		3RW5243, 3RW5244, 3RW5245	210 A to 315 A	1	3RW5954-0BP00		1	1 unit 42S
		3RW5246, 3RW5247, 3RW5248	370 A to 570 A	1	3RW5954-0BT00		1	1 unit 42S
Control units								
	Control unit	3RW52...-AC0.	24 V analog output	1	3RW5920-1UA00		1	1 unit 42S
		3RW52...-AC1.	110 - 250 V analog output	1	3RW5920-1UA10		1	1 unit 42S
		3RW52...-TC0.	24 V thermistor input	1	3RW5920-1UT00		1	1 unit 42S
		3RW52...-TC1.	110 - 250 V thermistor input	1	3RW5920-1UT10		1	1 unit 42S

SIRIUS 3RW Soft Starters

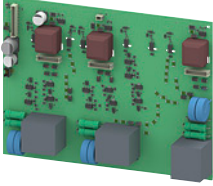
Spare Parts



for 3RW52 **NEW**

	Product designation	Manufacturer's Article No. of the soft starter	Type of product	SD	Article No.	Price per PU	PU (UNIT, SET, M)	PS*	PG	
Printed-circuit boards										
 3RW5923-0PY04	Printed circuit board	3RW5213-..C.4	480 V, 13 A	1	3RW5921-0PA04		1	1 unit	42S	
		3RW5214-..C.4	480 V, 18 A	1	3RW5921-0PB04		1	1 unit	42S	
		3RW5215-..C.4	480 V, 25 A	1	3RW5921-0PC04		1	1 unit	42S	
		3RW5216-..C.4	480 V, 32 A	1	3RW5921-0PD04		1	1 unit	42S	
		3RW5217-..C.4	480 V, 38 A	1	3RW5921-0PE04		1	1 unit	42S	
		3RW522-..C.4, 3RW523-..C.4	480 V	1	3RW5923-0PY04		1	1 unit	42S	
	3RW524-..C.4	480 V	1	3RW5924-0PY04		1	1 unit	42S		
	 3RW5924-0PY05		3RW5213-..C.5	600 V, 13 A	1	3RW5921-0PA05		1	1 unit	42S
			3RW5214-..C.5	600 V, 18 A	1	3RW5921-0PB05		1	1 unit	42S
			3RW5215-..C.5	600 V, 25 A	1	3RW5921-0PC05		1	1 unit	42S
3RW5216-..C.5			600 V, 32 A	1	3RW5921-0PD05		1	1 unit	42S	
3RW5217-..C.5			600 V, 38 A	1	3RW5921-0PE05		1	1 unit	42S	
3RW522-..C.5, 3RW523-..C.5			600 V	1	3RW5923-0PY05		1	1 unit	42S	
3RW524-..C.5	600 V	1	3RW5924-0PY05		1	1 unit	42S			
Fans										
 3RW5983-0FF00	Fans	3RW5216/17 (1x), 3RW526/27, 3RW553 (2x)	--	1	3RW5983-0FF00		1	1 unit	42S	
		3RW524	--	1	3RW5984-0FF00		1	1 unit	42S	
Terminals										
 3RW5982-0TB00	Box terminal block	3RW522 (2x)	--	1	3RW5982-0TB00		1	1 unit	42S	
		 3RW5980-1TR00	Removable control terminals	3RW521-..1.C.., 3RW522-..1.C.., 3RW523-..6.C.., 3RW524-..6.C..	With screw terminals, contains 2 blocks each with 6 terminals	1	3RW5980-1TR00		1	1 unit
3RW521-..3.C.., 3RW522-..3.C.., 3RW523-..2.C.., 3RW524-..2.C..	With spring-type terminals, contains 2 blocks each with 6 terminals			1	3RW5980-2TR00		1	1 unit	42S	
Enclosure components										
 3RW5953-0GB00	Enclosure base	3RW552, 3RW553	--	1	3RW5953-0GB00		1	1 unit	42S	
		3RW554	--	1	3RW5954-0GB00		1	1 unit	42S	
 3RW5950-0GD20	Cover for control cable duct	3RW52	Titanium gray	1	3RW5950-0GD20		1	1 unit	42S	

SIRIUS 3RW Soft Starters

Spare Parts

NEW for 3RW52

	Product designation	Manufacturer's Article No. of the soft starter	Type of product	SD	Article No.	Price per PU	PU (UNIT, SET, M)	PS*	PG
Enclosure components									
	Front cover	3RW524	--	1	3RW5954-0GF00		1	1 unit	42S
3RW5954-0GF00									
	Hinged cover	3RW52	Without cutout	1	3RW5950-0GL20		1	1 unit	42S
3RW5950-0GL20									
Transport packaging									
	Transport packaging	3RW521	--	1	3RW5951-0VY00		1	1 unit	42S
		3RW522, 3RW523	--	1	3RW5953-0VY00		1	1 unit	42S
		3RW524	--	1	3RW5954-0VY00		1	1 unit	42S
3RW5953-0VY00									





6

SIRIUS 3RW Soft Starters

Spare Parts

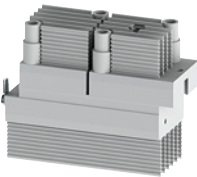
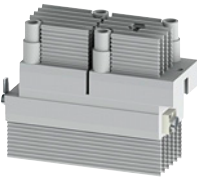
for 3RW40

Selection and ordering data

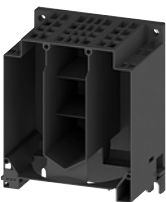
	For soft starters	Size	Version	SD	Article No.	Price per PU	PU (UNIT, SET, M)	PS*	PG
Type					d				
Power semiconductor modules									
	3RW4073	S12	600 V, 230 A	1	3RW4773-0LB00		1	1 unit	42G
	3RW4074	S12	600 V, 280 A	1	3RW4774-0LB00		1	1 unit	42G
	3RW4075	S12	600 V, 356 A	1	3RW4775-0LB00		1	1 unit	42G
	3RW4076	S12	600 V, 432 A	1	3RW4776-0LB00		1	1 unit	42G
3RW4773-0LB00									
NTC power semiconductor modules									
	3RW4073	S12	600 V, 230 A	1	3RW4773-0NB00		1	1 unit	42G
	3RW4074	S12	600 V, 280 A	1	3RW4774-0NB00		1	1 unit	42G
	3RW4075	S12	600 V, 356 A	1	3RW4775-0NB00		1	1 unit	42G
	3RW4076	S12	600 V, 432 A	1	3RW4776-0NB00		1	1 unit	42G
3RW4773-0NB00									
Control units with screw terminals									
	3RW4055-.BB3.	S6	115 V	1	3RW4755-6SB30		1	1 unit	42G
	3RW4055-.BB4.	S6	230 V	1	3RW4755-6SB40		1	1 unit	42G
	3RW4056-.BB3.	S6	115 V	1	3RW4756-6SB30		1	1 unit	42G
	3RW4056-.BB4.	S6	230 V	1	3RW4756-6SB40		1	1 unit	42G
	3RW4073-.BB3.	S12	115 V	1	3RW4773-6SB30		1	1 unit	42G
	3RW4073-.BB4.	S12	230 V	1	3RW4773-6SB40		1	1 unit	42G
	3RW4074-.BB3.	S12	115 V	1	3RW4774-6SB30		1	1 unit	42G
	3RW4074-.BB4.	S12	230 V	1	3RW4774-6SB40		1	1 unit	42G
	3RW4075-.BB3.	S12	115 V	1	3RW4775-6SB30		1	1 unit	42G
	3RW4075-.BB4.	S12	230 V	1	3RW4775-6SB40		1	1 unit	42G
3RW4755-6SB40									
Firing printed circuit boards									
	3RW405-.BB.4	S6	460 V	2	3RW4756-0VB70		1	1 unit	42G
	3RW405-.BB.5	S6	600 V	2	3RW4756-0VB80		1	1 unit	42G
	3RW407-.BB.4	S12	460 V	2	3RW4776-0VB70		1	1 unit	42G
	3RW407-.BB.5	S12	600 V	2	3RW4776-0VB80		1	1 unit	42G
3RW4756-0VB70									
Fans									
	3RW405-.BB3.	S6	115 V	▶	3RW4936-8VX30		1	1 unit	42G
	3RW405-.BB4.	S6	230 V	▶	3RW4936-8VX40		1	1 unit	42G
	3RW407-.BB3.	S12	115 V	▶	3RW4947-8VX30		1	1 unit	42G
	3RW407-.BB4.	S12	230 V	▶	3RW4947-8VX40		1	1 unit	42G
3RW4936-8VX.0, 3RW4947-8VX.0									
Removable control terminals									
	With spring-type terminals								
	3RW40	S6/S12	2 blocks each with 6 terminals	1	3RW4776-2HB00		1	1 unit	42G
With screw terminals									
3RW40	S6/S12	2 blocks each with 6 terminals	1	3RW4776-6HB00		1	1 unit	42G	
3RW4776-6HB00									
Enclosure base									
	3RW407.	S12	--	3	3RW4776-0UB00		1	1 unit	42G
3RW4776-0UB00									

1. General Provisions

By using this catalog you can acquire hardware and software products described therein from Siemens AG subject to the following Terms and Conditions of Sale and Delivery (hereinafter referred to as "T&C"). Please note that the scope, the quality and the conditions for supplies and services, including software products, by any Siemens entity having a registered office outside Germany, shall be subject exclusively to the General Terms and Conditions of the respective Siemens entity. The following T&C apply exclusively for orders placed with Siemens Aktiengesellschaft, Germany.

1.1 For customers with a seat or registered office in Germany

For customers with a seat or registered office in Germany, the following applies subordinate to the T&C:

- the "General Terms of Payment"¹⁾ and,
- for software products, the "General License Conditions for Software Products for Automation and Drives for Customers with a Seat or Registered Office in Germany"¹⁾ and,
- for other supplies and services, the "General Conditions for the Supply of Products and Services of the Electrical and Electronics Industry"¹⁾.

1.2 For customers with a seat or registered office outside Germany

For customers with a seat or registered office outside Germany, the following applies subordinate to the T&C:

- the "General Terms of Payment"¹⁾ and,
- for software products, the "General License Conditions for Software Products for Automation and Drives for Customers with a Seat or Registered Office outside of Germany"¹⁾ and
- for other supplies and/or services, the "General Conditions for Supplies of Siemens Industry for Customers with a Seat or Registered Office outside of Germany"¹⁾.

2. Prices

The prices are in € (Euro) ex point of delivery, exclusive of packaging.

The sales tax (value added tax) is not included in the prices. It shall be charged separately at the respective rate according to the applicable statutory legal regulations.

Prices are subject to change without prior notice. We will charge the prices valid at the time of delivery.

To compensate for variations in the price of raw materials (e.g. silver, copper, aluminum, lead, gold, dysprosium and neodym), surcharges are calculated on a daily basis using the so-called metal factor for products containing these raw materials. A surcharge for the respective raw material is calculated as a supplement to the price of a product if the basic official price of the raw material in question is exceeded.

The metal factor of a product indicates the basic official price (for those raw materials concerned) as of which the surcharges on the price of the product are applied, and with what method of calculation.

An exact explanation of the metal factor can be downloaded at:

www.siemens.com/automation/salesmaterial-as/catalog/en/terms_of_trade_en.pdf

To calculate the surcharge (except in the cases of dysprosium and neodym), the official price from the day prior to that on which the order was received or the release order was effected is used.

To calculate the surcharge applicable to dysprosium and neodym ("rare earths"), the corresponding three-month basic average price in the quarter prior to that in which the order was received or the release order was effected is used with a one-month buffer (details on the calculation can be found in the explanation of the metal factor).

3. Additional Terms and Conditions

The dimensions are in mm. In Germany, according to the German law on units in measuring technology, data in inches apply only to devices for export.

Illustrations are not binding.

Insofar as there are no remarks on the individual pages of this catalog - especially with regard to data, dimensions and weights given - these are subject to change without prior notice.

4. Export regulations

We shall not be obligated to fulfill any agreement if such fulfillment is prevented by any impediments arising out of national or international foreign trade or customs requirements or any embargoes and/or other sanctions.

Export of goods listed in this catalog may be subject to licensing requirements. We will indicate in the delivery details whether licenses are required under German, European and US export lists. Goods labeled with "AL" not equal to "N" are subject to European or German export authorization when being exported out of the EU. Goods labeled with "ECCN" not equal to "N" are subject to US re-export authorization.

The export indications can be viewed in advance in the description of the respective goods on the Industry Mall, our online catalog system. Only the export labels "AL" and "ECCN" indicated on order confirmations, delivery notes and invoices are authoritative.

Even without a label, or with label "AL:N" or "ECCN:N", authorization may be required i .a. due to the final disposition and intended use of goods.

If you transfer goods (hardware and/or software and/or technology as well as corresponding documentation, regardless of the mode of provision) delivered by us or works and services (including all kinds of technical support) performed by us to a third party worldwide, you must comply with all applicable national and international (re-)export control regulations.

If required for the purpose of conducting export control checks, you (upon request by us) shall promptly provide us with all information pertaining to the particular end customer, final disposition and intended use of goods delivered by us respectively works and services provided by us, as well as to any export control restrictions existing in this relation.

The products listed in this catalog may be subject to European/German and/or US export regulations. Any export requiring approval is therefore subject to authorization by the relevant authorities.

Errors excepted and subject to change without prior notice.

¹⁾ The text of the Terms and Conditions of Siemens AG can be downloaded at
www.siemens.com/automation/salesmaterial-as/catalog/en/terms_of_trade_en.pdf

Get more information

Control Products:
www.siemens.com/sirius

Siemens AG
Digital Factory
Control Products
Postfach 23 55
90713 FÜRTH
GERMANY

© Siemens AG 2018
Subject to change without prior notice
Artikel-No. E86060-K1010-A301-A1-7600
ST.PV.T.0031.S.30 / Dispo 68201
KG 0418 3. WÜ 88 En
Printed in Germany

The information provided in this catalog contains merely general descriptions or characteristics of performance which in case of actual use do not always apply as described or which may change as a result of further development of the products. An obligation to provide the respective characteristics shall only exist if expressly agreed in the terms of contract. Availability and technical specifications are subject to change without notice.

All product designations may be trademarks or product names of Siemens AG or supplier companies whose use by third parties for their own purposes could violate the rights of the owners.

Token fee: 2.00 €

Security information

Siemens provides products and solutions with industrial security functions that support the secure operation of plants, systems, machines and networks.

In order to protect plants, systems, machines and networks against cyber threats, it is necessary to implement – and continuously maintain – a holistic, state-of-the-art industrial security concept. Siemens' products and solutions only form one element of such a concept.

Customer is responsible to prevent unauthorized access to its plants, systems, machines and networks. Systems, machines and components should only be connected to the enterprise network or the internet if and to the extent necessary and with appropriate security measures (e.g. use of firewalls and network segmentation) in place.

Additionally, Siemens' guidance on appropriate security measures should be taken into account. For more information about industrial security, please visit <http://www.siemens.com/industrialsecurity>.

Siemens' products and solutions undergo continuous development to make them more secure. Siemens strongly recommends to apply product updates as soon as available and to always use the latest product versions. Use of product versions that are no longer supported, and failure to apply latest updates may increase customer's exposure to cyber threats.

To stay informed about product updates, subscribe to the Siemens Industrial Security RSS Feed under <http://www.siemens.com/industrialsecurity>.

SIRIUS 3RW
soft starters

