



Components for fixed prosthesis

**CATALOG/TECHNICAL MANUAL
CODE LIST**

for Dentists and Dental Technicians

DT
Bridge



1st Edition

W O R L D L E A D E R I N D E N T A L A T T A C H M E N T S

RHEIN83

OT Bridge

The fixed prosthesis by Rhein83

The partially or totally edentulous patient experiences a condition of strong physical and social discomfort. Nowadays, the role of the dentist and the dental technician is of primary importance. Working in a team donates to the patient the "smile and function"; this changes, literally, the individual life allowing to reach a true aesthetic rejuvenation and a psychological benefit. The prosthetist must always evaluate, realistically, the best therapy depending on the patient characteristics. The prosthetist's job is to study the appropriate prosthetic project evaluating costs, benefits and the expectations of the patient. RHEIN 83 group, during the past 35 years of activity, has invested resources and energies in the search of simple, repeatable and reliable working protocols to make the everyday dentist and dental technician work easy and, above all, with no unexpected variables. The removable implant retained denture is a proven and reliable treatment that often remains the first choice for a professional. The fixed screwed denture is a solution for the edentulism that completely changes the patient's perspective. The project "OT BRIDGE" was born and developed in the RHEIN 83 Research and Development Department, in cooperation with some of the most prestigious Italian Universities; the low profile attachment "OT EQUATOR", born in the 2007, is an evolution of the well-known spherical system OT Cap; OT EQUATOR minimizes the vertical dimensions while preserving the same retentive and functional area.

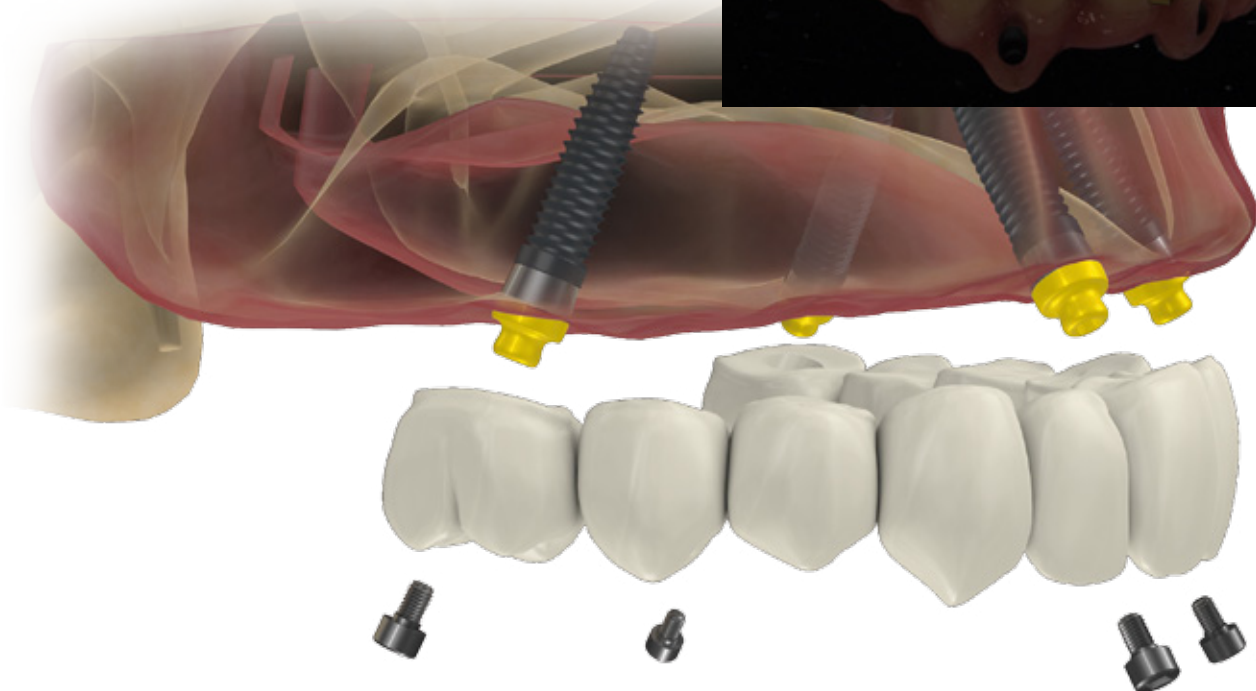

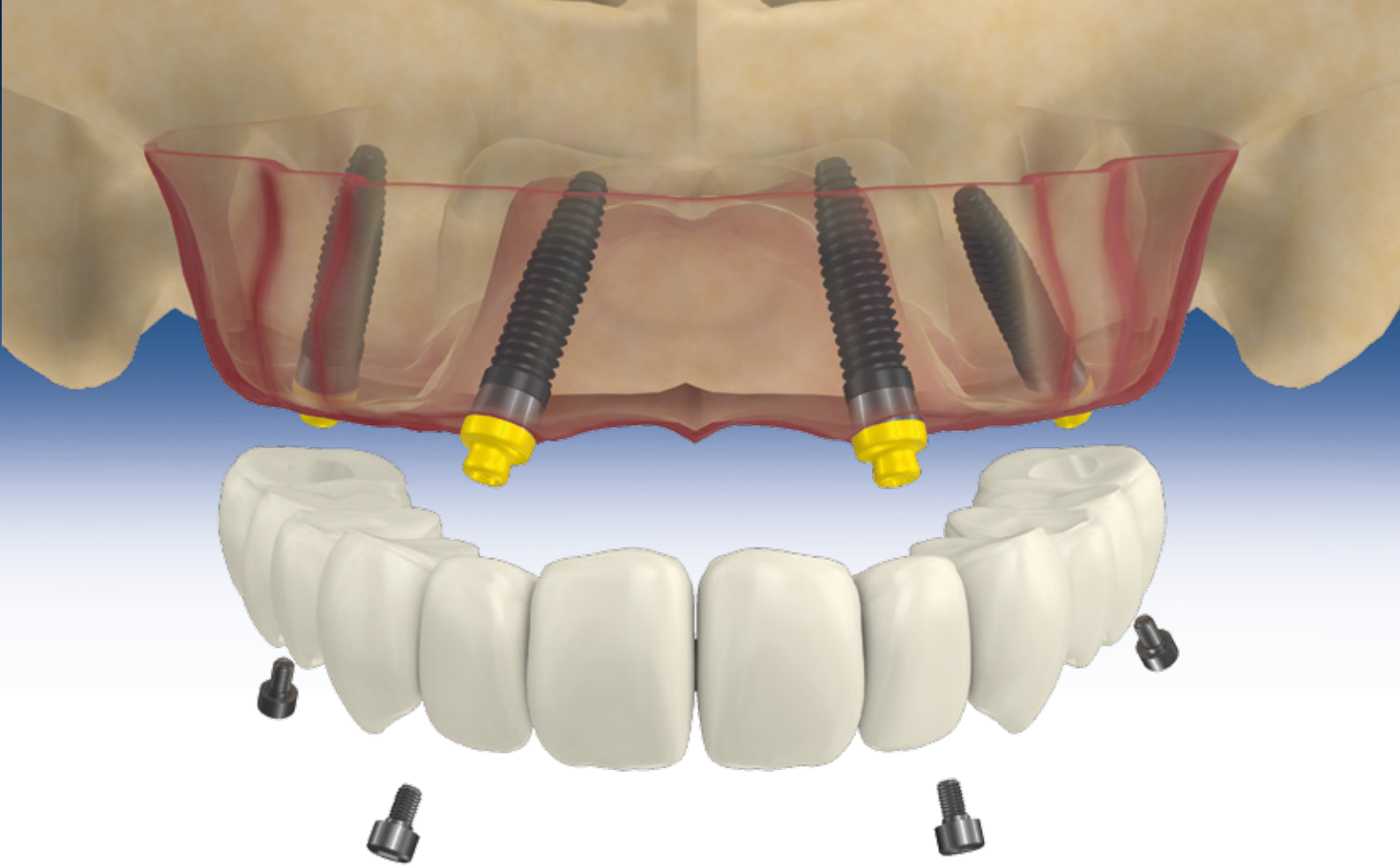

OT EQUATOR system is a global, well-established reality in the removable prosthetic protocols. Today our research allows its use in a fixed denture treatment. This is possible thanks to the Seeger system, a novelty and a revolution in the "fixed implant prosthetics" that allows to reduce the number of the prosthetic screw holes in the aesthetic areas. The sub-equatorial component, an interchangeable acetabular ring, will be housed into the cylindrical "Extragrade" abutment; this acetabular seeger spring, is one of the original elements of this product and represents a systematic alternative to the screwed and cemented dentures.

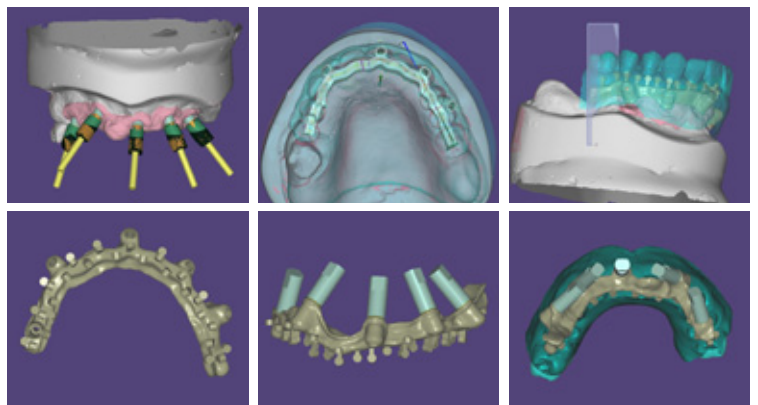

The OT Equator abutment has a blind threaded hole that does not communicate with the implant; this avoids any bacterial infiltration into the implant. The main mechanical advantage of the system is its multifunctionality in overcoming the implant divergence, even in extreme cases over 80° without resorting to components like MUA or without using time-consuming milled abutments techniques.



The real revolution offered by Ot Equator system is in the versatility; you can use the same abutment, regardless if it is a removable or fixed denture. Saving materials, tools and working time is a key point both for the clinic and the laboratory; moreover, the OT Equator system is also available in the digital dental field in the most advanced cad-cam software.



Photo courtesy by L.Cattin, E.Giunchi

TITANIUM ABUTMENTS WITH THROUGH HOLE SCREW AND CASTABLE SLEEVE

The titanium abutments with through hole screw are used in all dentures where the divergence does not create any aesthetic problem for the access to the prosthetic screw in the dental arch

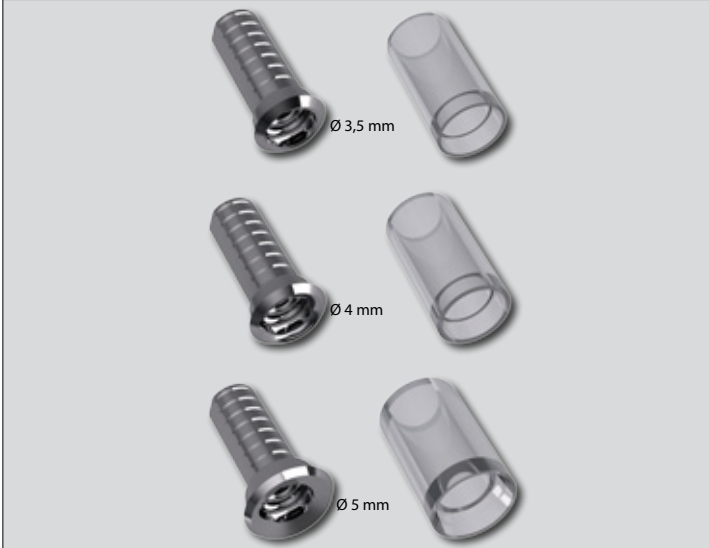

TITANIUM ABUTMENTS INCLINED AT 15° WITH NO THROUGH HOLE SCREW, AND CASTABLE SLEEVE

The Extragrade titanium abutments with no through hole for screws are used to create a fixed denture "Seeger Bridge" even on very divergent implants, exploiting, with the Seeger, the abutment undercuts as an anchoring area obtaining in this way a "snap" retention.



OT BRIDGE DIGITAL SOLUTION

SOLUTION A



Model scan with the titanium through hole abutments for a CAD design.

SOLUTION B



Scan of the model with the scan abutments for the digital flow. The top beveled surface matches with the Extragrade incision of the titanium abutment; the Extragrade must always be positioned in correspondence of the maximum undercut created by the tilted implant.



Digital structure CAD designed, ready to be realized. The Extragrade titanium abutments will be cemented into the holes.

MONCONI IN TITANIO CON E SENZA VITE + GUAINA CALCINABILE

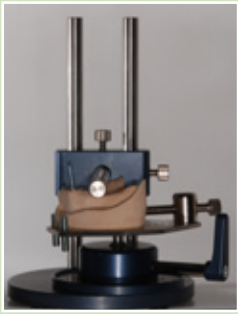

Model analysis with the Rhein83 parallelometer.

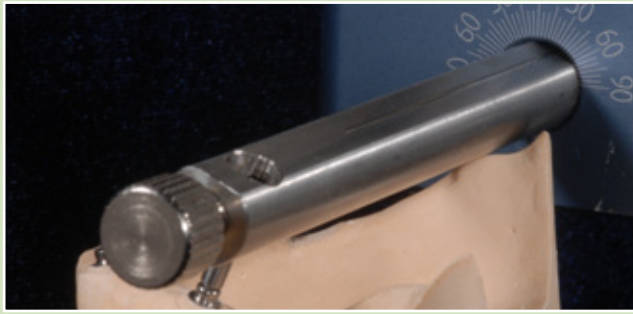

Implants divergency analysis.



Analysis of the teeth set-up dimensions. The project is made with the titanium abutments with screws, sleeves to be bonded and titanium abutments inclined at 15° without screws.

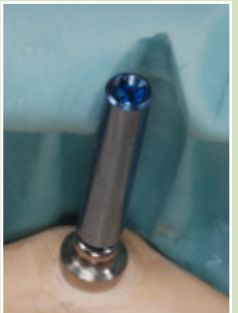

Long screw on Ot Equator analog to check where the prosthetic screw hole will be located.



Extragate Titanium Abutment inclined at 15° without screw. The white Seeger must be positioned with its open side towards the Extragate bevel.

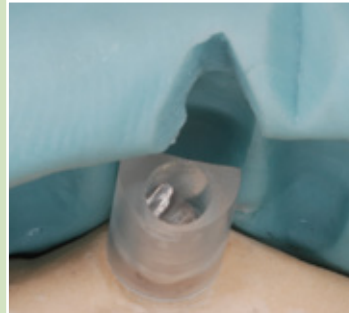

In case of an excessive implant inclination, it is suggested to use an Extragate titanium abutment inclined at 15° without screw and a castable sleeve to be bonded. The abutment will be retained by the white Seeger only. The percentage of abutments without screws should be limited to 25% of the total number of abutments (in this case 1 out of 4).



It is important to position the flat surface of the titanium abutment in correspondence with the undercut created by the inclination of the implant; the flat surface indicates the location of the Extragate bevel, which will allow the denture to overcome the undercuts created by the tilted implant.



The open side of the Seeger must be positioned towards the Extragate, a position that is forced by an anti-rotational device located into the abutment.



The castable sleeve allows the construction of a structure that later will be cast. Then the Extragate titanium abutments will be passively bonded.



The castable structure must be as passive as possible. Passivity is facilitated by the use of castable gingival connectors that can be adapted, cut and shaped, trying to leave as little space as possible between these and the implant abutment.



The castable structure ready to be cast.



Before bonding, the fitting of the framework should be tested. It is important to cement the elements one at a time. The use of the Ot Cem composite cement from Rhein83 is recommended.



Place the Extragate titanium abutment with the short screw onto the Ot Equator attachment, **making sure to place the flat surface of the titanium abutment in correspondence with the undercut created by the implant inclination.** It is recommended to protect the screw hole with a wax pin.

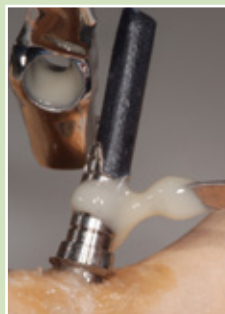

The cement should be put on the external part of the Extragate titanium abutment and into the internal surface of the metal cast sleeve. The wax pin will seal and protect the entrance of the prosthetic screw.



Alternatively: screw the titanium abutment and smear the screw with vaseline, keeping the Extragate abutment in the exact position; respect the setting time of the composite cement as reported in the instructions for use.



Work polished, assembled, ready to be coated with the aesthetic material. Please note the white Seegers inserted in the Extragate abutment housing.

CASTABLE ABUTMENT WITH PASSING THROUGH HOLE FOR SCREW AND SEEGER



CASTABLE ABUTMENT WITHOUT PASSING THROUGH HOLE FOR SCREW AND SEEGER



OT EQUATOR ABUTMENT



CASTABLE CONNECTOR



SPECIAL BUR

for the polishing of the abutment housing



TITANIUM SCREW H11,5mm



WHITE SEEGER WITH HANDLE

standard retention



SQUARE LONG SCREW DRIVER

usable with the manual torque wrench



TITANIUM SCREW H2mm



PINK SEEGER WITH HANDLE

soft retention



SQUARE SCREW DRIVER + HOLDER

usable with the manual torque wrench



MANUAL TORQUE WRENCH



UNIVERSAL HANDLE FOR MINI IMPRESSION COPING INSERTION



SQUARE DRIVER CONNECTOR FOR TORQUE HANDPIECE



COMPOSITE CEMENT OT CEM

for the metal bonding (2 components)

CASTABLE ABUTMENTS

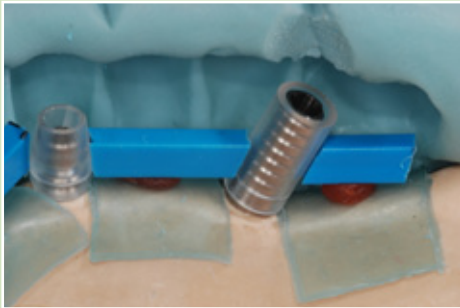

Model analysis with the help of the diagnostic teeth set-up mask. Where the space is limited, the Extragrade castable abutment is advisable which, while allowing a passive insertion, overcomes the divergencies and can be shaped accordingly to the available spaces.

Into the castable abutment with screw, likewise the titanium abutment with screw, you can see the bevel called Extragrade.

The Extragrade position is indicated by the flat surface outside the abutment; this must always be positioned in correspondence with the undercut created by the tilted implant.

Cast and sand-blasted bar with 150 micron particle size aluminum dioxide at 3 atmospheres.



Detail of the castable abutment after the casting and the sandblasting.

Special bur to clean any oxides, micro-imperfections or bubbles inside the Seeger housing in those areas where the sandblasting is not effective.

Test with the OT Equator analog, before proceeding with the trimming and the polishing of the framework.

Framework polished and ready to be finished with the aesthetic covering.



Insert the Seeger as shown in the photo by placing the open section in correspondence with the undercut created by the inclination of the implant.

Work finished; caudal view.

Vestibular view. Please note that thanks to the pre-angled abutments and the Seeger there are no vestibular prosthetic screw holes.

Denture completed.

Ideal solution for cases with immediate loading or for all cases where a temporary device is required to provide an excellent structural strength.

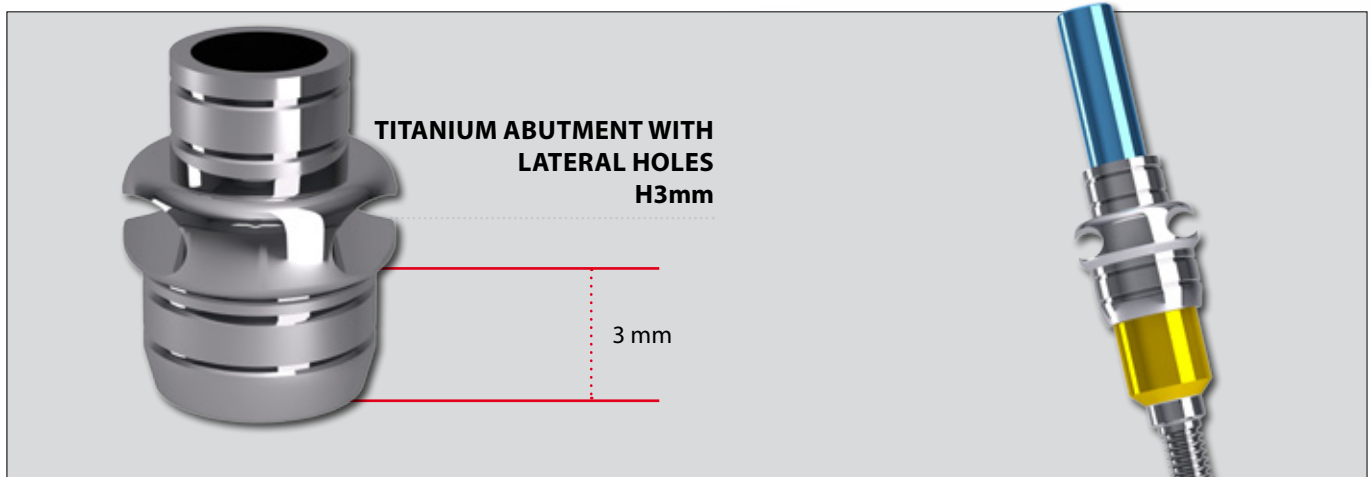
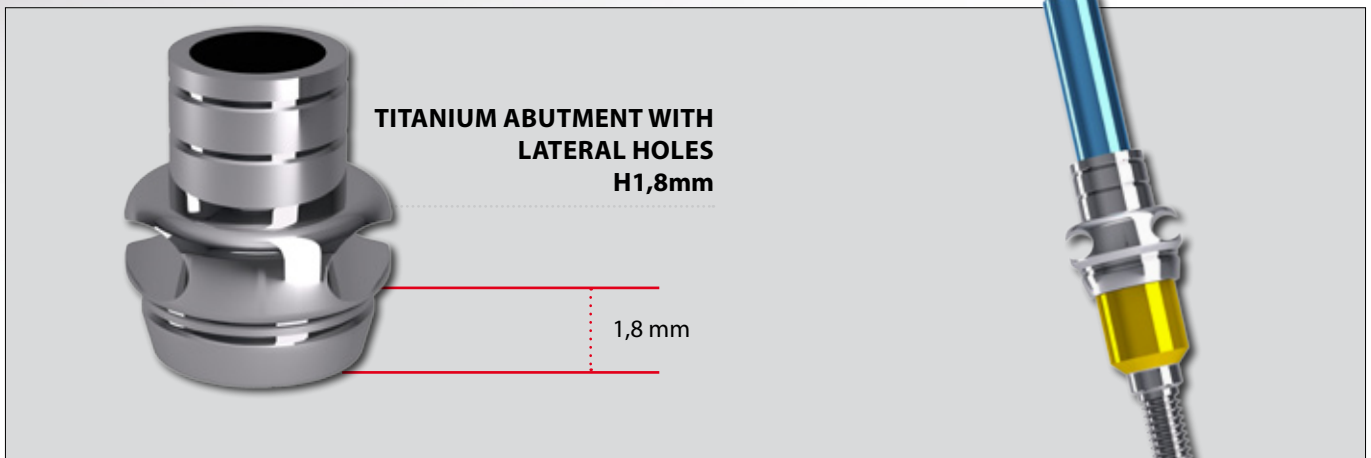

OT EQUATOR ABUTMENT



TITANIUM SCREW H11,5mm



TITANIUM SCREW H2mm



WHITE SEEGER WITH HANDLE
standard retention



PINK SEEGER WITH HANDLE
soft retention



MINI
IMPRESSION COPING

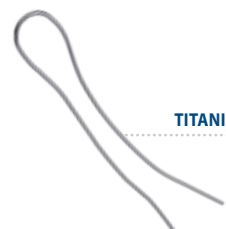

TITANIUM WIRE Ø 1,0mm

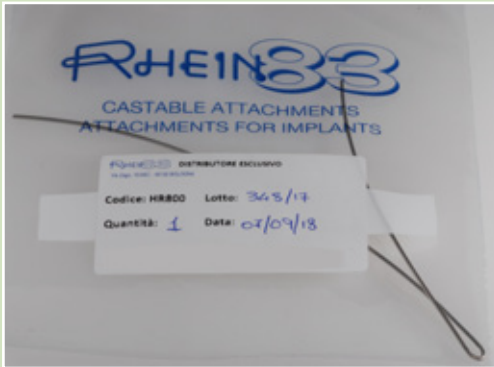

Titanium wire for the construction of wire reinforced frameworks.



Titanium wire inserted into the lateral hole (Ø 1mm) of the abutment.

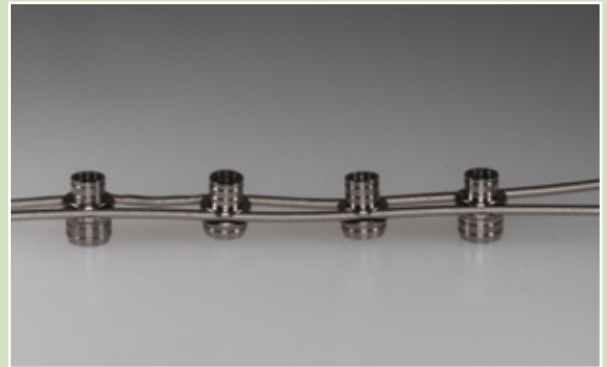

Insert the titanium wire into all lateral holes of the titanium abutments.



Screw the titanium abutments with lateral holes one at a time and bend the titanium wire accordingly so to follow the correct gingival and prosthetic profile.



The teeth are positioned and shaped accordingly to the mask and the available spaces.



The titanium abutments with lateral holes can be adapted accordingly to the available spaces and being properly opacified and then embodied with self-curing aesthetic resin.



The titanium abutments with lateral holes do not have the Extragrade bevel, so if necessary it can be made manually, once the work is finished, paying the utmost attention in doing it always on the divergent side.



It is fundamental to position the Seegers so that their open side is in correspondence with the undercut created by the tilted implant.



Insertion of the Seegers into all the titanium abutments.



Even with the temporary dentures, the insertion patterns must be followed accordingly to the implant divergences both on the model and into the patient's mouth.



In case of strong disparallelisms (like an all-on-four) it is advisable to insert the bridge first on the most inclined attachments, which in this case are those located on the incisor area, then moving to the posterior area, making the denture snap into the correct position.



The resin-wire-reinforced bridge is finished and delivered to the dentist in about 2 hours.

TRANSFER DA IMPRONTA



**TITANIUM IMPRESSION COPING
WITH LONG SCREW FOR
PICK-UP IMPRESSION**



PLASTIC IMPRESSION COPING



**PLASTIC MINI IMPRESSION
COPING**

OT EQUATOR STAINLESS STEEL ANALOGS

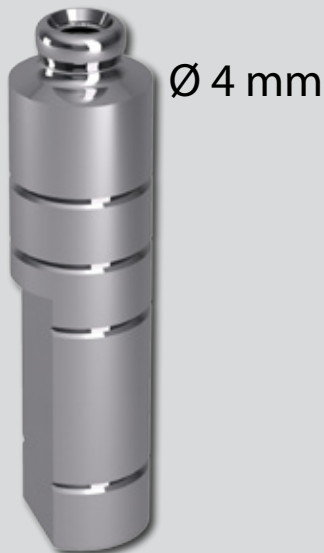



Impression with the titanium impression copings with screws.

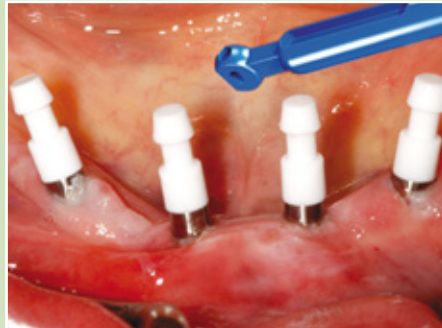

Impression with the plastic impression copings.



Impression with the plastic mini impression copings, ideal solution when there is not enough vertical dimension.



Elastomer impression with Ot Equator analogs matching the diameter of the inserted implants.



Often the plastic impression copings remain in the mouth; remove and reposition them into the impression; the right position can be easily found before pouring the model.



In case of an immediate loading denture, the impression can be taken with the mini impression copings and collecting all the necessary data just after the surgery.



View of the working upper model poured in quick-setting plaster and of the teeth set-up silicone mask.



View of the working lower model poured in quick-setting plaster and the analogs.



STAINLESS STEEL JOINT



TITANIUM JOINT



STAINLESS STEEL CLYNDER



TITANIUM CLYNDER



STAINLESS STEEL
RETENTIVE CLYNDER



TITANIUM
RETENTIVE CLYNDER

Telescopic bar designed for screwed structures without stress on implants for immediate loading dentures using the bonding technique without casting and welding; available with retentive cylinders (optional) for a better tooth retention. the system can also be used for screwed bridges. Available in medical grade stainless steel and in grade 5ELI Titanium. The Titanium version joints can be welded to the Extragrade abutments.



JOINT

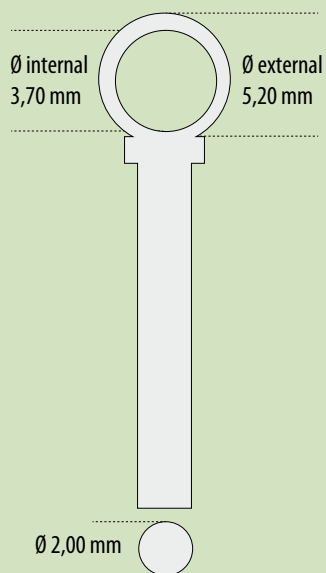

CYLINDER WITH RETENTIVE PINS

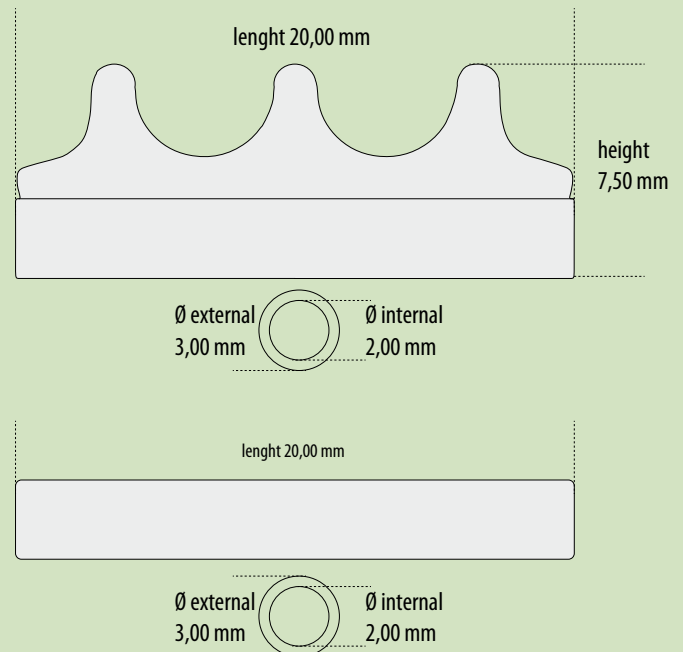

CYLINDER

OT BRIDGE

Extragate and seeger anti-rotation systems

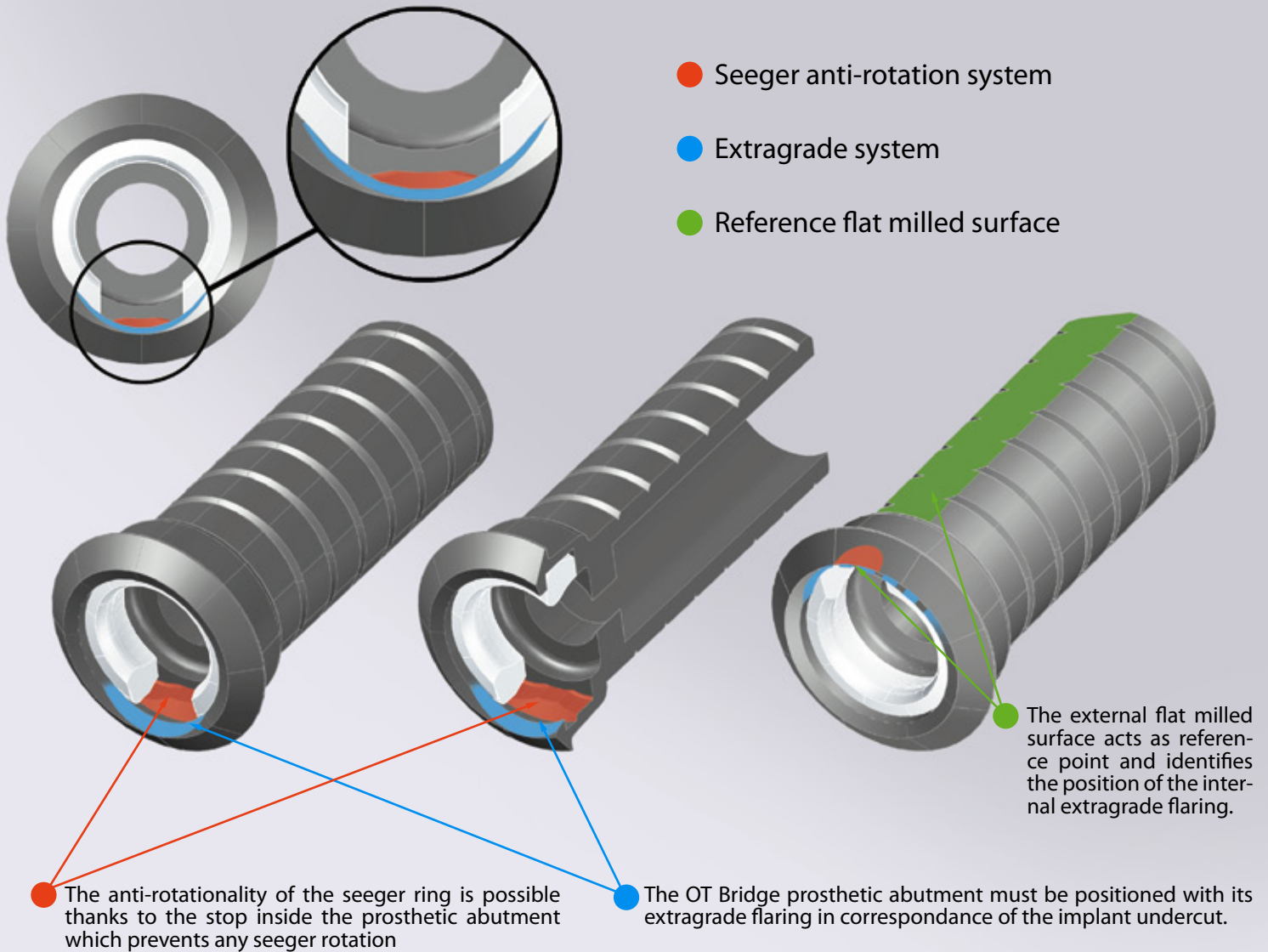

With divergent implants, the extragate abutment must be inserted with the external flat milled surface in correspondance of the maximum undercut of the Ot Equator

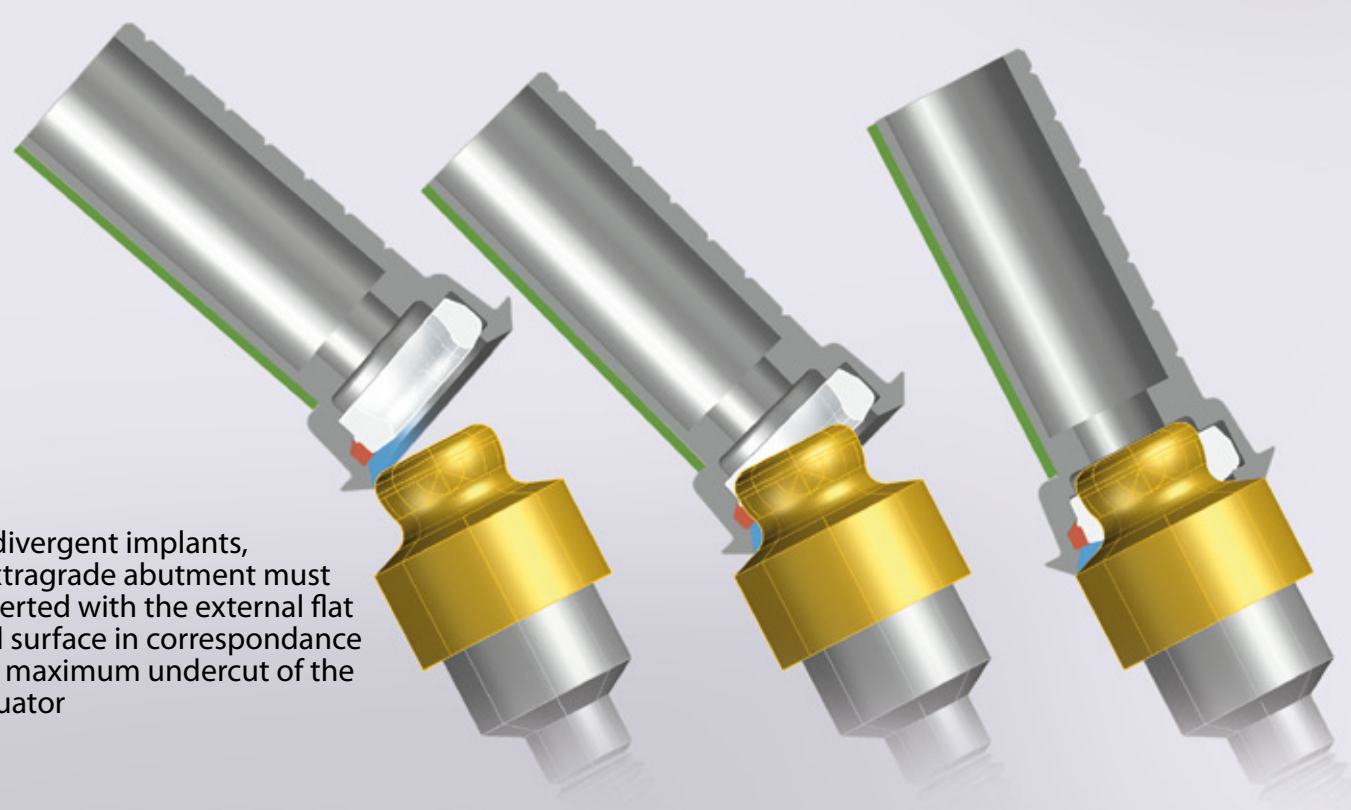

The autoclavable Set42 (BE42 + 42 Ot Equator of your choice) is suitable when an implant immediate loading procedure is preferred. It allows, indeed, to have available and ready to use different heights of OT Equator abutments. The Set 42 can be customized accordingly to the preferred brands, diameters and heights.

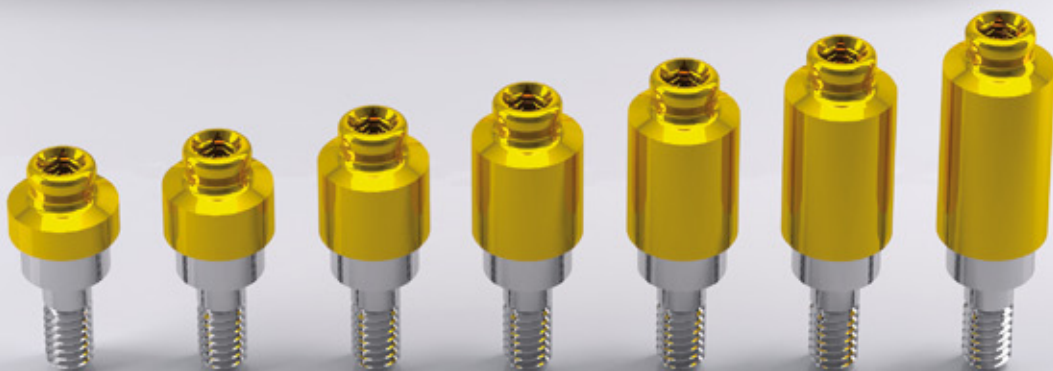

The Set 42 is produced and shipped within 5 days from the order, it is mandatory to indicate: implant brand, implant diameter and cuff height.

Available heights:
for internal hexagon implants from 0.5 to 7mm
for external hexagon implants from 2 to 7mm

OT EQUATOR ABUTMENT



Ref. 030

- 1 OT EQUATOR TITANIUM ABUTMENT WITH TiN COATING

SET 42



Ref. BE42
+ n° 42 Ot Equator
(Ref. 030 to be chosen)

- 1 ASSORTMENT SET (autoclavable) + 42 OT EQUATOR +TiN ABUTMENTS
THE SET42 CAN BE CUSTOMIZED ON THE BASIS OF THE IMPLANTS BRANDS, IMPLANTS DIAMETERS AND CUFF HEIGHTS DESIRED. PLEASE INDICATE, IN THE ORDER, THE QUANTITY AND THE ABOVE SPECIFICATIONS FOR EVERY KIND OF ABUTMENT.



Ref. BE42

- 1 EMPTY BOX FOR ASSORTED OT EQUATOR ABUTMENTS (ABUTMENTS NOT INCLUDED)

IMPRESSION COPINGS



Ref. 144TTE

- 1 TITANIUM IMPRESSION COPING + TITANIUM SCREW



Ref. 144MTE

- 2 IMPRESSION COPINGS *FOR INDIVIDUAL TRAY*



Ref. TPM2

- 2 MINI IMPRESSION COPINGS h3,7mm

OT EQUATOR SCAN ABUTMENT



Ref. 145SAE

- 1 OT EQUATOR TITANIUM SCAN ABUTMENT + TITANIUM SCREW

SCREW AND HEALING RING



Ref. 159VAG

SCREW AND HEALING RING

SET CONTENT

- 1 OT EQUATOR SELF-EXTRACTING TITANIUM SCREW
- 1 TITANIUM HEALING RING

LABORATORY ANALOGS



Ref. 144AE

- 2 LABORATORY ANALOGS ø 4mm



Ref. AI502

- 2 LABORATORY ANALOGS ø 5mm

SCREWS



Ref. VC

- 1 TITANIUM SCREW h2mm

Ref. VXL

- 1 TITANIUM SCREW h11,5mm

TOOLS



Ref. 774CHE

- 1 SQUARE SCREW DRIVER + OT EQUATOR HOLDER
(SQUARE TIP 1.25mm) (USABLE WITH THE MANUAL TORQUE WRENCH)



Ref. 775CLE

- 1 SQUARE LONG SCREW DRIVER
(SQUARE TIP 1.25mm) (USABLE WITH THE MANUAL TORQUE WRENCH)



Ref. 774HC

- 1 INTERCHANGEABLE HOLDER



Ref. 760CE

- 1 SQUARE DRIVER CONNECTOR
FOR TORQUE HANDPIECE (SQUARE TIP 1,25mm)



Ref. 760CRD

- 1 MANUAL TORQUE WRENCH For Ot Equator and Sphero Block/Flex
(TORQUE RANGE: 15-35 Ncm - MAX. ALLOWED 50Ncm)



Ref. 124ICP

- 1 UNIVERSAL HANDLE

MEDICAL STEEL T-BAR



Ref. G80A

- 4 MEDICAL STEEL JOINTS



Ref. T20A

- 4 MEDICAL STEEL CYLINDERS



Ref. T20Ai

- 4 MEDICAL STEEL RETENTIVE CYLINDERS

TITANIUM T-BAR



Ref. G80T

- 4 TITANIUM JOINTS



Ref. T20T

- 4 TITANIUM CYLINDERS



Ref. T20Ti

- 4 TITANIUM RETENTIVE CYLINDERS

T-BAR TOOLS



Ref. TA

- 2 T-BAR ADAPTERS

ABUTMENTS FOR FIXED PROSTHESIS



Ref. MTSEG

Ø3,5mm

EXTRAGRADE TITANIUM ABUTMENT Ø3,5mm

SET CONTENT

- 1 EXTRAGRADE TITANIUM ABUTMENT TO BE CEMENTED h9,5mm Ø3,5mm
- 1 TITANIUM SCREW h2mm
- 2 WHITE SEEGER'S WITH HANDLE



Ref. MT40SEG

Ø4,0mm

EXTRAGRADE TITANIUM ABUTMENT Ø4,0mm

SET CONTENT

- 1 EXTRAGRADE TITANIUM ABUTMENT TO BE CEMENTED h9,5mm Ø4,0mm
- 1 TITANIUM SCREW h2mm
- 2 WHITE SEEGER'S WITH HANDLE



Ref. MT50SEG

Ø5,0mm

EXTRAGRADE TITANIUM ABUTMENT Ø5,0mm

SET CONTENT

- 1 EXTRAGRADE TITANIUM ABUTMENT FOR CEMENTATION h9,5mm Ø5,0mm
- 1 TITANIUM SCREW h2mm
- 2 WHITE SEEGER'S WITH HANDLE



Ref. MTSFEG

Ø3,5mm

EXTRAGRADE TITANIUM ABUTMENT WITHOUT HOLE, INCLINED AT 15°

SET CONTENT

- 1 EXTRAGRADE TITANIUM ABUTMENT INCLINED AT 15° TO BE CEMENTED Ø3,5mm
- 2 WHITE SEEGER'S WITH HANDLE



Ref. MTEG15SF

Ø4,0mm

EXTRAGRADE TITANIUM ABUTMENT WITHOUT HOLE, INCLINED AT 15°

SET CONTENT

- 1 EXTRAGRADE TITANIUM ABUTMENT INCLINED AT 15° TO BE CEMENTED Ø4,0mm
- 2 WHITE SEEGER'S WITH HANDLE



Ref. CMEG40C

Ø4,0mm

EXTRAGRADE CASTABLE ABUTMENT

SET CONTENT

- 1 EXTRAGRADE CASTABLE ABUTMENT WITH HOLE
- 1 TITANIUM SCREW h2mm
- 2 WHITE SEEGER'S WITH HANDLE



Ref. MCEG15SF

Ø4,0mm

EXTRAGRADE CASTABLE ABUTMENT WITHOUT HOLE

SET CONTENT

- 1 EXTRAGRADE CASTABLE ABUTMENT WITHOUT HOLE (ONLY AVAILABLE WITH Ø4,0mm)
- 2 WHITE SEEGER'S WITH HANDLE
- 1 PINK SEEGER WITH HANDLE



Ref. CMTFP

h1,8mm

TITANIUM ABUTMENT WITH LATERAL HOLES FOR TEMPORARY RESIN BRIDGE WITH WIRE-REINFORCEMENT

SET CONTENT

- 1 TITANIUM ABUTMENT WITH LATERAL HOLES h1,8mm (ONLY AVAILABLE WITH Ø4,0mm)
- 1 TITANIUM SCREW h2mm
- 2 WHITE SEEGER'S WITH HANDLE



Ref. CMTB30FP

h3,0mm

TITANIUM ABUTMENT WITH LATERAL HOLES FOR TEMPORARY RESIN BRIDGE WITH WIRE-REINFORCEMENT

SET CONTENT

- 1 TITANIUM ABUTMENT WITH LATERAL HOLES h3,0mm (ONLY AVAILABLE WITH Ø4,0mm)
- 1 TITANIUM SCREW h2mm
- 2 WHITE SEEGER'S WITH HANDLE



Ref. MT40GL



















Ø4,0mm

TITANIUM NORMO ABUTMENT FOR INTRA ORAL WELDING

SET CONTENT

- 1 TITANIUM NORMO ABUTMENT FOR INTRA ORAL WELDING h9,5mm Ø4,0mm
- 1 TITANIUM SCREW h2mm
- 2 WHITE SEEGER'S WITH HANDLE

SPARE PARTS

	Ref. RMTSFEG	• 1 EXTRAGRADE TITANIUM ABUTMENT WITHOUT HOLE, INCLINED AT 15° Ø3,5mm
	Ref. RMTEG15SF	• 1 EXTRAGRADE TITANIUM ABUTMENT WITHOUT HOLE, INCLINED AT 15° Ø4,0mm
	Ref. RMTSEG	• 1 EXTRAGRADE TITANIUM ABUTMENT Ø3,5mm
	Ref. RMT40SEG	• 1 EXTRAGRADE TITANIUM ABUTMENT Ø4,0mm
	Ref. RMT50SEG	• 1 EXTRAGRADE TITANIUM ABUTMENT Ø5,0mm
	Ref. GCMR	• 1 CASTABLE SLEEVE FOR INCLINED TITANIUM ABUTMENT WITHOUT HOLE Ø3,5mm
	Ref. GCMR4	• 1 CASTABLE SLEEVE FOR INCLINED TITANIUM ABUTMENT WITHOUT HOLE Ø4,0mm
	Ref. GC	• 1 CASTABLE SLEEVE FOR TITANIUM ABUTMENT Ø3,5mm
	Ref. GC4	• 1 CASTABLE SLEEVE FOR TITANIUM ABUTMENT Ø4mm
	Ref. GC5	• 1 CASTABLE SLEEVE FOR TITANIUM ABUTMENT Ø5mm
	Ref. MTFP	• 1 TITANIUM ABUTMENT WITH LATERAL HOLES FOR TEMPORARY RESIN BRIDGE WITH WIRE-REINFORCEMENT h1,8mm (ONLY AVAILABLE WITH Ø4,0mm)
	Ref. MTB30FP	• 1 TITANIUM ABUTMENT WITH LATERAL HOLES FOR TEMPORARY RESIN BRIDGE WITH WIRE-REINFORCEMENT h3mm (ONLY AVAILABLE WITH Ø4,0mm)
	Ref. HR800	• 1 TITANIUM WIRE WITHOUT ELASTIC MEMORY Ø1,0mm
	Ref. MEG40C	• 1 EXTRAGRADE CASTABLE ABUTMENT Ø4,0mm
	Ref. RMCEG15SF	• 1 EXTRAGRADE CASTABLE ABUTMENT WITHOUT HOLE (ONLY AVAILABLE WITH Ø4,0mm)
	Ref. SM6	• 6 WHITE SEEGERS WITH HANDLE (STANDARD RETENTION)
	Ref. SRM6	• 6 PINK SEEGERS WITH HANDLE (SOFT RETENTION)
	Ref. 022RGO	• 2 CASTABLE CONNECTION BAR
	Ref. FSS	• 1 BUR FOR THE SEEGER HOUSING POLISHING



Via ZAGO 10/ABC 40128 - BOLOGNA (ITALY)
Tel. (+39) 051 244510 - (+39) 051 244396 Fax (+39) 051 245238
<http://www.rhein83.com>
marketing@rhein83.it