



EEMANN | **CATALOGUE**
TECH | **2021**



Quality. Experience. Technology.



EEMANN TECH is a Company that was founded by experts with extensive experience and knowledge in the IPSC arena. This knowledge was gained by being actively involved in the organizational roles of IPSC matches as well as taking part as competitors in the highest level of international competitions.

The main field of our activity is manufacturing and supplying the market with high quality spare and tuning parts, paper and steel targets and accessories for IPSC sports.

We are constantly developing and expanding the range of products to satisfy all our Customers requirements. If you have any questions please feel free to contact us.

We are here for You!
The EEMANN TECH team.

OUR MISSION

Our mission is to satisfy our Customers needs with quality products and professional services. We combine modern technology, performance standards, and long-term experience to deliver products of high quality and precision.

We are here to take care of all your needs and assist you in gaining the highest achievements.

OUR GOAL

Our goal is to assist competitors to achieve best results.

COOPERATION

If you are interested in cooperation and want to become a dealer in your region, please feel free to send us your questions, offers and requests to the following email: export@eemann-tech.com.

We are always open for cooperation and ready to answer any questions you have!

Table of contents

Springs	5-42
CZ	6-15
COLT	16-23
TANFOGLIO	24-25
GLOCK	26-27
SIG SAUER	28-29
XDM	30
SPHINX	30
SPS	30
AR-15	31-34
AR-9 PCC	35-36
MOLOT-VEPR 12ga	37
BENELLI	38
DILLON PRECISION	39-42
Parts	43-101
COLT	45-62
CZ	63-89
GLOCK	90-93
TANFOGLIO	94
AR-15	95-100
AR-9 PCC	101
Targets	102-113
Steel Targets	104-106
Cardboard Targets	107-109
Target Patchers	110-111
ISSF 25M Target	112
Dry Firing Kits	113
Tools & Accessories	114-119
Polishing Media	119
Apparels	120-122



Everything is Possible



SPRINGS

We offer wide selection of tuning and factory-power springs for the most popular pistol models in IPSC practical shooting: Colt 1911/2011, CZ, Glock, Tanfoglio, Sphinx, Sig Sauer, Springfield XDM and other.

Each competitor can customize their shooting equipment using EEMANN TECH parts according to their needs and division requirements. We have all the parts you need for your handguns to match the factory parameters and usual functioning using EEMANN TECH factory-power springs or make them highly customized by using the EEMANN TECH tuning springs.

Thanks to advanced technologies our springs have an increased service life.

Not only do we have single springs, but we also offer spring sets. There are sets of standard and competition springs for different pistol models and kits of springs with different power values. All springs are labelled and packed accordingly.

The Eemann Tech Competition Recoil Spring For CZ

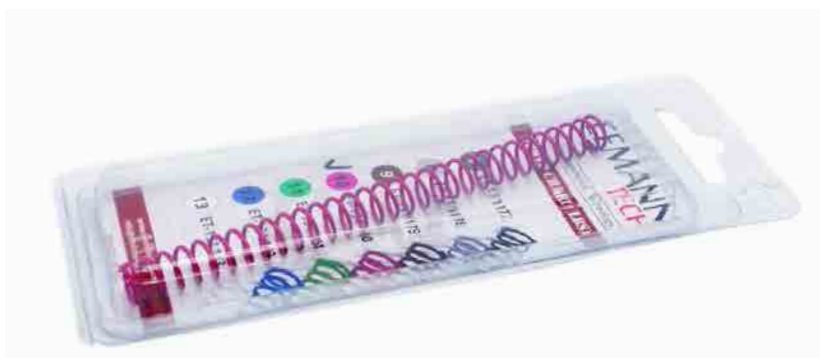

Reference nr.	Spring weight
ET-131177	7 lbs
ET-131178	8 lbs
ET-131179	9 lbs
ET-131180	10 lbs
ET-131181	11 lbs
ET-131182	12 lbs
ET-131183	13 lbs

The Eemann Tech competition recoil spring has been specially designed for:

- CZ 75 SP-01 Shadow
- CZ Shadow 2

The spring also fits all CZ 75 pistols with long Recoil Spring Guide rods.

Precise Your **Power** With Colors

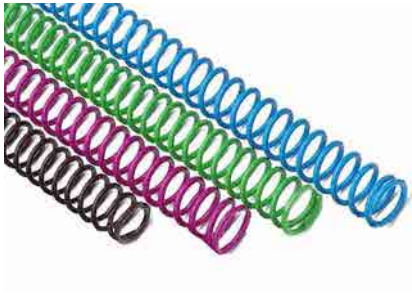

THE EEMANN TECH RECOIL SPRINGS CALIBRATION PACK FOR CZ

Reference nr.

ET-131199

- ET-131179 9 lbs - 1 pc.
- **ET-131180 10 lbs - 1 pc.**
- ET-131181 11 lbs - 1 pc.
- ET-131182 12 lbs - 1 pc.

EEMANN TECH RECOIL SPRING FOR CZ 75, CZ SHADOW 2



Reference nr. **Spring weight**

ET-131137	7 lbs
ET-131138	8 lbs
ET-131139	9 lbs
ET-131140	10 lbs
ET-131141	11 lbs
ET-131142	12 lbs
ET-131143	13 lbs
ET-131144	14 lbs
ET-131145	15 lbs
ET-131146	16 lbs

EEMANN TECH MAIN SPRING FOR CZ 75, CZ SHADOW 2



Reference nr. **Spring weight**

ET-131117	7 lbs
ET-131118	8 lbs
ET-131119	9 lbs
ET-131120	10 lbs
ET-131121	11 lbs
ET-131122	12 lbs
ET-131123	13 lbs
ET-131126	16 lbs

EEMANN TECH EXTRACTOR SPRING FOR CZ 75, CZ SHADOW 2



Reference nr. **Caliber**

ET-131152	9x19/9x21mm
ET-132152	.40S&W



EEMANN TECH FIRING PIN SPRING FOR CZ 75, CZ SHADOW 2

Reference nr.

ET-131155



EEMANN TECH FIRING PIN SPRING LIGHT (-15% POWER) FOR CZ 75, CZ SHADOW 2*

Reference nr.

ET-131156

*15% less from factory power



EEMANN TECH MAGAZINE CATCH RELEASE SPRING FOR CZ 75, CZ SHADOW 2

Reference nr.

ET-131133



EEMANN TECH COMPETITION MAGAZINE CATCH RELEASE SPRING (-10% POWER) FOR CZ 75, CZ SHADOW 2

Reference nr.

ET-131200

NEW



EEMANN TECH SAFETY DETENT PLUNGER SPRING FOR CZ 75, CZ SHADOW 2

Reference nr.

ET-131131



EEMANN TECH EJECTOR SPRINGS SET FOR
CZ 75 TACTICAL SPORT*

Reference nr.

ET-132174

*Two pieces set

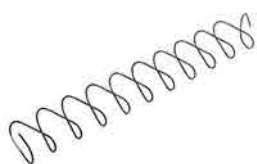

EEMANN TECH MAGAZINE SPRING
(OEM 18 ROUNDS) FOR CZ 75 SP-01 SHADOW

Reference nr.

ET-131147

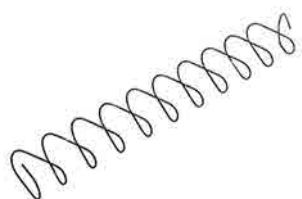

EEMANN TECH MAGAZINE SPRING (MEC-GAR
19 ROUNDS) FOR CZ SHADOW 2

Reference nr.

ET-131148



EEMANN TECH MAGAZINE SPRING FOR
CZ 75 TACTICAL SPORTS, 9X19/.40SW

Reference nr.

ET-131149

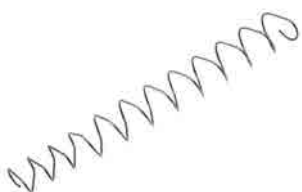

EEMANN TECH MAGAZINE SPRING FOR
CZ 75, 16 ROUNDS MAGAZINE

Reference nr.

ET-131150



EEMANN TECH SEAR SPRING FOR CZ 75, CZ SHADOW 2

Reference nr.

ET-131112



EEMANN TECH COMPETITION SEAR SPRING (-10% POWER) FOR CZ 75, CZ SHADOW 2*

Reference nr.

ET-131113

*10% less from factory power



EEMANN TECH TRIGGER BAR SPRING FOR CZ 75, CZ SHADOW 2

Reference nr.

ET-131134



EEMANN TECH COMPETITION TRIGGER BAR SPRING (-15% POWER) FOR CZ*

Reference nr.

ET-131201

NEW

*15% less from factory power



EEMANN TECH SLIDE STOP SPRING FOR CZ 75, CZ SHADOW 2

Reference nr.

ET-131103

EEMANN TECH

Quality. Experience.
Technology.

The Eemann Tech Competition Trigger Spring for CZ 75

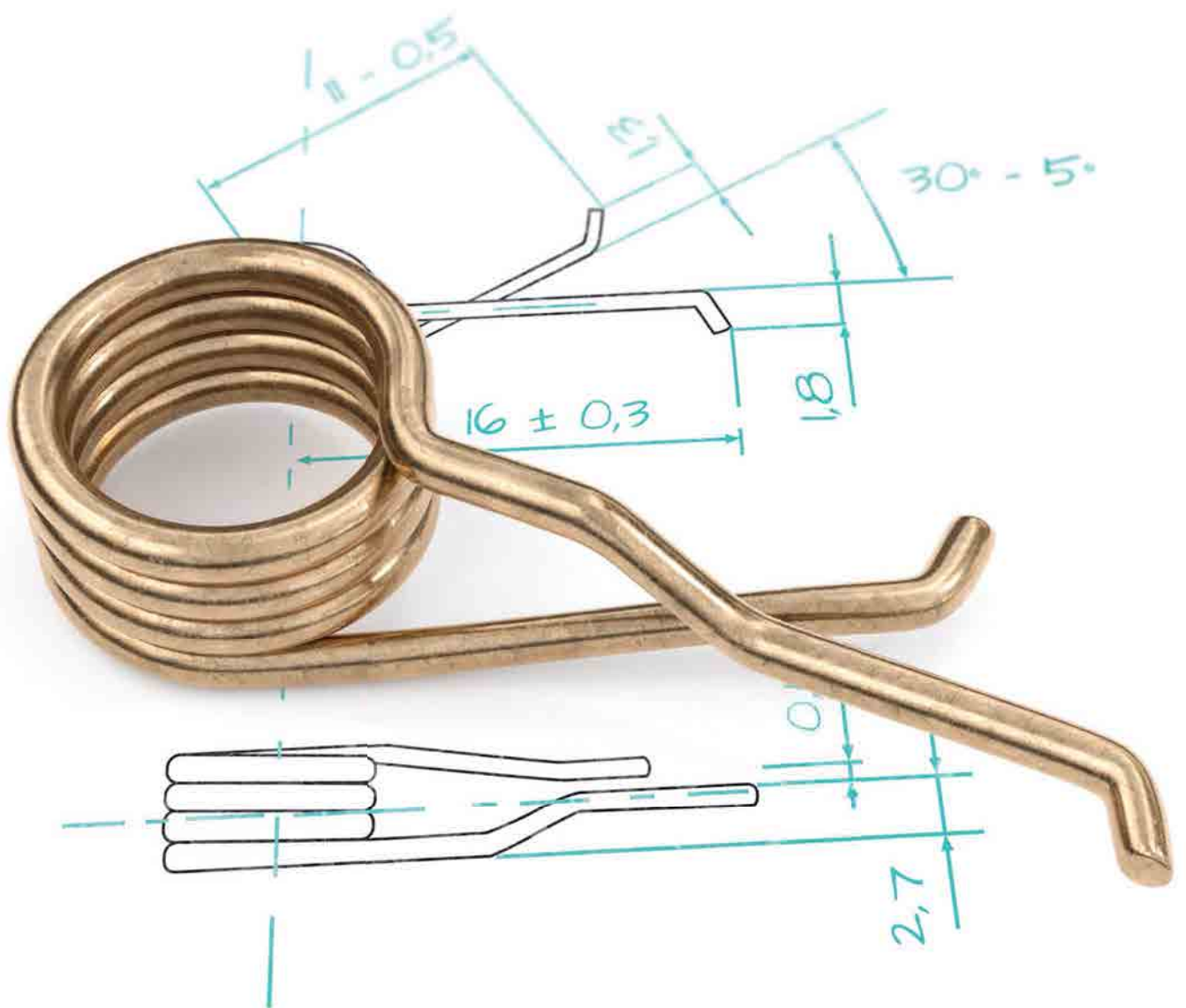

Accuracy on Every Level



EEMANN TECH TRIGGER SPRING FOR CZ 75, CZ SHADOW 2

Reference nr.

ET-131108



EEMANN TECH COMPETITION TRIGGER SPRING (-15% POWER) FOR CZ 75, CZ SHADOW 2*

Reference nr.

ET-131109

*15% less from factory power



EEMANN TECH EXTREME TRIGGER SPRING (+10% POWER) FOR CZ 75, CZ SHADOW 2*

Reference nr.

ET-131110

*10% more from factory power



EEMANN TECH TRIGGER SPRING FOR CZ 75 TACTICAL SPORT

Reference nr.

ET-132108



EEMANN TECH COMPETITION TRIGGER SPRING (-15% POWER) FOR CZ 75 TACTICAL SPORT*

Reference nr.

ET-132118

*15% less from factory power

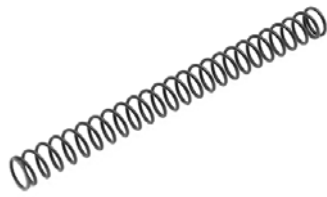

EEMANN TECH FIRING PIN SPRING FOR CZ P-10

Reference nr.

ET-130091

NEW



EEMANN TECH DISASSEMBLY PLATE SPRING FOR CZ P-10

Reference nr.

ET-130098

NEW



EEMANN TECH TRIGGER BAR DISCONNECTOR SPRING FOR CZ P-10

Reference nr.

ET-130097

NEW



EEMANN TECH MAGAZINE CATCH SPRING FOR CZ P-10

Reference nr.

ET-130096

NEW



EEMANN TECH TRIGGER BAR SPRING FOR CZ P-10*

Reference nr.

ET-130095

NEW

*Two pieces set



EEMANN TECH SLIDE STOP SPRING FOR CZ P-10

Reference nr.

ET-130094

NEW



EEMANN TECH SEAR SPRING FOR CZ P-07/P-09

Reference nr.

ET-130106

NEW

EEMANN TECH HAMMER DECOCKING
LEVER SPRING FOR CZ P-07/P-09

Reference nr.

ET-130099

NEW

EEMANN TECH TRIGGER BAR SPRING
FOR CZ P-07/P-09

Reference nr.

ET-130108

NEW

EEMANN TECH SAFETY LATCH SPRING
FOR CZ P-07/P-09

Reference nr.

ET-130107

NEW

EEMANN TECH EXTRACTOR SPRING
FOR CZ P-07/P-09/P-10

Reference nr.

ET-130093

NEW

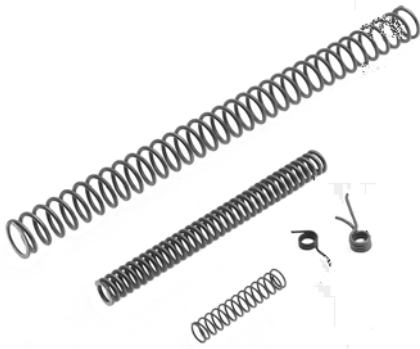

EEMANN TECH COMPETITION SPRINGS KIT FOR CZ

Reference nr.

ET-131203

NEW

- ET-131141 - 1pc.
- ET-131119 - 1pc.
- ET-131109 - 1pc.
- ET-131156 - 1pc.
- ET-131113 - 1pc.

The Eemann Tech Competition Springs Kit for CZ has been specially made for IPSC and USPSA competitors. Use it if you wish to improve the trigger weight, recoil characteristics and overall feel of your CZ.

Compatible with:

- CZ 75, CZ 75B
- CZ 85, CZ 85B
- CZ 75 SP-01, CZ 75 SP-01 Tactical
- CZ 75 SP-01 Shadow, CZ 75 SP-01 Shadow Orange
- CZ Shadow 2, CZ Shadow 2 Orange

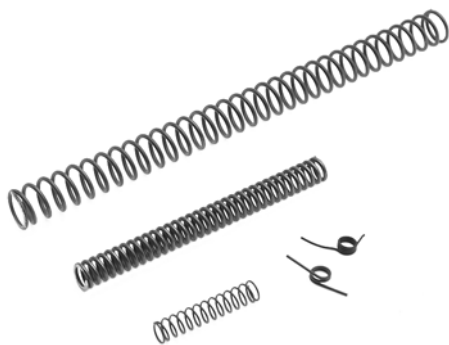

EEMANN TECH COMPETITION SPRINGS KIT FOR CZ 75 TACTICAL SPORT

Reference nr.

ET-131204

NEW

- ET-131141 - 1pc.
- ET-131119 - 1pc.
- ET-132118 - 1pc.
- ET-131156 - 1pc.
- ET-131113 - 1pc.

The Eemann Tech Competition Springs Kit for CZ 75 Tactical Sport has been specially made for IPSC and USPSA competitors. Use it if you wish to improve the trigger weight, recoil characteristics and overall feel of your CZ.

Compatible with:

- CZ 75 Tactical Sport
- CZ 75 Tactical Sport Orange

The Eemann Tech Progressive Recoil Spring for 1911/2011

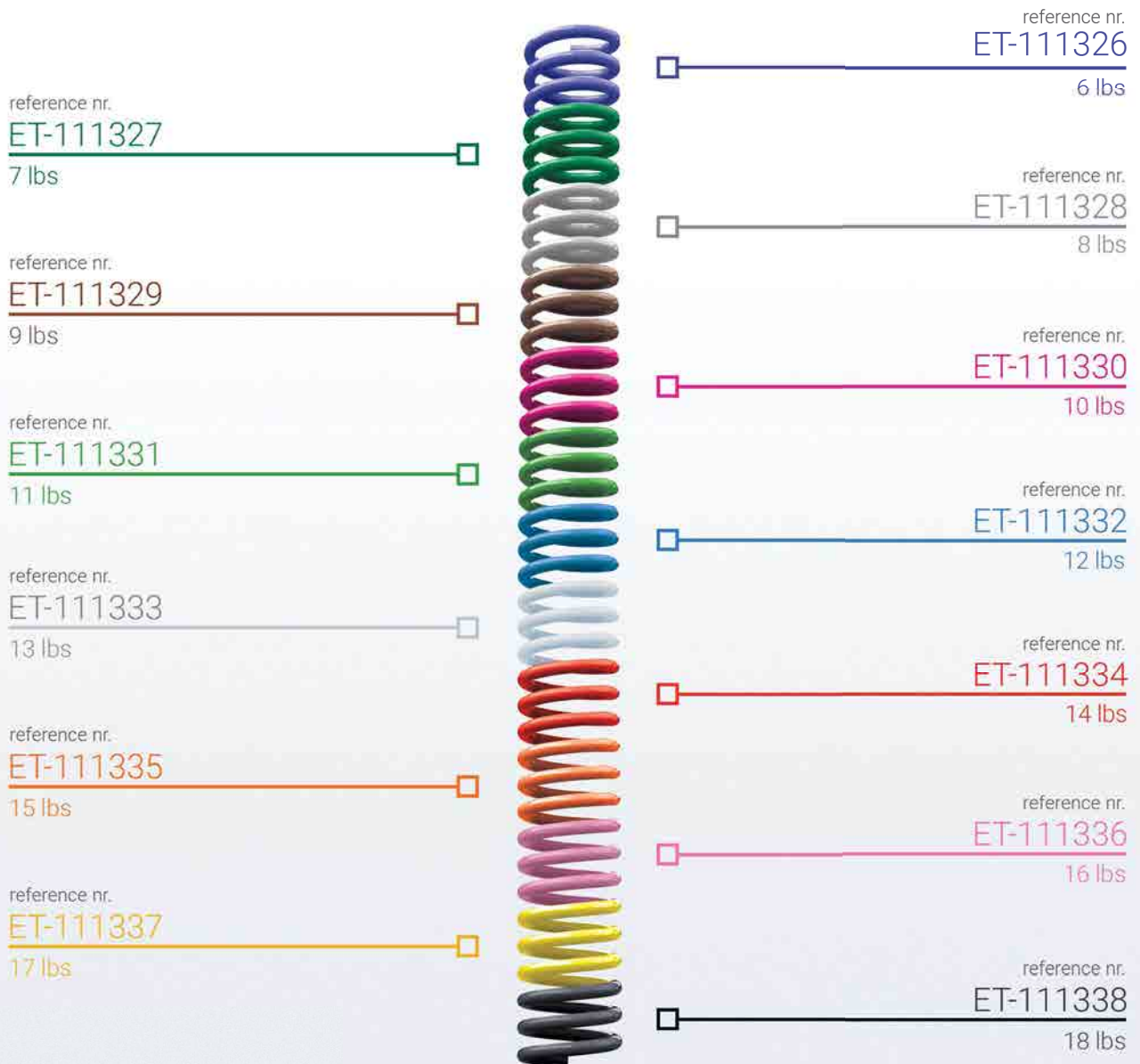

A **Wide Selection** For Every Preference



Eemann Tech Progressive Recoil Spring

The Eemann Tech Progressive Recoil Spring for 1911/2011 differs from the factory recoil spring in distance between coils. The progressive recoil springs coils are constantly reducing from the center to the end of the spring. The first part of the spring has standard factory coil gaps and is the strongest part.

The part with the “factory” coil gap starts compressing first and after the first coils impact the second part with “progressive” coil distance, they join together for faster recoil reducing to zero.

At the end of the compression cycle, the progressive recoil spring’s power is ~10% greater than the declared value. As a result, if you use a weaker spring, the springs capacity remains same. Every spring’s power value is indicated by a unique color, that allows identifying the spring’s original power at any moment of its life.

The Eemann Tech Progressive Recoil Springs are painted by a special polymer paint with thermal treatment, which remains elastic throughout the life of the spring. There are special calibration packs for different types of handguns / IPSC divisions. Every calibration pack contains 4 springs of different power, for more precise calibration of the handgun for individual types of ammunition.

For maximum efficiency, it is recommended to use the Eemann Tech Progressive Recoil Spring with Eemann Tech Recoil Buffer (Reference code: ET-303011).

The Eemann Tech Progressive Recoil Spring has power selection from 6-18 lbs. This variety of spring power values allows the use them with any type of handguns from OPEN division (6-7 lbs) to the Classic Major .45 caliber and factory ammunition with a light bullet (18 lbs).

When installing the Eemann Tech Progressive Recoil Spring, the strengthened part of the spring should be directed towards the chamber.

EEMANN
TECH

Quality. Experience.
Technology.

The Eemann Tech Progressive Recoil Spring for 1911/2011



Choose Your Spring **Color**

EEMANN TECH PROGRESSIVE RECOIL SPRING FOR 1911/2011

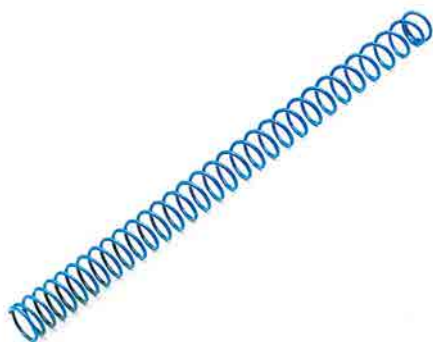

Reference nr. **Spring weight**

ET-111326	6 lbs
ET-111327	7 lbs
ET-111328	8 lbs
ET-111329	9 lbs
ET-111330	10 lbs
ET-111331	11 lbs
ET-111332	12 lbs
ET-111333	13 lbs
ET-111334	14 lbs
ET-111335	15 lbs
ET-111336	16 lbs
ET-111337	17 lbs
ET-111338	18 lbs

EEMANN TECH MAIN SPRING FOR 1911/2011



Reference nr. **Spring weight**

ET-111160	14 lbs
ET-111161	15 lbs
ET-111162	16 lbs
ET-111163	17 lbs
ET-111164	18 lbs

EEMANN TECH MAGAZINE CATCH SPRING FOR 1911/2011



Reference nr.

ET-111080

EEMANN TECH MAGAZINE CATCH SPRING LIGHT FOR 1911/2011*



Reference nr.

ET-111081

* -15% less from ET-111080

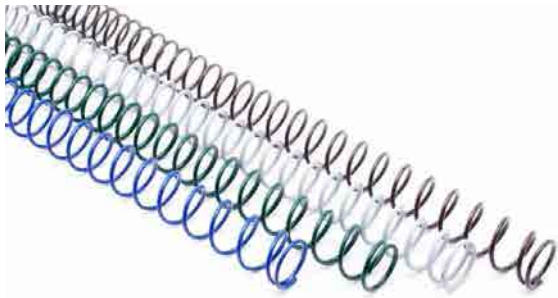

EEMANN TECH RECOIL SPRINGS CALIBRATION PACK "OPEN MAJOR" FOR 2011

Reference nr.

ET-119001

- ET-111326 6 lbs - 1 pc.
- ET-111327 7 lbs - 1 pc.
- ET-111328 8 lbs - 1 pc.
- ET-111329 9 lbs - 1 pc.

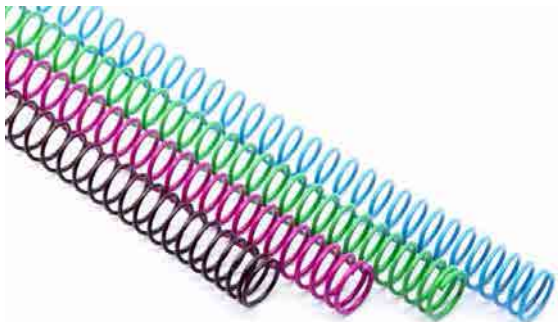

EEMANN TECH RECOIL SPRINGS CALIBRATION PACK "STANDARD/CLASSIC MINOR" FOR 1911/2011

Reference nr.

ET-119002

- ET-111329 9 lbs - 1 pc.
- ET-111330 10 lbs - 1 pc.
- ET-111331 11 lbs - 1 pc.
- ET-111332 12 lbs - 1 pc.

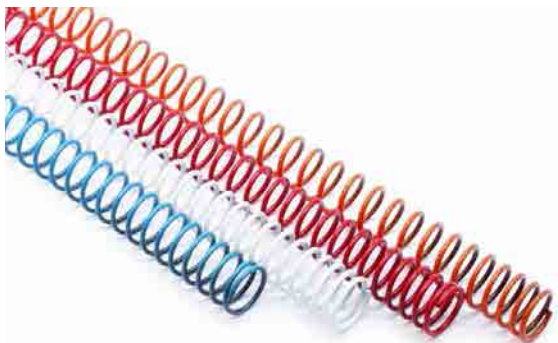

EEMANN TECH RECOIL SPRINGS CALIBRATION PACK "STANDARD MAJOR" FOR 2011

Reference nr.

ET-119003

- ET-111332 12 lbs - 1 pc.
- ET-111333 13 lbs - 1 pc.
- ET-111334 14 lbs - 1 pc.
- ET-111335 15 lbs - 1 pc.



EEMANN TECH RECOIL SPRINGS CALIBRATION PACK "CLASSIC MAJOR" FOR 1911

Reference nr.

ET-119004

- ET-111335 15 lbs - 1 pc.
- ET-111336 16 lbs - 1 pc.
- ET-111337 17 lbs - 1 pc.
- ET-111338 18 lbs - 1 pc.

EEMANN TECH RECOIL SPRING FOR 1911/2011

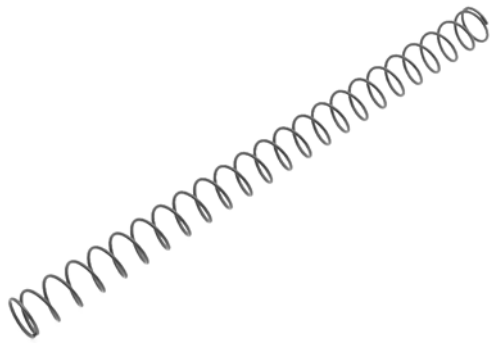

Reference nr.	Spring weight	
ET-114106	6 lbs	NEW
ET-114108	8 lbs	NEW
ET-114110	10 lbs	NEW
ET-114112	12 lbs	NEW
ET-114114	14 lbs	NEW
ET-114116	16 lbs	NEW
ET-114118	18 lbs	NEW
ET-114120	20 lbs	NEW
ET-114122	22 lbs	NEW
ET-114124	24 lbs	NEW



Eemmann Tech Recoil Spring for 1911/2011 5" barrel.
 Recoil springs are available in different power specifications
 for the recoil function to individual needs.
 Made of steel, with thermic treatment for the best performance and quality!



EEMANN TECH SAFETY LOCK PLUNGER
SPRING FOR 1911/2011

Reference nr.

ET-111110



EEMANN TECH SEAR SPRING FOR
1911/2011

Reference nr.

ET-111200



EEMANN TECH FIRING PIN SPRING FOR
1911/2011

Reference nr.

ET-111040



SPARE SPRING SET FOR EEMANN TECH
COMPETITION EXTRACTOR 1911/2011

Reference nr.

ET-111033



EEMANN TECH 120 MM STANDARD
MAGAZINE SPRING FOR 2011

Reference nr.

ET-111301



**EEMANN TECH 120 MM HIGH CAPACITY
MAGAZINE SPRING FOR 2011**

Reference nr.

ET-111302



**EEMANN TECH 140 MM STANDARD
MAGAZINE SPRING FOR 2011**

Reference nr.

ET-111303

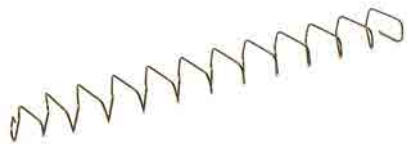

**EEMANN TECH 140 MM HIGH CAPACITY
MAGAZINE SPRING FOR 2011**

Reference nr.

ET-111304



**EEMANN TECH 170 MM STANDARD
MAGAZINE SPRING FOR 2011**

Reference nr.

ET-111305



**EEMANN TECH 170 MM HIGH CAPACITY
MAGAZINE SPRING FOR 2011**

Reference nr.

ET-111306



**EEMANN TECH SINGLE STACK MAGAZINE
SPRING FOR 1911**

Reference nr.

Caliber

ET-111550

.45AUTO

ET-111551

9x19mm



EEMANN TECH HAMMER SPRING FOR TANFOGLIO

Reference nr. **Spring weight**

ET-151432 12 lbs

ET-151433 13 lbs

ET-151430* 16 lbs

*Factory power



EEMANN TECH MAGAZINE SPRING FOR TANFOGLIO

Reference nr. **Caliber**

ET-151610 9x19mm

ET-151611 .40S&W



EEMANN TECH OPEN MAGAZINE SPRING 170 MM FOR TANFOGLIO, 13 COILS

Reference nr.

ET-151612



EEMANN TECH RECOIL SPRING FOR TANFOGLIO

Reference nr. **Caliber**

ET-151828 8 lbs

ET-151829 9 lbs

ET-151830 10 lbs

ET-151831 11 lbs

ET-151832 12 lbs

ET-151833 13 lbs

ET-151834 14 lbs

ET-151835 15 lbs

ET-151836 16 lbs

ET-151837 17 lbs



EEMANN TECH MAGAZINE CATCH SPRING FOR TANFOGLIO

Reference nr.

ET-151680



EEMANN TECH TRIGGER SPRING FOR
TANFOGLIO

Reference nr.

ET-151330



EEMANN TECH COMPETITION TRIGGER SPRING
(-15% POWER) FOR TANFOGLIO*

Reference nr.

ET-151331

*15% less from factory power



EEMANN TECH EXTRACTOR SPRING FOR
TANFOGLIO

Reference nr.

ET-151113



EEMANN TECH FIRING PIN SAFETY SPRING
FOR TANFOGLIO

Reference nr.

ET-151560



EEMANN TECH FIRING PIN SPRING FOR
TANFOGLIO

Reference nr.

ET-151530



EEMANN TECH SEAR SPRING FOR
TANFOGLIO

Reference nr.

ET-151930

EEMANN TECH COMPETITION FIRING PIN SPRING FOR GLOCK



Reference nr.	Spring weight	
ET-121021	2,5 lbs	NEW
ET-121024	3 lbs	NEW
ET-121003	4 lbs	NEW
ET-121025	5 lbs	NEW

EEMANN TECH COMPETITION FIRING PIN SAFETY SPRING FOR GLOCK*



Reference nr.
ET-121005

*10% less from factory power

EEMANN TECH RECOIL SPRING FOR GLOCK



Reference nr.	Spring weight
ET-121010	10 lbs
ET-121011	11 lbs
ET-121012	12 lbs
ET-121013	13 lbs
ET-121014	14 lbs
ET-121015	15 lbs
ET-121016	16 lbs

EEMANN TECH MAGAZINE SPRING FOR GLOCK MAGAZINE



Reference nr.	Rounds amount
ET-121007	17
ET-121008	17+2
ET-121009	15
ET-121017	33



EEMANN TECH COMPETITION SPRINGS KIT FOR GLOCK GEN5

Reference nr.

ET-121026

NEW

- ET-121003
- ET-121020
- ET-121005



EEMANN TECH COMPETITION SPRINGS KIT FOR GLOCK GEN3/4

Reference nr.

ET-121018

- ET-121003
- ET-121004
- ET-121005



EEMANN TECH COMPETITION TRIGGER SPRING FOR GLOCK GEN5*

Reference nr.

ET-121020

NEW

*10% more power from factory spring



EEMANN TECH COMPETITION TRIGGER SPRING FOR GLOCK GEN3/4*

Reference nr.

ET-121004

*10% more power from factory spring

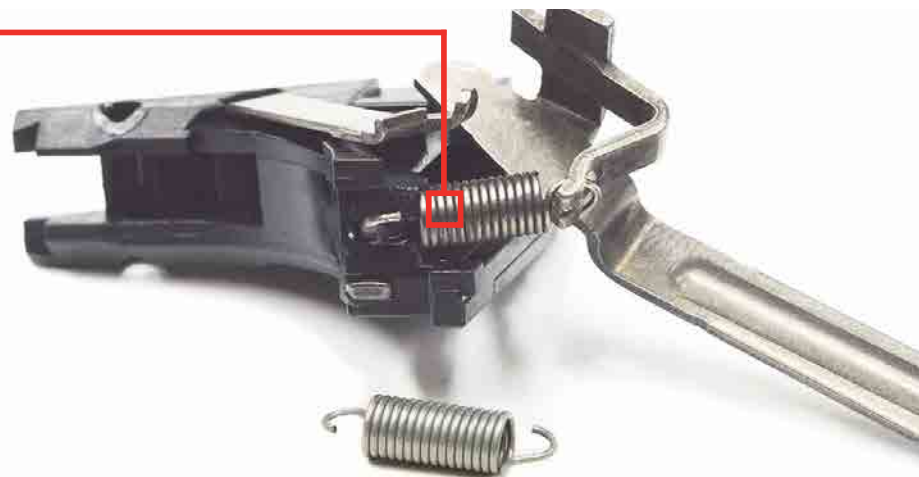



EEMANN TECH TRIGGER BAR SPRING FOR
SIG SAUER P226

Reference nr.

ET-141001



EEMANN TECH HAMMER RESET SPRING FOR
SIG SAUER P226

Reference nr.

ET-141002



EEMANN TECH SEAR SPRING FOR
SIG SAUER P226

Reference nr.

ET-141003



EEMANN TECH FIRING PIN SPRING FOR
SIG SAUER P226

Reference nr.

ET-141004



**EEMANN TECH FIRING PIN SPRING LIGHT
(-15% POWER) FOR SIG SAUER P226***

Reference nr.

ET-141005

*15% less from ET-141004 (factory power)



**EEMANN TECH MAIN SPRING FOR
SIG SAUER P226**

Reference nr.

Spring weight

ET-141006

13 lbs

ET-141007

14 lbs

ET-141008

15 lbs

ET-141009

16 lbs

ET-141010

17 lbs

ET-141011*

19 lbs

*Factory power

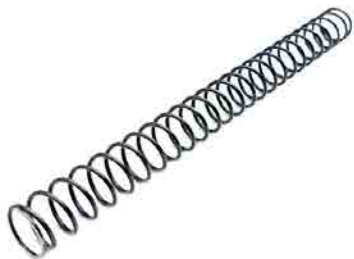

**EEMANN TECH RECOIL SPRING
FOR SIG SAUER P226**

Reference nr.

Spring weight

ET-141012

9 lbs

ET-141013

10 lbs

ET-141014

11 lbs

ET-141015

12 lbs

ET-141016*

13 lbs

*Factory power



EEMANN TECH RECOIL SPRING FOR SPRINGFIELD XDM (HS2000)

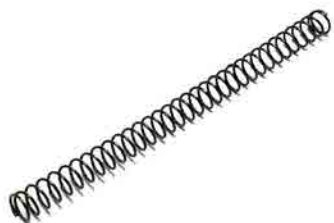

Reference nr. **Spring weight**

ET-161000	10 lbs
ET-161001	11 lbs
ET-161002	12 lbs
ET-161003	13 lbs
ET-161004*	14 lbs

*Factory power

EEMANN TECH RECOIL SPRING FOR SPHINX SDP STANDARD**



Reference nr. **Spring weight**

ET-171001	10 lbs
ET-171002	11 lbs
ET-171003	12 lbs
ET-171004	13 lbs
ET-171005*	14 lbs

*Factory power

**Does not fit SDP compact



EEMANN TECH MAIN SPRING FOR SPS



Reference nr. **Spring weight**

ET-111165	13 lbs
ET-111166*	16 lbs

*Factory power

EEMANN TECH

Quality. Experience.
Technology.

The Eemann Tech Competition Trigger Springs Kit for AR-15

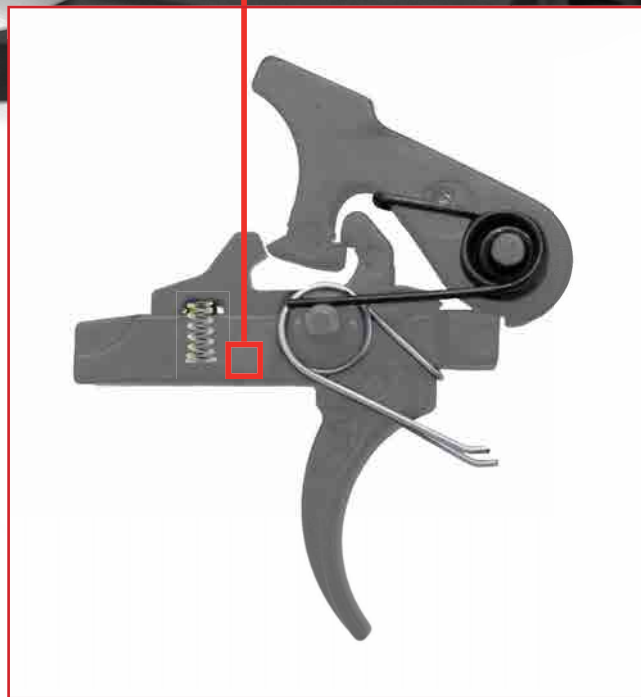

Customize Your Trigger



EEMANN TECH COMPETITION TRIGGER SPRINGS KIT FOR AR-15

Reference nr.

ET-180001



EEMANN TECH TACTICAL TRIGGER SPRINGS KIT FOR AR-15

Reference nr.

ET-180002



EEMANN TECH COMPETITION TRIGGER SPRING FOR AR-15*

Reference nr.

ET-180003

*10% less power from ET-180004



EEMANN TECH HAMMER SPRING FOR AR-15

Reference nr.

ET-180075

NEW



EEMANN TECH AR-15 LOWER SMALL PARTS SET

Reference nr.

ET-180005



EEMANN TECH SMALL SPRINGS SET FOR AR-15

Reference nr.

ET-180030

NEW

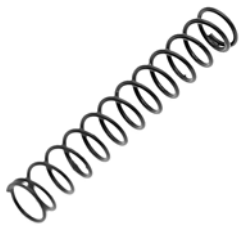

EEMANN TECH AR-15 RECOIL BUFFER RETAINER SPRING

Reference nr.

ET-180011

NEW



EEMANN TECH AR-15 MAGAZINE RELEASE SPRING

Reference nr.

ET-180012

NEW



EEMANN TECH AR-15 TAKEDOWN DETENT SPRING

Reference nr.

ET-180013

NEW



EEMANN TECH AR-15 SELECTOR DETENT SPRING

Reference nr.

ET-180014

NEW



EEMANN TECH AR-15 PIVOT DETENT SPRING

Reference nr.

ET-180015

NEW



EEMANN TECH AR-15 BOLT CATCH DETENT SPRING

Reference nr.

ET-180016

NEW



EEMANN TECH DISCONNECTOR SPRING FOR AR-15

Reference nr.

ET-180071

NEW

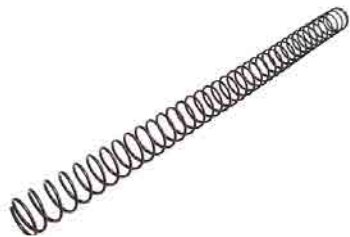

EEMANN TECH RECOIL BUFFER SPRING FOR AR-15

Reference nr.

ET-180006

NEW



EEMANN TECH EXTRACTOR SPRING FOR AR-15

Reference nr.

ET-180056

NEW



EEMANN TECH EJECTOR SPRING FOR AR-15

Reference nr.

ET-180052

NEW



**EEMANN TECH COMPETITION TRIGGER SPRINGS
KIT FOR AR-9 PCC**

Reference nr.

ET-180001



**EEMANN TECH COMPETITION TRIGGER SPRING
FOR AR-9 PCC***

Reference nr.

ET-180003

*10% less power from ET-180004



**EEMANN TECH SMALL SPRINGS SET
FOR AR-9 PCC**

Reference nr.

ET-180030

NEW

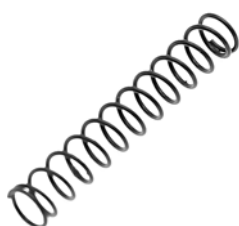

**EEMANN TECH AR-9 PCC RECOIL BUFFER
RETAINER SPRING**

Reference nr.

ET-180011

NEW



**EEMANN TECH AR-9 PCC MAGAZINE RELEASE
SPRING**

Reference nr.

ET-180012

NEW



EEMANN TECH AR-9 PCC TAKEDOWN DETENT SPRING

Reference nr.

ET-180013

NEW



EEMANN TECH AR-9 PCC SELECTOR DETENT SPRING

Reference nr.

ET-180014

NEW



EEMANN TECH AR-9 PCC PIVOT DETENT SPRING

Reference nr.

ET-180015

NEW



EEMANN TECH AR-9 PCC BOLT CATCH DETENT SPRING

Reference nr.

ET-180016

NEW



EEMANN TECH SPRINGS KIT FOR
MOLOT-VEPR 12GA

Reference nr.

ET-170012

NEW

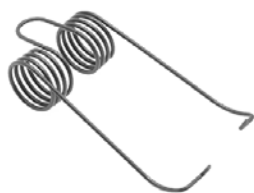

EEMANN TECH HAMMER SPRING FOR
MOLOT-VEPR 12GA

Reference nr.

ET-170554

NEW



EEMANN TECH EXTRACTOR SPRING FOR
MOLOT-VEPR 12GA

Reference nr.

ET-170060

NEW

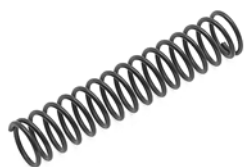

EEMANN TECH FIRING PIN SPRING FOR
MOLOT-VEPR 12GA

Reference nr.

ET-170061

NEW



EEMANN TECH MAGAZINE CATCH SPRING
FOR MOLOT-VEPR 12GA

Reference nr.

ET-170474

NEW



EEMANN TECH SLIDE LOCK SPRING FOR
MOLOT-VEPR 12GA

Reference nr.

ET-170388

NEW

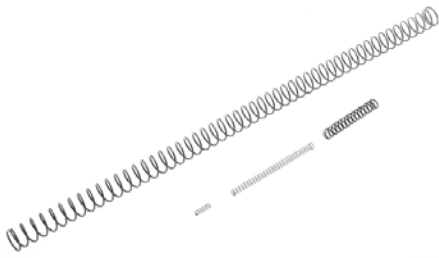

EEMANN TECH COMPETITION SPRINGS KIT FOR BENELLI

Reference nr.

ET-191001

NEW

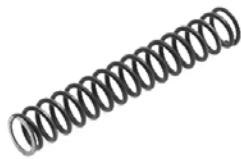

EEMANN TECH HAMMER SPRING FOR BENELLI

Reference nr.

ET-191002

NEW



EEMANN TECH TRIGGER SPRING FOR BENELLI

Reference nr.

ET-191003

NEW

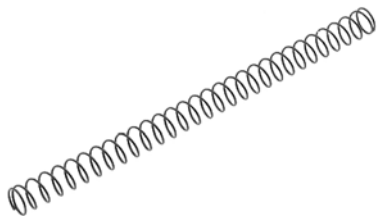

EEMANN TECH FIRING PIN SPRING FOR BENELLI

Reference nr.

ET-191004

NEW

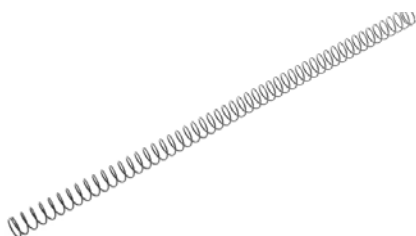

EEMANN TECH RECOIL SPRING FOR BENELLI

Reference nr.

ET-191005

NEW



EEMANN TECH SHOTGUN EXTENSION TUBE SPRING FOR 12GA

Reference nr.

ET-121212

NEW

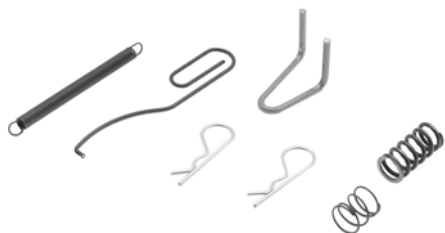

EEMANN TECH SPRINGS KIT FOR DILLON
RL550

Reference nr.

ET-520048

NEW



EEMANN TECH SLIDE RETURN SPRING 13928
FOR DILLON RL550

Reference nr.

ET-513928

NEW



EEMANN TECH CARTRIDGE SPRING 13926
FOR DILLON RL550

Reference nr.

ET-513926

NEW



EEMANN TECH EJECTOR WIRE 13925 FOR
DILLON RL550

Reference nr.

ET-513925

NEW



EEMANN TECH PRIMER CUP SPRING 14033
FOR DILLON XL550/XL650

Reference nr.

ET-514033

NEW



EEMANN TECH RETAINING CLIPS 10-PACK
FOR DILLON 14040 PICKUP TUBE

Reference nr.

ET-514040

NEW



EEMANN TECH SPRINGS KIT FOR DILLON
XL650/XL750

Reference nr.

ET-521146

NEW



EEMANN TECH EJECTOR WIRE 13298 FOR
DILLON XL650/XL750

Reference nr.

ET-513298

NEW



EEMANN TECH INDEXER RETURN SPRING
13791 FOR DILLON XL650/XL750

Reference nr.

ET-513791

NEW



EEMANN TECH LOCATOR TAB SPRING 13624
FOR DILLON XL650

Reference nr.

ET-513624

NEW



EEMANN TECH PAWL SPRING 13938 FOR
DILLON XL650/XL750

Reference nr.

ET-513938

NEW



EEMANN TECH DISC DETENT SPRING 13844
FOR DILLON XL650

Reference nr.

ET-513844

NEW



EEMANN TECH INDEX BALL SPRING 13997
FOR DILLON XL650/XL750

Reference nr.

ET-513997

NEW



EEMANN TECH INDEXING ARM SPRING
13965 FOR DILLON XL650

Reference nr.

ET-513965

NEW



EEMANN TECH CASEFEED ARM RETURN
SPRING 13936 FOR DILLON XL650/XL750

Reference nr.

ET-513936

NEW



EEMANN TECH CASE INSERT SLIDE SPRING
13937 FOR DILLON XL650/XL750

Reference nr.

ET-513937

NEW



EEMANN TECH PAWL SPRING 13938 FOR
DILLON XL650/XL750

Reference nr.

ET-513938

NEW



EEMANN TECH SPRINGS KIT FOR DILLON
RL1050

Reference nr.

ET-501050

NEW



EEMANN TECH PRIMER PUNCH SPRING
13858 FOR DILLON 1050

Reference nr.

ET-513858

NEW



EEMANN TECH TOOLHEAD SPRING 8,5"
12572 FOR DILLON RL1050*

Reference nr.

ET-512572

NEW

* for Dillon RL1050 machines produced since january 2016



EEMANN TECH TOOLHEAD SPRING 10,5"
12572 FOR DILLON RL1050*

Reference nr.

ET-512570

NEW

* for Dillon RL1050 machines produced after january 2016



EEMANN TECH DECAPPING PINS 10 PCS.
PACK FOR DILLON DIES

Reference nr.

ET-513753

NEW



EEMANN | GUN PARTS

TECH





PARTS

The EEMANN TECH Company produces standard and tuning parts for the most popular IPSC handguns, shotguns, and rifles amongst IPSC competitors: 1911/2011, CZ, GLOCK, Sig Sauer, Sphinx, AR15 and other firearm models and types.

We make spare parts of which the quality is excellent and exceeds the factory-made standard.

We pay special attention to the tuning parts. While developing parts we use the long-term experience of the best IPSC competitors around the world. All parts are made of high quality materials using modern and advanced technology.

Every competitor is able to customize their shooting equipment using the EEMANN TECH parts according to their needs and division. We have everything for making handguns meet the factory parameters using EEMANN TECH classic-line spare parts or make them highly customized by using the EEMANN TECH tuning-line parts.

We produce trigger mechanisms, enhanced slide stops and thumb safties; sport extended magazine catches, front and rear sights; main, trigger, sear and recoil springs, recoil spring guide rods and many other parts that are needed and wanted among the competitive shooters all over the World.

All parts are labeled and packed accordingly.

All EEMANN TECH parts are fully CNC-machined (MIM FREE).

EEMANN TECH

Quality. Experience.
Technology.

The Eemann Tech Extended Firing Pin for 1911/2011



Control Your **Speed**



EEMANN TECH FIRING PIN FOR 1911/2011

Reference nr.	Caliber	Color
ET-111050	9mm/.38S/.40S&W	Black
ET-112050	9mm/.38S/.40S&W	Silver



EEMANN TECH EXTENDED FIRING PIN FOR 1911/2011

Reference nr.	Caliber	Color
ET-112052	9mm/.38S/.40S&W	Silver



EEMANN TECH COMPETITION EXTRACTOR FOR 1911/2011

Reference nr.	Caliber	Color
ET-111034	9mm/.40S&W	Black



SPARE SPRING CAP FOR EEMANN TECH COMPETITION EXTRACTOR 1911/2011

Reference nr.
ET-111035



EEMANN TECH EXTRACTOR FOR 1911/2011

Reference nr.	Caliber	Color
ET-111030	9mm/.40S&W	Black
ET-111031	.45auto	Black
ET-111032	.45auto 80 Series	Black



EEMANN TECH MAGAZINE CATCH PLAIN FOR 1911*

Reference nr. **Color**

ET-111090 Black

ET-111091 Silver

*Catch lock and catch spring not included



EEMANN TECH MAGAZINE CATCH WITH EXTENDED BUTTON FOR 1911*

Reference nr. **Color**

ET-111092 Black

ET-111093 Silver

*Catch lock and catch spring not included



EEMANN TECH MAGAZINE CATCH PLAIN FOR 2011*

Reference nr. **Color**

ET-111094 Black

ET-111095 Silver

*Catch lock and catch spring not included



EEMANN TECH MAGAZINE CATCH WITH EXTENDED BUTTON FOR 2011*

Reference nr. **Color**

ET-111096 Black

ET-111097 Silver

*Catch lock and catch spring not included



EEMANN TECH MAGAZINE CATCH LOCK FOR 1911/2011

Reference nr. **Color**

ET-111070 Black

ET-111071 Silver



EEMANN TECH EXTENDED SLIDE STOP FOR 1911*

Reference nr.	Color
ET-211291	Black

* For calibers 9x19mm, .45



EEMANN TECH SOLID SLIDE STOP FOR 1911/2011*

Reference nr.	Color
ET-211290	Black
ET-212290	Silver

* For calibers 9x19mm, .40S&W, .45



EEMANN TECH SLIDE STOP PLUNGER FOR 1911/2011

Reference nr.	Color
ET-111100	Black
ET-112100	Silver

NEW



EEMANN TECH SAFETY LOCK PLUNGER FOR 1911/2011

Reference nr.	Color
ET-111120	Black
ET-112120	Silver

NEW



EEMANN TECH PLUNGER TUBE FOR 1911/2011

Reference nr.	Color
ET-111440	Black

EEMANN TECH

Quality. Experience.
Technology.

The Eemann Tech Thumb Rest Slide Stop For 1911/2011

Reference nr. ET-212292

Eemann Tech Thumb Rest Slide Stop For Colt 1911, 2011 and clones.

Material: Stainless Steel

Caliber: All

All the EEMANN TECH parts for Colt 1911, STI 2011 and their clones are made from high quality carbon, alloyed or stainless steel using technologies and CNC machines of new generation.



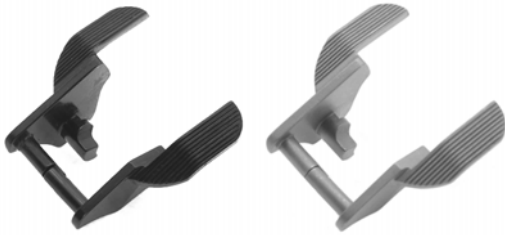

EEMANN TECH SOLID SAFETY FOR 1911/2011

Reference nr.	Color
ET-111260	Black
ET-111261	Silver



EEMANN TECH SOLID COMBAT SINGLE SAFETY FOR 1911

Reference nr.	Color
ET-111262	Black
ET-111263	Silver

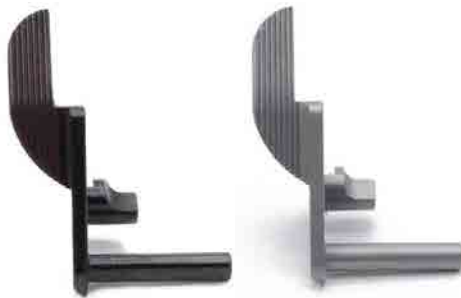

EEMANN TECH SOLID WIDE SINGLE SAFETY FOR 1911

Reference nr.	Color
ET-111264	Black
ET-111265	Silver



EEMANN TECH SOLID COMBAT SAFETY FOR 1911/2011

Reference nr.	Color
ET-111266	Black
ET-111267	Silver



EEMANN TECH COMPETITION THUMB SAFETY WITH SHIELD FOR 1911/2011

Reference nr.
ET-211929



EEMANN TECH TRIGGER FOR 2011

Reference nr.	Color	
ET-111196	Black	NEW
ET-111197	Silver	NEW

Trigger full length: 56,5mm



EEMANN TECH TRIGGER FOR 1911

Reference nr.	Color	
ET-111140	Black	
ET-111143	Silver	

Trigger full length: 56,5mm



EEMANN TECH K-HOLE TRIGGER FOR 1911

Reference nr.	Color	
ET-111141	Black	
ET-111142	Silver	

Trigger full length: 56,7mm



EEMANN TECH SOLID TRIGGER FOR 2011

Reference nr.	Color	
ET-111145	Silver	

Trigger full length: 51,2mm



EEMANN TECH SOLID TRIGGER LONG FOR 2011

Reference nr.	Color	
ET-111147	Silver	

Trigger full length: 56,6mm

EEMANN TECH K-HOLE FLAT TRIGGER FOR 2011

Reference nr.	Color	
ET-111149	Silver	NEW

Trigger full length: 57,8mm

EEMANN TECH TWO PIECES MAGWELL FOR 1911, 25LPI CHECKERED

Reference nr.	Color	Height
ET-111180	Black	47,2 mm
ET-111181	Silver	47,2 mm

Magwell size: 32x48x5mm

EEMANN TECH MAINSPRING HOUSING FOR 1911, 25LPI CHECKERED, FLAT*

Reference nr.	Color	Height
ET-111192	Black	48,6 mm
ET-111191	Silver	48,6 mm

*For installation without magwell



EEMANN TECH

Quality. Experience.
Technology.

The Eemann Tech Front Sight for 1911/2011, Checkered with 1mm Fiber Optics Rod

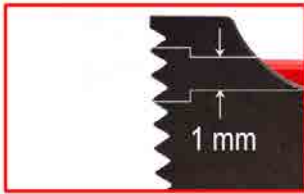

- Serrated surface (none-glare properties)
- Additional space for fiber rod installation
- Fiber rod diameter 1 mm or 1.5 mm



- Longer fiber optics rod
- More light absorption
- Ultra bright sight view

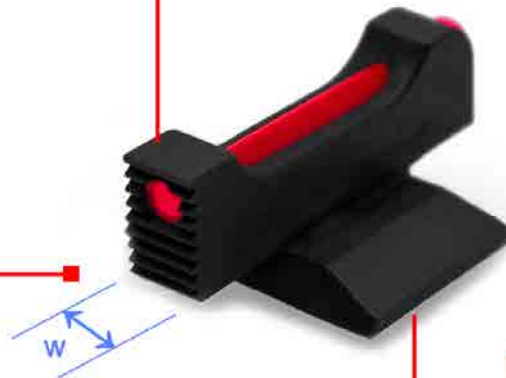

- Width: .160" (4.10 mm) - .180" (4.60 mm)
- Height: .090" (2.23 mm) - .125" (3.20 mm)

Dovetail size:

- Length: .300" (7.6 mm)
- Width: .0394" (10.0 mm)
- Base height: .0063" (1.6 mm)
- Angle: 60°

Perfection in Every Detail

EEMANN TECH FRONT SIGHT FOR 1911/2011, CHECKERED, STEEL



Reference nr.	Height	Width
ET-130400	.180" (4.60mm)	.125" (3.20mm)
ET-130401	.180" (4.60mm)	.110" (2.80mm)
ET-130402	.180" (4.60mm)	.100" (2.56mm)
ET-130403	.180" (4.60mm)	.090" (2.23mm)
ET-130404	.160" (4.10mm)	.125" (3.20mm)
ET-130405	.160" (4.10mm)	.110" (2.80mm)
ET-130406	.160" (4.10mm)	.100" (2.56mm)
ET-130407	.160" (4.10mm)	.090" (2.23mm)

EEMANN TECH FRONT SIGHT FOR 1911/2011, CHECKERED WITH 1MM FIBER OPTICS ROD



Reference nr.	Height x Width
ET-130408	.180" (4.60mm) .125" (3.20mm)
ET-130409	.180" (4.60mm) .110" (2.80mm)
ET-130410	.180" (4.60mm) .100" (2.56mm)
ET-130411	.180" (4.60mm) .090" (2.23mm)
ET-130412	.160" (4.10mm) .125" (3.20mm)
ET-130413	.160" (4.10mm) .110" (2.80mm)
ET-130414	.160" (4.10mm) .100" (2.56mm)
ET-130415	.160" (4.10mm) .090" (2.23mm)

EEMANN TECH FRONT SIGHT FOR 1911/2011, CHECKERED WITH 1,5MM FIBER OPTICS ROD



Reference nr.	Height x Width
ET-130416	.180" (4.60mm) .125" (3.20mm)
ET-130417	.180" (4.60mm) .110" (2.80mm)
ET-130418	.180" (4.60mm) .100" (2.56mm)
ET-130419	.160" (4.10mm) .125" (3.20mm)
ET-130420	.160" (4.10mm) .110" (2.80mm)
ET-130421	.160" (4.10mm) .100" (2.56mm)



EEMANN TECH ADJUSTABLE REAR SIGHT BOMAR FOR 1911/2011

Reference nr.
ET-111600



EEMANN TECH FRONT SIGHT "NOVAK TYPE"
0.330 1,5MM FIBER OPTICS ROD FOR 1911/2011

Reference nr.

ET-130801

NEW



EEMANN TECH FRONT SIGHT "NOVAK TYPE"
0.330 1MM FIBER OPTICS ROD FOR 1911/2011

Reference nr.

ET-130802

NEW



EEMANN TECH ADJUSTABLE REAR SIGHT
"NOVAK TYPE" FOR 1911/2011

Reference nr.

ET-130700

NEW



EEMANN TECH ADJUSTABLE REAR SIGHT WITH
FIBER OPTICS "NOVAK TYPE" FOR 1911/2011

Reference nr.

ET-130800

NEW

EEMANN TECH MAINSPRING HOUSING PIN FOR 1911

Reference nr.	Color
ET-111220	Black
ET-112220	Silver

NEW

EEMANN TECH MAINSPRING CAP FOR 1911/2011

Reference nr.	Color
EE-111150	Black
ET-112150	Silver

NEW

EEMANN TECH MAINSPRING HOUSING PIN RETAINER FOR 1911/2011

Reference nr.	Color
ET-111170	Black
ET-112170	Silver

NEW

EEMANN TECH SPARE SCREW FOR 1911/2011 TWO PIECES MAGWELL

Reference nr.	Color
ET-111186*	Black
ET-111183**	Silver

* for ET-111180, ET-111187

** for ET-111181, ET-111188

EEMANN TECH GRIP SCREW BUSHING FOR 1911

Reference nr.	Height	Color
ET-111250	4,0 mm	Black
ET-111251	4,0 mm	Silver
ET-111252	6,9 mm	Black
ET-111253	6,9 mm	Silver



**EEMANN TECH MAINSPRING CAP PIN
FOR 1911/2011**

Reference nr.	Color
ET-111190	Black
ET-112190	Silver NEW



**EEMANN TECH HAMMER PIN
FOR 1911/2011**

Reference nr.	Color
ET-111270	Black
ET-112270	Silver NEW



**EEMANN TECH HAMMER STRUT PIN
FOR 1911/2011**

Reference nr.	Color
ET-111420	Black
ET-112420	Silver NEW



EEMANN TECH BARREL LINK PIN FOR 1911/2011

Reference nr.	Color
ET-111360	Black
ET-112360	Silver NEW



EEMANN TECH SEAR PIN FOR 1911/2011

Reference nr.	Color
ET-111280	Black
ET-112280	Silver NEW



**EEMANN TECH HAMMER STRUT
FOR 1911/2011**

Reference nr.	Color
ET-111410	Black



EEMANN TECH GRIP SCREW HEX FOR 1911, LONG

Reference nr.	Color
ET-111240	Black
ET-112240	Silver



EEMANN TECH GRIP SCREW FLAT FOR 1911, LONG

Reference nr.	Color
ET-111241	Black
ET-112241	Silver



EEMANN TECH GRIP SCREW HEX+FLAT FOR 1911, LONG

Reference nr.	Color
ET-111242	Black
ET-112242	Silver



EEMANN TECH GRIP SCREW HEX FOR 1911, SHORT

Reference nr.	Color
ET-111243	Black
ET-112243	Silver



EEMANN TECH GRIP SCREW FLAT FOR 1911, SHORT

Reference nr.	Color
ET-111244	Black
ET-112244	Silver



EEMANN TECH GRIP SCREW HEX+FLAT FOR 1911, SHORT

Reference nr.	Color
ET-111245	Black
ET-112245	Silver



**EEMANN TECH DEMON HAMMER
FOR 1911/2011**

Reference nr.	Color
ET-111400	Silver



**EEMANN TECH PREMIUM MATCH HAMMER
FOR 1911/2011**

Reference nr.	Color
ET-111401	Silver



**EEMANN TECH COMMANDER HAMMER
FOR 1911/2011**

Reference nr.	Color
ET-111402	Silver



**EEMANN TECH PRO HAMMER FOR
1911/2011**

Reference nr.	Color
ET-111403	Silver



**EEMANN TECH ULTRA LIGHT COMPETITION
HAMMER FOR 1911/2011**

Reference nr.	Color
ET-111404	Silver



EEMANN TECH RECOIL SPRING GUIDE ROD FOR 1911/2011

Reference nr.	Barrel Length	
ET-111311	4.0"	NEW
ET-111310	5.0"	NEW
ET-111312	6.0"	NEW



EEMANN TECH COMPETITION GUIDE ROD TOOLLESS FOR 1911/2011*

Reference nr.
ET-110001

*Recoil Spring is not included



EEMANN TECH COMPETITION SEAR FOR 1911/2011

Reference nr.	Material
ET-112390	Stainless Steel
ET-111390	Steel



9x19 mm

.40S&W

.45auto

EEMANN TECH EJECTOR FOR 1911/2011

Reference nr.	Caliber
ET-111450	9x19 mm
ET-111451	.40S&W
ET-111452	.45auto



EEMANN TECH PINS SET FOR 1911

Reference nr.	Color	
ET-111601	Black	
ET-111602	Silver	NEW



EEMANN TECH BARREL BUSHING FOR 1911

Reference nr.	Length	Color
ET-111340	21,1 mm	Silver
ET-111341	12,8 mm	Silver
ET-111342	21,1 mm	Black
ET-111343	12,8 mm	Black



THE EEMANN TECH RECOIL SPRING PLUG BUSHING BARREL FOR 1911/2011

Reference nr.	Color
ET-111316	Black
ET-111317	Silver



EEMANN TECH BARREL LINK FOR 1911/2011

Reference nr.	Size
ET-111371	#1
ET-111372	#2
ET-111373	#3
ET-111374	#4
ET-111375	#5



EEMANN TECH DISCONNECTOR FOR 1911/2011

Reference nr.	Color
ET-111380	Black



**EEMANN TECH COMPETITION BUFFERS
5 PCS. SET FOR 1911/2011**

Reference nr.
ET-303011



EEMANN TECH EJECTOR PIN FOR 1911/2011

Reference nr.	Color
ET-111460	Black
ET-112460	Silver

Diameter: 0,05" (1,5mm) NEW



EEMANN TECH MAINSPRING HOUSING FLAT FOR 2011, CHECKERED 25 LPI

Reference nr.	Color
ET-111184	Black
ET-111185	Silver



EEMANN TECH MAGWELL FOR 2011

Reference nr.	Color
ET-211180	Black
ET-212180	Silver



EEMANN TECH ALUMINIUM MAGWELL FOR 2011

Reference nr.	Color
ET-213180	Black



EEMANN TECH MAINSPRING HOUSING PIN FOR 2011

Reference nr.	Color
ET-212220	Silver
ET-211220	Black

The Eemann Tech Front Sight for CZ 75, Checkered with 1mm Fiber Optics Rod



Sight Your Picture

**EEMANN TECH CZ 75 FRONT SIGHT,
CHECKERED, STEEL**

Reference nr.	Height	Width
ET-130100	5,50 mm	3,00 mm
ET-130101	6,00 mm	3,00 mm
ET-130102	6,50 mm	3,00 mm
ET-130103	7,00 mm	3,00 mm
ET-130104	7,50 mm	3,00 mm
ET-130105	8,00 mm	3,00 mm

**EEMANN TECH FRONT SIGHT FOR CZ 75,
CHECKERED WITH 1MM FIBER OPTICS ROD**

Reference nr.	Height	Width
ET-130200	5,00 mm	2,70 mm
ET-130201	5,00 mm	3,00 mm
ET-130202	5,25 mm	2,70 mm
ET-130203	5,25 mm	3,00 mm
ET-130204	5,50 mm	2,70 mm
ET-130205	5,50 mm	3,00 mm
ET-130206	5,75 mm	2,70 mm
ET-130207	5,75 mm	3,00 mm
ET-130208	6,00 mm	2,70 mm
ET-130209	6,00 mm	3,00 mm
ET-130210	6,25 mm	2,70 mm
ET-130211	6,25 mm	3,00 mm
ET-130212	6,50 mm	2,70 mm
ET-130213	6,50 mm	3,00 mm
ET-130214	6,75 mm	2,70 mm
ET-130215	6,75 mm	3,00 mm
ET-130216	7,00 mm	2,70 mm
ET-130217	7,00 mm	3,00 mm
ET-130218	7,25 mm	2,70 mm
ET-130219	7,25 mm	3,00 mm
ET-130220	7,50 mm	2,70 mm
ET-130221	7,50 mm	3,00 mm
ET-130222	7,75 mm	2,70 mm
ET-130223	7,75 mm	3,00 mm
ET-130224	8,00 mm	2,70 mm
ET-130225	8,00 mm	3,00 mm
ET-130226	9,50 mm	3,00 mm

NEW



EEMANN TECH FRONT SIGHT FOR CZ 75, CZ SHAWOD 2 CHECKERED WITH 1,5 MM FIBER OPTICS ROD

Reference nr.	Height	Width
ET-130300	5,00 mm	2,70 mm
ET-130301	5,00 mm	3,00 mm
ET-130302	5,25 mm	2,70 mm
ET-130303	5,25 mm	3,00 mm
ET-130304	5,50 mm	2,70 mm
ET-130305	5,50 mm	3,00 mm
ET-130306	5,75 mm	2,70 mm
ET-130307	5,75 mm	3,00 mm
ET-130308	6,00 mm	2,70 mm
ET-130309	6,00 mm	3,00 mm
ET-130310	6,25 mm	2,70 mm
ET-130311	6,25 mm	3,00 mm
ET-130312	6,50 mm	2,70 mm
ET-130313	6,50 mm	3,00 mm
ET-130314	6,75 mm	2,70 mm
ET-130315	6,75 mm	3,00 mm
ET-130316	7,00 mm	2,70 mm
ET-130317	7,00 mm	3,00 mm
ET-130318	7,25 mm	2,70 mm
ET-130319	7,25 mm	3,00 mm
ET-130320	7,50 mm	2,70 mm
ET-130321	7,50 mm	3,00 mm
ET-130322	7,75 mm	2,70 mm
ET-130323	7,75 mm	3,00 mm
ET-130324	8,00 mm	2,70 mm
ET-130325	8,00 mm	3,00 mm





EEMANN TECH FRONT SIGHT FOR CZ 75,
CHECKERED, WITH 1MM FIBER OPTICS ROD

Reference nr.	Height	Width	
ET-130226	9,50 mm	3,00 mm	NEW



EEMANN TECH ADJUSTABLE REAR SIGHT FOR
CZ 75

Reference nr.	
ET-130500	NEW



EEMANN TECH ADJUSTABLE REAR SIGHT WITH
FIBER OPTICS FOR CZ 75

Reference nr.	
ET-130600	NEW



EEMANN TECH COMPETITION FRONT SIGHT FOR
CZ P-10

Reference nr.	
ET-130071	NEW



EEMANN TECH ADJUSTABLE SIGHTS SET FOR
CZ P-10

Reference nr.	
ET-130070	NEW



EEMANN TECH ADJUSTABLE REAR SIGHT
FOR CZ SP-01 SHADOW

Reference nr.

ET-130008



EEMANN TECH ADJUSTABLE REAR SIGHT WITH
FIBER OPTICS FOR CZ SP-01 SHADOW

Reference nr.

ET-012025



EEMANN TECH ADJUSTABLE REAR SIGHT
FOR CZ 75 TS

Reference nr.

ET-130030



EEMANN TECH ADJUSTABLE REAR SIGHT WITH
FIBER OPTICS FOR CZ 75 TS

Reference nr.

ET-130031

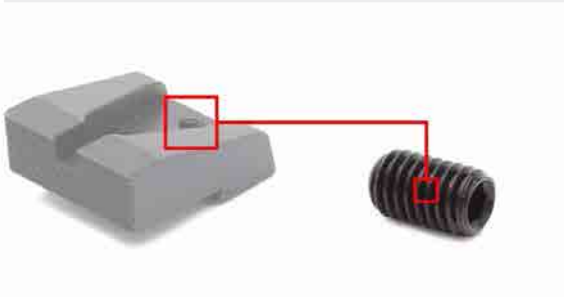

EEMANN TECH EXTENDED SCREW FOR CZ 75
SP-01 OEM REAR FIXED SIGHT

Reference nr.

ET-012024



The Eemann Tech Trigger For CZ 75 (Single Action Only)

BACK-SHIFTED

STRAIGHT

HOOKED

FRONT-SHIFTED

EXTRA FRONT-SHIFTED

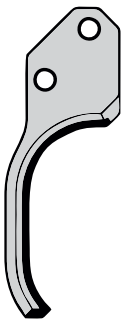

BLUE



RED



GREEN



BLACK



SILVER



GOLD

EEMANN TECH TRIGGER FOR CZ 75, STRAIGHT



Reference nr.	Height	Type
ET-012101	Blue	Smooth
ET-012102	Green	Smooth
ET-012103	Red	Smooth
ET-012104	Black	Smooth
ET-012105	Silver	Smooth
ET-012106	Gold	Smooth



Reference nr.	Height	Type
ET-012108	Blue	Serrated
ET-012109	Green	Serrated
ET-012110	Red	Serrated
ET-012111	Black	Serrated
ET-012112	Silver	Serrated
ET-012113	Gold	Serrated

EEMANN TECH TRIGGER FOR CZ 75, HOOKED



Reference nr.	Height	Type
ET-012115	Blue	Smooth
ET-012116	Green	Smooth
ET-012117	Red	Smooth
ET-012118	Black	Smooth
ET-012119	Silver	Smooth
ET-012120	Gold	Smooth



Reference nr.	Height	Type
ET-012122	Blue	Serrated
ET-012123	Green	Serrated
ET-012124	Red	Serrated
ET-012125	Black	Serrated
ET-012126	Silver	Serrated
ET-012127	Gold	Serrated

**EEMANN TECH TRIGGER FOR CZ 75,
BACK-SHIFTED**

Reference nr.	Height	Type
ET-012143	Blue	Smooth
ET-012144	Green	Smooth
ET-012145	Red	Smooth
ET-012146	Black	Smooth
ET-012147	Silver	Smooth
ET-012148	Gold	Smooth



Reference nr.	Height	Type
ET-012150	Blue	Serrated
ET-012151	Green	Serrated
ET-012152	Red	Serrated
ET-012153	Black	Serrated
ET-012154	Silver	Serrated
ET-012155	Gold	Serrated

**EEMANN TECH TRIGGER FOR CZ 75,
FRONT-SHIFTED**

Reference nr.	Height	Type
ET-012129	Blue	Smooth
ET-012130	Green	Smooth
ET-012131	Red	Smooth
ET-012132	Black	Smooth
ET-012133	Silver	Smooth
ET-012134	Gold	Smooth



Reference nr.	Height	Type
ET-012136	Blue	Serrated
ET-012137	Green	Serrated
ET-012138	Red	Serrated
ET-012139	Black	Serrated
ET-012140	Silver	Serrated
ET-012141	Gold	Serrated

**EEMANN TECH TRIGGER FOR CZ 75,
EXTRA FRONT-SHIFTED**



Reference nr.	Height	Type
ET-012157	Blue	Smooth
ET-012158	Green	Smooth
ET-012159	Red	Smooth
ET-012160	Black	Smooth
ET-012161	Silver	Smooth
ET-012162	Gold	Smooth



Reference nr.	Height	Type
ET-012164	Blue	Serrated
ET-012165	Green	Serrated
ET-012166	Red	Serrated
ET-012167	Black	Serrated
ET-012168	Silver	Serrated
ET-012169	Gold	Serrated



Be Fast To Be **First**

**EEMANN TECH COMPETITION HAMMER
FOR CZ 75, SA/DA**

Reference nr.	Color
ET-130001	Black

**EEMANN TECH MATCH HAMMER FOR CZ 75,
SA/DA**

Reference nr.	Color
ET-130003	Black

**EEMANN TECH ULTRA LIGHT HAMMER FOR
CZ 75, SA/DA**

Reference nr.	Color
ET-130035	Black





EEMANN TECH COMPETITION DISCONNECTOR FOR CZ SHADOW

Reference nr.

ET-130044

NEW

The Eemann Tech Competition Disconnecter will ensure a short trigger reset without any additional modifications for your gun. It delivers the minimum pre travel at the moment of Single Action reset. Since this is a part of the trigger group - it should be legal for IPSC and USPSA Production division (Check your IPSC/USPSA rule book).

**NOT FOR PISTOLS WITH FIRING PIN BLOCKS!
ONLY FOR EXPERT SHOOTERS!**

Fits:

- CZ 75 SP-01 (without firing pin block models)
- CZ 75 SP-01 Shadow models
- CZ Shadow 2

The set includes:

- Eemann Tech Competition Disconnecter: 1 pc.
- CZ 75 Hammer Pin: 1 pc.

Material: Steel



CZ Shadow 2

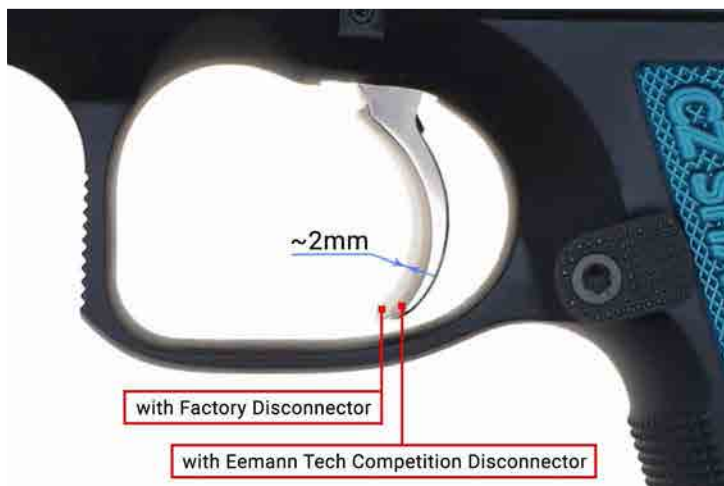

CZ 75 SP-01 Shadow

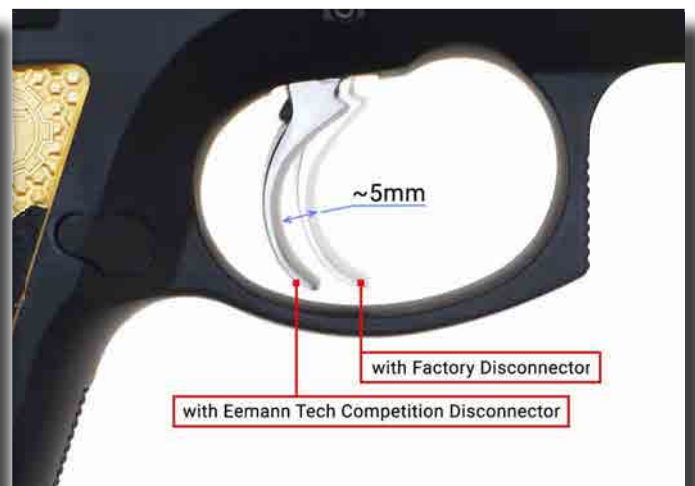

EEMANN TECH

Quality. Experience.
Technology.

The Eemann Tech Standard Base Pad for CZ 75, CZ 75 SP-01, CZ Shadow 2



IPSC Standard box size : 225 mm x 150 mm x 45 mm

When Size Does **Matter**

**EEMANN TECH STANDARD BASE PAD FOR
CZ 75, CZ 75 SP-01, CZ SHADOW 2 - BLACK***
Reference nr.
ET-130016

*Works with magwell

**EEMANN TECH STANDARD BASE PAD FOR
CZ 75, CZ 75 SP-01, CZ SHADOW 2 - SILVER***
Reference nr.
ET-130032

*Works with magwell

**EEMANN TECH BRASS BASE PAD FOR
CZ SHADOW 2***
Reference nr.
ET-130045

*Works with magwell

Material
Brass

**EEMANN TECH COMPETITION BUFFERS
5 PCS. SET**
Reference nr.
ET-303013
ET-303014
ET-303017
Pistol Model
CZ 75, CZ 75 SP-01 Shadow
CZ 75 TS
CZ Shadow 2



EEMANN TECH FULL LENGTH GUIDE ROD FOR CZ 75

Reference nr.	Color
ET-130005	Black



EEMANN TECH STEEL SHORT GUIDE ROD FOR CZ 75/85 (WITHOUT HOLE INSIDE)

Reference nr.	Color
ET-130006	Black



EEMANN TECH STEEL SHORT GUIDE ROD FOR CZ 75 TS

Reference nr.	Color
ET-130007	Black



EEMANN TECH GUIDE ROD FOR CZ SHADOW 2

Reference nr.	Color
ET-303016	Silver



EEMANN TECH GUIDE ROD FOR CZ 75 SP-01 SHADOW, NEW DESIGN

Reference nr.	Color
ET-130024	Silver



EEMANN TECH PIN FOR CZ 75

Reference nr.	Color
ET-130038	Silver

EEMANN TECH

Quality. Experience.
Technology.

The Eemann Tech RIGHT Hand Safety for CZ 75 TS, CZ Shadow 2



The Eemann Tech Double-sided Extended Safety for CZ Shadow 2 and CZ 75 Tactical Sports. It also works as a support for the thumb. This type of safety improves the grip and recoil control. It has been produced in accordance with IPSC rules for Standard division for left and right handed shooters, and for Open Division where both levers are the same.

For the following pistols:

- CZ 75 Tactical Sports
- CZ 75 TS Orange
- CZ 75 TS Czechmate
- CZ Shadow 2



EEMANN TECH RIGHT HAND SAFETY SMALL
SIZE FOR CZ 75 TS, CZ SHADOW 2

Reference nr.	Color
ET-130012	Black



EEMANN TECH RIGHT HAND SAFETY MEDIUM
SIZE FOR CZ 75 TS, CZ SHADOW 2

Reference nr.	Color
ET-130013	Black



EEMANN TECH RIGHT HAND SAFETY LARGE
SIZE FOR CZ 75 TS, CZ SHADOW 2

Reference nr.	Color
ET-130033	Black





EEMANN TECH BRASS LONG GRIPS FOR CZ 75, CZ 75 TS, CZ SHADOW 2*

Reference nr.	Size	Thickness
ET-130018	Small	0,8 mm
ET-130019	Medium	1,8 mm
ET-130020	Large	2,8 mm
ET-130021	Extra Large	3,8 mm

*For using without Magwell!



EEMANN TECH BRASS SHORT GRIPS FOR CZ 75, CZ 75 TS, CZ SHADOW 2*

Reference nr.	Size	Thickness
ET-130026	Small	0,8 mm
ET-130027	Medium	1,8 mm
ET-130028	Large	2,8 mm
ET-130029	Extra Large	3,8 mm

*For using with Magwell!



EEMANN TECH GRIP TAPE SET FOR CZ

Reference nr.	Color
ET-130022	Black





**EEMANN TECH BRASS MAGWELL FOR
CZ SHADOW 2**

Reference nr. **Material**

ET-130043 Brass



**EEMANN TECH BRASS MAGWELL FOR
CZ 75 SP-01 SHADOW**

Reference nr. **Material**

ET-130023 Brass



**EEMANN TECH BRASS MAGWELL FOR
CZ 75 TS**

Reference nr. **Material**

ET-130017 Brass



**EEMANN TECH BRASS BASE PAD FOR
CZ SHADOW 2**

Reference nr. **Material**

ET-130045 Brass



EEMANN TECH FIRING PIN FOR CZ 75 SP-01

Reference nr.	Color
ET-130014	Black



EEMANN TECH COMPETITION FIRING PIN FOR CZ*

Reference nr.	Color
ET-130015	Black

*The Extended Firing Pin resolves the misfire faults caused by weak main spring.



Born To Perform



EEMANN TECH ADJUSTABLE THUMB REST

Reference nr.

ET-130047

NEW



EEMANN TECH PRECISE BARREL BUSHING FOR
CZ 75-01 SHADOW, CZ SHADOW 2, CZ 75 TS

Reference nr.

ET-130034

NEW

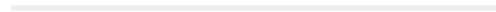

EEMANN TECH PRECISE BARREL BUSHING FOR
CZ 85, CZ 75B, CZ 75D COMPACT

Reference nr.

ET-130048

NEW

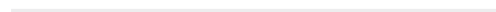

EEMANN TECH PRECISE BARREL BUSHING FOR
CZ 75, CZ 75BD, CZ85B

Reference nr.

ET-130049

NEW

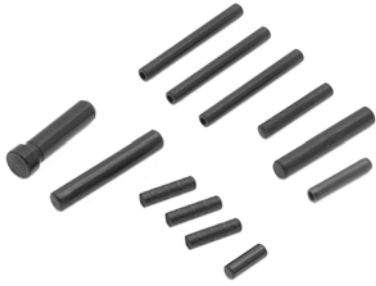

EEMANN TECH PINS SET FOR CZ

Reference nr.

ET-130062

NEW



EEMANN TECH TRIGGER PIN FOR CZ

Reference nr.

ET-130054

NEW



EEMANN TECH HAMMER STRUT PIN FOR CZ

Reference nr.

ET-130055

NEW



EEMANN TECH SEAR PIN FOR CZ

Reference nr.

ET-130056

NEW



EEMANN TECH MAIN SPRING PLUG PIN FOR CZ

Reference nr.

ET-130057

NEW



EEMANN TECH FRONT SIGHT PIN FOR CZ

Reference nr.

ET-130058

NEW



EEMANN TECH EXTRACTOR PIN FOR CZ

Reference nr.

ET-130059

NEW



EEMANN TECH HAMMER PIN FOR CZ

Reference nr.

ET-130060

NEW



EEMANN TECH HAMMER PIN LOCK PIN FOR CZ

Reference nr.

ET-130061

NEW





EEMANN TECH SLIDE STOP WITH THUMB REST FOR CZ 75 - BLACK

Reference nr.

ET-130046

NEW

Best solution for IPSC Standard division. Fits in IPSC Standard Box with OEM Safety.

Compatible with:

- CZ 75 B
- CZ 75 Shadow Line
- CZ 75 SP-01
- CZ 75 SP-01 Shadow

Total width: 41,5mm

Thumbrest width: 11mm

Material: Carbon Steel

Color: Black



EEMANN TECH SLIDE STOP WITH THUMB REST FOR CZ SHADOW 2 - BLACK

Reference nr.

ET-130050

NEW

Best solution for IPSC Standard division. Fits in IPSC Standard Box with OEM Safety.

Compatible with:

- CZ Shadow 2
- CZ 75D Compact
- CZ 75 Tactical Sports

Total width: 41,5mm

Thumbrest width: 11mm

Material: Carbon Steel

Color: Black

Fair **Advantage**



EEMANN TECH SOLID SLIDE STOP FOR CZ 75
Reference nr.

ET-130080

NEW

EEMANN TECH SOLID SLIDE STOP FOR CZ SHADOW 2
Reference nr.

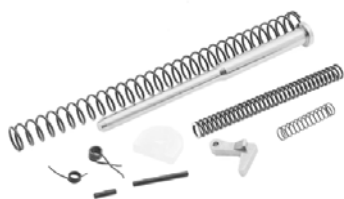
ET-130090

NEW

EEMANN TECH UPGRADE KIT FOR CZ 75 SP-01 SHADOW
Reference nr.

ET-130051

NEW

EEMANN TECH UPGRADE KIT FOR CZ 75 TS
Reference nr.

ET-130063

NEW

EEMANN TECH UPGRADE KIT FOR CZ SHADOW 2
Reference nr.

ET-130052

NEW

**EEMANN
TECH**

Quality. Experience. Technology.

SMALL PARTS

Upgrade Kit

CZ SHADOW 2

The Eemann Tech Upgrade Kit ET-130052 is made for the most popular competition pistol, the CZ Shadow 2 and is used predominantly for IPSC, USPSA & any action sports.



CZ Shadow 2

ET-130052

www.eemann-tech.com

info@eemann-tech.com

Made in EU



EEMANN TECH

Quality. Experience.
Technology.

The Eemann Tech Recoil System for GLOCK



Invented and produced for GLOCK17 GEN3 & GEN4 models. Gen3 to Gen4 recoil spring adapter and Installation tool are included.



The set contains a recoil spring 16lbs. Recoil springs with other power values are available for purchasing separately (from 10lbs till 16lbs).



Recoil Spring Guide Rod is made from Stainless Steel with a maximum possible diameter for the best performance. Recoil System Assembly weight is 36 g.





EEMANN TECH COMPETITION RECOIL SYSTEM FOR GLOCK 17-22 GEN3/GEN4

Reference nr.	Color
ET-120003	Silver



EEMANN TECH COMPETITION RECOIL SYSTEM FOR GLOCK 17-22 GEN5

Reference nr.	Color
ET-120005	Silver



EEMANN TECH GRIPS 4PCS. SET FOR GLOCK BASE PADS

Reference nr.	
ET-120040	NEW



EEMANN TECH COMPETITION GRIP TAPE FOR GLOCK17 GEN5

Reference nr.	
ET-120035	NEW



EEMANN TECH COMPETITION BUFFERS 5 PCS. SET FOR GLOCK GEN 3

Reference nr.
ET-303012



EEMANN TECH COMPETITION SIGHTS SET FOR GLOCK

Reference nr.	Diameter
ET-120021	1 mm
ET-120022	1,5 mm



EEMANN TECH TACTICAL SIGHTS SET FOR GLOCK

Reference nr.	Diameter
ET-120023	1 mm
ET-120024	1,5 mm



EEMANN TECH ADJUSTABLE SIGHTS SET FOR GLOCK

Reference nr.	Diameter
ET-120027	1 mm
ET-120028	1,5 mm



EEMANN TECH COMPETITION FRONT SIGHT FOR GLOCK

Reference nr.	Diameter	Height
ET-120025	1 mm	4,5 mm
ET-120026	1,5 mm	4,5 mm



EEMANN TECH FRONT SIGHT FOR ADJUSTABLE SIGHT

Reference nr.	Diameter	Height
ET-120030	1 mm	8,0 mm
ET-120031	1,5 mm	8,0 mm



EEMANN TECH UPGRADE KIT FOR GLOCK GEN 5*

Reference nr.

ET-120029

*Recommended only for OEM trigger system



EEMANN TECH UPGRADE KIT FOR GLOCK GEN 4*

Reference nr.

ET-120019

*Recommended only for OEM trigger system



EEMANN TECH UPGRADE KIT FOR GLOCK GEN 3*

Reference nr.

ET-120020

*Recommended only for OEM trigger system





EEMANN TECH SLIDE STOP WITH THUMB REST FOR TANFOGLIO - BLACK

Reference nr.

ET-152000

NEW



EEMANN TECH COMPETITION DISCONNECTOR FOR TANFOGLIO

Reference nr.

ET-152010

NEW



EEMANN TECH DISCONNECTOR PIN FOR TANFOGLIO

Reference nr.

ET-150003

NEW



EEMANN TECH TITANIUM FIRING PIN FOR TANFOGLIO

Reference nr.

ET-150001



EEMANN TECH COMPETITION BUFFERS 5 PCS. SET FOR TANFOGLIO

Reference nr.

ET-303015



FCH

R

M

ADDC
7.06E

DORLEUP
AG-43

Soft System



EEMANN TECH BOLT CATCH PLUNGER FOR AR-15

Reference nr.

ET-180031

NEW



EEMANN TECH SAFETY DETENT FOR AR-15

Reference nr.

ET-180032

NEW



EEMANN TECH PISTOL GRIP SCREW FOR AR-15

Reference nr.

ET-180033

NEW



EEMANN TECH PISTOL GRIP LOCK WASHER FOR AR-15

Reference nr.

ET-180034

NEW



EEMANN TECH BUFFER RETAINER FOR AR-15

Reference nr.

ET-180035

NEW



EEMANN TECH PIVOT PIN FOR AR-15

Reference nr.

ET-180036

NEW



EEMANN TECH TAKEDOWN PIN FOR AR-15

Reference nr.

ET-180037

NEW



EEMANN TECH TAKEDOWN AND PIVOT PIN DETENT FOR AR-15

Reference nr.

ET-180038

NEW



EEMANN TECH TRIGGER GUARD ROLL PIN FOR AR-15

Reference nr.

ET-180039

NEW



EEMANN TECH TRIGGER AND HAMMER PIN FOR AR-15

Reference nr.

ET-180040

NEW



EEMANN TECH GAS TUBE FOR AR-15

Reference nr.

Length

ET-180041

38,5 cm (15 1/8 inch)

NEW

ET-180042

29,9 cm (11 3/4 inch)

NEW

ET-180043

24,8 cm (9 3/4 inch)

NEW



EEMANN TECH GAS TUBE ROLL PIN FOR AR-15

Reference nr.

ET-180047

NEW



EEMANN TECH FORWARD ASSIST SPRING PIN FOR AR-15

Reference nr.

ET-180050

NEW



EEMANN TECH EJECTOR FOR AR-15

Reference nr.

ET-180051

NEW



EEMANN TECH MAGAZINE CATCH BUTTON FOR AR-15

Reference nr.

ET-180074

NEW



EEMANN TECH EJECTOR ROLL PIN FOR AR-15

Reference nr.

ET-180053

NEW



EEMANN TECH EXTRACTOR FOR AR-15

Reference nr.

ET-180054

NEW



EEMANN TECH EXTRACTOR PIN FOR AR-15

Reference nr.

ET-180055

NEW



EEMANN TECH EXTRACTOR SPRING INSERT FOR AR-15

Reference nr.

ET-180057

NEW



EEMANN TECH FIRING PIN FOR AR-15

Reference nr.

ET-180059

NEW



EEMANN TECH FIRING PIN RETAINING PIN FOR AR-15

Reference nr.

ET-180060

NEW



EEMANN TECH CAM PIN FOR AR-15

Reference nr.

ET-180061

NEW



EEMANN TECH BOLT CARRIER KEY FOR AR-15

Reference nr.

ET-180062

NEW



EEMANN TECH BOLT CARRIER KEY SCREW FOR AR-15

Reference nr.

ET-180063

NEW



EEMANN TECH CHARGING HANDLE ASSEMBLY FOR AR-15

Reference nr.

ET-180064

NEW



EEMANN TECH SAFETY SELECTOR LEVER FOR AR-15

Reference nr.

ET-180066

NEW



EEMANN TECH BOLT CATCH FOR AR-15

Reference nr.

ET-180067

NEW



EEMANN TECH BOLT CATCH PIN FOR AR-15

Reference nr.

ET-180068

NEW



EEMANN TECH MAGAZINE CATCH FOR AR-15

Reference nr.

ET-180069

NEW



EEMANN TECH DISCONNECTOR FOR AR-15

Reference nr.

ET-180070

NEW



EEMANN TECH EXTRACTOR FOR AR-9 PCC

Reference nr.

ET-189001

NEW



EEMANN TECH FIRING PIN FOR AR-9 PCC

Reference nr.

ET-189002

NEW

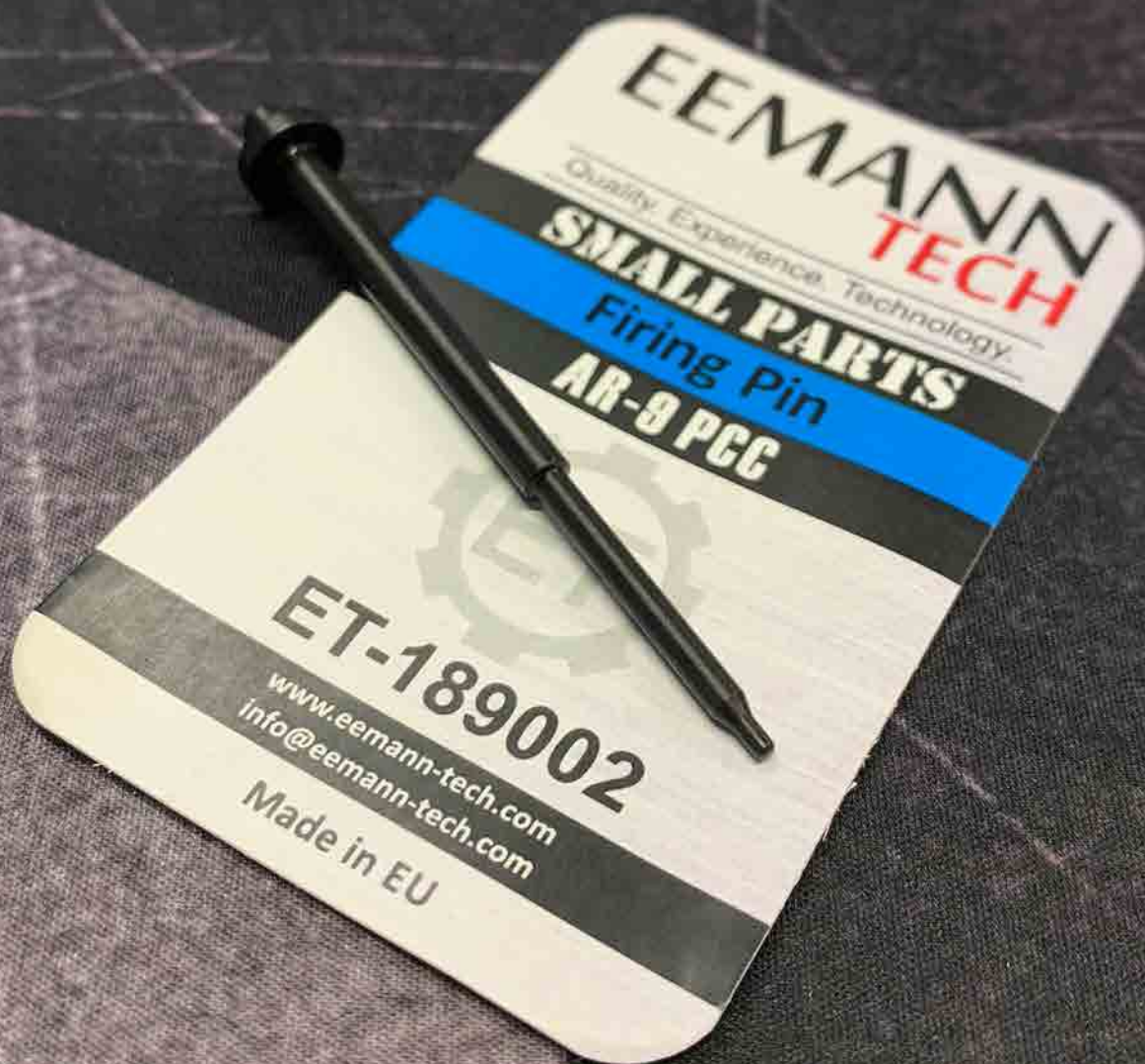



EEMANN | TARGETS TECH





TARGETS

The EEMANN TECH Company produces different kinds of targets for practical and other action shooting disciplines. The selection of EEMANN TECH targets covers IPSC, IDPA, USPSA, ISSF, Target Shooting and Tactical Disciplines.

Cardboard targets are the “expendable material” for any kind of competition from Level I to World Shoots, Club team practices, individual training, and master classes. You can never have enough targets! The EEMANN TECH Company produces cardboard and paper targets for in-door shooting galleries and open-air shooting ranges.

In addition to the target selection EEMANN TECH offers different types of target patches.

Our patches are made of water- and frost-resistant material. Specially designed for the IPSC/IDPA and their type of targets. The 20 mm patches are meant for patching hits from handgun, rifle shots or shotgun buckshots. The 30 mm patches are meant for rifle shots starting from caliber 7.62 mm. The 40 mm patches are meant for patching hits from shotgun slugs. The range of EEMANN TECH patches have a wide selection of colors, diameter and quantity per roll.

Besides the paper and cardboarded targets EEMANN TECH has a selection of Self setting metal plate targets. The Self setting targets are made of HARDOX steel and are intended for competition and shooting practice with handgun or rifle.

All the products manufactured by EEMANN TECH are labelled and have original packaging.

EEMANN TECH

Quality. Experience.
Technology.

The Eemann Tech Self Setting Steel Target, HARDOX, 200mm

Reference nr. ET-040012



Taking **Training** to the Next Level

TECHNICAL SPECIFICATIONS

- Plate material: HARDOX 450
- Plate thickness: 12mm
- Plate diameter: 20cm
- Height: 28cm
- Weight Brutto: 9,8 kg
- Weight Netto: 9,2 kg
- Plate-base material: Steel S355

STEEL TARGETS

The Eemann Tech IPSC Self Setting HARDOX Steel Target made of **Hardox steel** for competition and practice shooting using handgun or rifle.



The plate rises by means of special springs that can be easily removed if needed. The speed and rigidity of rising the plate backwards depends on springs power.

To maximize the training effect and have the plate rise back again to the standing position after each shot the plate should be used as it was designed with springs set mounted. To satisfy shooters with different firearm power factor the Self Setting plate set contains different power springs to provide the option for customization, to meet your needs and expectations. Using the Eemann Tech Self Setting Steel Target will take training to the next level!

To use the plate for practical shooting competitions the springs can be easily removed and the plate will work as a normal falling plate.

The Self Setting plate has a heavy base made of steel that keeps the plate in place whilst shooting. To fix the plate in place reliably the special holes are perforated on the horizontal parts of the plate base. Using the securing holes, the plate can be either fixed on the ground in the vertical position or secured to some stable construction downwards.

SET CONTAINS

- Eemann Tech IPSC Self Setting HARDOX Steel Target
- 2-springs-set [ET-040010]
- Additional 2-springs-set with reduced power -10% [ET-040011]

TARGET HAS BEEN TESTED BY

- Pistol at 7 meters distance (calibers: 9x19; 7,62x25; .38 SUPER)
- Rifle at 100 meters distance (calibers: .223 REM; 7,62x39; .308 WIN; 7,62x54R)



SELF SETTING STEEL TARGET, HARDOX, 200MM

Reference nr.

ET-040012



SPARE PLATE FOR SELF SETTING STEEL TARGET
200MM X 12MM, HARDOX

Reference nr.

ET-040013



SPARE ASSEMBLY KIT FOR SELF SETTING
STEEL TARGET

Reference nr.

ET-040014



SPARE SPRING SET FOR SELF SETTING
STEEL TARGET

Reference nr.

ET-040010



SPARE SPRING SET FOR SELF SETTING
STEEL TARGET, REDUCED POWER -10%

Reference nr.

ET-040011

EEMANN TECH

Quality. Experience.
Technology.

The Eemann Tech Cardboard IPSC Target, TAN/WHITE, 100pcs

Reference nr. ET-202100

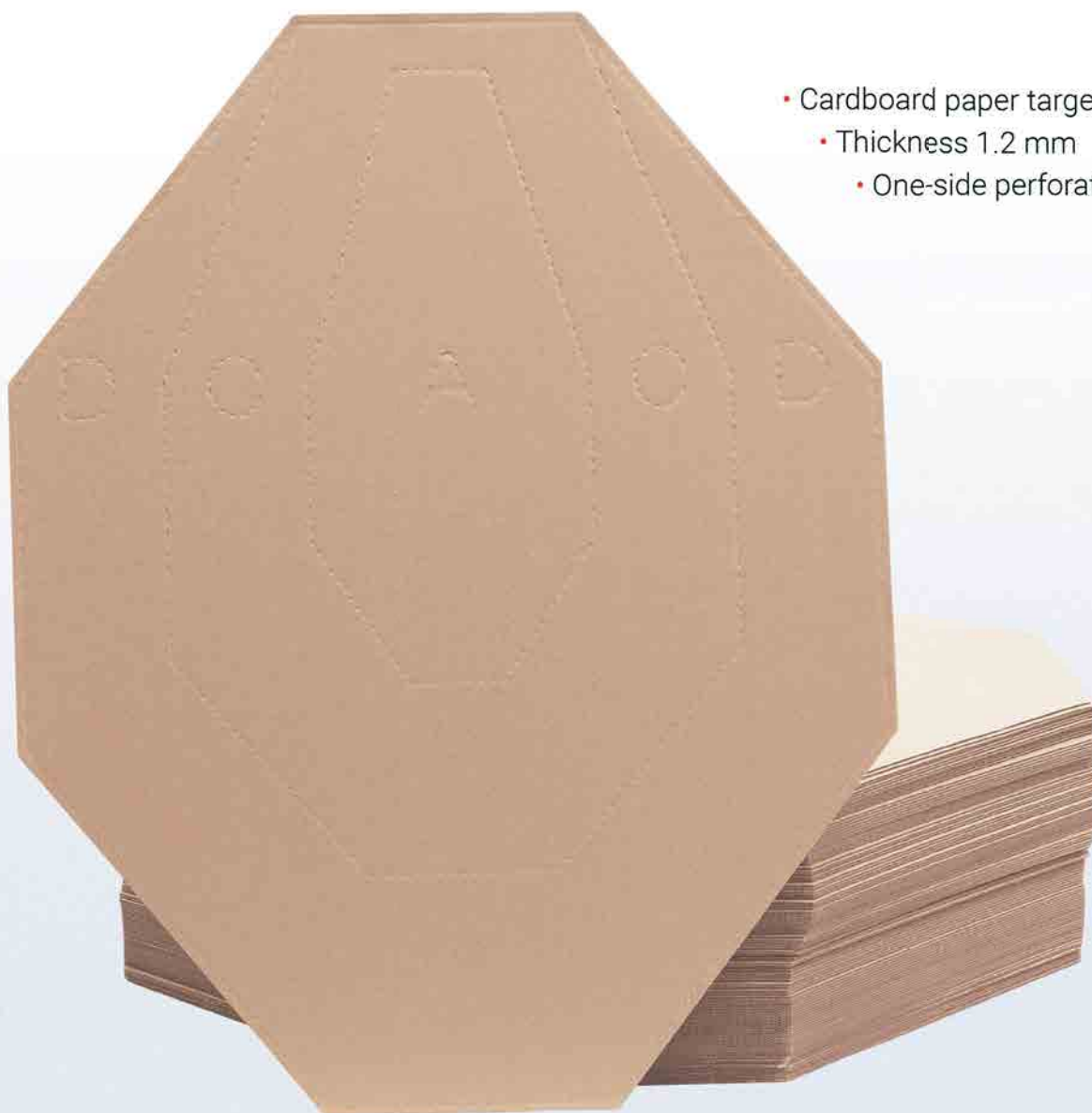

- Cardboard paper targets
- Thickness 1.2 mm
- One-side perforated

Train Your Shooting **Accuracy** to be Perfect

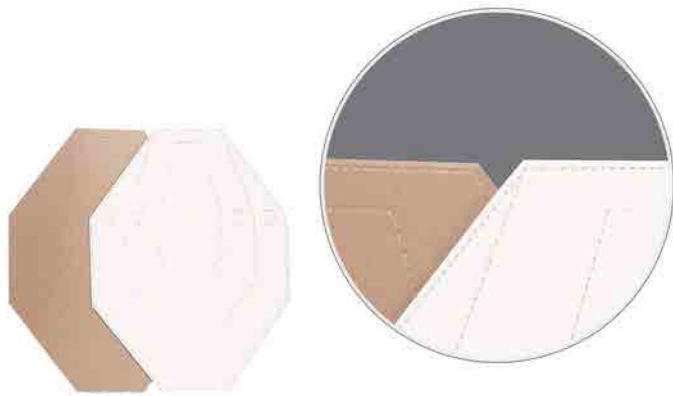

CARDBOARD IPSC TARGET

Reference nr.	Color	Quantity
ET-202100	TAN / WHITE	100pcs

*Target's size is original size from IPSC rulebook (Appendix B2)

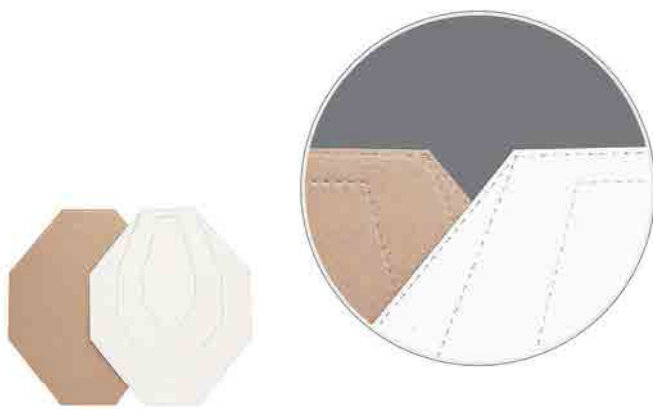

CARDBOARD IPSC MINI TARGET

Reference nr.	Color	Quantity
ET-213100	TAN / WHITE	100pcs

*Target's size is 60% from Cardboard IPSC Target ET-202100

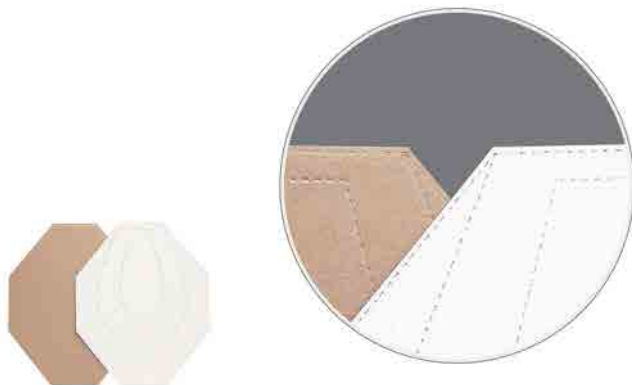

CARDBOARD IPSC MICRO TARGET

Reference nr.	Color	Quantity
ET-223100	TAN / WHITE	100pcs

*Target's size is 40% from Cardboard IPSC Target ET-202100

High quality IPSC legal targets for competition and training needs.
Perforated to include A, C, and D zones.

Perforation on Tan/White targets is done on the front side of target (Tan side). White side can be used both as Penalty Target and Scoring Target (perforation of scoring lines on white side is visible).

Material: Cardboard

Available quantity per pack: 100pcs.

Color: Tan/White

Packaging: Transparent Stretch Wrap



CARDBOARD IDPA TARGET

Reference nr.	Color	Quantity
ET-231100	TAN / WHITE	100pcs



CARDBOARD METRIC TARGET

Reference nr.	Color	Quantity
ET-239100	TAN / WHITE	100pcs

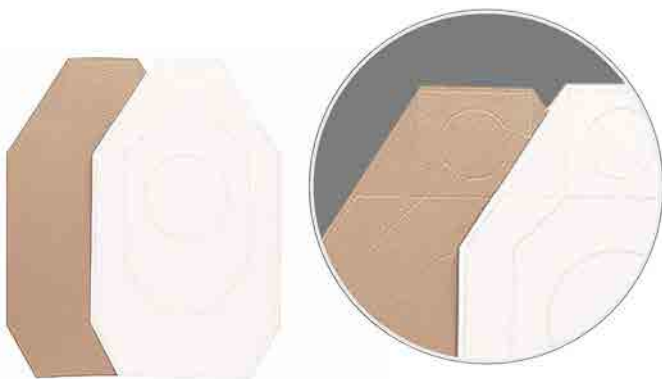

CARDBOARD ALTERNATIVE IDPA TARGET

Reference nr.	Color	Quantity
ET-232100	TAN / WHITE	100pcs

EEMANN | Quality. Experience.
TECH | Technology.

The Eemann Tech Paper Target Patcher Rolls



Giving a Second **Life** to Targets



EEMANN TECH PAPER TARGET PATCHER ROLL TAN

Reference nr.	Diameter	Quantity per roll
ET-302001	20mm	1000pcs
ET-302002	20mm	2000pcs
ET-302014	20mm	3000pcs
ET-302003	30mm	1000pcs
ET-302004	40mm	1000pcs



EEMANN TECH PAPER TARGET PATCHER ROLL WHITE

Reference nr.	Diameter	Quantity per roll
ET-302005	20mm	1000pcs
ET-302006	30mm	1000pcs
ET-302007	40mm	1000pcs



EEMANN TECH PAPER TARGET PATCHER ROLL BLACK

Reference nr.	Diameter	Quantity per roll
ET-302008	20mm	1000pcs
ET-302009	30mm	1000pcs
ET-302010	40mm	1000pcs



EEMANN TECH PAPER TARGET PATCHER ROLL GREEN

Reference nr.	Diameter	Quantity per roll
ET-302011	20mm	1000pcs
ET-302012	30mm	1000pcs
ET-302013	40mm	1000pcs



EEMANN TECH PAPER TARGET PATCHER ROLL RED

Reference nr.	Diameter	Quantity per roll
ET-302015	20mm	1000pcs
ET-302016	40mm	1000pcs

The Eemann Tech ISSF 25M Target 550 mm x 550 mm

Eemann Tech ISSF 25M Precision & 50M Pistol Target for:

- 50 m Pistol
- 25 m Standard Pistol events
- 25 m Center Fire precision stage
- 25 m Pistol events

Inner ten: 25 mm (± 0.2 mm)

Black from 7 to 10 rings = 200 mm (± 1.0 mm)

Ring thickness: 0.2 mm to 0.5 mm

Size: 550 mm x 550 mm

Available quantity per pack: 100 pcs.

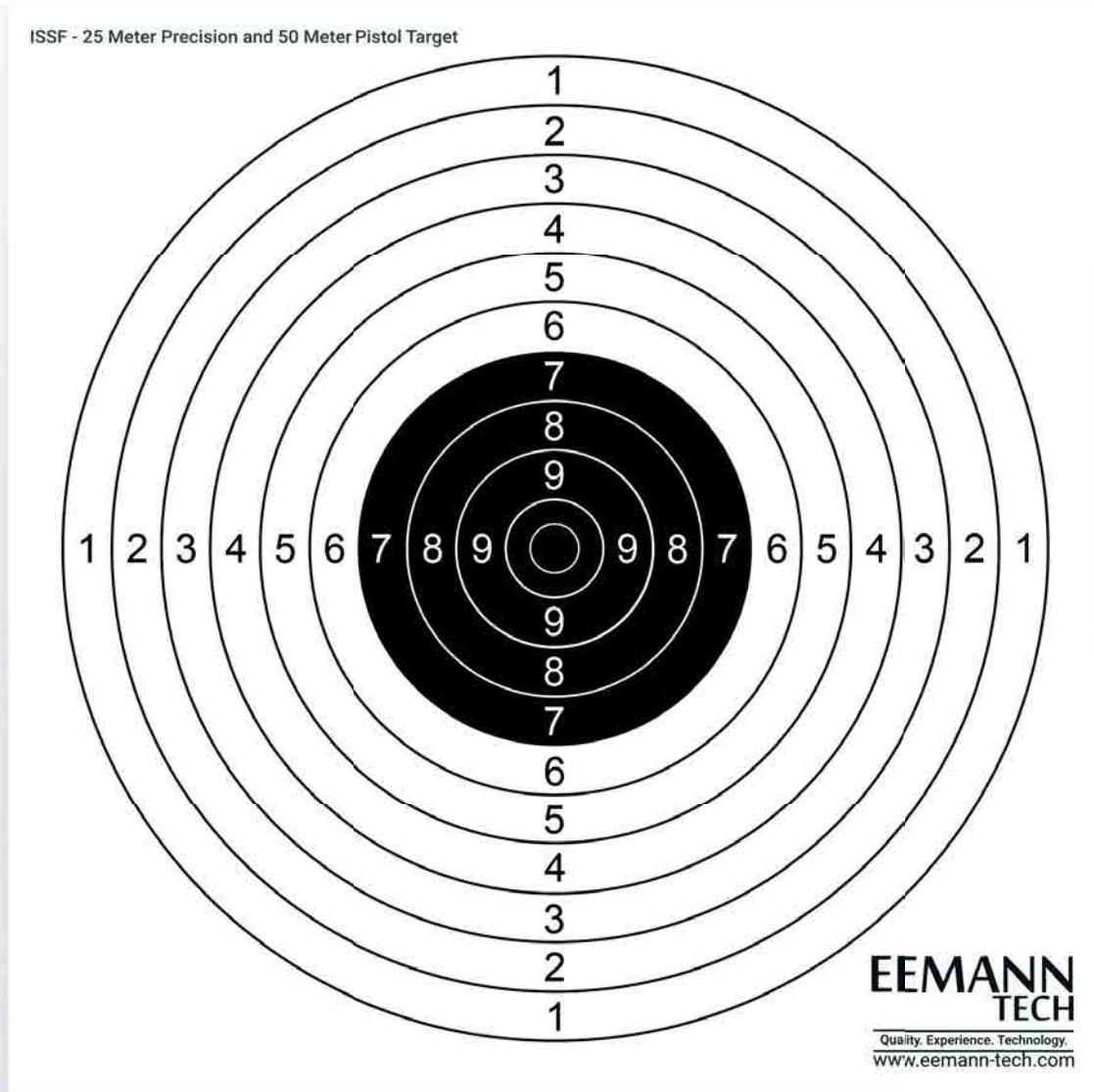

Practice Makes Perfect

**EEMANN TECH IPSC DRY FIRING TRAINING KIT****Reference nr.**

ET-222101

NEW**EEMANN TECH USPSA DRY FIRING TRAINING KIT****Reference nr.**

ET-222102

NEW

The Eemann Tech Dry Firing Targets kit is specially made for home dry fire training exercises. The targets are laser cut products made of 2 mm thick MDF and have A, C and D zones clearly marked.

Each target has a hole on the top part for attaching purposes onto any soft surfaces by tacs (included). The holes located on the target's sides are meant for rotation imitation. Cut targets represent hard cover targets.

THE TARGETS HAVE 3 SIZES

- Big targets: 15 cm tall that are 26 % of full-size target and imitate medium distance
- Medium targets: 9 cm tall that are 16 % of full-size target and imitate long distance
- Small targets: 6 cm tall that are 10 % of full-size target and imitate very long distance

COLOR

- Targets are of TAN color
- Poppers are of WHITE color





EEMANN TECH | TOOLS & ACCESSORIES





EEMANN TECH GUN BORE ROPE CLEANER

Reference nr.	Caliber
ET-030023	9x19 mm
ET-030024	.223 Rem
ET-030025	.308 Win
ET-030026	.40 S&W
ET-030027	12 Gauge
ET-030028	.45AUTO
ET-030029	.22LR
ET-030030	.177 (4.5mm)



EEMANN TECH TORX KEY T15 L-SHAPED

Reference nr.
ET-030011



EEMANN TECH TORX KEY T20 L-SHAPED

Reference nr.
ET-030010



EEMANN TECH HEX KEY 1,5MM L-SHAPED

Reference nr.
ET-030012

NEW



EEMANN TECH HEX KEY 2MM L-SHAPED

Reference nr.
ET-030013

NEW



EEMANN TECH HEX KEY 2,5MM L-SHAPED

Reference nr.
ET-030014

NEW



EEMANN TECH HSS DRILL FOR THE CZ FRONT SIGHT

Reference nr.

ET-020002



EEMANN TECH DIAMOND FILES 10-PCS SET

Reference nr.

ET-030009



EEMANN TECH IPSC SCORING HANDGUN OVERLAY

Reference nr.

ET-030030



.45auto

.40S&W

9x19 mm

EEMANN TECH PISTOL AMMO CHAMBER CHECKER

Reference nr.

Caliber

ET-030020

9x19 mm

ET-030021

.40 S&W

ET-030022

.45AUTO



EEMANN TECH 4-PCS PLASTIC HOOK SET

Reference nr.

ET-030100



EEMANN TECH GRIP TAPE 5CM X 30CM

Reference nr.

Pistol Model

ET-303001

Black

ET-303002

Blue

ET-303003

Green

ET-303004

Yellow

ET-303005

Red

ET-303007

Grey

ET-303008

White





EEMANN TECH SLIDE LOCK TOOL FOR CZ

Reference nr.

ET-030332

NEW



EEMANN TECH SLIDE LOCK TOOL FOR 1911/2011

Reference nr.

ET-030333

NEW



EEMANN TECH SLIDE LOCK TOOL FOR GLOCK

Reference nr.

ET-030334

NEW

Slide lock tool specially made to lock the pistol slide in vise for the maintenance or sights removal (replacement).
Made from Aluminium, do not damage surface of slide.

Gunsmith **Perfection**

**EEMANN TECH CORN COB POLISHING MEDIA
M16 - 2KG****Reference nr.**

ET-030032

NEW**EEMANN TECH CORN COB POLISHING MEDIA
M16 - 25KG****Reference nr.**

ET-030033

NEW

High quality corn cob media which can remove grit, dirt and powder residue from your cases.

The media can be used repeatedly but should be replaced periodically for the best result. The small grain media is perfect for use in small to medium size tumblers and cleans even the smallest recesses of case rims and primer pockets.

Works great with all polishing additives. Just a few spoons onto the media and then a few hours in your tumbler – and your brass will come out looking like new!



EEMANN | APPARELS TECH





Fabric:
LITE-X

EEMANN TECH CLASSIC T-SHIRT

Reference nr.	Size
ET-400001	2XS
ET-400002	XS
ET-400003	S
ET-400004	M
ET-400005	L
ET-400006	XL
ET-400007	2XL
ET-400008	3XL
ET-400009	4XL
ET-400010	5XL
ET-400011	6XL
ET-400012	7XL
ET-400013	8XL
ET-400014	9XL
ET-400015	10XL



Fabric:
LITE-X

EEMANN TECH COMPETITION SPRINGS T-SHIRT

Reference nr.	Size
ET-400021	2XS
ET-400022	XS
ET-400023	S
ET-400024	M
ET-400025	L
ET-400026	XL
ET-400027	2XL
ET-400028	3XL
ET-400029	4XL
ET-400030	5XL
ET-400031	6XL
ET-400032	7XL
ET-400033	8XL
ET-400034	9XL
ET-400035	10XL



EEMANN TECH LANYARD

Reference nr.
ET-009014

DED EEMANN TECH AUSTRALASIA 2019 T-SHIRT

Reference nr.	Size
ET-401640	2XS
ET-401641	XS
ET-401642	S
ET-401643	M
ET-401644	L
ET-401645	XL
ET-401646	2XL
ET-401647	3XL
ET-401648	4XL
ET-401649	5XL
ET-401650	6XL
ET-401651	7XL
ET-401652	8XL
ET-401653	9XL
ET-401654	10XL



Fabric:
LITE-X



EEMANN TECH PEN

Reference nr.
ET-009018



EEMANN TECH RUBBER MAT

Reference nr.	Size
ET-009022	900x400mm



EEMANN TECH NOTEBOOK

Reference nr.	Size
ET-009021	A5



Stay in contact with us:

www.eemann-tech.com
export@eemann-tech.com

www.facebook.com/eemanntechofficial
www.instagram.com/eemanntech
www.youtube.com/EemannTech

Männiku tee 96G, Tallinn

