

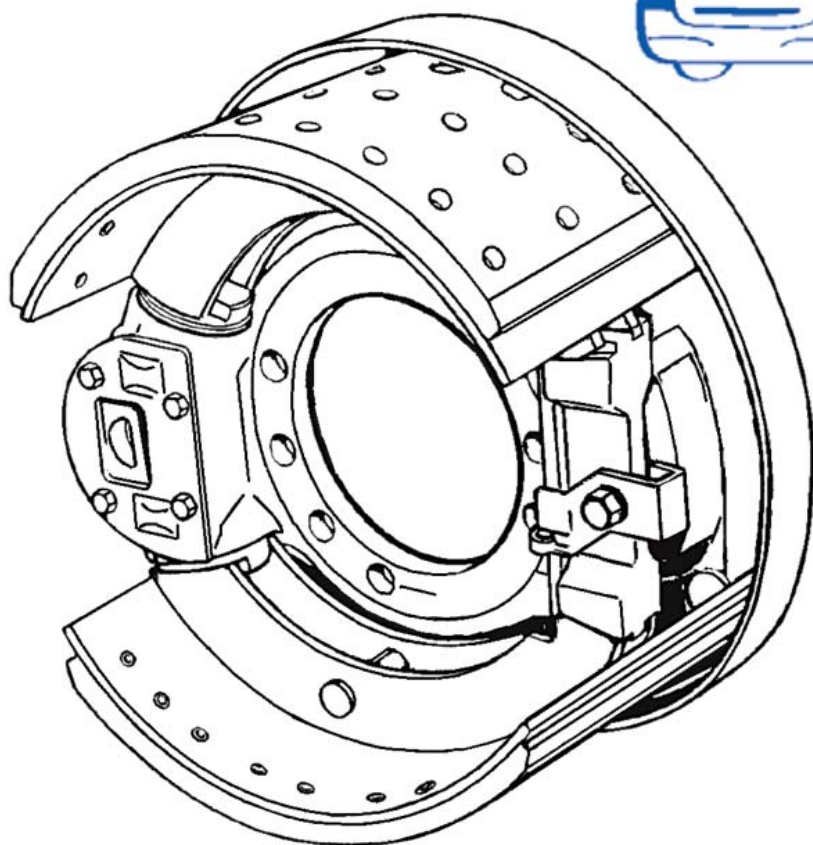



**CATALOGUE PIÈCES DE FRICTIONS A
TAMBOURS POIDS LOURDS
MÂCHOIRES DE FREIN GARNIES ET KIT DE
GARNITURES AVEC ACCESSOIRES**

**CV FRICTIONS DRUM PART CATALOGUE
CV LINED BRAKE SHOES AND CV LINING KIT
WITH FITTING KIT**





**CATALOGUE PIECES DE FRICTIONS A
TAMBOURS POIDS LOURDS
MÂCHOIRES DE FREIN GARNIES ET KIT DE
GARNITURES AVEC ACCESSOIRES
CV FRICTIONS DRUM PART CATALOGUE
CV LINED BRAKE SHOES AND CV LINING KIT
WITH FITTING KIT**

	PAGE
 SOMMAIRE	2
INTRODUCTION - NOUVEAUTES	3
ABREVIATIONS - EXPLICATIONS DES REFERENCES	4
TUTORIEL D'UTILISATION DU CATALOGUE	5
APPLICATION PAR VEHICULES	6-14
PIECES DE FREINAGE POUR GRUES MOBILES	15
RECHERCHE GARNITURES PAR DIMENSIONS	16-27
DIMENSIONS DES RIVETS	28
LISTE APPLICATIVE DES TEMOINS D'USURE	29-30
ILLUSTRATIONS	31-41
CORRESPONDANCE DES REFERENCES	42-70
AVIS DE NON-RESPONSABILITE	71

 CONTENTS	2
INTRODUCTION - NEWS	3
ABBREVIATION - PARTNUMBERS EXPLANATION	4
HOW TO USE THE CATALOG	5
APPLICATION BY VEHICLE	6-14
BRAKE PARTS FOR MOBILE CRANES	15
BRAKE LINING RESEARCH BY SIZE	16-27
DIMENSIONS RIVETS	28
WEAR INDICATOR LIST	29-30
DRAWINGS	31-41
CROSS REFERENCE LIST	42-70
DISCLAIMER	71

INTRODUCTION

Ce catalogue a pour but de simplifier et de compléter les catalogues existants de Textar (<http://www.gil-automotive.com/archives/textarcvcatalogue.pdf> ou sur www.brakebook.com). La recherche par véhicule est simplifiée et représente 95% des ventes. La recherche des garnitures par dimensions inclut 99% des freins à tambours existants (les garnitures avec terminaison xx sont sur demande et livrable sous 48 à 72 heures). Vous trouverez dans ILLUSTRATIONS les pièces complémentaires pour réaliser les opérations de maintenance des freins les plus importants ; ceux-ci se retrouvent en effectuant une recherche par les 5 chiffres du WVA ou des 5 premiers chiffres de la référence Textar.

 This catalog aims to simplify and complete the existing Textar catalog (<http://www.gil-automotive.com/archives/textarcvcatalogue.pdf> or www.brakebook.com). Search by vehicle is simplified and represents 95% of sales. Search by dimension linings includes 99% of the existing drum brake (trim xx termination are available on demand and within 48 to 72 hours). Into DRAWINGS section you will find the additional parts to achieve the maintenance of the biggest brakes; they can be found by searching by the 5 digits of the WVA or first 5 digits of Textar reference.

NEWS 1906880; 1907180; 1909080

Nouveauté importante : 3 kits pour DAF, IRISBUS, RENAULT TRUCKS et VOLVO pour frein came Z en largeur 175, 200 et 225 mm sont désormais disponibles. Epaisseur de la mâchoire 8mm
New large 3 kits DAF IRISBUS, RENAULT TRUCKS and VOLVO to Z cam brake width 175, 200 and 225 mm are now available. Brake shoes thickness 8 mm.







**CATALOGUE PIECES DE FRICTIONS A
TAMBOURS POIDS LOURDS
MÂCHOIRES DE FREIN GARNIES ET KIT DE
GARNITURES AVEC ACCESSOIRES**





**CV FRICTIONS DRUM PART CATALOGUE
CV LINED BRAKE SHOES AND CV LINING KIT
WITH FITTING KIT**

ABREVIATIONS	Français	English
410x200	Ø Tambour x Largeur Garniture	Drum Ø x Lining width
AV	Essieu avant	Front axle
AV/AR	Essieu avant & arrière	Front and rear axle
AR	Essieu arrière	Rear axle
ROCKWELL 1	1 = Premier montage	First equipment
ROCKWELL 2	2 = Deuxième montage	Second equipment
RPP	Remplacé par	Superseded
EXPLICATIONS DES REFERENCES / PARTNUMBERS EXPLANATION		
MACxxxxx	Mâchoire nue	Unlined brake shoe
MACxxxxxCAST	Mâchoire nue en fonte	Cast Unlined brake shoe
MACxxxxx/2	Mâchoires nues en kit de 2 pièces	Unlined brake shoes kit 2 pieces





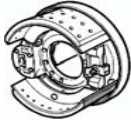
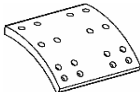

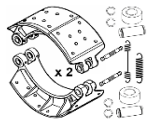
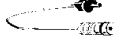

 Après ouverture du catalogue, veuillez taper les touches de votre clavier (**Ctrl+F**), une case va s'ouvrir (en vert) taper par exemple KERAX, appuyer sur entrée, vous remarquerez que vous arrivez sur les applications pour KERAX, appuyer sur entrée vous irez aux étriers pour le KERAX et vous continuez cette procédure afin de trouver le restant des pièces pour le KERAX. Vous pouvez également effectuer une recherche d'un numéro OES exemple: Veuillez taper les touches de votre clavier (**Ctrl+F**), écrivez 5001825627 puis entrée vous arriverez directement à la référence 1925501 Après avoir trouvé la référence 1925501, vous pouvez la copier en la surbrillant puis (**Ctrl+C**) et téléchargez le tarif général puis (**Ctrl+F**) et (**Ctrl+V**) pour coller, puis entrée, vous trouverez alors le prix et le code de remise du produit dans ce cas c'est 6.

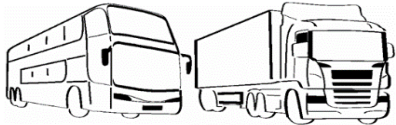
 After opening the catalog, please type the keys on your keyboard (**Ctrl + F**), a pop up will be open (green) eg type KERAX, press enter, you will notice that you get the master cylinder KERAX, press on entry then go to the caliper application for KERAX and you continue this process to find the remaining parts for KERAX. You can also search an OES number example: Please type in your keyboard (**Ctrl + F**), then write 5001825627 entry you come to the partnumber 1925501 After finding the part number 1925501, you can copy it on the brilliant and (**Ctrl + C**) and then download list price (**Ctrl + F**) and (**Ctrl + V**) to paste and input, you then find the price and the product discount code in this case is 6.



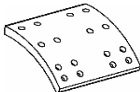

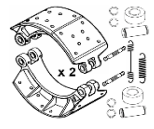

APPLICATION PAR VEHICULES APPLICATION BY VEHICLES

				VVA				
BPW	H & EH >1995 SN4218.1 - 22,5"		420x180 CO +0 mm	19032	1903230		1903270	
BPW	ECO 95 SN4218.2 - 22,5"		420x180 CO +0 mm	19032	1903230		1903271	
BPW	H & EH >1995 SN4220.1 - 22,5"		420x200 CO +0 mm	19094	1909437		1909470	
BPW	ECO 95 SN4220.2 - 22,5"		420x200 CO +0 mm	19094	1909437		1909471	
DAF	1900	AV	420x150 DAF	19010/19011	1901005			
DAF	2300	AV	420x150 DAF	19010/19011	1901005			
DAF	2300	AR	420x200 DAF	19063/19064	1906303	MAC9063/64		
DAF	2500	AV	420x150 DAF	19010/19011	1901005			
DAF	2700	AV	420x150 DAF	19010/19011	1901005			
DAF	2700	AR	420x200 DAF	19063/19064	1906303	MAC9063/64		
DAF	2900	AV	420x150 DAF	19010/19011	1901005			
DAF	2900	AR	420x200 DAF	19063/19064	1906303	MAC9063/64		
DAF	50 F	AV/AR	360x170 PERROT	19503	1950308	MAC9503		
DAF	55 F	AR	360x170 PERROT	19503	1950308	MAC9503		
DAF	65 F	AV	420x150 DAF	19010/19011	1901005			
DAF	65 F	AR	420x200 DAF	19063/19064	1906303	MAC9063/64		
DAF	75 F	AV	420x150 DAF	19010/19011	1901005			
DAF	75 F	AR	420x150 DAF	19010/19011	1901005			
DAF	75 F	AR	420x200 DAF	19063/19064	1906303	MAC9063/64		
DAF	85 F	AV	420x150 DAF	19010/19011	1901005			
DAF	85 F	AR	420x150 DAF	19010/19011	1901005			
DAF	85 F	AR	420x200 DAF	19063/19064	1906303	MAC9063/64		
DAF	95 F	AV	420x150 DAF	19010/19011	1901005			
DAF	95 F	AV	420x200 DAF	19063/19064	1906303	MAC9063/64		
DAF	95 F	AR	420x150 DAF	19010/19011	1901005			
DAF	95 F	AR	420x200 DAF	19063/19064	1906303	MAC9063/64		
DAF	105 XF	AR	410x200 MERITOR	19071	1907102	MAC9071/2	1907180	
ERF	E - SERIE	AV	410x175 MERITOR	19090	1909002	MAC9090/2	1909080	
ERF	E - SERIE	AR	410x200 MERITOR	19071	1907102	MAC9071/2	1907180	
GIGANT	GKHI 10510-3020		300x200 CO +0 mm	19574	1957431		1957471	



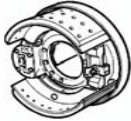
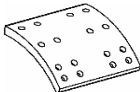

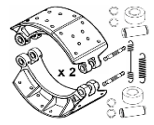

APPLICATION PAR VEHICULES APPLICATION BY VEHICLES

								
IRISBUS	AGORA	AR	414x220 RT	19187	1918702	MAC9187		
IRISBUS	E - SERIE	AR	414x150 BENDIX	19049/19199	1904902	MAC9049/199		
IRISBUS	FR 1	AR	414x175 RT	19935	1993502	MAC9935		
IRISBUS	FR 1	AR	414x200 RT	19974	19974xx	MAC9974		
IRISBUS	FR 1	AR	414x220 RT	19187	1918702	MAC9187		
IRISBUS	HEULIEZ	AV	414x150 BENDIX	19049/19199	1904902	MAC9049/199		
IRISBUS	HEULIEZ	AV/AR	414x175 RT	19935	1993502	MAC9935		
IRISBUS	HEULIEZ	AR	414x220 RT	19187	1918702	MAC9187		
IRISBUS	HEULIEZ	AR	410x225 MERITOR	19068	1906802	MAC9068/2	1906880	
IRISBUS	ILIADE	AR	414x220 RT	19187	1918702	MAC9187		
IRISBUS	PR	AV/AR	414x150 BENDIX	19049/19199	1904902	MAC9049/199		
IRISBUS	PR	AV	414x175 RT	19935	1993502	MAC9935		
IRISBUS	PR	AR	414x200 RT	19974	19974xx	MAC9974		
IRISBUS	RECREO 2	AR	410x200 MERITOR	19071	1907102	MAC9071/2	1907180	
IRISBUS	S - SERIE	AV/AR	414x150 BENDIX	19049/19199	1904902	MAC9049/199		
IRISBUS	TRACER	AV/AR	414x175 RT	19935	1993502	MAC9935		
IVECO	EUROCARGO	AR	360x170 PERROT	19503	1950308	MAC9503		
IVECO	EUROSTAR	AR	410x182 PERROT 2	19099/19100	1909902			98032100
IVECO	EUROSTAR -04.96	AR	410x180 ROCKWELL 1	19555/19556	1955502			98032200
IVECO	EUROSTAR 05.96-05.03	AR	410x180 ROCKWELL 2	19714/19715/19556	1971401			98032200
IVECO	EUROSTAR 06.03-	AR	410x180 ROCKWELL 3	19109/19110	1910902			98032200
IVECO	EUROSTAR	AR	410x200 PERROT 1	19343/19263 RPP	1909102	MAC9091/98		98032100
IVECO	EUROSTAR	AR	410x202 PERROT 2	19091/19098	1909102	MAC9091/98		98032100
IVECO	EUROSTAR -04.96	AR	410x200 ROCKWELL 1	19554/19553	1955301			98032200
IVECO	EUROSTAR 05.96-05.03	AR	410x200 ROCKWELL 2	19716/19717/19553	1971612			98032200
IVECO	EUROSTAR 06.03-	AR	410x200 ROCKWELL 3	19116/19119	1911602			98032200
IVECO	EUROTECH	AR	410x202 PERROT 2	19091/19098	1909102	MAC9091/98		98032100
IVECO	EUROTECH	AR	410x182 PERROT 2	19099/19100	1909902			98032100
IVECO	EUROTECH MP -04.96	AR	410x180 ROCKWELL 1	19555/19556	1955502			98032200
IVECO	EUROTECH MP 05.96-05.03	AR	410x180 ROCKWELL 2	19714/19715/19556	1971401			98032200

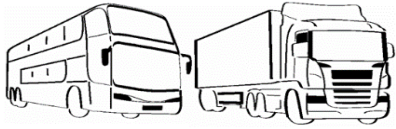

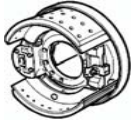

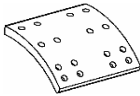

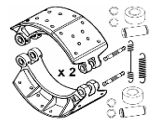
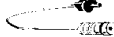
APPLICATION PAR VEHICULES APPLICATION BY VEHICLES

				VVA				
IVECO	EUROTECH MP 06.03-	AR	410x180 ROCKWELL 3	19109/19110	1910902			98032200
IVECO	EUROTECH MP -04.96	AR	410x200 ROCKWELL 1	19554/19553	1955301			98032200
IVECO	EUROTECH MP 05.96-05.03	AR	410x200 ROCKWELL 2	19716/19717/19553	1971612			98032200
IVECO	EUROTECH MP 06.03-	AR	410x200 ROCKWELL 3	19116/19119	1911602			98032200
IVECO	EUROTECH MP	AR	410x180 PERROT 1	19342/19262 RPP	1909902			98032100
IVECO	EUROTECH MP	AR	410x182 PERROT 2	19099/19100	1909902			98032100
IVECO	EUROTECH MP	AR	410x200 PERROT 1	19343/19263 RPP	1909102	MAC9091/98		98032100
IVECO	EUROTECH MP	AR	410x202 PERROT 2	19091/19098	1909102	MAC9091/98		98032100
IVECO	EUROTECH MT -04.96	AR	410x180 ROCKWELL 1	19555/19556	1955502			98032200
IVECO	EUROTECH MT 05.96-05.03	AR	410x180 ROCKWELL 2	19714/19715/19556	1971401			98032200
IVECO	EUROTECH MT 06.03-	AR	410x180 ROCKWELL 3	19109/19110	1910902			98032200
IVECO	EUROTECH MT -04.96	AR	410x200 ROCKWELL 1	19554/19553	1955301			98032200
IVECO	EUROTECH MT 05.96-05.03	AR	410x200 ROCKWELL 2	19716/19717/19553	1971612			98032200
IVECO	EUROTECH MT 06.03-	AR	410x200 ROCKWELL 3	19116/19119	1911602			98032200
IVECO	EUROTRAKKER	AV	410x200 PERROT 1	19343/19263 RPP	1909102	MAC9091/98		98032100
IVECO	EUROTRAKKER	AV	410x202 PERROT 2	19091/19098	1909102	MAC9091/98		98032100
IVECO	EUROTRAKKER -04.96	AV	410x200 ROCKWELL 1	19554/19553	1955301			98032200
IVECO	EUROTRAKKER 05.96-05.03	AV	410x200 ROCKWELL 2	19716/19717/19553	1971612			98032200
IVECO	EUROTRAKKER 06.03-	AV	410x200 ROCKWELL 3	19116/19119	1911602			98032200
IVECO	EUROTRAKKER	AR	410x200 PERROT 1	19343/19263 RPP	1909102	MAC9091/98		98032100
IVECO	EUROTRAKKER	AR	410x202 PERROT 2	19091/19098	1909102	MAC9091/98		98032100
IVECO	EUROTRAKKER -04.96	AR	410x200 ROCKWELL 1	19554/19553	1955301			98032200
IVECO	EUROTRAKKER 05.96-05.03	AR	410x200 ROCKWELL 2	19716/19717/19553	1971612			98032200
IVECO	EUROTRAKKER 06.03-	AR	410x200 ROCKWELL 3	19116/19119	1911602			98032200
MAN	EL-Series	AR	410x220 MERCEDES	19496	1949602	MAC9496CAST		98023500
MAN	F2000	AV	410x180 MERCEDES	19495	1949502	MAC9495CAST		98023500
MAN	F2000	AR	410x180 MERCEDES	19495	1949502	MAC9495CAST		98023500
MAN	F2000	AR	410x220 MERCEDES	19496	1949602	MAC9496CAST		98023500
MAN	F90	AV	410x160 MERCEDES	19494	1949402			98023500
MAN	F90	AV	410x180 MERCEDES	19495	1949502	MAC9495CAST		98023500

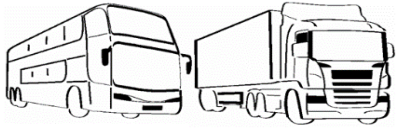

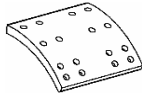

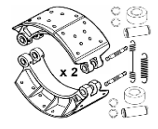

APPLICATION PAR VEHICULES APPLICATION BY VEHICLES

								
MAN	F90	AR	410x220 MERCEDES	19496	1949602	MAC9496CAST	98023500	
MAN	FR/FRH-Series	AV	410x160 MERCEDES	19494	1949402		98023500	
MAN	FR/FRH-Series	AR	410x220 MERCEDES	19496	1949602	MAC9496CAST	98023500	
MAN	M2000	AV	410x160 MERCEDES	19494	1949402		98023500	
MAN	M2000	AR	410x180 MERCEDES	19495	1949502	MAC9495CAST	98023500	
MAN	M2000	AR	410x220 MERCEDES	19496	1949602	MAC9496CAST	98023500	
MAN	NG-Series	AV	410x160 MERCEDES	19494	1949402		98023500	
MAN	NG-Series	AR	410x220 MERCEDES	19496	1949602	MAC9496CAST	98023500	
MAN	NL-Series	AV	410x160 MERCEDES	19494	1949402		98023500	
MAN	NL-Series	AR	410x220 MERCEDES	19496	1949602	MAC9496CAST	98023500	
MAN	SD/SL-Series	AV	410x160 MERCEDES	19494	1949402		98023500	
MAN	SD/SL-Series	AR	410x220 MERCEDES	19496	1949602	MAC9496CAST	98023500	
MAN	SG-Series	AV	410x160 MERCEDES	19494	1949402		98023500	
MAN	SG-Series	AR	410x160 MERCEDES	19494	1949402		98023500	
MAN	SG-Series	AR	410x180 MERCEDES	19495	1949502	MAC9495CAST	98023500	
MAN	SG-Series	AR	410x220 MERCEDES	19496	1949602	MAC9496CAST	98023500	
MAN	SR-Series	AV	410x160 MERCEDES	19494	1949402		98023500	
MAN	SR-Series	AR	410x220 MERCEDES	19496	1949602	MAC9496CAST	98023500	
MAN	SÜ-Series	AV	410x160 MERCEDES	19494	1949402		98023500	
MAN	SÜ-Series	AR	410x220 MERCEDES	19496	1949602	MAC9496CAST	98023500	
MAN	TGA	AR	410x220 MERCEDES	19496	1949602	MAC9496CAST	98023500	
MAN	ÜL-Series	AV	410x160 MERCEDES	19494	1949402		98023500	
MAN	ÜL-Series	AR	410x220 MERCEDES	19496	1949602	MAC9496CAST	98023500	
MERCEDES	Actros	AV	410x180 MERCEDES	19495	1949502	MAC9495CAST	98017002	
MERCEDES	Actros	AR	410x220 MERCEDES	19496	1949602	MAC9496CAST	98017002	
MERCEDES	Atego	AV	410x180 MERCEDES	19495	1949502	MAC9495CAST	98017002	
MERCEDES	Atego	AR	410x220 MERCEDES	19496	1949602	MAC9496CAST	98017002	
MERCEDES	LK-Series	AV	410x160 MERCEDES	19494	1949402		98017002	
MERCEDES	LK-Series	AR	410x160 MERCEDES	19494	1949402		98017002	
MERCEDES	MS/SK-Series	AV	410x160 MERCEDES	19494	1949402		98017002	

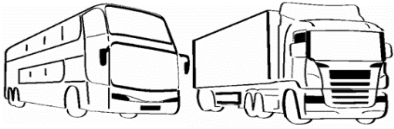

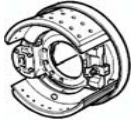
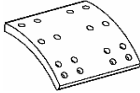

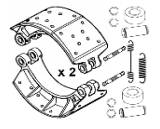
APPLICATION PAR VEHICULES APPLICATION BY VEHICLES

				VVA				
MERCEDES	MS/SK-Series	AV	410x180 MERCEDES	19495	1949502	MAC9495CAST		98017002
MERCEDES	MS/SK-Series	AR	410x160 MERCEDES	19494	1949402			98017002
MERCEDES	MS/SK-Series	AR	410x180 MERCEDES	19495	1949502	MAC9495CAST		98017002
MERCEDES	MS/SK-Series	AR	410x220 MERCEDES	19496	1949602	MAC9496CAST		98017002
MERCEDES	OLD RANGE 33t	AR	410x220 MERCEDES	19496	1949602	MAC9496CAST		98017002
MERCEDES	O-Series	AV	410x160 MERCEDES	19494	1949402			98017002
MERCEDES	O-Series	AV	410x180 MERCEDES	19495	1949502	MAC9495CAST		98017002
MERCEDES	O-Series	AR	410x180 MERCEDES	19495	1949502	MAC9495CAST		98017002
MERCEDES	O-Series	AR	410x220 MERCEDES	19496	1949602	MAC9496CAST		98017002
RENAULT TRUCKS	BERLIET	AV/AR	414x150 BENDIX	19049/19199	1904902	MAC9049/199		
RENAULT TRUCKS	C - RANGE	AV	414x150 BENDIX	19049/19199	1904902	MAC9049/199		
RENAULT TRUCKS	C - RANGE	AV	414x150 RT	19934	1993402	MAC9934		
RENAULT TRUCKS	C - RANGE	AV	414x175 RT	19935	1993502	MAC9935		
RENAULT TRUCKS	C - RANGE	AR	414x150 BENDIX	19049/19199	1904902	MAC9049/199		
RENAULT TRUCKS	C - RANGE	AR	414x150 RT	19934	1993402	MAC9934		
RENAULT TRUCKS	C - RANGE	AR	414x175 RT	19935	1993502	MAC9935		
RENAULT TRUCKS	G - MANAGER	AV	414x150 BENDIX	19049/19199	1904902	MAC9049/199		
RENAULT TRUCKS	G - MANAGER	AV	414x150 RT	19934	1993402	MAC9934		
RENAULT TRUCKS	G - MANAGER	AV	414x175 RT	19935	1993502	MAC9935		
RENAULT TRUCKS	G - MANAGER	AR	414x175 RT	19935	1993502	MAC9935		
RENAULT TRUCKS	G - MANAGER	AR	414x150 RT	19934	1993402	MAC9934		
RENAULT TRUCKS	G - MAXTER	AV/AR	414x175 RT	19935	1993502	MAC9935		
RENAULT TRUCKS	KERAX	AV	414x175 RT	19935	1993502	MAC9935K		
RENAULT TRUCKS	KERAX	AR	414x175 RT	19935	1993502	MAC9935K		
RENAULT TRUCKS	KERAX	AR	414x220 RT	19187	1918702	MAC9187K		
RENAULT TRUCKS	KERAX Dxi	AV	410x175 MERITOR	19090	1909002	MAC9090/2	1909080	
RENAULT TRUCKS	KERAX Dxi	AR	410x200 MERITOR	19071	1907102	MAC9071/2	1907180	
RENAULT TRUCKS	KERAX Dxi	AR	410x225 MERITOR	19068	1906802	MAC9068/2	1906880	
RENAULT TRUCKS	MAGNUM AE	AR	414x150 RT	19934	1993402	MAC9934		
RENAULT TRUCKS	MAGNUM AE	AR	414x175 RT	19935	1993502	MAC9935		



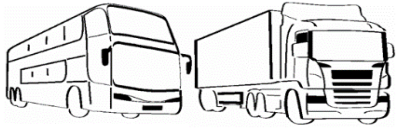

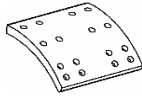

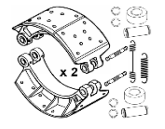
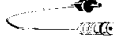
APPLICATION PAR VEHICULES APPLICATION BY VEHICLES

				WVA				
RENAULT TRUCKS	MAGNUM AE	AR	414x220 RT	19187	1918702	MAC9187		
RENAULT TRUCKS	MIDLINER M/S	AV	414x150 RT	19934	1993402	MAC9934		
RENAULT TRUCKS	MIDLINER M/S	AR	310x125 BENDIX	17352	17352xx	AB350929		
RENAULT TRUCKS	MIDLINER M/S	AR	325x150 BENDIX	19709	19709xx	AB350891		
RENAULT TRUCKS	MIDLINER M/S	AR	360x170 BENDIX	19255/19259	1925501	AB337220		
RENAULT TRUCKS	MIDLINER M/S	AR	414x150 BENDIX	19049/19199	1904902	MAC9049/199		
RENAULT TRUCKS	MIDLINER M/S	AR	414x150 RT	19934	1993402	MAC9934		
RENAULT TRUCKS	MIDLINER M/S	AR	414x175 RT	19935	1993502	MAC9935		
RENAULT TRUCKS	PREMIUM	AR	414x220 RT	19187	1918702	MAC9187		
RENAULT TRUCKS	PREMIUM Dxi	AV	410x175 MERITOR	19090	1909002	MAC9090/2	1909080	
RENAULT TRUCKS	PREMIUM Dxi	AR	410x200 MERITOR	19071	1907102	MAC9071/2	1907180	
RENAULT TRUCKS	PREMIUM Dxi	AR	410x225 MERITOR	19068	1906802	MAC9068/2	1906880	
RENAULT TRUCKS	R - MAJOR	AV	414x150 BENDIX	19049/19199	1904902	MAC9049/199		
RENAULT TRUCKS	R - MAJOR	AV	414x150 RT	19934	1993402	MAC9934		
RENAULT TRUCKS	R - MAJOR	AV	414x175 RT	19935	1993502	MAC9935		
RENAULT TRUCKS	R - MAJOR	AR	414x150 RT	19934	1993402	MAC9934		
RENAULT TRUCKS	R - MAJOR	AR	414x175 RT	19935	1993502	MAC9935		
RENAULT TRUCKS	SAVIEM	AV/AR	414x150 BENDIX	19049/19199	1904902	MAC9049/199		
ROR	TM, TE AC BRAKE - 17,5"		311x190 CO +0 mm	19604/19605	1960408		1960470	
ROR	LM Q+ BRAKE - 22,5"		419x177 CO +0 mm	19030/19033	1903001		1903070	
ROR	TM, TE Q BRAKE - 22,5"		419x178 CO +0 mm	19036/19037	1903712		1903770	
ROR	TM, TE Q BRAKE - 22,5"		419x178 CR +1 mm	19036/19037	1903713		1903771	
ROR	TM Z BRAKE - 22,5"		419x219 CO +0 mm	19369/19370	1936912		1936970	
ROR	TM Z BRAKE - 22,5"		419x219 CR +1 mm	19369/19370	1936913		1936971	
SAE DUPILLIER	S3220, S3320 - 17,5"		305x200 CO +0 mm	19762/19763	1976210		1976270	
SAF	RS 8442 SNF - 22,5"		420x180 CO +0 mm	19032	1903230		1903274	
SAF	RS 8442 SNF - 22,5"		420x180 CR +1 mm	19032	1903231		1903275	
SAF	WRZ6242 SNF - 22,5"		420x200 CO +0 mm	19094	1909437		1909474	
SAF	WRZ6242 SNF - 22,5"		420x200 CR +1 mm	19094	1909439		1909475	
SCANIA	C-K BUS	AV	412x178 SCANIA	19931	1993101			

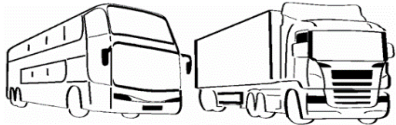

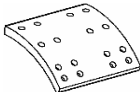

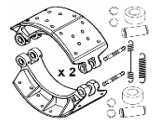
APPLICATION PAR VEHICULES APPLICATION BY VEHICLES

				WVA				
SCANIA	C-K BUS	AR	412x254	SCANIA	19933	1993301	MAC9933	
SCANIA	N - BUS	AV	412x178	SCANIA	19931	1993101		
SCANIA	N - BUS	AR	412x254	SCANIA	19933	1993301	MAC9933	
SCANIA	SERIE 3 - 93	AV	412x127	SCANIA	17991	1799101		
SCANIA	SERIE 3 - 93	AV	412x178	SCANIA	19931	1993101		
SCANIA	SERIE 3 - 93	AR	412x127	SCANIA	17991	1799101		
SCANIA	SERIE 3 - 93	AR	412x178	SCANIA	19931	1993101		
SCANIA	SERIE 3 - 93	AR	412x203	SCANIA	19932	1993201	MAC9932	
SCANIA	SERIE 3 - 113	AV	412x127	SCANIA	17991	1799101		
SCANIA	SERIE 3 - 113	AV	412x178	SCANIA	19931	1993101		
SCANIA	SERIE 3 - 113	AR	412x127	SCANIA	17991	1799101		
SCANIA	SERIE 3 - 113	AR	412x178	SCANIA	19931	1993101		
SCANIA	SERIE 3 - 113	AR	412x203	SCANIA	19932	1993201	MAC9932	
SCANIA	SERIE 3 - 113	AR	412x254	SCANIA	19933	1993301	MAC9933	
SCANIA	SERIE 3 - 143	AV	412x178	SCANIA	19931	1993101		
SCANIA	SERIE 3 - 143	AR	412x127	SCANIA	17991	1799101		
SCANIA	SERIE 3 - 143	AR	412x178	SCANIA	19931	1993101		
SCANIA	SERIE 3 - 143	AR	412x203	SCANIA	19932	1993201	MAC9932	
SCANIA	SERIE 3 - 143	AR	412x254	SCANIA	19933	1993301	MAC9933	
SCANIA	SERIE 4 - 94	AV	412x178	SCANIA	19931	1993101		
SCANIA	SERIE 4 - 94	AV	412x203	SCANIA	19932	1993201	MAC9932	
SCANIA	SERIE 4 - 94	AR	412x254	SCANIA	19933	1993301	MAC9933	
SCANIA	SERIE 4 - 94	AR	412x127	SCANIA	17991	1799101		
SCANIA	SERIE 4 - 94	AR	412x203	SCANIA	19932	1993201	MAC9932	
SCANIA	SERIE 4 - 94	AR	412x178	SCANIA	19931	1993101		
SCANIA	SERIE 4 - 114	AV	412x178	SCANIA	19931	1993101		
SCANIA	SERIE 4 - 114	AV	412x203	SCANIA	19932	1993201	MAC9932	
SCANIA	SERIE 4 - 114	AR	412x127	SCANIA	17991	1799101		
SCANIA	SERIE 4 - 114	AR	412x178	SCANIA	19931	1993101		
SCANIA	SERIE 4 - 114	AR	412x203	SCANIA	19932	1993201	MAC9932	

APPLICATION PAR VEHICULES APPLICATION BY VEHICLES

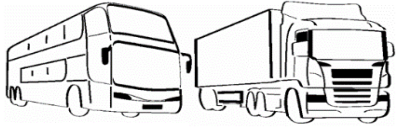
				WVA				
SCANIA	SERIE 4 - 114	AR	412x254	SCANIA	19933	1993301	MAC9933	
SCANIA	SERIE 4 - 124	AV	412x178	SCANIA	19931	1993101		
SCANIA	SERIE 4 - 124	AV	412x203	SCANIA	19932	1993201	MAC9932	
SCANIA	SERIE 4 - 124	AR	412x127	SCANIA	17991	1799101		
SCANIA	SERIE 4 - 124	AR	412x178	SCANIA	19931	1993101		
SCANIA	SERIE 4 - 124	AR	412x203	SCANIA	19932	1993201	MAC9932	
SCANIA	SERIE 4 - 124	AR	412x254	SCANIA	19933	1993301	MAC9933	
SCANIA	SERIE 4 - 144	AV	412x178	SCANIA	19931	1993101		
SCANIA	SERIE 4 - 144	AV	412x203	SCANIA	19932	1993201	MAC9932	
SCANIA	SERIE 4 - 144	AR	412x178	SCANIA	19931	1993101		
SCANIA	SERIE 4 - 144	AR	412x203	SCANIA	19932	1993201	MAC9932	
SCANIA	SERIE 4 - 144	AR	412x254	SCANIA	19933	1993301	MAC9933	
SMB	C3 - 17,5"		311x203	CO +0 mm	19608/19609	1986201		1960870
SMB	C2/L2 PROPARG P13, LUN, PSL - 22,5"		419x178	CO +0 mm	19613/19614	1961313		1961370
SMB	C2/L2 PROPARG P13, LUN, PSL - 22,5"		419x178	CR +1 mm	19613/19614	1961314		1961371
SMB	C1/L1 - 22,5"		419x203	CO +0 mm	19557/19606	1955713		1955770
SMB	C1/L1 - 22,5"		419x203	CR +1 mm	19557/19606	1955714		1955771
VOLVO TRUCKS	B-SERIE	AV	410x150	MERITOR	19941	1994102	MAC9941/2	
VOLVO TRUCKS	B-SERIE	AV	410x175	MERITOR	19090	1909002	MAC9090/2	1909080
VOLVO TRUCKS	B-SERIE	AV	410x200	MERITOR	19071	1907102	MAC9071/2	1907180
VOLVO TRUCKS	B-SERIE	AR	410x175	MERITOR	19090	1909002	MAC9090/2	1909080
VOLVO TRUCKS	B-SERIE	AR	410x225	MERITOR	19068	1906802	MAC9068/2	1906880
VOLVO TRUCKS	F - SERIE	AV	410x150	MERITOR	19941	1994102	MAC9941/2	
VOLVO TRUCKS	F - SERIE	AV	410x175	MERITOR	19090	1909002	MAC9090/2	1909080
VOLVO TRUCKS	F - SERIE	AV	410x200	MERITOR	19071	1907102	MAC9071/2	1907180
VOLVO TRUCKS	F - SERIE	AV	410x225	MERITOR	19068	1906802	MAC9068/2	1906880
VOLVO TRUCKS	F - SERIE	AR	410x150	MERITOR	19941	1994102	MAC9941/2	
VOLVO TRUCKS	F - SERIE	AR	410x175	MERITOR	19090	1909002	MAC9090/2	1909080
VOLVO TRUCKS	F - SERIE	AR	410x200	MERITOR	19071	1907102	MAC9071/2	1907180
VOLVO TRUCKS	F - SERIE	AR	410x225	MERITOR	19068	1906802	MAC9068/2	1906880

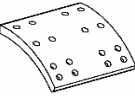
APPLICATION PAR VEHICULES APPLICATION BY VEHICLES

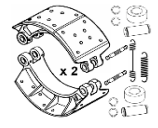
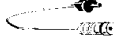
				WVA				
VOLVO TRUCKS	FH 12/16	AV	410x175 MERITOR	19090	1909002	MAC9090/2	1909080	
VOLVO TRUCKS	FH 12/16	AV	410x200 MERITOR	19071	1907102	MAC9071/2	1907180	
VOLVO TRUCKS	FH 12/16	AR2	410x125 MERITOR	17992	1799201	MAC7992/2		
VOLVO TRUCKS	FH 12/16	AR	410x200 MERITOR	19071	1907102	MAC9071/2	1907180	
VOLVO TRUCKS	FH 12/16	AR	410x225 MERITOR	19068	1906802	MAC9068/2	1906880	
VOLVO TRUCKS	FL 12/16	AV	410x175 MERITOR	19090	1909002	MAC9090/2	1909080	
VOLVO TRUCKS	FL 12/16	AR	410x225 MERITOR	19068	1906802	MAC9068/2	1906880	
VOLVO TRUCKS	FM 12/16	AV	410x175 MERITOR	19090	1909002	MAC9090/2	1909080	
VOLVO TRUCKS	FM 12/16	AR	410x200 MERITOR	19071	1907102	MAC9071/2	1907180	
VOLVO TRUCKS	FM 12/16	AR	410x225 MERITOR	19068	1906802	MAC9068/2	1906880	
VOLVO TRUCKS	FM 7	AV	410x175 MERITOR	19090	1909002	MAC9090/2	1909080	
VOLVO TRUCKS	FM 7	AR	410x200 MERITOR	19071	1907102	MAC9071/2	1907180	
VOLVO TRUCKS	FM 7	AR	410x225 MERITOR	19068	1906802	MAC9068/2	1906880	
VOLVO TRUCKS	N - SERIE	AV	410x150 MERITOR	19941	1994102	MAC9941/2		
VOLVO TRUCKS	N - SERIE	AV	410x175 MERITOR	19090	1909002	MAC9090/2	1909080	
VOLVO TRUCKS	N - SERIE	AV	410x200 MERITOR	19071	1907102	MAC9071/2	1907180	
VOLVO TRUCKS	N - SERIE	AV	410x225 MERITOR	19068	1906802	MAC9068/2	1906880	
VOLVO TRUCKS	N - SERIE	AR	410x150 MERITOR	19941	1994102	MAC9941/2		
VOLVO TRUCKS	N - SERIE	AR	410x175 MERITOR	19090	1909002	MAC9090/2	1909080	
VOLVO TRUCKS	N - SERIE	AR	410x200 MERITOR	19071	1907102	MAC9071/2	1907180	
VOLVO TRUCKS	N - SERIE	AR	410x225 MERITOR	19068	1906802	MAC9068/2	1906880	

Automotive

PIECES DE FREINAGE POUR GRUES MOBILES BRAKE PARTS FOR MOBILE CRANES

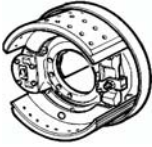
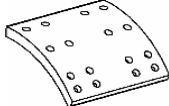
	OBS	DETAIL	WVA	
-----------------------------------------------------------------------------------	------------	---------------	------------	-------------------------------------------------------------------------------------

Garnitures de frein/ Brake lining

410x180	OLD	8 trous/holes rivet 10x18	19723	19723xx
410x180	NEW	10 trous/holes rivet 8x18	19113	19113xx
500x120	OLD	8 trous/holes rivet 10x18	17237	17237xx
500x120	NEW	10 trous/holes rivet 8x18	17374	17374xx
500x160	OLD	8 trous/holes rivet 10x18	19687	19687xx
500x160	NEW	10 trous/holes rivet 8x18	19042	19042xx
500x180	OLD	8 trous/holes rivet 10x18	19690	19690xx
500x180	NEW	10 trous/holes rivet 8x18	19041	19041xx

Ecarteurs / Expanders

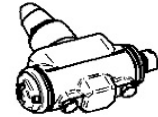

410x180	KNOTT	SIMPLEX		ECF005
410x180	KNOTT	DUPLEX		ECF006
410x180	PERROT	SIMPLEX		ECF003
410x180	PERROT	DUPLEX		ECF004
500x120	KNOTT	SIMPLEX		ECF005
500x120	PERROT	SIMPLEX		ECF003
500x160	KNOTT	SIMPLEX		ECF005
500x160	PERROT	SIMPLEX		ECF003
500x180	KNOTT	DUPLEX		ECF006
500x180	PERROT	DUPLEX		ECF004

Frein Simplex
Simplex Brake

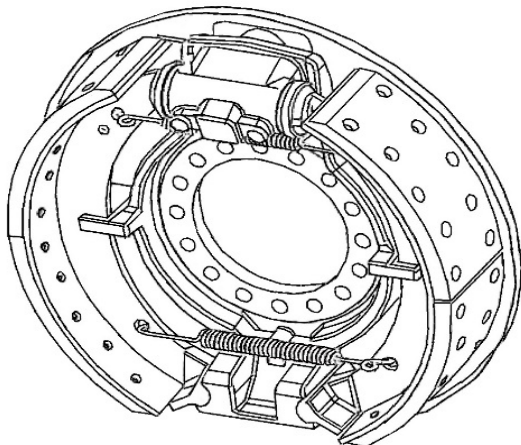

Frein Duplex
Duplex Brake

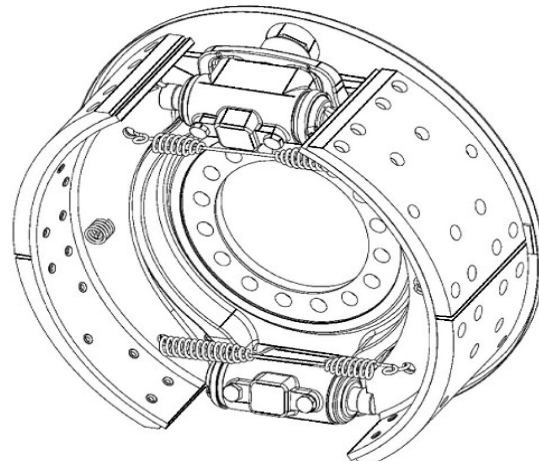

RECHERCHE GARNITURES DE FREIN PAR DIMENSIONS BRAKE LINING RESEARCH BY SIZE



Larg/ Width	Ø Tamb/ Drum	Nbr rivet/s et	Nbr	WVA	REF	Rivet Type	Rivet Textar	Rivet GIL	BFMC	
35	230,0	44	1+1+2	11019/11025/11582	1101901	4x10	86000800		MB/90/1; MB/91/03;	MERCEDES PERROT
45	305,0	52	2+2	13464/13465	13464xx	4x8	86000700		SA/15/1; SA/16/1;	RT
50	356,0	52	2+2	13053/13145	13053xx	4x8	86000700		RN/70/1; RN/71/1;	RT
55	260,0	52	2+2	13020/13532	1302001	4x10	86000800		MB/88/1; MB/89/2;	MERCEDES PERROT
70	300,0	52	2+2	15349/15350	1534906	6x15	87001300	RIV615	MB/70/1; MB/69/1;	MERCEDES
70	305,0	52	2+2	15831/15832	1583101	4x8	86000700		SA/20/1; SA/21/1;	RT
75	360,0	52	2+2	15104/15107	15104xx	4x8	86000700		RN/57/1; RN/58/1;	RT
76	330,2	48	4	15563	15563xx	L09	88000700	RIVL09	GG/149/1	FORD
80	270,0	52	2+2	15030/15742	1503002	5x10	86001500		MB/80/1; MB/81/3;	MERCEDES STEYR PERROT
80	305,0	48	4	15698	15698xx	4x8	86000700		SA/14/1	RT
80	305,0	48	8	15799	15799xx	6x15	87001300			SAE
80	325,0	52	2+2	15732/15733	1573204	6x12	86002200		FI/101/1; FI/100/1;	IVECO PERROT
80	400,0	40	4	15247	1524701	5x10	86001500		FD/86/1	BPW KAESSBOHRER SAF
80	400,0	64	4	15306	1530601	5x10	86001500			STEYR KNOTT
87	300,0	52	2+2	15059/15869	1505901	6x10	86002100		MB/107/1; MB/108/2;	MERCEDES
88	412,8	48	8	15185	15185xx	6,3x18	85000400		SV/7/1	SCANIA
90	300,0	40	4	15057	15057xx	8x15	85000600	RIV815	MB/64/1	MERCEDES
90	308,0	40	4	15162	1516203	8x15	85000600	RIV815	MB/116/2	MERCEDES
90	325,0	60	2+2	15586/15589	15586xx	5x10	86001500			HANOMAG
90	406,0	64	4	15282	15282xx	5x15	86001700		BT/48/1	RT
90	420,0	64	4	15207	1520704	8x18	85000700	RIV818	FI/79/2	IVECO
90	420,0	64	4	15336	15336xx	8x15	85000600	RIV815	FI/80/1	IVECO
90	420,0	64	4	15494	15494xx	8x18	85000700	RIV818	FI/84/1	IVECO
98	304,0	52	2+2	15580/15581	1558008	6x10	86002100		MB/94/1; MB/95/1;	MERCEDES
98	325,0	44	2+2	15817/15823	1581702	8x20	86002900		MP/37/1; MP/38/1;	DAF LEYLAND MAN PERROT
99	325,0	48	8	15879	1587906	8x15	87001500	RIV815	GG/209/1	MAN STEYR
100	300,0	64	8	17347	1734703	8x15	85000600	RIV815		BPW
100	310,0	52	2+2	17099/17096	1709601	6x12	86002200		PB/26/1; PB/23/1;	IVECO
100	310,0	56	2+2	17829/17799	17829xx	5x12	86001600		BT/76/1; SA/25/1;	RT

Les garnitures de frein avec suffixes xx sont livrables sous 48-72 heures

Brake linings xx suffixes are available in 48-72 hours

RECHERCHE GARNITURES DE FREIN PAR DIMENSIONS BRAKE LINING RESEARCH BY SIZE



Larg/ Width	Ø Tamb/ Drum	Nbr rivet/s et	Nbr	WVA	REF	Rivet Type	Rivet Textar	Rivet GIL	BFMC	
100	325,0	52	2+2	17924/17925	1792408	6x12	86002200		FI/120/1; FI/121/1;	IVECO PERROT
100	325,0	72	4	17744	17744xx	5x12	86001600			RT
100	327,0	52	2+2	17776/17793	1740805	6x12	86002200		OM/12/1; FI/102/1;	IVECO PERROT
100	356,0	60	2+2	17497/17498	17497xx	5x15	86001700		BT/52/1; BT/53/1;	RT
100	356,0	64	2+2	17582/17805	17805xx	5x12	86001600		BT/53/1; SA/24/1;	RT
100	400,0	32	2+2	17792/17794	17792xx	6x12	86002200		FI/108/1; FI/109/1;	IVECO
100	400,0	48	4	17094	1709401	8x15	86002700	RIV815	SY/7/1	IVECO PERROT
100	400,0	56	2+2	17050/17051	17050xx	6x12	86002200		MF/1/1; MF/2/1;	PERROT
100	406,0	48	8	17760	17760xx	6x15	87001300			SAE
100	406,0	54	2+2	17247/17305	17247xx	5x12	86001600		SA/8/1; SA/9/1;	COLAERT RT
100	406,0	80	2+2	17500/17506	17500xx	5x12	86001600			RT
100	410,0	64	8	17739	17739xx	8x18	85000700	RIV818		MERCEDES
100	418,0	64	8	17297	17297xx	8x15	85000600	RIV815	MB/67/1	MERCEDES
100	441,4	64	8	17669	17669xx	10x18	87002000	RIV1018		PERROT
100	500,0	64	8	17273	17273xx	10x18	87002000	RIV1018		PERROT
101	406,4	80	4+4	17383/17384	17383xx	6,5x17,6	85001700		DF/10/3; DF/11/3;	DAF
102	300,0	52	2+2	17350/17973	1735003	6x10	86002100		MB/100/1; MB/101/2;	MERCEDES
104	308,0	40	4	17278	1727806	8x15	85000600	RIV815	MB/109/2	MERCEDES
106	409,4	64	2+2	17854/17855	17854xx	L09	88000700	RIVL09	BO/54/1; BO/53/1;	BEDFORD
108	387,4	48	4	17134	17134xx	L09	88000700	RIVL09	GG/77/1	FORD
108	387,4	56	4	17557	17557xx	L09	88000700	RIVL09	GG/157/1	FORD
114	393,7	48	2+2	17117/17116	17116xx	L12	88000900	RIVL11	LE/63/1; LE/63/2;	LEYLAND
119	308,0	40	4	17280	1728006	8x15	85000600	RIV815	MB/110/1; MB/110/2;	MERCEDES
120	325,0	52	2+2	17088/17635	1708802	6x12	86002200		SY/20/2; SY/26/1;	IVECO OM PERROT
120	325,0	60	2+2	17827/17828	1782704	5x12	86001600		SA/28/1; SA/29/1;	DAF IVECO RT
120	325,0	64	4	17339	17339xx	6x12	86002200			PERROT
120	400,0	48	4	17275	17275xx	8x15	86002700	RIV815	KM/10/1	IVECO
120	400,0	64	8	17115	1711501	8x15	85000600	RIV815	BC/39/1	BPW SAE SAF
120	400,0	64	8	17001	1700101	8x15	85000600	RIV815		BPW SAF

Les garnitures de frein avec suffixes xx sont livrables sous 48-72 heures

Brake linings xx suffixes are available in 48-72 hours

RECHERCHE GARNITURES DE FREIN PAR DIMENSIONS BRAKE LINING RESEARCH BY SIZE



Larg/ Width	Ø Tamb/ Drum	Nbr rivet/s et	Nbr	WVA	REF	Rivet Type	Rivet Textar	Rivet GIL	BFMC	
120	408,0	64	8	17259	17259xx	8x15	85000600	RIV815	MB/56/1	MERCEDES
120	410,0	64	8	17682	1768202	8x15	85000600	RIV815	MP/29/1	MAN MERCEDES
120	410,0	80	8	17405	1740501	8X15	85000600	RIV815		BPW
120	418,0	64	8	17298	17298xx	8x15	85000600	RIV815	MB/68/1	MERCEDES
120	420,0	48	8	17888	1788802	8x18	85000700	RIV818		IKARUS
120	420,0	64	8	17184	1718401	8x18	85000700	RIV818		KAROSA LIAZ
120	420,0	80	8	17377	1737707	8x15	85000600	RIV815	BC/78/1	BPW KAESSBOHRER SAF
120	500,0	64	8	17237	17237xx	10x18	87002000	RIV1018	PB	PERROT
120	500,0	80	8	17374	17374xx	8x20	86002900		PB	PERROT
121	300,0	52	2+2	17351/17975	1735103	6x10	86002100		MB/117/1; MB/118/2;	MERCEDES
123	410,0	64	8	17992	1799201	L09	88000700	RIVL09	VL/85/1	VOLVO
124	330,2	48	4	17217	17217xx	L09	88000700	RIVL09	GG/194/1	DAF FORD
125	305,0	48	8	17592	17592xx	6x15	87001300			SAE
125	305,0	48	4	17612	17612xx	6x15	87001300			TRAILOR
125	305,0	48	4+4	17897/17898	17897xx	8x18	87001600	RIV818		SAE
125	310,0	64	2+2	17831/17832	1783102	5x12	86001600		SA/27/1; SA/26/1;	DAF RT VOLVO
125	310,0	72	4	17352	17352xx	5x12	86001600		RN/104/1	RT
125	406,0	48	8	17761	17761xx	6x15	87001300			SAE
125	406,0	96	2+2	17307/17308	17307xx	5x15	86001700		BT/54/1; BT/55/1;	RT
125	406,0	104	2+2	17704/17705	17704xx	5x15	86001700		BT/69/1; BT/70/1;	RT
125	414,0	96	2+2	17309/17531	17309xx	6x15	87001300		BT/57/7; BT/56/7;	RT
125	420,0	64	4	17481	1748107	8x15	86002700	RIV815	FI/86/2	IVECO VANHOOL
125	420,0	96	4	17482	1748206	8x18	85000700	RIV818	FI/94/1	IVECO
127	330,2	48	4	17560	17560xx	L09	88000700	RIVL09	GG/156/1	FORD
127	393,7	48	4	17316	17316xx	L09	88000700	RIVL09	GG/153/1; FD/153/1;	FORD
127	393,7	64	4	17804	17804xx	6x15	86002300		DO/80/2	RT
127	406,4	80	4+4	17324/17325	17324xx	6,5x17,6	85001700		DF/15/3; DF/14/3;	BOVA DAF
127	409,4	64	2+2	17714/17713	17713xx	L09	88000700	RIVL09	BO/56/1; BO/55/1;	BEDFORD
127	412,7	72	4+4	17664/17665	1766402	L10	88000800	RIVL10	VL/71/1; VL/70/1;	VOLVO

Les garnitures de frein avec suffixes xx sont livrables sous 48-72 heures

Brake linings xx suffixes are available in 48-72 hours

RECHERCHE GARNITURES DE FREIN PAR DIMENSIONS BRAKE LINING RESEARCH BY SIZE



Larg/ Width	Ø Tamb/ Drum	Nbr rivet/s et	Nbr	WVA	REF	Rivet Type	Rivet Textar	Rivet GIL	BFMC	
127	412,8	32	4	17991	1799101	S38	85002100	RIVS38	SV/39/2	SCANIA
127	412,8	64	8	17161	1716101	6,3x18	85000400		SV/26/1	SCANIA
127	419,0	80	4+4	17012/17013	17012xx	6,5x17,6	85001700		DF/41/1; DF/40/1;	DAF
127	419,1	80	4+4	17263/17264	1726301	6,5x17,6	85001700		DF/22/3; DF/23/3;	DAF NEOPLAN
129	364,0	56	4+4	17290/17950	1729006	8x15	85000600	RIV815	MB/111/1; MB/112/1;	MERCEDES
134	308,0	40	4	17287	1728705	8x15	85000600	RIV815	MB/115/1; MB/115/2;	MERCEDES
135	300,0	40	4	17409	1740910	8x15	87001500	RIV815	MB/71/1	MERCEDES
135	420,0	64	8	17885	17885xx	8x18	85000700	RIV818	FI/113/1	IVECO
138	420,0	48	8	17746	17746xx	8x18	85000700	RIV818		IKARUS
139	360,0	112	4+4	17357/17358	17357xx	L09	88000700	RIVL09	GG/233/1; GG/234/1;	VOLVO
140	325,0	48	4	17688	1768801	6x12	86002200		SY/22/1	IVECO
140	325,0	52	2+2	17879/17880	17880xx	6x12	86002200		SY/32/1; SY/22/1;	IVECO
140	325,0	56	4	17879	17879xx	6x12	86002200		SY/32/1; FI/126/1;	IVECO
140	400,0	48	4	17248	17248xx	8x18	85000700	RIV818	BC/32/2	IVECO
140	400,0	56	2+2	17270/17269	17269xx	8x15	86002700	RIV815	BC/33/1; BC/32/1;	IVECO
140	410,0	64	4+4	17742/17743	17742xx	10x18	87002000	RIV1018	PB/10/1; PB/9/1;	KAESSBOHRER
140	410,0	64	8	17238	1723802	8x15	85000600	RIV815	MP/30/2	MAN MERCEDES
140	410,0	72	4+4	17971/17972	17971xx	6x15	87001300		PD/6/1; PD/5/1;	PEGASO
140	418,0	64	8	17105	17105xx	8x15	85000600	RIV815	MB/65/1	MERCEDES
140	420,0	48	4	17300	17300xx	10x18	87002000	RIV1018	KM/11/1	MAN
140	420,0	56	4+4	17869/17870	17869xx	8x18	85000700	RIV818	FI/105/1; FI/100/1;	IVECO
140	420,0	56	4+4	17410/17411	17410xx	10x18	87002000	RIV1018	MP/35/1; MP/34/1;	MAN
140	420,0	64	4	17323	17323xx	8x15	86002700	RIV815	FI/81/1	IVECO
140	420,0	80	8	17456	1745605	8x18	85000700	RIV818	BC/109/1	BPW
140	430,0	64	8	17276	1727601	8x20	86002900		MB/60/1	MERCEDES
140	440,0	64	8	17285	17285xx	8x18	85000700	RIV818	BC/2/1	MAN
143	360,0	112	8	17017	1701703	8x15	85000600	RIV815	GG/217/1	MAN RT
143	410,0	72	4+4	17795/17796	1779501	8x18	85000700	RIV818	MB/83/1; MB/82/1;	MERCEDES
147	325,0	44	2+2	17900/17901	1790007	8x20	86002900		MP/39/1; MP/40/1;	DAF LEYLAND MAN NEOPLAN PERROT

Les garnitures de frein avec suffixes xx sont livrables sous 48-72 heures

Brake linings xx suffixes are available in 48-72 hours

RECHERCHE GARNITURES DE FREIN PAR DIMENSIONS BRAKE LINING RESEARCH BY SIZE

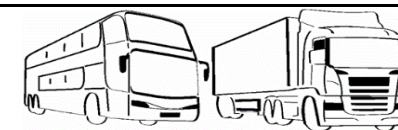

Larg/ Width	Ø Tamb/ Drum	Nbr rivet/s et	Nbr	WVA	REF	Rivet Type	Rivet Textar	Rivet GIL	BFMC	
148	410,0	96	8	19941	1994102	L09	88000700	RIVL09	VL/86/1	VOLVO
148	420,0	64	4+4	19010/19011	1901005	6,5x17,6	85001700		DF/45/1; DF/44/1;	DAF
149	325,0	64	8	17988	1798806	8x15	87001500	RIV815	GG/210/1	MAN STEYR
150	300,0	64	4+4	19517/19518	1951701	8x15	85000600	RIV815	SJ/25/1; SJ/24/1;	SAE SAF
150	300,0	64	8	19102	1910205	8x15	85000600	RIV815	BC/54/1	BPW SAF
150	300,0	64	8	19573	1957306	8x15	85000600	RIV815	BC/79/1	BPW
150	300,0	64	8	19396	19396xx	8x15	85000600	RIV815		BPW
150	300,0	64	8	19596	1959601	8x18	85000700	RIV818		WARSTEIN
150	305,0	48	4+4	19760/19761	1976002	8x18	87001600	RIV818	SA/36/1; SA/37/1;	SAE
150	305,0	64	8	19401	19401xx	5x15	86001700		SJ/36/1	SAE
150	325,0	64	2+2	19620/19621	1962004	5x12	86001600		SA/31/1; SA/30/1;	DAF IVECO RT
150	325,0	72	4	19709	19709xx	5x12	86001600		RN/106/1	RT
150	335,0	64	8	17362	17362xx	L09	88000700	RIVL09	YK/13/1	YORK
150	356,0	64	8	19544	19544xx	5x15	86001700		RW/29/2	TRAILOR
150	356,0	80	4+4	19912/19913	1991201	8x18	85000700	RIV818	LZ/5/1; LZ/4/1;	SAE SAF TRAILOR
150	400,0	80	4+4	19168/19169	19168xx	8x18	85000700	RIV818	BC/92/1; BC/93/1;	KAESSBOHRER
150	410,0	96	4+4	19144/19145	19144xx	6x18	86002400		SV/43/1; SV/44/1;	SISU
150	414,0	64	8	19934	1993402	8x18	85000700	RIV818	RN/100/1	RT
150	414,0	72	4	19919	19919xx	8x18	85000700	RIV818	BT/84/1	RT
150	414,0	96	2+2	19049/19199	1904902	6x15	87001300		SA/10/1; SA/11/1;	RT
150	414,0	104	4	19680	19680xx	6x15	87001300		SA/34/1	RT
150	419,0	96	4+4	19672/19673	19672xx	5x14,2	85000500		FT/8/1; FT/9/1;	FRUEHAUF
150	420,0	64	4+4	19900/19901	1990002	L10	88000800	RIVL10	DF/34/1; DF/35/1;	DAF
150	420,0	64	8	19410	1941001	8x18	85000700	RIV818		KAROSA LIAZ
151	414,0	64	4+4	19359/19360	19359xx	6x18	86002400			TRAILOR
152	381,0	64	8	19502	19502xx	L10	88000800	RIVL10		MACK
152	393,7	48	4+4	19583/19584	19583xx	L10	88000800	RIVL10	LE/67/1; LE/68/1;	SCAMMELL
152	393,7	48	4	19172	19172xx	L09	88000700	RIVL09	AL/49/1	LEYLAND
152	393,7	48	4	19351	19351xx	L09	88000700	RIVL09	GG/140/1	FORD

Les garnitures de frein avec suffixes xx sont livrables sous 48-72 heures

Brake linings xx suffixes are available in 48-72 hours

RECHERCHE GARNITURES DE FREIN PAR DIMENSIONS BRAKE LINING RESEARCH BY SIZE



Larg/ Width	Ø Tamb/ Drum	Nbr rivet/s et	Nbr	WVA	REF	Rivet Type	Rivet Textar	Rivet GIL	BFMC	
152	393,7	48	4	19072	19072xx	L09	88000700	RIVL09	GG/83/1	LEYLAND
152	393,7	64	8	19905	19905xx	L09	88000700	RIVL09	CW/10/1	FORD
152	393,7	64	4	19622	19622xx	6x15	87001300		LH/82/2	RT
152	393,7	96	8	19662	19662xx	L12	88000900	RIVL11		LEYLAND
152	412,7	88	4+4	19560/19561	1956002	L10	88000800	RIVL10	VL/74/1; VL/75/1;	VOLVO
152	419,0	80	4+4	19024/19031	1902401	6,5x17,6	85001700		DF/43/1; DF/42/1;	DAF
152	419,1	64	4+4	19118/19117	19117xx	L10	88000800	RIVL10	DF/20/1; DF/21/1;	DAF
152	419,1	80	4+4	19150/19151	1915002	L09	88000700	RIVL09	DF/20/3; DF/21/3;	BOVA DAF
155	410,0	48	4	18017	18017xx	L10	88000800	RIVL10	LE/70/1	LEYLAND
159	364,0	56	4+4	19506/19845	1950607	8x15	85000600	RIV815	MB113/1; MB/114/1;	MERCEDES
160	325,0	52	2+2	19821/19822	19821xx	6x12	86002200		SY/33/1; SY/34/1;	IVECO
160	360,0	72	4+4	19952/19953	1995201	8x15	85000600	RIV815	BC/104/1; BC/105/1;	BPW
160	370,0	64	8	19125	19125xx	8x15	85000600	RIV815	MB/61/1	MERCEDES
160	410,0	64	4+4	19849/19850	1984906	10x18	87002000	RIV1018	PB/17/1; PB/16/1;	KAESSBOHRER PERROT
160	410,0	64	4+4	19634/19635	19634xx	10x18	87002000	RIV1018	PB/27/1; PB/28/1;	KAESSBOHRER
160	410,0	64	8	19494 (ex 19486)	1949402	8x15	85000600	RIV815	MP/31/2	MERCEDES
160	410,0	64	8	19713	1971301	8x15	85000600	RIV815		MAN
160	410,0	72	4+4	19579/19580	1957901	8x18	85000700	RIV818	MB/75/1; MB/74/1;	MAN MERCEDES
160	410,0	72	4+4	19579/19706	1970601	8x18	85000700	RIV818	MB/75/1; MB/74/2;	MERCEDES
160	410,0	100	4+4	19877/19878	1987701	6x15	87001300		PD/8/1; PD/7/1;	PEGASO
160	418,0	64	8	19182	19182xx	8x15	85000600	RIV815	MB/66/1	MERCEDES
160	420,0	32	4	19245	19245xx	10x18	87002000	RIV1018	SY/23/1	STEYR
160	420,0	64	8	19411	1941101	8x18	85000700	RIV818		TATRA
160	420,0	80	8	19200	1920005	8x15	85000600	RIV815	BC/35/1	BPW FRUEHAUF SAE SAF
160	440,0	60	4+4	19473/19474	19473xx	10x18	87002000	RIV1018	MP/25/1; MP/26/1;	MAN
160	440,0	60	2+2	19153/19154	19153xx	8x18	85000700	RIV818		IVECO
160	500,0	64	8	19687	19687xx	10x18	87002000	RIV1018		PERROT
160	500,0	80	8	19042	19042xx	8x20	86002900			PERROT
163	360,0	96	8	19177	1917705	8x15	85000600	RIV815	GG/218/1	MAN TVM

Les garnitures de frein avec suffixes xx sont livrables sous 48-72 heures

Brake linings xx suffixes are available in 48-72 hours

RECHERCHE GARNITURES DE FREIN PAR DIMENSIONS BRAKE LINING RESEARCH BY SIZE



Larg/ Width	Ø Tamb/ Drum	Nbr rivet/s et	Nbr	WVA	REF	Rivet Type	Rivet Textar	Rivet GIL	BFMC	
169	360,0	84	2+2	19269/19272	1926901	L09	88000700	RIVL09	GG/208/1; GG/207/1;	VOLVO
169	360,0	96	4+2	19543/19552	19543xx	L09	88000700	RIVL09	GG/214/1; GG/215/1;	VOLVO
170	360,0	72	4	19918	19918xx	8x15	87001500	RIV815	FI/124/1	IVECO
170	360,0	72	4	19503	1950308	8x16	85002200	RIV815	PB/22/1	DAF DENNIS IVECO LEYLAND PERROT
170	360,0	72	4	19225	1922507	8x18	87001600	RIV818		DENNIS IVECO NEOPLAN PERROT
170	360,0	80	2+2	19255/19259	1925501	5x12	86001600		RN/102/1; RN/103/1;	RT
170	360,0	88	4	19923	19923xx	L09	88000700	RIVL09	GG/211/1	DAF
170	360,0	96	8	19306	19306xx	L10	88000800	RIVL10	GG/216/1	DAF
170	360,0	96	8	19928	1992802	L10	88000800	RIVL10	RW/26/1	NISSAN STEYR
170	360,0	112	4+4	19758/19759	1975803	L09	88000700	RIVL09	GG/235/1; GG/236/1;	VOLVO
170	440,0	64	8	19160	1916001	8x20	86002800		MB/51/1	MERCEDES
173	410,0	112	8	19090 (ex 19938)	1909002	L11	88000900	RIVL11	VL/87/2	RT VOLVO
173	420,0	96	4+4	19052/19055	1905201	6,5x17,6	85001700		DF/47/1; DF/46/1;	DAF
175	393,7	72	8	19684	19684xx	L10	88000800	RIVL10	GG/180/1	DENNIS LEYLAND
175	414,0	64	8	19935	1993502	8x18	85000700	RIV818	RN/101/1	RT
175	414,0	72	8	19463	1946301	8x18	85000700	RIV818	BT/59/5	RT
175	414,0	84	4	19655	19655xx	8x18	85000700	RIV818	BT/59/7	RT
175	414,0	92	2+2	19548/19549	19548xx	6x18	86002400		LF/100/1; LF/101/1;	RT
175	414,0	104	4	19682	19682xx	6x15	87001300		SA/35/1	RT
175	420,0	96	4+4	19888/19889	1988802	L10	88000800	RIVL10	DF/37/1; DF/36/1;	DAF
177	311,0	96	4+4	19783/19784	19783xx	L09	88000700	RIVL09	MQ/3/3; MQ/4/3;	ROR
177	393,7	64	8	19771	19771xx	L09	88000700	RIVL09	GG/155/1	DENNIS LEYLAND
177	393,7	68	2+2	19179/19178	19178xx	L12	88000900	RIVL11	LE/64/2; LE/64/1;	LEYLAND
177	393,7	72	4	19111	1911101	L09	88000700	RIVL09	GG/92/1	ERF FORD LEYLAND PEGASO YORK
177	393,7	96	8	19744	19744xx	L10	88000800	RIVL10	CS/63/1	DENNIS ERF
177	393,7	96	8	18008	18008xx	L09	88000700	RIVL09	CS/68/2	DENNIS
177	412,8	96	8	19075	1907502	6,3x18	85000400		SV/8/1	NEOPLAN SCANIA
177	419,1	80	8	19746	19746xx	8x18	85000700	RIV818	FO/34/1	FODEN
177	419,1	96	4+4	19030/19033	1903001	L09	88000700	RIVL09	RW/34/1; RW/35/1;	ROR

Les garnitures de frein avec suffixes xx sont livrables sous 48-72 heures

Brake linings xx suffixes are available in 48-72 hours

RECHERCHE GARNITURES DE FREIN PAR DIMENSIONS BRAKE LINING RESEARCH BY SIZE



Larg/ Width	Ø Tamb/ Drum	Nbr rivet/s et	Nbr	WVA	REF	Rivet Type	Rivet Textar	Rivet GIL	BFMC	
177	419,1	96	4+4	19981/19982	1998101	L09	88000700	RIVL09		ROR
178	381,0	96	6+2	19384/19385	1938414	10.10	85001400		CW/4/1; CW/4/2;	IVECO VANHOOL VOLVO ROCKWELL
178	393,5	84	4+4	19467/19468	1946703	L11	88000900	RIVL11	VL/73/2; VL/72/1;	VOLVO
178	393,7	96	4+4	19333/19334	1933301	L09	88000700	RIVL09	YK/7/2; YK/6/2;	YORK
178	393,7	128	8	19887	19887xx	L09	88000700	RIVL09	CW/11/1	FORD
178	412,8	64	4	19931	1993101	S38	85002100	RIVS38	SV/40/2	SCANIA
178	419,1	96	4+4	19036/19037	1903616	5x14,2	85000500		DF/24/1; DF/25/1;	TRAILOR
178	419,1	96	4+4	19036/19037	1903712	L09	88000700	RIVL09	IL/66/3; IL/67/3;	ROR
178	419,1	112	4+4	19256/19260	1925602	L09	88000700	RIVL09	DF/16/2; DF/17/2;	BOVA DAF NEOPLAN
178	419,1	128	4+4	19613/19614	1961313	5x14,2	85000500		FT/12/1; FT/11/1;	SMB C2
178	420,0	64	4+4	19283/19284	1928308	8x15	85000600	RIV815	SJ/28/1; SJ/29/1;	SAE SAF
178	420,0	112	8	19896	19896xx	L10	88000800	RIVL10	AX/14/6	VAN HOOL
180	305,0	64	4	19444	19444xx	6x15	87001300			TRAILOR
180	367,0	64	4+4	19479/19480	1947905	8x15	86002700	RIV815	SJ/32/1; SJ/33/1;	SAE SAF
180	381,0	96	8	19492	19492xx	L09	88000700	RIVL09	RW/24/1	VOLVO
180	410,0	64	4+4	19558/19559	19558xx	10x18	87002000	RIV1018	PB/11/1; PB/12/1;	KAESSBOHRER
180	410,0	64	4+4	19855/19856	1985502	10x18	87002000	RIV1018	PB/29/1; PB/30/1;	KAESSBOHRER PERROT
180	410,0	64	8	19495 (ex 19487)	1949502	8x18	85000700	RIV818	MP/32/2	MAN MERCEDES STEYR
180	410,0	64	8	19723	19723xx	10x18	87002000	RIV1018	PB/40/1	PERROT
180	410,0	64	4+4	19946/19947	19946xx	10x18	87002000	RIV1018		VAN HOOL
180	410,0	72	4	18018	18018xx	L10	88000800	RIVL10	LE/71/1	LEYLAND
180	410,0	80	8	19113	19113xx	8x20	86002900			PERROT
180	410,0	80	8	19081	1908101	8x15	85000600	RIV815		BPW
180	410,0	96	4+2+2	19556/19714/19715	1971401	8x18	87001500	RIV818	RW/28/1; RW/30/1; RW/31/1	IVECO ROCKWELL
180	410,0	96	6+2	19555/19556	1955502	8x18	87001500	RIV818	RW/28/2; RW/28/1;	IVECO ROCKWELL
180	410,0	96	4+4	19109/19110	1910902	8x15	87001500	RIV815	RW/36/1; RW/37/1;	IVECO
180	410,0	112	8	19342	1934202	8x16	85002200		PB/25/2	IVECO PERROT
180	419,0	64	8	19449	19449xx	8x18	85000700	RIV818		TATRA
180	420,0	72	8	19235	1923502	8x18	85000700	RIV818		IKARUS RABA

Les garnitures de frein avec suffixes xx sont livrables sous 48-72 heures

Brake linings xx suffixes are available in 48-72 hours

RECHERCHE GARNITURES DE FREIN PAR DIMENSIONS BRAKE LINING RESEARCH BY SIZE



Larg/ Width	Ø Tamb/ Drum	Nbr rivet/s et	Nbr	WVA	REF	Rivet Type	Rivet Textar	Rivet GIL	BFMC	
180	420,0	80	8	19032	1903230	8x15	85000600	RIV815	BC/98/1	BPW
180	420,0	80	8	19191	1919101	8x15	85000600	RIV815		BPW
180	420,0	96	8	19972	1997201	8x15	85000700	RIV815		KAROSA
180	420,0	112	8	19236	1923601	8x18	85000700	RIV818		IKARUS
180	420,0	128	8	19694	19694xx	8x18	85000700	RIV818	FI/106/1	IVECO VAN HOOL
180	440,0	60	4+4	19475/19476	19475xx	10x18	87002000	RIV1018	MP/27/1; MP/28/1;	MAN
180	500,0	64	8	19690	19690xx	10x18	87002000	RIV1018	PB/13/1	PERROT
180	500,0	112	8	19041	19041xx	8x20	86002900			PERROT
182	410,0	96	6+2	19099/19100	1909902	8x16	85002200		PB/41/1; PB/41/2;	IVECO
183	360,0	96	8	19708	1970803	8x15	85000600	RIV815	GG/232/1	MAN
185	420,0	64	8	19246	19246xx	10x18	87002000	RIV1018	SY/24/1	STEYR
190	310,0	80	4+4	19604/19605	1960408	L10	88000800	RIVL10	RW/9/3; RW/13/3;	ROR
198	410,0	112	8	19071 (ex 19939)	1907102	L11	88000900	RIVL11	VL/88/2	DAF DENNIS IRISBUS RT VOLVO
198	420,0	128	4+4	19063/19064	1906303	6,5x17,6	85001700		DF/49/1; DF/48/1;	DAF
199	393,7	128	4+4	19820	19820xx	L09	88000700	RIVL09	GG/189/1	LEYLAND
200	300,0	64	4+4	19515/19516	1951512	8x15	85000600	RIV815	SJ/23/1; SJ/22/1;	KAESSBOHRER LAG SAF PERROT
200	300,0	64	8	19103	1910301	8x15	85000600	RIV815	BC/55/1	BPW KAESSBOHRER SAE SAF
200	300,0	64	8	19574	1957427	8x15	85000600	RIV815	BC/80/1	BPW GIGANT
200	300,0	64	8	19397	19397xx	8x15	85000600	RIV815		BPW
200	300,0	64	8	19568	1956801	8x15	85000600	RIV815		KAESSBOHRER
200	300,0	96	4+4	19967/19968	1996708	5x14,2	85000500		BC/106/1; BC/107/1;	TRAILOR
200	305,0	56	4	19996	19996xx	8x15	85000600	RIV815	LZ/1/1	COLAERT
200	305,0	64	4+4	19762/19763	1976210	8x18	87001600	RIV818	LZ/2/1; LZ/3/1;	SAE
200	305,0	80	8	19405	19405xx	6x15	87001300			SAE
200	335,0	96	8	19700	19700xx	L09	88000700	RIVL09	YK/12/1	YORK
200	350,0	80	4+4	19908/19909	1990803	L10	88000800	RIVL10	RW/21/1; RW/22/1;	ROR
200	355,0	80	4+4	19892/19893	1989208	8x18	85000700	RIV818	SJ/26/1; SJ/27/1;	SAE SAF
200	360,0	72	4+4	19902/19903	1990210	8x15	85000600	RIV815	BC/100/1; BC/101/1;	BPW
200	360,0	96	4+4	19718/19719	1971802	5x14,2	85000500			SMB C5

Les garnitures de frein avec suffixes xx sont livrables sous 48-72 heures

Brake linings xx suffixes are available in 48-72 hours

RECHERCHE GARNITURES DE FREIN PAR DIMENSIONS BRAKE LINING RESEARCH BY SIZE



Larg/ Width	Ø Tamb/ Drum	Nbr rivet/s et	Nbr	WVA	REF	Rivet Type	Rivet Textar	Rivet GIL	BFMC	
200	364,0	56	4+4	19505/19112	1950505	8x15	85000600	RIV815	MB/120/1; MB/121/1;	MERCEDES
200	367,0	64	4+4	19490/19491	1949005	8x15	86002700	RIV815	SJ/34/1; SJ/35/1;	SAE SAF
200	381,0	96	8	19542	1954201	L09	88000700	RIVL09	RW/25/1	LEYLAND VOLVO
200	393,7	72	8	19685	19685xx	L10	88000800	RIVL10	GG/179/1	DENNIS LEYLAND
200	400,0	80	4+4	19166/19167	1916602	8x18	85000700	RIV818	BC/91/1; BC/90/1;	KAESSBOHRER
200	410,0	96	4+2+2	19553/19716/19717	1971612	8x15	87001500	RIV815	RW/29/1; RW/32/1; RW/33/1	IVECO ROCKWELL
200	410,0	96	6+2	19786/19823	1978611	10x18	87002000	RIV1018	PB/3/1; PB/4/1;	IVECO VANHOOL
200	410,0	96	6+2	19553/19554	1955301	8x15	87001500	RIV815	RW/29/1; RW/29/2;	IVECO ROCKWELL
200	410,0	96	4+4	19116/19119	1911602	8x15	87001500	RIV815	RW/38/1; RW/39/1;	IVECO
200	410,0	96	8	19786	1978610	10x18	87002000	RIV1018	PB/3/1	IVECO VANHOOL
200	410,0	104	4+4	19880/19882	19880xx	6x15	87001300			PEGASO
200	410,0	112	8	19343	1934302	8x16	85002200		PB/24/2	IVECO PERROT
200	410,0	128	8	18014	18014xx	L11	88000900	RIVL11	RW/27/1	ASTRA
200	414,0	64	8	19974	19974xx	8x18	85000700	RIV818		RT
200	414,0	92	2+2	19406/19407	19406xx	6x18	86002400		LF/102/1; LF/103/1;	COLAERT
200	420,0	64	4+4	19477/19478	1947706	8x15	85000600	RIV815	SJ/30/1; SJ/31/1;	SAE SAF
200	420,0	64	8	19338	19338xx	8x15	85000600	RIV815	FT/5/1	CODER
200	420,0	80	4+4	19251/19252	19251xx	8x15	85000600	RIV815	BL/36/1; BL/35/1;	MOL
200	420,0	80	8	19094	1909437	8x15	85000600	RIV815	BC/97/1	BPW
200	420,0	80	8	19644	19644xx	8x18	85000700	RIV818		GORICKA
200	420,0	80	8	19192	1919201	8x15	85000600	RIV815		BPW
200	420,0	128	4+4	19891/19890	1989002	L10	88000800	RIVL10	DF/33/1; DF/32/1;	BOVA DAF
202	410,0	96	6+2	19091/19098	1909102	8x16	85002200		PB/42/1; PB/42/2;	IVECO
203	311,0	96	4+4	19862/19863	1986201	5x14,2	85000500		FU/18/2; FU/17/2;	SMB C3
203	393,7	68	2+2	19066/19067	19066xx	L12	88000900	RIVL11	LE/60/1; LE/60/2;	LEYLAND
203	393,7	72	4	19371	19371xx	L09	88000700	RIVL09	GG/142/1	DODGE ERF LEYLAND
203	393,7	84	4+4	19562/19563	1956202	L11	88000900	RIVL11	VL/76/2; VL/77/1;	VOLVO
203	393,7	96	8	19745	19745xx	L10	88000800	RIVL10	CS/64/1	DENNIS ERF
203	393,7	96	8	19922	19922xx	L09	88000700	RIVL09	CS/67/2	DENNIS ERF

Les garnitures de frein avec suffixes xx sont livrables sous 48-72 heures

Brake linings xx suffixes are available in 48-72 hours

RECHERCHE GARNITURES DE FREIN PAR DIMENSIONS BRAKE LINING RESEARCH BY SIZE



Larg/ Width	Ø Tamb/ Drum	Nbr rivet/s et	Nbr	WVA	REF	Rivet Type	Rivet Textar	Rivet GIL	BFMC	
203	393,7	128	8	19921	1992101	L09	88000700	RIVL09	CW/12/1	FORD LEYLAND
203	412,8	64	4	19932	1993201	S38	85002100	RIVS38	SV/41/2	SCANIA
203	412,8	96	8	19393	1939302	6,3x18	85000400		SV/27/1	SCANIA
203	419,0	96	4+4	19365/19366	1936605	L10	88000800	RIVL10	RW/2/3; RW/1/3;	ROR
203	419,0	144	4+4	19617/19911	1961705	L10	88000800	RIVL10	DF/31/1	DAF VANHOOL
203	419,1	96	4+4	19365/19366	1936515	5x14,2	85000500		RW/1/1; RW/2/1;	TRAILOR
203	419,1	128	4+4	19557/19606	1955713	5x14,2	85000500		FT/6/1; FT/7/1;	SMB C1
203	419,1	160	4+4	19617/19618	19618xx	L10	88000800	RIVL10	DF/31/1; DF/30/1;	DAF
209	393,7	128	4+4	19461/19462	1946101	L09	88000700	RIVL09	YK/9/2; YK/8/2;	MOL YORK
210	311,0	128	4+4	19826/19827	19826xx	L10	88000800	RIVL10	YK/10/1; YK/11/1;	YORK
218	419,1	96	4+4	19983/19984	1998301	L09	88000700	RIVL09		ROR
219	410,0	72	4+4	19581/19582	1958101	8x18	85000700	RIV818	MB/77/1; MB/76/1;	MAN MERCEDES
219	410,0	72	4+4	19581/19707	1970701	8x18	85000700	RIV818	MB/77/2; MB/76/2;	BOVA MAN MERCEDES NEOPLAN
219	410,0	96	4+4	19743/19755	1974302	10x18	87002000	RIV1018	PB/21/1; PB/20/1;	KAESSBOHRER NEOPLAN VANHOOL
219	419,1	96	4+4	19369/19370	1936912	L10	88000800	RIVL10	FU/5/4; FU/4/4;	ROR
219	420,0	96	8	19591	1959111	8x15	85000600	RIV815	BC/81/1	BPW
220	370,0	80	8	19466	19466xx	8x18	85000700	RIV818	MB/58/3	MERCEDES
220	410,0	96	4+2+2	19848/19847/19699	1969905	10x18	87002000	RIV1018	PB/19/1; PB/18/1; PB/18/2	BOVA KAESSBOHRER NEOPLAN VANHOOL
220	410,0	96	4+4	19712/19755	1971201	10x18	87002000	RIV1018	PB/32/1; PB/31/1;	KAESSBOHRER IVECO
220	410,0	96	4+4	19114/19115	19114xx	10x18	87002000	RIV1018		VAN HOOL (mach./shoe Acier/Steel)
220	410,0	96	4+4	19114/19115	19114xx	10x18	87002000	RIV1018		VAN HOOL (mach./shoe Fonte/Cast)
220	410,0	112	6+2	19824/19838	1982410	10x18	87002000	RIV1018		IVECO PERROT
220	414,0	64	8	19187	1918702	8x18	85000700	RIV818	RN/104/1	RT
220	420,0	80	8	19825	19825xx	8x18	85000700	RIV818	BC/99/1	BPW
223	410,0	64	8	19496 (ex 19488)	1949602	8x18	85000700	RIV818	MP/36/2	ERF MAN MERCEDES STEYR
223	410,0	112	8	19068 (ex 19940)	1906802	L11	88000900	RIVL11	VL/89/2	DENNIS RT VOLVO
230	393,7	96	8	19975/19976	19975xx	L11	88000900	RIVL11	VL/100/1; VL/101/1;	VOLVO
240	393,7	84	4+4	19885/19886	1988501	L11	88000900	RIVL11	VL/83/1; VL/84/2;	VOLVO
240	420,0	128	4+4	19914/19915	1991403	L10	88000800	RIVL10	DF/38/1; DF/39/1;	DAF

Les garnitures de frein avec suffixes xx sont livrables sous 48-72 heures

Brake linings xx suffixes are available in 48-72 hours

RECHERCHE GARNITURES DE FREIN PAR DIMENSIONS BRAKE LINING RESEARCH BY SIZE

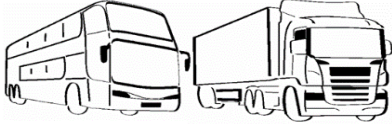
Larg/ Width	Ø Tamb/ Drum	Nbr rivet/s et	Nbr	WVA	REF	Rivet Type	Rivet Textar	Rivet GIL	BFMC	
240	420,0	128	4+4	19069/19077	1906901	6,5x17,6	85001700		DF/50/1; DF/51/1;	DAF
254	393,7	84	4+4	19799/19800	1979901	L11	88000900	RIVL11	VL/82/1; VL/81/2;	VOLVO
254	412,8	64	4	19933	1993301	S38	85002100	RIVS38	SV/42/2	SCANIA
254	412,8	96	8	19647	1964702	6,3x18	85000400		SV/34/1	NEOPLAN SCANIA



Les garnitures de frein avec suffixes xx sont livrables sous 48-72 heures
 Brake linings xx suffixes are available in 48-72 hours

DIMENSIONS DES RIVETS DIMENSIONS RIVETS

Textar	GIL	Ø	Long.	head	angle	Matiere	Designation	type	Rep.
85000400		6,3	18,0	12,0	180°	Laiton/Brass	Special Scania old ST		3
85000500		5,0	15,5	12,0	150°	Acier zingué	Special SMB ST		5
85000600		8,0	15,0	15,5	180°	Acier zingué	Renforced Mercedes	7338 C2	2
85000700		8,0	18,0	15,5	180°	Acier zingué	Renforced Mercedes	7338 C2	2
85001400		6,3	16,5	12,0	125°	Acier zingué	Tubulaire Iveco 19384	10.10	1
85001700		6,5	17,6	14,0	180°	Acier zingué	Semi-tubulaire DAF		3
85002100	RIVS38	6,6	18,0	12,0	180°	Laiton/Brass	ST Scania new	S38	3
85002200		8,0	16,0	16,0	180°	Acier zingué	ST Iveco		3
86000700		4,0	8,0	7,5	180°	Cuivre/Copper	Semi-tubulaire	7338 B	3
86000800		4,0	10,0	7,5	180°	Cuivre/Copper	Semi-tubulaire	7338 B	3
86001500		5,0	10,0	9,5	180°	Cuivre/Copper	Semi-tubulaire	7338 B	3
86001600		5,0	12,0	11,0	180°	Cuivre/Copper	Semi-tubulaire	7338 B	3
86001700		5,0	15,0	11,0	180°	Cuivre/Copper	Semi-tubulaire	7338 B	3
86002100		6,0	10,0	11,0	180°	Cuivre/Copper	Semi-tubulaire	7338 B	3
86002200		6,0	12,0	11,0	180°	Cuivre/Copper	Semi-tubulaire	7338 B	3
86002300	RIV615	6,0	15,0	12,0	180°	Cuivre/Copper	Semi-tubulaire	7338 B	3
86002400		6,0	18,0	12,0	180°	Cuivre/Copper	Semi-tubulaire	7338 B	3
86002700		8,0	15,0	15,5	180°	Acier zingué	Semi-tubulaire	7338 B	3
86002701		8,0	15,0	15,5	180°	Cuivre/Copper	Semi-tubulaire	7338 B	3
86002800		8,0	18,0	15,5	180°	Acier zingué	Semi-tubulaire	7338 B	3
86002801		8,0	18,0	15,5	180°	Cuivre/Copper	Semi-tubulaire	7338 B	3
86002900		8,0	20,0	15,5	180°	Cuivre/Copper	Semi-tubulaire	7338 B	3
86003200		10,0	18,0	19,0	180°	Cuivre/Copper	Semi-tubulaire	7338 B	3
87000400		4,0	8,0	7,5	180°	Cuivre/Copper	Tubulaire	7338 C	4
87000500		4,0	10,0	7,5	180°	Cuivre/Copper	Tubulaire	7338 C	4
87001200		6,0	12,0	11,0	180°	Acier zingué	Tubulaire	7338 C	4
87001300		6,0	15,0	11,0	180°	Acier zingué	Tubulaire	7338 C	4
87001500	RIV815	8,0	15,0	15,5	180°	Acier zingué	Tubulaire	7338 C	4
87001600	RIV818	8,0	18,0	15,5	180°	Acier zingué	Tubulaire	7338 C	4
87002000	RIV1018	10,0	18,0	19,0	180°	Acier zingué	Tubulaire	7338 C	4
88000700	RIVL09	6,4	14,3	12,0	150°	Laiton/Brass	Semi-tubulaire L09	BS3575	5
88000800	RIVL10	6,4	15,9	12,0	150°	Laiton/Brass	Semi-tubulaire L10	BS3575	5
88000900	RIVL11	6,4	17,5	12,0	150°	Laiton/Brass	Semi-tubulaire L11	BS3575	5
	RIVL12	6,4	19,1	12,0	150°	Laiton/Brass	Semi-tubulaire L12	BS3575	5

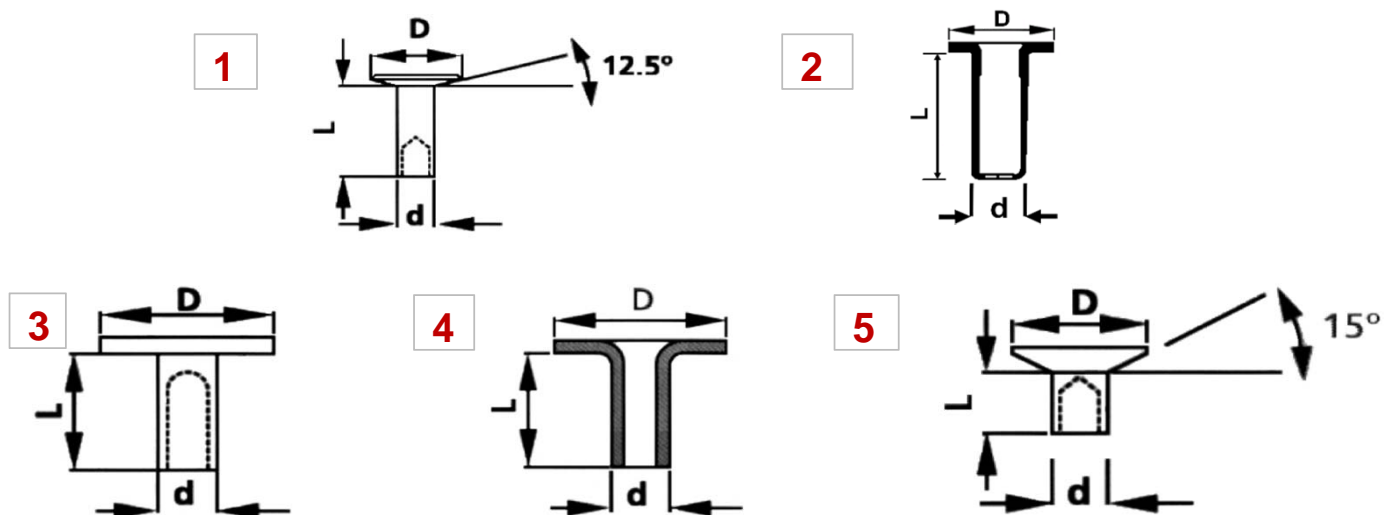



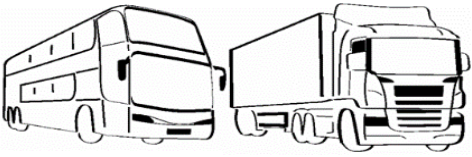
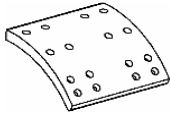
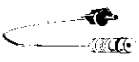

**LISTE APPLICATIVE DES TEMOINS D'USURE
WEAR INDICATOR LIST**

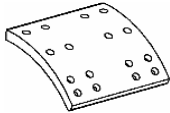
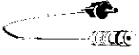
	Th.	WVA		
IVECO	00	19091/19098	1909102	98032100
IVECO	00	19099/19100	1909902	98032100
IVECO	00	19109/19110	1910902	98032200
IVECO	10	19109/19110	1910903	98032200
IVECO	00	19116/19119	1911602	98032200
IVECO	00	19342	1934202	98032100
IVECO	00	19343	1934302	98032100
IVECO	10	19343	1934304	98032100
IVECO	00	19553/19554	1955301	98032200
IVECO	10	19553/19554	19553xx	98032200
IVECO	20	19553/19554	19553xx	98032200
IVECO	00	19555/19556	1955502	98032200
IVECO	10	19555/19556	19555xx	98032200
IVECO	00	19556/714/715	1971401	98032200
IVECO	10	19556/714/715	1971403	98032200
IVECO	10	19553/716/717	1971602	98032200
IVECO	00	19553/19716/19717	1971612	98032200
MAN	00	17238	1723802	98023500
MAN	10	17238	1723804	98023500
MAN	20	17238	1723806	98023600
MAN	00	19495	1949502	98023500
MAN	13	19495	1949504	98023500
MAN	21	19495	1949505	98023600
MAN	00	19496	1949602	98023500
MAN	10	19496	1949604	98023500
MAN	20	19496	1949605	98023600
MAN	00	19713	1971301	98023500
MAN	10	19713	1971302	98023500
MERCEDES	00	11019/11025/11582	1101901	98016800
MERCEDES	00	13020/13532	1302001	98016800
MERCEDES	10	13020/13532	1302002	98016800
MERCEDES	00	15030/15742	1503002	98016800
MERCEDES	10	15030/15742	1503003	98016800
MERCEDES	00	15059/15869	1505901	98016900
MERCEDES	10	15059/15869	15059xx	98016900
MERCEDES	00	15162	1516203	98017002
MERCEDES	10	15162	15162xx	98017002

**LISTE APPLICATIVE DES TEMOINS D'USURE
WEAR INDICATOR LIST**

	Th.	WVA		
MERCEDES	00 17238		1723802	98017002
MERCEDES	10 17238		1723804	98017002
MERCEDES	20 17238		17238xx	98017102
MERCEDES	00 17278		1727806	98017002
MERCEDES	10 17278		1727807	98017002
MERCEDES	00 17280		1728006	98017002
MERCEDES	10 17280		1728007	98017002
MERCEDES	20 17280		17280xx	98017102
MERCEDES	00 17287		1728705	98017002
MERCEDES	10 17287		1728706	98017002
MERCEDES	00 17290/17950		1729006	98017002
MERCEDES	10 17290/17950		1729007	98017002
MERCEDES	20 17949/17950		17290xx	98017102
MERCEDES	00 17350/19973		1735003	98016900
MERCEDES	10 17350		1735004	98016900
MERCEDES	00 17351/17975		1735103	98016900
MERCEDES	10 17351/17975		1735104	98016900
MERCEDES	00 19494		1949402	98017002
MERCEDES	13 19494		1949404	98017002
MERCEDES	21 19494		1949405	98017102
MERCEDES	00 19495		1949502	98017002
MERCEDES	13 19495		1949504	98017002
MERCEDES	21 19495		1949505	98017102
MERCEDES	00 19496		1949602	98017002
MERCEDES	10 19496		1949604	98017002
MERCEDES	20 19496		1949605	98017102
MERCEDES	00 19505/19112		1950505	98017002
MERCEDES	10 19505/19112		1950506	98017002
MERCEDES	00 19506/19845		1950607	98017002
MERCEDES	10 19506/19845		1950608	98017002
MERCEDES	00 19579/19706		1970601	98017002
MERCEDES	10 19579/19706		1970618	98017002
MERCEDES	20 19579/19706		1970619	98017102
MERCEDES	00 19581/19707		1970701	98017002
MERCEDES	10 19581/19707		1970702	98017002
MERCEDES	20 19581/19707		1970720	98017102

ILLUSTRATIONS DRAWINGS

Reference	Designation	WVA	Illustration
AB350929	MACHOIRE NUE RT 310X125 / UNLINED BRAKE SHOES	17352	
AB350891	MACHOIRE NUE RT 325X150 / UNLINED BRAKE SHOES	19709	
AB337220	MACHOIRE NUE RT 360X170 / UNLINED BRAKE SHOES	19255; 19259 TM	
AB337276	ECARTEUR FREIN COIN RT 360X170- 310X125-325X150 / WEDGE BRAKE	17352; 19255; 19259; 19709;	
KRES005	KIT RESSORT DE MACHOIRES RT / SPRING KIT	17352; 19709	
KRES006	KIT RESSORT DE MACHOIRES RT / SPRING KIT	19255; 19259	
AC0001	KIT D'AXE TRANSVERSAL / CROSS SHAFT KIT	17992; 19068, 19071, 19090; 19941	

ILLUSTRATIONS DRAWINGS



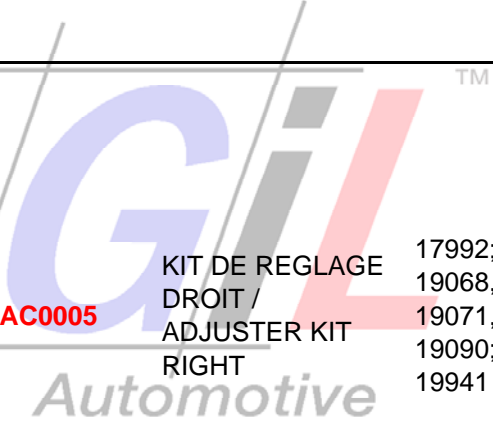

Reference	Designation	WVA	Illustration
AC0002	KIT DE TIGE MANUELLE / MANUAL OVERRIDE STEM KIT	17992; 19068, 19071, 19090; 19941	
MAC7992/2	KIT 2 MACHOIRES NUES 410X125 / UNLINED BRAKE SHOES KIT (2 PIECES) Th.:8 mm	17992	
MAC9941/2	KIT 2 MACHOIRES NUES 410X150 / UNLINED BRAKE SHOES KIT (2 PIECES) Th.:8 mm	19941	
MAC9090/2	KIT 2 MACHOIRES NUES 410X175 / UNLINED BRAKE SHOES KIT (2 PIECES) Th.:8 mm	19090	
MAC9071/2	KIT 2 MACHOIRES NUES 410X200 / UNLINED BRAKE SHOES KIT (2 PIECES) Th.:8 mm	19071	
MAC9068/2	KIT 2 MACHOIRES NUES 410X225 / UNLINED BRAKE SHOES KIT (2 PIECES) Th.:8 mm	19068	
AC0003	KIT DE VERROUILLAGE DE REGLEUR / ADJUSTER LOCK KIT	17992; 19068, 19071, 19090; 19941	

**ILLUSTRATIONS
DRAWINGS**







Reference	Designation	WVA	Illustration
AC0004	KIT DE VERROUILLAGE DE REGLEUR / ADJUSTER LOCK KIT	17992; 19068, 19071, 19090; 19941	
AC0005	KIT DE REGLAGE DROIT / ADJUSTER KIT RIGHT	17992; 19068, 19071, 19090; 19941	
AC0006	KIT DE REGLAGE GAUCHE / ADJUSTER KIT LEFT	17992; 19068, 19071, 19090; 19941	
AC0007	JAMBE / STRUT	17992; 19068, 19071, 19090; 19941	
AC0008	VIS NOYEE M6X100-16 / SET SCREW	17992; 19068, 19071, 19090; 19941	



**ILLUSTRATIONS
DRAWINGS**

Reference	Designation	WVA	Illustration
AC0009	PLAQUE COUVERCLE / COVERPLATE	17992; 19068, 19071, 19090; 19941	
AC0010	PIGNON GAUCHE / PINION LEFT	17992; 19068, 19071, 19090; 19941	
AC0011	PIGNON DROIT / PINION RIGHT	17992; 19068, 19071, 19090; 19941	
AC0013	RESSORT EN C / C SPRING	17992; 19068, 19071, 19090; 19941	
AC0014	CACHE - POUSSIÈRE / DIRT EXCLUDER	17992; 19068, 19071, 19090; 19941	

**ILLUSTRATIONS
DRAWINGS**

Reference	Designation	WVA	Illustration
AC0015	AGRAFE À RESSORT / SPRING HOLDDOWN CLIP	17992; 19068, 19071, 19090; 19941	
AC0016	PION DE BUTEE / ABUTMENT PIN	TM 17992; 19068, 19071, 19090; 19941	
MAC9187	MACHOIRE NUE RT 414X220 AVEC GALET / UNLINED BRAKE SHOES WITH ROLLER	19187	
MAC9187K	MACHOIRE NUE RT 414X220 KERAX AVEC GALET / UNLINED BRAKE SHOES WITH ROLLER	19187	
MAC9934	MACHOIRE NUE RT 414X150 AVEC GALET / UNLINED BRAKE SHOES WITH ROLLER	19934	
MAC9934K	MACHOIRE NUE RT 414X150 REDUIT AVEC GALET / UNLINED BRAKE SHOES WITH ROLLER	19934	







ILLUSTRATIONS DRAWINGS

Reference	Designation	WVA	Illustration
MAC9935	MACHOIRE NUE RT 414X175 AVEC GALET / UNLINED BRAKE SHOES WITH ROLLER	19935	
MAC9935K	MACHOIRE NUE RT 414X175 KERAX AVEC GALET / UNLINED BRAKE SHOES WITH ROLLER	19935	
AC0018	GALET / ROLLER	19187; 19934; 19355	
AC0019	AXE DE GALET / ROLLER AXE	19187; 19934; 19355	
AC0021	ROTULE 42X62X25 / BALL	19187; 19934; 19355	
APF001	AXE POINT FIXE / ANCHOR FIXED	19187; 19934; 19355	

**ILLUSTRATIONS
DRAWINGS**

Reference	Designation	WVA	Illustration
APF001/1	GOUPILLE MECANIMBUS / PIN	19187; 19934; 19355	
APF001/2	JOINT TORIQUE / O-RING	19187; 19934; 19355 TM	
APF001/3	BAGUE POINT FIXE / BUSH	19187; 19934; 19355	
AXE001	AXE RESSORT RT / AXIS SPRING	19187; 19934; 19355	
AXE002	AXE RESSORT RT / AXIS SPRING	19187; 19934; 19355	
BE0001	BAGUE D'ETANCHEITE 120X160X15 / O- SEAL	19187; 19934; 19355	
RES001	RESSORT DE MACHOIRES RT / RETURN SPRING 154X38X5	19187; 19934; 19355	

ILLUSTRATIONS DRAWINGS

Reference	Designation	WVA	Illustration
RES002	RESSORT DE MACHOIRES RT / RETURN SPRING 236X28X4	19187; 19934; 19355	
RES004	RESSORT DE MACHOIRES RT / RETURN SPRING 251X34X5	19187; 19934; 19355	
MAC9063/64	MACHOIRE NUE DAF 420X200 / UNLINED BRAKE SHOES	19063; 19064	
MAC9503	MACHOIRE NUE IVECO 360X170 / UNLINED BRAKE SHOES	19503	
ECF001	ECARTEUR DAF IVECO PERROT 360X170 SIMPLEX / WEDGE BRAKE	19503	
ECF002	ECARTEUR IVECO PERROT 410X180 410X200 SIMPLEX / WEDGE BRAKE	19091; 19098	
MAC9091/98	MACHOIRE NUE PERROT 410X202 / UNLINED BRAKE SHOES	19091; 19098	

ILLUSTRATIONS DRAWINGS

Reference	Designation	WVA	Illustration
98032100	TEMOIN USURE IVECO PERROT / WEAR INDICATOR (L.: 1315mm 1 piece)	19091; 19099	
MAC9495CAST	MACHOIRE NUE MAN MERCEDES 410X183 + GALET / UNLINED BRAKE SHOES WITH ROLLER	19495 TM	
MAC9496CAST	MACHOIRE NUE MAN MERCEDES 410X223 +GALET / UNLINED BRAKE SHOES WITH ROLLER	19496	
98017002	TEMOINS USURE MERCEDES (EX 98017000) / WEAR INDICATOR (L.: 120mm - 2 pieces)	15162; 17238; 17278; 17280; 17287; 17290; 19112; 19494; 19495; 19496; 19505; 19506; 19706; 19707; 19936; 19937;	
98017102	TEMOINS USURE MERCEDES +2 MM (EX 98017100)/ WEAR INDICATOR (L.: 120mm - 2 pieces)	15162; 17238; 17278; 17280; 17287; 17290; 19112; 19494; 19495; 19496; 19505; 19506; 19706; 19707; 19936; 19937;	

**ILLUSTRATIONS
DRAWINGS**

Reference	Designation	WVA	Illustration
98023500	TEMOINS USURE MAN CO & +1MM/ WEAR INDICATOR (L.: 194mm - 2 pieces)	17238; 19495; 19496; 19713	
98023600	TEMOINS USURE MAN +2MM & +3MM (FAT)/ WEAR INDICATOR (L.: 194mm - 2 pieces)	17238; 19495; 19496; 19713	
MAC9932	MACHOIRE NUE SCANIA 413X203 / UNLINED BRAKE SHOES	19932	
MAC9933	MACHOIRE NUE SCANIA 413X254 / UNLINED BRAKE SHOES	19933	
MAC9974	MACHOIRE NUE IRISBUS 414X200 / UNLINED BRAKE SHOES	19974	
98016800	TEMOINS USURE MERCEDES/ WEAR INDICATOR (L. : 150mm / 4 pieces)	11019; 11025; 11582; 11583; 13020; 13532; 13533; 15030; 15742; 15743;	

ILLUSTRATIONS DRAWINGS

Reference	Designation	WVA	Illustration
98016900	TEMOINS USURE MERCEDES/ WEAR INDICATOR (L. : 200mm / 4 pieces)	15059;	
		15869;	
		15870;	
		17350;	
		17351;	
		17973;	
		17974;	
		17975;	
		17976;	
98032200	TEMOIN USURE IVECO ROCKWELL/ WEAR INDICATOR (L.: 1315mm 1 piece)	19109;	
		19110;	
		19116;	
		19119;	
		19553;	
		19553;	
		19554;	
		19555;	
		19556;	
		19556;	
19714;			
19715;			
19716;			
19717;			

CORRESPONDANCE DES REFERENCES CROSS REFERENCE LIST

MARQUE	REF OES	REFERENCE
ABEX	AK2037159	1960470
ABEX	AK2041927	1960870
ABEX	AK2043170	1976270
ABEX	AK2620929	1961370
ABEX	AK2622929	1955770
ABEX	AK2751173	1903070
ABEX	AK2858927	1903770
ABEX	AK2870929	1903270
ABEX	AK2870929	1903271
ABEX	AK2878929	1909470
ABEX	AK2895159	1936970
ABEX	B2002	1957306
ABEX	B2008	1978610
ABEX	B2009	1982410
ABEX	B2029	1978611
ABEX	B2030	1516203
ABEX	B2031	1727806
ABEX	B2032	1728006
ABEX	B2033	1728705
ABEX	B2037	1960408
ABEX	B2041	1986201
ABEX	B2041	1986201
ABEX	B2043	1976210
ABEX	B2044	1976002
ABEX	B2045	1987701
ABEX	B2046	19880xx
ABEX	B2049	17897xx
ABEX	B2050	19125xx
ABEX	B2053	1990210
ABEX	B2061	1925501
ABEX	B2063	19923xx
ABEX	B2064	1729006
ABEX	B2066	1950607
ABEX	B2083	1956202
ABEX	B2084	1916602
ABEX	B2091	19684xx
ABEX	B2092	19685xx
ABEX	B2093	1970601
ABEX	B2094	1970701
ABEX	B2095	1979901
ABEX	B2096	1988501
ABEX	B2097	1949602
ABEX	B2097	1949602
ABEX	B2105	1957427
ABEX	B2112	1779501
ABEX	B2143	19946xx
ABEX	B2148	1946703
ABEX	B2150	1799201
ABEX	B2152	1994102

MARQUE	REF OES	REFERENCE
ABEX	B2160	1723802
ABEX	B2161	1768202
ABEX	B2162	17739xx
ABEX	B2169	1969905
ABEX	B2170	1984906
ABEX	B2177	1766402
ABEX	B2179	1993402
ABEX	B2180	1993502
ABEX	B2181	19974xx
ABEX	B2182	1918702
ABEX	B2184	19634xx
ABEX	B2185	1974302
ABEX	B2202	1949402
ABEX	B2203	1949502
ABEX	B2208	1939302
ABEX	B2212	1956002
ABEX	B2302	1951512
ABEX	B2305	19543xx
ABEX	B2308	1990803
ABEX	B2309	17357xx
ABEX	B2311	1975803
ABEX	B2322	15879xx
ABEX	B2323	1798806
ABEX	B2325	1971802
ABEX	B2338	1726301
ABEX	B2345	1926901
ABEX	B2354	1915002
ABEX	B2358	1991201
ABEX	B2366	1989208
ABEX	B2369	1925602
ABEX	B2409	1936605
ABEX	B2420	17704xx
ABEX	B2481	1993201
ABEX	B2483	19618xx
ABEX	B2484	1961705
ABEX	B2487	1993301
ABEX	B2489	19896xx
ABEX	B2497	19680xx
ABEX	B2498	19682xx
ABEX	B2500	1716101
ABEX	B2501	1907502
ABEX	B2502	19359xx
ABEX	B2503	1920005
ABEX	B2506	19672xx
ABEX	B2509	1799101
ABEX	B2510	1993101
ABEX	B2541	19168xx
ABEX	B2620	1961313
ABEX	B2622	1955713

Les correspondances de références ont pour seul objectif d'aider la recherche de référence

Cross references are there for the sole purpose of helping the reference search

CORRESPONDANCE DES REFERENCES CROSS REFERENCE LIST

MARQUE	REF OES	REFERENCE
ABEX	B2675	1954201
ABEX	B2676	19492xx
ABEX	B2677	1934302
ABEX	B2677	1934302
ABEX	B2678	1934202
ABEX	B2678	1934202
ABEX	B2679	1950505
ABEX	B2703	19905xx
ABEX	B2704	19887xx
ABEX	B2706	19820xx
ABEX	B2707	19306xx
ABEX	B2708	1928308
ABEX	B2709	1947706
ABEX	B2710	1992101
ABEX	B2711	1901005
ABEX	B2712	1905201
ABEX	B2713	1906303
ABEX	B2717	19745xx
ABEX	B2720	1701703
ABEX	B2721	1917705
ABEX	B2722	19825xx
ABEX	B2723	1951701
ABEX	B2724	19396xx
ABEX	B2725	19397xx
ABEX	B2726	1995201
ABEX	B2727	1956801
ABEX	B2728	17742xx
ABEX	B2729	19558xx
ABEX	B2730	19723xx
ABEX	B2731	1745605
ABEX	B2732	1964703
ABEX	B2733	17012xx
ABEX	B2734	1902401
ABEX	B2735	1971201
ABEX	B2736	19251xx
ABEX	B2737	1955301
ABEX	B2738	1955502
ABEX	B2739	1938414
ABEX	B2740	19114xx
ABEX	B2741	1971401
ABEX	B2742	1971613
ABEX	B2743	1947905
ABEX	B2744	1949005
ABEX	B2745	1991403
ABEX	B2746	1906901
ABEX	B2747	1992802
ABEX	B2748	19826xx
ABEX	B2749	1970803
ABEX	B2750	18014xx

MARQUE	REF OES	REFERENCE
ABEX	B2751	1903001
ABEX	B2752	1941001
ABEX	B2753	1997201
ABEX	B2754	1909002
ABEX	B2755	1907102
ABEX	B2756	1906802
ABEX	B2757	1909902
ABEX	B2758	1909102
ABEX	B2800	1996708
ABEX	B2822	1985502
ABEX	B2858	1903712
ABEX	B2869	19406xx
ABEX	B2870	1903230
ABEX	B2873	1903616
ABEX	B2878	1909437
ABEX	B2880	19338xx
ABEX	B2891	1936515
ABEX	B2894	1990002
ABEX	B2895	1936912
ABEX	B2896	1988802
ABEX	B2897	1989002
ABEX	B2898	1910902
ABEX	B2899	1911602
ABEX	B2900	1919101
ABEX	B2901	1919201
ABEX	B4002	1957307
ABEX	B4009	19824xx
ABEX	B4029	1978612
ABEX	B4030	15162xx
ABEX	B4031	1727807
ABEX	B4032	1728007
ABEX	B4033	1728706
ABEX	B4037	1960409
ABEX	B4041	1986202
ABEX	B4041	1986202
ABEX	B4043	1976211
ABEX	B4049	17897xx
ABEX	B4053	1990212
ABEX	B4061	1925502
ABEX	B4063	19923xx
ABEX	B4064	1729007
ABEX	B4066	1950608
ABEX	B4083	1956204
ABEX	B4093	1970618
ABEX	B4094	1970702
ABEX	B4095	1979902
ABEX	B4096	19885xx
ABEX	B4097	1949604
ABEX	B4097	1949604

Les correspondances de références ont pour seul objectif d'aider la recherche de référence

Cross references are there for the sole purpose of helping the reference search

CORRESPONDANCE DES REFERENCES CROSS REFERENCE LIST

MARQUE	REF OES	REFERENCE
ABEX	B4105	1957428
ABEX	B4112	17795xx
ABEX	B4143	19946xx
ABEX	B4148	19467xx
ABEX	B4150	17992xx
ABEX	B4152	19941xx
ABEX	B4160	1723804
ABEX	B4161	17682xx
ABEX	B4169	1969906
ABEX	B4177	17664xx
ABEX	B4179	1993410
ABEX	B4180	1993514
ABEX	B4181	19974xx
ABEX	B4182	1918704
ABEX	B4184	19634xx
ABEX	B4185	19743xx
ABEX	B4202	1949404
ABEX	B4203	1949504
ABEX	B4208	1939304
ABEX	B4212	19560xx
ABEX	B4302	1951513
ABEX	B4305	19543xx
ABEX	B4308	1990804
ABEX	B4309	17357xx
ABEX	B4311	1975804
ABEX	B4323	1798807
ABEX	B4325	19718xx
ABEX	B4345	19269xx
ABEX	B4354	19150xx
ABEX	B4358	1991202
ABEX	B4366	1989202
ABEX	B4369	19256xx
ABEX	B4409	1936607
ABEX	B4420	17704xx
ABEX	B4481	1993202
ABEX	B4487	1993307
ABEX	B4489	19896xx
ABEX	B4500	1716101
ABEX	B4501	19075xx
ABEX	B4503	19200xx
ABEX	B4506	19672xx
ABEX	B4509	17991xx
ABEX	B4510	1993102
ABEX	B4620	1961314
ABEX	B4622	1955714
ABEX	B4675	19542xx
ABEX	B4676	19492xx
ABEX	B4677	1934304
ABEX	B4677	1934304

MARQUE	REF OES	REFERENCE
ABEX	B4678	19342xx
ABEX	B4679	1950506
ABEX	B4707	19306xx
ABEX	B4708	1928309
ABEX	B4709	1947707
ABEX	B4711	1901006
ABEX	B4712	19052xx
ABEX	B4713	1906304
ABEX	B4720	1701704
ABEX	B4721	19177xx
ABEX	B4726	1995202
ABEX	B4727	1956802
ABEX	B4728	17742xx
ABEX	B4729	19558xx
ABEX	B4731	1745606
ABEX	B4732	19647xx
ABEX	B4734	19024xx
ABEX	B4735	1971202
ABEX	B4737	19553xx
ABEX	B4739	1938415
ABEX	B4740	19114xx
ABEX	B4742	1971602
ABEX	B4744	19490xx
ABEX	B4751	1903002
ABEX	B4754	1909005
ABEX	B4755	1907105
ABEX	B4756	1906805
ABEX	B4800	1996709
ABEX	B4858	1903713
ABEX	B4870	1903231
ABEX	B4873	1903617
ABEX	B4878	1909439
ABEX	B4880	19338xx
ABEX	B4891	1936513
ABEX	B4894	1990004
ABEX	B4895	1936913
ABEX	B4896	1988804
ABEX	B4897	1989004
ABEX	B4898	1910903
ABEX	B4900	1919102
ABEX	B4901	1919202
ABEX	B6097	1949605
ABEX	B6097	1949605
ABEX	B6105	1957429
ABEX	B6179	19934xx
ABEX	B6180	19935xx
ABEX	B6182	19187xx
ABEX	B6202	1949405
ABEX	B6203	1949505

Les correspondances de références ont pour seul objectif d'aider la recherche de référence

Cross references are there for the sole purpose of helping the reference search

CORRESPONDANCE DES REFERENCES CROSS REFERENCE LIST

MARQUE	REF OES	REFERENCE
ABEX	B6208	19393xx
ABEX	B6481	19932xx
ABEX	B6501	19075xx
ABEX	B6503	19200xx
ABEX	B6510	19931xx
ABEX	B6620	19613xx
ABEX	B6708	1928310
ABEX	B6738	19555xx
ABEX	B6739	1938416
ABEX	B6741	1971403
ABEX	B6754	19071xx
ABEX	B6756	19068xx
ABEX	B6858	1903714
ABEX	B6870	19032xx
ABEX	B6878	1909440
ABEX	B6895	1936914
ABEX	FAI200	98016800
ABEX	FAI201	98016900
ABEX	FAI202	98017002
ABEX	FAI203	98017102
ABEX	FAI205	98023500
ABEX	FAI206	98023600
ABEX	FAI207	98032200
ABEX	FAI208	98032100
ABEX	J0300	17134xx
ABEX	J0301	17546xx
ABEX	J0302	19351xx
ABEX	J0303	17316xx
ABEX	J0305	1911101
ABEX	J0306	17557xx
ABEX	J0307	15789xx
ABEX	J0308	17555xx
ABEX	J0309	17560xx
ABEX	J0310	17662xx
ABEX	J0311	15562xx
ABEX	J0312	17556xx
ABEX	J0313	15837xx
ABEX	J0314	17934xx
ABEX	J0315	17932xx
ABEX	J0316	17477xx
ABEX	J0317	17713xx
ABEX	J0318	17229xx
ABEX	J0319	15794xx
ABEX	J0320	17854xx
ABEX	J1001	1101901
ABEX	J1002	1302001
ABEX	J1031	19182xx
ABEX	J1033	15057xx
ABEX	J1035	17105xx

MARQUE	REF OES	REFERENCE
ABEX	J1045	1709401
ABEX	J1046	17792xx
ABEX	J1048	19996xx
ABEX	J1049	19444xx
ABEX	J1050	17612xx
ABEX	J1051	1708802
ABEX	J1222	17497xx
ABEX	J1224	17307xx
ABEX	J1225	17805xx
ABEX	J1226	1962004
ABEX	J1227	1782704
ABEX	J1228	17829xx
ABEX	J1229	1783102
ABEX	J1232	1910301
ABEX	J1233	17761xx
ABEX	J1240	1740910
ABEX	J1241	17500xx
ABEX	J1243	17247xx
ABEX	J1243	17247xx
ABEX	J1248	1583101
ABEX	J1253	1573204
ABEX	J1287	17804xx
ABEX	J1288	19622xx
ABEX	J1293	1503002
ABEX	J1295	1904902
ABEX	J1296	1904902
ABEX	J1304	17298xx
ABEX	J1305	1727601
ABEX	J1306	1916001
ABEX	J1307	17869xx
ABEX	J1308	19694xx
ABEX	J1312	17309xx
ABEX	J1325	1946301
ABEX	J1326	19655xx
ABEX	J1338	19919xx
ABEX	J1339	1946301
ABEX	J1345	1558008
ABEX	J1346	1740909
ABEX	J1348	17323xx
ABEX	J1350	17352xx
ABEX	J1351	19709xx
ABEX	J1356	19918xx
ABEX	J1357	15207xx
ABEX	J1358	15494xx
ABEX	J1359	1748206
ABEX	J1360	1581702
ABEX	J1361	1790007
ABEX	J1410	15698xx
ABEX	J1411	17880xx

Les correspondances de références ont pour seul objectif d'aider la recherche de référence

Cross references are there for the sole purpose of helping the reference search

CORRESPONDANCE DES REFERENCES CROSS REFERENCE LIST

MARQUE	REF OES	REFERENCE
ABEX	J1412	19821xx
ABEX	J1413	17879xx
ABEX	J1420	13464xx
ABEX	J1421	1792408
ABEX	J1482	13053xx
ABEX	J1510	15104xx
ABEX	J1511	17744xx
ABEX	J1512	1534906
ABEX	J1516	1740805
ABEX	J1517	1748107
ABEX	J1518	19072xx
ABEX	J1519	15282xx
ABEX	J1521	19544xx
ABEX	J1522	17592xx
ABEX	J1523	19401xx
ABEX	J1524	19405xx
ABEX	J1535	17885xx
ABEX	J1675	1950308
ABEX	J1678	19371xx
ABEX	J1679	1505901
ABEX	J1680	1735003
ABEX	J1681	1735103
ABEX	J1682	15280xx
ABEX	J1684	15799xx
ABEX	J1685	1709601
ABEX	J1686	17362xx
ABEX	J1687	19700xx
ABEX	J2002	1302002
ABEX	J2031	19182xx
ABEX	J2045	17094xx
ABEX	J2046	17792xx
ABEX	J2051	1708804
ABEX	J2225	17805xx
ABEX	J2226	1962005
ABEX	J2227	1782705
ABEX	J2228	17829xx
ABEX	J2229	17831xx
ABEX	J2240	17409xx
ABEX	J2253	1573205
ABEX	J2287	17804xx
ABEX	J2288	19622xx
ABEX	J2293	1503003
ABEX	J2295	1904911
ABEX	J2296	1904911
ABEX	J2306	1916002
ABEX	J2307	17869xx
ABEX	J2308	19694xx
ABEX	J2312	17309xx
ABEX	J2325	19463xx

MARQUE	REF OES	REFERENCE
ABEX	J2338	19919xx
ABEX	J2339	19463xx
ABEX	J2345	15580xx
ABEX	J2346	17409xx
ABEX	J2351	19709xx
ABEX	J2356	19918xx
ABEX	J2357	15207xx
ABEX	J2358	15494xx
ABEX	J2359	1748207
ABEX	J2361	17900xx
ABEX	J2411	17880xx
ABEX	J2412	19821xx
ABEX	J2413	17879xx
ABEX	J2421	1792409
ABEX	J2512	1534907
ABEX	J2516	1740806
ABEX	J2517	1748108
ABEX	J2518	19072xx
ABEX	J2521	19544xx
ABEX	J2535	17885xx
ABEX	J2675	1950307
ABEX	J2679	15059xx
ABEX	J2680	1735004
ABEX	J2681	1735104
ABEX	J3051	1708806
ABEX	J3253	1573206
ABEX	J3296	19049xx
ABEX	J3307	17869xx
ABEX	J3308	19694xx
ABEX	J3325	19463xx
ABEX	J3357	15207xx
ABEX	J3358	15494xx
ABEX	J3359	1748208
ABEX	J3516	1740807
ABEX	J3517	1748109
BPW	0300099476	1903230
BPW	0309212510	1734703
BPW	0309213100	1957306
BPW	0309213190	1957306
BPW	0309213200	1957307
BPW	0309213310	1957306
BPW	0309213320	1957307
BPW	0309213440	1957306
BPW	0309213450	1957307
BPW	0309214020	1910301
BPW	0309214030	1910301
BPW	0309214120	1957422
BPW	0309214270	1957422
BPW	0309214330	1957422

Les correspondances de références ont pour seul objectif d'aider la recherche de référence

Cross references are there for the sole purpose of helping the reference search

CORRESPONDANCE DES REFERENCES CROSS REFERENCE LIST

MARQUE	REF OES	REFERENCE
BPW	0309214440	1957422
BPW	0309214450	1957422
BPW	0309219080	1990210
BPW	0309219090	1990210
BPW	0309219220	1995201
BPW	0309219230	1995201
BPW	0309219240	1990210
BPW	0309219250	1990210
BPW	0309219300	1990212
BPW	0309219310	1990212
BPW	0309219460	1995202
BPW	0309219470	1995202
BPW	0309219520	1990210
BPW	0309219520	1990212
BPW	0309219530	1990210
BPW	0309219530	1990212
BPW	0309219540	1990210
BPW	0309219550	1990210
BPW	0309219560	1990212
BPW	0309219570	1990212
BPW	0309219620	1995201
BPW	0309219630	1995201
BPW	0309219640	1995202
BPW	0309219650	1995202
BPW	0309219880	1990210
BPW	0309220010	1524701
BPW	0309220120	1524701
BPW	0309220150	1524701
BPW	0309222010	1711501
BPW	0309222030	1711502
BPW	0309222080	1700101
BPW	0309222170	1700101
BPW	0309222180	1711501
BPW	0309222250	1711501
BPW	0309222350	1700101
BPW	0309223020	1919101
BPW	0309225010	1920005
BPW	0309225170	1920005
BPW	0309225350	1920005
BPW	0309225400	1920005
BPW	0309225470	1920005
BPW	0309225480	1920005
BPW	0309226010	1903230
BPW	0309226030	1903231
BPW	0309226110	1903230
BPW	0309226210	1903230
BPW	0309226260	1903230
BPW	0309226320	1903230
BPW	0309226450	1903230

MARQUE	REF OES	REFERENCE
BPW	0309226560	1903230
BPW	0309226570	1903231
BPW	0309226760	1903230
BPW	0309226770	1903231
BPW	0309226850	1903230
BPW	0309226860	1903231
BPW	0309226980	1919101
BPW	0309227010	1909437
BPW	0309227020	1909439
BPW	0309227060	1909437
BPW	0309227150	1909437
BPW	0309227190	1909437
BPW	0309227220	1909439
BPW	0309227240	1909437
BPW	0309227260	1909437
BPW	0309227430	1909437
BPW	0309227450	1909437
BPW	0309227530	1909437
BPW	0309227540	1909439
BPW	0309227630	1909439
BPW	0309227650	1909437
BPW	0309227710	1909437
BPW	0309227720	1909439
BPW	0309227760	1909437
BPW	0309227770	1909439
BPW	0309227900	1919201
BPW	0309228020	1959111
BPW	0309228210	1959111
BPW	0309228280	1959111
BPW	0309228310	1959111
BPW	0309228320	1959111
BPW	0309229020	1737707
BPW	0309229350	1737707
BPW	0309229360	1737707
BPW	0309229390	1737707
BPW	0309229430	1737707
BPW	0309229440	1737707
BPW	0309229520	1737707
BPW	0309229530	1737707
BPW	0309229600	1908101
BPW	0309229600	1908101
BPW	0309229640	1740501
BPW	0309229650	1740501
BPW	0392279800	1919201
BPW	0509127790	1909437
BPW	0509127820	1909470
BPW	0509146090	1903230
BPW	0509146090	1903270
BPW	0509146140	1903271

Les correspondances de références ont pour seul objectif d'aider la recherche de référence

Cross references are there for the sole purpose of helping the reference search

CORRESPONDANCE DES REFERENCES CROSS REFERENCE LIST

MARQUE	REF OES	REFERENCE
BPW	0509146321	1919101
BPW	0980107390	1919101
BPW	0980107410	1919101
BPW	0980107450	1919201
BPW	309214130	1957425
BPW	309214280	1957425
BPW	309214340	1957425
BPW	309214460	1957425
DAF	0681788T	1915002
DAF	0681790T	1925602
DAF	0682087T	1991403
DAF	0682839T	1915002
DAF	0682845T	1990002
DAF	0682849T	1989002
DAF	0682850T	1989004
DAF	1246532	MAC9063/64
DAF	1522138	1907102
DAF	1694347	AC0009
DAF	1694352	AC0005
DAF	1694353	AC0006
DAF	1694354	AC0014
DAF	1694355	AC0007
DAF	1694362	AC0013
DAF	1694363	AC0016
DAF	1694368	AC0001
DAF	1694372	AC0015
DAF	1694793	AC0010
DAF	1694794	AC0011
DAF	1785123	1905201
DAF	1785124	1905201
DAF	1785125	1906303
DAF	1785126	1906303
DAF	1808124	1901005
DAF	1808126	1905201
DAF	1808130	1906901
DAF	1808184	1989004
DAF	313741	1783102
DAF	313743	1782704
DAF	313744	1782704
DAF	313745	1962005
DAF	313746	1782704
DAF	313746	1962004
DAF	391156	MAC9063/64
DAF	391951	1991403
DAF	607360	1782704
DAF	607360	1782704
DAF	607855	1782704
DAF	607855	1962004
DAF	607991	CR0936

MARQUE	REF OES	REFERENCE
DAF	607992	CR0937
DAF	607993	CR0932
DAF	607994	CR0933
DAF	608422	CR0928
DAF	608423	CR0929
DAF	608424	CR0940
DAF	608425	CR0941
DAF	608438	1782704
DAF	608438	1783102
DAF	608505	1782704
DAF	680815	1925602
DAF	680816	1925602
DAF	680841	1925602
DAF	680842	1925602
DAF	680883	1925602
DAF	681274	1915002
DAF	681276	1915002
DAF	681278	1925602
DAF	681284	1925602
DAF	681473	1991403
DAF	681474	1991403
DAF	681535	1991403
DAF	681536	1991403
DAF	681539	1991403
DAF	681540	1991403
DAF	681790	1925602
DAF	682037	1915002
DAF	682083	1991403
DAF	682087	1991403
DAF	682089	1991403
DAF	682092	1988802
DAF	682096	1988802
DAF	682098	1988802
DAF	682101	1989002
DAF	682102	1989004
DAF	682105	1989002
DAF	682106	1989004
DAF	682107	1989002
DAF	682110	1990002
DAF	682114	1990002
DAF	682116	1990002
DAF	682416	1901005
DAF	682417	1901006
DAF	682418	1901005
DAF	682419	1901006
DAF	682421	1905201
DAF	682426	1906303
DAF	682427	1906304
DAF	682428	1906304

Les correspondances de références ont pour seul objectif d'aider la recherche de référence

Cross references are there for the sole purpose of helping the reference search

CORRESPONDANCE DES REFERENCES CROSS REFERENCE LIST

MARQUE	REF OES	REFERENCE
DAF	682441	1902401
DAF	682443	1902401
DAF	682807	1915002
DAF	682808	1915002
DAF	682809	1925602
DAF	682839	1915002
DAF	682841	1925602
DAF	682843	1961705
DAF	682845	1990002
DAF	682847	1988802
DAF	682849	1989002
DAF	682850	1989004
DAF	682851	1991403
DAF	682855	1902401
DAF	682857	1901005
DAF	682858	1901006
DAF	682859	1905201
DAF	682861	1906303
DAF	682862	1906304
DAF	682863	1906901
DAF	682863	1991403
DAF	683013	1915002
DAF	683016	1925602
DAF	683018	1961705
DAF	683021	1990002
DAF	683023	1988802
DAF	683025	1989002
DAF	683026	1989004
DAF	683027	1991403
DAF	683031	1902401
DAF	683033	1901005
DAF	683034	1901006
DAF	683035	1905201
DAF	683037	1906303
DAF	683038	1906304
DAF	683039	1906901
DAF	683262	1915002
DAF	683263	1915002
DAF	683265	1925602
DAF	683266	1990002
DAF	683268	1988802
DAF	683270	1989002
DAF	683271	1989004
DAF	683272	1991403
DAF	683274	1901005
DAF	683275	1901006
DAF	683276	1905201
DAF	683278	1906303
DAF	683279	1906304

MARQUE	REF OES	REFERENCE
DAF	683280	1906901
DAF	683313	1961705
DAF	683317	1902401
DAF	699152	CR0928
DAF	699153	CR0929
DAF	699154	CR0932
DAF	699155	CR0933
DAF	699156	CR0940
DAF	699157	CR0941
DAF	699158	CR0936
DAF	699159	CR0937
DAF	70707	1901005
DAF	70708	1901005
DAF	91112875	MF0503
DAF	FBU9121	ECF001
DAF	GWC1149	CR1002
DAF	RTC3624	CR1002
DAF	SR3157755	MF0407
DAF LDV	759704	CR1003
FERODO	FAI200	98016800
FERODO	FAI201	98016900
FERODO	FAI202	98017002
FERODO	FAI203	98017102
FERODO	FAI205	98023500
FERODO	FAI206	98023600
FERODO	FAI207	98032200
FERODO	FAI208	98032100
FORD	1560032	CR1002
FORD	4055730	CR0618
FORD	92VB2261CA	CR0618
GIGANT SAE	7802022	1976210
GIGANT SAE	8803050	1976211
GIGANT SAE	8803051	1976210
GIGANT SAE	9012303	1976210
GIGANT SAE	9104160	1976210
GIGANT SAE	9317084	1957471
GIGANT SAE	9317804	1976270
IRISBUS	500359913	FCS003
IRISBUS	500359916	FCS004
IRISBUS	5006018439	AC0014
IRISBUS	5006018471	AC0015
IRISBUS	5006018472	AC0003
IRISBUS	5006018473	AC0004
IRISBUS	5006018480	AC0013
IVECO	1543999	MF0503
IVECO	1902483	1978610
IVECO	1903250	1709401
IVECO	1903254	1792408
IVECO	1903255	1792409

Les correspondances de références ont pour seul objectif d'aider la recherche de référence

Cross references are there for the sole purpose of helping the reference search

CORRESPONDANCE DES REFERENCES CROSS REFERENCE LIST

MARQUE	REF OES	REFERENCE
IVECO	1903257	1740805
IVECO	1903258	1740806
IVECO	1903261	1708802
IVECO	1903284	1768801
IVECO	1903306	1962004
IVECO	1903315	19153xx
IVECO	1903359	1978610
IVECO	1903378	1962005
IVECO	1903382	1962004
IVECO	1903480	1938414
IVECO	1903481	1938415
IVECO	1903490	1708804
IVECO	1906000	1922507
IVECO	1906027	1503002
IVECO	1906028	1503003
IVECO	1906033	1938415
IVECO	1906055	1792409
IVECO	1906065	1503002
IVECO	1906066	1503003
IVECO	1906087	1978610
IVECO	1906103	17269xx
IVECO	1906113	1962004
IVECO	1906115	1782704
IVECO	1906115	1962004
IVECO	1906117	1782704
IVECO	1906132	1768801
IVECO	1906136	1783102
IVECO	1906142	1962005
IVECO	1906149	1782705
IVECO	1906150	1962005
IVECO	1906171	MF0503
IVECO	1906176	1938414
IVECO	1906177	1938415
IVECO	1906197	1709601
IVECO	1906200	1938414
IVECO	1906221	1950308
IVECO	1906222	1950307
IVECO	1906223	1950309
IVECO	1906233	1740805
IVECO	1906235	1740806
IVECO	1906236	1792408
IVECO	1906237	1708802
IVECO	1906241	1938415
IVECO	1906244	1978610
IVECO	1906249	1982410
IVECO	1906267	1708804
IVECO	1906301	1709401
IVECO	1906352	MF0503
IVECO	1906361	1950308

MARQUE	REF OES	REFERENCE
IVECO	1906362	19153xx
IVECO	1906362	19153xx
IVECO	1906371	1955502
IVECO	1906372	1971401
IVECO	1906373	1971403
IVECO	1906377	MF0525
IVECO	1906380	1503002
IVECO	1906397	1922507
IVECO	1906407	1971401
IVECO	1906408	1971403
IVECO	1906413	1971612
IVECO	1906414	1971613
IVECO	1906431	1971401
IVECO	1906432	1971612
IVECO	2983279	CR0932
IVECO	2983280	CR0933
IVECO	2983300	CR0928
IVECO	2983301	CR0929
IVECO	2983313	CR0936
IVECO	2983314	CR0937
IVECO	2983327	CR0940
IVECO	2983327	CR0940
IVECO	2983328	CR0941
IVECO	2983328	CR0941
IVECO	2991755	1909902
IVECO	2991756	1909902
IVECO	2991759	MAK0016
IVECO	2991760	1909102
IVECO	2991906	1938414
IVECO	2991907	1938415
IVECO	2991914	1971401
IVECO	2991915	1971403
IVECO	2991918	1909902
IVECO	2992005	1909102
IVECO	2992113	1910902
IVECO	2992123	1911602
IVECO	2992124	1911603
IVECO	2996501	1911603
IVECO	2996507	1910903
IVECO	2997760	1909102
IVECO	3434795	19153xx
IVECO	4071472	CR1012
IVECO	41000936	1955301
IVECO	41022771	FCS005
IVECO	41022772	FCS006
IVECO	41022773	FCS009
IVECO	41022774	FCS010
IVECO	41211315	FCD005
IVECO	41211316	FCD006

Les correspondances de références ont pour seul objectif d'aider la recherche de référence

Cross references are there for the sole purpose of helping the reference search

CORRESPONDANCE DES REFERENCES CROSS REFERENCE LIST

MARQUE	REF OES	REFERENCE
IVECO	41211321	FCD011
IVECO	41211322	FCD012
IVECO	4122369	CR1010
IVECO	4122669	CR1010
IVECO	41285034	FCD011
IVECO	41285035	FCD012
IVECO	4212449	CR1014
IVECO	4220639	CR1016
IVECO	4220643	CR1011
IVECO	42481446	1740806
IVECO	42491897	1978610
IVECO	42530550	98032100
IVECO	42540290	AC0002
IVECO	4254725	CR1023
IVECO	4276036	CR1015
IVECO	4291534	CR0620
IVECO	4294681	CR1018
IVECO	4296247	CR1017
IVECO	4712856	CR1019
IVECO	4727624	CR1007
IVECO	4744164	CR1007
IVECO	4837192	CR0620
IVECO	4846034	FL3207
IVECO	4846035	FL3208
IVECO	4860637	FCD003
IVECO	4860638	FCD004
IVECO	500300073	FL3001
IVECO	500300075	FL3002
IVECO	500351600	FCS001
IVECO	500351601	FCS002
IVECO	5006018456	AC0002
IVECO	60102882	CR0620
IVECO	7160129	1709401
IVECO	7160171	1708802
IVECO	7160175	1708802
IVECO	7162112	TF0014
IVECO	7162112	TF0014
IVECO	7165213	CR1011
IVECO	7165379	TF0014
IVECO	7165802	CR1023
IVECO	7910200	TF0014
IVECO	7980525	CR1002
IVECO	7984278	CR0414
IVECO	8121104	CR0414
IVECO	8121575	CR1002
IVECO	8121576	CR1003
IVECO	8123580	CR0420
IVECO	8193387	CR1020
IVECO	8193797	CR0928

MARQUE	REF OES	REFERENCE
IVECO	8193798	CR0929
IVECO	8193799	CR0932
IVECO	8193800	CR0933
IVECO	8193801	CR0940
IVECO	8193801	CR0940
IVECO	8193802	CR0941
IVECO	8193802	CR0941
IVECO	8193803	CR0936
IVECO	8193804	CR0937
IVECO	8194527	CR0420
IVECO	8559394	1740805
IVECO	93155720	CR0420
IVECO	93155721	CR1020
IVECO	93155722	CR0414
IVECO	93159002	CR1005
IVECO	93160540	CR1005
IVECO	93163355	ECF002
IVECO	93163525	ECF001
IVECO	93192921	98032200
IVECO	98449332	FL3207
IVECO	98449334	FL3208
IVECO	98452387	CR1006
IVECO	98464849	FCD003
IVECO	98464850	FCD004
IVECO	98474483	FCS001
IVECO	98474485	FCS002
IVECO	99436612	FL3207
IVECO	99436613	FL3208
IVECO	9983470	CR1002
IVECO	9983871	CR1003
KAESSBOHRER	8241999325	1909437
KAESSBOHRER	8241999326	1909439
KAESSBOHRER	8241999328	1903230
KAESSBOHRER	8241999329	1903231
KAESSBOHRER	8241999686	1957422
KAESSBOHRER	8241999721	1995201
KAESSBOHRER	8241999722	1995201
KAESSBOHRER	8241999733	1903230
KAESSBOHRER	8241999734	1903231
KAESSBOHRER	8241999735	1909437
KAESSBOHRER	8241999736	1909439
KAESSBOHRER	8282000491	1740805
KAESSBOHRER	8282000539	1740806
KAESSBOHRER	82820009610	1740806
KAESSBOHRER	82820009700	1740805
KAESSBOHRER	82820009780	1740805
KAESSBOHRER	8283000651	1974302
KAESSBOHRER	8283000769	1916602
KAESSBOHRER	8283000770	1916602

Les correspondances de références ont pour seul objectif d'aider la recherche de référence

Cross references are there for the sole purpose of helping the reference search

CORRESPONDANCE DES REFERENCES CROSS REFERENCE LIST

MARQUE	REF OES	REFERENCE
KAESSBOHRER	8285000064	1956801
KAESSBOHRER	8285000147	1956802
KAESSBOHRER	8285000227	1916602
KAESSBOHRER	8285000228	1916602
KAESSBOHRER	8285066060	1969905
KAESSBOHRER	8285200114	1969905
KAESSBOHRER	8285200115	1969905
KAESSBOHRER	8285200116	1969905
KAESSBOHRER	82852325220	1969906
KAESSBOHRER	8285232523	1969905
KAESSBOHRER	8285236223	1969905
KAESSBOHRER	8285236225	1969905
KAESSBOHRER	8285345369	1969905
KAESSBOHRER	8285345370	1969905
KAESSBOHRER	8285348407	1985502
KAESSBOHRER	8285348408	1985502
KAESSBOHRER	8285368361	1969905
KAESSBOHRER	8285368362	1969905
KAESSBOHRER	82855066040	1969906
KAESSBOHRER	82855086030	1969906
LEYLAND DAF	AMPB017	1950308
LEYLAND DAF	AMPB018	1950308
LEYLAND DAF	AMPB288	1790006
LEYLAND DAF	AMPB289	1581702
LEYLAND DAF	AMPB294	1581702
LEYLAND DAF	AMPB295	1790006
MAGIRUS	2560503E510712	1740805
MAGIRUS	2966745E510712	1740806
MAGIRUS	42481444	1740805
MAGIRUS	42481445	1740805
MAGIRUS	42481446	1740806
MAN	81259370022	98023600
MAN	81259370026	98023500
MAN	81259376011	98023500
MAN	81259376012	98023600
MAN	81502006504	MAC9496CAST
MAN	81502006752	1949504
MAN	81502006828	1949602
MAN	81502006829	1949504
MAN	81502010107	MAC9496CAST
MAN	81502016086	MAC9495CAST
MAN	81502016099	MAC9495CAST
MAN	81502016114	MAC9496CAST
MAN	81502016184	MAC9495CAST
MAN	81502016185	MAC9496CAST
MAN	81502016218	MAC9496CAST
MAN	81502016220	MAC9495CAST
MAN	81502016221	MAC9496CAST
MAN	81502016223	MAC9496CAST

MARQUE	REF OES	REFERENCE
MAN	81502200238	1949504
MAN	81502200283	1949504
MAN	81502200438	1949504
MAN	81502200505	1949504
MAN	81502200550	1949402
MAN	81502200550	1971301
MAN	81502200551	1949502
MAN	81502200632	1949604
MAN	81502200644	1949604
MAN	81502200647	1949604
MAN	81502200658	1949402
MAN	81502200658	1971301
MAN	81502200659	1949402
MAN	81502200659	1971301
MAN	81502200660	1949402
MAN	81502200660	1971301
MAN	81502200661	1949602
MAN	81502200662	1949602
MAN	81502200663	1949602
MAN	81502200720	1949504
MAN	81502200763	1949504
MAN	81502200769	1949504
MAN	81502200907	1949504
MAN	81502200995	1949402
MAN	81502200995	1971301
MAN	81502210006	1790006
MAN	81502210009	1790006
MAN	81502210012	1581702
MAN	81502210015	1581702
MAN	81502210059	1949504
MAN	81502210142	1723802
MAN	81502210165	1949604
MAN	81502210218	1949504
MAN	81502210236	1958101
MAN	81502210256	1958101
MAN	81502210276	1958101
MAN	81502210315	1768202
MAN	81502210318	1723802
MAN	81502210319	1723802
MAN	81502210325	1957901
MAN	81502210340	1957901
MAN	81502210375	1957901
MAN	81502210431	1723802
MAN	81502210436	1949402
MAN	81502210436	1971301
MAN	81502210440	1949504
MAN	81502210441	1949502
MAN	81502210445	1949604
MAN	81502210446	1949602

Les correspondances de références ont pour seul objectif d'aider la recherche de référence

Cross references are there for the sole purpose of helping the reference search

CORRESPONDANCE DES REFERENCES CROSS REFERENCE LIST

MARQUE	REF OES	REFERENCE
MAN	81502210450	1949504
MAN	81502210451	1949502
MAN	81502210516	1723802
MAN	81502210521	1949402
MAN	81502210521	1971301
MAN	81502210525	1949504
MAN	81502210526	1949502
MAN	81502210530	1949604
MAN	81502210531	1949602
MAN	81502210536	1957901
MAN	81502210541	1957901
MAN	81502210546	1958101
MAN	81502210551	1958101
MAN	81502210584	1587906
MAN	81502210587	1798806
MAN	81502210588	1798807
MAN	81502210591	1949604
MAN	81502210596	1949604
MAN	81502210615	1949504
MAN	81502210616	1701703
MAN	81502210617	1701704
MAN	81502210619	1917705
MAN	81502210623	1949604
MAN	81502210635	1723802
MAN	81502210640	1949402
MAN	81502210640	1971301
MAN	81502210644	1949504
MAN	81502210645	1949502
MAN	81502210646	1949504
MAN	81502210649	1949604
MAN	81502210650	1949602
MAN	81502210655	1957901
MAN	81502210660	1957901
MAN	81502210665	1958101
MAN	81502210670	1958101
MAN	81502210673	1587906
MAN	81502210674	1798806
MAN	81502210675	1701703
MAN	81502210676	1917705
MAN	81502210678	1949604
MAN	81502210680	1971301
MAN	81502210681	1949602
MAN	81502210712	1957901
MAN	81502210717	1957901
MAN	81502210722	1958101
MAN	81502210727	1958101
MAN	81502210736	1798807
MAN	81502210738	1701704
MAN	81502210768	1768202

MARQUE	REF OES	REFERENCE
MAN	81502210770	1949504
MAN	81502210771	1949502
MAN	81502210780	1949604
MAN	81502210783	1723802
MAN	81502210784	1949502
MAN	81502210785	1581702
MAN	81502210788	1581702
MAN	81502210791	1790006
MAN	81502210794	1790006
MAN	81502210804	1949402
MAN	81502210804	1971301
MAN	81502210808	1949504
MAN	81502210809	1949502
MAN	81502210813	1949604
MAN	81502210814	1949602
MAN	81502210817	1949604
MAN	81502210819	1949604
MAN	81502210820	1949604
MAN	81502210830	1723802
MAN	81502210835	1723802
MAN	81502210840	1949402
MAN	81502210840	1971301
MAN	81502210845	1949402
MAN	81502210845	1971301
MAN	81502210849	1949504
MAN	81502210850	1949502
MAN	81502210854	1949504
MAN	81502210855	1949502
MAN	81502210859	1949604
MAN	81502210860	1949602
MAN	81502210864	1949604
MAN	81502210865	1949602
MAN	81502210878	1957901
MAN	81502210883	1957901
MAN	81502210888	1958101
MAN	81502210893	1958101
MAN	81502210898	1723802
MAN	81502210903	1949402
MAN	81502210903	1971301
MAN	81502210907	1949504
MAN	81502210908	1949502
MAN	81502210908	1949504
MAN	81502210912	1949604
MAN	81502210913	1949602
MAN	81502210921	1949602
MAN	81502210922	1949402
MAN	81502210922	1971301
MAN	81502210926	1949604
MAN	81502210944	1971301

Les correspondances de références ont pour seul objectif d'aider la recherche de référence

Cross references are there for the sole purpose of helping the reference search

CORRESPONDANCE DES REFERENCES CROSS REFERENCE LIST

MARQUE	REF OES	REFERENCE
MAN	81502216013	1587906
MAN	81502216016	1798806
MAN	81502216017	1798807
MAN	81502216025	1701703
MAN	81502216026	1701704
MAN	81502216028	1917705
MAN	81502216031	1798806
MAN	81502216032	1798807
MAN	81502216034	1587906
MAN	81502216037	1701703
MAN	81502216038	1701704
MAN	81502216040	1917705
MAN	81502216043	1798806
MAN	81502216044	1798807
MAN	81502216049	1917705
MAN	81502216055	1701703
MAN	81502216056	1701704
MAN	81502216061	1587906
MAN	81502216070	1970803
MAN	81502216073	1723802
MAN	81502216077	1949502
MAN	81502216078	1949504
MAN	81502216081	1949602
MAN	81502216082	1949604
MAN	81502216085	1949402
MAN	81502216085	1971301
MAN	81502216089	1723802
MAN	81502216093	1949402
MAN	81502216093	1971301
MAN	81502216097	1949502
MAN	81502216098	1949504
MAN	81502216101	1949602
MAN	81502216102	1949604
MAN	88502200024	1949604
MAN	88502200036	1949402
MAN	88502200036	1971301
MAN	88502200040	1949602
MAN	88502200045	1957901
MAN	88502200050	1957901
MAN	88502200055	1958101
MAN	88502200060	1958101
MERCEDES	0004210131	1969905
MERCEDES	0035401217	98016800
MERCEDES	0054208118	CR0581
MERCEDES	0084202418	CR0748
MERCEDES	0084204218	CR0581
MERCEDES	0084204418	CR0748
MERCEDES	0094201118	CR0748
MERCEDES	3014211810	1779501

MARQUE	REF OES	REFERENCE
MERCEDES	3014212110	1779501
MERCEDES	3014215510	1779501
MERCEDES	3014215810	1779501
MERCEDES	3014218810	1779501
MERCEDES	3014231610	1949505
MERCEDES	3014231910	1949505
MERCEDES	3014234910	1970618
MERCEDES	3014235210	1970618
MERCEDES	3014236110	1970702
MERCEDES	3014236410	1970702
MERCEDES	3014237010	1970601
MERCEDES	3014237010	1970618
MERCEDES	3014237110	1970618
MERCEDES	3014237910	1970701
MERCEDES	3014237910	1970702
MERCEDES	3014238010	1970702
MERCEDES	3024232710	19466xx
MERCEDES	3024233010	19466xx
MERCEDES	3054210010	1949402
MERCEDES	3054230310	1949602
MERCEDES	3054230310	1949604
MERCEDES	3054230410	1949605
MERCEDES	3054230610	19466xx
MERCEDES	3054230910	1949602
MERCEDES	3054230910	1949604
MERCEDES	3054231010	1949605
MERCEDES	3054231210	19466xx
MERCEDES	3074211210	1779501
MERCEDES	3074211510	1779501
MERCEDES	3074211610	1779501
MERCEDES	3074213610	1779501
MERCEDES	3074213910	1779501
MERCEDES	3074215410	1779501
MERCEDES	3094210410	1534906
MERCEDES	3094210510	1534907
MERCEDES	3094210710	1534906
MERCEDES	3094210810	1534907
MERCEDES	3094214910	1534906
MERCEDES	3094215210	1558008
MERCEDES	3103251300	15057xx
MERCEDES	3104214410	1558008
MERCEDES	3104215110	15057xx
MERCEDES	3144210510	15057xx
MERCEDES	3164211910	1740909
MERCEDES	3164212310	1740909
MERCEDES	3164212410	1740909
MERCEDES	3164212510	1740909
MERCEDES	3174215610	19125xx
MERCEDES	3174232510	19466xx

Les correspondances de références ont pour seul objectif d'aider la recherche de référence

Cross references are there for the sole purpose of helping the reference search

CORRESPONDANCE DES REFERENCES CROSS REFERENCE LIST

MARQUE	REF OES	REFERENCE
MERCEDES	3174232810	19466xx
MERCEDES	3174233210	19466xx
MERCEDES	3174233510	19466xx
MERCEDES	3174235010	19466xx
MERCEDES	3184211910	1740909
MERCEDES	3244210610	15057xx
MERCEDES	3244211010	15057xx
MERCEDES	3244211410	15057xx
MERCEDES	3244211510	15057xx
MERCEDES	3354210110	1727601
MERCEDES	3354210510	1727601
MERCEDES	3354211110	1727601
MERCEDES	3354211910	1727601
MERCEDES	3354212710	1727601
MERCEDES	3414234110	17298xx
MERCEDES	3464210010	1723802
MERCEDES	3464210110	1723804
MERCEDES	3464230010	1949502
MERCEDES	3464230110	1949505
MERCEDES	3464230310	1949402
MERCEDES	3464230310	1949404
MERCEDES	3464230610	1949502
MERCEDES	3464230710	1949505
MERCEDES	3464230810	1949505
MERCEDES	3464230910	1949502
MERCEDES	3464231010	1949505
MERCEDES	3464231210	1949402
MERCEDES	3464231210	1949404
MERCEDES	3464231910	1723802
MERCEDES	3464232010	1723804
MERCEDES	3464232210	1723802
MERCEDES	3464232310	1723804
MERCEDES	3464232510	1723802
MERCEDES	3464232610	1723804
MERCEDES	3464232810	1949502
MERCEDES	3464232910	1949505
MERCEDES	3464233110	1949402
MERCEDES	3464233410	1949502
MERCEDES	3464233510	1949505
MERCEDES	3464233710	1949402
MERCEDES	3464234110	1723802
MERCEDES	3464234210	1723804
MERCEDES	3464235810	1949404
MERCEDES	3464237110	1949505
MERCEDES	3464237410	1949505
MERCEDES	3464238310	1949505
MERCEDES	3464238610	1949505
MERCEDES	3494210010	1727601
MERCEDES	3494210310	1727601

MARQUE	REF OES	REFERENCE
MERCEDES	3494210910	1727601
MERCEDES	3494211010	1727601
MERCEDES	3494211210	1727601
MERCEDES	3504200219	MAC9496CAST
MERCEDES	3524210010	1768202
MERCEDES	3524210310	1768202
MERCEDES	3534230610	1768202
MERCEDES	3534231210	1768202
MERCEDES	3534233410	17297xx
MERCEDES	3554233410	19125xx
MERCEDES	3574211310	1970618
MERCEDES	3574211410	1970618
MERCEDES	3574212210	1779501
MERCEDES	3574230111	1970701
MERCEDES	3574230211	1970702
MERCEDES	3574230411	1970601
MERCEDES	3574230511	1970618
MERCEDES	3574230710	1970618
MERCEDES	3574231010	1970618
MERCEDES	3574231011	1970702
MERCEDES	3574231310	1970702
MERCEDES	3574231610	1970702
MERCEDES	3574231911	1970618
MERCEDES	3574232211	1970702
MERCEDES	3574233510	1970701
MERCEDES	3574233610	1970702
MERCEDES	3574234710	1970601
MERCEDES	3574234810	1970618
MERCEDES	3574235810	1970618
MERCEDES	3574236110	1970618
MERCEDES	3574237010	1970702
MERCEDES	3574237310	1970702
MERCEDES	3574238310	1970618
MERCEDES	3574238610	1970618
MERCEDES	3574239510	1970702
MERCEDES	3574239810	1970702
MERCEDES	3604210910	1723802
MERCEDES	3604211010	1723804
MERCEDES	3604211210	1723802
MERCEDES	3604211310	1723804
MERCEDES	3604230410	1949402
MERCEDES	3604230710	1949402
MERCEDES	3604231010	1723802
MERCEDES	3604231110	1723804
MERCEDES	3604231910	1949404
MERCEDES	3814210010	1768202
MERCEDES	3814210110	1768202
MERCEDES	3834210610	1768202
MERCEDES	3834210910	1768202

Les correspondances de références ont pour seul objectif d'aider la recherche de référence

Cross references are there for the sole purpose of helping the reference search

CORRESPONDANCE DES REFERENCES CROSS REFERENCE LIST

MARQUE	REF OES	REFERENCE
MERCEDES	3834212810	1723802
MERCEDES	3834212910	1723802
MERCEDES	3834213010	1723804
MERCEDES	3854210010	1949402
MERCEDES	3854210310	1949402
MERCEDES	3854211310	1723804
MERCEDES	3854230110	1723802
MERCEDES	3854230210	1723804
MERCEDES	3854230410	1723802
MERCEDES	3854230510	1723804
MERCEDES	3854231310	1949402
MERCEDES	3854231410	1949402
MERCEDES	3854231510	1949404
MERCEDES	3894206119	MAC9495CAST
MERCEDES	3894206419	MAC9495CAST
MERCEDES	4634201220	1503002
MERCEDES	4634230310	1503003
MERCEDES	4884210010	1723802
MERCEDES	4884210110	1723804
MERCEDES	4974210010	1723802
MERCEDES	4974210110	1723804
MERCEDES	6014235001	TF0221
MERCEDES	6014235101	TF0220
MERCEDES	6014300922	MF0572
MERCEDES	6015400617	98016800
MERCEDES	6114209020	1503002
MERCEDES	6114209020	MF0525
MERCEDES	6114231010	1503002
MERCEDES	6114231110	1503003
MERCEDES	6114231410	1503002
MERCEDES	6114231510	1503003
MERCEDES	6114231810	1503002
MERCEDES	6114231910	1503003
MERCEDES	6114232210	1503002
MERCEDES	6114232310	1503003
MERCEDES	6114232510	1503002
MERCEDES	6114233010	1503003
MERCEDES	6174211210	1768202
MERCEDES	6174211610	1768202
MERCEDES	6174230030	1949602
MERCEDES	6174230110	1949505
MERCEDES	6174230311	1723802
MERCEDES	6174230411	1723804
MERCEDES	6174230530	1949602
MERCEDES	6174230711	1949402
MERCEDES	6174231111	1949502
MERCEDES	6174231330	1949502
MERCEDES	617423133067	1949502
MERCEDES	617423133068	1949502

MARQUE	REF OES	REFERENCE
MERCEDES	6174231430	1949504
MERCEDES	6174231511	1949502
MERCEDES	6174231711	1949504
MERCEDES	6174231730	1949402
MERCEDES	6174231810	1949504
MERCEDES	6174231830	1949404
MERCEDES	6174231910	1949505
MERCEDES	6174231911	1949402
MERCEDES	6174232011	1949404
MERCEDES	6174232111	1949505
MERCEDES	6174232210	1768202
MERCEDES	6174232230	1723802
MERCEDES	617423223067	1723802
MERCEDES	6174232311	1949502
MERCEDES	6174232411	1949504
MERCEDES	6174232610	1723802
MERCEDES	6174232630	1723802
MERCEDES	6174232710	1723804
MERCEDES	6174232711	1949502
MERCEDES	6174232711	1949504
MERCEDES	6174232911	1949505
MERCEDES	6174233010	1949402
MERCEDES	6174233110	1949404
MERCEDES	6174233111	1949602
MERCEDES	6174233211	1949604
MERCEDES	6174233311	1768202
MERCEDES	6174233311	1949604
MERCEDES	6174233410	1949502
MERCEDES	6174233411	1949602
MERCEDES	6174233411	1949605
MERCEDES	6174233911	1723802
MERCEDES	6174234011	1723804
MERCEDES	6174234310	1723802
MERCEDES	6174234311	1723802
MERCEDES	6174234410	1723804
MERCEDES	6174234411	1723804
MERCEDES	6174234710	1949402
MERCEDES	6174234711	1949402
MERCEDES	6174234811	1949404
MERCEDES	6174235110	1949502
MERCEDES	6174235111	1949502
MERCEDES	6174235310	1949505
MERCEDES	6174235510	1949602
MERCEDES	6174235511	1949602
MERCEDES	6174235610	1949604
MERCEDES	6174235710	1949605
MERCEDES	6174235711	1949605
MERCEDES	6174235911	1949502
MERCEDES	6174236210	1949602

Les correspondances de références ont pour seul objectif d'aider la recherche de référence

Cross references are there for the sole purpose of helping the reference search

CORRESPONDANCE DES REFERENCES CROSS REFERENCE LIST

MARQUE	REF OES	REFERENCE
MERCEDES	6174236310	1723802
MERCEDES	6174236311	1949502
MERCEDES	6174236410	1723804
MERCEDES	6174236511	1949505
MERCEDES	6174236710	1949402
MERCEDES	6174237110	1949502
MERCEDES	6174237111	1949502
MERCEDES	6174237310	1949505
MERCEDES	6174237510	1949602
MERCEDES	6174237610	1949604
MERCEDES	6174237710	1949605
MERCEDES	6174238010	1949604
MERCEDES	6174238110	1949605
MERCEDES	6174238211	1723802
MERCEDES	6174238310	1723802
MERCEDES	6174238410	1723804
MERCEDES	6174238710	1949402
MERCEDES	6174239110	1949502
MERCEDES	6174239210	1949504
MERCEDES	6174239310	1949505
MERCEDES	6174239311	1949502
MERCEDES	6174239510	1949602
MERCEDES	6174239610	1949604
MERCEDES	6174239710	1949605
MERCEDES	6174239911	1768202
MERCEDES	6204200119	MAC9496CAST
MERCEDES	6204200319	MAC9496CAST
MERCEDES	6204200519	MAC9496CAST
MERCEDES	6214210010	1949402
MERCEDES	6214210410	1949402
MERCEDES	6214210510	1949404
MERCEDES	6214210810	1949402
MERCEDES	621421081068	1949402
MERCEDES	6214210910	1949404
MERCEDES	6244200019	MAC9496CAST
MERCEDES	6244200219	MAC9496CAST
MERCEDES	6504231310	1723802
MERCEDES	6504231410	1723804
MERCEDES	6524200019	MAC9496CAST
MERCEDES	6524231410	1949505
MERCEDES	6524231610	1949602
MERCEDES	6524231710	1949604
MERCEDES	6524231810	1949605
MERCEDES	6594200419	MAC9496CAST
MERCEDES	6594200519	MAC9496CAST
MERCEDES	6594200519	MAC9496CAST
MERCEDES	6594200619	MAC9495CAST
MERCEDES	6594210010	1723802
MERCEDES	6594210110	1723804

MARQUE	REF OES	REFERENCE
MERCEDES	6594210410	1949402
MERCEDES	6594210810	1723802
MERCEDES	6594210910	1723804
MERCEDES	6594211210	1949402
MERCEDES	6594211610	1723802
MERCEDES	6594211710	1723804
MERCEDES	6594212010	1949402
MERCEDES	6594230010	1949502
MERCEDES	6594230210	1949505
MERCEDES	6594230410	1949602
MERCEDES	6594230810	1949502
MERCEDES	6594230910	1949504
MERCEDES	6594231210	1949602
MERCEDES	6594231610	1949502
MERCEDES	6594231710	1949504
MERCEDES	6594232010	1949602
MERCEDES	6594232110	1949604
MERCEDES	6594232120	1949604
MERCEDES	6594232210	1949605
MERCEDES	6594232310	1949502
MERCEDES	6594232410	1949504
MERCEDES	6594232510	1949502
MERCEDES	6594233710	1949602
MERCEDES	6594234010	1949504
MERCEDES	6674230110	1503003
MERCEDES	6674230210	1503002
MERCEDES	6674231410	1503002
MERCEDES	6674231510	1503003
MERCEDES	6674232910	1503002
MERCEDES	6674233010	1503003
MERCEDES	6674233310	1503002
MERCEDES	6674233410	1503003
MERCEDES	6684230010	1735103
MERCEDES	6684230110	1735104
MERCEDES	6684230810	1735003
MERCEDES	6684230910	1735004
MERCEDES	6684231610	1505901
MERCEDES	6684232510	1735103
MERCEDES	6684232610	1735104
MERCEDES	6684232910	1735003
MERCEDES	6684233010	1735004
MERCEDES	6684233310	1505901
MERCEDES	6684233710	1735103
MERCEDES	6684233810	1735104
MERCEDES	6684234110	1735003
MERCEDES	6684234210	1735004
MERCEDES	6684234510	1505901
MERCEDES	6684236210	1505901
MERCEDES	6694230110	1735004

Les correspondances de références ont pour seul objectif d'aider la recherche de référence

Cross references are there for the sole purpose of helping the reference search

CORRESPONDANCE DES REFERENCES CROSS REFERENCE LIST

MARQUE	REF OES	REFERENCE
MERCEDES	6694230410	1735003
MERCEDES	6694230510	1735004
MERCEDES	6704231211	1735004
MERCEDES	6704231511	1735104
MERCEDES	6704232211	1735103
MERCEDES	6704232311	1735104
MERCEDES	6704232611	1735103
MERCEDES	6704232711	1735104
MERCEDES	6704233011	1735003
MERCEDES	6704233111	1735004
MERCEDES	6704233811	1505901
MERCEDES	6704234211	1505901
MERCEDES	6704234711	1735103
MERCEDES	6704234811	1735104
MERCEDES	6704235111	1735103
MERCEDES	6704235211	1735104
MERCEDES	6704235911	1735003
MERCEDES	6704236011	1735003
MERCEDES	6704236411	1735104
MERCEDES	6704236611	1735104
MERCEDES	6704237111	1735103
MERCEDES	6704237611	1735104
MERCEDES	6704238210	1735103
MERCEDES	6704238310	1735104
MERCEDES	6704239010	1735003
MERCEDES	6704239110	1735004
MERCEDES	6704239810	1505901
MERCEDES	6705400017	98016900
MERCEDES	6734210331	1728705
MERCEDES	6734210431	1728706
MERCEDES	6734210731	1728006
MERCEDES	6734210831	1728007
MERCEDES	6734211131	1727806
MERCEDES	6734211231	1727807
MERCEDES	6734211531	1516203
MERCEDES	6734211931	1516203
MERCEDES	6734212331	1727806
MERCEDES	6734212431	1727807
MERCEDES	6734212731	1728006
MERCEDES	6734212831	1728007
MERCEDES	6734213131	1728705
MERCEDES	6734213231	1728706
MERCEDES	6734213531	1727807
MERCEDES	6734213531	1728006
MERCEDES	6734214410	1516203
MERCEDES	6734214430	1728006
MERCEDES	6734215810	1728705
MERCEDES	6734215830	1516203
MERCEDES	6734215910	1728706

MARQUE	REF OES	REFERENCE
MERCEDES	6734216210	1728006
MERCEDES	6734216230	1728006
MERCEDES	6734216310	1728007
MERCEDES	6734216610	1727806
MERCEDES	6734216710	1727807
MERCEDES	6734217010	1516203
MERCEDES	6734217610	1728705
MERCEDES	6734217710	1728706
MERCEDES	6734218010	1728006
MERCEDES	6734218130	1728705
MERCEDES	6734218410	1727806
MERCEDES	6734218510	1727807
MERCEDES	6734218530	1728006
MERCEDES	6734218810	1516203
MERCEDES	6734218830	1727807
MERCEDES	6734219430	1728705
MERCEDES	6734219530	1728706
MERCEDES	6734219810	1727806
MERCEDES	6734219830	1727806
MERCEDES	6734219930	1727807
MERCEDES	6744211230	1728705
MERCEDES	6744211330	1728706
MERCEDES	6744211630	1728006
MERCEDES	6744211730	1728007
MERCEDES	6744212030	1727806
MERCEDES	6744212130	1727807
MERCEDES	6744212430	1516203
MERCEDES	6744212830	1728705
MERCEDES	6744212930	1728706
MERCEDES	6744213230	1728006
MERCEDES	6744213330	1728007
MERCEDES	6744213630	1727806
MERCEDES	6744213730	1727807
MERCEDES	6744214030	1516203
MERCEDES	6744214430	1728705
MERCEDES	6744214530	1728706
MERCEDES	6744214830	1728006
MERCEDES	6744214930	1728007
MERCEDES	6744215230	1727806
MERCEDES	6744215330	1727807
MERCEDES	6744215630	1516203
MERCEDES	6744219810	1727806
MERCEDES	6744219910	1727807
MERCEDES	6754210830	1950607
MERCEDES	6754210930	1950608
MERCEDES	6754211730	1729006
MERCEDES	6754211830	1729007
MERCEDES	6754212130	1950607
MERCEDES	6754212230	1950608

Les correspondances de références ont pour seul objectif d'aider la recherche de référence

Cross references are there for the sole purpose of helping the reference search

CORRESPONDANCE DES REFERENCES CROSS REFERENCE LIST

MARQUE	REF OES	REFERENCE
MERCEDES	6754212530	1950607
MERCEDES	6754212630	1950608
MERCEDES	6754212930	1950505
MERCEDES	6754213030	1950506
MERCEDES	6754213330	1950505
MERCEDES	6754213430	1950506
MERCEDES	6754213730	1729006
MERCEDES	6754213810	1729006
MERCEDES	6754213830	1729007
MERCEDES	6754214010	1729007
MERCEDES	6754214130	1950607
MERCEDES	6754214230	1950608
MERCEDES	6754214510	1950607
MERCEDES	6754214530	1950505
MERCEDES	6754214610	1950607
MERCEDES	6754214630	1950506
MERCEDES	6754214710	1950608
MERCEDES	6754214810	1950608
MERCEDES	6754216210	1729006
MERCEDES	6754216410	1729007
MERCEDES	6754216810	1950607
MERCEDES	6754216910	1950607
MERCEDES	6754217010	1950607
MERCEDES	6754217110	1950608
MERCEDES	6754217210	1950608
MERCEDES	6754218010	1950505
MERCEDES	6754218110	1950505
MERCEDES	6754218210	1950506
MERCEDES	6754218310	1950506
MERCEDES	6754218810	1950505
MERCEDES	6754218910	1950505
MERCEDES	6754219010	1950506
MERCEDES	6754219110	1950506
MERCEDES	6754219610	1950505
MERCEDES	6754219710	1950506
MERCEDES	6764210010	1729006
MERCEDES	6764210110	1729007
MERCEDES	6764210410	1950607
MERCEDES	6764210510	1950608
MERCEDES	6764210810	1950505
MERCEDES	6764210910	1950506
MERCEDES	6764211210	1729006
MERCEDES	6764211310	1729007
MERCEDES	6764211610	1950607
MERCEDES	6764211710	1950608
MERCEDES	6764212010	1950505
MERCEDES	6764212110	1950506
MERCEDES	6764212410	1729006
MERCEDES	6764212510	1729007

MARQUE	REF OES	REFERENCE
MERCEDES	6764212810	1950607
MERCEDES	6764212910	1950608
MERCEDES	6764213210	1950505
MERCEDES	6764213310	1950506
MERCEDES	6764214510	1729007
MERCEDES	6775400717	98017002
MERCEDES	6775400817	98017102
MERCEDES	A0004210131	1969905
MERCEDES	A0035401217	98016800
MERCEDES	A0054208118	CR0581
MERCEDES	A0084204218	CR0581
MERCEDES	A3014218810	1779501
MERCEDES	A3014234910	1970618
MERCEDES	A3014235210	1970618
MERCEDES	A3014236110	1970702
MERCEDES	A3014236410	1970702
MERCEDES	A3014237010	1970601
MERCEDES	A3014237010	1970618
MERCEDES	A3014237110	1970618
MERCEDES	A3014237910	1970701
MERCEDES	A3014237910	1970702
MERCEDES	A3014238010	1970702
MERCEDES	A3024232710	19466xx
MERCEDES	A3024233010	19466xx
MERCEDES	A3054210010	1949402
MERCEDES	A3054230310	1949602
MERCEDES	A3054230610	19466xx
MERCEDES	A3054230910	1949602
MERCEDES	A3054231210	19466xx
MERCEDES	A3094210410	1534906
MERCEDES	A3094210510	1534907
MERCEDES	A3094210710	1534906
MERCEDES	A3094210810	1534907
MERCEDES	A3094214910	1534906
MERCEDES	A3094215210	1558008
MERCEDES	A3104214410	1558008
MERCEDES	A3144210510	15057xx
MERCEDES	A3164211910	1740909
MERCEDES	A3164212310	1740909
MERCEDES	A3164212410	1740909
MERCEDES	A3164212510	1740909
MERCEDES	A3174215610	19125xx
MERCEDES	A3174232510	19466xx
MERCEDES	A3174232810	19466xx
MERCEDES	A3174233210	19466xx
MERCEDES	A3174233510	19466xx
MERCEDES	A3174235010	19466xx
MERCEDES	A3184211910	1740909
MERCEDES	A3354210110	1727601

Les correspondances de références ont pour seul objectif d'aider la recherche de référence

Cross references are there for the sole purpose of helping the reference search

CORRESPONDANCE DES REFERENCES CROSS REFERENCE LIST

MARQUE	REF OES	REFERENCE
MERCEDES	A3354210510	1727601
MERCEDES	A3354211110	1727601
MERCEDES	A3354211910	1727601
MERCEDES	A3354212710	1727601
MERCEDES	A3414234110	17298xx
MERCEDES	A3464210010	1723802
MERCEDES	A3464210110	1723804
MERCEDES	A3464230010	1949502
MERCEDES	A3464230310	1949402
MERCEDES	A3464230610	1949502
MERCEDES	A3464230910	1949502
MERCEDES	A3464231210	1949402
MERCEDES	A3464231910	1723802
MERCEDES	A3464232010	1723804
MERCEDES	A3464232210	1723802
MERCEDES	A3464232310	1723804
MERCEDES	A3464232510	1723802
MERCEDES	A3464232610	1723804
MERCEDES	A3464232810	1949502
MERCEDES	A3464233110	1949402
MERCEDES	A3464233410	1949502
MERCEDES	A3464233710	1949402
MERCEDES	A3464234110	1723802
MERCEDES	A3464234210	1723804
MERCEDES	A3494210010	1727601
MERCEDES	A3494210310	1727601
MERCEDES	A3494210910	1727601
MERCEDES	A3494211010	1727601
MERCEDES	A3494211210	1727601
MERCEDES	A3524210010	1768202
MERCEDES	A3524210310	1768202
MERCEDES	A3534230610	1768202
MERCEDES	A3534231210	1768202
MERCEDES	A3534233410	17297xx
MERCEDES	A3554233410	19125xx
MERCEDES	A3574211310	1970618
MERCEDES	A3574211410	1970618
MERCEDES	A3574212210	1779501
MERCEDES	A3574230111	1970701
MERCEDES	A3574230211	1970702
MERCEDES	A3574230411	1970601
MERCEDES	A3574230511	1970618
MERCEDES	A3574230710	1970618
MERCEDES	A3574231010	1970618
MERCEDES	A3574231011	1970702
MERCEDES	A3574231310	1970702
MERCEDES	A3574231610	1970702
MERCEDES	A3574231911	1970618
MERCEDES	A3574232211	1970702

MARQUE	REF OES	REFERENCE
MERCEDES	A3574233510	1970701
MERCEDES	A3574233610	1970702
MERCEDES	A3574234710	1970601
MERCEDES	A3574234810	1970618
MERCEDES	A3574235810	1970618
MERCEDES	A3574236110	1970618
MERCEDES	A3574237010	1970702
MERCEDES	A3574237310	1970702
MERCEDES	A3574238310	1970618
MERCEDES	A3574238610	1970618
MERCEDES	A3574239510	1970702
MERCEDES	A3574239810	1970702
MERCEDES	A3604210910	1723802
MERCEDES	A3604211010	1723804
MERCEDES	A3604211210	1723802
MERCEDES	A3604211310	1723804
MERCEDES	A3604230410	1949402
MERCEDES	A3604230710	1949402
MERCEDES	A3604231010	1723802
MERCEDES	A3604231110	1723804
MERCEDES	A3814210010	1768202
MERCEDES	A3814210110	1768202
MERCEDES	A3834210610	1768202
MERCEDES	A3834210910	1768202
MERCEDES	A3834212810	1723802
MERCEDES	A3834212910	1723802
MERCEDES	A3834213010	1723804
MERCEDES	A3854210010	1949402
MERCEDES	A3854210310	1949402
MERCEDES	A3854211310	1723804
MERCEDES	A3854230110	1723802
MERCEDES	A3854230210	1723804
MERCEDES	A3854230410	1723802
MERCEDES	A3854230510	1723804
MERCEDES	A3854231310	1949402
MERCEDES	A3854231410	1949402
MERCEDES	A4634201220	1503002
MERCEDES	A4634230310	1503003
MERCEDES	A4884210010	1723802
MERCEDES	A4884210110	1723804
MERCEDES	A4974210010	1723802
MERCEDES	A4974210110	1723804
MERCEDES	A6015400617	98016800
MERCEDES	A6114209020	1503002
MERCEDES	A6114231010	1503002
MERCEDES	A6114231110	1503003
MERCEDES	A6114231410	1503002
MERCEDES	A6114231510	1503003
MERCEDES	A6114231810	1503002

Les correspondances de références ont pour seul objectif d'aider la recherche de référence

Cross references are there for the sole purpose of helping the reference search

CORRESPONDANCE DES REFERENCES CROSS REFERENCE LIST

MARQUE	REF OES	REFERENCE
MERCEDES	A6114231910	1503003
MERCEDES	A6114232210	1503002
MERCEDES	A6114232310	1503003
MERCEDES	A6114232510	1503002
MERCEDES	A6114233010	1503003
MERCEDES	A6174211210	1768202
MERCEDES	A6174211610	1768202
MERCEDES	A6174230030	1949602
MERCEDES	A6174230311	1723802
MERCEDES	A6174230411	1723804
MERCEDES	A6174230530	1949602
MERCEDES	A6174230711	1949402
MERCEDES	A6174231111	1949502
MERCEDES	A6174231330	1949502
MERCEDES	A617423133067	1949502
MERCEDES	A617423133068	1949502
MERCEDES	A6174231511	1949502
MERCEDES	A6174231730	1949402
MERCEDES	A6174231810	1949504
MERCEDES	A6174231911	1949402
MERCEDES	A6174232210	1768202
MERCEDES	A6174232230	1723802
MERCEDES	A617423223067	1723802
MERCEDES	A6174232311	1949502
MERCEDES	A6174232610	1723802
MERCEDES	A6174232630	1723802
MERCEDES	A6174232710	1723804
MERCEDES	A6174232711	1949502
MERCEDES	A6174233010	1949402
MERCEDES	A6174233111	1949602
MERCEDES	A6174233311	1768202
MERCEDES	A6174233410	1949502
MERCEDES	A6174233411	1949602
MERCEDES	A6174233911	1723802
MERCEDES	A6174234011	1723804
MERCEDES	A6174234310	1723802
MERCEDES	A6174234311	1723802
MERCEDES	A6174234410	1723804
MERCEDES	A6174234411	1723804
MERCEDES	A6174234710	1949402
MERCEDES	A6174234711	1949402
MERCEDES	A6174235110	1949502
MERCEDES	A6174235111	1949502
MERCEDES	A6174235510	1949602
MERCEDES	A6174235511	1949602
MERCEDES	A6174235911	1949502
MERCEDES	A6174236210	1949602
MERCEDES	A6174236310	1723802
MERCEDES	A6174236311	1949502

MARQUE	REF OES	REFERENCE
MERCEDES	A6174236410	1723804
MERCEDES	A6174236710	1949402
MERCEDES	A6174237110	1949502
MERCEDES	A6174237111	1949502
MERCEDES	A6174237510	1949602
MERCEDES	A6174238211	1723802
MERCEDES	A6174238310	1723802
MERCEDES	A6174238410	1723804
MERCEDES	A6174238710	1949402
MERCEDES	A6174239110	1949502
MERCEDES	A6174239310	1949505
MERCEDES	A6174239311	1949502
MERCEDES	A6174239510	1949602
MERCEDES	A6174239610	1949604
MERCEDES	A6174239710	1949605
MERCEDES	A6174239911	1768202
MERCEDES	A6214210010	1949402
MERCEDES	A6214210410	1949402
MERCEDES	A6214210810	1949402
MERCEDES	A621421081067	1949402
MERCEDES	A621421081068	1949402
MERCEDES	A6314200020	1970601
MERCEDES	A6504231310	1723802
MERCEDES	A6504231410	1723804
MERCEDES	A6594210010	1723802
MERCEDES	A6594210110	1723804
MERCEDES	A6594210410	1949402
MERCEDES	A6594210810	1723802
MERCEDES	A6594210910	1723804
MERCEDES	A6594211210	1949402
MERCEDES	A6594211610	1723802
MERCEDES	A6594211710	1723804
MERCEDES	A6594212010	1949402
MERCEDES	A6594230010	1949502
MERCEDES	A6594230410	1949602
MERCEDES	A6594230810	1949502
MERCEDES	A6594231210	1949602
MERCEDES	A6594231610	1949502
MERCEDES	A6594232010	1949602
MERCEDES	A6594232120	1949604
MERCEDES	A6594232310	1949502
MERCEDES	A6594232510	1949502
MERCEDES	A6594233710	1949602
MERCEDES	A6674230110	1503003
MERCEDES	A6674230210	1503002
MERCEDES	A6674231410	1503002
MERCEDES	A6674231510	1503003
MERCEDES	A6674232910	1503002
MERCEDES	A6674233010	1503003

Les correspondances de références ont pour seul objectif d'aider la recherche de référence

Cross references are there for the sole purpose of helping the reference search

CORRESPONDANCE DES REFERENCES CROSS REFERENCE LIST

MARQUE	REF OES	REFERENCE
MERCEDES	A6674233310	1503002
MERCEDES	A6674233410	1503003
MERCEDES	A6684230010	1735103
MERCEDES	A6684230110	1735104
MERCEDES	A6684230810	1735003
MERCEDES	A6684230910	1735004
MERCEDES	A6684231610	1505901
MERCEDES	A6684232510	1735103
MERCEDES	A6684232610	1735104
MERCEDES	A6684232910	1735003
MERCEDES	A6684233010	1735004
MERCEDES	A6684233310	1505901
MERCEDES	A6684233710	1735103
MERCEDES	A6684233810	1735104
MERCEDES	A6684234110	1735003
MERCEDES	A6684234210	1735004
MERCEDES	A6684234510	1505901
MERCEDES	A6684236210	1505901
MERCEDES	A6694230110	1735004
MERCEDES	A6694230410	1735003
MERCEDES	A6694230510	1735004
MERCEDES	A6704231211	1735004
MERCEDES	A6704231511	1735104
MERCEDES	A6704232211	1735103
MERCEDES	A6704232311	1735104
MERCEDES	A6704232611	1735103
MERCEDES	A6704232711	1735104
MERCEDES	A6704233011	1735003
MERCEDES	A6704233111	1735004
MERCEDES	A6704233811	1505901
MERCEDES	A6704234211	1505901
MERCEDES	A6704234711	1735103
MERCEDES	A6704234811	1735104
MERCEDES	A6704235111	1735103
MERCEDES	A6704235211	1735104
MERCEDES	A6704235911	1735003
MERCEDES	A6704236011	1735003
MERCEDES	A6704236411	1735104
MERCEDES	A6704236611	1735104
MERCEDES	A6704237111	1735103
MERCEDES	A6704237611	1735104
MERCEDES	A6704238210	1735103
MERCEDES	A6704238310	1735104
MERCEDES	A6704239010	1735003
MERCEDES	A6704239110	1735004
MERCEDES	A6704239810	1505901
MERCEDES	A6705400017	98016900
MERCEDES	A6734210331	1728705
MERCEDES	A6734210431	1728706

MARQUE	REF OES	REFERENCE
MERCEDES	A6734210731	1728006
MERCEDES	A6734210831	1728007
MERCEDES	A6734211131	1727806
MERCEDES	A6734211231	1727807
MERCEDES	A6734211531	1516203
MERCEDES	A6734211931	1516203
MERCEDES	A6734212331	1727806
MERCEDES	A6734212431	1727807
MERCEDES	A6734212731	1728006
MERCEDES	A6734212831	1728007
MERCEDES	A6734213131	1728705
MERCEDES	A6734213231	1728706
MERCEDES	A6734213531	1727807
MERCEDES	A6734213531	1728006
MERCEDES	A6734214410	1516203
MERCEDES	A6734214430	1728006
MERCEDES	A6734215810	1728705
MERCEDES	A6734215830	1516203
MERCEDES	A6734215910	1728706
MERCEDES	A6734216210	1728006
MERCEDES	A6734216230	1728006
MERCEDES	A6734216310	1728007
MERCEDES	A6734216330	1728007
MERCEDES	A6734216610	1727806
MERCEDES	A6734216710	1727807
MERCEDES	A6734217010	1516203
MERCEDES	A6734217610	1728705
MERCEDES	A6734217710	1728706
MERCEDES	A6734218010	1728006
MERCEDES	A6734218110	1728007
MERCEDES	A6734218130	1728705
MERCEDES	A6734218410	1727806
MERCEDES	A6734218510	1727807
MERCEDES	A6734218530	1728006
MERCEDES	A6734218810	1516203
MERCEDES	A6734218830	1727807
MERCEDES	A6734219430	1728705
MERCEDES	A6734219530	1728706
MERCEDES	A6734219810	1727806
MERCEDES	A6734219830	1727806
MERCEDES	A6734219930	1727807
MERCEDES	A6744211230	1728705
MERCEDES	A6744211330	1728706
MERCEDES	A6744211630	1728006
MERCEDES	A6744211730	1728007
MERCEDES	A6744212030	1727806
MERCEDES	A6744212130	1727807
MERCEDES	A6744212430	1516203
MERCEDES	A6744212830	1728705

Les correspondances de références ont pour seul objectif d'aider la recherche de référence

Cross references are there for the sole purpose of helping the reference search

CORRESPONDANCE DES REFERENCES CROSS REFERENCE LIST

MARQUE	REF OES	REFERENCE
MERCEDES	A6744212930	1728706
MERCEDES	A6744213230	1728006
MERCEDES	A6744213330	1728007
MERCEDES	A6744213630	1727806
MERCEDES	A6744213730	1727807
MERCEDES	A6744214030	1516203
MERCEDES	A6744214430	1728705
MERCEDES	A6744214530	1728706
MERCEDES	A6744214830	1728006
MERCEDES	A6744214930	1728007
MERCEDES	A6744215230	1727806
MERCEDES	A6744215330	1727807
MERCEDES	A6744215630	1516203
MERCEDES	A6744219810	1727806
MERCEDES	A6744219910	1727807
MERCEDES	A6754210830	1950607
MERCEDES	A6754210930	1950608
MERCEDES	A6754211730	1729006
MERCEDES	A6754211830	1729007
MERCEDES	A6754212130	1950607
MERCEDES	A6754212230	1950608
MERCEDES	A6754212530	1950607
MERCEDES	A6754212630	1950608
MERCEDES	A6754212930	1950505
MERCEDES	A6754213030	1950506
MERCEDES	A6754213330	1950505
MERCEDES	A6754213430	1950506
MERCEDES	A6754213730	1729006
MERCEDES	A6754213810	1729006
MERCEDES	A6754213830	1729007
MERCEDES	A6754214010	1729007
MERCEDES	A6754214130	1950607
MERCEDES	A6754214230	1950608
MERCEDES	A6754214510	1950607
MERCEDES	A6754214530	1950505
MERCEDES	A6754214610	1950607
MERCEDES	A6754214630	1950506
MERCEDES	A6754214710	1950608
MERCEDES	A6754214810	1950608
MERCEDES	A6754216210	1729006
MERCEDES	A6754216410	1729007
MERCEDES	A6754216810	1950607
MERCEDES	A6754216910	1950607
MERCEDES	A6754217010	1950607
MERCEDES	A6754217110	1950608
MERCEDES	A6754217210	1950608
MERCEDES	A6754218010	1950505
MERCEDES	A6754218110	1950505
MERCEDES	A6754218210	1950506

MARQUE	REF OES	REFERENCE
MERCEDES	A6754218310	1950506
MERCEDES	A6754218810	1950505
MERCEDES	A6754218910	1950505
MERCEDES	A6754219010	1950506
MERCEDES	A6754219110	1950506
MERCEDES	A6754219610	1950505
MERCEDES	A6754219710	1950506
MERCEDES	A6764210010	1729006
MERCEDES	A6764210110	1729007
MERCEDES	A6764210410	1950607
MERCEDES	A6764210510	1950608
MERCEDES	A6764210810	1950505
MERCEDES	A6764210910	1950506
MERCEDES	A6764211210	1729006
MERCEDES	A6764211310	1729007
MERCEDES	A6764211610	1950607
MERCEDES	A6764211710	1950608
MERCEDES	A6764212010	1950505
MERCEDES	A6764212110	1950506
MERCEDES	A6764212410	1729006
MERCEDES	A6764212510	1729007
MERCEDES	A6764212810	1950607
MERCEDES	A6764212910	1950608
MERCEDES	A6764213210	1950505
MERCEDES	A6764213310	1950506
MERCEDES	A6764214510	1729007
MERCEDES	A6775400717	98017002
MERCEDES	A6775400817	98017102
MERITOR	68371277NQT	1970803
MERITOR	68371534NQU	1907102
MERITOR	68371536NQU	1906802
MERITOR	MBSK1000-4	1903770
MERITOR	MBSK1010-4	1936970
MERITOR	MBSK1040-4	1903070
MERITOR	MBSK2000-4	1903271
MERITOR	MBSK2010-4	1909470
MERITOR	MBSK2490-4	1961370
MERITOR	MBSK2500-4	1955770
MERITOR	RBSK1212	1938414
MERITOR	RBSK1213	1938415
MERITOR	RBSK1226	1938414
MERITOR	RBSK1227	1938415
MERITOR	RD15705219	FCD003
MERITOR	RD15705220	FCD004
MERITOR	RD41018235	FCD005
MERITOR	RD41018236	FCD006
MERITOR	RD41020243	FCD009
MERITOR	RD41020244	FCD010
MERITOR	RD41020335	FCD011

Les correspondances de références ont pour seul objectif d'aider la recherche de référence

Cross references are there for the sole purpose of helping the reference search

CORRESPONDANCE DES REFERENCES CROSS REFERENCE LIST

MARQUE	REF OES	REFERENCE
MERITOR	RD41020336	FCD012
MERITOR	RS15705223	FCS001
MERITOR	RS15705224	FCS002
MERITOR	RS15705232	FCS100
MERITOR	RS36017239	FCS003
MERITOR	RS36017240	FCS004
MERITOR	RS41018205	FCS005
MERITOR	RS41018206	FCS006
MERITOR	RS41020307	FCS009
MERITOR	RS41020308	FCS010
NISSAN	069029000	MF0353
NISSAN	069053200	MF0353
NISSAN	44000F3803	MF0353
NISSAN	441009X125	CR0618
NISSAN	44100D6200	CR1004
NISSAN	6464706	CR0618
NISSAN	69012170	CR1004
NISSAN	69021740	CR1021
NISSAN	69022780	CR1021
NISSAN	69030110	CR1021
NISSAN	69030120	CR1022
NISSAN	69041420	CR1022
NISSAN	YC152261AA	CR0618
PERROT	12739075VT	ECF001
PERROT	12739076VT	ECF002
PERROT	12739085VT	ECF003
PERROT	12739086VT	ECF004
PERROT	14352031	ECF002
RABA	318393341014	1923601
RABA	318933341013	1923502
RENAULT	7701201617	MF0353
RENAULT TRUCKS	189923	TF6801
RENAULT TRUCKS	189923	TF6801
RENAULT TRUCKS	5000001165	CRB143
RENAULT TRUCKS	5000001166	CRB144
RENAULT TRUCKS	5000001169	CRB147
RENAULT TRUCKS	5000242586	CR0549
RENAULT TRUCKS	5000242587	CR0550
RENAULT TRUCKS	5000243040	CR0539
RENAULT TRUCKS	5000243144	CR0546
RENAULT TRUCKS	5000288508	1993502
RENAULT TRUCKS	5000288509	1993510
RENAULT TRUCKS	5000288510	1946301
RENAULT TRUCKS	5000288512	1993402
RENAULT TRUCKS	5000288512	1993410
RENAULT TRUCKS	5000288514	1904902
RENAULT TRUCKS	5000288515	1904911
RENAULT TRUCKS	5000288520	1783102
RENAULT TRUCKS	5000288522	1783102

MARQUE	REF OES	REFERENCE
RENAULT TRUCKS	5000288524	1925501
RENAULT TRUCKS	5000288525	1925502
RENAULT TRUCKS	5000295945	1962005
RENAULT TRUCKS	5000393657	CR0827
RENAULT TRUCKS	5000516025	CR0690
RENAULT TRUCKS	5000559091	1782704
RENAULT TRUCKS	5000559107	CR0928
RENAULT TRUCKS	5000559108	CR0929
RENAULT TRUCKS	5000559150	CR0932
RENAULT TRUCKS	5000559151	CR0933
RENAULT TRUCKS	5000559160	1962004
RENAULT TRUCKS	5000559160	1782704
RENAULT TRUCKS	5000559194	CR0936
RENAULT TRUCKS	5000559197	CR0937
RENAULT TRUCKS	5000559441	1904902
RENAULT TRUCKS	5000560943	1782705
RENAULT TRUCKS	5000560980	CR0940
RENAULT TRUCKS	5000560981	CR0941
RENAULT TRUCKS	5000560984	1783102
RENAULT TRUCKS	5000671980	BE0001
RENAULT TRUCKS	5000716600	AC0019
RENAULT TRUCKS	5000716656	AC0018
RENAULT TRUCKS	5000737459	TF6801
RENAULT TRUCKS	5000792794	MAC9934
RENAULT TRUCKS	5000792795	MAC9935
RENAULT TRUCKS	5000793121	1946301
RENAULT TRUCKS	5000809636	1904911
RENAULT TRUCKS	5000811113	1993502
RENAULT TRUCKS	5000811877	1904902
RENAULT TRUCKS	5000811878	1946301
RENAULT TRUCKS	5000811881	1904911
RENAULT TRUCKS	5000812335	1993402
RENAULT TRUCKS	5000812335	1993410
RENAULT TRUCKS	5000814699	CR0891
RENAULT TRUCKS	5000814854	1904902
RENAULT TRUCKS	5000814855	1904902
RENAULT TRUCKS	5000814856	1904911
RENAULT TRUCKS	5000814857	1904911
RENAULT TRUCKS	5000814858	1946301
RENAULT TRUCKS	5000814860	1904902
RENAULT TRUCKS	5000814861	1904911
RENAULT TRUCKS	5000815055	1783102
RENAULT TRUCKS	5000815370	CR0918
RENAULT TRUCKS	5000815484	AB337276
RENAULT TRUCKS	5000815489	KRES006
RENAULT TRUCKS	5000815514	CR0896
RENAULT TRUCKS	5000815603	CR0925
RENAULT TRUCKS	5000815604	CR0926
RENAULT TRUCKS	5000815640	1925501

Les correspondances de références ont pour seul objectif d'aider la recherche de référence

Cross references are there for the sole purpose of helping the reference search

CORRESPONDANCE DES REFERENCES CROSS REFERENCE LIST

MARQUE	REF OES	REFERENCE
RENAULT TRUCKS	5000816057	1904911
RENAULT TRUCKS	5000816058	1904902
RENAULT TRUCKS	5000816602	CR0934
RENAULT TRUCKS	5000816603	CR0935
RENAULT TRUCKS	5000816604	CR0930
RENAULT TRUCKS	5000816605	CR0931
RENAULT TRUCKS	5000819160	1782704
RENAULT TRUCKS	5000819161	1962004
RENAULT TRUCKS	5000819161	1782704
RENAULT TRUCKS	5000819162	1782705
RENAULT TRUCKS	5000820588	AB337220
RENAULT TRUCKS	5000821135	1904902
RENAULT TRUCKS	5000821136	1946301
RENAULT TRUCKS	5000821730	1904902
RENAULT TRUCKS	5000821731	1904911
RENAULT TRUCKS	5000821732	1946301
RENAULT TRUCKS	5000821815	1993402
RENAULT TRUCKS	5000821817	1993502
RENAULT TRUCKS	5000821818	1918704
RENAULT TRUCKS	5000821818	1993510
RENAULT TRUCKS	5000822061	1993402
RENAULT TRUCKS	5000822064	1993510
RENAULT TRUCKS	5000822595	1783102
RENAULT TRUCKS	5000822597	1782704
RENAULT TRUCKS	5000822597	1782704
RENAULT TRUCKS	5000822598	1782705
RENAULT TRUCKS	5000822599	1782704
RENAULT TRUCKS	5000822599	1962004
RENAULT TRUCKS	5000822604	1925502
RENAULT TRUCKS	5000822605	1962005
RENAULT TRUCKS	5000824295	1904902
RENAULT TRUCKS	5000824296	1904911
RENAULT TRUCKS	5000824297	1946301
RENAULT TRUCKS	5000825257	1993402
RENAULT TRUCKS	5000825618	1946301
RENAULT TRUCKS	5000916058	1904902
RENAULT TRUCKS	5000987156	CR0837
RENAULT TRUCKS	5000987157	CR0838
RENAULT TRUCKS	5000987158	CR0835
RENAULT TRUCKS	5000987159	CR0836
RENAULT TRUCKS	5001019221	1993502
RENAULT TRUCKS	5001019222	1918702
RENAULT TRUCKS	5001823154	AB350929
RENAULT TRUCKS	5001823158	AB350891
RENAULT TRUCKS	5001823215	1783102
RENAULT TRUCKS	5001823240	1918702
RENAULT TRUCKS	5001823241	1918704
RENAULT TRUCKS	5001823263	KRES005
RENAULT TRUCKS	5001825100	1993502

MARQUE	REF OES	REFERENCE
RENAULT TRUCKS	5001825620	1904902
RENAULT TRUCKS	5001825621	1904911
RENAULT TRUCKS	5001825627	1925501
RENAULT TRUCKS	5001825629	1925502
RENAULT TRUCKS	5001829350	MF0601
RENAULT TRUCKS	5001829558	1993510
RENAULT TRUCKS	5001832024	19502xx
RENAULT TRUCKS	5001839079	FCS100
RENAULT TRUCKS	5001855104	1993410
RENAULT TRUCKS	5001855104	1993402
RENAULT TRUCKS	5001855105	1993410
RENAULT TRUCKS	5001855106	1993502
RENAULT TRUCKS	5001855122	1918702
RENAULT TRUCKS	5001855122	1993502
RENAULT TRUCKS	5001855123	1918704
RENAULT TRUCKS	5001855146	1918702
RENAULT TRUCKS	5001855147	1918704
RENAULT TRUCKS	5001859264	1782704
RENAULT TRUCKS	5001859266	1783102
RENAULT TRUCKS	5001859270	1782704
RENAULT TRUCKS	5001859271	1782705
RENAULT TRUCKS	5001859272	1962004
RENAULT TRUCKS	5001859273	1962005
RENAULT TRUCKS	5001859274	1946301
RENAULT TRUCKS	5001860030	1993402
RENAULT TRUCKS	5001860031	1993410
RENAULT TRUCKS	5001860032	1993502
RENAULT TRUCKS	5001860033	1993510
RENAULT TRUCKS	5001860048	1918702
RENAULT TRUCKS	5001860049	1918704
RENAULT TRUCKS	5001865097	CR0930
RENAULT TRUCKS	5001865098	CR0931
RENAULT TRUCKS	5001865103	CR0549
RENAULT TRUCKS	5001865104	CR0550
RENAULT TRUCKS	5001865106	CR0896
RENAULT TRUCKS	5001865109	CR0918
RENAULT TRUCKS	5001865111	CR0827
RENAULT TRUCKS	5001865113	CR0539
RENAULT TRUCKS	5001865114	CR0546
RENAULT TRUCKS	5001865118	CR0891
RENAULT TRUCKS	5001865119	CR0690
RENAULT TRUCKS	5001865120	CRB190
RENAULT TRUCKS	5001865123	CR0367
RENAULT TRUCKS	5001865124	CRB157
RENAULT TRUCKS	5001866959	CR0925
RENAULT TRUCKS	5001866960	CR0926
RENAULT TRUCKS	5001866961	CR0934
RENAULT TRUCKS	5001866962	CR0935
RENAULT TRUCKS	5001867100	MF0601

Les correspondances de références ont pour seul objectif d'aider la recherche de référence

Cross references are there for the sole purpose of helping the reference search

CORRESPONDANCE DES REFERENCES CROSS REFERENCE LIST

MARQUE	REF OES	REFERENCE
RENAULT TRUCKS	5001868087	1909002
RENAULT TRUCKS	5001868088	1909005
RENAULT TRUCKS	5001868089	1907102
RENAULT TRUCKS	5001868090	1907105
RENAULT TRUCKS	5001868091	1906802
RENAULT TRUCKS	5001868092	1906805
RENAULT TRUCKS	5001868113	AC0013
RENAULT TRUCKS	5001868114	AC0016
RENAULT TRUCKS	5001868117	AC0006
RENAULT TRUCKS	5001868118	AC0005
RENAULT TRUCKS	5001868119	AC0014
RENAULT TRUCKS	5001868120	AC0007
RENAULT TRUCKS	5001868121	AC0001
RENAULT TRUCKS	5001868122	AC0012
RENAULT TRUCKS	5001868125	AC0010
RENAULT TRUCKS	5001868126	AC0011
RENAULT TRUCKS	5001868127	AC0009
RENAULT TRUCKS	5001868128	AC0015
RENAULT TRUCKS	5001868569	MAC9090/2
RENAULT TRUCKS	5001868572	MAC9071/2
RENAULT TRUCKS	5001868573	MAC9068/2
RENAULT TRUCKS	5010046458	CR0835
RENAULT TRUCKS	5010046459	CR0836
RENAULT TRUCKS	5010046460	CR0837
RENAULT TRUCKS	5010046461	CR0838
RENAULT TRUCKS	5010067400	AC0020
RENAULT TRUCKS	5010067400	APF001
RENAULT TRUCKS	5010067564	APF001/2
RENAULT TRUCKS	5010067942	CAM003
RENAULT TRUCKS	5010067943	CAM004
RENAULT TRUCKS	5010097260	MAC9935K
RENAULT TRUCKS	5010097262	AXE002
RENAULT TRUCKS	5010098946	AXE001
RENAULT TRUCKS	5010098948	MAC9187
RENAULT TRUCKS	5010098949	TF6802
RENAULT TRUCKS	5010136148	TF6801
RENAULT TRUCKS	5010216613	APF001/3
RENAULT TRUCKS	5010224053	MAC9934K
RENAULT TRUCKS	5010224629	MAC9974
RENAULT TRUCKS	5010422362	AC0021
RENAULT TRUCKS	5010525775	MAC9187K
RENAULT TRUCKS	5010525805	TF6805
RENAULT TRUCKS	5010566199	BE0001
RENAULT TRUCKS	7400276097	AC0003
RENAULT TRUCKS	7400276098	AC0004
RENAULT TRUCKS	7403090964	AC0002
RENAULT TRUCKS	7420851343	CR0836
RENAULT TRUCKS	7420851344	CR0837
RENAULT TRUCKS	7421534374	1909002

MARQUE	REF OES	REFERENCE
RENAULT TRUCKS	7421534386	1907102
RENAULT TRUCKS	7421534392	1906802
RENAULT TRUCKS	7421534397	1909005
RENAULT TRUCKS	7485013109	1906880
RENAULT TRUCKS	7485013110	1907180
RENAULT TRUCKS	7701001747	CR0310
RENAULT TRUCKS	7701010167	1904902
RENAULT TRUCKS	7701010168	1904911
RENAULT TRUCKS	7701010593	1904902
RENAULT TRUCKS	7701010594	1904911
RENAULT TRUCKS	7701365115	CRB157
RENAULT TRUCKS	7703002134	AC0008
RENAULT TRUCKS	7703067135	APF001/1
RENAULT TRUCKS	770507400	CR0367
RENAULT TRUCKS	770507500	CR0366
RENAULT TRUCKS	870090900	CR0366
RENAULT TRUCKS	870441200	CR0342
RENAULT TRUCKS	870441300	CR0351
RENAULT TRUCKS	870507400	CR0367
RENAULT TRUCKS	870618400	CRB190
RENAULT TRUCKS	870618400	CRB190
ROR	15205192E	1936908
ROR	15205192R	1936970
ROR	15205536R	1903770
ROR	15206004E	1960408
ROR	15206004R	1960470
ROR	15224952R	1903070
ROR	21010776	1960408
ROR	21200780B	1960408
ROR	21200781B	1960408
ROR	21200790B	1903712
ROR	21200791B	1903712
ROR	21200794B	1936908
ROR	21200795B	1936908
ROR	21209710B	1990803
ROR	21209710E	1990803
ROR	21209711B	1990803
ROR	21209711E	1990803
ROR	21224717R	1903001
ROR	21224718R	1903001
ROR	60207753R	1936908
ROR	60207755R	1960408
ROR	60207757R	1903001
SAF	1057001200	1903230
SAF	1057001210	1903231
SAF	1057002400	1951512
SAF	1057002410	1951513
SAF	1057002500	1951512
SAF	1057002510	1951513

Les correspondances de références ont pour seul objectif d'aider la recherche de référence

Cross references are there for the sole purpose of helping the reference search

CORRESPONDANCE DES REFERENCES CROSS REFERENCE LIST

MARQUE	REF OES	REFERENCE
SAF	1057003300	1951701
SAF	1057003400	1951701
SAF	1057004300	1989208
SAF	1057004400	1989208
SAF	1057004410	1989202
SAF	1057004800	1991201
SAF	1057004900	1991201
SAF	1057006000	1928304
SAF	1057006010	1928306
SAF	1057006100	1928304
SAF	1057006110	1928306
SAF	1057006600	1947706
SAF	1057006610	1947707
SAF	1057006700	1947706
SAF	1057006710	1947707
SAF	1057006800	1947905
SAF	1057006900	1947905
SAF	1057007000	1949005
SAF	1057007100	1949005
SAF	1057241310	1909439
SAF	1057242400	1951513
SAF	1057242409	1951513
SAF	1057242500	1951512
SAF	1057242510	1951513
SAF	1057242511	1951513
SAF	1057243400	1951701
SAF	1057244300	1989208
SAF	1057244400	1989208
SAF	10572843005	1989208
SAF	10572844005	1989208
SAF	1057301000	1737707
SAF	1057301200	1903230
SAF	1057301210	1903231
SAF	1057301300	1909437
SAF	1057301310	1909439
SAF	1057304400	1989208
SAF	1057304410	1989202
SAF	1057306000	1928304
SAF	1057306010	1928306
SAF	1057306100	1928304
SAF	1057306110	1928306
SAF	1057312400	1951512
SAF	1057312410	1951513
SAF	1057312500	1951512
SAF	1057312510	1951513
SAF	1057313300	1951701
SAF	1057313400	1951701
SAF	1057313500	1951701
SAF	1057314300	1989208

MARQUE	REF OES	REFERENCE
SAF	1057314310	1989202
SAF	1057991210	1903231
SAF	1057996000	1928304
SAF	1057996010	1928306
SAF	1057996100	1928304
SAF	1057996110	1928306
SAF	1057996600	1947706
SAF	1057996610	1947707
SAF	1057996700	1947706
SAF	1057996710	1947707
SAF	1057996800	1947905
SAF	1057996900	1947905
SAF	3057001300	1909437
SAF	3057001310	1909439
SAF	3057306000	1928304
SAF	3057306010	1928306
SAF	3057306600	1947706
SAF	3057311200	1903230
SAF	3057311210	1903231
SAF	3057312400	1951512
SAF	3057312410	1951513
SAF	3057313300	1951701
SAF	3057314300	1989208
SAF	3057314300	1989202
SAF	3057314310	1989202
SAF	3057317000	1949005
SAF	3057396600	1947706
SAF	3057396800	1947905
SCANIA	1104544	MAC9932
SCANIA	1104545	MAC9933
SCANIA	1104545	MAC9933
SCANIA	11045452	MAC9932
SCANIA	1104548	MAC9932
SCANIA	1104549	MAC9933
SCANIA	1104553	MAC9933
SCANIA	1109002	1993101
SCANIA	1109003	1993201
SCANIA	1116693	MAC9932
SCANIA	1116694	MAC9933
SCANIA	1123136	MAC9932
SCANIA	1123137	MAC9933
SCANIA	1301487	MAC9933
SCANIA	1301913	MAC9933
SCANIA	1304933	1939302
SCANIA	1516501	1993201
SCANIA	1535247	1799101
SCANIA	1535248	1993101
SCANIA	1535249	1993201
SCANIA	1535250	1993301

Les correspondances de références ont pour seul objectif d'aider la recherche de référence

Cross references are there for the sole purpose of helping the reference search

CORRESPONDANCE DES REFERENCES CROSS REFERENCE LIST

MARQUE	REF OES	REFERENCE
SCANIA	1535252	1993108
SCANIA	1535253	1993201
SCANIA	1535254	1993301
SCANIA	181814	1939302
SCANIA	245875	MAC9933
SCANIA	246096	MAC9933
SCANIA	276421	MAC9933
SCANIA	322818	MAC9933
SCANIA	355768	MAC9933
SCANIA	374355	MAC9933
SCANIA	374358	MAC9933
SCANIA	385948	1993101
SCANIA	385948	1993101
SCANIA	385949	1993201
SCANIA	385950	1993301
SCANIA	390544	MAC9933
SCANIA	397051	1799101
SCANIA	397052	1993101
SCANIA	551010	1716101
SCANIA	551029	1939302
SCANIA	551039	1939302
SCANIA	551048	1964702
SCANIA	551053	1939302
SCANIA	551057	1716101
SCANIA	551059	1939302
SCANIA	551122	1799101
SCANIA	551123	1993101
SCANIA	551124	1993201
SCANIA	551125	1993301
SCANIA	551127	1993102
SCANIA	551128	1993202
SCANIA	551131	1939302
SCANIA	551132	1964702
SCANIA	551136	1799101
SCANIA	551137	1993101
SCANIA	551138	1993201
SCANIA	551139	1993301
SCANIA	551143	1993202
SCANIA	551160	1799101
SCANIA	551161	1993101
SCANIA	551162	1939302
SCANIA	551162	1993201
SCANIA	551163	1993301
SCANIA	551165	1993102
SCANIA	551166	1993202
SCANIA	551167	1993307
SCANIA	551168	1716101
SCANIA	551170	1939302
SCANIA	551171	1964702

MARQUE	REF OES	REFERENCE
SCANIA	551174	1939302
SCANIA	551179	1993101
SCANIA	551180	1993301
SCANIA	551184	1964702
SCANIA	551187	1716101
SCANIA	551188	1939302
SCANIA	551191	1799101
SCANIA	551192	1993201
SCANIA	552110	1799101
SCANIA	552112	1993101
SCANIA	552114	1993201
SCANIA	552115	1993202
SCANIA	552116	1993301
SCANIA	552118	1716101
SCANIA	552122	1939302
SCANIA	552124	1964702
SCANIA	751011	1939302
SCANIA	751012	1939302
SCANIA	751039	1939302
SISU	5463603213	19144xx
SISU	5463616413	19144xx
SISU	5463616513	19144xx
SMB	AJB0907001	1971802
SMB	M006174	1961313
SMB	M007282	1986201
SMB	M007282	1960870
SMB	M009287	1961313
SMB	M010560	1955713
SMB	M010587	1986201
SMB	M016771	1986202
SMB	M018367	1986202
SMB	M02815	1955713
SMB	M051348	1971802
SMB	M051356	1971802
SMB	M064512	1971802
SMB	M100527	1955713
SMB	M91003501	1955770
SMB	M91003503	1961313
SMB	M91003503	1961370
STEYR	59000340006	1740805
STEYR	59000440007	1740806
STEYR	59000440008	1740805
STEYR	59000440707	1740805
TRAILOR	6505111C	1903616
VOLVO	1517824	CR0932
VOLVO	1517825	CR0933
VOLVO	1517834	CR0936
VOLVO	1517835	CR0937
VOLVO	1517941	CR0928

Les correspondances de références ont pour seul objectif d'aider la recherche de référence

Cross references are there for the sole purpose of helping the reference search

CORRESPONDANCE DES REFERENCES CROSS REFERENCE LIST

MARQUE	REF OES	REFERENCE
VOLVO	1517942	CR0929
VOLVO	1517952	CR0940
VOLVO	1517953	CR0941
VOLVO	1697687	CR0928
VOLVO	1697688	CR0929
VOLVO	1697689	CR0932
VOLVO	1697690	CR0933
VOLVO	1697691	CR0940
VOLVO	1697692	CR0941
VOLVO	1697693	CR0936
VOLVO	1697694	CR0937
VOLVO	270384	1909002
VOLVO	270524	1799201
VOLVO	2705366	1766402
VOLVO	2705382	1956002
VOLVO	2705408	1946703
VOLVO	2705424	1956202
VOLVO	2705440	1979901
VOLVO	2705457	1979902
VOLVO	270546	1988501
VOLVO	270547	1988501
VOLVO	270830	1799201
VOLVO	2708303	1799201
VOLVO	2708311	1799202
VOLVO	270832	1994102
VOLVO	2708329	1994102
VOLVO	270838	1906802
VOLVO	2708386	1906802
VOLVO	2709368	1799201
VOLVO	2709376	1799202
VOLVO	2709382	1994102
VOLVO	2709384	1994102
VOLVO	2709426	1907102
VOLVO	2709442	1906802
VOLVO	2709442	1906802
VOLVO	270972	1994102
VOLVO	2709723	1994102
VOLVO	270978	1906802
VOLVO	2711026	1938414
VOLVO	2711034	1938415
VOLVO	2711380	1988501
VOLVO	2712495	1938414
VOLVO	2712503	1938415
VOLVO	272515	1766402
VOLVO	2725150	1766402
VOLVO	2725158	1766402
VOLVO	272516	1946703
VOLVO	2725166	1946703
VOLVO	272522	1956002

MARQUE	REF OES	REFERENCE
VOLVO	2725224	1956002
VOLVO	272523	1956202
VOLVO	2725232	1956202
VOLVO	2725281	1956002
VOLVO	2725299	1956202
VOLVO	2725455	1766402
VOLVO	272549	1956002
VOLVO	2725497	1956002
VOLVO	272614	1782704
VOLVO	2726149	1782704
VOLVO	272615	1782704
VOLVO	272621	1962004
VOLVO	2726214	1962004
VOLVO	272622	1962005
VOLVO	2726511	1783102
VOLVO	272652	1783102
VOLVO	2726933	1766402
VOLVO	272694	1956002
VOLVO	2726941	1956002
VOLVO	2727105	1979901
VOLVO	2727113	1979902
VOLVO	272724	1938414
VOLVO	2727246	1938414
VOLVO	272734	1946703
VOLVO	2727345	1946703
VOLVO	272736	1956202
VOLVO	2727360	1956202
VOLVO	2727444	1946703
VOLVO	2727460	1956202
VOLVO	2727469	1956202
VOLVO	2727485	1979901
VOLVO	2727493	1979902
VOLVO	272754	1956002
VOLVO	2727857	1766402
VOLVO	2727873	1946703
VOLVO	272806	1988501
VOLVO	2728061	1988501
VOLVO	2728491	1938415
VOLVO	2728863	1988501
VOLVO	2728889	1956002
VOLVO	272890	1946703
VOLVO	2728905	1946703
VOLVO	272892	1956202
VOLVO	2728921	1956202
VOLVO	2728947	1979901
VOLVO	2728954	1979902
VOLVO	272910	AC0001
VOLVO	275883	1946703
VOLVO	2759900	1799201

Les correspondances de références ont pour seul objectif d'aider la recherche de référence

Cross references are there for the sole purpose of helping the reference search

CORRESPONDANCE DES REFERENCES CROSS REFERENCE LIST

MARQUE	REF OES	REFERENCE
VOLVO	2759918	1799202
VOLVO	2759926	1994102
VOLVO	2759967	1907102
VOLVO	2759983	1906802
VOLVO	2760403	1766402
VOLVO	2760429	1956002
VOLVO	2760445	1946703
VOLVO	2760460	1956202
VOLVO	2760486	1979901
VOLVO	2760494	1979902
VOLVO	2760502	1988501
VOLVO	276097	AC0003
VOLVO	276098	AC0004
VOLVO	276100	AC0002
VOLVO	3090044	1954201
VOLVO	30900443	1954201
VOLVO	3090343	1799201
VOLVO	30903439	1799201
VOLVO	30903447	1799202
VOLVO	3090345	1994102
VOLVO	3090349	1907102
VOLVO	30903512	1906802
VOLVO	3090954	AC0014
VOLVO	3090964	AC0002
VOLVO	30912828	1979901
VOLVO	30912836	1979902
VOLVO	30912844	1988501
VOLVO	3091438	1975803
VOLVO	30914527	1799201
VOLVO	30914535	1799202
VOLVO	3091458	1907102
VOLVO	3091488	1735702
VOLVO	3091795	AC0015
VOLVO	3092693	1946703
VOLVO	3092694	1956202
VOLVO	3092695	1979901
VOLVO	3093260	1907105
VOLVO	3093262	1906805
VOLVO	3093264	1907105
VOLVO	3093266	1906805
VOLVO	3095163	1799201
VOLVO	3095164	1799202
VOLVO	3095165	1994102
VOLVO	3095170	1907105
VOLVO	3095172	1906805
VOLVO	3095173	1799201
VOLVO	3095174	1799201
VOLVO	3095175	1994102
VOLVO	3095176	1994102

MARQUE	REF OES	REFERENCE
VOLVO	3095177	1909002
VOLVO	3095178	1909002
VOLVO	3095180	1907105
VOLVO	3095182	1906805
VOLVO	3095187	1909005
VOLVO	3095193	MAC7992/2
VOLVO	30951935	MAC7992/2
VOLVO	3095194	MAC9941/2
VOLVO	3095195	MAC9090/2
VOLVO	3095196	MAC9071/2
VOLVO	3095197	MAC9068/2
VOLVO	3097092	AC0013
VOLVO	3097167	1946703
VOLVO	3097168	1956202
VOLVO	3097169	1979901
VOLVO	30971691	1979901
VOLVO	30971725	1979902
VOLVO	3097175	1766402
VOLVO	3097177	1956002
VOLVO	3097274	1799201
VOLVO	3097435	1975803
VOLVO	3098082	19975xx
VOLVO	3098264	1909002
VOLVO	3098264	1909005
VOLVO	3098267	1906805
VOLVO	85104191	MAC9090/2
VOLVO	85105382	1909002
VOLVO	85105382	1909005
VOLVO	85105383	1907105
VOLVO	8550977	AC0005
VOLVO	8550978	AC0006

Les correspondances de références ont pour seul objectif d'aider la recherche de référence
Cross references are there for the sole purpose of helping the reference search

**GIL Automotive remet à jour la documentation sur le site
GIL Automotive will update the documentation on the site**

www.GiL-Automotive.com

Avis de non-responsabilité

Les marques désignées sont des marques déposées par leurs propriétaires respectifs. GIL Automotive n'est en aucun cas liée, affiliée ou associée aux propriétaires de ces marques. Les produits de GIL Automotive présentés dans ce document ne sont ni recommandés ni autorisés par les propriétaires de ces marques.

Disclaimer

The designated trademarks are registered marks of their respective owners and GIL Automotive is not commercially connected, affiliated, or associated with any of the owners of such marks. The GIL Automotive products presented herein are not endorsed or authorized by any of the trademark owners.