

# Caterpillar® Haul Road Design and Management



Pete Holman

2006 Big Iron University

St. Charles, IL



# Overview

## Caterpillar® Haul Road Design and Management



# Introduction

---

The haul road is either the mine's greatest asset or greatest liability

- Investment in the haul road is money well spent
- Major influence on both cost and production













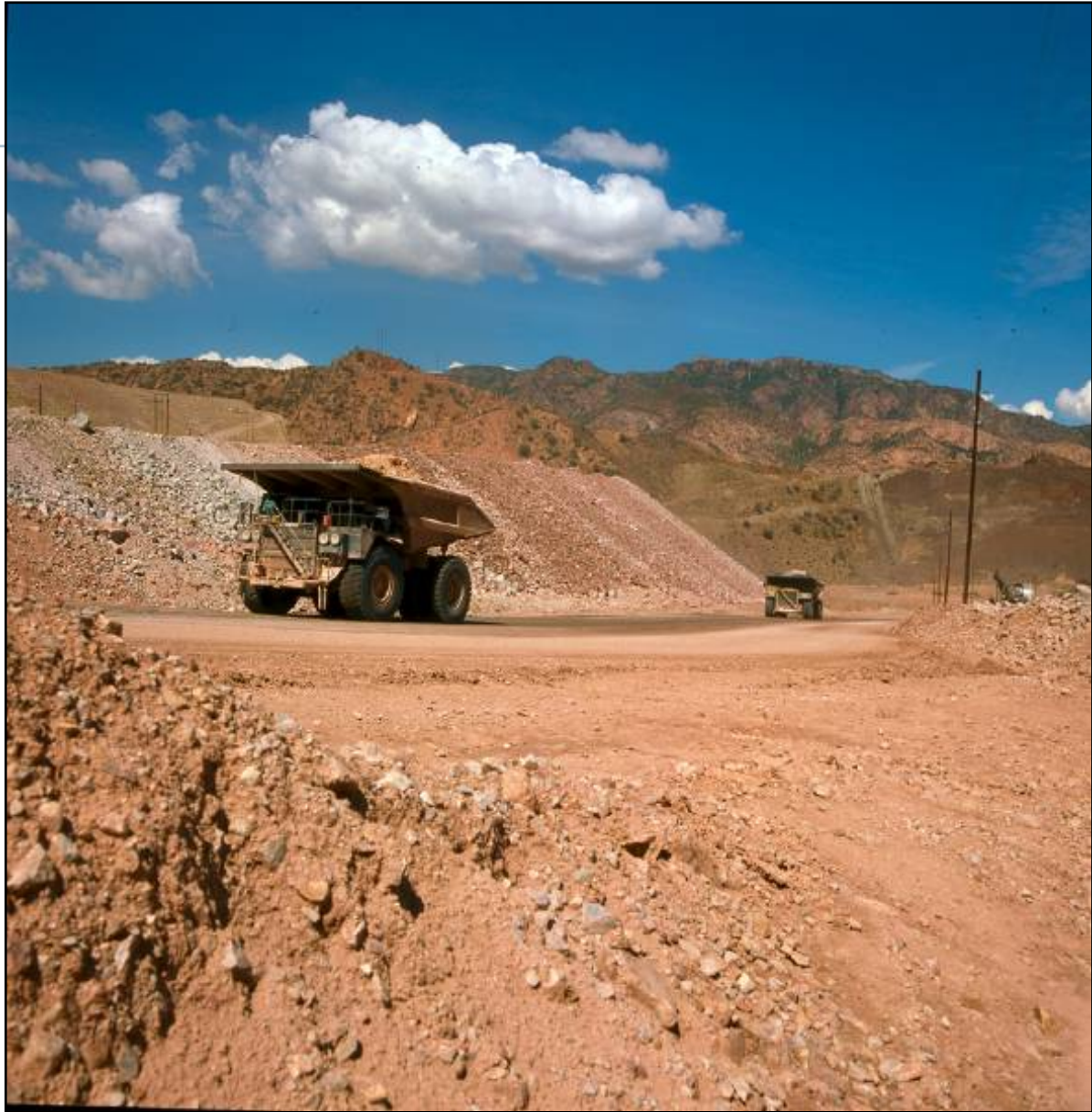

# Introduction

---

In both surface and underground mining, poorly designed and maintained haul roads can lead to dramatically increased costs

- Lost production
- Major equipment repair/replacement
- Tire longevity
- Fuel
- Safety





# Haul Road Planning and Alignment

Caterpillar® Haul Road Design and Management



# Haul Road Classifications

---

- Permanent
- Semi-permanent
- Temporary



# Mine Design Involves Determining Haul Road Parameters

---

- Grade
- Traffic layout
- Traffic patterns
- Curves/Superelevations
- Intersections
- Switchbacks





# Rules of Thumb

---

- If you can comfortably travel your haul roads at 60 km/h (35 mph) in a light vehicle, this is an indicator of good haul road conditions
- Haul roads begin at the loading face and end at the dump
  - Maintain good floor conditions at the dump
  - Maintain good floor conditions at the load area
- Travel at reasonable speeds in the dump zone



# Vehicle Stopping Distance

---

- Primary consideration in design
- Evaluate each vehicle in the fleet
  - Road alignment must adjust to the vehicle with the longest stopping distance
- Sight distance is a key element in determination
  - Must be sufficient to allow vehicle to safely stop before encountering obstructions or hazards



# Sight Distance for Horizontal and Vertical Curves

“The extent of peripheral area visible to the vehicle operator”

- Must be sufficient for a vehicle to stop before reaching a hazard or obstacle
- Distance from the operator’s eye must equal or exceed required stopping distances

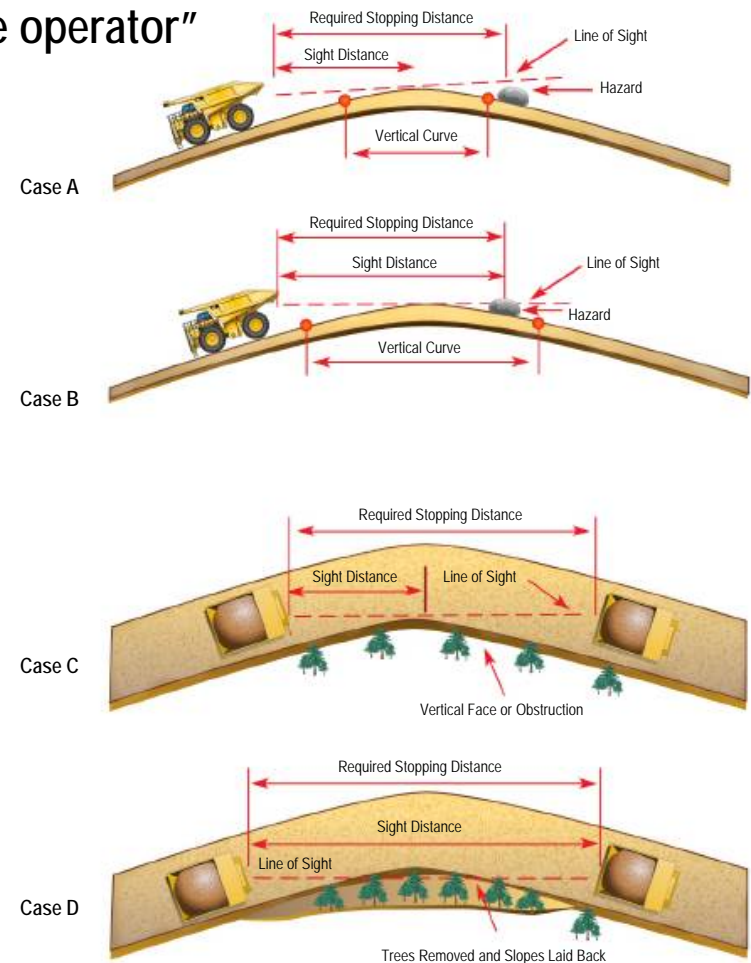



# Minimum Road Width

---

## Straight Road Segments

- Determined by vehicle size rather than type or gross weight
- May require additional width due to:
  - Use by larger equipment than primary users (shovels, draglines, etc)
  - Allow room for vehicles to pass on single lane roads
  - Allow sufficient space to avoid collision with stalled or slow moving vehicles if stopping distance is less than sight distance



# Minimum Road Width

## One-way straights and corners

- A minimum of 2 – 2.5 widths is recommended

## Two-way traffic

- In straights, a minimum of 3 – 3.5 truck widths
- In corners, a minimum of 3.5 – 4 truck widths

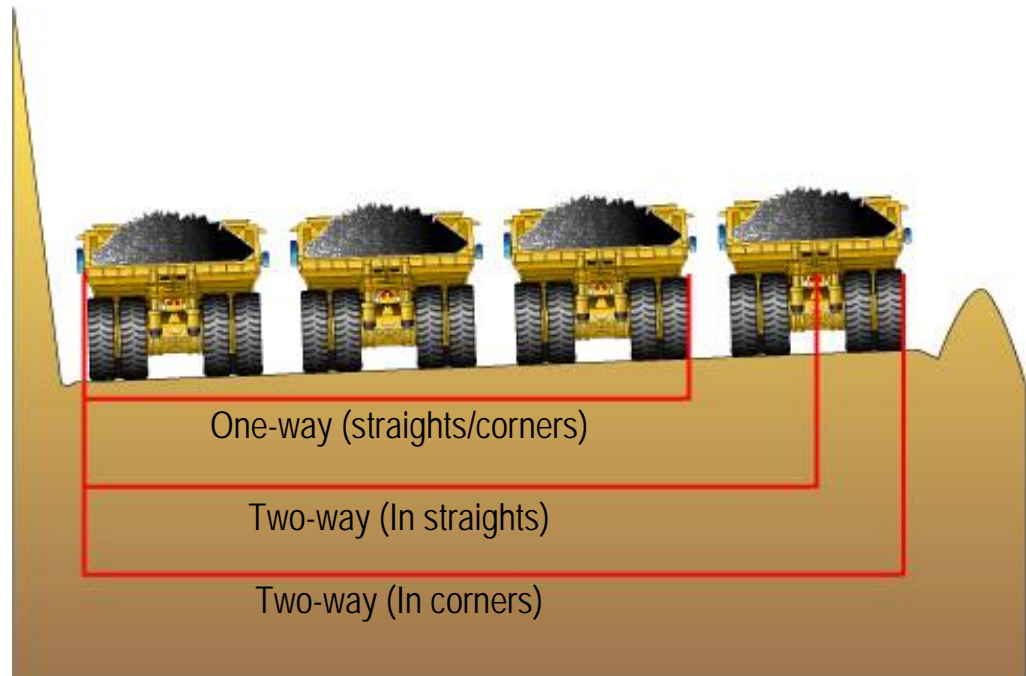

# Haul Road Width Examples

## Cat off-highway trucks

Model	Accessories	Overall Width Ft, In (m)	One Way (Straights / Corners)	Two Way (Straights)	Two Way (In Corners)
777D	Basic dual slope body	20' 0" (6.10)	40' 0" (12.20) min.	60' 0" (18.30) min.	70' 0" (21.35) min.
785C	Basic dual slope body	21' 4" (6.64)	42' 8" (13.28) min.	64' 2" (19.92) min.	74' 8" (23.24) min.
789C	Basic dual slope body	25' 2" (7.67)	50' 4" (15.34) min.	75' 6" (23.01) min.	88' 1" (26.85) min.
793C	Basic dual slope body	24' 4" (7.44)	48' 8" (14.88) min.	73' 2" (22.32) min.	85' 2" (26.04) min.
797B	Flat floor body	30' 0" (9.15)	60' 0" (18.30) min.	90' 0" (27.45) min.	105' 0" (32.03) min.





# Cross Fall

---

## On flats

- Maintain minimum slope for drainage
- Keep 2% constant cross fall (if possible), with loaded truck on the “uphill” side
- If constant cross fall is not possible, crown haul roads with minimum slope angle

## On grades

- Minimal cross fall is required unless rainfall is heavy

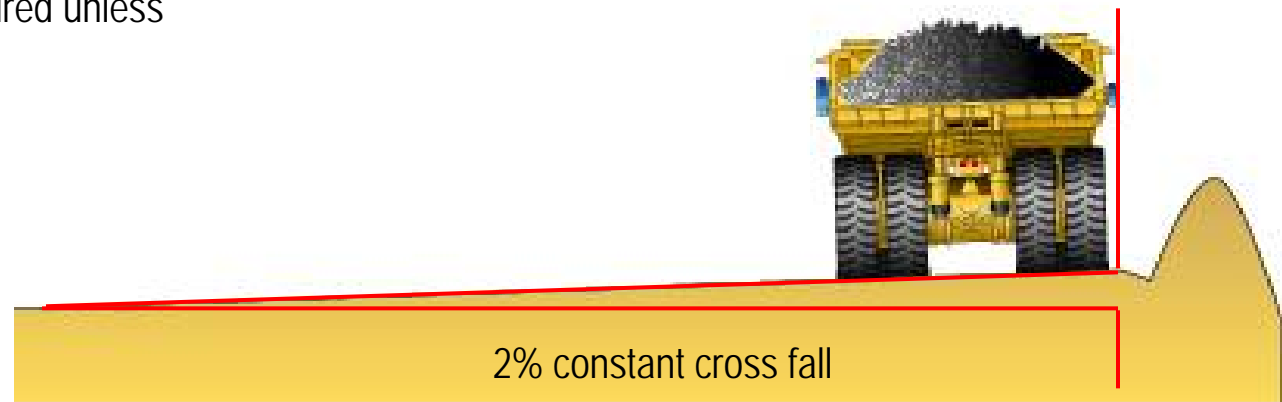

# Horizontal Alignment

---

Horizontal alignment concerns designing the elements necessary for safe operation around curves

- Proper width
- Superelevation
- Turning radius
- Sight distances



# Designing for Curves and Switchbacks

- Include truck performance as part of the equation
- Strive for consistent truck speed for optimal performance
- Recognize that poorly designed curves produce slower cycle times and higher overall costs
- Consider trucks moving both directions
  - Empty trucks travel faster





# Curves and Switchbacks

- Designing for curves and switchbacks:
- Use largest radius possible
  - Use maximum practical radius
  - Keep constant and smooth as possible
- Superelevation
  - Employ if speeds exceed 15 km/h (10 mph) as per Performance Handbook
  - Greater than 10% superelevation should be used with caution



TURN RADIUS		Speed	Speed	Speed	Speed	Speed	Speed	Speed	Speed
m	ft	16 km/h 10 mph	24 km/h 15 mph	32 km/h 20 mph	40 km/h 25 mph	48 km/h 30 mph	56 km/h 35 mph	64 km/h 40 mph	72 km/h 45 mph
15.2	50	13%	30%	—	—	—	—	—	—
30.5	100	7%	15%	27%	—	—	—	—	—
45.7	150	4%	10%	18%	28%	—	—	—	—
61.0	200	3%	8%	13%	21%	30%	—	—	—
91.5	300	2%	5%	9%	14%	20%	27%	—	—
152.4	500	1%	3%	5%	8%	12%	16%	21%	27%
213.4	700	1%	2%	4%	6%	9%	12%	15%	19%
304.9	1000	1%	2%	3%	4%	6%	8%	11%	14%



# Superelevation

---

- Similar to banking curves on a race track
- Counteracts centrifugal forces
- Allows higher travel speeds on curves
- Reduces stress on frame and tires
- Reduces chance of spillage
- Limited by higher loads on inside wheels, additional frame stresses, and potential sliding in slippery conditions



# Optimal Grade

## Smooth, constant grades

- Minimize transmission shifts
- Maintain higher average speed
- Allow more constant braking effort on returns
- Reduces spillage
- Reduces fuel consumption









# Choosing Optimal Grade

- Requires consideration of haul road geometry and truck performance on grade
- Factor of time and distance
- Basic indicator of optimal grade is cycle time
- Distance in a mine must consider both horizontal and vertical performance parameters

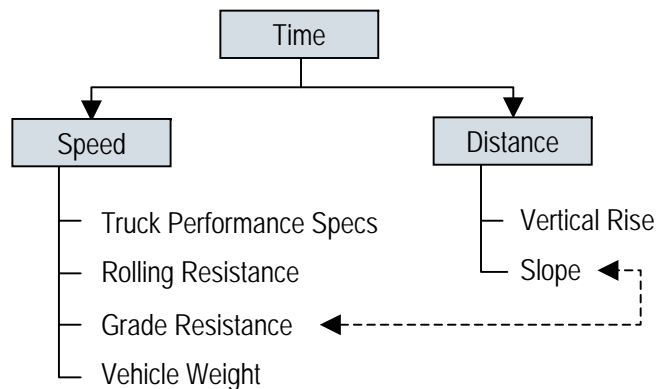

Grade Length vs. Slope

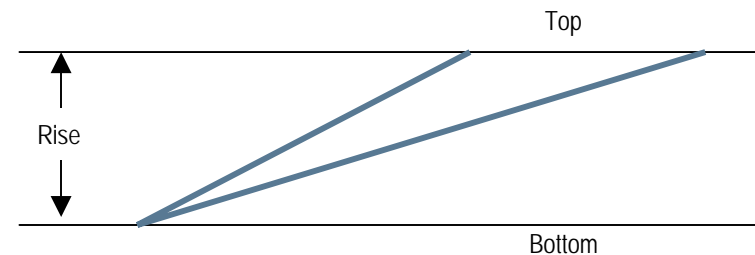

Grade Length vs. Slope  
(1,000 ft Lift)

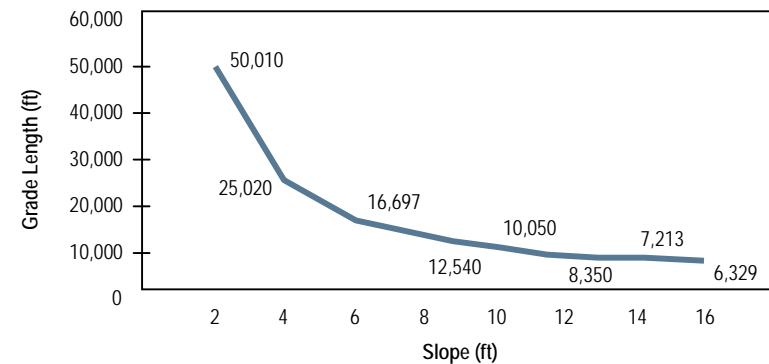

# Steady State Speed on Grade (mph)

793D

%		GMW (lb)			
Grade Resistance	Rolling Resistance	750K	800K	850K	900K*
2%	1%	30.48	30.05	29.64	28.59
4%	1%	20.56	18.94	17.45	17.03
6%	1%	15.55	14.29	12.19	12.01
8%	1%	11.14	10.60	9.73	8.91
10%	1%	8.87	8.72	8.25	7.69
12%	1%	7.85	7.18	6.56	6.49
14%	1%	6.54	6.41	6.04	5.61
16%	1%	6.04	5.55	5.03	4.02

\*Not recommended...shown for reference only



# Optimal Grades

793D Time on grade – 1,000 ft. lift (includes 1% rolling resistance)

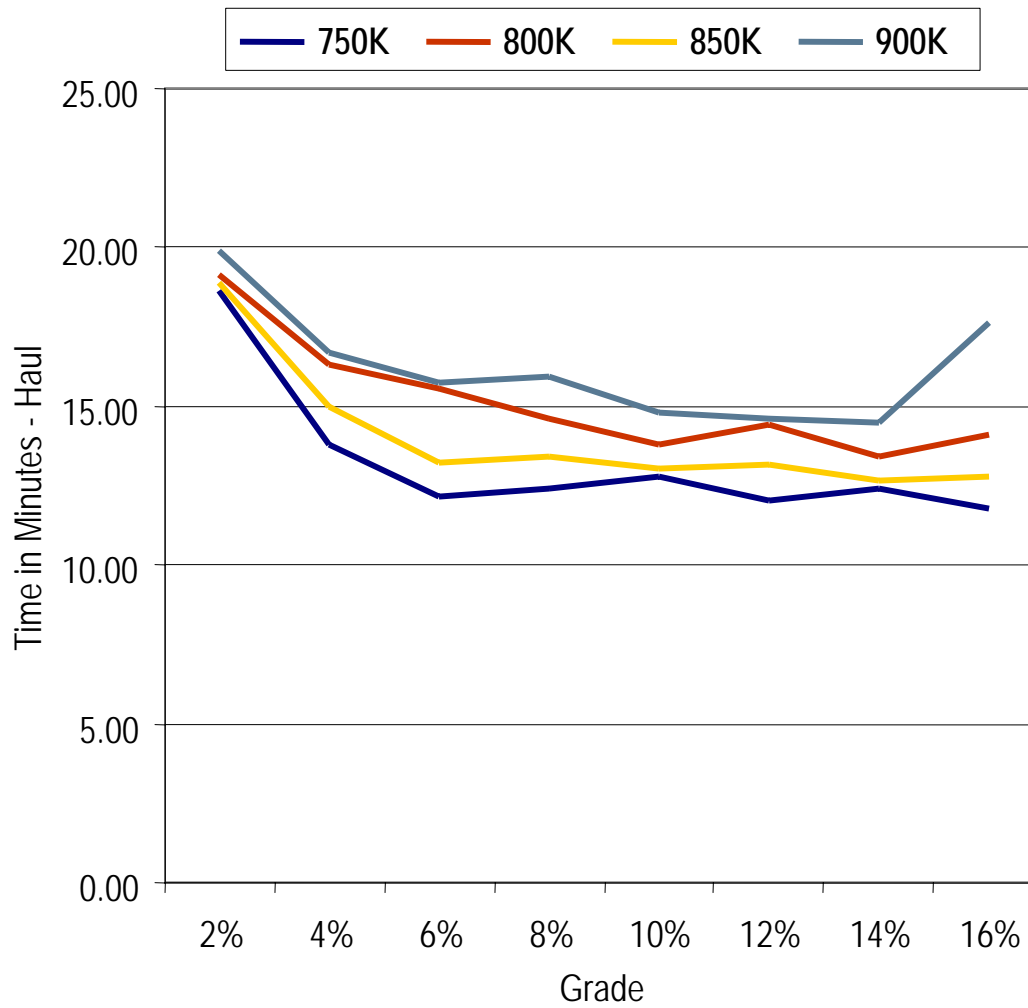

# Optimum Haul Road Grades

---

- Limit haul road grades to 8% - 10% with 2% rolling resistance
- Minimize haul road rolling resistance wherever possible
- Maintain payloads within the Cat 10-10-20 Overload guidelines





# Haul Road Cross Section Design

Caterpillar® Haul Road Design and Management



# Haul Road Cross Section Design

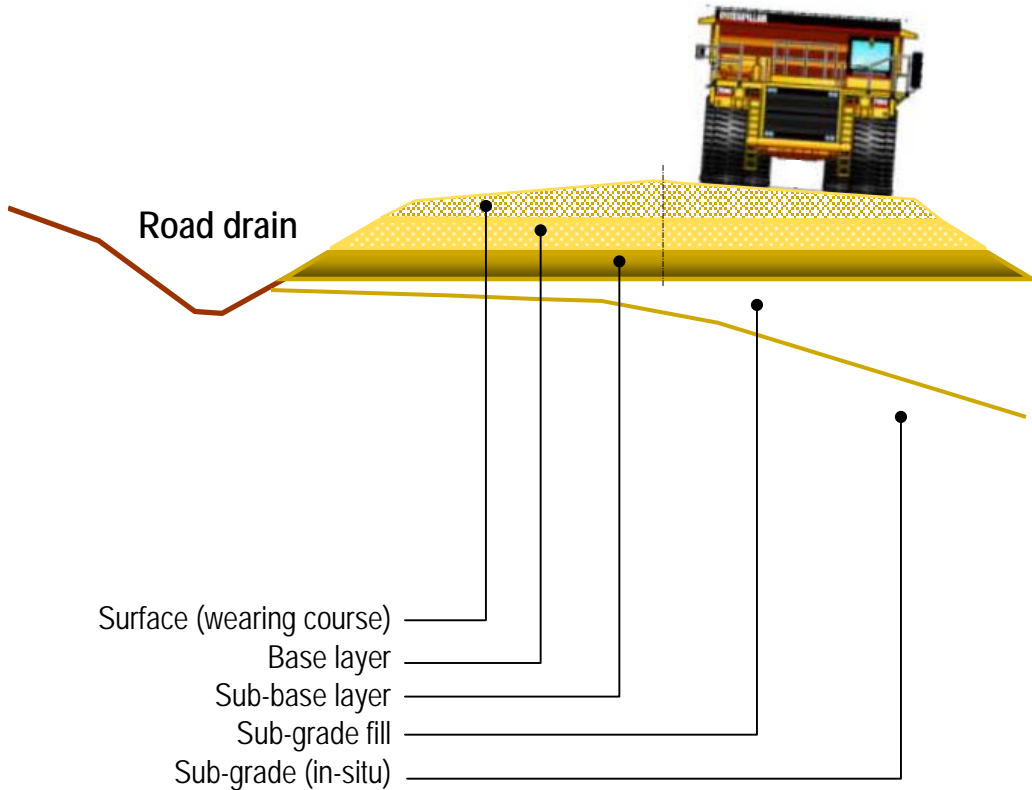

Number of layers may vary according to specific design and material availability

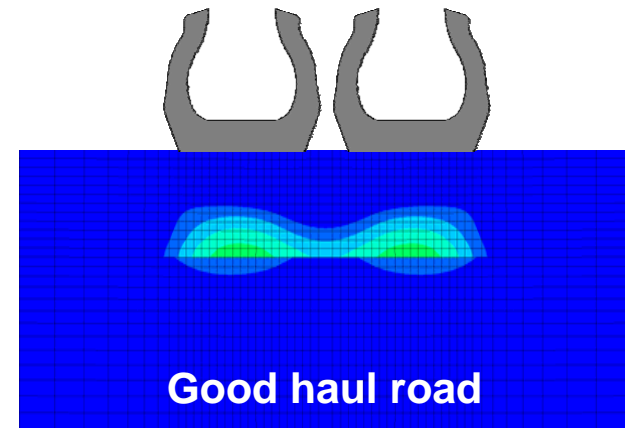
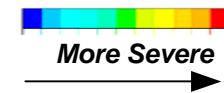
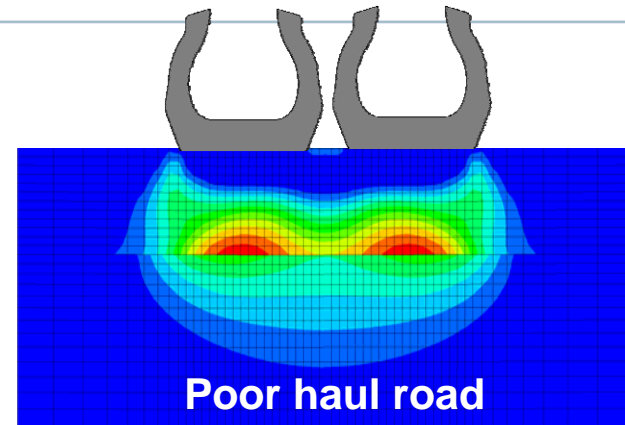

Permanent plastic strain due to shear failure



# Four Basic Layers

- Sub-grade
- Sub-base
- Base course
- Surface course

Typical haul road cross-section for 320t haul trucks

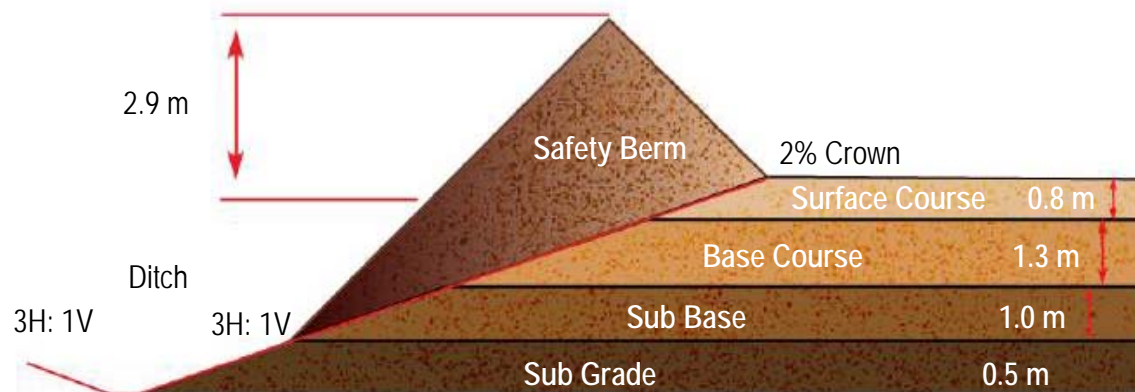

# Designing Haul Roads: Theoretical Example

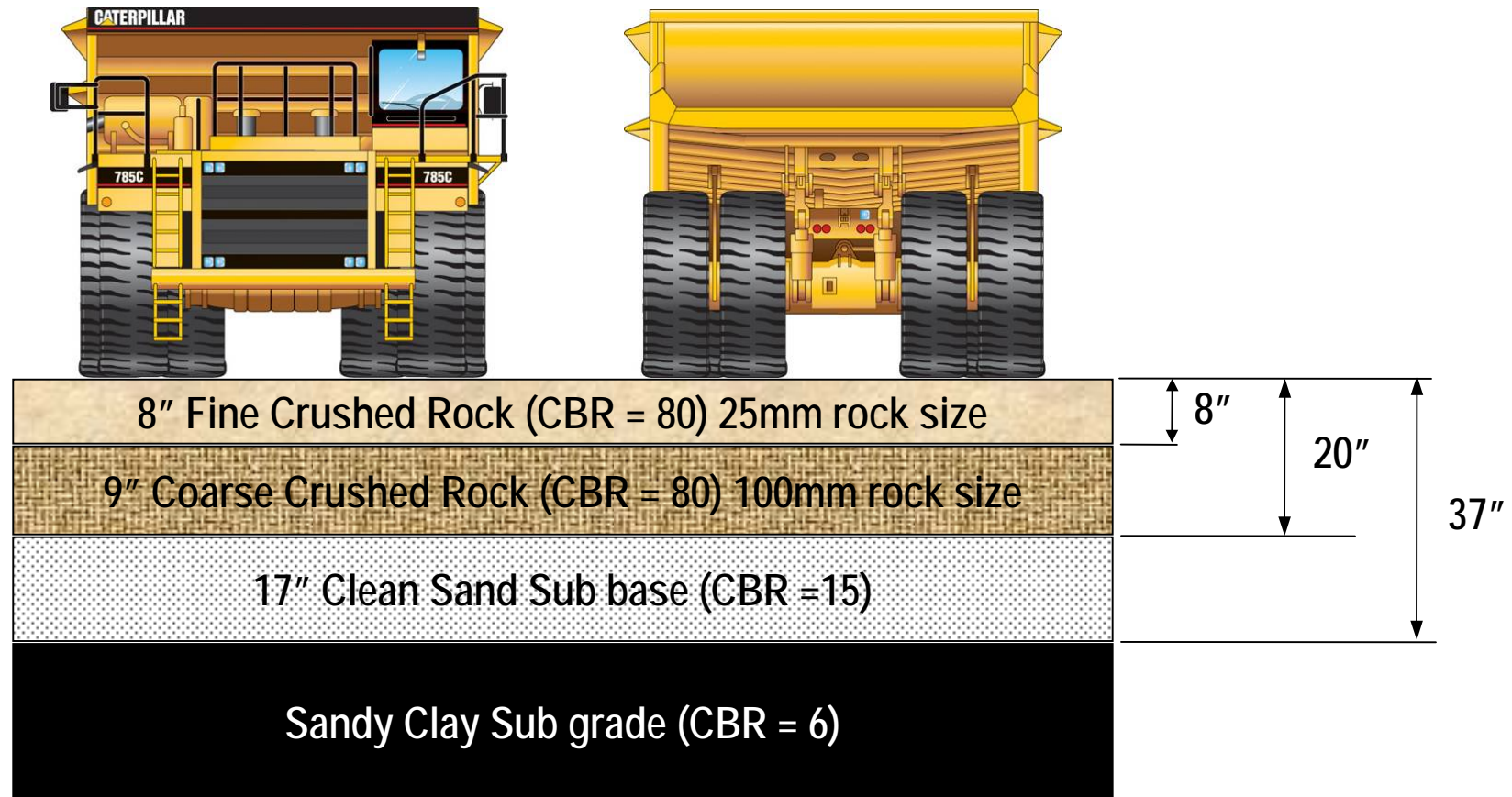

# Four Basic Layers

- Sub-grade
- Sub-base
- Base course
- Surface course

Typical haul road cross-section for 320t haul trucks

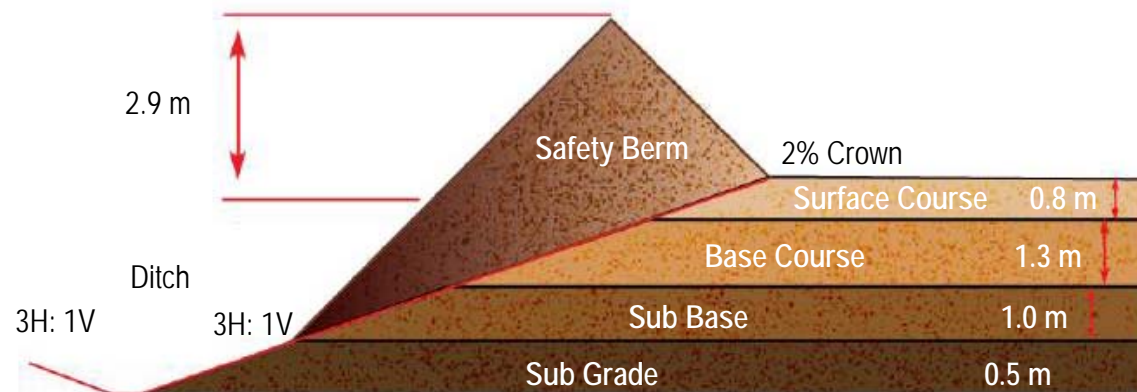



# Haul Road Surfaces

Caterpillar Haul Road Design and Management



# Haul Road Surfaces

---

## Primary haul road considerations include:

- Surface material – usually crushed gravel
- Roughness – impact forces are transferred from tires to truck
- Traction and rolling resistance – affects safety, productivity, and component life
- Dusting properties – can become a major maintenance and safety factor
- Maintenance and repair – part of overall design and operating costs







# Road Surface Roughness

- Significantly reduces truck component life from impact forces transmitted through the tires
- Most truck frame shock loads occur within 150m of the face and dump
  - Match bucket and truck size to minimize spillage; carefully design and maintain dump zones
- Truck frames have an impact fatigue life; fatigue is cumulative
  - Highest 10% is more damaging than lowest 90%



# Soft, Wet Areas

---

- Remove soft and wet spots completely and refill with good dry material
- Without a good repair, these spots will continually deteriorate





# Rolling Resistance

For off-highway trucks running radial-ply tires, assume a minimum rolling resistance of:

- 1.5% for a hard, well-maintained, permanent haul roads
- 3% for a well-maintained road with little flexing
- 4% for a road with 25 mm (1 in) tire penetration
- 5% for a road with 50 mm (2 in) tire penetration
- 8% for a road with 100 mm (4 in) tire penetration
- 14% for a road with 200 mm (8 in) tire penetration

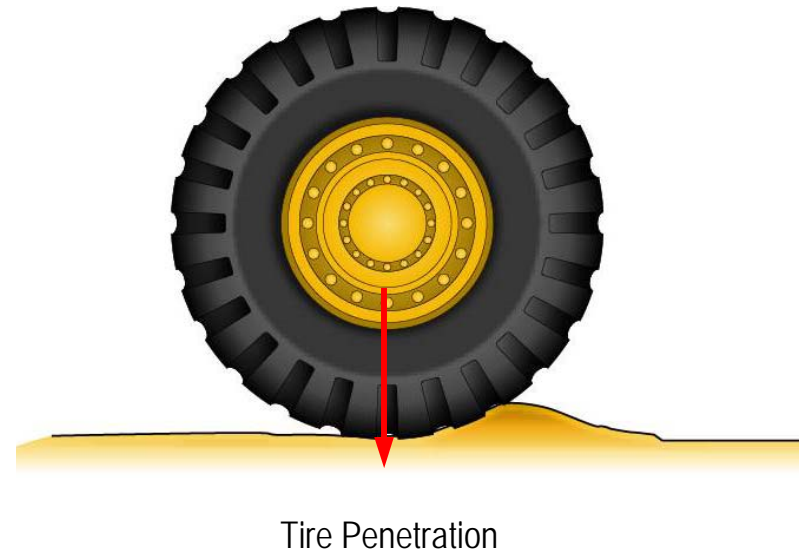

In practice, a 5% increase in rolling resistance can result in up to a 10% decrease in production and a 35% increase in production costs.



# High Rolling Resistance

---

- 610 mm (24 in) deep tire penetration
- 30% rolling resistance
- Excessive fuel burn
- Reduced tire life
- Reduced component life



Tire Penetration



# Rolling Resistance

Performance vs. Rolling Resistance  
10,000 ft. Flat Haul

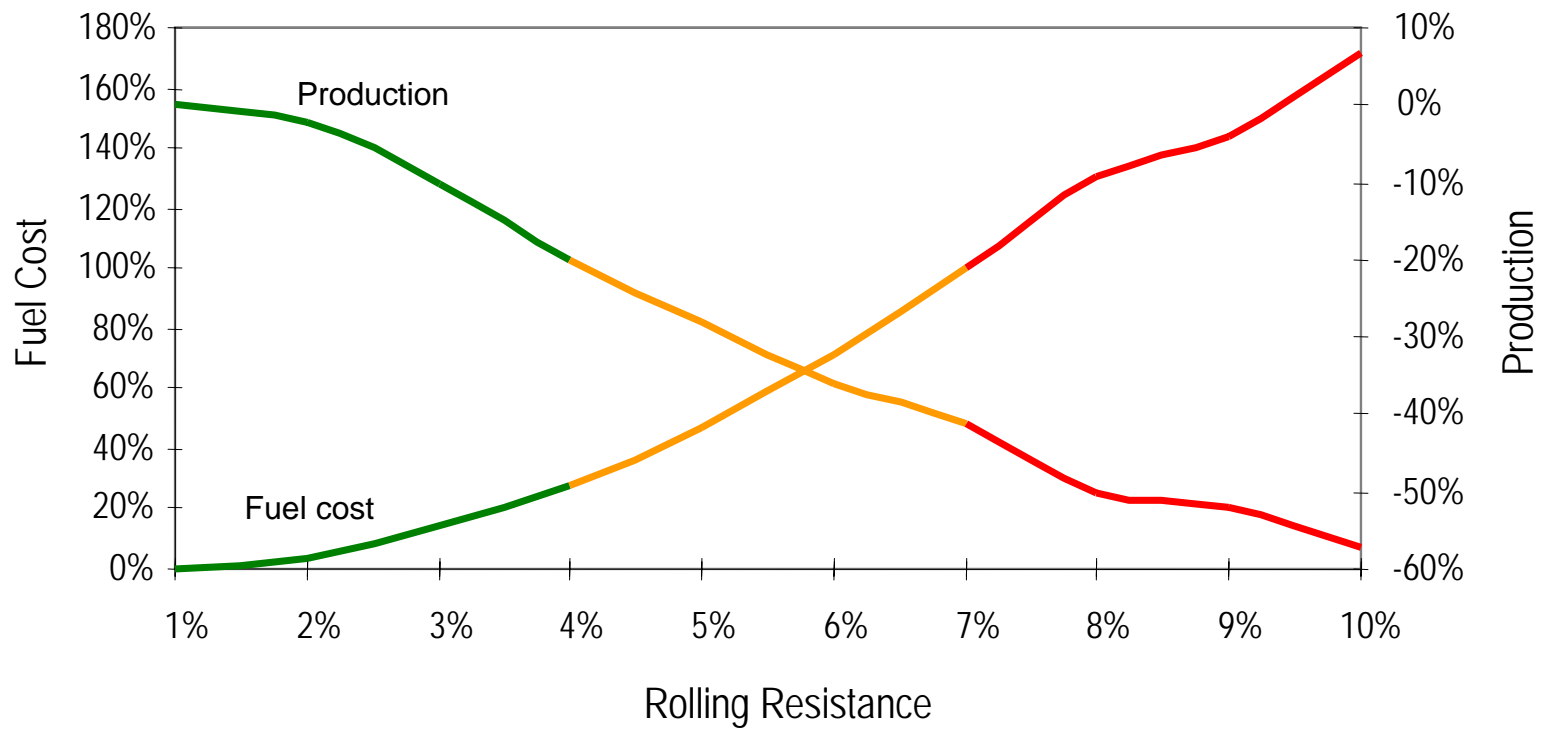

# Rolling Resistance

	Rolling Resistance, Percent*			
	Tires		Track**	Track + Tires
Underfooting	Bias	Radial		
A very hard, smooth roadway, concrete, cold asphalt or dirt surface, no penetration or flexing	1.5%*	1.2%	0%	1.0%
A hard, smooth, stabilized surfaced roadway without penetration under load, watered, maintained	2.0%	1.7%	0%	1.2%
A firm, smooth, rolling roadway with dirt or light surfacing, flexing slightly under load or undulating, maintained fairly regularly, watered	3.0%	2.5%	0%	1.8%
A dirt roadway, rutted or flexing under load, little maintenance, no water 25 mm (1") tire penetration or flexing	4.0%	4.0%	0%	2.4%
A dirt roadway, rutted or flexing under load, little maintenance, no water, 50 mm (2") tire penetration or flexing	5.0%	5.0%	0%	3.0%
Rutted dirt roadway, soft under travel, no maintenance, no stabilization, 100 mm (4") tire penetration or flexing	8.0%	8.0%	0%	4.8%
Loose sand or gravel	10.0%	10.0%	2%	7.0%
Rutted dirt roadway, soft under travel, no maintenance, no stabilization, 200 mm (8") tire penetration and flexing	14.0%	14.0%	5%	10.0%
Very soft, muddy, rutted roadway, 300 mm (12") tire penetration, no flexing	20.0%	20.0%	8%	15.0%



# Economic Impact of Rolling Resistance

---

- Increased fuel costs due to slower travel in lower gears
- Increased cost per ton hauled due to lower productivity
- Increased tire costs due to higher wear and potential failure
- Increased equipment and maintenance costs due to greater wear and fatigue





# Maintenance and Repair

---

Poorly maintained haul roads increase operating costs in terms of:

- Equipment – rough haul roads dramatically increase component wear increasing maintenance costs



# Measures to Reduce Haul Road Deterioration

---

- Keep ditches and culverts clear of obstructions to minimize potential erosion factors
- Use different areas of the haulage lane to avoid rutting
- Load vehicles within limits to prevent spillage
- Minimize dust problems with water trucks or sprinklers
- Employ support equipment (Motor Graders, Wheel Dozers, etc) to maintain cross slopes, remove spills, and fill and smooth surface depressions



# Drainage



Stagnant Water – No Drainage From Pit



Potential for Tire Cuts



Rut Formation – High RR



# Drainage

---

- Adequate drainage must carry away maximum expected rainfall, with minimum puddling, pot-holing or water entry into road sub-base

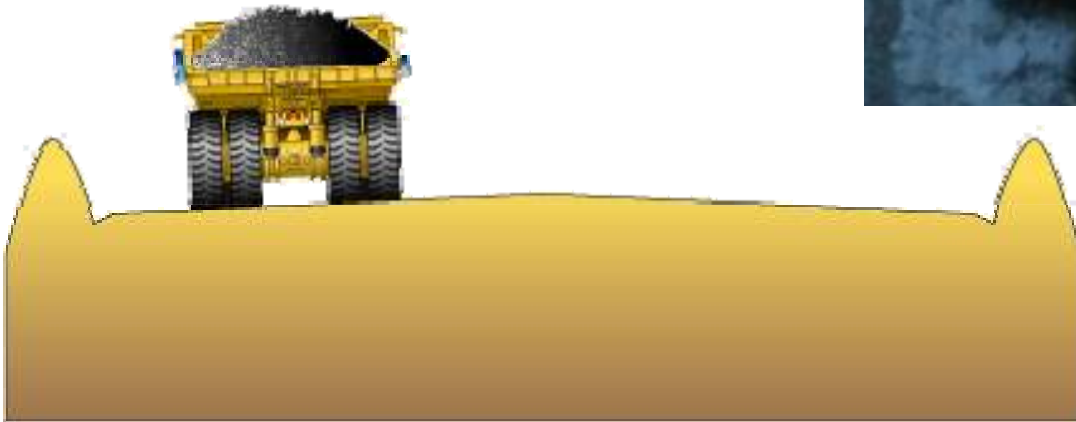

# Drainage

Proper drainage arrangements are an important constituent to good haul roads

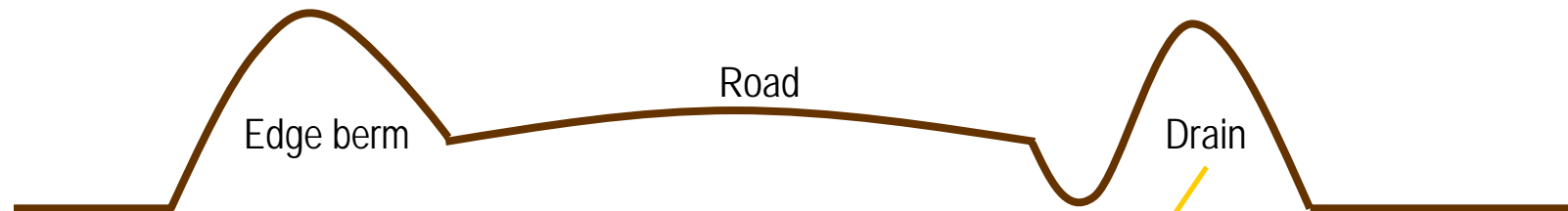

Constant cross fall and drain for water





# Ditches

---

- All roads need to be ditched, and ditches maintained
- Rock linings in ditches steeper than 8% prevent erosion
- Ditches should channel water to diversions, diversions to settling ponds
- Staked bails of hay can be used for temporary silt traps



# Dust Control

- Watering removes dust hazard and maintains compaction
- Use “checkerboard” or “spot” intermittent pattern on slopes to reduce slippage risk during braking grades
- “Spot” watering works well for areas with limited water supply

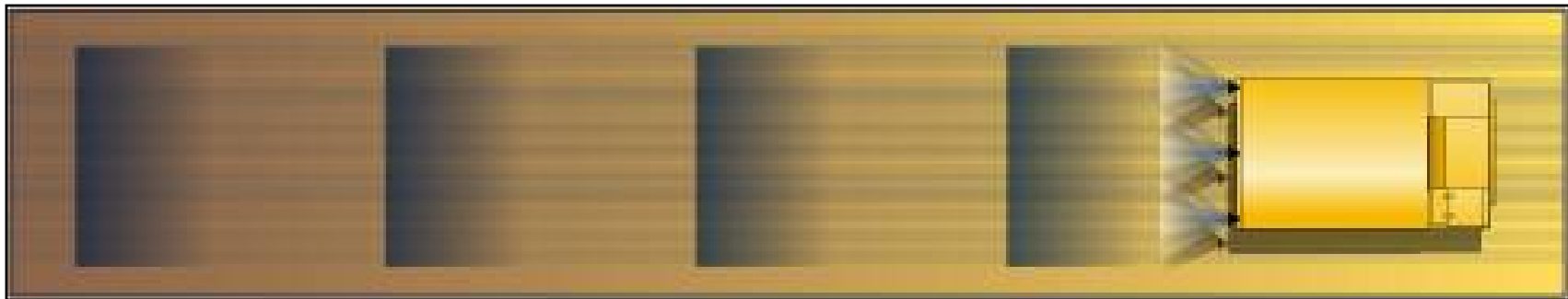
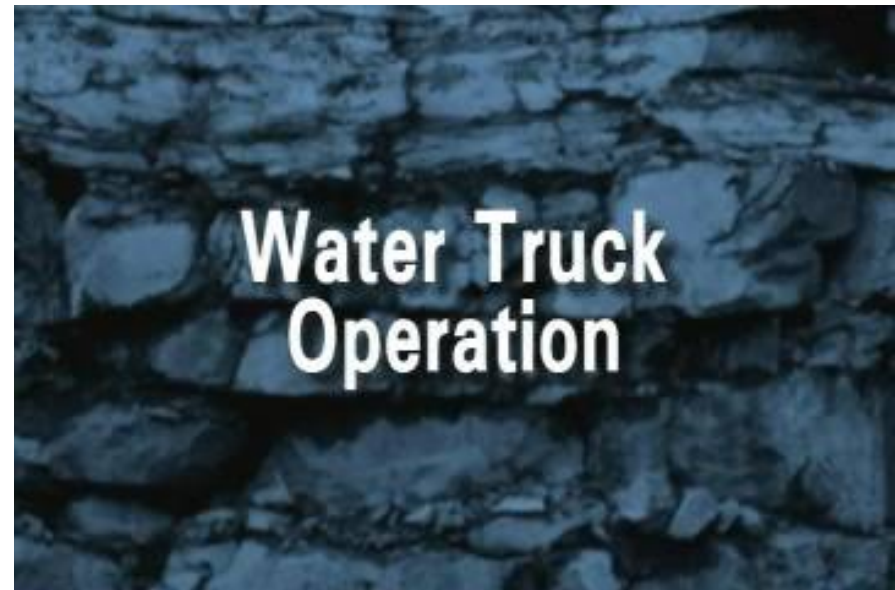

# Dust Control



Excess water sprinkling



Rut formation – high RR

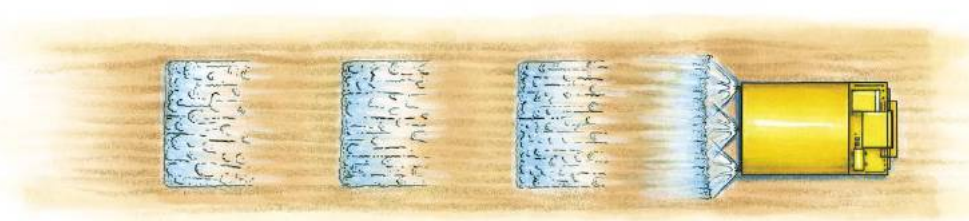

# Dust Suppressants

---

Liquid stabilizers and polymers provide:

- Dust suppression
- Stronger surface course
- Waterproofing

Common suppressants include:

- Emulsified asphalt
- Calcium chloride
- Calcium lignosulfonate
- Surfactants



# Haul Road Safety Considerations

Caterpillar® Haul Road Design and Management





# Rules of Thumb for Safety Berm Construction

## Recommended height

- Minimum of half the wheel height for conventional berms
- equal to tire height for boulder-faced berms

## Recommended placement

- Along the edge of the dump area
- Along all haul road edges with gaps for drainage
- Check your local mining regulations



# Other Purposes for Safety Berms

---

- Marking devices for haul road edges
- Drainage channels to prevent uncontrolled erosion
- Fixed points of reference for vehicle operators



# Safety Provisions

---

- Median or collision berms
- Escape lanes
- Appropriate signage
- Dedicated small vehicle roads



# Tire Impact on Road Design

Caterpillar® Haul Road Design and Management



# Factors Affecting Tire Life

---

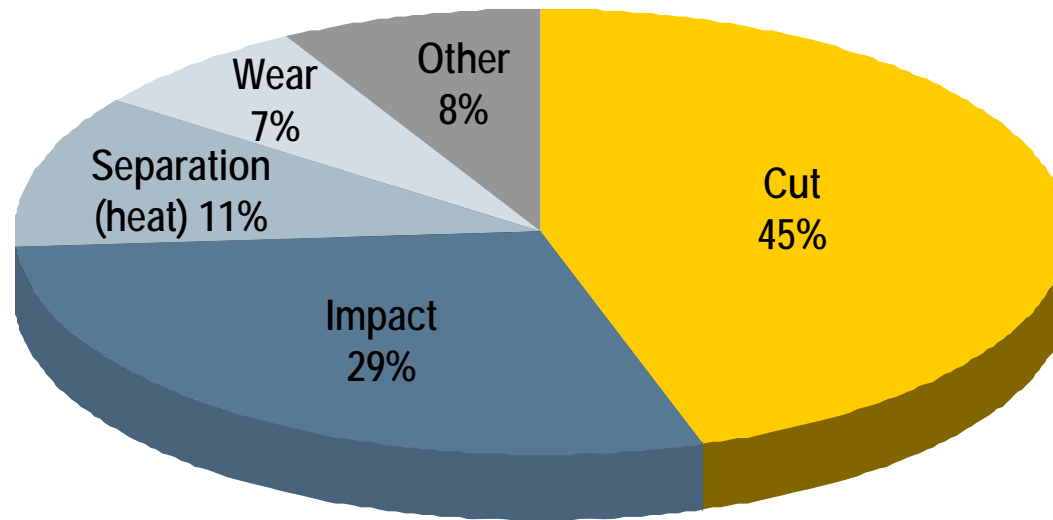

Source: Actual data, world-class metal mine

















# Load Transfer on Slope

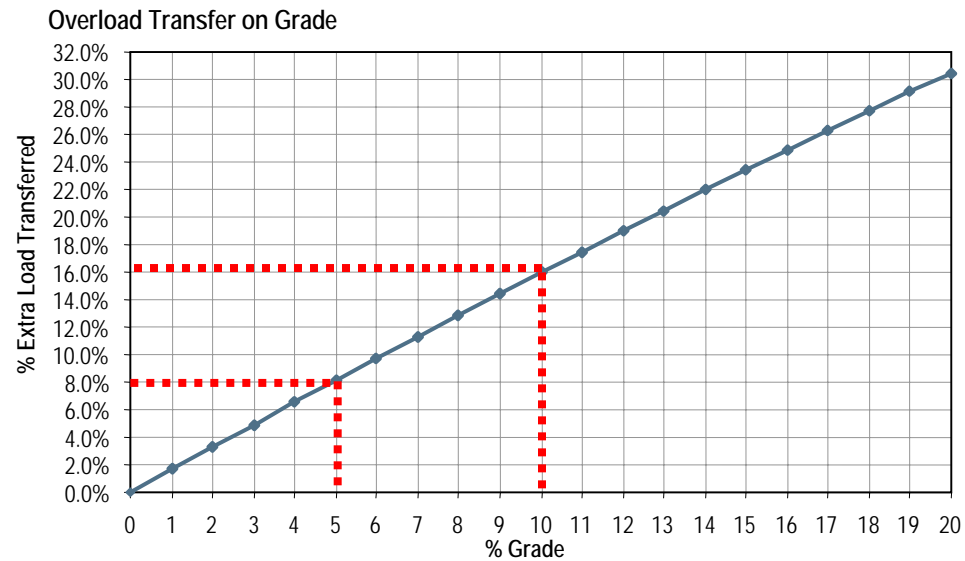
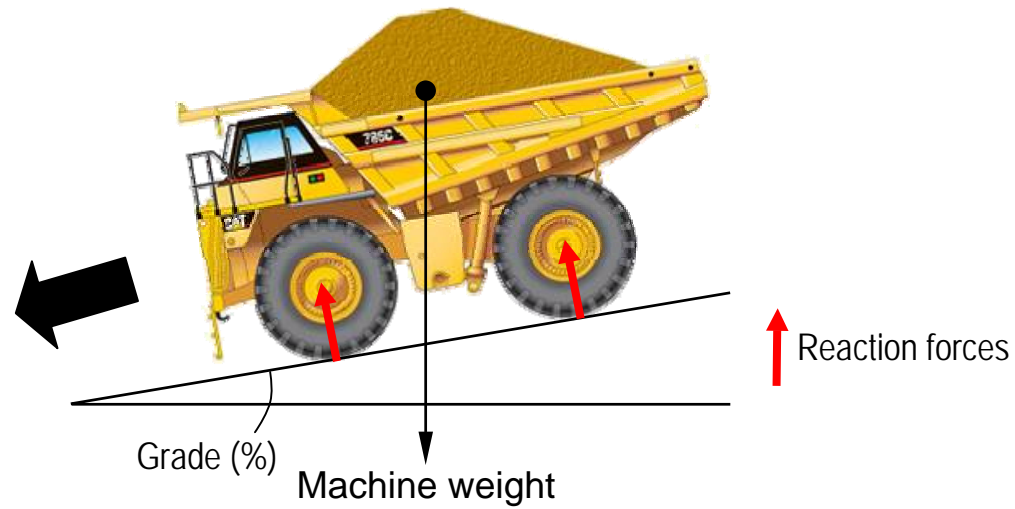

# Load Transfer on Grade (793 & 797)

% Front Axle Weight on Downhill Grade  
Calculations to Effective Weight

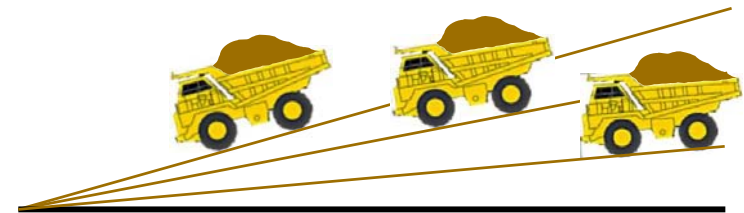
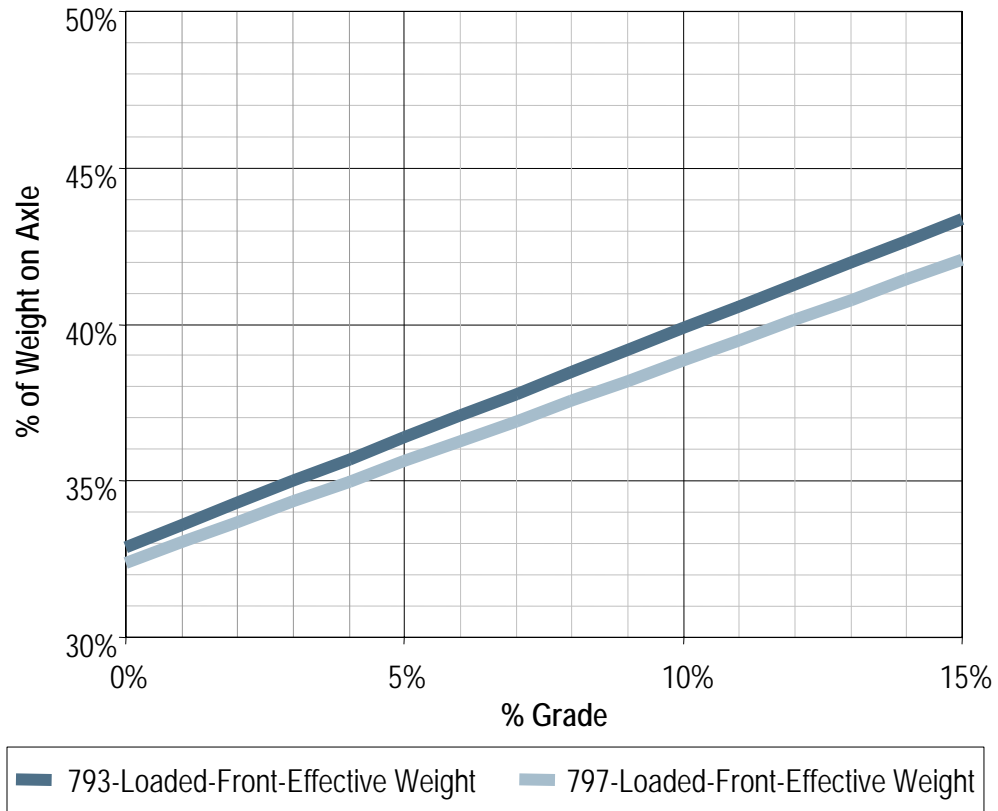

# Load Transfer on a Crown

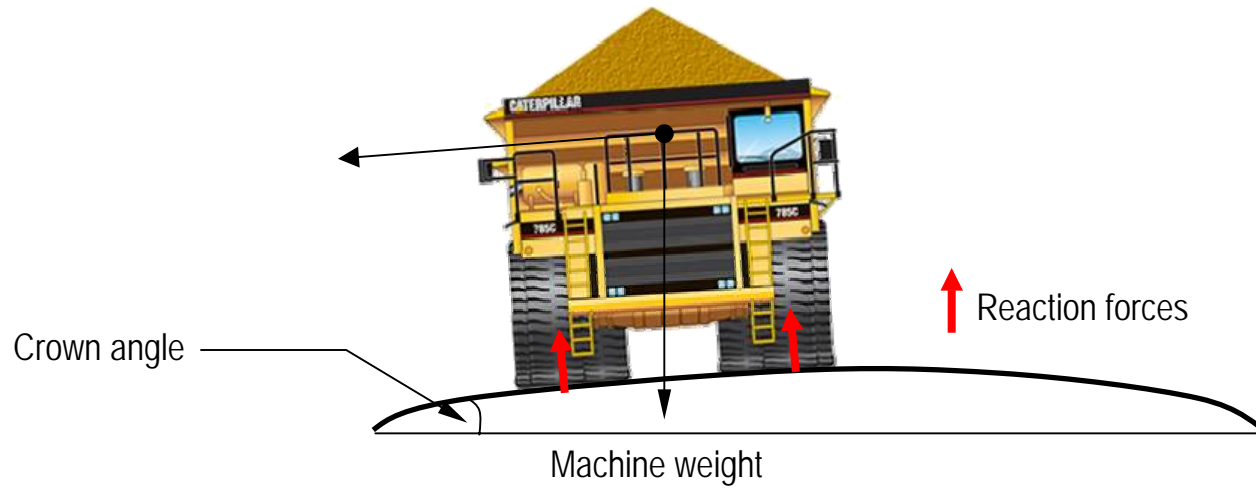

Overload Transfer on Crown

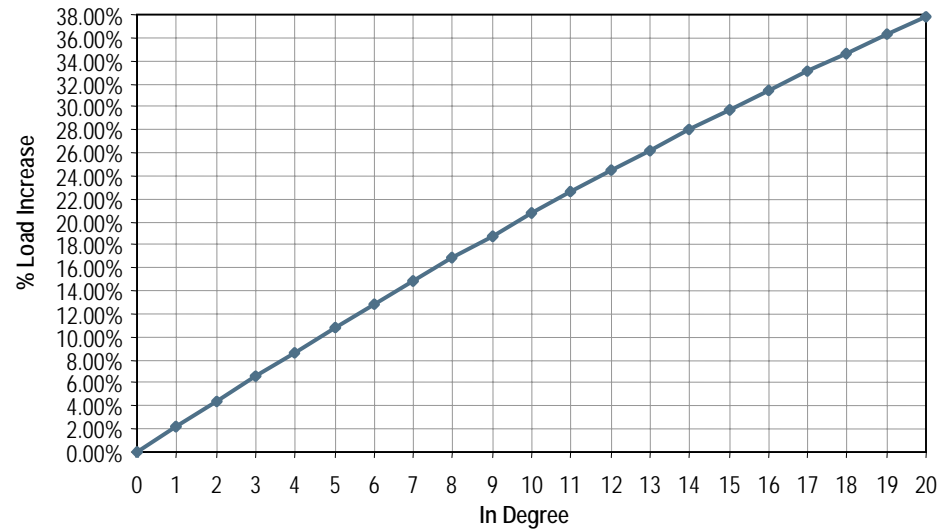

# Crown



Wrong crowning



Excess cross fall

Two-way cross fall

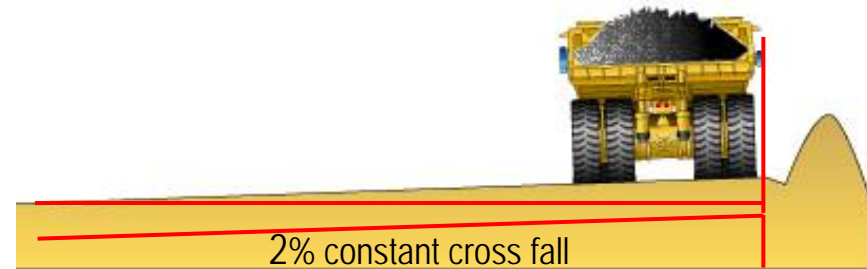
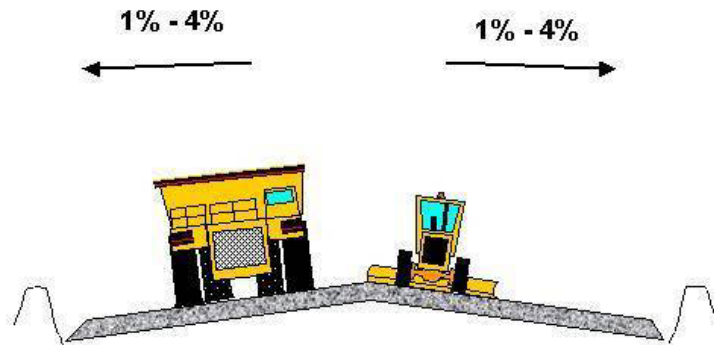

# Dumps



Constant clearing is necessary



Good dump area – keeps tire cuts at minimum



Ideal dump







# Watering



Excess water sprinkling



Rut formation – high RR

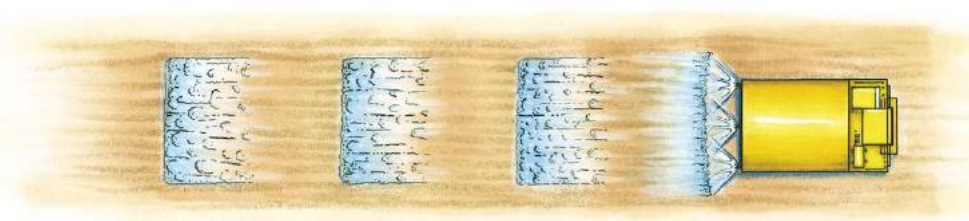

# Influence of Load Increase

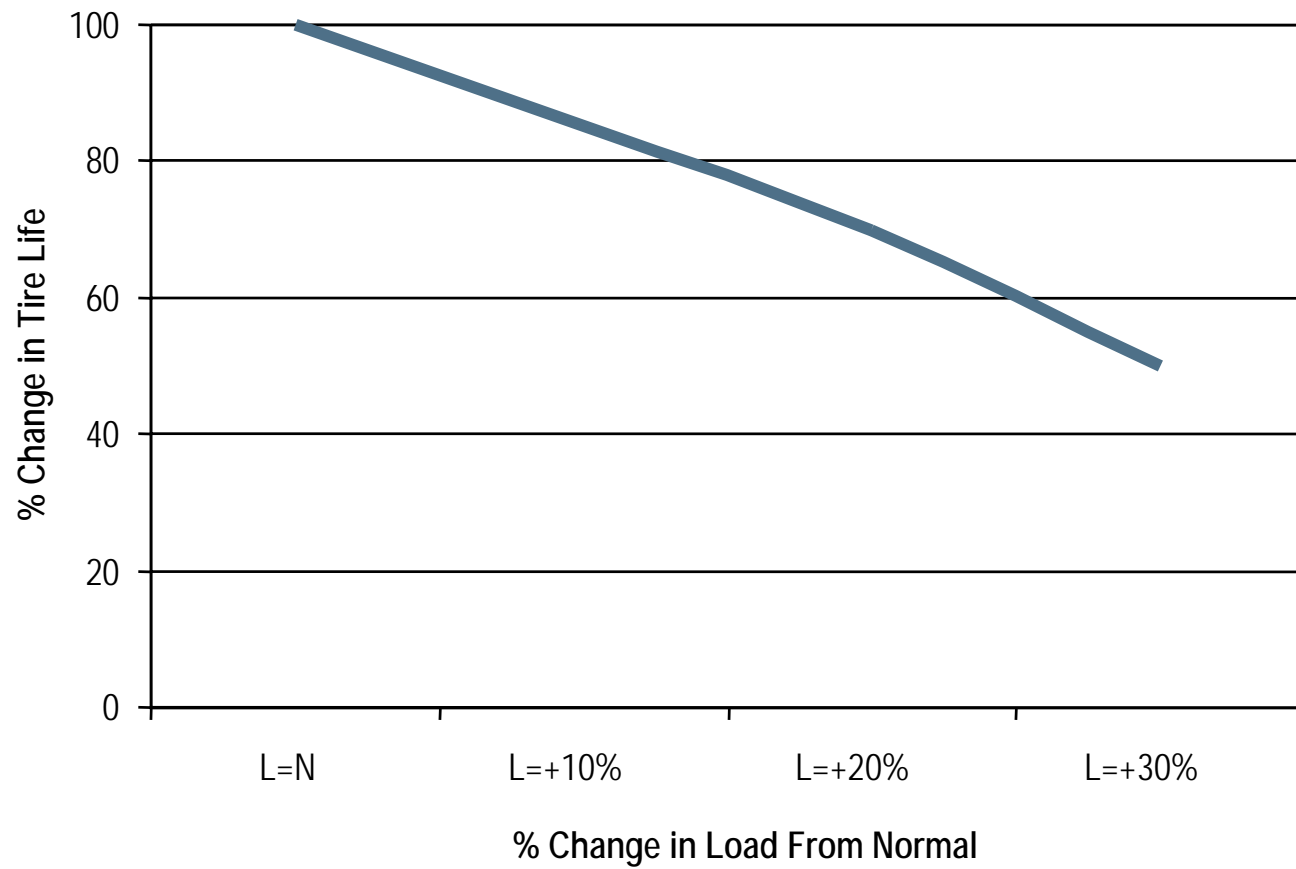

# Strut Pressures

- Ensure that the cylinders are properly charged as per manufacturer's recommendations

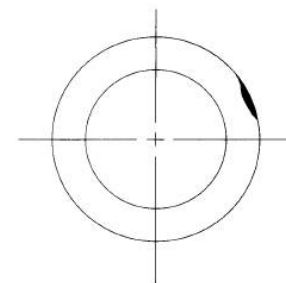
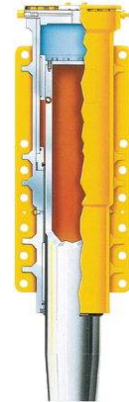



# Inflation Pressure

Correct inflation pressure provides an optimum shape to the tire with the following features and benefits

- The maximum ground contact area
  - Maximum traction and braking
  - Optimum cornering ability
  - Maximum flotation
- The optimum flexibility
  - Optimum enveloping of road hazards
  - Optimum sidewall flexibility to minimize the effects of road irregularities
- Reduced heat levels within tire
  - Minimum heat levels in the tire reduce fatigue within the tire
  - To use the longest wearing and most cut resistant tread compound for the operating conditions
- Reduction in downtime
  - To increase the availability of the equipment
  - To increase productivity and reduce operating cost





# Support Equipment

Caterpillar® Haul Road Design and Management



# Support Equipment Benefits

Tractors, wheel dozers, motor graders and water trucks

- Optimum machine productivity
- Minimum impact on major components
- Maximum tire life
- Maximum haul road life
- Maximum operational safety



# Points To Remember

---

## Haul Road Support







# Software for Aiding Haul Road Design

Caterpillar® Haul Road Design and Management





# VIMS® System

A Caterpillar® exclusive integrated system that monitors machine performance to provide critical information on a real-time basis

- Export data to Application Severity Analysis (ASA) and Road Analysis Control (RAC) to quantify haul road conditions
- Better payload management to optimize speed on grade
- Check event logs for high brake temperatures, engine over-speeds, etc.

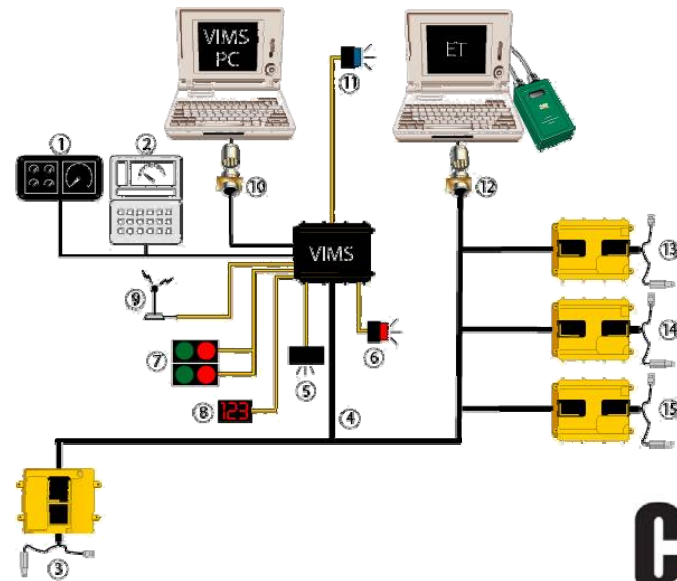

# Fleet Production and Cost (FPC)

A Caterpillar exclusive software package that can simulate truck productivity and estimate cost-per-ton on your haul road profiles

Use FPC to compare actual cycle times with predicted values:

- Are trucks achieving predicted speed on grades?
- Are trucks cycling in predicted cycle times?
- Are truck wait times at the loader in the predicted range?

If predicted values don't match actual times, investigate possible causes:

- Rough/slippery roads causing operators to slow down
- Higher rolling resistance than planned/expected
- Tight corners forcing machine to slow down
- Poor visibility due to dust or obscured views
- Pinch points, stop signs at intersections, etc

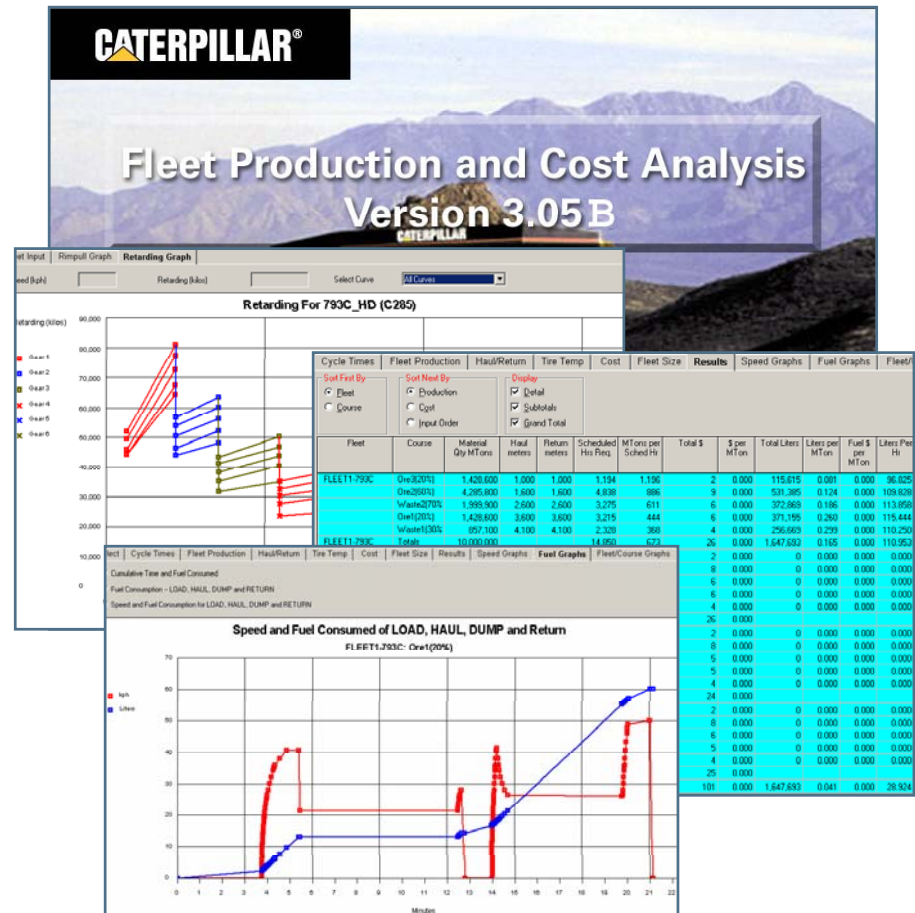

# Road Analysis Control (RAC)

A Caterpillar exclusive monitoring tool that uses on-board pressure sensors, RAC monitors and logs haul road severity to increase truck life and reduce cost/ton.

- Sensors measure component loading & impact shock
- System identifies haul road problem areas to avoid and correct
- Contributes to improved haul roads to optimize truck component life, fuel consumption, and safety
- Transmits real time data and GPS locations to maintenance via radio, if equipped



01	Red	TOPKIP Tires - No Condition
02	Blue	TOPKIP Tires - No Condition
03	Green	No Data Detected
04	Yellow	No Data Detected
05	Cyan	No Data Detected
06	Magenta	No Data Detected

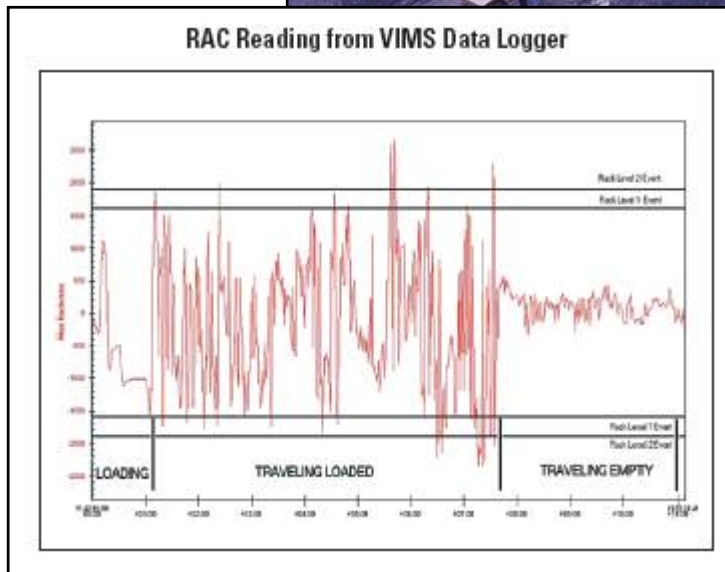

# Reduce Cost per Ton With Road Analysis Controller

- Increase Productivity
- Lower Tire Cost
- Reduce Operator Fatigue
- Increase Frame Life
- Maximize Support Equipment Utilization
- Extend Component Life



$$\frac{\text{Cost per Hour}}{\text{Ton's per Hour}} \begin{matrix} \downarrow \\ \uparrow \end{matrix} = \text{Cost per ton} \downarrow$$



---

"RAC system has helped us respond quicker in making the necessary repairs to the roads. Through improved pit planning, haul profile and haul road maintenance we have increased our truck speeds approximately 2 mph."

Jeffery D. Carter  
Process Manager- Maintenance RAG Coal West, Inc.





# Road Analysis Control

---

## How It Works:

- Collects each strut's pressure data 10 times per second
- Measures differences between the struts to determine:
  - Pitch - Front and Rear Axle Wheel Strut Pressures
  - Rack - Diagonal Wheel Strut Pressures
  - Bias - Side to Side Strut Pressures
- Adjustable RAC events for site conditions
- Develops Fatigue Equivalent Load Analysis (FELA) Index to Establish a Relative Severity of each Cycle
- Calculates Trends, manages Events in VIMSpC
- Correlates Pitch and Rack Measurements against Predetermined Acceptable Design Limits



# $RACK = (LF+RR)-(RF+LR)$

eg:  $(1000 + 2100) - (400 + 300) = 2400$  PSI RACK

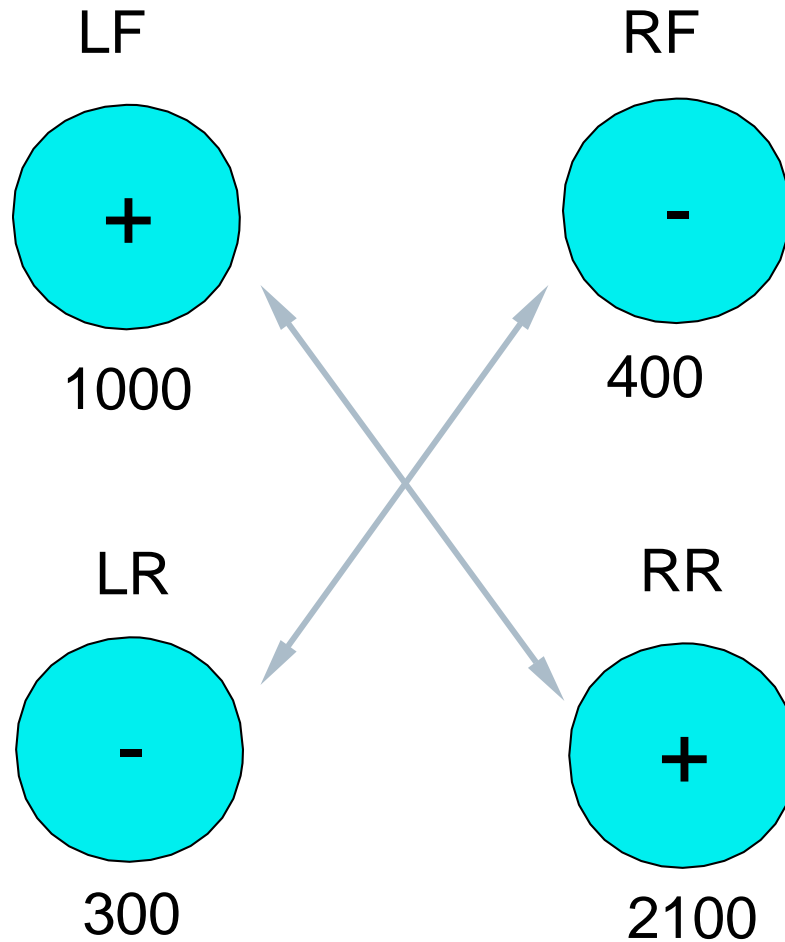

# Pitch = (LF+RF)-(LR+RR)

---

eg: (1400 + 1400) - (500 + 500) = 1800 PSI Pitch

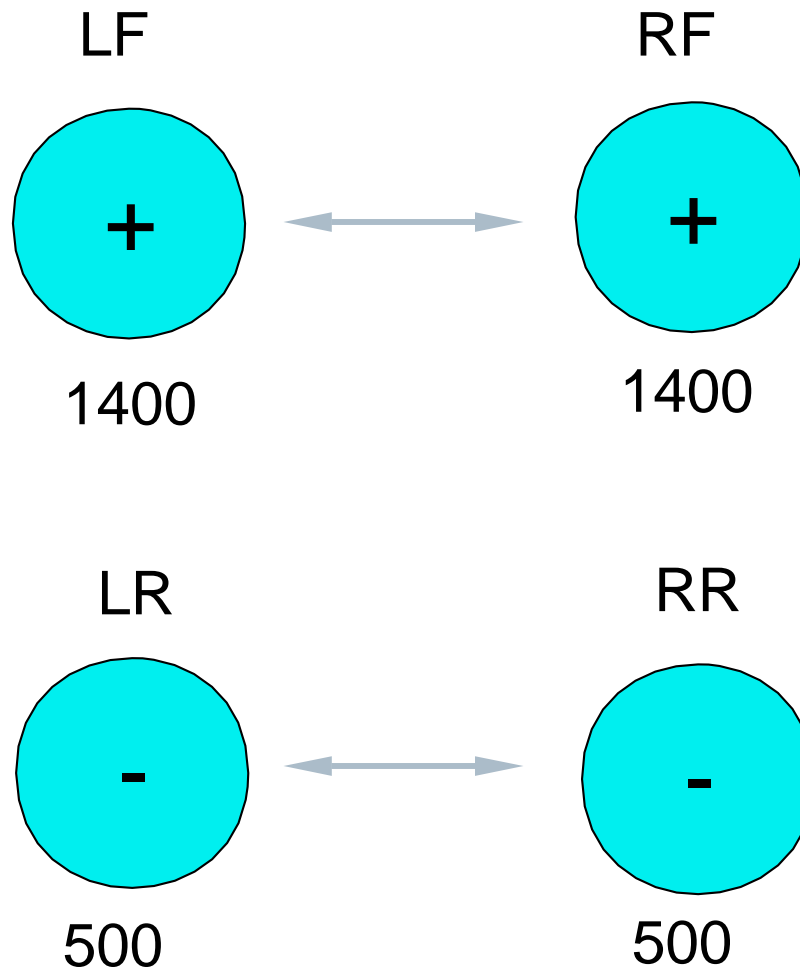

# Bias = (LF+LR)-(RF+RR)

---

eg: (1600 + 1400) - (400 + 300) = 2300 PSI Bias

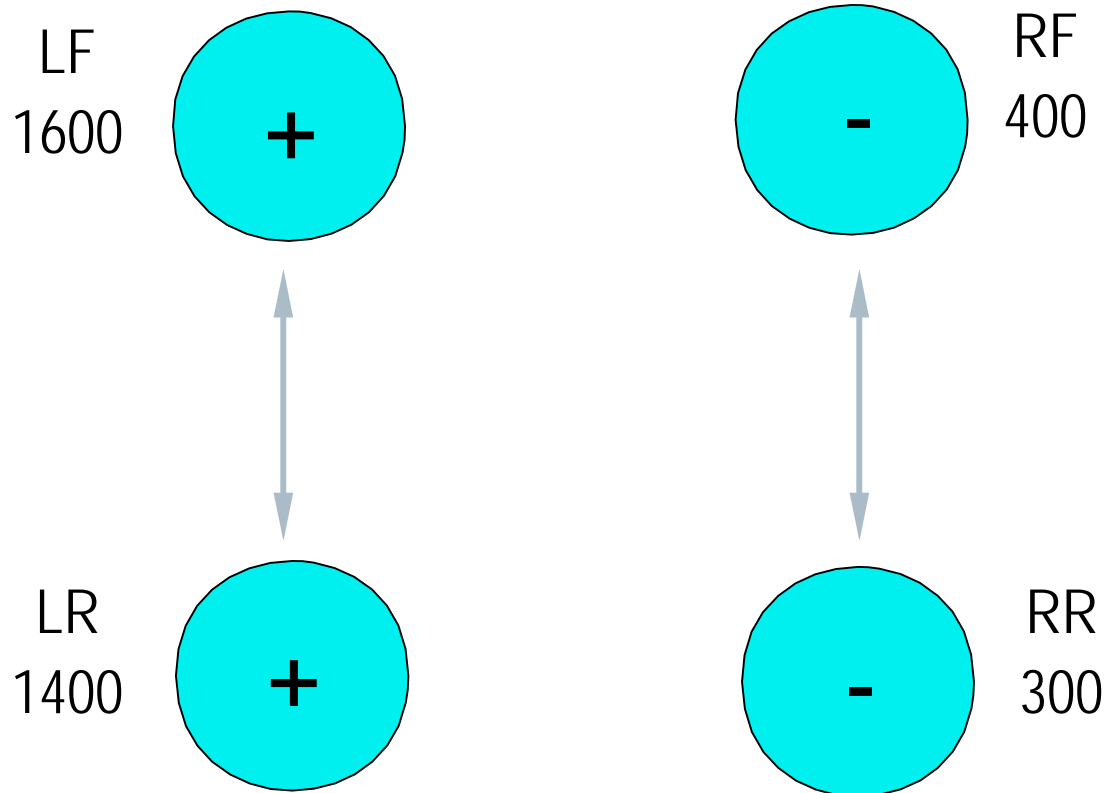

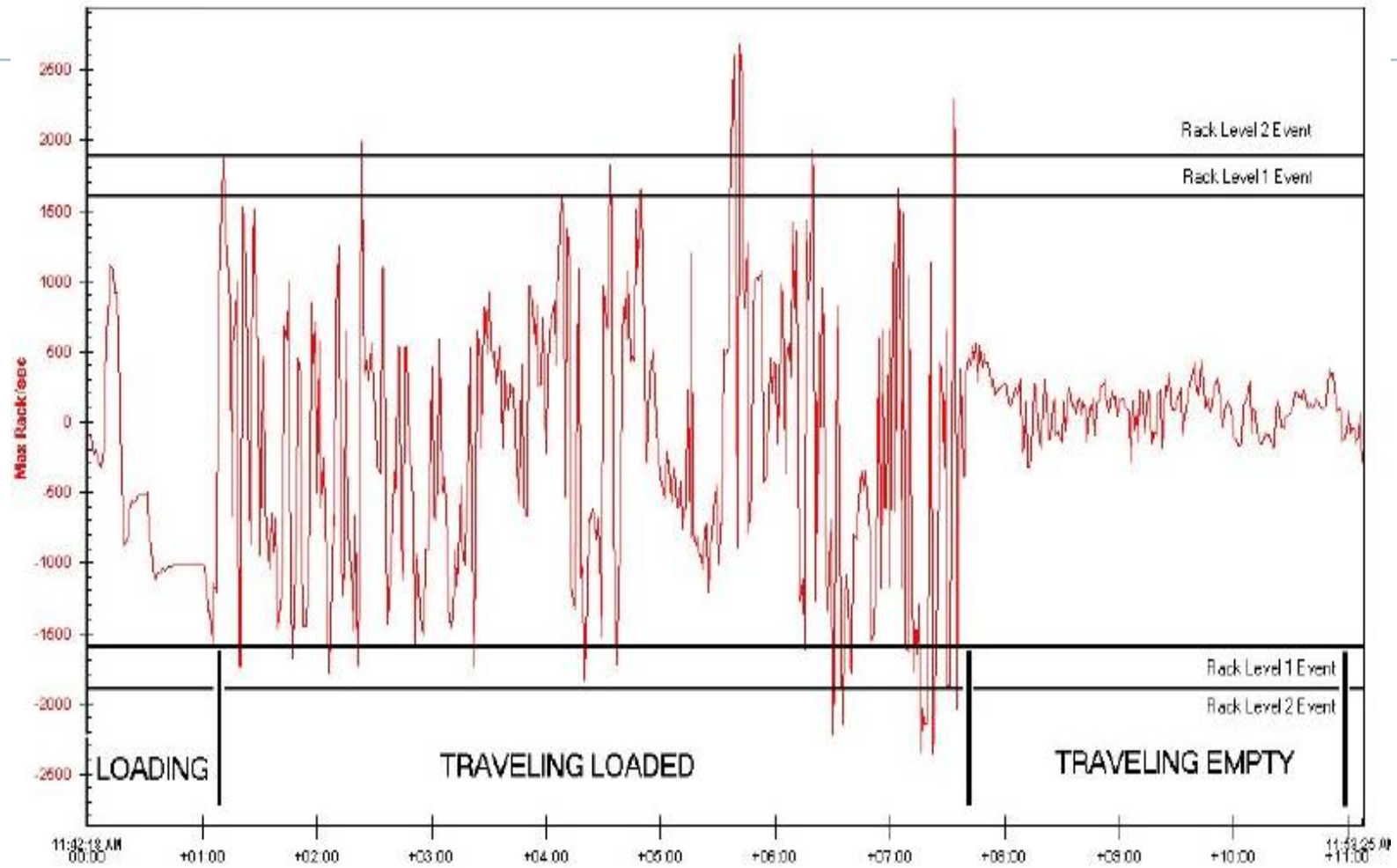



# RAC Trigger Levels

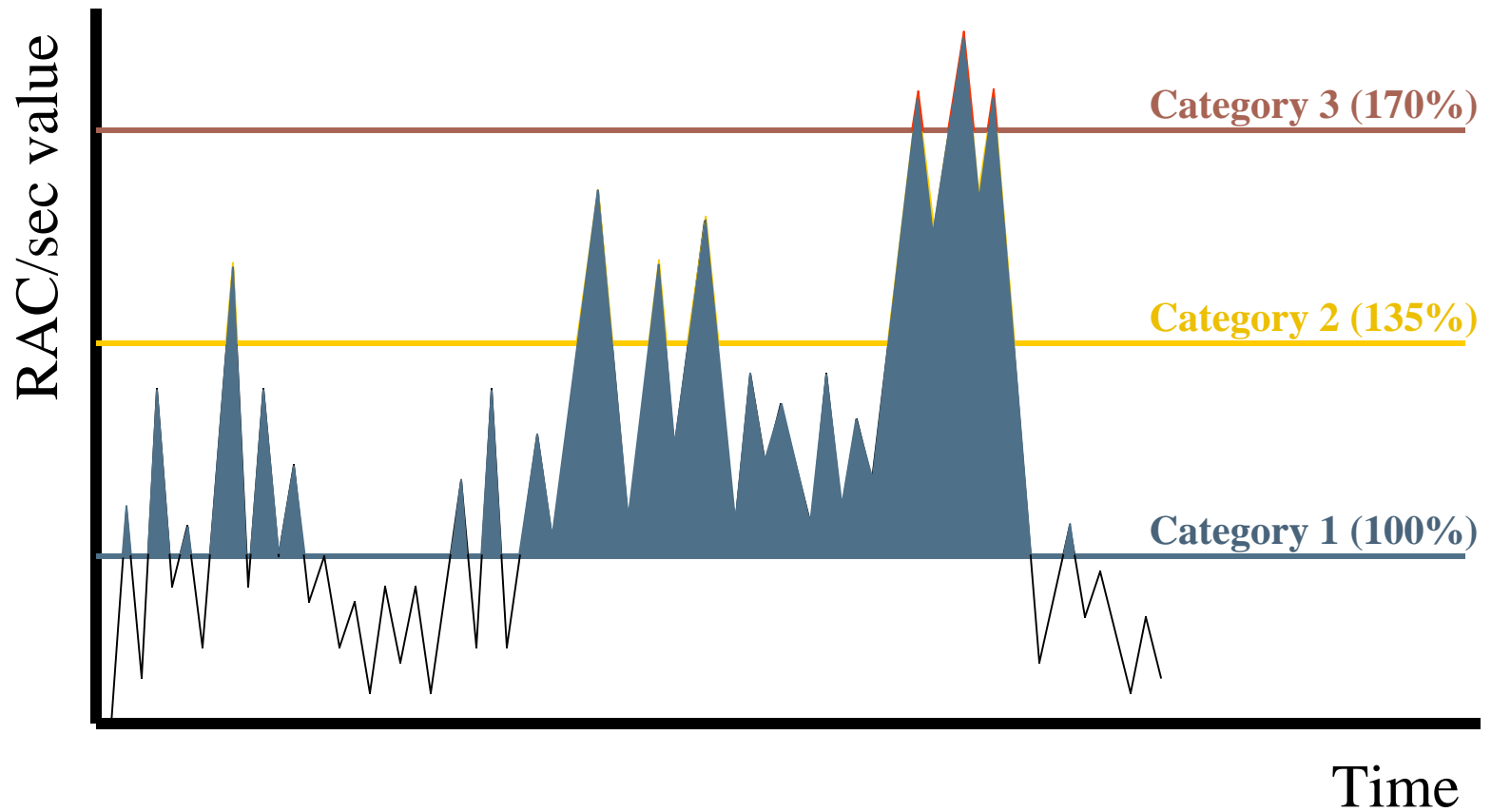

# Features:

---

- Provides real time “Event” feedback to the operator
  - Two Levels of Warning through VIMS on-board
    - Level I - VIMS Alert Light and Warning Message “Maximum Pitch and Rack Limits” have been measured – “Reduce speed”
    - Level II - VIMS Alert Light and Warning Message “Max Pitch and Rack Measurements Too High - Slow Down, Avoid Area”
- Event information transmitted wirelessly through MineSTAR, VIMSwireless or other telemetry link





# Which Tire Cost More?

---

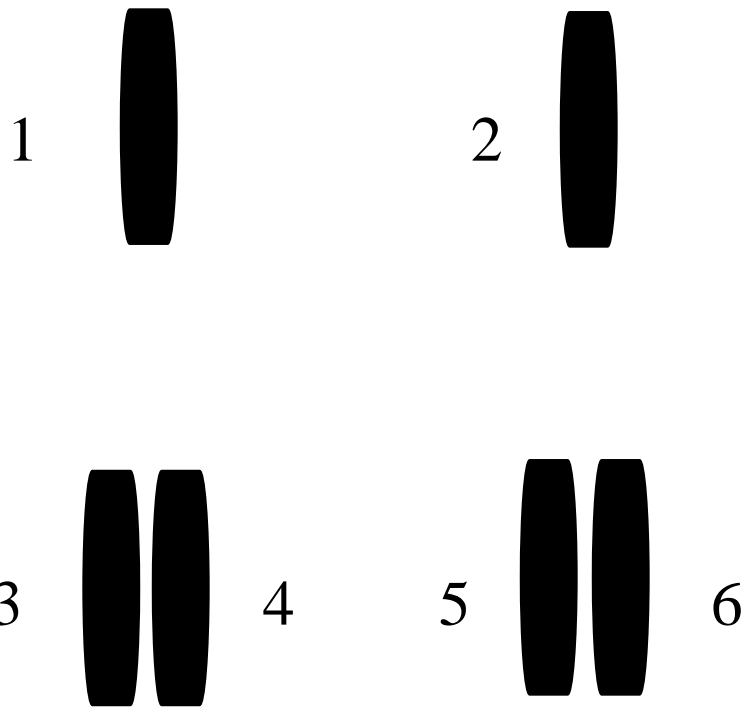

<u>MPH</u>	<u>% Load</u>
1-3	14%
3-5	21%
5-7	38%
7-10	56%
+11	75%

# RAC Will Identify Where to Repair Your Roads





# What can you do with the data?

---

- Example: Week to week reporting
- Using data from VIMSpC or VIMS Supervisor, create a simple overview report (no satellite solutions required!)

*Compare to results from last week – did we improve?*

---

Period 5/02/2003 to 12/02/2003 Truck: DT123

	Rack	Pitch	Bias
Number of Events in Period:	2	6	15
Average FELA during Period:	735	1034	

---

Average Payload/cycle for Period:	237.5 tons
Average Fuel used/cycle for Period:	41 gallons
Average Cycle Time for Period:	25:20
Tire Cost/Hour for Period:	\$10
Tires lost to road hazards:	1

---



# Mine EIA

A Caterpillar exclusive software package that can calculate cost per ton and quantify the value that Caterpillar and competitive mining truck, loading tools, and dozers provide

- Combines financial and production factors to simplify determining lowest cost per ton
- Change various cost and production factors to see the effect on overall cost per ton

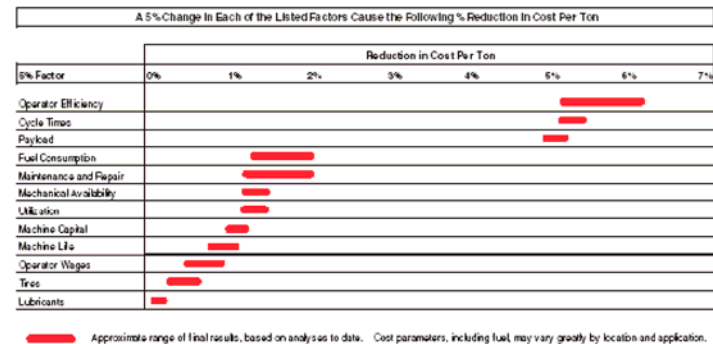
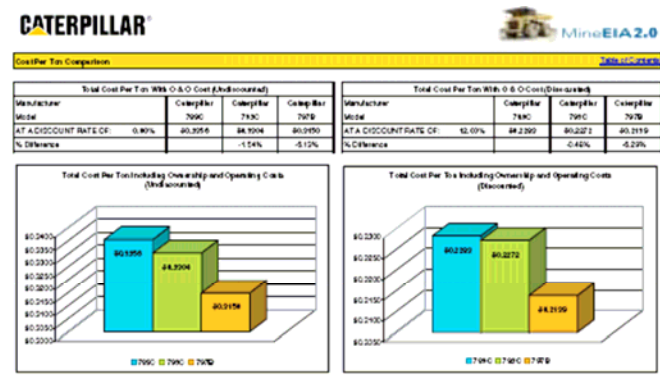

# Economics of Haul Road Construction

Caterpillar® Haul Road Design and Management



# Road Building Costs

To truly understand haul road economics, the full life-cycle costs must be considered

- Road construction
- Road removal
- Impact on fleet productivity and operating
- Road maintenance
- Extra fleet operating and maintenance
- Extra stripping costs (haul road width)
- Cost - the time value of money

Climate

Truck size

Volume moved

Loss of ore



Permanent road

Semi-permanent roads – months or years

Temporary roads – days or weeks



# Rolling Resistance

---

## Impact of rolling resistance on cycle time:

- The following examples assume a 1.6m one-way haul distance and a 1.8 minute combined loading and dumping time.
- Example #1:  
4% rolling resistance – loaded and unloaded travel times for the CAT 793C are a combined time of 4.7 minutes – total cycle time = 6.5 minutes
- Example #2:  
10% rolling resistance - loaded and unloaded travel times to a combined time of 9.5 minutes – total cycle time = 11.3 minutes
  
- Plus 50% lost production





# Effect of Rolling Resistance on Production (English)

Increased haul & return speed = Increased cycles

## 793 truck

- 250 ton payload
- 17 min cycle = 3.5 cycles/hr  
15 min cycle = 4 cycles /hr
- 4 cycles/hr x 250 tons = 1000 tons/hr  
3.5 cycles/hr x 250 tons = 875 tons/hr  
125 tons



# Effect of Rolling Resistance on Production (English)

Increased haul & return speed = Increased cycles

793 truck

- 250 ton payload
- 17 min cycle = 3.5 cycles/hr  
15 min cycle = 4 cycles /hr
- 4 cycles/hr x 250 tons = 1000 tons/hr  
3.5 cycles/hr x 250 tons = 875 tons/hr  
125 tons

125 tons x .75 eff = 100 tons

100 tons x 10 trucks = 1000 tons/hr

1000 tons/hr x 6500 hrs = 6,500,000 tons/annual



# Questions?

## Caterpillar® Haul Road Design and Management







