

Celseon[®] AK/AJ Condensing Units

Reference Guide



Tecumseh



Use intended for Authorized Wholesalers/OEM Customers.

Celseon AK/AJ Condensing Units
Modular Design = True Simplicity

Celseon AK/AJ Condensing Units

Celseon AK/AJ. Modular Design = True Simplicity.

Tecumseh's Celseon AK/AJ condensing units are designed specifically for refrigeration applications where reliable cooling is required under varying loads and operating conditions. Reliability starts with the compressor and at the heart of every Celseon Unit is a performance-proven Tecumseh compressor, built with exacting standards to handle the rigors of commercial refrigeration.

Celseon AK/AJ's modular construction is built around three (3) common base plates, scaled to unit capacity, that accommodate an assortment of Tecumseh compressor models and standardized components. Options include power cord, service valves, receiver tank, filter-drier, and sight glass.

AK/AJ models are available ranging from 1/3 to 1-1/4 HP. Models are released in refrigerants R134a and R404A, as well as R12, R22, and their replacement blends.

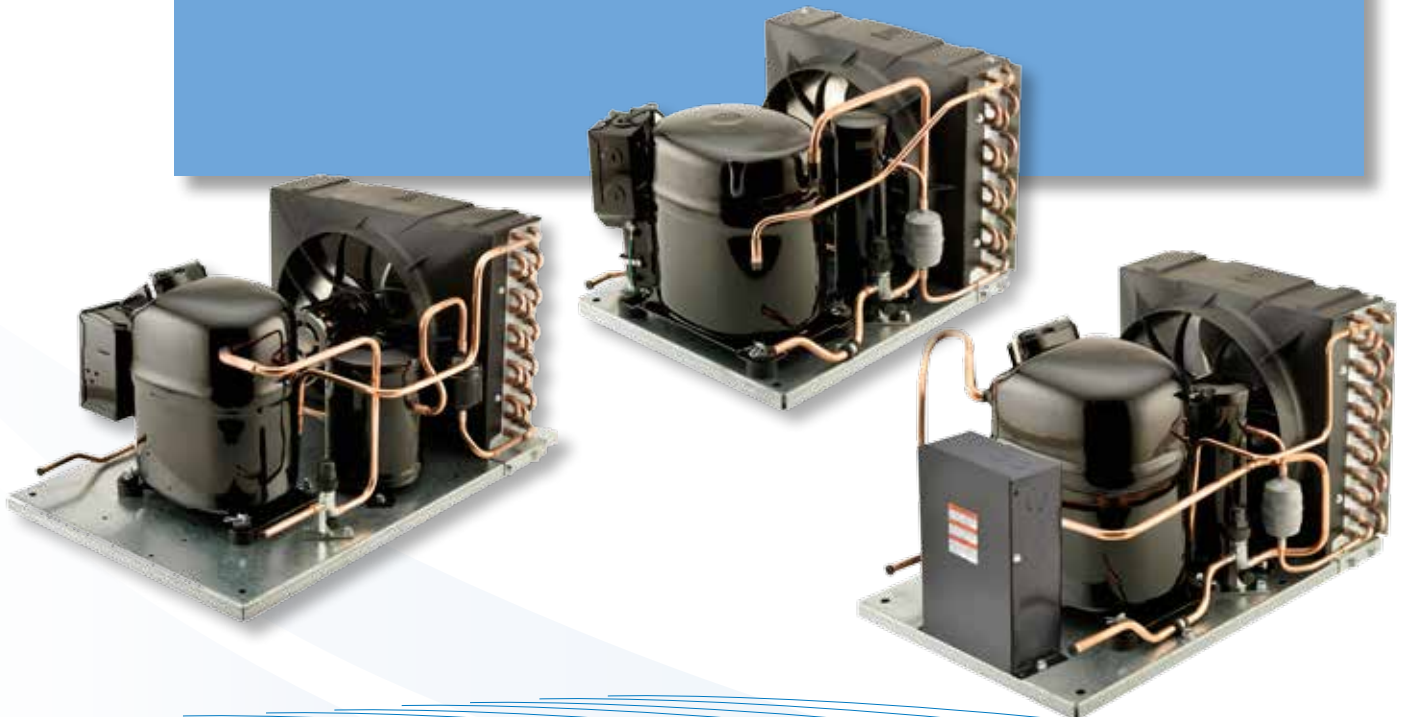

Table of Contents

Introduction	2
Overview	4
Product Marketing	6
Features and Benefits.....	6
Condensing Unit Model Nomenclature	7
Serial Label	7
Condensing Unit Item Number (Bill of Material)	7
Cross Reference AK/AJ Models	8
Celseon AE ² Condensing Units.....	11
Specifications.....	12
Build your Modular Design	13
FAQs	14
More Information	15
Tech Tips	15

CONDENSED KNOWLEDGE.



Tecumseh has the condensing unit to serve your refrigeration needs — from fractional HP indoor, to evaporative condensate, up to large outdoor units. Every Tecumseh condensing unit is designed to deliver reliable cooling under varying loads and operating conditions.

Now that's condensed knowledge.
For more information, visit tecumseh.com



Tecumseh

Looking For a Better Tomorrow™

©2013 Tecumseh Products Company. All Rights Reserved.

OVERVIEW

Why Tecumseh Celseon AK/AJ?

- Tecumseh is a recognized leader in commercial refrigeration. The Tecumseh brand is well known in the industry for reliability and performance, and carries significant contractor loyalty.
- Tecumseh has an established and well positioned North American wholesale distribution network, totaling over 1,700 authorized branch locations throughout the USA, Canada, and Mexico.
- Tecumseh's Celseon condensing units are known for their rugged construction and reliable performance. This means longer life and greater "up time."
- Celseon's modular design accommodates an assortment of Tecumseh compressor models with standardized components and popular option packages. This translates to lower costs, shorter lead times, less inventory, greater flexibility, and improved quality.
- A removable molded fan guard assembly is designed for ease of maintenance and cleaning. Sweat connections, electrical screw terminations, and optional service valves simplify installation and service.
- All units are 100% pressure leak tested. Functional performance tests are also conducted including compressor start, operation of main components, and electrical current draw.
- Tecumseh's web applications (see page 15) provide a wealth of information and tools to assist authorized wholesalers and refrigeration contractors with product selection, heat load calculations, replacement parts look-up and more.
- Tecumseh continues to receive high marks for its prompt and knowledgeable Technical Services team that provides assistance to authorized wholesalers and, refrigeration and air conditioning contractors.

Celseon Product Offering...

Modular Design

- AK/AJ modular units cover a broad capacity range from 1/3 to 1 1/4 HP with fewer models to stock.
- Compact footprint is space efficient. Three (3) base sizes ensure that the footprint is scaled with unit capacity.
- Models are released in refrigerants R134a and R404A, as well as R12, R22, and their replacement blends.
- Sweat connections and electrical screw terminals simplify installation and service to save time and money.
- Removable molded fan guard assembly for ease of maintenance and cleaning.
- Base condensing unit models can be upgraded with options such as power cord, service valves, receiver tank, filter-drier and sight glass.

Optional Features

- High and low side valves allow system isolation for easy installation and servicing.
- Receiver tank is utilized in non-critically charged (expansion valve) systems and aides in system pump down.
- Sight glass is used for charging non-critically charged systems which also include a receiver tank.
- Filter-drier option for applications where proximity to the condensing unit is desirable.

Celseon AK/AJ Exploded View

Small base shown

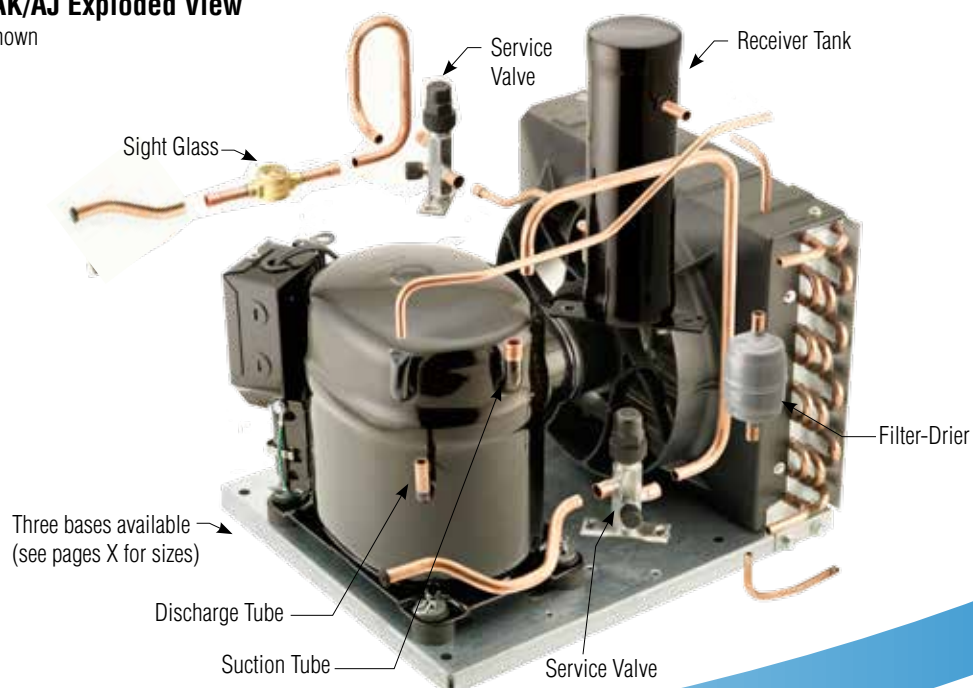

PRODUCT MARKETING

FEATURES AND BENEFITS

• **SPACE EFFICIENT**

Modular design, built on three (3) compact bases that are scaled to unit capacity.

• **FEWER MODELS TO STOCK**

Celseon covers a broad capacity range (models up to 1-1/4 HP) and refrigerant types with popular feature options.

• **MAINTENANCE FRIENDLY**

Removable molded fan guard assembly for ease of maintenance and cleaning.

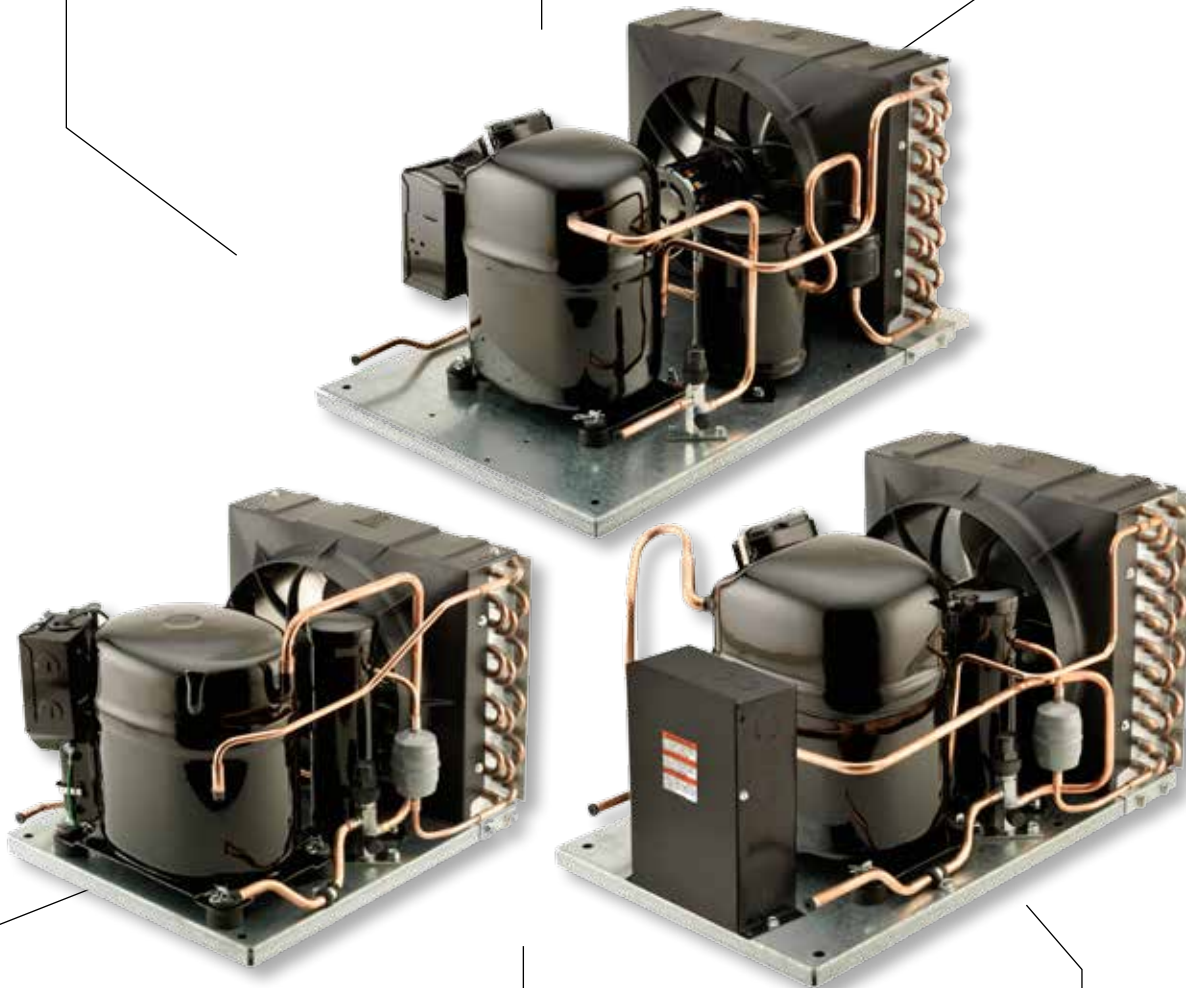

• **SAVES TIME & MONEY**

Sweat connections, electrical screw terminations, and optional service valves simplify installation and service.

• **PROVEN RELIABILITY**

Rugged Tecumseh compressors deliver long life and greater "up time" along with quality components.

• **EFFICIENCY**

Standard higher efficiency PSC condenser fan motor. Improved air flow across the coil. Optional AE² compressor on selected models.

CONDENSING UNIT MODEL NOMENCLATURE

AE² models only **AE 4 457 Y AA 1A DG**
 All other models except AE² **AKA 4 457 Y AA DG**

Family & Generation

AE², AK, AJ Compressor Series

Application Range

4 High +20°F to +55°F (-6.7°C to +12.8°C)
 4 High/Comm (AE² models only)
 9/7 Med/Comm -10°F to +45°F (-23.3°C to +7.2°C)
 2 Low -40°F to +10°F (-40.0°C to -12.2°C)

Capacity

First number is total digits
 Remainder is capacity in Btu/h
 This example 5700 Btu/h Capacity

Refrigerant

Y = R134a Z = R404A E = R22 A = R12

Options

With no power cord:
 A, H, G, J
 With power cord:
 K, S, C, P

Fan Motor/Efficiency

D Permanent Split Capacitor Motor (PSC)

Voltage

AA 115/60/1
 NA 208-230/60/1

Release Variant

SERIAL LABEL

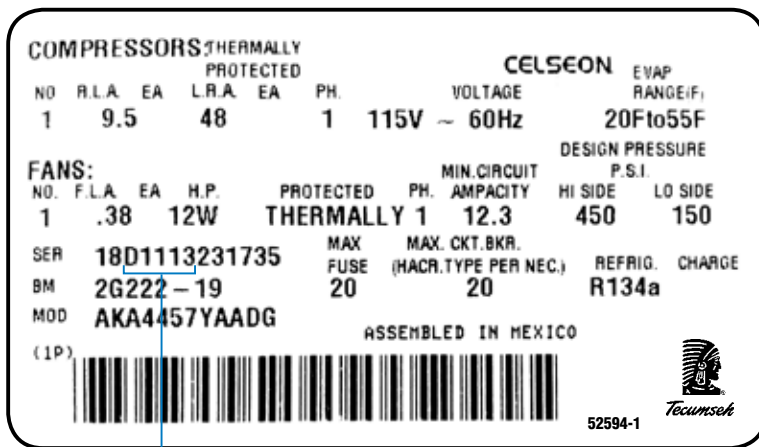

First letter indicates month (see Table 1), next 2 digits indicate day of the month, following 2 digits indicate year.

Table 1

A - January	G - July
B - February	H - August
C - March	J - September
D - April	K - October
E - May	L - November
F - June	M - December

UNIT ITEM NUMBER

(BILL OF MATERIAL)

Select the Bill of Material prefix for Customized Option Configurations.

Bill of Material number prefix: 2G = AK/AJ Celseon

2G*-*9**

Base Item Number (BOM)

Option Codes

Options <u>NO</u> Power Cord	Description	Options <u>with</u> Power Cord
-09	Sweat Connections	-39
-29	Sweat Connections, and Service Valves	-69
-19	Sweat Connections, Service Valves and Receiver Tank	-59
-79	Sweat Connections, Service Valves, Receiver Tank, Filter-Drier and Sight Glass	-89

Use intended for Authorized Wholesalers/OEM customers.

TECUMSEH TO TECUMSEH CROSS REFERENCE

Standard Condensing Unit Model Number	Item Number (Bill of Material)	Celcoseon Condensing Unit Model Number	Item Number (Bill of Material)	HP	Capacity Btu/h	Power Cord	Service Valves	Receiver Tank	Filter Drier	Sight Glass
R22 COMMERCIAL TEMPERATURE										
AKA9433EXAXC	2C232-9	AKA9435EAADG	2G303-19	1/2	3510		X	X		
AKA9433EXAXC	2B298-1	AKA9435EAADG	2G303-19	1/2	3510		X	X		
AKA9433EXAXC*	2D268-1, -9*	AKA9435EAADG	2G303-19	1/2	3510		X	X		
AKA9433EXAXB	2C247-1, -9	AKA9435EAADC	2G303-59	1/2	3510	X	X	X		
AKA9433EXAXA	2E212-1	AKA9435EAADS	2G303-69	1/2	3510	X	X			
AKA9433EXDXC	2C233-9	AKA9435ENADG	2G304-19	1/2	3510		X	X		
AKA9446EXAXC	2C234-9	AKA9446EAADG	2G214-19	1/2	4600		X	X		
AKA9446EXAXE*	2D265-1, -9*	AKA9446EAADG	2G214-19	1/2	4600		X	X		
AKA9446EXAXA	2C204-1	AKA9446EAADH	2G214-29	1/2	4600		X			
AKA9446EXAXD	2E237-9	AKA9446EAADH	2G214-29	1/2	4600		X			
AKA9446EXDXC	2C235-9	AKA9446ENADG	2G215-19	1/2	4600		X	X		
AKA9446EXDXE	2D264-9	AKA9446ENADG	2G215-19	1/2	4600		X	X		
AKA9461EXDXC	2B717-1	AKA9461ENADG	2G716-19	3/4	6100		X	X		
AKA9461EXDXC	2B725-1, -9	AKA9461ENADG	2G716-19	3/4	6100		X	X		
AKA9461EXDXE*	2B759-1, -9*	AKA9461ENADG	2G716-19	3/4	6100		X	X		
AKA9470EXDXC	2A1180-1	AKA9470ENADG	2G719-19	3/4	7000		X	X		
AKA9470EXDXC	2A1185-1, -9	AKA9470ENADG	2G719-19	3/4	7000		X	X		
AKA9470EXDXE*	2A1199-1, -9*	AKA9470ENADG	2G719-19	3/4	7000		X	X		
AKA9470EXDXD	2A1181-1	AKA9470ENADH	2G719-29	3/4	7000		X			
AJA9486EXDXC	2A1183-1, -9	AJA9486ENADG	2G1002-19	1	8600		X	X		
AJA9486EXDXE*	2A1198-1, -9*	AJA9486ENADG	2G1002-19	1	8600		X	X		
R404A COMMERCIAL TEMPERATURE										
AKA9429ZXAXC	2D351-1, -9	AKA9430ZAADG	2G301-19	1/3	3091		X	X		
AKA9429ZXAXC	2E366-1, -4	AKA9430ZAADG	2G301-19	1/3	3091		X	X		
AKA9429ZXAXC	2E370-1	AKA9430ZAADG	2G301-19	1/3	3091		X	X		
AKA9429ZXAXK*	2E371-1*	AKA9430ZAADG	2G301-19	1/3	3091		X	X		
AKA9429ZDXC	2D377-1	AKA9430ZNADG	2G302-19	1/3	3091		X	X		
AKA9440ZXAXC	2E279-1	AKA9442ZAADG	2G212-19	1/2	4237		X	X		
AKA9440ZXAXC	2E280-1	AKA9442ZAADG	2G212-19	1/2	4237		X	X		
AKA9440ZXAXK	2E281-1	AKA9442ZAADG	2G212-19	1/2	4237		X	X		
AKA9440ZXAXC	2D291-1	AKA9442ZAADG	2G212-19	1/2	4237		X	X		
AKA9440ZDXC	2D292-1	AKA9442ZNADG	2G213-19	1/2	4237		X	X		
AKA9440ZDXC	2T292-1	AKA9442ZNADJ	2G213-79	1/2	4237		X	X	X	X
AKA9460ZDXC	2B776-1, -9	AKA9457ZNADG	2G715-19	1/2	5709		X	X		
AKA9460ZDXC	2C738-1	AKA9457ZNADG	2G715-19	1/2	5709		X	X		
AKA9463ZXAXC*	2B788-1*	AKA9463ZAADG	2G717-19	3/4	6360		X	X		
AKA9463ZXAXC	2B788-2	AKA9463ZAADG	2G717-19	3/4	6360		X	X		
AKA9463ZDXC	2B777-1 -4	AKA9463ZNADG	2G718-19	3/4	6360		X	X		
AKA9463ZDXC	2C735-1	AKA9463ZNADG	2G718-19	3/4	6360		X	X		
AKA9463ZXAXC*	32T777-1*	AKA9463ZNADG	2G718-19	3/4	6360		X	X		
AKA9463ZDXC	2T777-2	AKA9463ZNADJ	2G718-79	3/4	6360		X	X	X	X

* Standard condensing unit included a low pressure control (Part Number 84026-2) and the cross model does not. Low pressure controls can be shipped loose.

TECUMSEH TO TECUMSEH CROSS REFERENCE (continued)

Standard Condensing Unit Model Number	Item Number (Bill of Material)	Celsoon Condensing Unit Model Number	Item Number (Bill of Material)	HP	Capacity Btu/h	Power Cord	Service Valves	Receiver Tank	Filter Drier	Sight Glass
R134a HIGH TEMPERATURE										
AKA4460YXAXC	2C242-1, -9	AKA4457YAADG	2G222-19	1/2	5606		X	X		
AKA4460YXAXC	2C238-1	AKA4457YAADG	2G222-19	1/2	5606		X	X		
AKA4460YXAXA	2D214-1	AKA4457YAADK	2G222-39	1/2	5606	X				
AKA4460YXAXB	2C241-1, -9	AKA4457YAADC	2G222-59	1/2	5606	X	X	X		
AKA4460YXAXB	2C237-1	AKA4457YAADC	2G222-59	1/2	5606	X	X	X		
AKA4460YXAXA	2C236-1	AKA4457YAADS	2G222-69	1/2	5606	X	X			
AKA4460YXDXC	2D226-1, -9	AKA4457YNADG	2G223-19	1/2	5606		X	X		
AKA4476YXAXC	2C294-1, -9	AKA4472YAADG	2G731-19	1/2	7200		X	X		
AKA4476YXAXA	2C292-1	AKA4472YAADH	2G731-29	1/2	7200		X			
AKA4476YXAXD	2C295-1, -4	AKA4472YAADH	2G731-29	1/2	7200		X			
AKA4476YXAXB	2B293-1	AKA4472YAADC	2G731-59	1/2	7200	X	X	X		
AKA4476YXDXC	2D232-1, -9	AKA4472YNADG	2G732-19	1/2	7200		X	X		
AKA4476YXDXA	2D230-1	AKA4472YNADH	2G732-29	1/2	7200		X			
AJA4492YXAXC	2B728-1, -9	AJA4492YAADG**	2G733-19	3/4	8070		X	X		
AJA4492YXAXC	2C727-1	AJA4492YAADG**	2G733-19	3/4	8070		X	X		
AJA4492YXAXD	2B731-1, -2	AJA4492YAADH**	2G733-29	3/4	8070		X			
AJA4492YXDxD	2B732-3	AJA4492YNADA**	2G734-09	3/4	8070		X			
AJA4492YXDXC	2B726-1, -9	AJA4492YNADG**	2G734-19	3/4	8070		X	X		
AJA4492YXDxD	2B727-1	AJA4492YNADH**	2G734-29	3/4	8070		X			
AJA4512YXDXC	2A1193-1, 9	AJA4512YNADG**	2G1021-19	1	12200		X	X		
AJA4512YXDxD	2A1194-1	AJA4512YNADG**	2G1021-19	1	12200		X	X		
R12 HIGH TEMPERATURE										
AJA4461AXAXC	2B216-9	AJA4456AAADG	2G220-19	1/2	5675		X	X		
AJA4461AXAXB	2A276-9	AJA4456AAADC	2G220-59	1/2	5675	X	X	X		
AJA4461AXDXC	2B223-9	AJA4456ANADG	2G221-19	1/2	5675		X	X		
AJA4492AXAXC	2A750-9	AJA4488AAADG	2G737-19	3/4	8800		X	X		
AJA4492AXDXC	2A757-9	AJA4488ANADG	2G738-19	3/4	8800		X	X		
AJA4512AXDXC	2A1129-9	AJA4512ANADG	2G1020-19	1	11700		X	X		
R134a MEDIUM TEMPERATURE										
AKA7437YXAXC	2C287-1	AKA7437YAADG	2G209-19	1/2	3677		X	X		
AJA7465YXAXE*	2B729-1, -9*	AJA7455YAADG	2G710-19	3/4	5540		X	X		
AJA7465YXAXG	2B760-2, -4	AJA7455YAADC	2G710-59	3/4	5540	X	X	X		
AJA7465YXDxE*	2B730-1, -9*	AJA7455YNADG	2G711-19	3/4	5540		X	X		
R404A MEDIUM TEMPERATURE										
AJA7480ZXDXC	2B1102-1, -9	AJA7480ZNADG	2G1010-19	1	7940		X	X		
AJA7480ZXDXC	2T, 32T1102-1	AJA7480ZLNADJ	2G1010-79	1	7940		X	X	X	X
R12 MEDIUM TEMPERATURE										
AJA7441AXAXC	2B218-8, -9	AJA7444AAADG	2G210-19	1/2	4400		X	X		
AJA7441AXDXC	2B225-9	AJA7444ANADG	2G211-19	1/2	4400		X	X		
AJA7465AXAXE*	2B714-9*	AJA7465AAADG	2G712-19	3/4	6560		X	X		
AJB7465AXDxE*	2B715-9*	AJB7465ANADG	2G713-19	3/4	6560		X	X		

* Standard condensing unit included a low pressure control (Part Number 84026-2) and the cross model does not. Low pressure controls can be shipped loose.

** Models currently under development.

TECUMSEH TO TECUMSEH CROSS REFERENCE (continued)

Standard Condensing Unit Model Number	Item Number (Bill of Material)	Celseon Condensing Unit Model Number	Item Number (Bill of Material)	HP	Capacity Btu/h	Power Cord	Service Valves	Receiver Tank	Filter Drier	Sight Glass
R404A LOW TEMPERATURE										
AJA2422ZXAXA	2E205-1, -9	AJA2423ZAADA	2G202-09	1/2	2254		X			
AJA2422ZXAXC	2D253-1, -9, -4	AJA2423ZAADG	2G202-19	1/2	2254		X	X		
AJA2422ZXAXB	2D256-1, -9	AJA2423ZAADC	2G202-59	1/2	2254	X	X	X		
AJA2422ZXAXA	2D252-1, -3	AJA2423ZAADS	2G202-69	1/2	2254	X	X			
AJA2429ZXAXD	2D263-1	AKA2430ZAADH	2G739-29	3/4	3000		X			
AJA2429ZXAXB	2D275-1, -9	AKA2430ZAADC	2G739-59	3/4	3000	X	X	X		
AJA2429ZXAXA	2D262-1, -9	AKA2430ZAADS	2G739-69	3/4	3000	X	X			
AJB2441ZXAXC	2B1132-44	AJB2439ZAADG	2G701-19	1	3926		X	X		
AJB2450ZDXC	2B1134-44	AJB2447ZNADG	2G1001-19	1-1/4	3926					
AJB2450ZDXC	2B1134-44	AJB2447ZNADG	2G1001-19	1-1/4	3926					
R134A LOW TEMPERATURE										
AJA2422YXAXA	2C296-1	AJA2423YAADS	2G201-69	1/2	2780		X	X		
AJA2422YXAXA	2C298-1	AJA2423YAADG	2G201-19	1/2	2780	X	X	X		
R22 LOW TEMPERATURE										
AJA2425AXAXC	2B217-9	AJA2427AAADG	2G203-19	3/4	2780		X	X		
AJA2425AXAXB	2A275-9	AJA2427AAADC	2G203-59	3/4	2780	X	X	X		
AJA2425AXDXC	2B221-9	AJA2427ANADG	2G204-19	3/4	2780		X	X		

* Standard condensing unit included a low pressure control (Part Number 84026-2) and the cross model does not. Low pressure controls can be shipped loose.

CELSEON AE² CONDENSING UNITS - FIRST MODELS RELEASED



Listed in the table below are the initial Celseon condensing units that have been released using AE² compressors. These AE² models provide cooling capacities comparable to some AK or AJ condensing units but in a physically smaller package. The same AE² compressor housings, tubing sizes and orientations will be used for both OEM and wholesale compressors and condensing units. This allows the use of a single compressor housing configuration, simplifying installation and replacement.

Model Number	Item Number (Bill of Material)	HP	Capacity (Btu/h)	Refrigerant	Application
AE2425Z-AA3CD**	2G740-**	3/4	TBD	R404A	LBP
AE4450Y-AA1AD**	2G224-**	1/2	TBD	R134a	H/CBP
AE4450Z-AA1AD**	2G225-**	1/2	TBD	R404A	H/CBP
AE4456Y-AA1CD**	2G226-**	1/2	TBD	R134a	H/CBP
AE4460Y-AA3CD**	2G227-**	1/2	TBD	R134a	H/CBP
AE4470Z-AA3CD**	2G229-**	1/2	TBD	R404A	H/CBP

**Available option codes

UNIT ITEM NUMBER (BILL OF MATERIAL)

Select the Bill of Material prefix for Customized Option Configurations.

Bill of Material number prefix: 2G = AK, AJ, AE² Celseon

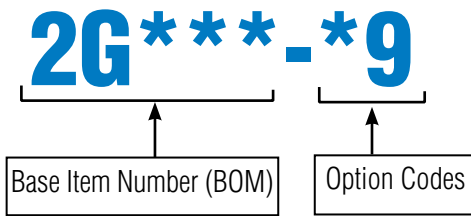

Options <u>NO</u> Power Cord	Description	Options <u>with</u> Power Cord
-09	Sweat Connections	-39
-29	Sweat Connections, and Service Valves	-69
-19	Sweat Connections, Service Valves and Receiver Tank	-59
-79	Sweat Connections, Service Valves, Receiver Tank, Filter-Drier and Sight Glass	-89

SPECIFICATIONS

Product

Models:	High/Comm. Temperature	1/2 to 1 HP (5 AE ² models, 12 AK/AJ models)
	Med./ Comm. Temperature	1/3 to 1 HP (23 AK/AJ models)
	Low Temperature:	1/2 to 1-1/4 HP (1 AE ² model, 7 AK/AJ models)
Evaporating Ranges:	High Temperature:	+20°F to +55°F (-6.7°C to +12.8°C)
	Med./Comm. Temperature:	-10°F to +45°F (-23.3°C to +7.2°C)
	Low Temperature:	-40°F to +10°F (-40.0°C to -12.2°C)
Ambient Operating Temperature:	Rated at	90°F (32.2°C)
	Range:	80°F (26.6C) to 110°F (43.3°C)

Materials

Steel Valves:	Steel, Base Mounted with Copper Sweat Connections Replacement P/N: 3/8 ODF 56630		
Receiver:	Steel, Base Mounted with Copper Sweat Connections		
	Replacement P/N:	510-10000	510-10002
	Height:	9.0 in (229 mm)	7.0 in (178 mm)
	Diameter:	2.5 in (64 mm)	5.0 in (127 mm)
	Internal Capacity:	37 in ³ (606 cm ³)	128 in ³ (1999 cm ³)
Base Plate:	Cold Rolled Steel 16 Ga. Galvanized G90u		
Refrigerant and Oil:	Refrigerant	Oil Type	
	R134a, R404A R12, R22 compatible	Polyolester (POE) Synthetic Alkylate (AB)	
Fan Guard:	Polypropylene – Replacement P/N: Small 707-00004		
	Medium 707-00005		
	Large 707-00002		
Fan Blade:	Aluminum – Replacement P/N: 515-10002: 12W		
	515-10003: 35W		
	515-10001: 50W		
Fan Motor (PSC): (Permanent Split Capacitor)	810-10001: 12W 115V	810-10000: 12W 230V	
	810-10003: 35W 115V	810-10002: 35W 230V	
	810-10004: 50W 115V	810-10041: 50W 230V	
Condenser:	Copper Tube and Aluminum Fin		Width x Height
	Replacement P/N: Small 506-10004	3-row 13 in	10.2 in
	Medium 506-10008	4-row 13 in	11.3 in
	Large 506-00002	3-row 17 in	12.4 in
Electrical Cord:	Length: 42 inches (1066 mm)		
	Replacement P/N: 85106-14: 115V; 85259-5: 230V		

Dimensions

	Length	Width	Height
Small:	15 in (381 mm)	14 in (356 mm)	11.7 in (297 mm)
Medium:	20 in (508 mm)	14.3 in (363 mm)	12.2 in (310 mm)
Large:	24 in (609 mm)	17.6 in (447 mm)	13.4 in (340 mm)

Suction Line Sweat Connection:	3/8 inch (9.5 mm) ODF - All units and all options
Liquid Line Sweat Connection:	1/4 inch (6.3 mm) ODF - Base unit only (Sm + Med) 3/8 in all other size and options

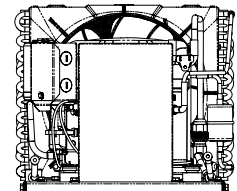
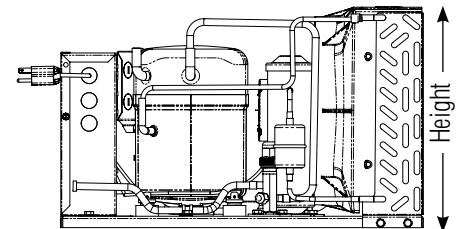
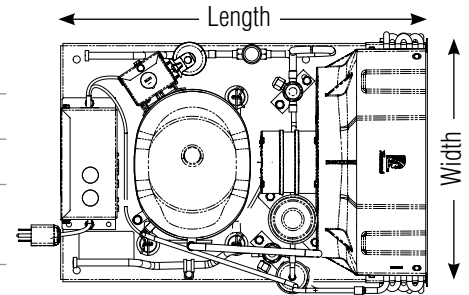
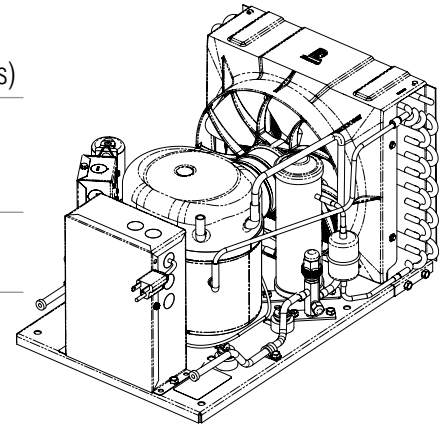

Agency Approval

Celsoen Condensing units are in compliance with US and Canadian safety agency requirements. The cUfus file number is SA2372.

BUILD YOUR MODULAR DESIGN

APPLICATIONS

- High/Commercial, Commercial/Medium and Low Temperatures
- R134a: 1/3 to 1 HP
- R404A: 1/3 to 1-1/4 HP
- R22: 1/2 to 1 HP
- R12: 1/2 to 1 HP



STEP 1: Small, Medium or Large Base

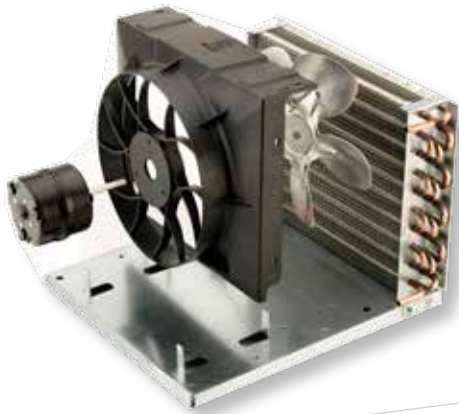

STEP 2: AK, AJ or AE² Compressor



Condensing Unit Model Number Available Options

- Options **without** a power cord:
 - A** Sweat Connections
 - H** Sweat Connections and Service Valves
 - G** Sweat Connections, Service Valves and Receiver Tank
 - J** Sweat Connections, Service Valves, Receiver Tank, Filter-Drier and Sight Glass
- Options **with** a power cord:
 - K** Sweat Connections
 - S** Sweat Connections and Service Valves
 - C** Sweat Connections, Service Valves and Receiver Tank
 - P** Sweat Connections, Service Valves, Receiver Tank, Filter-Drier and Sight Glass

STEP 3: Options Available

Sweat Connections are standard.



Options: H / S



Options: G / C



Options: J / P

FAQs

- Q** How can I identify a Tecumseh Celseon AK/AJ indoor air-cooled condensing unit?
A **The item number/bill of material number will begin with “2G”.**
- Q** How many Celseon AK/AJ indoor unit base sizes are available?
A **There are three (3) available base sizes. See pages 12 for dimensions.**
- Q** What is the capacity range for the...
A **Models are available ranging from 1/3 to 1-1/4 HP, compatible with refrigerants R404A, R134a, R12 and R22.**
- Q** Is a replacement parts list available for Celseon AK/AJ units?
A **Yes. A replacement parts list is available and will be uploaded to our website in June 2013.**
- Q** Where can I find Celseon AK/AJ indoor condensing unit technical data sheets?
A **Tecumseh has web applications available for your information at <http://boxload.tecumseh.com/>**
- Q** Are there any changes to the way I process warranty returns?
A **No, the Wholesale Warranty and Return Process remains unchanged.**
- Q** Can I purchase an Celseon AK/AJ as part of the 2013 Big Chill² program?
A **Yes. All Celseon AK/AJ models are included in the promotion.**
- Q** Will I receive a new price list and/or a price quote?
A **Yes. An updated price list has been sent to all authorized wholesalers’ designated contact(s) as part of our Big Chill² promotion. Updated OEM price quotes will be issued by the end of June 2013.**
- Q** Celseon AK/AJ indoor units are Agency Approval Compliant?
A **Yes. AK/AJ indoor units are in compliance with both Canadian and U.S. requirements. The UL file number is SA2372.**
- Q** Does the Celseon AK/AJ have a Pressure Control option?
A **No, but it is under consideration for future development as an assembled option. Pressure controls are available as a loose component or accessory. Legacy units with mounted pressure controls will remain in the product line.**
- Q** Is Celseon AK/AJ compatible with EC (electronically commutated) Motors?
A **Yes. Availability of a high efficiency EC motor option is under development and will be announced at a later date.**
- Q** Are compressor families other than AK and AJ applied to the Celseon AK/AJ condensing units?
A **Yes. The all new high efficiency AE² compressor is being applied in its extended capacities in both R134a and R404A.**
- Q** Will you be updating the current Celseon condensing unit product catalog to include the extended range of AE2, AK and AJ condensing units?
A **Yes, we are developing a Celseon Fractional HP Indoor Condensing Unit product catalog that will include all Tecumseh indoor condensing units with capacities ranging from 1/3 to 1-1/4 HP.**
- Q** How do Celseon AK/AJ condensing units compare in size to the legacy AK/AJ condensing units?
A **Celseon AK/AJ units have the same footprint and overall height as legacy AK/AJ condensing units.**
- Q** Are replacement parts readily available for Tecumseh’s new Celseon AK/AJ condensing units?
A **Yes, we are currently stocking a supply of Celseon AK/AJ condensing unit replacement parts at our distribution center in Tupelo, Mississippi.**

TECH TIPS

Tecumseh has developed a number of tools to help you sell.

Website: www.tecumseh.com

Tecumseh's portal to the world, the website offers product information, compressor data sheets, wholesaler location lookup, basic cross-referencing and a library filled with marketing brochures/catalogs, application bulletins and more.

Tecumseh Web Applications

A suite of online web application tools that eliminates the guess work. Site includes product and component look up, cross reference tools, drawings, along with performance data. Analytical tools are also available for use including, refrigerant line sizing and calculating box (heat) load requirements. Go to the website at, <http://boxload.tecumseh.com/>

Online Literature

Tecumseh's online literature portal, located under the "Library" tab of www.tecumseh.com, provides downloadable and searchable PDF versions of all catalogs, brochures and reference booklets produced.

Mobile Tech to Go

These apps are the electronic version of Tecumseh's Electrical Service Parts & Cross Reference tools. For iPhone®/iPad® and Android® devices.



iPhone/iPad

<https://itunes.apple.com/us/app/tecumseh/id502258181?mt=8>



Android Device

<https://play.google.com/store/apps/details?id=com.logic.tecumseh>



Tecumseh Web Applications

[Box Load Program](#) [Capillary Tube Sizing Program](#)
[Condensing Unit Data Sheets](#) [Evaporator Coil Data Sheets](#)
[Electrical Service Parts Guidebook](#) [Competitive Cross Reference](#)
[Condensing Unit Fast Reference](#) [Compressor Fast Reference](#)
[Part Number Fast Reference](#) [Refrigerant TP-PT Chart](#)
[Compressor Performance Data](#) [Condensing Unit Performance Data](#)
[System Analyzer](#) [Refrigerant Line Sizing](#)
[3-Phase Voltage Imbalance Calculator](#) [Compressor Housing Drawings](#)
[Units of Measurement Converter](#)



TECUMSEH NORTH AMERICA

SALES AND MARKETING

5683 Hines Drive
Ann Arbor, MI 48108

tecumsehusa@tecumseh.com
Tel. 734.585.9500

TECHNICAL SERVICES

5683 Hines Drive
Ann Arbor, MI 48108

technical.service@tecumseh.com
Tel. 800.211.3427

For more information on products by Tecumseh,
please visit our website www.tecumseh.com



Tecumseh