

# ***DRIVING CENTRIFUGAL COMPRESSOR TECHNOLOGY***

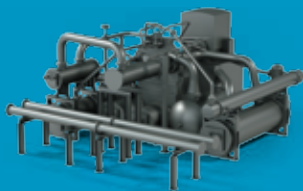

Atlas Copco Gas and Process Solutions

---

*Atlas Copco*

---



**Editor-in-Chief:**

Patrick Kessler – Cologne, Germany  
Marketing Communications  
Atlas Copco Gas and Process Division

**Concept, Design, Text:**

Brains & Hearts – Munich, Germany

**Photo Material:**

Hans Herbig, Olaf Nickel, Image on page 9: © Linde,  
Image on page 27: © John Crane Group Corporation,  
Atlas Copco Gas and Process Marketing Communications

**Print:**

Welzel + Hardt GmbH – Wesseling, Germany

Printed in Germany – 2016

© Atlas Copco Gas and Process Division, Atlas Copco Energas GmbH  
Schlehenweg 15, 50999 Cologne, Germany  
Phone: +49 2236 96 50 0  
atlascopco.energass@de.atlascopco.com  
www.atlascopco-gap.com

- 04 Driving Centrifugal Compressor Technology
- 06 Integrally-Geared Compressors:  
Covering the Full Application Spectrum
- 08 Industrial Gases
- 10 Oil and Gas (Midstream)
- 12 Chemical / Petrochemical
- 14 Power Generation
- 16 The Extra Edge for Your Process:  
Integral Gear Technology
- 20 Driving Your Process: Our Impellers
- 24 Controlling Your Capacity:  
Our IGV and DGV Options
- 26 Shielding Your Process: Our Seal Options
- 28 Our Packaging Options
- 30 Committed to Sustainable Quality
- 32 Proven Engineering Expertise
- 34 Production Know-How Around the Globe
- 36 Testing Your Machine
- 38 Building to API Specifications
- 42 Features of Our Turbocompressor Products
- 44 Product and Applications at a Glance
- 48 Our Products for Your Market
- 50 A Truly Global Operation

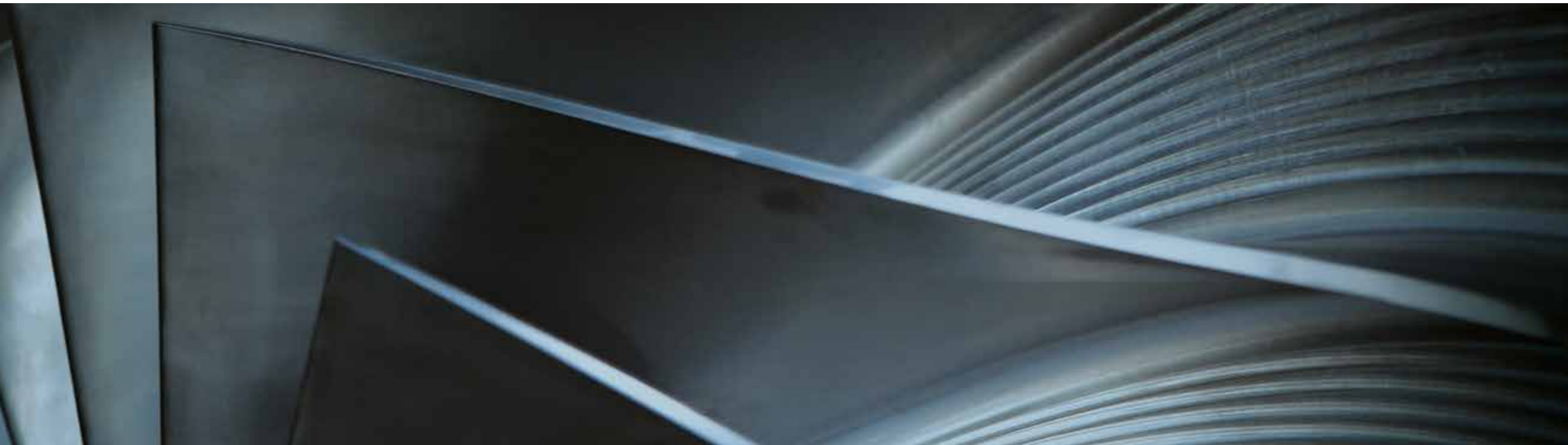

**Integral Gear Technology Offers You:**

- Customization options that improve your process
- Shorter installation and commissioning times
- Maximum compressor efficiency
- Maximum reliability
- Power savings
- Compact and lean design

## Driving Centrifugal Compressor Technology

Over the past century, Atlas Copco has built close relationships with customers around the globe. In doing so, we have pursued one goal: providing our customers with sustainable productivity, regardless of process, application, or market. Integral Gear Technology – the concept that drives our centrifugal compressors – is what allows us to consistently achieve this goal.

### The Entire Range of Solutions

Integral Gear Technology is the forward-looking expertise that makes our turbocompressors first-in-class. It's a market-leading innovation and the result of decades of development.

A uniquely versatile and cost-efficient solution, this technology allows for multi-staging, enabling up to eight stages to be included on one gearbox.

And that's not all. We also offer a complete range of multi-stage expander / compressor / generator solutions. Moreover, our compressor design supports API specifications.

### Compact Design, Efficient Operation

Our centrifugal compressors feature a very compact design. This greatly reduces your on-site footprint, especially in marine and offshore settings.

By providing a range of customization possibilities, we can also focus on your precise needs. Our options include diverse impeller designs and variable diffusers, to name just a few.

Energy efficiency – with a focus on power optimization – is a key area we emphasize. The goal: to ensure an optimum process for you.

### Our Compressor Range

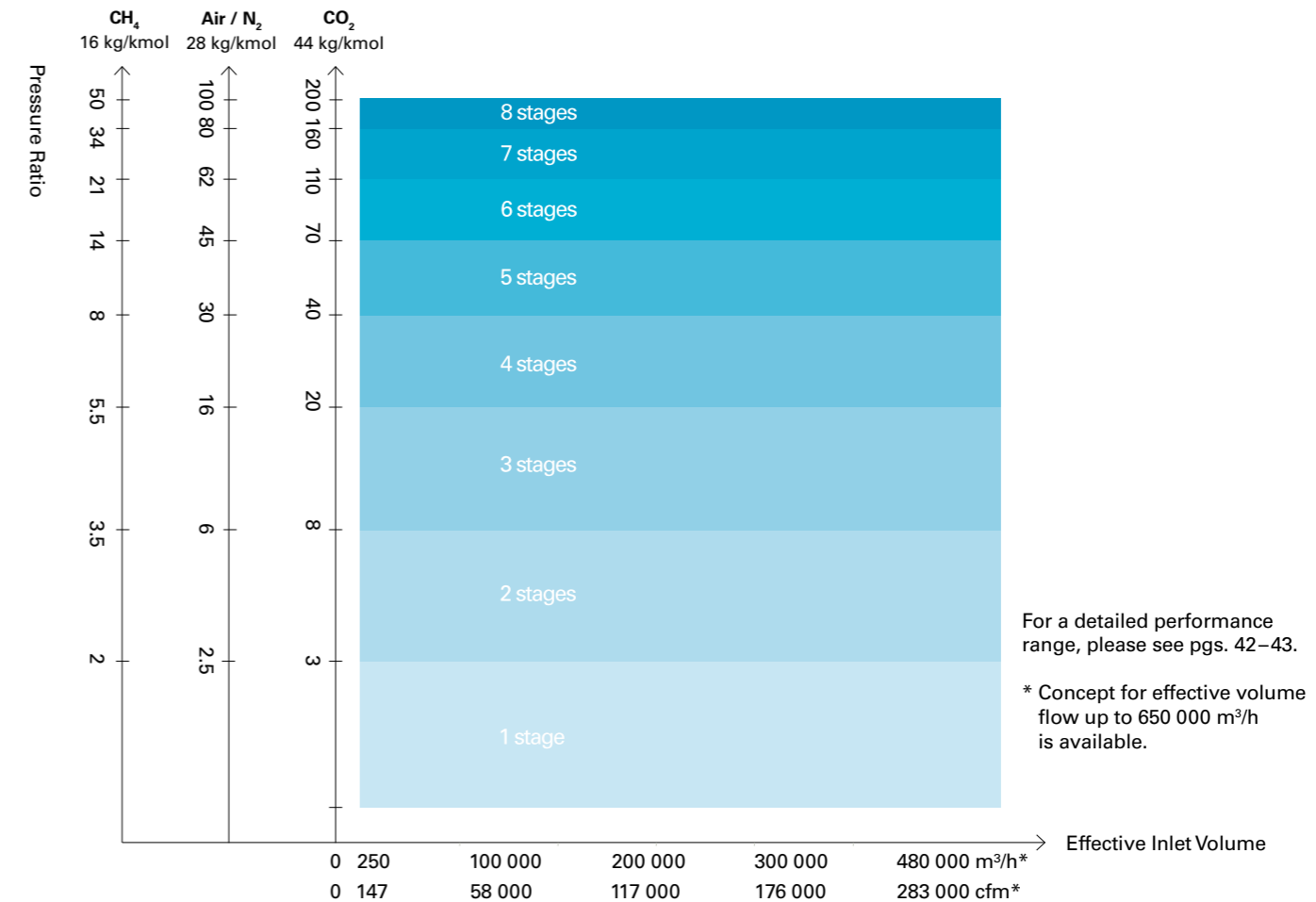

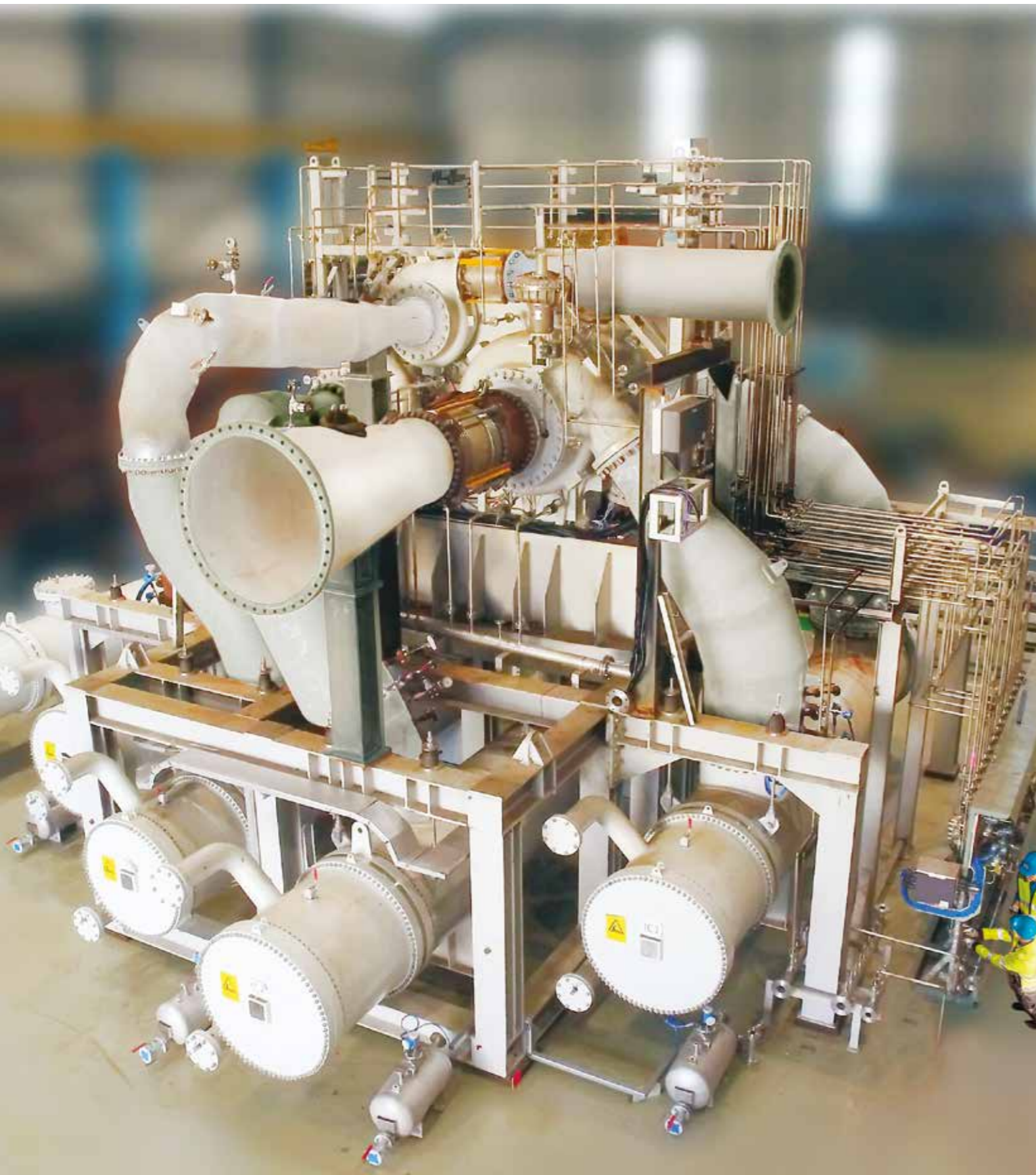

## Integrally-Gear Compressors: Covering the Full Application Spectrum

For an ever growing number of applications, integrally-gear compressors provide the most efficient, space-saving and reliable solution possible. It's no wonder that the compressors have become vital parts of numerous processes.

### Backed by a History of Advancements

Through decades of intensive development, integral gear technology has grown from a cutting-edge technology into a mainstay in nearly every compressor application imaginable.

And there are good reasons why. Integrally-gear compressors are more compact and efficient than comparable single-shaft designs and they afford a level of process control that other technologies can't match.

Each compression stage is specifically optimized to run at its optimum speed. The result: greater pressure ratios in a smaller footprint with significantly less energy expenditure.

### A World of Process Possibilities

Integrally-gear compressors run at the heart of vital applications extending from LNG vessels on the high seas to complex compression requirements in petrochemical plants. Our machines are at home in air separation plants, at power facilities, in applications across the entire LNG value chain as well as in numerous related downstream processes.

### A Wide Range of Applications:

- Fuel gas boosting
- Plant & Instrument air
- Main and booster air / booster N<sub>2</sub>
- NGL recovery / gas processing
- Olefins / polyolefins
- Hydrogen / HyCO
- Fertilizers, including ammonia, urea, nitric acid, melamine
- High-pressure CO<sub>2</sub> for urea and supercritical power cycles
- Numerous other application with thousands of references around the world



### Carbon Capture Storage (CCS)

Atlas Copco turbocompressors are employed in carbon capture storage (CCS), a new and promising technology. Integrated into different processes (such as Oxyfuel), CCS allows CO<sub>2</sub> to be captured directly at the source instead of being released into the atmosphere.

The CO<sub>2</sub> is then transported to a predetermined location – either underground or underwater – where it is safely stored. By placing CO<sub>2</sub> under high pressure, it can be saved in reservoirs to help mitigate carbon emissions.

### Industrial Gas Applications

Application	No. of stages	Discharge pressure bar (PSI)	Effective inlet flow m <sup>3</sup> /h (cfm)
Air compressor	2–6	35 (507)	3 500–480 000* (2 100–283 000)
Booster compressor	1–6	80 (1 160)	2 500–80 000 (1 500–47 000)
Oxygen	1–5	32 (464)	3 000–16 000 (1 800–9 000)
Combined service	up to 8	150 (2 175)	30 000–400 000 (18 000–235 000)

\* Design for effective volume flow up to 650 000 m<sup>3</sup>/h is available.

## Industrial Gases

Industrial-gas technology may have originated over a century ago, but it remains a key growth market in many of today’s global industries. That’s precisely where Atlas Copco air compressors can be found – providing a whole host of solutions for the industrial gas industry.

### Air Separation

We offer a range of customer-centric products, including Main Air, Booster Air / N<sub>2</sub> and oxygen compressors, as well as our expansion turbine options.

Thanks to our wide range of options, we can customize the industrial-gas compressor you choose to meet your precise needs.

Atlas Copco Gas and Process machines serve air-separation applications in numerous sectors, such as the steel, chemical / petrochemical, electronics, gas to liquids (GTL) / syngas / CO and microprocessor industries.



A compressor for nitrogen service



Atlas Copco builds air compressors with flow ranges up to 480 000 m<sup>3</sup>/h.



The growing HyCO market produces chemical feedstock gases and syngas. Photo: © Linde AG

# Oil and Gas (Midstream)

Atlas Copco Gas and Process turbocompressors reliably support every process in the oil and gas midstream industry – whether it’s on land or at sea.

Natural gas is an important energy source around the world, meeting up to one-third of global energy needs. In an industry that spans oceans and continents, reliability, energy savings and safety are key requirements. They also drive this dynamic industry, and this is exactly where Atlas Copco Gas and Process’ compressors and expanders come into play. From FLNG to FSRU – we provide customized and standardized machinery that supports every link in the midstream value chain, while maximizing performance and dependability.

## Robust and Efficient Midstream Operations



Because a large portion of your investment comes from turbomachinery equipment and power costs, reliability and efficiency are critical factors for your midstream operation. With more than four decades of experience, Atlas Copco Gas and Process has delivered robust and efficient compressors and expanders to the midstream sector, time and again.

## Adding Value

One appeal of natural gas lies in commodity products – such as ethane, butane or propane – which are used in many downstream chemical and petrochemical processes. Atlas Copco Gas and Process compressors will enable you to efficiently and consistently gain maximum value from your natural gas liquids (NGL) process.

## Safe Processing

With vast experience in the midstream industry, our compressors and expanders have a strong track record of safe and efficient operation across an extensive reference list.

FLNG	Carrier LNG	NGL / Gas Processing	NGL Fractionation / LPG	Onshore LNG
 <ul style="list-style-type: none"> <li>• Regeneration gas</li> <li>• Instrument air</li> <li>• Boil-off gas</li> <li>• Vapor return blower</li> </ul>	 <ul style="list-style-type: none"> <li>• Propulsion fuel gas supply system</li> <li>• Partial reliquefaction-system</li> <li>• Boil-off gas</li> <li>• Compander™</li> </ul>	 <ul style="list-style-type: none"> <li>• Inlet / feed gas</li> <li>• Refrigeration</li> <li>• Regeneration gas</li> <li>• Residue / sales gas</li> </ul>	 <ul style="list-style-type: none"> <li>• Refrigeration</li> <li>• Boil-off gas</li> </ul>	 <ul style="list-style-type: none"> <li><b>Small-Scale LNG</b></li> <li>• Nitrogen</li> <li>• Compander™</li> <li>• Mixed refrigeration</li> <li><b>Large-Scale LNG</b></li> <li>• Boil-off gas</li> <li>• Regeneration gas</li> <li>• Process gas</li> </ul>





## Chemical / Petrochemical

Chemical / Petrochemical is a key downstream segment. This is where added value is generated as hydrocarbons are processed and refined. Thanks to our extensive experience, we're a reliable, trusted partner in this crucial sector.

The chemical / petrochemical segment is one of the most complex industries. Given its demanding processes, reliability and safety are all-important.

Those are only two of the concerns we focus on as we supply centrifugal gas and air compressor solutions to a broad range of chemical / petrochemical processes – everything from traditional applications, such as ethylene and propylene manufacturing, to the production of aromatics and ammonia, to syngas operations.

### Plant Air: A Vital Driver

As in other sectors, a reliable supply of air to plant equipment is vital if Chemical / Petrochemical players are to operate successfully.

Their equipment must work well, first and foremost. In addition, it must comply with any and all with industrial standards, like those of the American Petroleum Institute (API).

That's a demanding range of challenges. And we're proud to help our customers meet them – by providing proven, sustainable solutions.

### Chemical / Petrochemical Applications at a Glance:

- Olefins / polyolefins
- SynGas / methanol
- Chlorine
- Ammonia
- Aromatics

“We supply sustainable turbocompressor solutions for the complex chemical / petrochemical market.”



Inside an ethylene-oxide plant



A centrifugal gas compressor for CO compression

## Power Generation

Energy market players are constantly striving for new solutions that minimize environmental impact. Conversely, they want to maximize productivity while generating a reliable supply of energy. Atlas Copco Gas and Process can meet those market needs, and others, thanks to our extensive experience and recognized know-how.

The market for natural gas-driven applications within the power-generation industry is growing rapidly all over the world.

Regardless of location, an efficient delivery of gas to the plant's turbines is instrumental if productivity is to be maintained in this process.

Our centrifugal gas compressors are a reliable solution for meeting this challenge. They can be easily maintained, with minimum downtime. Our customers rely on them for a number of applications, including fuel gas boosting.

In addition, every plant has different pressure and flow needs. Identifying the right compressor and components for each customer site is therefore a task of critical importance. Needless to say, it's a process we focus on in detail.



An Atlas Copco fuel gas booster

### Power Industry

Centrifugal air compressors can also help coal-fired power plants reduce their environmental impact. By deploying them in flue gas desulfurization and soot-blowing operations, customers can decrease their carbon footprint without sacrificing plant efficiency.

#### Power Generation and Power Industry Applications:

- Fuel gas boosting
- Supercritical CO<sub>2</sub>
- Plant and process air
- Flue gas desulphurization



Reliably serving various needs of the power generation industry





## The Extra Edge for Your Process: Integral Gear Technology

Based on decades of process-oriented and engineering know-how, Integral Gear Technology is an innovative approach well-suited to each customer's equipment requirements.

Developed in constant interaction with our customers, Integral Gear Technology provides long-term answers to today's application challenges. Even better, it does so in one compact, customizable package.

To give just one example: The rotor is an integral part of the gearbox, meaning the impeller is mounted on the high-speed pinion.

This allows the impeller to run at its specific optimum speed with the best efficiency.

That's not all: Our integrally-gearred compressors meet the API 617, chapter 3, and API 672 standards. They also satisfy other relevant quality standards, such as AGMA Q13 and ISO 1328, grade 4.

More and more customers around the world are choosing Integral Gear Technology – testimony to the effectiveness of this productivity-boosting approach.

### Our Integral Gear Technology Offers You:

- Improved efficiency
- Compact design
- Multi-speed capability for optimal speed in each stage
- Easy inspection and maintenance
- Combined service operation

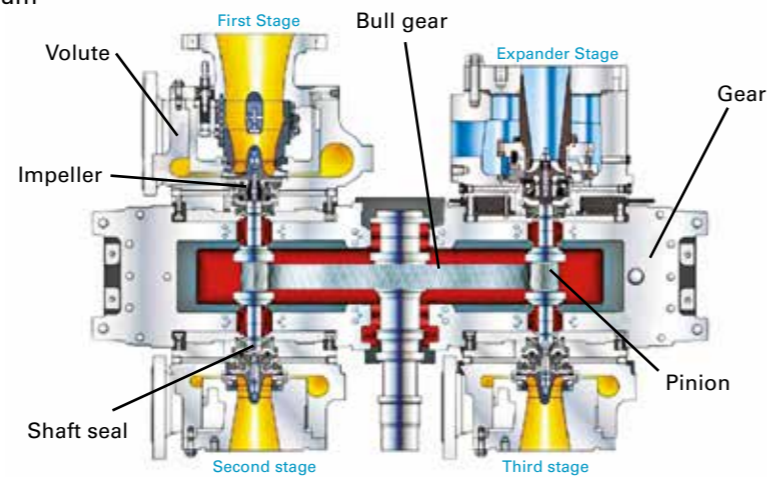

How it works: an inside look at the integral gear concept

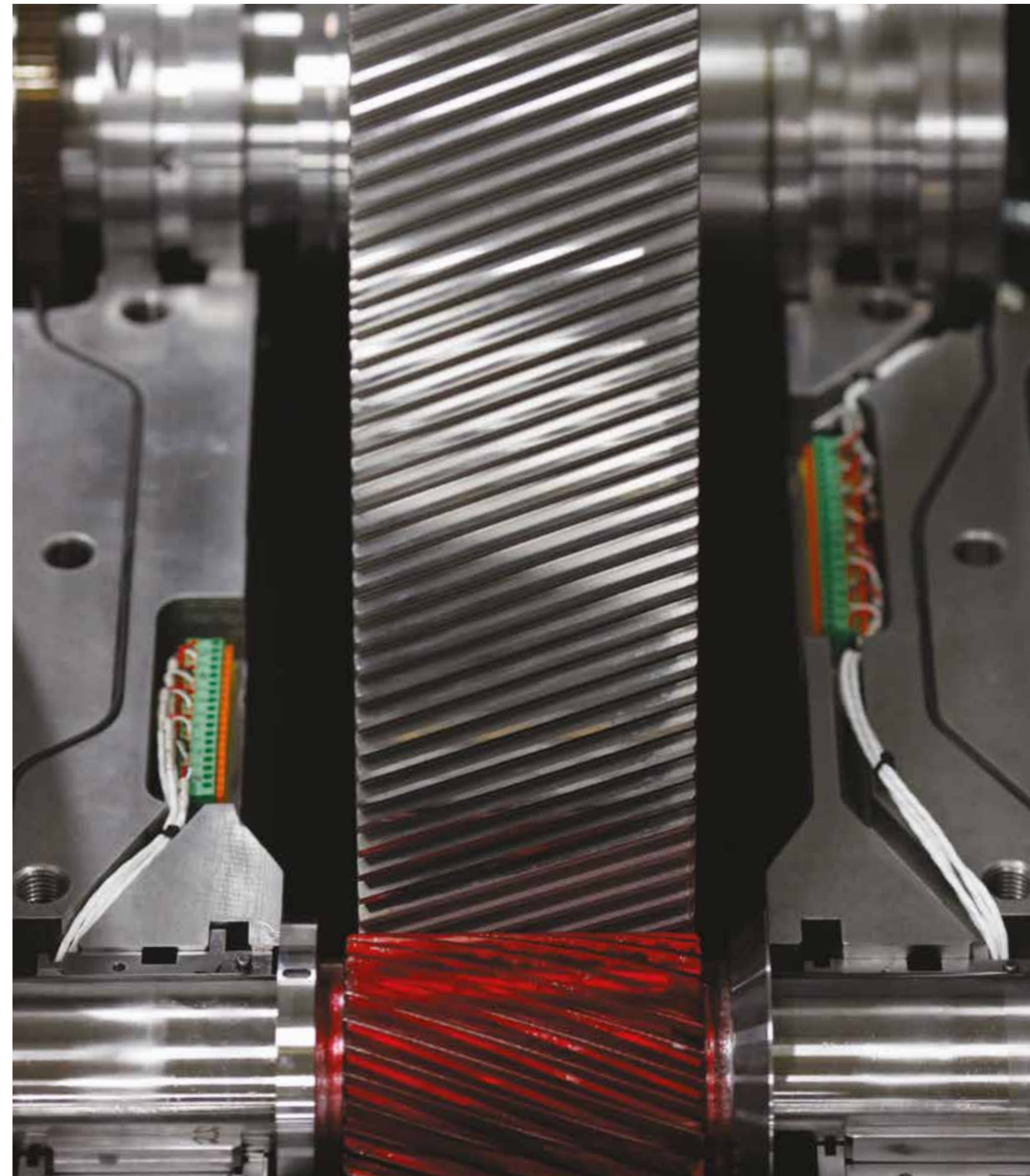



“Integral Gear Technology provides answers to today’s application challenges in one compact, customizable package.”

#### Inside the technology

Atlas Copco integral speed-increasing gears are driven by high-quality helical gearing with precise mesh geometry.

**This ensures:**

- Reliable performance
- Smooth operation
- High mechanical efficiency

The technology’s design offers a number of key advantages. First, its multiple-speed capability allows each stage to run at optimum pace, resulting in the highest-possible efficiencies.

In addition, thrust collars or axial bearings in the pinion gear ensure a high level of efficiency. This decreases losses while increasing mechanical rotor stability and reliability.

Tilting-pad bearings are used on the high-speed shaft, while sleeve bearings are used on the low-speed shaft.

Split horizontally, the gearbox design also facilitates easy inspection and maintenance of gears and bearings, without the need to disconnect the system’s piping.

Finally, to ensure optimum efficiency, sensing probes can be mounted on the pinions to monitor shaft vibration. In addition, sensors are installed in the bearings to keep track of temperature changes and shaft vibration.



*A radial-axial bearing*



*A radial bearing*



## Driving Your Process: Our Impellers

Atlas Copco Gas and Process employs superior design features in its impellers. They are at the heart of an aerodynamic stage design that drives your process.

Our turbocompressors feature an aerodynamic stage design, and the impeller is a key part of it. This design is based on decades of experience and ongoing development.

Having built thousands of compressor stages, we know what to expect. The result: impellers that meet your exact flow and pressure requirements.

In addition, Atlas Copco Gas and Process has years of experience creating compressors that can be used with corrosive and challenging gases.

Unsurprisingly, our extensive experience and technological know-how have also produced something else: many satisfied customers.

### Our Impellers:

- Provide optimum efficiency and reliability
- Have a strong track record for use with corrosive and challenging gases
- Are individually designed for your process requirements
- Are performance tested
- Cover a broad range of applications

**Inside The Technology**

When selecting impellers, we use software that calculates the design optimally reflecting your process.



*Up close: micro spline*

Thanks to the unique flow coefficients of each impeller group, our turbocompressors can meet a range of diverse requirements.

**Key Benefits:**

- Our impellers are available in open or closed configuration
- All geometries are tested by R&D
- Impellers are mounted on the pinion shaft using Hirth serration or micro spline
- Their design ensures easy assembly and high reliability



*It's all in the details: Hirth serration*

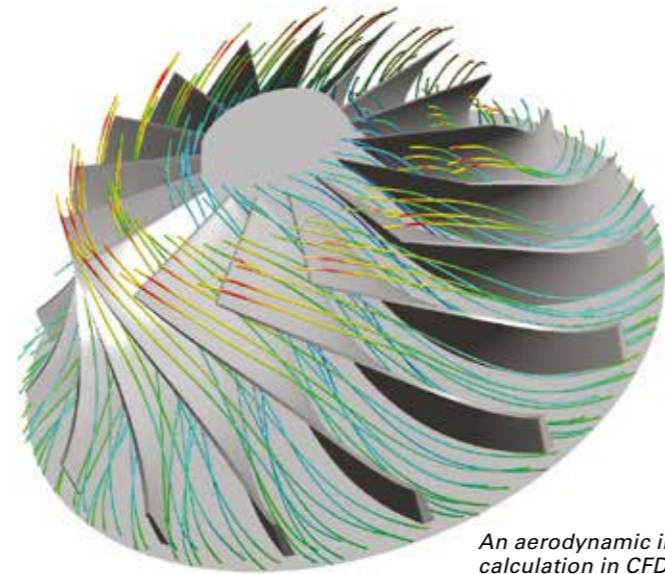

*An aerodynamic impeller calculation in CFD*

“We’ve built thousands and thousands of compressors – experience that results in superior impeller design.”



*A closed impeller*





**Atlas Copco Gas and Process Capacity-Control Options Offer You:**

- Optimum control range
- Maximum efficiency in all parts of your operation
- Vast range of regulation capabilities and excellent partial performance
- DGVs capable of large turndown
- Combined configuration to ensure maximum control flexibility

## Controlling Your Capacity: Our IGV and DGV Options

Our turbocompressors are designed to be an integral part of your process and your plant as a whole. To maximize their effectiveness, they can be equipped with different capacity-control options, which can adapt to changing process conditions such as discharge pressure and volume.

### Inside The Technology

Our **variable IGVs** offer a wide operating range and excellent partial-load performance.

In addition, our **variable DGVs** ensure an excellent control range in both single and multi-stage applications.

Finally, our **speed control** is just the feature you need when volume turndown at a lower pressure ratio is required.



A variable diffuser-guide vane (DGV)

Our control options include **inlet-guide vanes (IGV)**, **diffuser-guide vanes (DGV)**, and **combined IGV and DGV configurations**, as well as a speed-control capability using steam turbines or VFD.

The bottom line: Our capacity-control options ensure your process is as flexible and efficient as possible.

### IGV Control

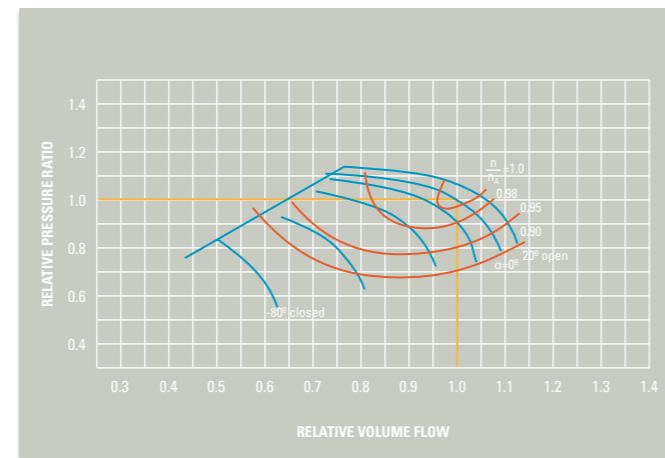

### DGV Control

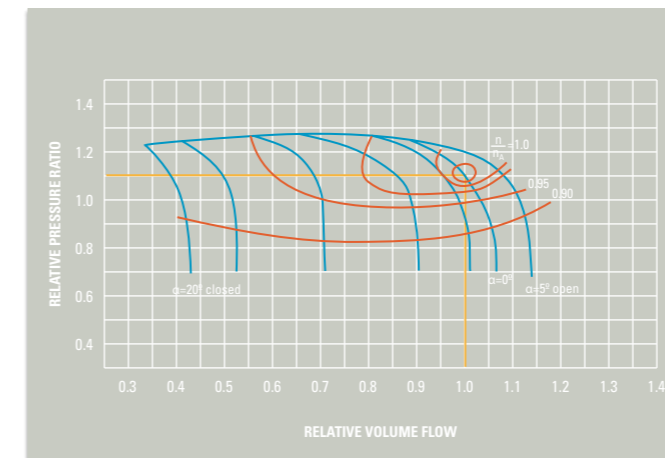

### Speed Control

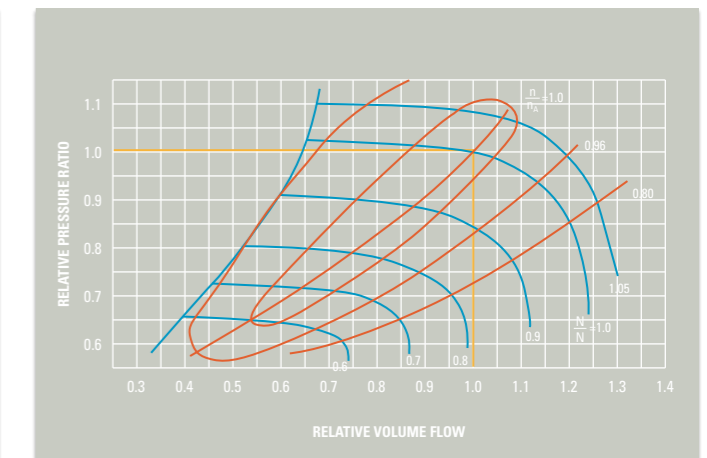

# Shielding Your Process: Our Seal Options

State-of-the-art shaft seals ensure your process remains a closed, efficient system.

Shaft seals minimize or eliminate the leakage of gas while preventing air intrusion into the compressor case.

Because every application requires a different solution, Atlas Copco Gas and Process offers a wide variety of seals. Our customers rely on them in any number of challenging settings, such as those that involve corrosive, toxic, and flammable gases.

With multiple options available, finding the right solution is the key. Drawing on decades of know-how and engineering expertise, our experts will be glad to help you identify the seal that meets your precise needs.

Our seal-gas systems comply with API 614 / 617.

## What Atlas Copco Gas and Process Offers You:

All of our seals provide one universal advantage: maximum efficiency.

### Other Benefits Include:

- Superior reliability
- Optimized shaft-seal selection and configuration
- Minimized process-gas leakage
- Minimized seal-gas consumption

Floating carbon seals

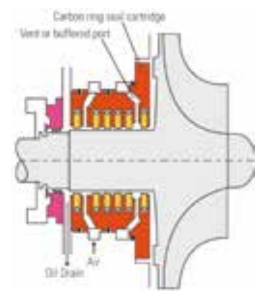

Labyrinth seals

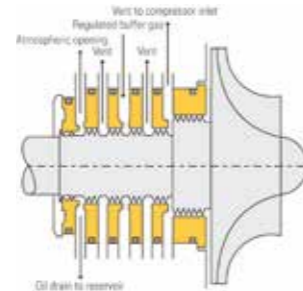

Dynamic dry-gas seals

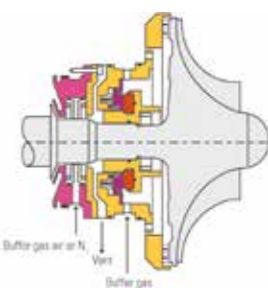

Oil-lubricated seals



## Inside the technology

Our **dry-gas seals** can be applied in single, tandem or double-acting configurations. Dynamic dry-gas seals, for example, offer an alternative to oil-lubricated seals for minimum leakage applications.

In addition, **shaft seals** such as **floating carbon ring seals** or precision-engineered **labyrinth seals** are ideal for minimum-leakage situations. They can also be combined with two to five chambers to allow the injection of buffer gas.

For example, when leakage into the atmosphere is permissible, **labyrinth seals** are an effective choice. The number of labyrinths and clearances is determined by the customer's application.



Photo: © John Crane Group Corporation

## Our Packaging Options

Markets are becoming increasingly globalized and dynamic, which has a direct impact on our customers. To respond optimally to their needs, we offer flexible options when delivering centrifugal compressors for air or gas compressors, as well as highly specified packaging solutions in line with API.

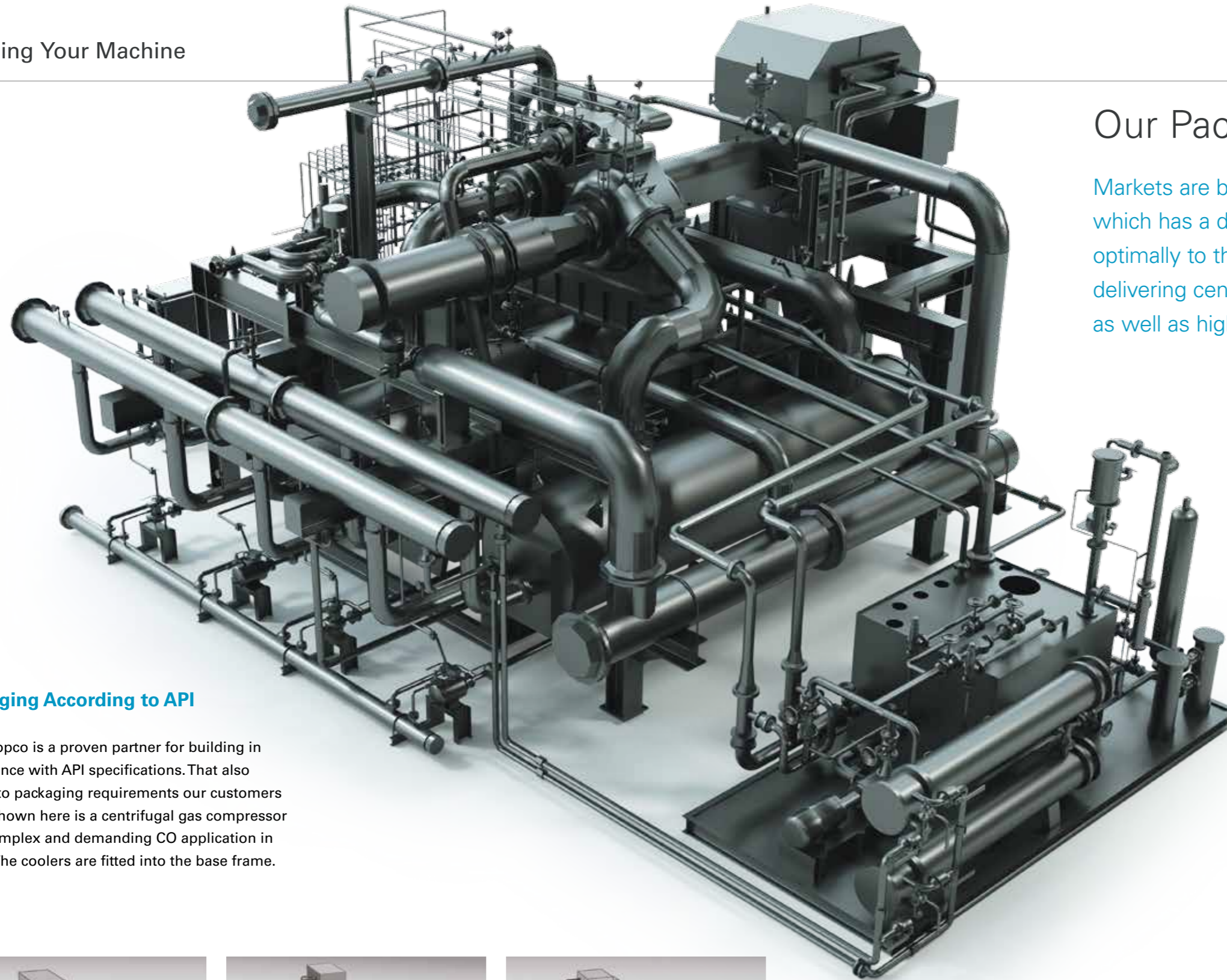

### Packaging According to API

Atlas Copco is a proven partner for building in accordance with API specifications. That also relates to packaging requirements our customers have. Shown here is a centrifugal gas compressor for a complex and demanding CO application in China. The coolers are fitted into the base frame.

#### Full-Packaging

Dating back to the early days of the turbocompressor, full-packaging is the most compact approach. It means the entire machine – from the core unit to the coolers and piping – is assembled and shipped to the customer in one skid (unit).

This option is best suited for machines with a flow volume of up to 52 000 m<sup>3</sup>/h, and when quick installation and operations are needed.

#### Semi-Packaging

This option is suitable for heavier machines (approx. 80 tons, flow volumes up to 120 000 m<sup>3</sup>/h) that cannot feasibly be transported as one unit. Select components such as the motor or foundation are produced and installed separately.

#### Free Arrangement

A modern variation of semi-packaging, our free-arrangement option takes advantage of the possibilities for sourcing components locally, thus reducing transport costs and times.

This option was developed because turbocompressors have grown in size. Often sourced locally, the components are delivered separately and installed as one unit on site.

Thanks to our systematic planning procedures and global infrastructure, this approach is ideal for customers who operate larger compressors and therefore need a customized solution.

“Thanks to our extensive know-how and innovative planning, we can offer each customer a fully customized packaging solution.”

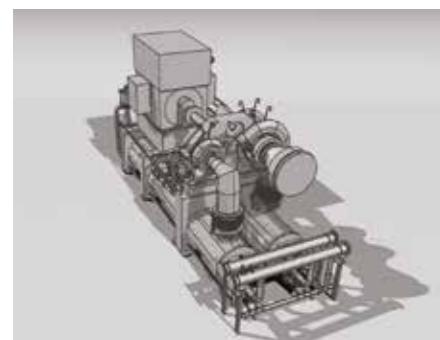

Full-package arrangement



Semi-package arrangement

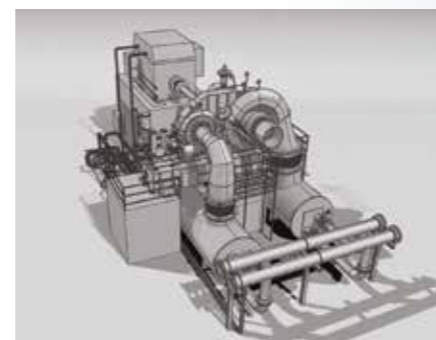

Free arrangement

## Committed to Sustainable Quality

By consistently producing high-quality products, Atlas Copco Gas and Process has established itself as an industry frontrunner. Our commitment to excellent quality has also earned us an outstanding reputation – and loyal customers around the globe.

### Your Partner From Start to Finish – and Beyond



\*Front-end engineering & design / \*\*Engineering/procurement/construction

Our focus on quality means that all of our equipment is designed and constructed for a minimum service life of **20 years** and at least **three years of uninterrupted operation**.

Because we're active in numerous markets, we also adhere to a range of standards, including **ISO, ASME, DIN, and CENELEC**.

This includes national and regional standards (such as those used in Australia, Russia and Japan), as well as the Marine Standard.

Finally, all our global facilities are subject to quality-assurance programs certified to the **ISO 9001** standard and registered by Lloyds Register Quality Assurance, Ltd.

#### Our Quality Promise to You:

- A lifelong service-responsibility guarantee for your machine
- Adherence to the applicable standards
- Global quality management according to ISO 9001
- Compliance with marine-relevant specifications (where required)
- Support of electric standards (where required)
- Documentation in your own language
- Compliance with ISO14001 and OHSAS 18001

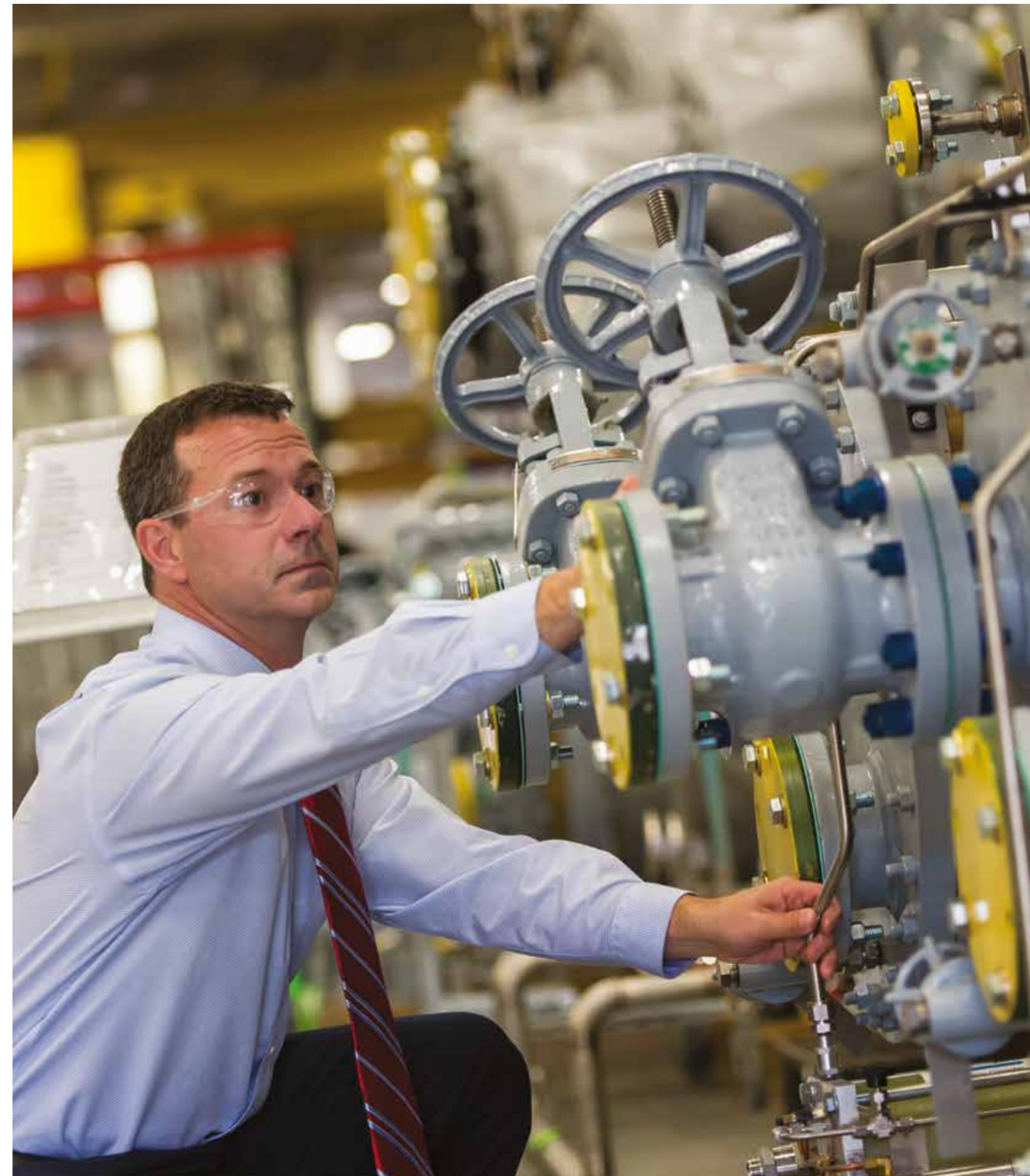



## Proven Engineering Expertise

Extensive process know-how, automated workflows, integrated quality protocols – these are just some of the engineering resources we draw on to provide our customers with first-in-class products.

### Our Tools for Boosting Your Productivity

Aerodynamics	Mechanics	Design
<ul style="list-style-type: none"> <li>• OEM* software</li> <li>• Experimental measurements</li> <li>• CFD analysis: ANSYS</li> <li>• Gas programs: HYSYS, FRG, GPA</li> </ul>	<ul style="list-style-type: none"> <li>• OEM* software</li> <li>• Rotor dynamics: SR3</li> <li>• Rotor dynamics &amp; bearings: Madyn</li> <li>• Torsional analysis: DRESP</li> <li>• FEA: ANSYS</li> <li>• FVA workbench: RICOR, ST-Plus</li> </ul>	<ul style="list-style-type: none"> <li>• 3D-CAD: ProE, MEDUSA / MPDS, Autodesk, Inventor</li> <li>• 2D-CAD: MEDUSA</li> <li>• Process design: HYSYS</li> <li>• Component design: OEM* software</li> </ul>

\* Original Equipment Manufacturer  
Different programs for aero design and selection of compressor and turbine components

### Quality Benchmarks

The Atlas Copco Gas and Process engineering department has set standards in the areas of aerodynamics, rotor design, controlling technology, lubrication systems, pressure vessels, instrumentation, and piping.

In addition to product excellence, the result of our applied expertise is our position as an industry leader and a roster of satisfied customers.

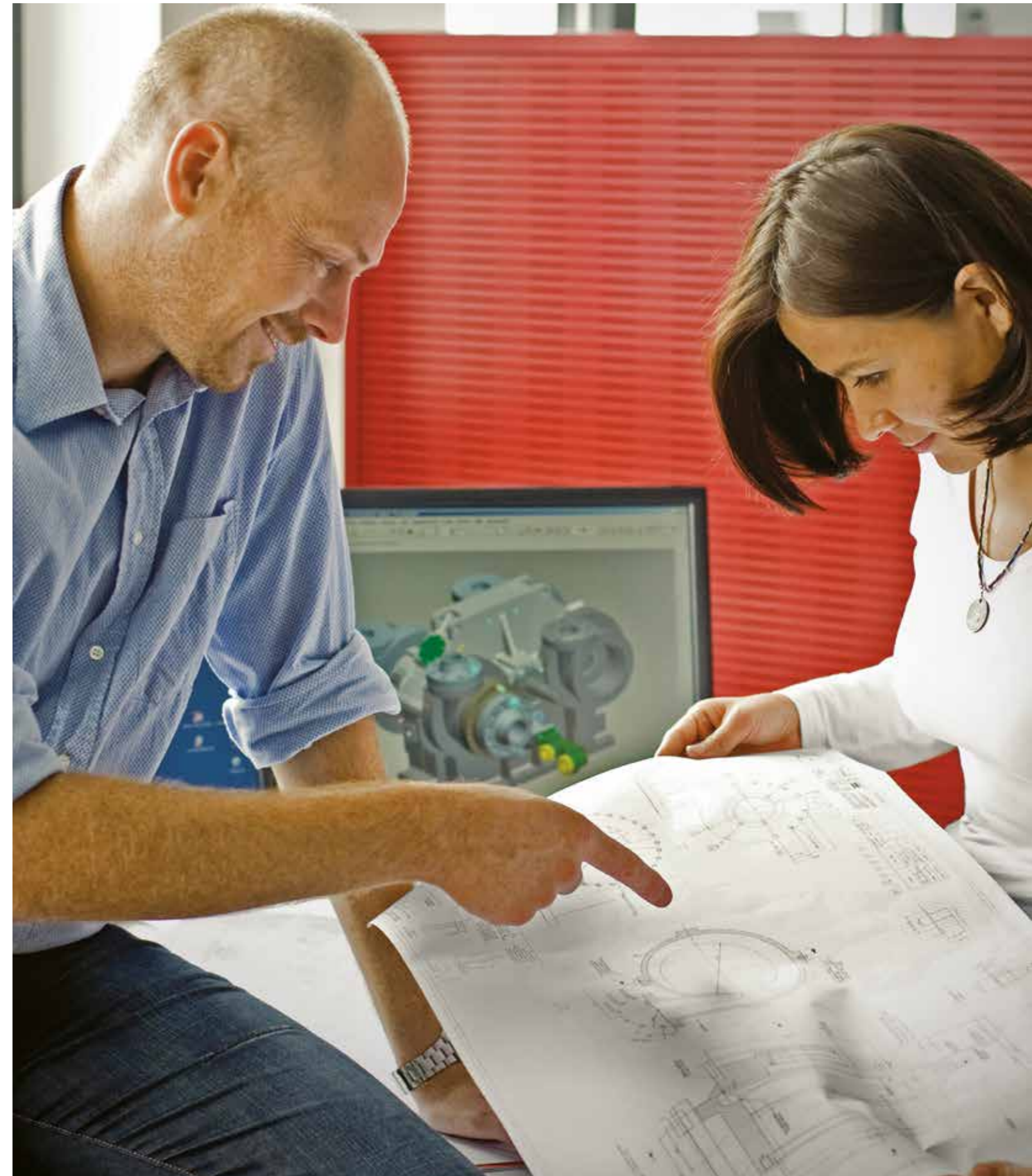



**Among Other Benefits, We Offer You:**

- Local packaging, and local sourcing for peripheral components
- In-house packaging of key components ensures premium quality and delivery times

**Key Components in Our Engineering Toolkit:**

- State-of-the-art production machinery (including milling, balancing and spinning equipment)
- Modern production infrastructure fit for the global stage – and your process needs
- Constant product-performance review
- Strict quality assurance

## Production Know-How Around the Globe

From Cologne to Upstate New York to China, when manufacturing our products we focus on one goal: helping our customers stay productive over the long term. With our many years of experience in markets around the world, we have the in-house knowledge to make it happen.

### Inside our Production Facilities

Working with the appropriate tools and processes, we use our extensive engineering know-how to create innovative, first-in-class products. Our skill set, moreover, is something we continue to invest in.



*Balancing machines*



*Spinning machinery*



*Inside the multi-skill machine: the milling process*

## Testing Your Machine

At our Gas and Process testing facilities, your machine is thoroughly checked before leaving the plant. We have the ability to simulate all relevant operating conditions you are facing, so we know when your equipment is ready to ship.

For example, as a standard quality-assurance measure, we perform mechanical test runs on your machine, with performance testing carried out when required.

To ensure nothing is left to chance, our tests fully comply with all relevant standards, including DIN, ISO, VDI 2045, ASME, PTC10 and API 617 / 672.

In testing the machines we sell, we also work closely with our customers in order to achieve our final goal: delivering the best product possible.

Ultimately, it's about making sure you have the quality, efficiency, and sustainability you need to carry out your processes.





## Building to API Specifications

Our experts can help you choose the right components for your process, before we build them to meet current international industry standards.

### Customizing to Your Requirements

Industries and applications such as chemical / petrochemical or oil and gas depend on equipment that operates with maximum efficiency and reliability and meets internationally set standards.

At Atlas Copco Gas and Process, we offer customers the unique combination of technical know-how and manufacturing expertise needed to transform every challenge into a success.

Depending on your process, we can customize your equipment to match the rigorous standards set by the American Petroleum Institute (API), which help improve efficiency of equipment and processes, comply with legislative and regulatory requirements, and increase the safety of operations.

“At Atlas Copco, we build our integrally-gearred compressors according to recognized industry standards, including API 617, chapter 3.”

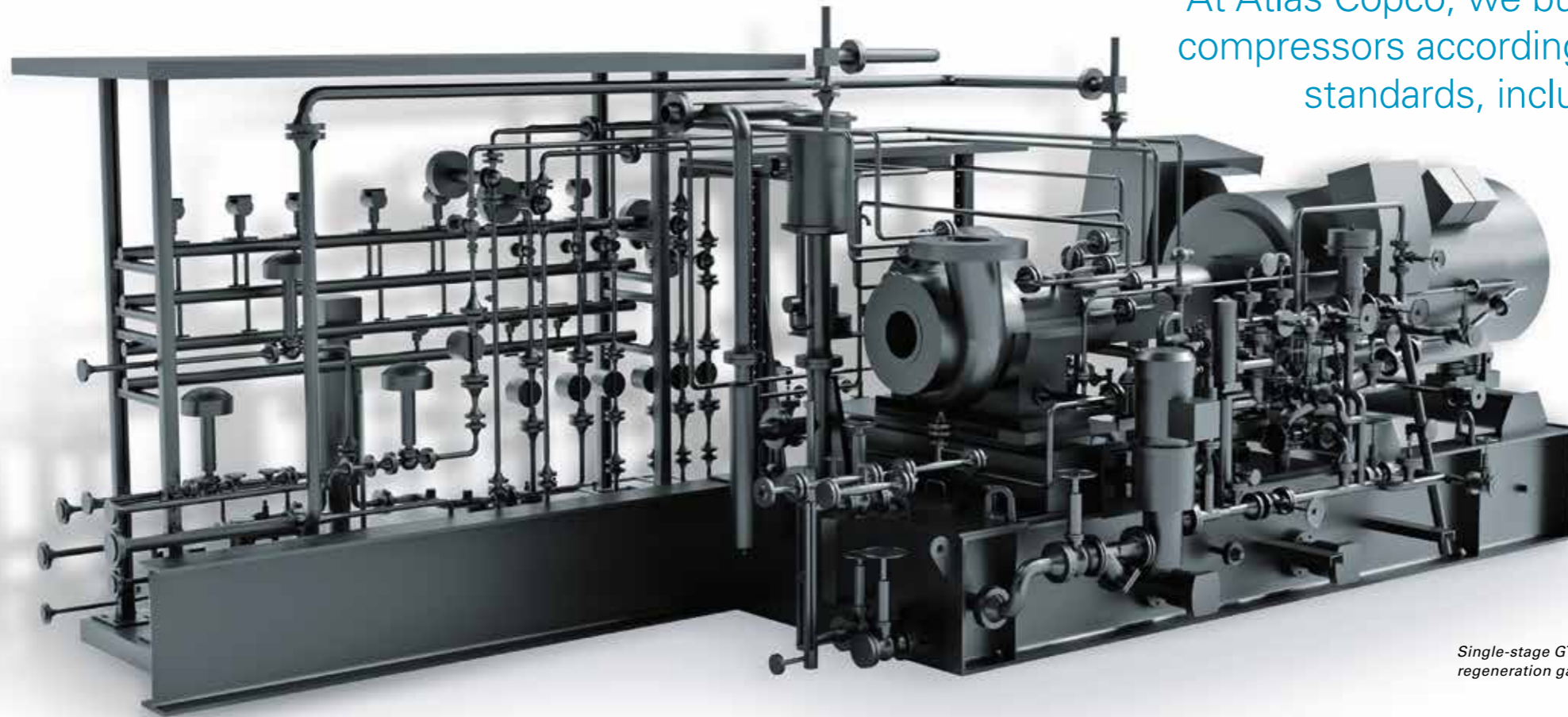

Single-stage GT026 centrifugal compressor for regeneration gas built according to API specifications

### Always Up to Standard

Atlas Copco Gas and Process builds compressors to meet API 617, chapter 3 (gas) and API 672 (air) requirements, including oil systems that reflect API 614. In fact, our know-how helps set industry standards.

After all, Atlas Copco Gas and Process engineers participated in the development of API 617, 7th edition, as well as API 672, 4th edition.

Atlas Copco Gas and Process also builds compressors that meet both API and DIN standards.



GT032 T1D1 compressor built to comply with API 617

Atlas Copco Gas and Process combines innovative, standard-setting turbomachinery with long-term project experience in extreme locations. Our equipment stays reliable, efficient, and safe in the cold of the Siberian tundra, in the heat of the desert, and in the corrosive, windswept waters of coastal regions.

Today, Atlas Copco is the market leader for centrifugal turbocompressors built to support offshore applications.

### Atlas Copco Gas and Process and API:

- We are a member of API and actively participate in standards development
- We focus on and are committed to serving the gas and process industry
- We have extensive experience meeting API standards
- We are proud to be a leading supplier of custom-built solutions
- Our track record includes 100-plus integrally-gearred units built according to API 617, chapter 3

# Features of Our Turbocompressor Products

This overview provides you with an in-depth look into our turbocompressor products – and how they differ technically.

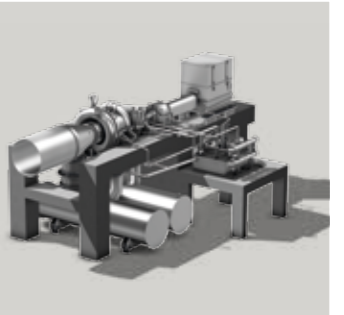
	H Series	SC Series	TP Series	GT Series	T Series	RT Series
						
Suction pressure (max.)	1.4 bar(a) (8 bar)*	70 bar(a)	50 bar(a)	80 bar(a)	40 bar(a)	Atmospheric
Discharge pressure (max.)	35 bar(a)	100 bar(a)	100 bar(a)	200 bar(a)	40 bar(a)	7 bar(a)
Suction temperature	-40 to 50°C	-50 to 200°C	-40 to 200°C	-200 to 200°C	-40 to 150°C	-40 to 80°C
Effective inlet-flow range	3 500–49 500 (85 000**) m <sup>3</sup> /h	250–155 000 m <sup>3</sup> /h	250–65 000 m <sup>3</sup> /h	250–400 000 m <sup>3</sup> /h	15 000–80 000 m <sup>3</sup> /h	240 000–480 000 m <sup>3</sup> /h***
Maximum No. of stages	1–6	1	2–6	1–8	1	3
Gases handled	Air, nitrogen	All gases	All gases	All gases	Polyethylene, Polypropylene	Air
Impeller types	Open	Open	Open	Open / closed	Open	Open / closed
Shaft / impeller connection	Microspline	Microspline	Microspline	Hirth serration	Hirth serration	Hirth serration / shrink fit
Seals						
Labyrinth	•	•	•	•		•
Carbon ring	•	•	•	•		•
Dry-gas seal		•	•	•	•	
Capacity / pressure control						
Variable inlet-guide vanes (IGV)	•	•	•	•	•	•
Variable diffuser-guide vanes (DGV)	•**	•	•	•	•	•
Variable speed		•	•	•	•	•
Inlet throttle	•	•	•	•	•	•
API	672	672 / 617	672 / 617	672 / 617	617	617
Axial thrust compensation	High-speed axial bearings	High-speed axial bearings	High-speed axial bearings	High-speed axial bearings or thrust collar	High-speed axial bearings	High-speed axial bearings
Oil system	Manufacturer's standard or API 614	Manufacturer's standard or API 614	Manufacturer's standard or API 614	Manufacturer's standard or API 614	API 614	Manufacturer's standard or API 614
Coupling	Dry	Dry	Dry	Dry	Dry	Dry
Test code	VDI2045 / ASME PTC10	VDI2045 / ASME PTC10	VDI2045 / ASME PTC10	VDI2045 / ASME PTC10	VDI2045 / ASME PTC10	VDI2045 / ASME PTC10

\* H-booster upon request  
 \*\* for single-stage H Series

\*\*\* Design for effective volume flow up to 650 000 m<sup>3</sup>/h is available.

**Main Air Compressor**

This turbocompressor feeds an oxygen plant inside a Chinese steel mill.

**Type:** Three-stage GT153  
**Inlet pressure:** 0.99 bar(a) / 14.4 psia  
**Outlet pressure:** 6.4 bar(a) / 92.8 psia  
**Inlet temperature:** 30 °C / 86 °F  
**Flow:** 380 000 m<sup>3</sup>/h / 224 000 cfm



**Booster Air Compressor / N<sub>2</sub> Recycle Compressor**

This combined service machine is at the heart of a steel and iron mill.

**Type:** Six-stage combined-service GT040  
**Inlet pressure:** 5.6 bar(a) / 81.2 psia  
**Outlet pressure:** 62 bar(a) / 899.2 psia  
**Inlet temperature:** 22 °C / 71 °F  
**Flow:** 8 800 m<sup>3</sup>/h / 5 179 cfm



**Recycled Feed Main Air / Booster Air Compressor**

This MAC-BAC compressor supplies dry nitrogen.

**Type:** Four-stage combined-service GT050 / GT032  
**Inlet pressure:** 5.3 bar(a) / 76.9 psia  
**Outlet pressure:** 29.1 bar(a) / 422.1 psia  
**Inlet temperature:** 24 °C / 75.2 °F  
**Flow:** 20 000 m<sup>3</sup>/h / 11 771 cfm



**Air Compressor for Membrane N<sub>2</sub> Generation**

This machine is used in an LNG-regasification application.

**Type:** Three-stage H16000  
**Inlet pressure:** 0.99 bar(a) / 14.4 psia  
**Outlet pressure:** 13.9 bar(a) / 201.6 psia  
**Inlet temperature:** 42 °C / 107 °F  
**Flow:** 19 000 m<sup>3</sup>/h / 11 183 cfm

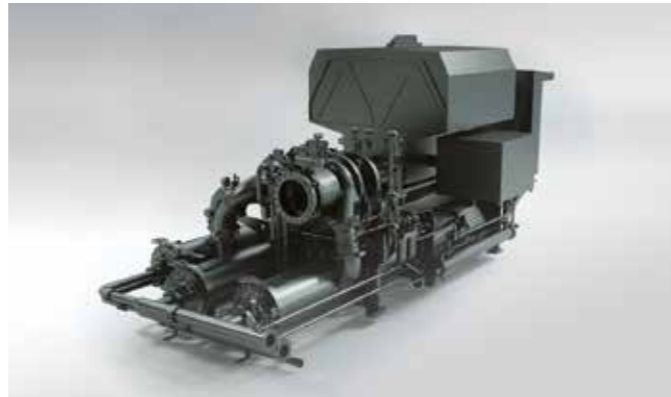

**Booster Air Compressor**

This is a two-stage H-Series compressor.

**Type:** Two-stage H26000  
**Inlet pressure:** 6 bar(a) / 87 psia  
**Outlet pressure:** 26 bar(a) / 377.1 psia  
**Inlet temperature:** 30 °C / 86 °F  
**Flow:** 6 600 m<sup>3</sup>/h / 3 885 cfm

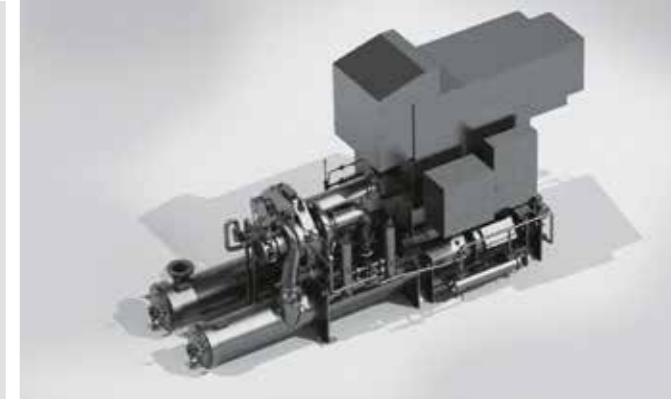

**Centrifugal Gas Compressor for Power Generation**

Close-up of one of our fuel gas boosters.

**Type:** Single-stage SC-series  
**Inlet pressure:** 27 bar(a) / 391.6 psia  
**Outlet pressure:** 42 bar(a) / 609.2 psia  
**Inlet temperature:** 12 °C / 53.6 °F  
**Flow:** 2 900 m<sup>3</sup>/h / 1 706.9 cfm



**Centrifugal Gas Compressor for Power Generation**

This fuel gas booster is used inside a Russian natural gas-fired power plant.

**Type:** Six-stage GT050  
**Inlet pressure:** 5.7 bar(a) / 82.7 psia  
**Outlet pressure:** 48.3 bar(a) / 700.5 psia  
**Inlet temperature:** 13 °C / 55.4 °F  
**Flow:** 14 300 m<sup>3</sup>/h / 8 416.7 cfm

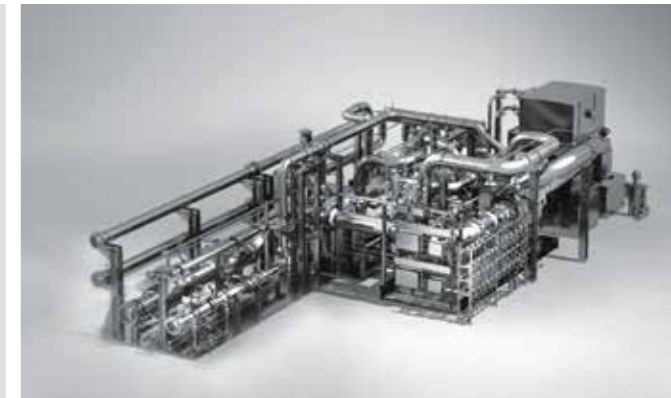

**Standardized Fuel Gas Booster**

A standardized fuel gas booster package.

**Type:** Single stage or multistage  
**Inlet pressure:** 8–30 bar(a) / 116–435 psia\*  
**Outlet pressure:** 28–50 bar(a) / 406–725 psia  
**Inlet temperature:** 5–65 °C / 41–149 °F  
**Outlet temperature:** below 155 °C / 311 °F  
**Flow:** 1 000–6 000 m<sup>3</sup>/h / 589–3 531 cfm

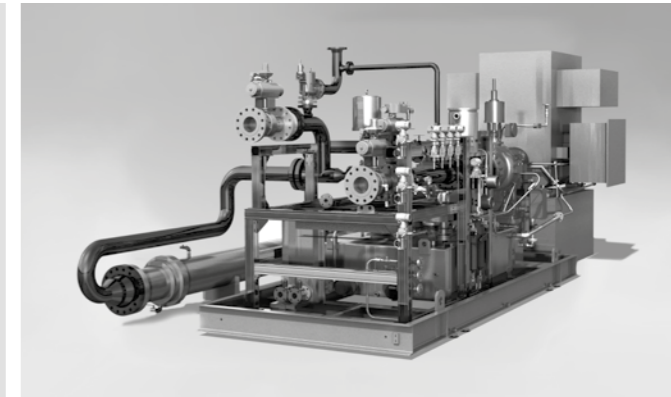

\* 14–30 bar(a) / 203–435 psia (Single stage)  
 8–22 bar(a) / 116–319 psia (Multistage)

**Centrifugal Compressor for Regeneration Gas**

Used in the United Arab Emirates, this regeneration-gas compressor is built to fully support API requirements.

**Type:** Single-stage GT026  
**Inlet pressure:** 67.4 bar(a) / 977.6 psia  
**Outlet pressure:** 74.3 bar(a) / 1 044.6 psia  
**Inlet temperature:** 62 °C / 143.6 °F  
**Flow:** 2 500 m<sup>3</sup>/h / 1 471.4 cfm

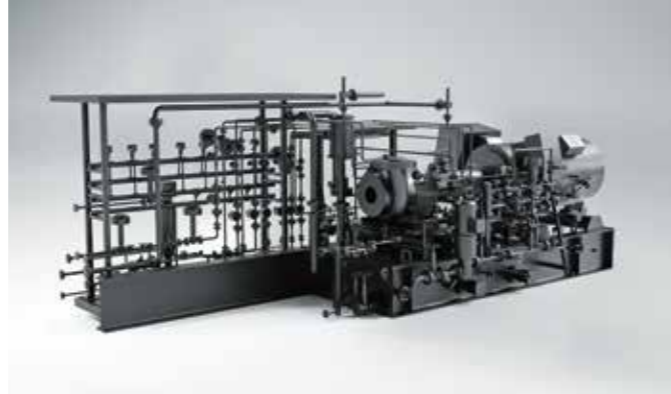

**Comander for Liquefied Natural Gas (LNG)**

The comander's expander stage is an essential component of an on-board LNG reliquefaction plant.

**Type:** Three-stage GT 032 N3D0 /  
 Single-stage ETG 150 MS  
**Inlet Pressure:** 56.4 bar(a) / 818 psia  
**Inlet Temperature:** -110 °C / -166 °F  
**Flow:** 94 400 Nm<sup>3</sup>/h / 55 561.7 scfm  
**Expander Cold Production:** 1 096 kW / 1 469 HP

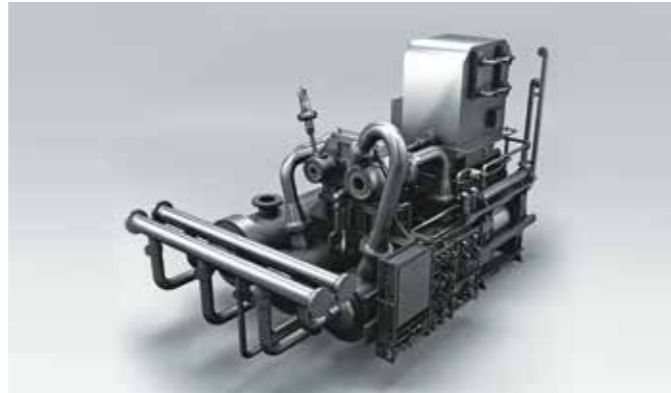

**Comander for Chemical**

The comander is deployed in a Belgian hydrogen-peroxide-to-propylene-oxide (HPPO) plant.

**Type:** Three-stage GT056 / ETI300NS  
**Inlet pressure:** 1.1 bar(a) / 16 psia  
**Outlet pressure:** 8.7 bar(a) / 126.2 psia  
**Inlet temperature:** 20 °C / 68 °F  
**Flow:** 37 500 m<sup>3</sup>/h / 22 071.7 cfm



**Centrifugal Gas Compressor for Petrochemical**

This compressor is deployed in a methanol application.

**Type:** Four-stage GT026  
**Inlet pressure:** 6.4 bar(a) / 92.8 psia  
**Outlet pressure:** 38.9 bar(a) / 564.2 psia  
**Inlet temperature:** 38 °C / 100.4 °F  
**Flow:** 2 500 m<sup>3</sup>/h / 1 471.4 cfm

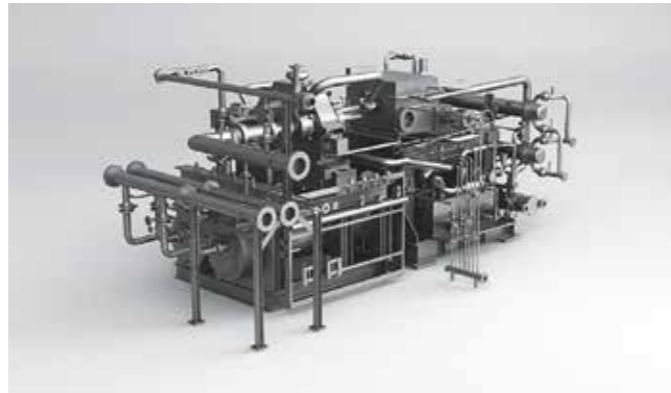

**Centrifugal Gas Compressor for Ethylene**

This compressor is used inside a polyethylene plant.

**Type:** Four-stage GT021  
**Inlet pressure:** 18.5 bar(a) / 268.3 psia  
**Outlet pressure:** 74.5 bar(a) / 1 080.5 psia  
**Inlet temperature:** 33 °C / 91.4 °F  
**Flow:** 2 200 m<sup>3</sup>/h / 1 294.9



**Centrifugal Gas Compressor for Coal Gasification**

This five-stage machine is used in a CO application in China.

**Type:** Five-stage GT070  
**Inlet pressure:** 1.1 bar(a) / 16 psia  
**Outlet pressure:** 83.4 bar(a) / 1209.6 psia  
**Inlet temperature:** 12 °C / 53.6 °F  
**Flow:** 43 000 m<sup>3</sup>/h / 25 308.8 cfm



**Centrifugal Gas Compressor for Petrochemical**

This compressor for a Chinese petrochemical plant had to meet complex requirements.

**Type:** Five-stage GT032  
**Inlet pressure:** 1.8 bar(a) / 26.1 psia  
**Outlet pressure:** 37.9 bar(a) / 549.7 psia  
**Inlet temperature:** 27 °C / 80.6 °F  
**Flow:** 30 000 m<sup>3</sup>/h / 17 657.3 cfm

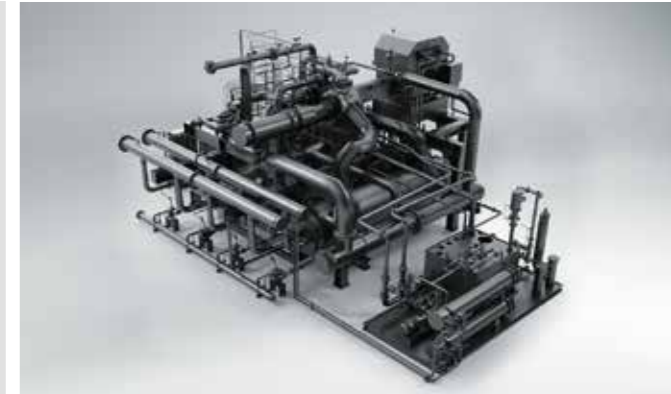

**Residue Gas Compressor for NGL Recovery**

A residue gas compressor for a gas plant in Nigeria, providing unmanned operation in extreme conditions.

**Type:** Two-stage TP14 / 14  
**Inlet pressure:** 18.4 bar(a) / 267 psia  
**Outlet pressure:** 53.4 bar(a) / 774 psia  
**Inlet temperature:** 43.2 °C / 110 °F  
**Flow:** 100 620 m<sup>3</sup>/h / 59 200 cfm

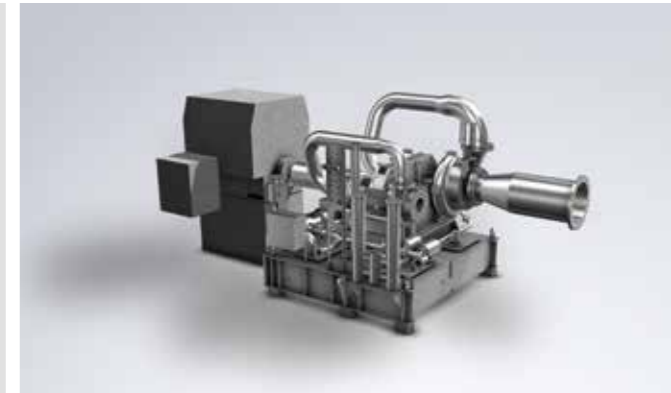



## Our Products for Your Market

Market / Application	Integrally-Geared Centrifugal Compressors		Non-Geared Centrifugal Compressors		Combined Service	Companders™
	Gas	Air / Nitrogen	Gas	Air		
<b>Industrial Gases</b>						
Main Air Compressor (MAC)		•		•	•	
Booster Air Compressor (BAC)		•			•	
N <sub>2</sub> Booster		•			•	
O <sub>2</sub> Compressor	•					
CO <sub>2</sub> Compressor	•					•
Plant & Instrument Air		•				
HyCO	•	•				
Carbon Capture Storage	•	•				
<b>Oil and Gas (Midstream)</b>						
FLNG	•	•				
FSRU	•					•
Carrier LNG	•					•
Small-scale LNG	•	•				•
Large-scale LNG	•					
NGL Recovery / Gas Processing	•				•	
NGL Fractination / LPG	•					
Refineries	•	•				
<b>Chemical / Petrochemical</b>						
Olefins / Polyolefins	•	•	•			•
SynGas / Methanol / Hydrogen	•	•			•	
Specialty Chemicals / Aromatics	•	•				
Ammonia	•	•			•	
Chlorine	•	•				
<b>Power Generation</b>						
Fuel Gas Boosting	•					
Supercritical CO <sub>2</sub>	•					•
<b>Fertilizer</b>						
Ammonia	•	•			•	
Urea	•	•			•	
Nitric Acid	•	•				
Melamine	•					

# A Truly Global Operation

Atlas Copco Gas and Process is an international player proud of its local presence across the world.

- PRODUCTION FACILITY ●
- APPLICATION CENTER ●
- REGIONAL SALES SUPPORT ●
- SERVICE CENTER ●

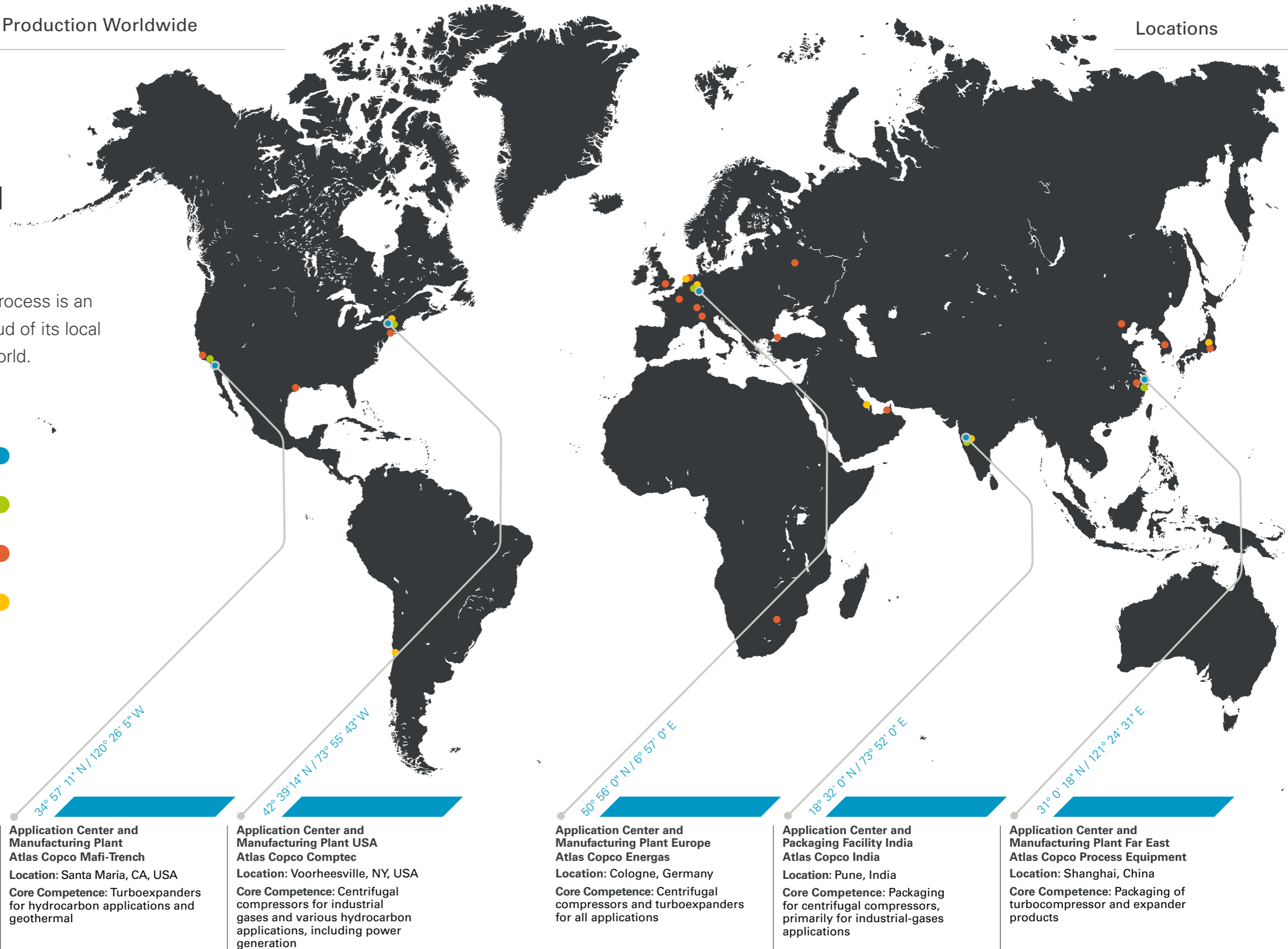



## ***COMMITTED TO SUSTAINABLE PRODUCTIVITY***

We stand by our responsibilities towards our customers,  
towards the environment and the people around us.  
We make performance stand the test of time.  
This is what we call – Sustainable Productivity.

Atlas Copco Gas and Process Division  
Schlehenweg 15, 50999 Cologne, Germany  
[www.atlascopco-gap.com](http://www.atlascopco-gap.com)

***Atlas Copco***