

CESSNA

CONTENTS

Cessna Manuals.....	12
Cessna Parts from Atlee Dodge	13
Cessna 120-140.....	14
Cessna 150-152.....	19
Cessna 170-177.....	20
Cessna 180-185.....	22
Miscellaneous	25
Cleveland Conversion Kits	25

Many parts can be correctly identified by the nomenclature listed in this section. However, we suggest that you also have the correct parts manual for positive identification.

Cessna Manuals

Parts Catalogs

120/140 Parts Catalog 1946-1949	UP104-12	\$34.88
140A Parts Catalog, 1949-1951.....	P105-12	\$83.00
150 Parts Catalog, 1959-1969.....	P438-12	\$172.30
150 Parts Catalog, 1970-1977.....	P691-12	\$233.00
152 Parts Catalog, 1978-1985 (P657-1-12)	P692-12	\$233.00
170 Parts Catalog, 1948.....	UP106-12	\$70.18
170A Parts Catalog, 1949-1951.....	UP107-12	\$70.18
170B Parts Catalog, 1952-1956.....	UP108-12	\$70.18
172 and 175 Parts Catalog, 1956-1962.....	P257-12	\$245.00
172 Parts Catalog, 1963-1974.....	P529-12	\$202.07
172/172Q Parts Catalog, 1975-1986.....	P696-12	\$233.00
172RG Parts Catalog, 1980-1985	P693-12	\$233.00
177 Cardinal Parts Catalog, 1968-1978.....	P695-12	\$189.76
177 Cardinal RG Parts Catalog, 1971-1978.....	P695-12	\$189.76
180, 1953-1962 and 182 Parts Catalog, 1956-1961.....	P259-12	\$233.00
180, 1963-1973 and 185, Parts Catalog, 1961-1973.....	P527-12	\$233.00
180-185 Parts Catalog, 1974-1985	P699-12	\$233.00
182 and Skylane Parts Catalog, 1962-1973.....	P515-12	\$215.68
182 Parts Catalog, 1974-1986.....	P690-12	\$233.00
R182/TR182 Skylane RG Parts Catalog, 1986-1987	P701-12	\$193.33
188 Parts Catalog, 1966-1975.....	P545-12	\$209.25
188 AG Aircraft Series Parts Catalog, 1976-1984.....	P694-12	\$209.25
190-195 Parts Catalog, 1948-1953	P112-12	\$209.25

Service Manuals

100 Series Service Manual, 1953-1962 (for 150, 172, 175, 180, 182, and 185).....	*UD138-13	\$76.98
* This manual is not written specifically for the 120, 140 or 170 series; however, much of the information is useful for these aircraft.		
100 Series Service Manual, 1963-1968	UD637-13	\$80.39
150 Series Service Manual, 1969-1976	D971-3-13	\$215.46
150 Series Service Manual, 1977.....	D2011-1-13	\$193.00
152 Series Service Manual, 1978-1985	D2064-1-13	\$233.00
172 Series Service Manual, 1969-1976	D972-4-13	\$202.07
172/172Q Series Service Manual, 1977-1986	D2065-3-13	\$233.00
172 Hawk XP Service Manual, 1977-1981.....	D2027-1-13	\$215.46
FR172 (Reims Rocket) Service Manual, 1968-1976	D849-5-13	\$220.00
172RG Service Manual, 1980-1985	D2066-1-13	\$198.15
177 Cardinal Service Manual, 1968-1978.....	D841-8-13	\$197.00
177RG Cardinal Service Manual, 1971-1975	D991-3-13	\$217.46
177RG Cardinal Service Manual, 1976-1978	D2009-4-13	\$221.92
180/185 Skywagon and AG Carryall, 1969-1980.....	D2000-9-13	\$246.33
180/185 Series Service Manual, 1981-1985.....	D2067-1-13	\$205.00
182 Skylane Service Manual, 1969-1976	D2006-3-13	\$205.00
182/T182 Skylane Service Manual, 1977-1986.....	D2068-3-13	\$215.46
R182/TR182 Skylane RG Service Manual, 1978-86	D2069-3-13	\$233.00
188 Ag Aircraft Series Service Manual, 1966-1984.....	D2054-1-13	\$205.00

Owners Manuals

120-140 Owners Manual, 1946-1948	UP123-13	\$11.48
140A Owners Manual, 1949-1951	UP124-13	\$17.52
150 Owners Manual, 1959-1960.....	P187-13	\$41.88
150A Owners Manual, 1961.....	P220-13	\$41.40
150B Owners Manual, 1962.....	D123-13	\$38.00
150C Owners Manual, 1963	D156-13	\$42.53
150D Owners Manual, 1964.....	D208-13	\$56.40
150E Owners Manual, 1965	D251-13	\$52.18
150F Owners Manual, 1966	D326-13	\$50.55
150G Owners Manual, 1967.....	D397-1-13	\$45.25
150H Owners Manual, 1968.....	D518-13	\$45.82
150J Owners Manual, 1969.....	D624-13	\$47.00
150K Owners Manual, 1970	D727-13	\$41.40
150L Owners Manual, 1971	D836-13	\$41.40
150L Owners Manual, 1972	D901-13	\$41.40
150L Owners Manual, 1973	D962-13	\$47.00
150L Owners Manual, 1974	D1013-13	\$41.40
150M Owners Manual, 1975	D1033-13	\$49.24
170 Owners Manual, 1948	UD376-13	\$17.44
170A Owners Manual, 1949-1951	UP125-13	\$17.52
170B Owners Manual, 1952-1955.....	UP213-13	\$17.52
170B Owners Manual, 1956.....	UP130-13	\$17.52
172 Owners Manual, 1956	P130A-13	\$48.11
172 Owners Manual, 1957-1958.....	P181-13	\$45.31
172 Owners Manual, 1959	P168-13	\$41.40
172A Owners Manual, 1960.....	P188-13	\$46.00
172B Owners Manual, 1961	D880-13	\$45.31
172C Owners Manual, 1962	D124-13	\$41.40
172D Owners Manual, 1963.....	D157-13	\$45.82

172E Owners Manual, 1964	D209-13	\$41.48
172F Owners Manual, 1965	D615-13	\$41.08
172G Owners Manual, 1966	D616-13	\$41.40
172H Owners Manual, 1967	D638-13	\$41.40
172I Owners Manual, 1968	D584-13	\$41.40
172K Owners Manual, 1969	D625-13	\$47.65
172K Owners Manual, 1970	D742-13	\$41.40
172L Owners Manual, 1971	D837-13	\$35.81
172L Owners Manual, 1972	D902-13	\$36.76
172M Owners Manual, 1973	D964-13	\$41.08
172M Owners Manual, 1974	D1016-13	\$42.96
172M Owners Manual, 1975	D1036-13	\$47.30
175 Owners Manual, 1958	P175-13	\$47.00
175 Owners Manual, 1959	P175A-13	\$41.40
175A Owners Manual, 1960	P197-13	\$41.40
175B Owners Manual, 1961	P225-13	\$41.40
175C Owners Manual, 1962	D125A-13	\$41.40
177 Owners Manual, 1968	D519-13	\$41.40
177A Owners Manual, 1969	D627-13	\$41.40
177B Owners Manual, 1970	D743-13	\$41.40
177B Owners Manual, 1971	D838-13	\$41.40
177B Owners Manual, 1972	D903-13	\$41.40
177B Owners Manual, 1973	D966-13	\$41.40
177B Owners Manual, 1974	D1018-13	\$41.40
177B Owners Manual, 1975	D1037-13	\$41.40
177RG Owners Manual, 1971	D862-13	\$41.40
177RG Owners Manual, 1972	D905-13	\$41.40
177RG Owners Manual, 1973	D966-13	\$41.40
177RG Owners Manual, 1974	D1019-13	\$41.40
177RG Owners Manual, 1975	D1039-13	\$41.40
180 Owners Manual, 1953	P131B-13	\$41.40
180 Owners Manual, 1954	P131-13	\$41.40
180 Owners Manual, 1955	P132-13	\$41.40
180 Owners Manual, 1956	P133-13	\$41.40
180A Owners Manual, 1957	P136-13	\$37.46
180A Owners Manual, 1958	P136A-13	\$41.40
180B Owners Manual, 1959	P170-13	\$43.22
180C Owners Manual, 1960	P198-13	\$41.40
180D Owners Manual, 1961	P231-13	\$41.40
180E Owners Manual, 1962	D127-13	\$41.40
180F Owners Manual, 1963	D158-13	\$41.40
180G Owners Manual, 1964	D210-13	\$41.40
180H Owners Manual, 1965	D264-13	\$41.40
180H Owners Manual, 1966	D335-13	\$41.40
180H Owners Manual, 1967	D413-13	\$41.40
180H Owners Manual, 1968	D521-13	\$41.40
180H Owners Manual, 1969	D692-13	\$47.00
180H Owners Manual, 1970	D765-13	\$41.40
180H Owners Manual, 1971-1972	D946-13	\$41.40
180J Owners Manual, 1973	D1000-13	\$41.40
180J Owners Manual, 1974	D1020-13	\$41.40
180J Owners Manual, 1975	D1040-13	\$41.40
182 Owners Manual, 1956	P134-13	\$49.00
182A Owners Manual, 1957-1958	D139-13	\$45.96
182B Owners Manual, 1959	P171-13	\$45.38
182C Owners Manual, 1960	P189-13	\$41.40
182D Owners Manual, 1961	P230-13	\$41.40

182E Owners Manual, 1962	D130-13	\$47.00
182F Owners Manual, 1963	D161-13	\$41.40
182G Owners Manual, 1964	D219-13	\$44.62
182H Owners Manual, 1965	D282-13	\$41.40
182J Owners Manual, 1966	D348-13	\$47.00
182K Owners Manual, 1967	D439-13	\$41.40
182L Owners Manual, 1968	D548-13	\$41.40
182M Owners Manual, 1969	D647-13	\$41.40
182N Owners Manual, 1970	D754-13	\$45.25
182N Owners Manual, 1971	D855-13	\$47.00
182P Owners Manual, 1972	D906-13	\$49.02
182P Owners Manual, 1973	D1003-13	\$47.00
182P Owners Manual, 1974	D1021-13	\$45.82
182P Owners Manual, 1975	D1041-13	\$43.22
185 Owners Manual, 1961	D101-13	\$45.25
185A Owners Manual, 1962	D129-13	\$47.00
185B Owners Manual, 1963	D159-13	\$41.40
185C Owners Manual, 1964	D211-13	\$41.40
185D Owners Manual, 1965	D265-13	\$41.40
185E Owners Manual, 1966	D360-13	\$41.40
A185E Owners Manual, 1967	D412-13	\$41.40
A185E Owners Manual, 1969	D695-13	\$41.40
A185E Owners Manual, 1970	D772-13	\$41.40
A185E Owners Manual, 1971-1972	D937-13	\$47.00
A185F Owners Manual, 1973	D1001-13	\$47.00
A185F Owners Manual, 1974	D1022-13	\$41.40
A185F Owners Manual, 1975	D1042-13	\$41.40
190, 195, 195A and 195B Owners Manual, 1946-1953	P138-13	\$45.25

Cessna Parts from Atlee Dodge

Description	Part #	Price
Exhaust Deflector Assembly, C-206 • STC	3238	\$800.00
Boarding Ladder, C-206 • STC	3193	\$1,052.00
Exhaust Clamp, C-206*	AD1250259-1	\$439.00
Ski Attach Kit, C-170, 180, 185, 206*	CE1001	\$325.00
Powder Coated Step, C-185*	8013-01	\$390.50
Water Rudder Lift Handle, C-180, 185, 206*	3359-1	\$440.00

*FAA 337 required

Cessna Jump Seats

STC APPROVED

Folds and removes in seconds. Seats do not come upholstered. Fits Cessna 170 through 185 including 182E through 182R and later wide body jump seats. STC'd and in stock.



Left	3187L	\$2,040.00
Right	3187R	\$2,040.00
Kit (includes installation hardware, left and right seats)	3187KIT	\$4,080.00

CESSNA PARTS FROM ATLEE DODGE

Cessna Seat Track Tie Down



For Cessna 208 series

- Adds cargo tie down capability to new HD Cessna seat rails (not included)
- Priced and sold individually
- Applicability: Cessna C208, C208A, C208B
- Made of aluminum anodized green

Seat Track Tie Down TDC-208 **\$112.89**

For Cessna 150 thru 210 series

- Clamps onto existing seat tracks to provide for a secure tie down
- Priced and sold individually
- Seat tracks not included
- Aluminum, anodized red with steel bolt
- STC SA02359AK-D

Seat Track Tie Down 8006 **\$81.25**



Intake Hose Heat Shrouds



- Applicability: Cessna 180, 185, 206, 207, 210
- Stainless steel

Intake Hose Heat Shrouds 3274 **\$33.00**



Cessna Muffler Shroud

- FAA-PMA approved for Cessna 180, 185
- Heavy duty

Muffler Shroud 4236 **\$560.00**



Universal Handle and Doubler

- Applicability: Cessna 180H, 180J, A185E, A185F, U206 Series
- Stainless steel

Boot Cowl Handle 3354H.... **\$110.50**
Doubler 3354D..... **\$12.84**



Heavy Duty Seat Back Frame



- Applicability: Cessna 206, 207
- More durable than stock seat back
- Constructed of 6061-T6 solid stock aluminum (not tubing)
- Hinges are solid stock as well – seat frame will not bend or crack at hinge mounts

3226AD **\$585.00**

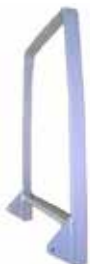

Universal Boot Cowl Step

- Applicability: Cessna U206, U206A, U206B, U206C, U206D, U206E, U206F, U206G, TU206A, TU206B, TU206C, TU206D, TU206E, TU206F, TU206G, P206, and TP206A series aircraft
- Powder coated white
- Cessna style step



Boot Cowl Step.....3354-S **\$93.00**

Cessna Battery Rack Firewall

- Applicability: Cessna 170, 170A, 170B, 180 through 180K, 185 through 185E
- Battery not included
- STC approved



Battery Rack..... 8008-01..... **\$514.00**

Cessna 120 – 140

Engine Parts

Engine Attach Spacer 0450195 **\$177.29**
Mixture Control Clamp 0450258 **\$272.95**
Oil Temperature Gauge Adapter..... 0450261 **\$327.54**

Engine Mount Assembly



For Cessna 120-140.....U0451000 **\$1,427.72**
For Cessna 140AU0451111 **\$1,635.38**

Small Skull Cap Spinner



- Applicability: Cessna 120/140
- Dome diameter: 5.125 inches outside diameter
- Spinner assembly may not fit all taper shaft installations



Spinner Dome and Bracket.....SM-SPIN-ASY **\$89.33**
Spinner DomeU0450279 **\$76.50**
Bracket.....U0450281 **\$22.85**

Continental Engine Mount Bushings

- Rubber
- Used on all A and C series Continental engines
- 8 required per installation
- Priced and sold individually



Engine Mount Bushings U22387A **\$6.18**

Sales: 1-877-332-8533
www.fadodge.com

Landing Gear

Brake Disc Cover Plate.....	0441126.....	\$4.13
Axle Nut.....	0441130.....	\$445.00
Tail Spring Attach Stiffener.....	0442115.....	\$482.04
Tailwheel Steering Chain Guard.....	U0442125.....	\$52.26
Tail Spring Shackles.....	U0442122.....	\$72.07
Tail Spring Abrasion Strip.....	U0442124.....	\$66.17

All Metal Cowling



- Applicability: Cessna 120, 140, 140A



1946 Cowling Parts

Lower Cowling Skin, Left.....	U0452126-3.....	\$1,400.92
Right.....	U0452126-5.....	\$1,400.92
Nose Cowling Only.....	U0452124.....	\$1,015.71

1947 and 1948 Cowling Parts

Center Cowling Support.....	U0452187.....	\$635.96
Lower Cowling Skin, Left.....	U0452189-3.....	\$1,202.73
Right.....	U0452189-5.....	\$1,202.73
Nose Cowling Blank.....	U0452185.....	\$1,015.71

120-140 Cowling Grilles



- Applicability: Cessna 120, 140
- Also approved for 170, 170A and 170B through serial number 25372



Left Cowling Grille.....	U0452207.....	\$253.49
Right Cowling Grille.....	U0452207-1.....	\$253.49

Landing Gear Bulkheads



Left.....	U0411495.....	\$1,900.39
Right.....	U0411495-1.....	\$1,900.39

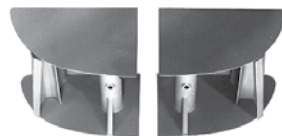

Air-Maze Air Filter

- Applicability: C-85 and C-90 engines
- Use with A50256 housing
- Supersedes part number 40599

Air Filter.....	600314.....	\$94.11
-----------------	-------------	----------------



Instrument Panel Shock Mount

J6984-8.....	\$8.16
--------------	---------------



Magneto Noise Filter

A293.....	\$190.14
-----------	-----------------



Tailwheel Springs



Early 120-140, Complete Set

Serial numbers 8001 to 14026 (top picture).....	U120-140E.....	\$291.86
---	----------------	-----------------

Serial numbers 14027 and up (bottom picture).....	U120-140.....	\$287.47
---	---------------	-----------------

120-140, Main Leaf Only

Serial numbers 8001 to 14026.....	U0442106.....	\$76.34
-----------------------------------	---------------	----------------

Serial numbers 14027 and up.....	U0442106-2.....	\$83.96
----------------------------------	-----------------	----------------

Individual Leaves

Tailwheel Leaf Spring.....	U0442107.....	\$49.14
----------------------------	---------------	----------------

Tailwheel Leaf Spring.....	U0442108.....	\$85.32
----------------------------	---------------	----------------

Tailwheel Leaf Spring.....	U0442108-2.....	\$93.86
----------------------------	-----------------	----------------

Tailwheel Leaf Spring.....	U0442109-2.....	\$54.28
----------------------------	-----------------	----------------

Tailwheel Leaf Spring.....	U0442110.....	\$106.27
----------------------------	---------------	-----------------

Tailwheel Leaf Spring.....	U0442110-2.....	\$64.75
----------------------------	-----------------	----------------

Rear Carry-thru Spar



For Cessna 120/140.....	U0411476.....	\$636.45
-------------------------	---------------	-----------------

Lift Strut Rod Ends

Front Rod End.....	U0422012.....	\$124.60
--------------------	---------------	-----------------

Rear Rod End.....	U0422316.....	\$103.78
-------------------	---------------	-----------------

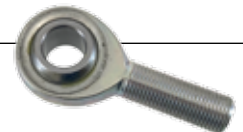

Fuel Valve Kit



This replacement valve will mount in the same position as the original OEM valve. It uses the same tank selector plate and the same mounting hardware as the original. Sold as a kit.

- Applicability: Cessna 120-140 with Continental C-85-12, C-85-12F, C-90-12F, C-90-14F and Lycoming O-235-C1 engines

NOTE: Valve positions are LEFT/RIGHT/OFF. There is no position for both tanks.

U0411716-500.....	\$537.53
-------------------	-----------------



Tail Surface Skins

FAA-PMA
APPROVED

- Elevator skins must be purchased in pairs (top and bottom) to insure matching corrugations

Top Elevator Skin

Assembly, Left.....	U0434141	\$296.02
Right.....	U0434140	\$296.02
Skin Only, Left.....	U0434141-1	\$176.61
Right.....	U0434140-1	\$168.29

Bottom Elevator Skin

Assembly, Left.....	U0434142	\$296.02
Right.....	U0434134	\$366.68
Skin Only, Left.....	U0434142-1	\$176.61
Right.....	U0434134-1	\$168.29

Tail Surfaces

Fin Assembly.....	U0431000	\$3,184.86
Front Fin Spar.....	U0431115	\$56.91
Fin Hinge Bushing.....	U0431119	\$8.73
Top Fin Hinge.....	U0431120	\$89.71
Lower Fin Skin.....	U0431128	\$418.29
Rear Fin Spar.....	U0431130	\$131.92
Lower Fin Rib.....	U0431135	\$174.18
Fin Rib.....	U0431136	\$109.05
Fin Rib.....	U0431137	\$82.94
Upper Fin Rib.....	U0431138	\$62.81
Upper Fin Cap Assembly.....	U0431139	\$460.96
Fin Spar Reinforcement.....	U0431145*	\$12.21
Fin Spar Reinforcement.....	U0431145-1*	\$13.49
Stabilizer Assembly.....	U0432000-3	\$8,818.24
Leading Edge Inboard Stabilizer, Left.....	U0432158	\$123.89
Right.....	U0432158-1	\$123.89
Leading Edge Outboard Stabilizer.....	U0432159	\$156.50
Rudder Assembly.....	U0433000-14	\$3,138.55
#1 Rudder Rib.....	U0433106-2	\$38.53
Rudder Tip.....	U0433111	\$224.99
Rudder Bellcrank.....	U0433113	\$405.45
Tail Light Mount Support.....	U0433121	\$59.26
Rudder Spar.....	U0433125	\$205.75
Rudder Tab.....	U0433127	\$18.02

* To comply with AD 50-31-01

Wing Drag Wires

FAA-PMA
APPROVED

For 120, 140

Wing Bay #1.....	U0422008-1	\$72.97
Wing Bay #2.....	U0422008-2	\$72.97
Wing Bays #3, #4.....	SAE0422008-4*	\$86.32

* Complies with AD 48-25-3 for C-120/140. Provides for use with standard AN365-1032 nuts.

Shop online at www.univair.com

Horizontal Stabilizer

FAA-PMA
APPROVED

U0432000-3
\$8,818.24



Wings

Wing Fabric Clip.....	US43	\$0.68
Aileron Control Bushing (0411489).....	NAS382-2	\$97.25
Flap Control Bushing (0411490).....	NAS382-1	\$237.85
Elevator Control Pulley Bushing.....	0411491	\$92.30
Wing Strut Front Rod End.....	U0422012	\$124.60
Nose Rib.....	0422138-3	\$157.00
Center Rib Section.....	0422212	CALL
Aileron Hinge Inner Race Bushing.....	U0422215	\$47.96
Upper Front Strut Bushing.....	0422261	\$1,280.00
Aileron Bellcrank Bushing.....	0422280	\$36.61
Rear Strut Attach Bolt.....	U0422297	\$106.87
Rear Strut Rod End.....	U0422316	\$103.78
Nose Rib.....	U0422337	\$88.11
Tip Spar, Right.....	0423113-1	\$215.07
Wingtip Spar, Left.....	U0423300-4	\$203.61
Right.....	U0423300-5	\$176.20
Flap, Left.....	0425000	\$2,557.85
Right.....	0425000-1	\$2,557.85
Wing Flap Hinge.....	U0425113	\$57.81
Flap Fitting, Left.....	U0425118	\$218.24
Right.....	U0425118-1	\$218.24

Aileron

FAA-PMA
APPROVED

- Excludes aileron pushrods
- Additional Crating Charge CR14 will be added to shipping charges

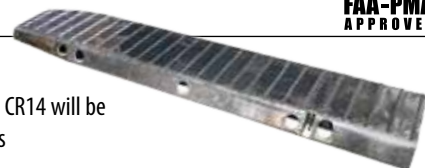

Left.....	U0424000-2	\$2,462.86
Right.....	U0424000-3	\$2,462.86

Elevator Assemblies

FAA-PMA
APPROVED

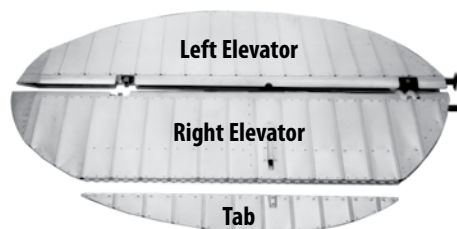

Elevator Assembly		
Right.....	U0434137	\$4,026.74
Right with Trim Tab.....	0434137A	\$4,624.25
Left.....	U0434139	\$2,439.87
Trim Tab.....	0434135	\$597.50
Trim Tab Pushrod.....	0434127	\$490.66

Frame

Frame Spar Bearing Block	0411129	\$1,244.41
Cabin Door Window Hinge	U0411185-7	\$71.78
Rudder Pedal Arm	0411307	\$252.52
Lower Door Sill Support	0411345	\$108.00
Rudder Pedal Shaft	0411369-2	\$90.70
Lower Door Hinge	0411579	\$599.00
Door Catch Striker	0411582	\$256.74
Upper Door Hinge, Left	0411597	\$836.00
Right.....	0411597-1	\$486.00
Landing Gear Fillet, Left.....	U0411762	\$25.72
Right.....	U0411762-1	\$25.13
Return Spring, Left.....	0411837-1	\$157.05
Nut.....	0411849	\$13.58
Tail Post Bulkhead.....	0412169	\$2,001.13
Starter Button Housing.....	0413015	\$9.48
Washer.....	0413228	\$78.86
Lower Cowl Reinforcement	U0452192	\$183.81

Leading Edge Tip Skins



Left	U0423112.....	\$834.85
Right.....	U0423112-1.....	\$834.85



Aluminum Gearbox Bulkhead

- Applicability: Cessna 120, 140, 140A



Front Bulkhead	0411120	\$454.07
Rear Bulkhead.....	0411109	CALL

Rudder Bellcrank



U0433113	\$405.45
----------------	-----------------



Tailwheel Bracket Assembly



U0412139	\$1,089.22
----------------	-------------------

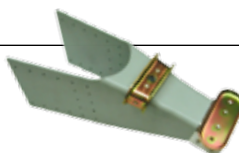

Lift Struts



- New, improved steel struts – sealed and oiled to prevent internal corrosion

Left	U0422340-8.....	\$2,374.38
Right.....	U0422340-9.....	\$2,374.38

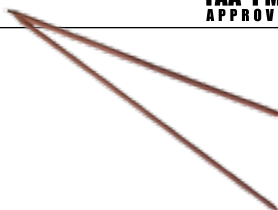

Lever Type Window Latches



- FAA-PMA
- Ivory colored knob only
- Latch finishes: polished and unpolished

Latch Assembly

- 120, 140, 140A, 170, 170A, 170B – serial numbers 20267 to 25372)
- U0413362-2 replaces Cessna 0411186 and 0411186-3

Unpolished.....	U0413362-2	\$402.95
Polished	U0413362-2+	\$492.55

- 170B (serial numbers 25373 and up), 172, 175, 180 and 182

Unpolished.....	U0413362-3	\$402.95
Polished	U0413362-3+	\$492.55

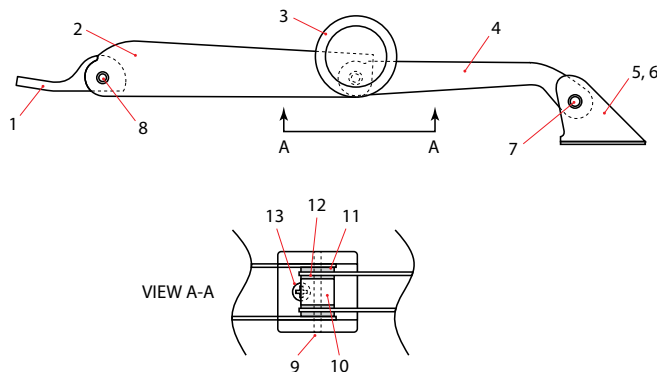

Latch Components Sold Separately:

1) Mounting Arm (bracket)		
(for -2 assembly)	U0413362-8	\$49.34
(for -3 assembly)	U0413362-9	\$50.75
2) Bracket	U0413362-13	\$81.49
3) Knob, Ivory	U0413359	\$22.10
4) Extension Arm	U0413362-12	\$81.49
5) Angle (left side).....	U0413362-10	\$8.52
6) Angle (right side).....	U0413362-11	\$8.52
7) Pin	U0413362-14	\$20.04
8) Pin	U0413362-16	\$20.04
9) Pin	U0413362-15	\$20.04
10) Spacer.....	U0413362-7	\$10.04
11) Flat Washer (2 required)	NAS1149F0363P	\$0.04
12) Flat Washer, Light (2 required).....	NAS1149F0332P	\$0.04
13) Screw.....	4X3/8-TRA	\$0.10

Concorde Batteries



- Applicability: Cessna 120, 140, and 140A
- Valve regulated sealed lead acid batteries

12 Volt, 22 Amp Hour.....	RG-25	\$294.95
12 Volt, 24 Amp Hour, Extra Capacity	RG-25XC	\$344.00
12 Volt, 29 Amp Hour.....	RG-35A	\$373.00
12 Volt, 33 Amp Hour, Extra Capacity	RG-35AXC	\$403.00

Cowl Latches and Details



- Applicability: Cessna 120, 140 and 170 series

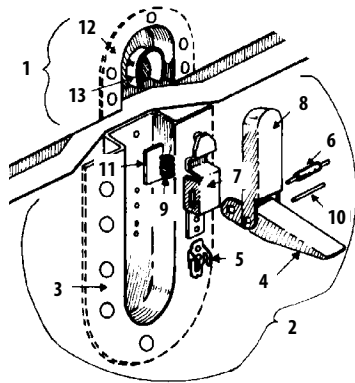

Hook and Lever Assemblies

- 1) Hook Assembly
U0452108..... **\$117.90**
- 2) Lever Assembly
U0452119..... **\$384.25**

Detail Parts

- 3) RecessU0452109 **\$41.87**
- 4) LeverU0452110 **\$31.93**
- 5) Clip.....U0452111 **\$29.93**
- 6) Pin.....U0452112 **\$17.34**
- 7) Housing.....U0452113 **\$32.09**
- 8) HookU0452114 **\$41.65**
- 9) SpringU0452115 **\$22.39**
- 10) Pin.....U0452120 **\$17.20**
- 11) ShimU0452121 **\$2.40**
- 12) RecessU0452122 **\$63.87**
- 13) HookU0452123 **\$61.23**

Control Cables



Cable descriptions are basic. Please consult your aircraft parts manual for proper cable application for your model and serial number.

Galvanized Steel

- Wheel to Aileron Cable, 285.0"..... U0400107-1 **\$149.78**
- Aileron Carry-Thru Cable, 222.5" U0400107-2 **\$124.72**
- Flap Control Cable, 73.75" U0400107-3 **\$67.70**
- Rudder Control Cable, 193.125"..... U0400107-4 **\$106.36**
- Elevator Up Control Cable, 167.0"..... U0400107-5 **\$112.78**
- Elevator Tab Aft Cable, 123.25"..... U0400107-7 **\$95.89**
- Elevator Tab Forward Cable, 58.75"..... U0400107-8 **\$89.71**
- Elevator Down Cable, 164.5" U0400107-9 **\$111.79**
- Flap Control Cable, 76.8125"..... U0400107-10 **\$70.68**
- Elevator Tab Carry-Thru Forward Cable, 124.5"..... U0400107-11 **\$80.97**
- Elevator Tab Carry-Thru Aft Cable, 59.125"..... U0400107-12 **\$68.37**
- Elevator Tab Aft Direct Cable, 77.125"..... U0400107-13 **\$85.29**
- Elevator Tab Forward Direct Cable, 104.875"..... U0400107-14 **\$88.53**
- Wheel to Aileron Cable, 302.0"..... U0400107-17 **\$164.38**
- Aileron Carry-Thru Cable, 263.75"..... U0400107-18 **\$136.03**

Stainless Steel

- Wheel to Aileron Cable, 285.0"..... U0400107-101 **\$217.30**
- Aileron Carry-Thru Cable, 222.5" U0400107-102 **\$173.63**
- Flap Control Cable, 73.75" U0400107-103 **\$110.58**
- Rudder Control Cable, 193.125"..... U0400107-104 **\$162.37**
- Elevator Up Control Cable, 167.0"..... U0400107-105 **\$122.15**
- Aft Elevator Tab Cable, 123.25"..... U0400107-107 **\$147.45**

- Forward Elevator Tab Cable, 58.75" U0400107-108 **\$98.27**
- Down Elevator Control Cable, 164.5" U0400107-109 **\$113.03**
- Flap Control Cable, 76.8125" U0400107-110 **\$124.11**
- Elevator Tab Carry-Thru Forward Cable, 124.5"..... U0400107-111 **\$108.01**
- Elevator Tab Carry-Thru Aft Cable, 59.125"..... U0400107-112 **\$98.28**
- Elevator Tab Aft Direct Cable, 77.125"..... U0400107-113 **\$130.15**
- Elevator Tab Forward Direct Cable, 104.875"..... U0400107-114 **\$130.25**
- Wheel to Aileron Cable, 302.0"..... U0400107-117 **\$244.64**
- Aileron Carry-Thru Cable, 263.75"..... U0400107-118 **\$265.42**

Propellers

Univair furnishes a bolt kit with each propeller purchase. Bolt kits can also be purchased separately from our website.

Propeller descriptions below show basic aircraft/engine model applicability. Check manufacturer's websites for exact applicability before purchasing, or contact our sales staff at 1-888-433-5433 and we can research it for you.

Please note that we do not stock all of the propellers listed. Non-stocked items may have up to a 6 week lead time.

- McCaughey, Aluminum, 120, 140, Cont C-85 CM7142 **\$4,728.80**
- McCaughey, Aluminum, 120, 140 Seaplane, Cont C-85..... CM7144 **\$4,870.66**
- McCaughey, Aluminum, 120, 140, 140A, Cont C-85..... CM7146 **\$4,728.80**
- McCaughey, Aluminum, 120, 140, 140A, Cont C-85..... CM7148 **\$4,728.80**
- McCaughey, Aluminum, 120, 140, 140A, Cont C-85..... CM7150 **\$4,728.80**
- McCaughey, Aluminum, 120, 140, 140A, Cont C-90..... CM7152 **\$4,728.80**
- McCaughey, Aluminum, 120, 140, 140A, Cont C-90..... CM7154 **\$4,728.80**
- McCaughey, Aluminum, 120, 140, 140A, Cont C-90..... CM7343 **\$4,728.80**
- Sensenich, Aluminum, 120S, 140S, Cont C-85 76AK-2-40 **\$4,956.50**
- Sensenich, Aluminum, 120, 140, Cont C-85..... 76AK-2-42 **\$5,004.25**
- Sensenich, Aluminum, 120, 140, Cont C-85..... 76AK-2-44 **\$4,956.50**
- Sensenich, Aluminum, 140, Cont C-90..... W72GK50-CUB **\$3,125.00**
- Sensenich, Wood, 140, Cont C-90..... W72GK50-SB **\$3,125.00**
- Sensenich, Wood, 120, 140, Cont C-85..... W72GK46 **\$3,090.00**
- Sensenich, Wood, 120, 140, Cont C-85..... W72GK48 **\$3,090.00**
- Sensenich, Wood, 140, Cont C-90..... W72GK50 **\$3,090.00**

Windows • Windshields

Prices below are for clear windows and windshields only. Please see our website for prices and availability of Solar Gray and Green tinted versions.

- Windshield (S/N 8001 to 8799).....0411172-3 **\$406.89**
- Windshield (S/N 8800 and up).....0411172-5 **\$406.89**
- Windshield, 140A only, 1949-19510413419-203 **\$397.24**
- Left or Right Door Window.....0411182 **\$80.93**
- Left or Right Rear Window0412145 **\$62.37**
- Skylight.....0411144 **\$67.57**

Shop Online: www.univair.com
Order By Phone: 1-888-433-5433
 Monday to Friday • 7:30 am to 5:00 pm MT

Cessna 150 – 152

150–152 Engine Mounts

FAA-PMA APPROVED

Serial Numbers 17001 to 59215.....	U0451114-1	\$1,206.63
Serial Numbers 59216 to 64532.....	U0451114-29	\$1,150.89
Serial Numbers 64533 to 71128.....	U0451114-32	\$1,150.89
Serial Numbers 71129 and up*.....	U0451120-1	\$1,761.68
Cessna 152 Mount.....	L0451003	\$2,463.21

* Not suitable for A150 Aerobats

150 Spinner Assembly

• Applicability: Cessna 150F, G, H, J, K



1) Front Plate, OEM (Plastic)	0450039-1-791	\$576.15
2) Rear Plate	U0450040-1	\$544.90
3) Spinner Dome.....	U0450027-12	\$453.42

150–152 Landing Gear Shims

Landing Gear Shim.....	0441157-1	\$58.29
Landing Gear Shim.....	0441157-2	\$298.78
Landing Gear Shim.....	0441157-3	\$121.47

150 Wings

Landing Light Shield, Left.....	0423564-1	\$419.89
---------------------------------	-----------------	-----------------

Windows • Windshields

Prices below are for clear windows and windshields only. Please see our website for prices and availability of Solar Gray and Green tinted versions.

150 Windshield (S/N 17001 to 67198 and 69309 to 73658).....	0413419-203	\$397.24
152 Rear Window.....	0412020-10	\$314.08

Concorde Batteries

• Applicability: Cessna 150 and 152 Series
• Valve regulated sealed lead acid batteries



12 Volt, 22 Amp Hour.....	RG-25	\$294.95
12 Volt, 24 Amp Hour, Extra Capacity.....	RG-25XC	\$344.00
12 Volt, 29 Amp Hour.....	RG-35A	\$373.00
12 Volt, 33 Amp Hour, Extra Capacity.....	RG-35AXC	\$403.00

Propellers



Univair furnishes a bolt kit with each propeller purchase. Bolt kits can also be purchased separately from our website.

Propeller descriptions below show basic aircraft/engine model applicability. Check manufacturer's websites for exact applicability before purchasing, or contact our sales staff at 1-888-433-5433 and we can research it for you.

Please note that we do not stock all of the propellers listed. Non-stocked items may have up to a 6 week lead time.

McCauley, Aluminum

FRA150L, M, Rolls Royce O-240.....	BRM7150	\$5,345.60
150G–K, Continental O-200.....	CF7535	\$4,728.80
150G–K, Continental O-200.....	CF7538	\$4,728.80
150G–K, Continental O-200.....	DCM6948	\$5,505.97
150–F150 Series, Continental O-200	MCM6950	\$5,345.60

Sensenich, Aluminum

150L–M, A150L–M, Continental O-200	69CK512-0-50	\$4,520.50
150L–M, A150L–M, Continental O-200	69CK512-0-52	\$4,520.50
152, Lycoming O-235	72CK56-0-52	\$4,600.50
152, Lycoming O-235.....	72CK56-0-54	\$4,600.50
152, Lycoming O-235.....	72CK56-0-56	\$4,600.50
150 Series, Lycoming O-320.....	74DM655-0-58	\$4,852.50

Control Cables

FAA-PMA APPROVED

Cable descriptions are basic. Please consult your aircraft parts manual for proper cable application for your model and serial number.

Galvanized Steel

Rudder Control Cable, 193.125"	U0400107-4	\$106.36
Elevator Up Control Cable, 167".....	U0400107-5	\$112.78
Elevator Down Cable, 164.5".....	U0400107-9	\$111.79
Elevator Tab Carry-Thru Forward Cable, 124.5".....	U0400107-11	\$80.97
Aileron Carry-Thru Cable, 262.875"	U0400107-21	\$153.83
Flap Extend Forward Cable, 68.5".....	U0400107-22	\$83.01
Flap Retract Forward Cable, 100".....	U0400107-23	\$83.01
Flap Retract Cable, 96.75".....	U0400107-26	\$87.39
Tab Actuator to Disconnect Cable, 56.25".....	U0400107-28	\$76.98
Tab Wheel to Turnbuckle Cable, 100.0".....	U0400107-29	\$84.80
Tab Actuator to Turnbuckle Cable, 76.875".....	U0400107-30	\$86.04
Aileron Cable, 307.625".....	U0400107-31	\$166.66
Flap Retract Cable, 94.75".....	U0400107-33	\$81.95
Flap Extend Cable, 103.875".....	U0400107-34	\$75.23
Aileron Cable, 293".....	U0400107-35	\$140.37
Aileron Cable, 232.75".....	U0400107-36	\$199.03
Flap Retract Forward Cable, 68.0".....	U0400107-37	\$74.82
Flap Retract Cable, 58.5".....	U0400107-38	\$70.19
Flap Extend Forward Cable, 55.375".....	U0400107-39	\$81.95
Flap Extend Cable, 49.375".....	U0400107-40	\$70.55
Aileron Cable, 233.75".....	U0400107-41	\$144.65
Elevator Tab Forward Direct Cable, 169.875".....	U0400107-42	\$115.36

CESSNA 150-152 • CESSNA 170-177

Elevator Tab Carry-Thru Cable, 147.375".....	U0400107-43.....	\$116.78
Flap Control Cable, 63.375".....	U0400107-45.....	\$50.60
Flap Control Cable, 47.625".....	U0400107-46.....	\$49.17
Rudder Forward Cable, 32.25".....	U0400107-47.....	\$73.42
Rudder Aft Cable, 159.625".....	U0400107-48.....	\$113.06
Rudder Cable, Left, 191.75".....	U0400107-49.....	\$126.80
Rudder Cable, Right, 193".....	U0400107-50.....	\$121.66
Elevator Tab Forward Cable, 173.75".....	U0400107-52.....	\$99.68
Elevator Tab Forward Direct Cable, 150".....	U0400107-53.....	\$99.68
Elevator Tab Forward Cable, 176.62".....	U0400107-54.....	\$99.68
Elevator Tab Forward Direct Cable, 153.87".....	U0400107-55.....	\$85.43
Elevator Tab Forward Cable, 176.12".....	U0400107-56.....	\$88.28
Elevator Tab Aft Carry-Thru Cable, 57.5".....	U0400107-57.....	\$68.40
Aileron Crossover Cable, Right, 126.81".....	U0400107-58.....	\$92.63
Aileron Crossover Cable, Left, 140.63".....	U0400107-59.....	\$92.63
Aileron Cable, 108.75".....	U0400107-60.....	\$72.61
Aileron Direct Cable, Left, 128.0".....	U0400107-61.....	\$86.93
Elevator Up Aft Cable, 76.56".....	U0400107-63.....	\$83.72
Elevator Down Aft Cable, 74.0".....	U0400107-64.....	\$134.67
Aileron Direct Cable, Right, 129.56".....	U0400107-65.....	\$91.13
Elevator Forward Cable, 94.44".....	U0400107-66.....	\$84.01

Stainless Steel

Rudder Control Cable, 193.125".....	U0400107-104.....	\$162.37
Elevator Up Control Cable, 167".....	U0400107-105.....	\$122.15
Down Elevator Control Cable, 164.5".....	U0400107-109.....	\$113.03
Elevator Tab Carry-Thru Forward Cable, 124.5".....	U0400107-111.....	\$108.01
Aileron Carry-Thru Cable, 262.875".....	U0400107-121.....	\$243.40
Flap Extend Forward Cable, 68.5".....	U0400107-122.....	\$117.90
Flap Retract Forward Cable, 100".....	U0400107-123.....	\$117.90
Flap Retract Cable, 96.75".....	U0400107-126.....	\$147.43
Tab Actuator to Disconnect Cable, 56.25".....	U0400107-128.....	\$103.41
Tab Wheel to Turnbuckle Cable, 100".....	U0400107-129.....	\$109.68
Tab Actuator to Turnbuckle Cable, 76.875".....	U0400107-130.....	\$115.50
Aileron Cable, 307.625".....	U0400107-131.....	\$294.88
Flap Retract Cable, 94.75".....	U0400107-133.....	\$128.72
Flap Extend Cable, 103.875".....	U0400107-134.....	\$108.27
Aileron Cable, 293".....	U0400107-135.....	\$196.75
Aileron Cable, 232.75".....	U0400107-136.....	\$211.20
Flap Retract Forward Cable, 68.0".....	U0400107-137.....	\$97.81
Flap Retract Cable, 58.5".....	U0400107-138.....	\$98.28
Flap Extend Forward Cable, 55.375".....	U0400107-139.....	\$94.32
Flap Extend Cable, 49.375".....	U0400107-140.....	\$93.40
Aileron Cable, 233.75".....	U0400107-141.....	\$192.35
Elevator Tab Forward Direct Cable, 169.875".....	U0400107-142.....	\$151.58
Elevator Tab Carry-Thru Cable, 147.375".....	U0400107-143.....	\$169.55
Flap Control Cable, 63.375".....	U0400107-145.....	\$75.04
Flap Control Cable, 47.625".....	U0400107-146.....	\$67.93
Rudder Forward Cable, 32.35".....	U0400107-147.....	\$86.02
Rudder Aft Cable, 159.625".....	U0400107-148.....	\$162.81
Rudder Cable, Left, 191.75".....	U0400107-149.....	\$155.39
Rudder Cable, Right, 193".....	U0400107-150.....	\$155.39
Rudder Centralizer Cable, 13.625".....	U0400107-151.....	\$66.35
Elevator Tab Forward Cable, 173.75".....	U0400107-152.....	\$100.17
Elevator Tab Forward Direct Cable, 150".....	U0400107-153.....	\$107.15
Elevator Tab Forward Cable, 176.62".....	U0400107-154.....	\$101.00
Elevator Tab Forward Direct Cable, 153.87".....	U0400107-155.....	\$121.49

Elevator Tab Forward Cable, 176.12".....	U0400107-156.....	\$122.34
Elevator Tab Aft Carry-Thru Cable, 57.5".....	U0400107-157.....	\$100.77
Aileron Crossover Cable, Right, 126.81".....	U0400107-158.....	\$123.97
Aileron Crossover Cable, Left, 140.63".....	U0400107-159.....	\$123.97
Aileron Cable, 108.75".....	U0400107-160.....	\$152.09
Aileron Direct Cable, Left, 128.0".....	U0400107-161.....	\$133.84
Elevator Up Aft Cable, 76.56".....	U0400107-163.....	\$113.05
Elevator Down Aft Cable, 74.0".....	U0400107-164.....	\$110.58
Aileron Direct Cable, Right, 129.56".....	U0400107-165.....	\$147.11
Elevator Forward Cable, 94.44".....	U0400107-166.....	\$132.38

Cessna 170 – 177

Nose Cowl

FAA-PMA
APPROVED

- Applicability: Cessna 170, 170A, and 170B through serial number 25372
- Aluminum



U0552000-13.....**\$1,217.63**

Air Temperature Gauge

This thermometer has both Centigrade and Fahrenheit dial graduations. It can be installed through Plexiglas® windshield or cowling on most aircraft or through the center strip in the windshield.



2716A.....**\$82.28**

Brake and Rudder Retainer Spring

Right.....0310196-3.....**\$63.36**

Left.....0310196-4.....**\$44.28**



170 Tail Surfaces

#3 Fin Rib.....0331108.....**\$33.46**

Concorde Batteries

- Applicability: Cessna 170 thru 177 Series
- Valve regulated sealed lead acid batteries



12 Volt, 22 Amp Hour.....RG-25.....**\$294.95**

12 Volt, 24 Amp Hour, Extra Capacity.....RG-25XC.....**\$344.00**

12 Volt, 29 Amp Hour.....RG-35A.....**\$373.00**

12 Volt, 33 Amp Hour, Extra Capacity.....RG-35AXC.....**\$403.00**

Control Cables

Cable descriptions are basic. Please consult your aircraft parts manual for proper cable application for your model and serial number.



Rudder Control Cable, 224 ⁷ / ₈ " GS.....	0510105-1	\$197.25
Elevator Control Cable, 177" GS	0510105-4	\$198.98
Flap Cable, 119.688" GS.....	0510105-5	\$84.06
Cessna Flap Cable, 43" GS	0510105-11	\$165.18
Aileron Cable, Direct, 347 ⁷ / ₈ " GS	0510105-12	\$212.04
Rudder Cable, SS.....	MC0510105-101	\$198.95
Tailwheel Steering Cable, SS	MC0510105-138	\$169.36

GS = Galvanized Steel • SS = Stainless Steel

Propellers

Univair furnishes a bolt kit with each propeller purchase. Bolt kits can also be purchased separately from our website.

Propeller descriptions below show basic aircraft/engine model applicability. Check manufacturer's websites for exact applicability before purchasing, or contact our sales staff at 1-888-433-5433 and we can research it for you.

Please note that we do not stock all of the propellers listed. Non-stocked items may have up to a 6 week lead time.



McCauley, Aluminum

170A, 170B, Franklin 6A4, Reconditioned.....	DM7652	\$5,345.60
170, 170A, 170B, 172, Continental O-300.....	DM7653	\$5,345.60
170A, 170B, Franklin 6A4.....	DM7654	\$5,505.97
170, 170A, 170B, 172, Continental C-145, O-300.....	MDM7653	\$5,505.97
170, 170A, 170B, Continental C-145	MDM7656	\$5,345.60
170A, 170B, Franklin 6A4.....	DM7649	\$5,345.60
172L-P, Lycoming O-320	DTM7553	\$5,345.60
172I-N, F172N, Lycoming O-320.....	DTM7557	\$5,612.88
172A-H, F172D-K, Continental O-300.....	EM7652	\$5,345.60
172I-N, F172L-N, Lycoming O-320.....	ETM8042	\$5,345.60
175 Seaplane, Continental G0-300.....	MFC8455	\$6,125.90
172A-H Seaplane, Continental O-300	SFC8040	\$5,345.60

Sensenich, Aluminum

170, Lycoming O-360	76EM855-0-54	\$4,896.50
170, 172, Lycoming O-360	76EM855-0-56	\$4,896.50
170 thru 175 Series, Lycoming O-360	76EM855-0-60	\$5,024.50
172-172C, Continental O-300	74DC-0-56	\$5,012.50
172, Lycoming O-300.....	74DR-0-56	\$4,972.50
172, 172A, 175, 177, Lycoming O-360	76EM8-0-52	\$4,860.50
172, 172A, 175, 177, Lycoming O-360	76EM8-0-54	\$4,860.50
172, 172A, 175, 177, Lycoming O-360	76EM8-0-57	\$4,860.50
172, 172A, 175, 177, Lycoming O-360	76EM8-0-58	\$4,860.50
172, 172A, 175, 177, Lycoming O-360	76EM8-0-60	\$4,860.50
172I-P, Lycoming O-320	74DM7-S14-58	\$4,856.50
172I-M, Lycoming O-320	74DM7-S14-60	\$4,856.50

172D-H Leading Edge Assembly

Leading Edge Assembly

Right.....	0523003-11	\$3,327.59
Left.....	0523005-55	\$1,092.01

170 Tailwheel Springs and Parts

**FAA-PMA
APPROVED**



Tailwheel Spring Assembly

C-170.....	U170	\$285.05
C-170 A and B (pictured).....	U170AB	\$278.74
Main Leaf Only.....	U0542106	\$122.12
Pawl (0442010-4).....	U3219A	\$36.57
Spring (0442010-5).....	U3222	\$14.13
Leaf Spring.....	U0442107	\$49.14
Leaf Spring.....	U0442108-2	\$93.86
Leaf Spring.....	U0442109-2	\$54.28
Attach Bushing	0442129-1	\$241.59
Attach Stiffener.....	0510000-33	\$592.35
Leaf Spring.....	U0542105	\$87.22

170 Wings

Drag Wires

Wing Bays #1, #2, length: 40.81 inches.....	U0422008-6	\$72.97
Wing Bay #3, length 42.63 inches	U0422008-5	\$72.97
Wing Bays #4, #5, length 45.69 inches.....	U0422008-4	\$54.37
Wing for 1948 Cessna 170, Uncovered, Right (without flaps, ailerons or tank)	0520002-15	\$11,896.36
Landing Light Window.....	0523115-5	\$80.93
Flap Control Spring	0523227	\$95.43
Nose Rib Assembly, Station 172.....	0523514-4	\$126.75
Gasket.....	0523532	\$39.25
Aileron Ribs		
#1, Left	0523808	\$82.52
#1, Right.....	0523808-2	\$30.74
#2, Left	0523809	\$39.78
#2, Right.....	0523809-1	\$48.82
#4, Left	0523811	\$75.84
Flap Trailing Edge Rib.....	0523923	\$80.79
Wingtip, Left or Right (for 170A and 170B, not 170).....	0623100	\$296.60
Nose Rib Assembly, Station 208.....	U0720608-26	\$103.96

Cessna 170 and Early 172

Spinner Assembly

**FAA-PMA
APPROVED**

• For Continental 8 hole flanges

Spinner Bulkhead.....	U0550162-3	\$192.12
Spinner Dome	U0550162-7	\$721.29
Spinner Assembly	U0550162	\$954.98



172 Spinners

FAA-PMA
APPROVED



- 1) Dome, for 172 A, B, C, D, E, F U0550228-28 **\$754.77**
(All aluminum dome – approved to replace original style “plastic” dome)
- 2) Rear Plate, for 172 A, B, C, D, E, F U0550228-26 **\$442.09**
- 3) Front Plate, for 172 A, B, C, D, E, F U0550228-3 **\$621.37**
- 4) Front Plate, for 172 I, K, L, M, N, P
and F172 L, M, N, P..... U0550321-4 **\$423.17**
- 4) Front Plate for 172P, Q, S/N 75869 – 76516 U0552231-1 **\$533.66**
- 5) Rear Plate, for 172 I, K, L, M, N, P, Q U0550321-010 **\$505.58**
- 6) Dome, for 172 G, H, I, K, L, M, N, P, Q
and F172 G, H, K, L, M, N, P U0550236-8 **\$567.37**

172 Cowl Oil Door

FAA-PMA
APPROVED

- Applicability: Cessna 172, A, B, C,
D, E, F, G, H, I, J, K, L, M, N, P, Q

- Cowl Oil Door U0552173-27 **\$361.30**
- Camloc Latch..... KM610-64 **\$56.35**

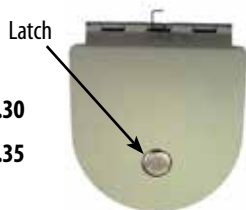

175 Frame Aft Section

- Applicability: Cessna 175, serial numbers 55001 to 56238

- Frame Aft Section0591201-4 **\$3,868.20**

172 – 175 Miscellaneous

- Latch Spring Replace KitSK172-16C **\$159.60**

Windows • Windshields

Prices below are for clear windows and windshields only. Please see our website for prices and availability of Solar Gray and Green tinted versions.

Cessna 170, 1948-1949 (Serial Numbers 18003 to 18728)

- Windshield.....0510000-6 **\$400.95**
- Left or Right Door Window.....0511106-3 **\$98.75**
- Left or Right Rear Window0512000-54 **\$74.99**

Cessna 170A, 1950-1951 (Serial Numbers 18729 to 20266)

- Windshield.....0510000-15 **\$421.00**
- Left or Right Door Window.....0511106-104 **\$98.75**
- Left or Right Rear Window0512000-54 **\$74.99**

Cessna 170B, 1952-1955 (Serial Numbers 20267 and up)

- Windshield.....0510001-6 **\$435.85**
- Left or Right Door Window.....0511106-104 **\$98.75**
- Left or Right Rear Window
S/N 20267 to 26504.....0512000-54 **\$74.99**
- S/N 26505 and up.....0591200-3 **\$72.02**

Cessna 172–177

- 172 Windshield (S/N 28000 to 47747)0510001-6 **\$435.85**
- 172 Windshield (S/N 47748 to 49544)0513300-16 **\$539.06**
- 172 Windshield (S/N 49545 to 50572)0513230-10 **\$559.10**
- 172 Windshield (S/N 50573 and up)0513230-12 **\$559.10**
- R172 and FR172 Windshield0513230-20 **\$755.87**
- 175 Windshield (S/N 5001 to 5702)0513300-8 **\$595.49**
- 175 Windshield (S/N 57003 to 57119)0513300-16 **\$539.06**
- 177 Windshield1710000-9 **\$628.90**

Cessna 180 – 185

Control Cables

FAA-PMA
APPROVED

Cable descriptions are basic. Please consult your aircraft parts manual for proper cable application for your model and serial number.



Galvanized Steel

- Aileron Carry-Thru Cable, 295.13" U0510105-13 **\$109.66**
- Aileron Control Cable, 319.25" U0510105-16 **\$157.08**
- Flap Return Forward Cable, 36.38" U0510105-21 **\$64.06**
- Flap Direct Forward Cable, 19.75" U0510105-22 **\$81.16**
- Elevator Control Upper Cable, 182.13" U0510105-24 **\$99.05**
- Elevator Control Lower Cable, 178.75" U0510105-25 **\$86.29**
- Rudder Control Cable, 229.5" U0510105-26 **\$101.92**
- Stabilizer Trim Forward Cable, 81.56" U0510105-28 **\$70.13**
- Stabilizer Trim Aft Cable, 52.5" U0510105-29 **\$94.18**
- Forward Rudder Cable, Left, 210.31" U0510105-51 **\$105.38**
- Aft Rudder Cable, 27.75" U0510105-52 **\$65.64**
- Flap Direct Outboard Cable, 68.88" U0510105-59 **\$112.49**
- Flap Return Outboard Cable, 56.88" U0510105-60 **\$59.78**
- Flap Direct Inboard Cable, Left, 54.44" U0510105-61 **\$89.71**
- Flap Direct Inboard Cable, Right, 51.94" U0510105-62 **\$67.70**
- Flap Return Inboard Cable, Left, 68.38" U0510105-63 **\$64.90**
- Flap Return Inboard Cable, Right, 65.19" U0510105-64 **\$64.90**
- Parking Brake Cable, 13.44" U0510105-70 **\$42.68**
- Forward Rudder Cable, Right, 200.75" U0510105-71 **\$92.95**
- Forward Rudder Cable, 20.69" U0510105-73 **\$64.85**
- Elevator Trim Cable, 13.25" U0510105-79 **\$62.61**
- Elevator Trim Cable, 15.63" U0510105-82 **\$56.93**
- Control Yoke Cable, 44.31" U0510105-213 **\$76.88**
- Control Yoke Cable, 16.75" U0510105-214 **\$103.41**
- Control Yoke Cable, 16.75" U0510105-215 **\$75.21**
- Control Yoke Cable, 18.75" U0510105-216 **\$68.33**
- Aileron Cable, 301.25" U0510105-222 **\$121.06**

Flap Direct Outboard Cable, 76.88".....	U0510105-225	\$100.11
Flap Direct Inboard Cable, Right, 44.0".....	U0510105-226	\$55.30
Flap Direct Inboard Cable, Left, 46.38".....	U0510105-227	\$68.33
Parking Brake Cable, 11.5".....	U0510105-232	\$52.02
Forward Rudder Cable, Right, 200.5".....	U0510105-237	\$112.51
Aileron Cable, 140.13".....	U0510105-262	\$82.58
Aileron Carry-Thru Cable, Left, 159.38".....	U0510105-264	\$99.05
Aileron Carry-Thru Cable, Right, 139.75".....	U0510105-265	\$98.26
Parking Brake Cable, 11.38".....	U0510105-278	\$79.67
Aileron Cable, 160.5".....	U0510105-295	\$96.92

Stainless Steel

Rudder Cable.....	MC0510105-101	\$198.95
Aileron Carry-Thru Cable, 295.13".....	U0510105-113	\$176.00
Aileron Control Cable, 319.25".....	U0510105-116	\$190.30
Flap Return Forward Cable, 36.38".....	U0510105-121	\$79.89
Flap Direct Forward Cable, 19.75".....	U0510105-122	\$79.08
Tailwheel Steering Cable, 17.75".....	U0510105-123	\$77.79
Elevator Control Upper Cable, 182.13".....	U0510105-124	\$113.37
Elevator Control Lower Cable, 178.75".....	U0510105-125	\$112.44
Rudder Control Cable, 229.5".....	U0510105-126	\$107.95
Stabilizer Trim Forward Cable, 81.56".....	U0510105-128	\$95.15
Stabilizer Trim Aft Cable, 52.50".....	U0510105-129	\$75.18
Tailwheel Steering Cable.....	MC0510105-138	\$169.36
Forward Rudder Cable, Left, 201.31".....	U0510105-151	\$119.45
Aft Rudder Cable, 27.75".....	U0510105-152	\$74.03
Tailwheel Steering Cable, 59.0".....	U0510105-153	\$89.15
Flap Direct Outboard Cable, 68.88".....	U0510105-159	\$86.20
Flap Return Outboard Cable, 56.88".....	U0510105-160	\$70.60
Flap Direct Inboard Cable, Left, 54.44".....	U0510105-161	\$92.06
Flap Direct Inboard Cable, Right, 51.94".....	U0510105-162	\$91.38
Flap Return Inboard Cable, Left, 68.38".....	U0510105-163	\$89.03
Flap Return Inboard Cable, Right, 65.19".....	U0510105-164	\$89.03
Parking Brake Cable, 13.44".....	U0510105-170	\$64.61
Forward Rudder Cable, Right, 200.75".....	U0510105-171	\$107.71
Forward Rudder Cable, 20.69".....	U0510105-173	\$61.40
Elevator Trim Cable, 13.25".....	U0510105-179	\$52.35
Elevator Trim Cable, 15.63".....	U0510105-182	\$84.65
Tailwheel Steering Cable, 58.81".....	U0510105-196	\$74.69
Tailwheel Steering Cable, 59.56".....	U0510105-199	\$74.43
Control Yoke Cable, 44.31".....	U0510105-313	\$88.91
Control Yoke Cable, 16.75".....	U0510105-314	\$102.38
Control Yoke Cable, 16.75".....	U0510105-315	\$70.84
Control Yoke Cable, 18.75".....	U0510105-316	\$62.66
Aileron Cable, 301.25".....	U0510105-322	\$153.97
Tailwheel Steering Cable, 59.25".....	U0510105-323	\$75.94
Flap Direct Outboard Cable, 76.88".....	U0510105-325	\$62.76
Flap Direct Inboard Cable, Right, 44.0".....	U0510105-326	\$84.16
Flap Direct Inboard Cable, Left, 46.38".....	U0510105-327	\$79.09
Aileron-Rudder Interconnect Cable, 18.63".....	U0510105-334	\$138.40
Forward Rudder Cable, Right, 200.5".....	U0510105-337	\$124.24
Aileron Cable, 140.13".....	U0510105-362	\$87.38
Aileron Carry-Thru Cable, Left, 159.38".....	U0510105-364	\$91.36
Aileron Carry-Thru Cable, Right, 139.75".....	U0510105-365	\$86.66
Tailwheel Lock Cable, 5.44".....	U0510105-394	\$59.27
Aileron Cable, 160.5".....	U0510105-395	\$107.59

Flap Roller Assembly

- Applicability: Cessna 150-152, 170B, 172, 180, 185 series

Inside Bushing.....	U0523919	\$15.66
Outboard Roller Bearing.....	U0523920	\$37.14
Roller Bearing.....	U0523921	\$43.00



Horizontal Stabilizer Skins

- FAA-PMA approval pending
- Applicability: Cessna 180, 182, 185
- Left or right

Outboard Stabilizer Skin 0732600-2.....	\$702.54
--	-----------------

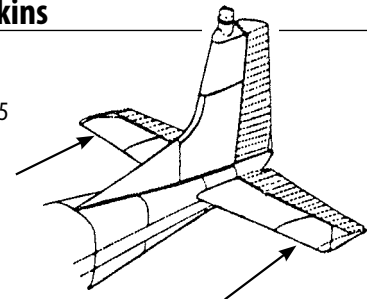

Horizontal Stabilizer Trim Screw Parts



- Applicability: Cessna 180, 185, 182-182D

Adjustment Screw.....	U0712500-11	\$374.93
Adjustment Barrel.....	U0712500-13	\$143.22



Elevator Bushings

- For Cessna 170 hinge and elevator bellcrank
- Also for 180, 185, 182 through 182D IB and OB hinge bushing and elevator arm upper bushing on 1962-82 Cessna 182

Bushings (AR4-1).....	MS24462-4	\$144.84
-----------------------	-----------	-----------------



Pushrod Bearings

Flap Pushrod Bearing.....	S1106-3	\$60.69
Aileron Pushrod Bearing.....	S1819-3	\$50.92



182 Spinner Dome



- For McCauley Constant Speed Propeller, on C-182H, J, K, L, M, N, P, Q, R
- Dome includes four U0752620-3 plastic spacer rings

Spinner Dome.....	U0752637K200	\$988.63
Plastic Spacer Ring.....	U0752620-3	\$6.51
Back Plate.....	0752637-27	\$3,470.37



CESSNA 180-185

180 – 185 Engine

Front Shock Mount.....	J3804-14	\$253.94
Rear Shock Mount.....	0750102-2	\$450.62
Baffle Support.....	0750117-30	\$232.12

Cowl Flaps



- Applicability: Cessna 180C, D, E, F, G, H, J, K
- 182B, C, D
- 185, 185A, B, C, D, E
- A185E, F



The cowl flaps on these airplanes are notorious for taking a real beating and the hinges are usually the first part to wear out. Univair's cowl flaps feature a replaceable stainless steel hinge which may be removed and replaced using screws. These cowl flaps are direct replacements for the OEM cowl flaps on the listed Cessna models.

Cowl Flap, Left.....	U0752014-1	\$1,523.63
Right.....	U0752014-2	\$1,523.63

180 – 185 Landing Gear

Landing Gear Fillet Plate, Right.....	0713018-4	\$770.86
Tailwheel Spring Link (0742200-6).....	U2133A-000	\$3.04
Tailwheel Bushing.....	0742400-11	\$192.32

Concorde Batteries

- Applicability: Cessna 180 thru 188 Series
- Valve regulated sealed lead acid batteries



12 Volt, 22 Amp Hour	RG-25	\$294.95
12 Volt, 24 Amp Hour, Extra Capacity	RG-25XC	\$344.00
12 Volt, 29 Amp Hour	RG-35A	\$373.00
12 Volt, 33 Amp Hour, Extra Capacity	RG-35AXC	\$403.00

Trim Screw Adjusting Cam



- Applicability: Cessna 180-180K, 182-182D, 185-185E, A185E, A185F



U0712502	\$46.29
----------------	----------------

Oil Door



- Applicability: Cessna 180-180G, 182-182G, 185-185C
- | | |
|-------------------|-----------------|
| U0752000-56 | \$460.09 |
|-------------------|-----------------|



- Applicability: Cessna 182H, J, K, M, N, P
- | | |
|------------------|-----------------|
| U0552173-6 | \$298.57 |
|------------------|-----------------|

Rudder and Elevator Skins

Elevator Skin

- Applicability: Cessna 180, 182 through 182D, 185
- To ensure that corrugations match, it is strongly recommended that skins are purchased in pairs

Top Left or Bottom Right Elevator Skin	U0734600-500	\$237.38
Top Right or Bottom Left Elevator Skin	U0734600-501	\$261.23



Rudder Skins (Sold in Pairs)

- Applicability: Cessna 180, 185, 182 through 182B
- To ensure that corrugations match, Univair only sells these parts in pairs
- Price includes both right and left skin

Rudder Skins	U0731000-500/501	\$506.59
--------------------	------------------------	-----------------

Aileron Hinge



- Applicability: Cessna 150, 152, 170A, 170B, 172, 180, 182, 185



Aileron Hinge Assembly	U0523816-1	\$103.08
------------------------------	------------------	-----------------

Adjusting Screw Boot



- Applicability: Cessna 180, 182 through 182D, 185

U0712500-18	\$72.97
-------------------	----------------



Air Filter

- Applicability: Cessna 180 serial numbers 51184 and up; Cessna 185 all serial numbers

Air Filter (0750038-4)	P10-6150	\$166.69
------------------------------	----------------	-----------------



Propellers

Univair furnishes a bolt kit with each propeller purchase. Bolt kits can also be purchased separately from our website.

Propeller descriptions below show basic aircraft/engine model applicability. Check manufacturer's websites for exact applicability before purchasing, or contact our sales staff at 1-888-433-5433 and we can research it for you.

Please note that we do not stock all of the propellers listed. Non-stocked items may have up to a 6 week lead time.

McCauley, Aluminum

188, 188A, 188B "AG Wagon", Continental O-470	AOM9044	\$5,345.60
---	---------------	-------------------

Windshields

Prices below are for clear windows and windshields only. Please see our website for prices and availability of Solar Gray and Green tinted options.

180 Windshield (S/N 30000 to 31260)	0791300-4	\$514.55
180 Windshield (S/N 31261 to 50355)	0791300-7	\$606.62
180 Windshield (S/N 50356 and up)	0713100-10	\$606.62
182 Windshield (S/N 33000 to 51556)	0791300-7	\$606.62
182 Windshield (S/N 51557 to 53598)	0713100-10	\$606.62
182 Windshield (S/N 53599 to 55844)	0713600-8	\$666.02
182 Windshield (S/N 55845 to 64295)	0713287-11	\$713.54
R182 Windshield	0713538-3	\$713.54
185 Windshield	0713100-10	\$606.62

Miscellaneous

Control Wheel and Cessna Hub Covers

- Plastic cover fits on hub of control wheel (sold separately)
- Cessna logo in center
- Hub cover available in three colors – red, black and maroon

Control Wheel	415-52055-6	\$53.30
Cessna Hub Cover, Red	52055-CES-RED	\$45.00
Black	52055-CES-BLK	\$45.00
Maroon	52055-CES-MAR	\$45.00

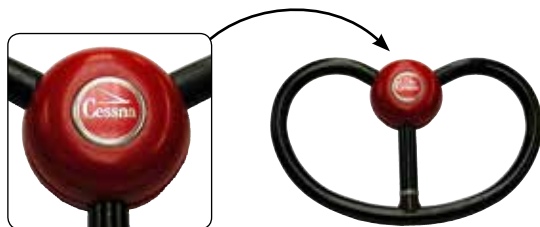

Cleveland Conversion Kits

Cleveland Wheels & Brakes are easy to install, easy to service, and replacement spare parts are easy on the wallet. Down time to change linings can be measured in minutes.

Cleveland is the world's largest manufacturer of wheels and brakes for general aviation. Our distribution network is strategically located to provide fast, dependable delivery and service anywhere – WORLDWIDE!

Applicability: 120, 140 (S/N 8004 to 13399), 140A (S/N 13400 and up), 170, 170A, 170B, 172, 172A to 172E, 175, 175A, 175B, 175C, P172D, 180, 180A to 180F, 182, 182A to 182G

Converts Goodyear to Cleveland. Cannot be used with crosswind landing gear. Installation per FAA STC SA13GL.
Tire size: 6.00-6199-04600**\$2,599.14**

Applicability: 120, 140 (S/N 8004 to 13399), 140A (S/N 13400 and up), 170, 170A, 170B, 172, 172A to 172E, 175, 175A, 175B, 175C, P172D, 180, 180A to 180F, 182, 182A to 182G

CHROME KIT. Converts Goodyear to Cleveland. Cannot be used with crosswind landing gear. Installation per FAA STC SA13GL.
Tire size: 6.00-6199-04600CH**\$5,210.27**

Applicability: 150, F150, A150, FA150, 152, A152, F152, FA152, 177, 177RG, F177RG, 182, A182, F182

Converts McCauley to Cleveland. Installation per FAA Form 337.¹
Tire size: 6.00-6199-08400**\$2,727.82**

Applicability: 172, F172, R172, FR172

Converts McCauley to Cleveland. Installation per FAA Form 337.¹
Tire size: 6.00-6199-08401**\$2,776.98**

Applicability: 180, 180A to 180F, 180H, 180J, 185, 185A, 185B, 185E, A185F, 206E, 206F, TU206E, TU206F

This kit is to be used only with Cessna axles. Part numbers 0541124 and 1441003-1 not for use on aircraft equipped with crosswind landing gear. Installation per FAA STC SA63GL.
Tire size: 8.00-6199-06200**\$2,581.18**

Applicability: 180, 180A to 180F, 180H, 180J, 185, 185A, 185B, 185E, A185F, 206E, 206F, TU206E, TU206F

CHROME KIT. This kit is to be used only with Cessna axles. Part numbers 0541124 and 1441003-1 not for use on aircraft equipped with crosswind landing gear. Installation per FAA STC SA63GL.
Tire size: 8.00-6199-06200CH**\$3,543.38**

Applicability: 180, 180A to 180F, 180H, 180J, 185, 185A, 185B, A185E, A185F, 206E, 206F, TU206E, TU206F, 210, 210A, 210B, 210C, 210K, 210L, 210M, T210C, T210K, T210L, T210M, T210N

This kit is to be used only with Cessna axles. Part numbers 0541124 and 1441003-1 not for use on aircraft equipped with crosswind landing gear. Installation per FAA STC SA52GL and SA62GL.
Tire size: 6.00-6199-06000**\$2,596.38**

Applicability: 190, 195, 195A, 195B

This kit is not for use on aircraft equipped with crosswind landing gear. Installation per FAA STC SA54GL.
Tire size: 6.50-10199-06100**\$8,786.14**

Applicability: 310, 310A through 310H, E310H, 310I, 310J, 310J-1, E310J, 310K, 310L, 310N, 310P, T310P, 310Q, T310Q, 310R, T310R, 320, 320-1, 320A, 320B, 320C, 320D, 320E, 320F

Installation per FAA STC SA110GL and SA111GL.
Tire size: 6.50-10199-06400**\$6,896.00**

Applicability: 340, 340A, 401, 401A, 401B, 402, 402A, 402B, 411, 411A, 414

Upgrade existing Cleveland wheels/brakes to heavy-duty wheels/brakes. Installation per FAA STC SA167GL and SA281GL.
Tire size: 6.50-10199-07200**\$5,990.98**

¹ The installer is required to obtain FAA field approval for the modification prior to returning the aircraft to service. Consult your local Flight Standards District Office (FSDO) for pre-approval guidelines.

