

Cessna

120

140

140A

150

170

170A

170B

172

175

180

182

185

190

195

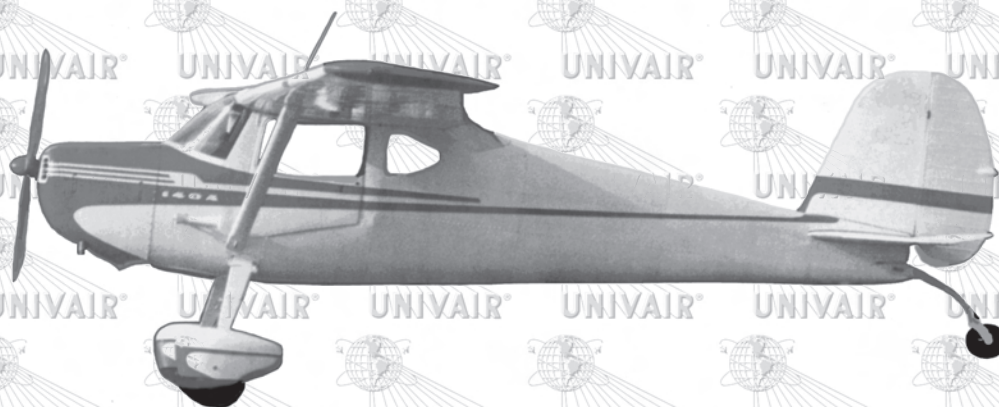
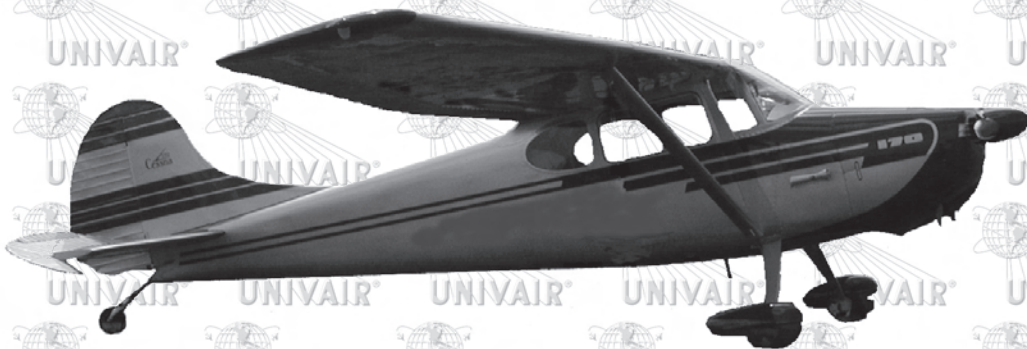
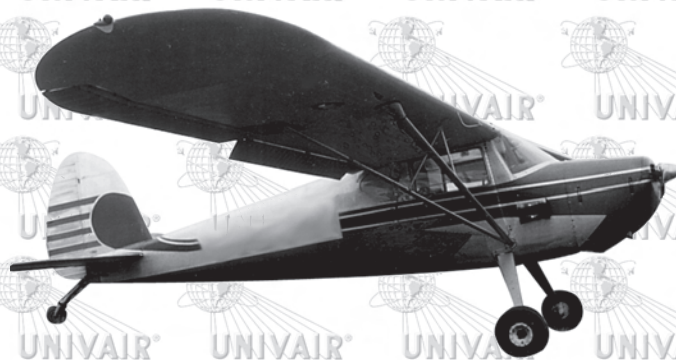

Cessna Model Section / Index

<i>Model/Section</i>	<i>Page No.</i>
Manuals.....	7, 8
120-140 Controls.....	7
120-140 Engine.....	8
120-140 Landing Gear.....	8
120-140 Fuselage.....	8, 9
120-140 Tail Surfaces.....	10
120-140 Wings.....	10
150 Controls, Engine.....	12
150 Landing Gear, Wings, Miscellaneous.....	12
170 Parts.....	13
172-175 Engine.....	13
172-175 Fuselage.....	13
172-175 Landing Gear.....	11
172-175 Miscellaneous.....	11
180, 182, 185, 190, 195 Parts.....	13
L-19.....	13
210, 310.....	17
Cessna Miscellaneous.....	17, 18

For items such as batteries, brakes, propellers, wheels and windshields, look in the specific sections in this catalog.

Parts Manuals

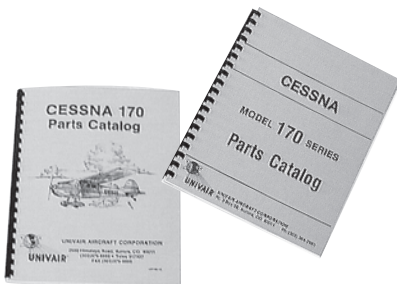

<i>Description</i>	<i>Part No.</i>
120/140 Parts Catalog 1946-1949.....	UP104-12
140A Parts Catalog, 1949-1951.....	P105-12
150 Parts Catalog, 1959-1969.....	P438-12
150 Parts Catalog, 1970-1977.....	P691-12
152 Parts Catalog, 1978-1985.....	P657-1-12
170 Parts Catalog, 1948.....	UP106-12
170A Parts Catalog, 1949-1951.....	UP107-12
170B Parts Catalog, 1952-1956.....	UP108-12
172 & 175 Parts Catalog, 1956-1962.....	P257-12
172 parts Catalog, 1963-1974.....	P529-12
172/172Q Parts Catalog, 1975-1986.....	P696-12
172RG Parts Catalog, 1980-1985.....	P693-12
177 Cardinal Parts, 1968-1978.....	P593-12
177 Cardinal RG Parts, 1971-1978.....	P695-12
Parts Catalog for 180, 1953-1962 and 182, 1956-1961.....	P259-12
Parts Catalog for 180, 1963-1973 and 185, 1961-1973.....	P527-12
180-185 Parts Catalog, 1974-1985.....	P699-12
182 and Skylane Parts Catalog, 1962-1973.....	P515-12
182 Parts Catalog, 1974-1986.....	P690-12
R182/TR182 Skylane RG Parts, 1986-1987.....	P701-12
188 Parts Catalog, 1966-1975.....	P545-12

Manuals (continued)

<i>Description</i>	<i>Part No.</i>
188 AG Aircraft Series, 1976-1984.....	P694-12
190-195 Parts Catalog, 1948-1953.....	P112-12

Service Manuals



100 Series Service Manual, 1953-1962 (for 150, 172, 175, 180, 182, and 185).....	*UD138-13
* This manual is not written specifically for the 120, 140 or 170 series; however, much of the information is useful for these aircraft.	
100 Series Service Manual, 1963-1968.....	UD637-13
150 Series Service Manual, 1969-1976.....	D971-3-13
150 Series Service, 1977.....	D2011-1-13
152 Series Service, 1978-1985.....	D2064-1-13
172 Series Service Manual, 1969-1976.....	D972-3-13
172/172Q Series Service, 1977-1986.....	D2065-2-13
Hawk XP Service, 1977-1981.....	D2027-1-13
FR172 (Reims Rocket) Service, 1968-1976.....	D849-5-13
172 RG Service Manual, 1980-1985.....	D2066-1-13
177 Cardinal Service, 1968-1978.....	D841-8-13
Cardinal RG Service, 1971-1975.....	D991-3-13
Cardinal RG Service, 1976-1978.....	D2009-4-13
180/185 Skywagon & AG carryall 1969-1980.....	D2000-9-13
180/185 Series Service, 1981-1985	D2067-1-13
182 Skylane Service, 1969-1976.....	D2006-3-13
182/T182 Skylane service, 1977-1986.....	D2068-3-13
R182/TR182 Skylane RG Service Manual, 1978-1984.....	D2069-3-13
188 Ag Aircraft Series Service Manual, 1966-1984.....	D2054-1-13

Owners Manuals



<i>Description</i>	<i>Part No.</i>
120-140 Owners Manual, 1946-1948.....	UP123-13
140A Owners Manual, 1949-1951.....	UP124-13

Owners Manuals (continued)

<i>Description</i>	<i>Part No.</i>
150 Owners Manual, 1959-1960.....	P187-13
150A Owners Manual, 1961.....	P220-13
150B Owners Manual, 1962.....	D123-13
150C Owners Manual, 1963.....	D156-13
150D Owners Manual, 1964.....	D208-13
150E Owners Manual, 1965.....	D251-13
150F Owners Manual, 1966.....	D326-13
150G Owners Manual, 1967.....	D397-1-13
150H Owners Manual, 1968.....	D518-13
150J Owners Manual, 1969.....	D624-13
150K Owners Manual, 1970.....	D727-13
150L Owners Manual, 1971.....	D836-13
150L Owners Manual, 1972.....	D901-13
150L Owners Manual, 1973.....	D962-13
150L Owners Manual, 1974.....	D1013-13
150M Owners Manual, 1975.....	D1033-13
170 Owners Manual, 1948.....	UD376-13
170A Owners Manual, 1949-1951.....	UP125-13
170B Owners Manual, 1952-1955.....	UP213-13
170B Owners Manual, 1956.....	UP130-13
172 Owners Manual, 1956.....	P130A-13
172 Owners Manual, 1957-1958.....	P181-13
172 Owners Manual, 1959.....	P168-13
172A Owners Manual, 1960.....	P188-13
172B Owners Manual, 1961.....	D880-13
172C Owners Manual, 1962.....	D124-13
172D Owners Manual, 1963.....	D157-13
172E Owners Manual, 1964.....	D209-13
172F Owners Manual, 1965.....	D615-13
172G Owners Manual, 1966.....	D616-13
172H Owners Manual, 1967.....	D638-13
172I Owners Manual, 1968.....	D584-13
172K Owners Manual, 1969.....	D625-13
172K Owners Manual, 1970.....	D742-13
172L Owners Manual, 1971.....	D837-13
172L Owners Manual, 1972.....	D902-13
172M Owners Manual, 1973.....	D964-13
172M Owners Manual, 1974.....	D1016-13
172M Owners Manual, 1975.....	D1036-13
175 Owners Manual, 1958.....	P175-13
175 Owners Manual, 1959.....	P175A-13
175A Owners Manual, 1960.....	P197-13
175B Owners Manual, 1961.....	P225-13
175C Owners Manual, 1962.....	D125A-13
177 Owners Manual, 1968.....	D519-13
177A Owners Manual, 1969.....	D627-13
177B Owners Manual, 1970.....	D743-13
177B Owners Manual, 1971.....	D838-13
177B Owners Manual, 1972.....	D903-13
177B Owners Manual, 1973.....	D966-13
177B Owners Manual, 1974.....	D1018-13
177B Owners Manual, 1975.....	D1037-13
177RG Owners Manual, 1971.....	D862-13
177RG Owners Manual, 1972.....	D905-13
177RG Owners Manual, 1973.....	D966-13
177RG Owners Manual, 1974.....	D1019-13
177RG Owners Manual, 1975.....	D1039-13

Owners Manuals (continued)

<i>Description</i>	<i>Part No.</i>
180 Owners Manual, 1953.....	P131B-13
180 Owners Manual, 1954.....	P131-13
180 Owners Manual, 1955.....	P132-13
180 Owners Manual, 1956.....	P133-13
180A Owners Manual, 1957.....	P136-13
180A Owners Manual, 1958.....	P136A-13
180B Owners Manual, 1959.....	P170-13
180C Owners Manual, 1960.....	P198-13
180D Owners Manual, 1961.....	P231-13
180E Owners Manual, 1962.....	D127-13
180F Owners Manual, 1963.....	D158-13
180G Owners Manual, 1964.....	D210-13
180H Owners Manual, 1965.....	D264-13
180H Owners Manual, 1966.....	D335-13
180H Owners Manual, 1967.....	D413-13
180H Owners Manual, 1968.....	D521-13
180H Owners Manual, 1969.....	D692-13
180H Owners Manual, 1970.....	D765-13
180H Owners Manual, 1971-1972.....	D946-13
180J Owners Manual, 1973.....	D1000-13
180J Owners Manual, 1974.....	D1020-13
180J Owners Manual, 1975.....	D1040-13
182 Owners Manual, 1956.....	P134-13
182A Owners Manual, 1957-1958.....	D139-13
182B Owners Manual, 1959.....	P171-13
182C Owners Manual, 1960.....	P189-13
182D Owners Manual, 1961.....	P230-13
182E Owners Manual, 1962.....	D130-13
182F Owners Manual, 1963.....	D161-13
182G Owners Manual, 1964.....	D219-13
182H Owners Manual, 1965.....	D282-13
182J Owners Manual, 1966.....	D348-13
182K Owners Manual, 1967.....	D439-13
182L Owners Manual, 1968.....	D548-13
182M Owners Manual, 1969.....	D647-13
182N Owners Manual, 1970.....	D754-13
182N Owners Manual, 1971.....	D855-13
182P Owners Manual, 1972.....	D906-13
182P Owners Manual, 1973.....	D1003-13
182P Owners Manual, 1974.....	D1021-13
182P Owners Manual, 1975.....	D1041-13
185 Owners Manual, 1961.....	D101-13
185A Owners Manual, 1962.....	D129-13
185B Owners Manual, 1963.....	D159-13
185C Owners Manual, 1964.....	D211-13
185D Owners Manual, 1965.....	D265-13
185E Owners Man., 1966.....	D360-13
A185E Owners Manual, 1967.....	D412-13

PC 114

Magneto Noise Filter



Mag Noise Filter.....A293

Owners Manuals (continued)

<i>Description</i>	<i>Part No.</i>
A185E Owners Manual, 1969.....	D695-13
A185E Owners Manual, 1970.....	D772-13
A185E Owners Manual, 1971-1972.....	D937-13
A185F Owners Manual, 1973.....	D1001-13
A185F Owners Manual, 1974.....	D1022-13
A185F Owners Manual, 1975.....	D1042-13
188 & A188 Owners, 1966-1967.....	D392-13
188 & A188 Owners, 1968-1969.....	D726-13
188A & A188A Owners, 1970-71.....	D764-13
188B & A188B Owners, 1972-73.....	D961-13
188B & A188B Owners, 1974.....	D1023-13
188B & A188B Owners, 1975.....	D1043-13
190, 195, 195A & 195B Owners Manual 1946-1953.....	P138-13

PC 114

Continental Engine

**Operators
Handbooks
(Glove Box Size)**



A and C Series, 4-cylinder.....	AC4WM
A and C Series, 6-cylinder.....	AC6WM
C Series, 6-cylinder.....	C6WM
O Series, 6-cylinder.....	CO6WM
IO-470-C.....	X30024

PC 200

Continental Service and Overhaul Manuals



A-65, A-75 Parts and Overhaul Manual.....	X30008
“C” Series Maintenance and Overhaul Manual (C-75, C-85, C-90, O-200).....	X30010A
“C” Series Parts Manual (C-75, C-85, C-90, O-200).....	X30011A
C-125, C-145, O-300 Maintenance and Overhaul Manual.....	X30013
C-125, C-145, O-300 Parts Manual.....	X30014
IO-520 Overhaul Manual.....	X30039A
IO-520 Parts Manual(Later Permamold Case)	X30624A
IO-520 Parts Manual (Early Sand Cast Case)	X30628A
O-470 Overhaul Manual.....	X30586A
O-470 Parts Manual.....	X30587A
IO-470 Overhaul Manual.....	X30588A
IO-470 Parts Manual.....	X30589A
IO-360 Overhaul Manual.....	X30594A
IO-360 Parts Manual.....	X30595A

PC 200

Engine — 120-140

<i>Description</i>	<i>Part No.</i>
Engine attachment Spacer.....	0450195
Mixture Control Clamp.....	0450258
Oil Temperature Gauge Adapter.....	0450261

PC 115

Small Skull Cap Spinner

**This spinner
assembly may not
fit all taper shaft
installations.**



Small Skull Cap Spinner Assy:

.....	PC299	SM-SPIN-ASY
Bracket.....	PC115	U0450281
Spinner Dome Only ...	PC115	U0450279

Instrument Panel Shock Mount



Part Number..... J6984-8

PC 299

Engine Mount Assembly For 120-140 FAA/PMA Approved



120-140..... U0451000
140A..... U0451111

PC 115

Continental Engine Mount Bushings

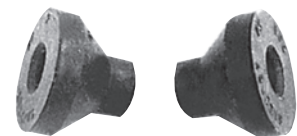

Part Number..... 22387

PC 201

CONTROL CABLES (FAA/PMA Approved) FOR C-120/140, 140A/150 & 152

Cable descriptions are basic. PLEASE CONSULT YOUR AIRCRAFT PARTS MANUAL FOR PROPER CABLE APPLICATION FOR YOUR MODEL AND SERIAL NO.

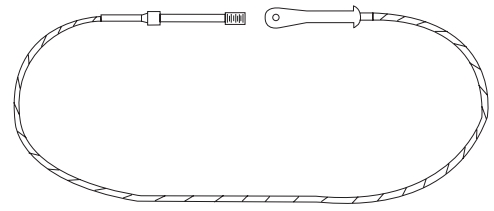

Control Cables	Galvanized	Stainless Steel	Description	Galvanized	Stainless Steel
Description	Part No.	Part No.	Description	Part No.	Part No.
Wheel to Aileron	U0400107-1	U0400107-101	Flap retract-forward	U0400107-37	U0400107-137
Aileron Carry thru	U0400107-2	U0400107-102	Flap retract	U0400107-38	U0400107-138
Flap control	U0400107-3	U0400107-103	Flap extend-forward	U0400107-39	U0400107-139
Rudder control	U0400107-4	U0400107-104	Flap extend	U0400107-40	U0400107-140
Elevator control-up	U0400107-5	U0400107-105	Aileron cable	U0400107-41	U0400107-141
Elevator tab-aft	U0400107-7	U0400107-107	Elev-tab-fwd direct	U0400107-42	U0400107-142
Elevator tab-forward	U0400107-8	U0400107-108	Elev tab carry thru	U0400107-43	U0400107-143
Elevator control-down	U0400107-9	U0400107-109	Flap control	U0400107-45	U0400107-145
Flap control	U0400107-10	U0400107-110	Flap control	U0400107-46	U0400107-146
Elevator tab carry through forward	U0400107-11	U0400107-111	Rudder-forward	U0400107-47	U0400107-147
Elevator tab carry through direct	U0400107-12	U0400107-112	Rudder-aft	U0400107-48	U0400107-148
Elevator tab aft direct	U0400107-13	U0400107-113	Rudder L/H cable	U0400107-49	U0400107-149
Elevator tab forward direct	U0400107-14	U0400107-114	Rudder R/H cable	U0400107-50	U0400107-150
Wheel to Aileron	U0400107-17	U0400107-117	Elevator tab-forward	U0400107-52	U0400107-152
Aileron carry thru	U0400107-18	U0400107-118	Elevator tab-forward direct	U0400107-53	U0400107-153
Aileron carry thru	U0400107-21	U0400107-121	Elevator tab-forward	U0400107-54	U0400107-154
Flap extend-forward	U0400107-22	U0400107-122	Elevator tab-forward direct	U0400107-55	U0400107-155
Flap retract-forward	U0400107-23	U0400107-123	Elevator tab-forward	U0400107-56	U0400107-156
Flap retract	U0400107-26	U0400107-126	Elevator tab-aft carry through	U0400107-57	U0400107-157
Tab actuator to disconnect	U0400107-28	U0400107-128	Aileron crossover R/H	U0400107-58	U0400107-158
Tab wheel to turnbuckle	U0400107-29	U0400107-129	Aileron crossover L/H	U0400107-59	U0400107-159
Tab actuator to turnbuckle	U0400107-30	U0400107-130	Aileron cable	U0400107-60	U0400107-160
Aileron Cable	U0400107-31	U0400107-131	Aileron direct L/H	U0400107-61	U0400107-161
Flap retract	U0400107-33	U0400107-133	Elevator up-aft	U0400107-63	U0400107-163
Flap extend	U0400107-34	U0400107-134	Elevator down-aft	U0400107-64	U0400107-164
Aileron cable	U0400107-35	U0400107-135	Aileron direct R/H	U0400107-65	U0400107-165
Aileron cable	U0400107-36	U0400107-136	Elevator forward	U0400107-66	U0400107-166

Air Filter for C-85 and C90 Engines



Use with
A50256 Housing

Part number (40599)..... 600314

PC 275

Tailwheel Spring Sets FAA/PMA Approved



(late Cessna spring set shown)

- Early 120-140 (single bend, originally)
(SN 8001-14026)..... U120-140E
- 120-140 (SN 14027 and up)..... U120-140
- 120-140 main leaf only
(SN 8001-14026)..... U0442106
- 120-140 main leaf only
(SN 14027 & up)..... U0442106-2

Landing Gear — 120-140

Description	Part No.
Landing Gear Support Wedge	0441023-2
Brake Disc Cover Plate	0441126
Axle Nut	0441130
Tailwheel Leaf Spring	U0442106
Tailwheel Leaf Spring	U0442106-2
Tailwheel Leaf Spring	U0442107
Tailwheel Leaf Spring	U0442108
Tailwheel Leaf Spring	U0442108-2
Tailwheel Leaf Spring	U0442109-2
Tailwheel Leaf Spring	U0442110
Tailwheel Leaf Spring	U0442110-2
Tail Spring Attachment Stiffener	0442115
Tailwheel Leaf Spring Clamp	U0442125
Tail Spring Shackle	U0442122
Tail Spring Abrasion Strip	U0442124

Tailwheel Attach Bracket for 120-140

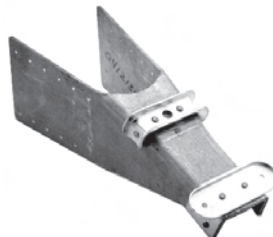

Part Number.....0412139-1

Landing Gear Bulkheads

FAA/PMA Approved

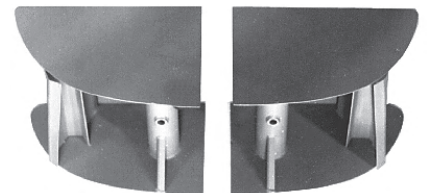

Left Hand.....U0411495
Right Hand U0411495-1



If you don't find the part you need, be sure to give us a call. We are here to help you with all of your classic aircraft needs!

Cessna 120/140

Tail Surfaces 120-140

Aluminum Gearbox Bulkhead



Bulkheads for 120, 140 & 140A

Front Bulkhead0411120
Rear Bulkhead.....0411109

Rudder Bellcrank FAA/PMA Approved



Part Number..... U0433113

C-120 and C-140 Tail Post Bulkhead

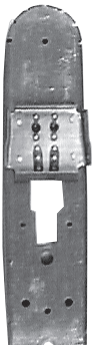

Part number 0412169

120-140 Tail Surfaces FAA/PMA Approved



Fin Assembly U0431000
Rudder Assembly U0433000-14

120-140 Horizontal Stabilizer

FAA/PMA Approved



Part Number..... U0432000-3

C-120 and C-140 Elevator Assemblies

FAA/PMA Approved

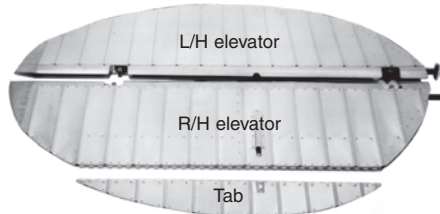

Right Hand Elevator Assembly U0434137
R H Elevator Assy with Trim Tab 0434137A
Left Hand Elevator Assy U0434139
Trim Tab 0434135
Trim Tab Push Rod..... 0434127

Tail Surface Skins FAA/PMA Approved

RH Top Elevator Skin Assy. U0434140
RH Bottom Elevator Skin Assy. U0434134
LH Top Elevator Skin Assy. U0434141
LH Bottom Elevator Skin Assy. U0434142
RH Top Elevator Skin Only..... U0434140-1
RH Bottom Elevator Skin Only.... U0434134-1
LH Top Elevator Skin Only..... U0434141-1
LH Bottom Elevator Skin Only.... U0434142-1
Rudder Skins (Pair L&R) U0433000-20

* Elevator Skins must be sold in pairs of top and bottom, to insure matching corrugations.

WINGS — 120-140

<i>Description</i>	<i>Part No.</i>
Aileron Control Bushing (0411489) PC 595 NAS382-2	
Flap Control Bushing (0411490) PC 595 NAS382-1	
Elevator Control Pulley Bushing..... 0411491	
Aileron Control Bushing..... 0411521	
Aileron Control Bushing..... 0411783	
C-120 L H Wing (without tank) 0420200-3	
Wing Strut Front Rod End..... U0422012	
Nose Rib0422138-3	
Left Hand Aileron Hinge Strut Rib.... 0422200-2	
Center Rib Section..... 0422212	
Aileron Hinge Inner Race Bushing.... U0422215	
Upper Front Strut Bushing 0422261	

Wings 120-140 (continued)

<i>Description</i>	<i>Part No.</i>
Aileron Bellcrank Bushing.....0422280	
Rear Strut Attach Bolt.....0422297	
Rear Strut Rod End.....U0422316	
Nose RibU0422337	
Left Hand Wing Strut U0422340-8	
Right Hand Wing Strut U0422340-9	
Left Hand Tip Spar0423113	
Right Hand Tip Spar 0423113-1	
Left Hand Trailing Edge Wing Tip Spar..... U0423300-4	
Right Hand Trailing Edge Wing Tip Spar..... U0423300-5	
Left Hand Flap.....0425000	
Right Hand Flap..... 0425000-1	
Wing Flap Hinge.....U0425113	
Left Hand Flap Control Fitting.....U0425118	
Right Hand Flap Control Fitting... U0425118-1	
Inboard Hinge (140A).....0525107	

120-140 Aileron FAA/PMA Approved



Left U0424000-2
Right..... U0424000-3

(Excludes Aileron Push Rods)

120-140 Lift Struts FAA/PMA Approved

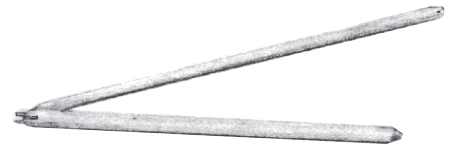

Left Hand..... U0422340-8
Right Hand U0422340-9

Lift Strut Rod Ends



Front Rod End U0422012
Rear Rod End..... U0422316

Fuselage - 120-140

<i>Description</i>	<i>Part No.</i>
Bulkhead.....	0411120
Fuselage Spar Bearing Block.....	0411129
Tinted Skylight.....	0411144G
Door Window Glass.....	0411182
Cabin Door Window Hinge.....	U0411185-7
Control Tube Socket.....	0411225
Rudder Pedal Arm.....	0411307
Flap Control Lever Cover.....	0411323
Lower Door Sill Support.....	0411345
Rudder Pedal Shaft.....	0411369-2
Lower Door Hinge.....	0411579
Door Catch Striker.....	0411582
Left Hand Upper Door Hinge.....	0411597
Right Hand Upper Door Hinge.....	0411597-1
Left Hand Landing Gear Fillet.....	U0411762
Right Hand Landing Gear Fillet.....	U0411762-1
Left Hand Return Spring.....	0411837-1
Nut.....	0411849
Aft Window.....	0412145
Tail Post Bulkhead.....	0412169
Instrument Bezel.....	0412487-3
Starter Button Housing.....	0413015
Felt Seal (0413163-7).....	0413163-58
Door Handle Escutcheon.....	0413197
Washer.....	0413228
Lower Cowl Reinforcement.....	U0452192

Tail Surfaces - 120-140

<i>Description</i>	<i>Part No.</i>
Fin Assembly.....	U0431000
Front Fin Spar.....	U0431115
Fin Hinge Bushing.....	U0431119
Top Fin Hinge.....	U0431120
Lower Fin Skin.....	U0431128
Rear Fin Spar.....	U0431130
Lower Fin Rib.....	U0431135
Fin Rib.....	U0431136
Fin Rib.....	U0431137
Upper Fin Rib.....	U0431138
Upper Fin Cap Assembly.....	U0431139
Fin Spar Reinforcement.....	*U0431145
Fin Spar Reinforcement.....	*U0431145-1
Stabilizer Assembly.....	U0432000-3
Left Hand Inboard Horizontal Stabilizer, Leading Edge.....	U0432158
Right Hand Inboard Horizontal Stabilizer, Leading Edge.....	U0432158-1
Outboard Horizontal Stabilizer, Leading Edge.....	U0432159
Rudder Assembly.....	U0433000-14
#1 Rudder Rib (Rib Only).....	U0433106-2
Rudder Tip.....	U0433111
Rudder Bellcrank.....	U0433113
Tail Light Mount Support.....	U0433121
Rudder Spar.....	U0433125
Rudder Tab.....	U0433127

(*) To comply with AD 50-31-01)

Fuselage - 120-140 (continued)

**Lever Type Window Latches
And Components
FAA/PMA Approved**

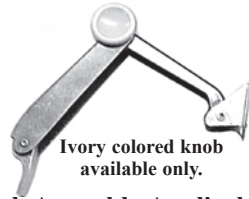

Ivory colored knob available only.

Latch Assembly Applicable on:
120, 140, 140A, 170, 170A,
170B, (S/N 20267 thru 25372)

..... U0413362-2

Polished Latch also available

Latch Assembly Applicable on:
170B (S/N 25373 & on), 172,
175, 180 & 182

..... U0413362-3

Polished Latch also available

Note: U0413362-2 replaces
Cessna 0411186 & 0411186-3

Component Parts:

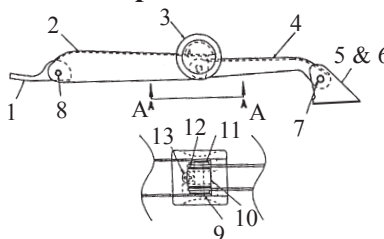

- 1. Arm (for-2 assy.).....U0413362-8
- Arm (for-3 assy.).....U0413362-9
- 2. Bracket.....U0413362-13
- 3. Knob.....U0413359
- 4. Extension Arm.....U0413362-12
- 5. Angle (left side).....U0441362-10
- 6. Angle (right side).....U0413362-11
- 7. Pin.....U0413362-14
- 8. Pin.....U0413362-16
- 9. Pin.....U0413362-15
- 10. Spacer.....U0413362-7
- 11. Washer (2 req.) *.....NAS1149F0363P
- 12. Washer (2 req.) *.....NAS1149F0332P
- * PC 502
- 13. Screw.....PC 595.....4 X 3/8TRA

120-140 Cowl Grills

FAA/PMA Approved

Also approved for 170, 170A and 170B
through S/N 25372



- Left Hand Cowl Grill.....U0452207
- Right Hand Cowl Grill.....U0452207-1

Fuselage - 120-140 (continued)

**Cowl Latches and Details
FAA/PMA Approved
For 120-140 and 170 Series**

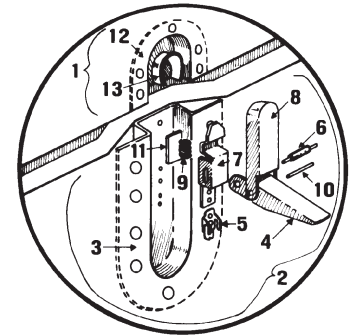

Hook and Lever Assemblies

- 1. Hook Assembly.....U0452108
- 2. Lever Assembly.....U0452119

Detail Parts

- 3. Recess.....U0452109
- 4. Lever.....U0452110
- 5. Clip.....U0452111
- 6. Pin.....U0452112
- 7. Housing.....U0452113
- 8. Hook.....U0452114
- 9. Spring.....U0452115
- 10. Pin.....U0452120
- 11. Shim.....U0452121
- 12. Recess.....U0452122
- 13. Hook.....U0452123

All Metal Cowling Parts

for 120-140 & 140A

FAA/PMA Approved



1946 Cowling Items

- Lower Cowl Skin, Left.....U0452126-3
- Lower Cowl Skin, Right.....U0452126-5
- Nose Cowl Only.....U0452124

1947 & 1948 Cowling Items

- Center Cowl Support.....U0452187
- Lower Cowl Skin, Left Hand.....U0452189-3
- Lower Cowl Skin, Right Hand.....U0452189-5
- Nose Cowl Blank.....U0452185

**C-120/140 & 170
Wing Drag Wires**
FAA-PMA Approved

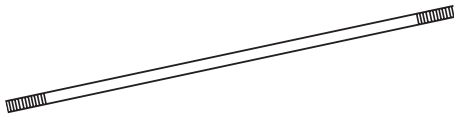

- 120/140 Wing Bay #1U0422008-1
- 120/140 Wing Bay #2U0422008-2
- 120/140 Wing Bay #3 & #4.....SAE0422008-4*
- 170 Wing Bay #4 & #5U0422008-4
- 170 Wing Bay #3.....U0422008-5
- 170 Wing Bay #1 & #2U0422008-6

* Complies with AD 48-25-3 for C-120/140
Provides for use with standard AN365-1032 nuts

**Tip Skin Assembly, Wing
Leading Edge**
FAA/PMA Approved



- Left U0423112
- Right.....U0423112-1

Wing Fabric Clip
FAA/PMA Approved



Part Number..... US43

**Rear Carry-through Spar
for 120-140**
FAA/PMA Approved



Part Number..... U0411476



Controls - Cessna 150/152

See the expanded list of 120/140/150 &
152 FAA-PMA Approved control
cables on Page 9.

Engine - 150

Description	Part No.
Clamp Half Assembly.....	0450338-9
Tailpipe Exhaust Clamp.....	0450338-10
Exhaust Muffler Tube.....	0450338-14

Cessna 150/152 Engine Mounts
FAA/PMA Approved



- SN 17001 to 59215.....U0451114-1
 - SN 59216 to 64532.....U0451114-29
 - SN 64533 to 71128.....U0451114-32
 - SN 71129 and up*U0451120-1
 - Cessna 152 Mount.....L0451003
- * Not suitable for A-150 Aerobats

Landing Gear - 150

Description	Part No.
Landing Gear Shim.....	0441157-1
Landing Gear Shim.....	0441157-2
Landing Gear Shim.....	0441157-3
Nose Gear Strut Placard	0442145-1

Wings - 150

Description	Part No.
Left Hand Wing Light Lens.....	0423564-1

Miscellaneous - 150

Description	Part No.
Rotating Beacon Mount.....	0400301-2
Support.....	0442147-1

Fuselage - Cessna 170

Description	Part No.
Right Hand Brake and Rudder Retainer Spring.....	0310196-3
Left Hand Brake and Rudder Retainer Spring.....	0310196-4

Fuselage (continued)

Description	Part No.
Rudder and Brake Pedal	0310453
Seat Roller.....	0311310
Ignition Switch Shield	0311777
Stewart-Warner Heater Screen.....	0311796
Left Hand Outboard Rudder Pedal Bulkhead.....	0510124
Fuselage Center Section Stiffener ..	0511000-35
Left Hand Hinge Half.....	0511106-14
Right Hand Hinge Half.....	0511106-15
Left Hand Door Glass.....	0511106-104
Aft Window.....	0512000-54
Right Hand Door Catch Bracket.....	0523004-5
Left Hand Door Catch Bracket.....	0523004-6
Left Hand Door Step Bracket.....	0523004-11

All-Metal Cowling Parts

For C-170, C-170A, and C-170B,
through SN 25372

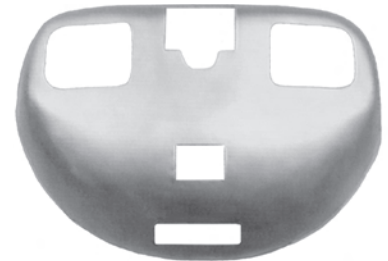

Nose Cowl(FAA/PMA)..... U0552000-13

- Lower Skin, Left Blank U0552000-32
- Lower Skin, Right Blank..... U0552000-33
- Lower Cowl Lip Blank..... U0552000-41

The above items pending FAA/PMA
approval. Available soon, call for
availability.

**Carburetor Air Intake Box
for 170 Cessna, 145 Swift**

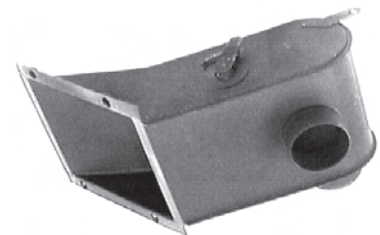

Part Number.....PC 201..... 530852

Landing Gear - 170

Description	Part No.
Tailwheel Pawl (0442010-4).....	PC690 3219
Tailwheel Spring (0442010-5).....	PC690 U3222
Tailwheel Leaf Spring.....	U0442107
Tailwheel Leaf Spring.....	U0442108-2
Tailwheel Leaf Spring.....	U0442109-2
Tailwheel Attach Bushing.....	0442129-1
Tailwheel Attach U-Bolt.....	0510000-32
Tailwheel Attach Stiffener.....	0510000-33
Tailwheel Leaf Spring.....	U0542105
Tailwheel Leaf Spring Main.....	U0542106

**C-170 Tailwheel Springs
FAA/PMA Approved**



(C-170 Springs Shown)

Tailwheel Spring Assembly C-170.....	U170
Main Leaf Only.....	U0542106
Tailwheel Spring Assy. C-170 A&B....	U170AB

Tail Surfaces — 170

Description	Part No.
#3 Fin Rib.....	0331108

Wings - 170

Description	Part No.
Wing for 1948 C-170, uncovered, without flaps and ailerons, right hand and left hand.....	0520002-15, -16
Flap Bracket.....	0520120-2
Leading Edge Skin, station 190-208..	0523003-57
Nose Rib, station 85.625.....	0523111-2
Landing Light Window.....	0523115-5
Flap Control Spring.....	0523227
Strut Attach Spacer.....	0523307
Nose Rib Assembly, station 172.....	0523514-4
Gasket.....	0523532
Left Hand #1 Aileron Rib.....	0523808
Right Hand #1 Aileron Rib.....	0523808-2
Left Hand #2 Aileron Rib.....	0523809
Right Hand #2 Aileron Rib.....	0523809-1
Left Hand #4 Aileron Rib.....	0523811
Right Hand Flap End Rib.....	0523912
Left Hand Flap End Rib.....	0523912-1
Flap Control Bracket.....	0523918
Flap Trailing Edge.....	0523923
Wing Tip.....	0623100
Nose Rib Assembly, station 208..	U0720608-26

**C-150 Spinner Assembly
For 150 F, G, H, J, 150 K**



1. Spinner Dome.....(FAA/PMA)..... **U0450027-12**
2. Rear Plate.....(FAA/PMA)..... **U0450040-1**
3. Front Plate (Plastic).....(OEM)..... **0450039-1-791**

**C-170 & Early 172 Spinner
Assembly (for Continental 8 hole flanges)
FAA/PMA Approved**



- | | |
|-----------------------|------------|
| Spinner Bulkhead..... | U0550162-3 |
| Spinner Dome..... | U0550162-7 |
| Spinner Assembly..... | U0550162 |

**C-172 Spinner & Components
For 172 A, B, C, D, E, & F
FAA/PMA Approved**



1. Dome (FAA-PMA)..... **U0550228-28**
All Aluminum Dome-Approved to replace original style "plastic" dome.
2. Rear Plate (FAA-PMA)..... **U0550228-26**
3. Front Plate (FAA/PMA)..... **U0550228-3**

**172 Spinner
For 172 I, K, L, M, N, & P**

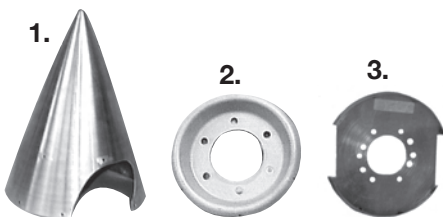

1. Dome (FAA-PMA)..... **U0550236-8**
2. Front Plate (FAA-PMA)..... **U0550321-4**
3. Rear Plate (FAA-PMA)..... **U0550321-010**

Fuselage - L-19

Description	Part No.
Window Handle.....	0611105-1
Window Weatherstrip.....	0611155-1
Pilot's Window Latch.....	0611217
Spring.....	0611279
Lift Tube Spring.....	0612116
Tailwheel Spring, Leaf.....	U0442108-2
Tailwheel Spring, Leaf.....	U0442109-2
Tailwheel Spring, Leaf.....	U0542105
Tailwheel Spring, Main.....	0642101
Tailwheel Spring Assembly.....	170-L19

Fuselage - 172-175



Fuselage Aft Section (175) SN 55001-56238.....	0591201-4
Fuselage Front Section (175) SN 56239-56777.....	0591301-14
Fuselage Front Section (175) SN 56778-57002.....	0591302-1
Doublers.....	0742410-12

Miscellaneous - 172-175

Description	Part No.
Rod.....	0541144
Fitting.....	0510205-4
Left Hand Wing Center Rib.....	0523510-7
Latch Spring Replace Kit.....	SK172-16C

Controls - L-19

Description	Part No.
Pedal Spring.....	0660123
Aft Control Stick Pin.....	0660147
Aileron Pulley Bracket.....	0660246

Tail Surfaces - L-19

Elevator Hinge.....	0634111
---------------------	---------

**172 Cowl Oil Door
FAA/PMA Approved**



Applicable on 172,
172A, B, C, D, E, F,
G, H, I, J, K, L, M,
N, P, Q

Latch.....KM610-64

Part No..... **U0552173-27**

172 D - H Leading Edge Assy.

Description	Part No.
RH Leading Edge Assy.....	0523003-11
LH Leading Edge Assy.....	0523005-55
RH Leading Edge Assy.....	0523005-57

Cessna 180, 182, 185

Engine - Cessna 180 and 185

Description	Part No.
Front Shock Mount.....	0750102-1
Rear Shock Mount.....	0750102-2
Baffle Support.....	0750117-30
Baffle Support.....	0750117-31
Bonding Jumper.....	0750137
Governor Control Arm.....	0750138
Carburetor Air Box Gasket.....	0750142-1
Connector Spring.....	0750290-10
Exhaust Clamp.....	0750290-14

Air Filters

For SN 180-51184 and up
and all 185 serial #'s

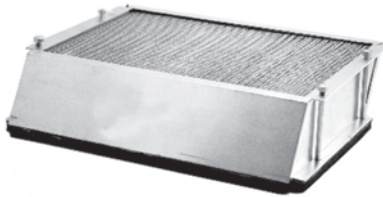

Part Number.....0750038-4

Fuselage - 180 and 185

Description	Part No.
Right Hand Rear Lower Hinge.....	0711037-4
Door Lock Cam.....	0711134-1
Tailwheel Spring Assembly	
Bellcrank.....	0712309-1
Oil Pressure Gauge.....	0713062-4
Pitot Tube Stem.....	0721105-8
Left Hand Nose Cap Doubler.....	0752011-21
Right Hand Bellcrank Assembly.....	0753000-5
Electric Ground Plug Bracket.....	0753016-1

Landing Gear - 180 and 185

Description	Part No.
Right Hand Landing Gear	
Fillet Plate.....	0713018-4
Left Hand Landing Gear	
Fillet Plate.....	0713018-5
Tailwheel Spring Link	
(0742200-6).....	2133
Tailwheel Bushing.....	0742400-11

**Can't find what you
need? Our sales staff
is ready to help.
1-888-433-5433**

Oil Filler Door FAA-PMA Approved



For 180-180G, 182-182G& 185-185C

Part Number..... U0752000-56

For C-182 H, J, K, M, N, & P

Part Number..... U0552173-6

Cowl Flaps All 185 Series FAA - PMA Approved

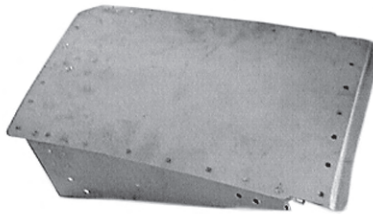

For 180D and Later, 182D & All 185 Series

Left..... U0752014-1

Right..... U0752014-2

C-180, 182 & 185

Horizontal Stabilizer Skins

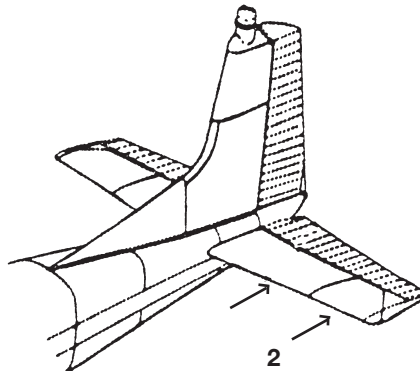

(FAA-PMA Approval Pending)

1. L/H Inboard Stabilizer Skin
.....0732600-5
R/H Inboard Stabilizer Skin
.....0732600-6
2. L/H & R/H Outboard Stabilizer Skin
.....0732600-2

C-180/185, & 182 Rudder & Elevator Skins



Rudder Skin

Elevator Skin

Elevator Skin (sold in pairs)

For 180, 182 - 182D, 185:

Top left & bottom right..... U0734600-500

Top right & bottom left..... U0734600-501

Rudder Skin (sold in pairs)

For all C-180, 185, 182 - 182B:

Right Hand..... U0731000-500

Left Hand..... U0731000-501

Note: To insure that trailing edge corrugations match, it is strongly recommended that skins are purchased in pairs (Top & Bottom or Left & Right). Skins are priced individually.

Cessna Wing Parts

Description	Part No.
Cessna Leading Edge.....	0720001-51
Cessna RH Leading Edge Assy.....	1220002-36
Cessna LH Leading Edge Assy.....	1220002-37

C-182 Spinner Dome For McCauley Constant Speed Propeller FAA/PMA Approved

Applicable on C-182H, J, K, L, M, N, P, Q, & R



Dome includes 4 U0752620-3 Plastic Spacer Rings

Spinner Dome.....U0752637K200

Plastic Spacer Ring.....U0752620-3

Backplate*.....0752637-17

(*Not pictured. Original Cessna Part)

CONTROL SYSTEM

Aileron Hinge

For all C-150, 152,170A, 170B,
172, 180, 182 & 185
FAA-PMA Approved



Part number U0523816-1

Horizontal Stabilizer

Trim Screw Parts

FAA-PMA Approved

For C-180, 185, 182 through 182D



Screw U0712500-11



Barrel U0712500-13

Trim Screw Adjusting Cam

FAA/PMA Approved



Part No. U0712502

Control Cables

FAA/PMA Approved & Original Cessna
for 170, 180, 182 & 185 series aircraft

Cable descriptions are basic.
Please consult your parts manual
for proper cable application, your
model, and serial No.!



Adjusting Screw Boot

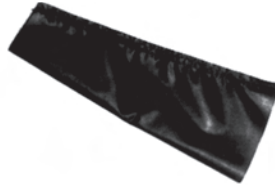

For all C-180, 182-182D, & 185

..... U0712500-18

Stabilizer Jackscrew

Access Cover Kit

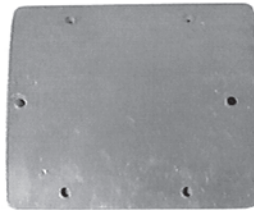

For all C-180 and C-185 thru 1981 A185F

.....SK185-27

Flap Roller Assembly

For all 150-152, 170B, 172,
180 & 185 series



Inside Bushing U0523919

Roller Bearing U0523920

(Outboard flap side)

Roller Bearing U0523921

Elevator Bushings

For : C-170 Hinge & Elevator Bellcrank
Also For: All C-180, 185, & 182 through
182D IB & OB Hinge Bushing and Elevator
Arm upper Bushing on C-182 '62-'82.



Part Number **PC 590** MS24462-4

Replaces AR4-1

Flap Push Rod Bearings



Part Number S1106-3

Note: S1106 Not for use on 172, P172, 172RG.
Use S1819-3

Aileron Push Rod Bearings



Part Number S1819-3

<i>Control Cable Description</i>	<i>Galvanized Steel Part No.</i>	<i>Stainless Steel Part No.</i>	<i>Control Cable Description</i>	<i>Galvanized Steel Part No.</i>	<i>Stainless Steel Part No.</i>
Rudder Cable	MC0510105-1	MC0510105-101	Flap R/H Direct Cable	0510105-18	0510105-118
Aileron Control Cable.....	MC0510105-2	MC0510105-102	Flap L/H Return Cable	0510105-19	0510105-119
Aileron Carry Through	MC0510105-3	MC0510105-103	Flap R/H Return Cable	0510105-20	0510105-120
Elevator Cable.....	MC0510105-4	MC0510105-104	Flap Return-Forward.....	U0510105-21	U0510105-121
Flap Lower Cable	MC0510105-5	MC0510105-105	Flap Direct-Forward	U0510105-22	U0510105-122
Flap Upper Cable.....	MC0510105-6	MC0510105-106	Tailwheel Steering	U0510105-123
Elevator Tab-Forward Up	MC0510105-7	MC0510105-107	Elevator Control-Upper	U0510105-24	U0510105-124
Elevator Tab-Aft Down	MC0510105-8	MC0510105-108	Elevator Control-Lower.....	U0510105-25	U0510105-125
Elevator Tab-Fwd Down.....	MC0510105-9	MC0510105-109	Rudder Control	U0510105-26	U0510105-126
Elevator Tab-Aft Up	MC0510105-10	MC0510105-110	Stabilizer Trim-Forward	U0510105-28	U0510105-128
Flap Upper	MC0510105-11	MC0510105-111	Stabilizer Trim-Aft.....	U0510105-29	U0510105-129
Aileron Direct Cable.....	MC0510105-12	MC0510105-112	Tailwheel Steering	MC0510105-38	MC0510105-138
Aileron Carry Through	U0510105-13	U0510105-113	Rudder Cable-Forward	MC0510105-39	MC0510105-139
Elevator Upper Cable	MC0510105-15	MC0510105-115	Elevator-Lower Forward.....	MC0510105-40	MC0510105-140
Aileron Control Cable.....	U0510105-16	U0510105-116	Elevator-Upper-Aft	MC0510105-41	MC0510105-141
Flap L/H Direct Cable	0510105-17	0510105-117	Elevator-Upper Forward.....	MC0510105-42	MC0510105-142

CONTROL CABLES CONTINUED — FAA-PMA Approved & Original Cessna

Cable descriptions are basic. Please consult your parts manual for proper cable application for your model, and serial Number.

<i>Description</i>	<i>Galvanized Part No.</i>	<i>Stainless Steel Part No.</i>	<i>Description</i>	<i>Galvanized Part No.</i>	<i>Stainless Steel Part No.</i>
Tab Actuator to Turnbuckle	MC0510105-44	MC0510105-144	Control Yoke Cable.....	U0510105-213	U0510105-313
Tab Actuator to Disconnect	MC0510105-45	MC0510105-145	Control Yoke Cable.....	U0510105-214	U0510105-314
Forward Rudder L/H.....	U0510105-51	U0510105-151	Control Yoke Cable.....	U0510105-215	U0510105-315
Aft Rudder Cable.....	U0510105-52	U0510105-152	Control Yoke Cable.....	U0510105-216	U0510105-316
Elevator Aft Lower	MC0510105-54	MC0510105-154	Aileron Direct Cable.....	MC0510105-217	MC0510105-317
Rudder Aft R/H Cable	MC0510105-55	MC0510105-155	Elevator Tab Wheel to Disconnect	MC0510105-220	MC0510105-320
Rudder Aft L/H Cable.....	MC0510105-56	MC0510105-156	Elevator Tab Wheel to Disconnect	MC0510105-221	MC0510105-321
Tab Wheel to Disconnect.....	MC0510105-57	MC0510105-157	Aileron Cable.....	U0510105-222	U0510105-322
Tab Wheel to Turnbuckle.....	MC0510105-58	MC0510105-158	Tailwheel Steering Cable		U0510105-323
Flap Direct Outboard	U0510105-59	U0510105-159	Aileron Direct Cable.....	MC0510105-224	MC0510105-324
Flap Return Outboard	U0510105-60	U0510105-160	Flap Direct Outboard	U0510105-225	U0510105-325
Flap Direct-IB., L/H	U0510105-61	U0510105-161	Flap Direct IB., R/H	U0510105-226	U0510105-326
Flap Direct-IB., R/H	U0510105-62	U0510105-162	Flap Direct IB., L/H.....	U0510105-227	U0510105-327
Flap Return-IB., L/H.....	U0510105-63	U0510105-163	Aileron Direct Cable.....	MC0510105-228	MC0510105-328
Flap Return-IB., R/H	U0510105-64	U0510105-164	Flap Cable.....	0510105-231	0510105-331
Rudder Cable R/H.....	MC0510105-66	MC0510105-166	Parking Brake Cable.....	U0510105-232	
Parking Brake Cable.....	U0510105-70	U0510105-170	Aileron Rudder Intercom		U0510105-334
Forward Rudder R/H	U0510105-71	U0510105-171	Forward Rudder Cable R/H.....	U0510105-237	U0510105-337
Aileron Cable.....	MC0510105-72	MC0510105-172	Rudder Cable R/H.....	MC0510105-238	MC0510105-338
Forward Rudder	U0510105-73	U0510105-173	Rudder Cable L/H.....	MC0510105-239	MC0510105-339
Rudder-Aft L/H.....	MC0510105-75	MC0510105-175	Yoke Cable.....	MC0510105-241	MC0510105-341
Rudder-Aft R/H	MC0510105-76	MC0510105-176	Yoke Cable.....	MC0510105-242	MC0510105-342
Rudder Cable L/H.....	MC0510105-77	MC0510105-177	Yoke Cable.....	MC0510105-243	MC0510105-343
Rudder Cable R/H.....	MC0510105-78	MC0510105-178	Yoke Cable.....	MC0510105-244	MC0510105-344
Elevator Trim Cable.....	U0510105-79	U0510105-179	Elevator Trim L/H Forward.....	MC0510105-245	MC0510105-345
Rudder-Aft L/H.....	MC0510105-80	MC0510105-180	Elevator Trim R/H Forward.....	MC0510105-246	MC0510105-346
Rudder-Aft R/H	MC0510105-81	U0510105-181	Elevator Trim L/H Aft	MC0510105-247	MC0510105-347
Elevator Trim Cable.....	U0510105-82	U0510105-182	Elevator Trim R/H Aft	MC0510105-248	MC0510105-348
Elevator Trim L/H Forward.....	MC0510105-86	MC0510105-186	Elevator Cable R/H.....	MC0510105-249	MC0510105-349
Elevator Trim L/H Aft	MC0510105-87	MC0510105-187	Elevator Cable L/H	MC0510105-250	MC0510105-350
Elevator Down Cable.....	MC0510105-88	MC0510105-188	Aileron Cable.....	MC0510105-260	MC0510105-360
Elevator R/H Cable.....	MC0510105-89	MC0510105-189	Aileron Cable.....	U0510105-262	U0510105-362
Elevator L/H Cable.....	MC0510105-90	MC0510105-190	Aileron Carry Through L/H.....	U0510105-264	U0510105-364
Flap Direct L/H.....	MC0510105-91	MC0510105-191	Aileron Carry Through R/H.....	U0510105-265	U0510105-365
Flap Direct R/H.....	MC0510105-92	MC0510105-192	Parking Brake Cable.....	U0510105-278	
Flap Retract Cable L/H.....	MC0510105-93	MC0510105-193	Elevator Aft Lower	MC0510105-290	MC0510105-390
Flap Retract Cable E/H.....	MC0510105-94	MC0510105-194	Elevator Aft Upper	MC0510105-291	MC0510105-391
Aileron Direct Cable.....	MC0510105-95	MC0510105-195	Tailwheel Lock Cable		MC0510105-394
Tailwheel Steering Cable	MC0510105-96	U0510105-196	Aileron Cable.....	U0510105-295	U0510105-395
Elevator Trim R/H Forward.....	MC0510105-97	MC0510105-197			
Elevator Trim R/H Aft	MC0510105-98	MC0510105-198			
Tailwheel Steering Cable		U0510105-199			
Elevator Trim R/H Forward.....	MC0510105-201	MC0510105-301			
Elevator Trim L/H Forward.....	MC0510105-202	MC0510105-302			
Rudder Cable L/H.....	MC0510105-205	MC0510105-305			
Rudder Cable R/H.....	MC0510105-206	MC0510105-306			
Rudder Cable Aft.....	MC0510105-207	MC0510105-307			
Elevator Cable Lower	MC0510105-208	MC0510105-308			
Elevator Cable-Aft Upper.....	0510105-209	0510105-309			
	use MC0510105-291	use MC0510105-391			
Elevator Cable-Aft Lower	0510105-210	0510105-310			
	use MC0510105-290	use MC0510105-390			



**Do you have suggestions on new products for Cessna?
Call, write, fax or make a suggestion through
our web site: www.univair.com**

Fuselage - 190 and 195

Co-Pilot Right Hand Rudder Bar Bulkhead.....	0311288-4
Fuel Tank Cap Gasket.....	0322551

Landing Gear - 190 and 195

Wheel Half Attach Nut.....	0341005-15
Pin.....	0341005-23
Outboard Brake Lining.....	0341015-3
1° Toe Out Shim.....	0341116-3
2° Toe Out Shim.....	0341116-4

Tail Surfaces - 190 and 195

Elevator Skin Reinforcement.....	0334100-20
----------------------------------	------------

Cessna 210

210 B Right Hand Wing (New in factory crate).....	1220002-204
210 B, Left Hand Elevator (New) ..	1234000-30

Cessna 310

Foul Weather Window Latch.....	0811725-35
Aft Fuselage Section, SN 35000-35546.....	0891200-1
Aft Fuselage Section, SN 35000-35225.....	0891200-6
Aft Fuselage Section, SN 35226-35546.....	0891201-2

Magneto Noise Filter



Noise filter.....A293

PC 245

Thermometer



Thermometer has both Centigrade and Fahrenheit dial graduations. It can be installed through plexiglass windshield or cowling on most aircraft or through the center strip in the windshield.

Thermometer.....2716A

PC 690

Cessna Miscellaneous

<i>Description</i>	<i>Part No.</i>
Bracket.....	0334211-2
Washer.....	0342147-1
Seal.....	0350131
Support.....	0350251
Bracket.....	0352120
Bracket.....	0352120-3
Strap.....	0411575-6
Block.....	0411657
Channel.....	0422214
Bushing.....	0450275
Door Post.....	0512124-17
Gasket.....	0532531
Skin (Blank).....	0533000-15
Spring.....	0543020
Block.....	0543024-1
Doubler.....	0543026
Spacer.....	0543047
Spring.....	0611279
Handle.....	0711022
Cover.....	0813457-6
Hinge.....	0831000-28
Voltage Regulator.....	0850460-7

Miscellaneous

Airpath Compass

Used in most light aircraft instrument panels that have the 2¼-inch panel cutouts. Has self-luminous dial and built-in compensator magnets.



Part Number.....C-2300

PC 635

3200 Tailwheel Assembly

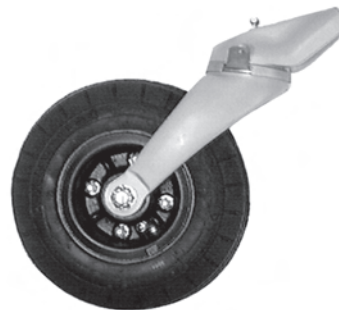

Pneumatic Assembly..... 3200

PC 690

Aerometer*

FAA/PMA Approved

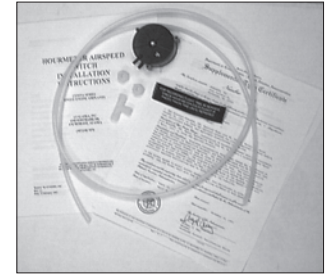

What is Aerometer?

Aerometer is an FAA/PMA Approved device that electrically activates an existing hourmeter when the forward motion of the aircraft exceeds 27 mph IAS.

What is Aircraft Time In Service?

As defined by FAR Part 1, "Time In Service, with respect to maintenance time records, means the time from the moment an aircraft leaves the surface of the earth until it touches at the next point of landing".

Why track Aircraft Time In Service?

Aerometer accurately tracks Aircraft Time In Service, not time spent taxiing, warming up, or waiting for clearances. By accurately tracking Aircraft Time In Service, you are guaranteed:

- To produce more revenue flight hours -----between 100 hour inspections.
- • To generate more revenue hours between -----mandatory engine and prop TBOs.
- To extend the revenue generating period -----for life limited components.

Who should use Aerometer?

Any light aircraft can benefit from Aerometer! Charter operations and flight schools who customarily bill from the flight hour recorder can still take advantage of Aerometer. Simply install a second hourmeter to track Time In Service in conjunction with Aerometer.

Is it easy to install?

Aerometer comes complete in kit form and can be installed in most aircraft in under 2 hours. Installation of this device requires no structural or sheet metal modification.

The Aerometer is available in comprehensive kit form with all the necessary components as well as STC paperwork and complete installation.

Kit for single engine Cessna Aircraft

Part Number AEROMETER-CES

PC 635

Miscellaneous (continued)

Military Surplus Seat Belt



3 Inches Wide, Heavy Duty

Nylon..... 44G5437
 Cotton 44G5437S

PC 699

Cleveland Wheel and Brake Assemblies

For additional information See Tires, Wheels and Brakes section in this catalog.

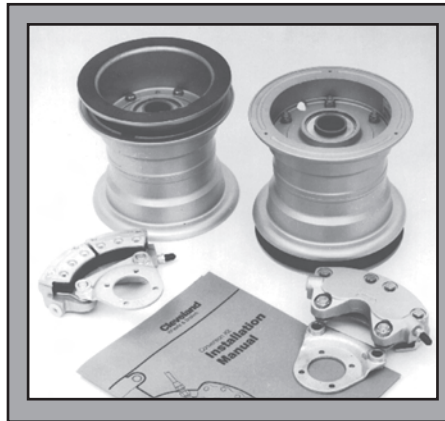

**WHELEN
 MODEL 70509 FLASHER**



SPECIFICATIONS:

Current Draw:

2.7 AMPS @ 14V
 1.35 AMPS @ 28V

Weight: .27 lbs.

Wire: 20 AWG Teflon

Lamp: 35W Halogen

Filament: CC-8 (Axial)

Lens: Lexan® Polycarbonate

Whelen Engineering introduces the Model 70509 Flasher, a totally new self-contained, flashing anti-collision light assembly that is FAA TSO-C96A approved. The Model 70509 FLASHER features a rugged polycarbonate lens with internal optics (patent pending), replaceable halogen lamp and flasher assemblies. It can be installed as a replacement on 1967-1979 Cessna aircraft, on most general aviation aircraft, home builds, and ultralights. A separate flasher power pack is not needed because the unit is completely self-contained.

PC 620

PART NUMBER	DESCRIPTION
01-0770509-05	28V Flasher Assembly (red/white)
01-0770509-04	28V Flasher Assembly (white)
01-0770509-03	28V Flasher Assembly (red)
01-0770509-02	14V Flasher Assembly (red/white)
01-0770509-01	14V Flasher Assembly (white)
01-0770509-00	14V Flasher Assembly (red)

CONVERSION KITS FOR CESSNA

APPLICATION	KIT NO.	DESCRIPTION
120, 140 (S/N 8004 thru 13399), 140A (S/N 13400 & up), 170, 170A, 170B, 172, 172A thru 172E, 175, 175A, 175B, 175C, P172D, 180, 180A thru 180F, 182, 182A thru 182G	199-04600	Converts Goodyear to Cleveland; Cannot be used with crosswind landing gear. Installation per FAA STC SA 13GL.
150, F150, A150, FA150, 152, A152, F152, FA152, 177, 177RG, F177RG, 182, A182, F182	199-08400	Converts McCauley to Cleveland Installation per FAA form 337. (2)
172, F172, R172, FR172	199-08401	Converts McCauley to Cleveland Installation per FAA Form 337. (2)
180, 180A thru 180F, 180H, 180J, 185 185A, 185B, 185E, A185F, 206E, 206F, TU206E, TU206F	199-06200	This kit is to be used only with Cessna Axles. P/N 0541124 & 1441003-1, not for use on aircraft equipped with crosswind landing gear. Installation per FAA STC SA63GL.
180, 180A thru 180F, 180H, 180J, 185, 185A, 185B, A185E, A185F, 206E, 206F, TU206E, TU206F	199-15500	High corrosion Resistant Kit Direct Replacement for 40-75D and 30-52N. Installation per FAA Form 337. (2)
180, 180A thru 180F, 180H, 180J, 185, 185A, 185B, A185E, A185F, 206E, 206F, TU206E, TU206F, 210, 210A, 210B, 210C, 210K, 210L, 210M, T210C, T210K, T210L, T210M, T210N	199-06000	This kit is to be used only with Cessna Axles P/N 0541124 & 1441003-1, not for use on aircraft equipped with crosswind landing gear. Installation per FAA STC SA52GL & SA62GL.
190, 195, 195A, 195B	199-06100	This kit is not for use on aircraft equipped with crosswind landing gear. Installation per FAA STC SA54GL.

PC 660

- (1) Also available with chrome plated brake discs. To order, specify kit number, followed by "CHROME".
- (2) The installer is required to obtain FAA field approval for the modification prior to returning the aircraft to service. Consult your local Flight Standards District Office (F. S. D. O.) for pre-approval guidelines.

IGNITION LEADS AT LOW PRICES!

101 series, 7mm, fits all engines with S6 Bendix series or Slick magnetos that have a threaded backplate. For additional details, see Engine Parts and Accessories section in this catalog.

NEED A NEW WINDSHIELD?

See our Windows and Windshields section in this catalog.