

PRINCIPLES & PRACTICE OF
PHYSICS

Chapter 12
Torque

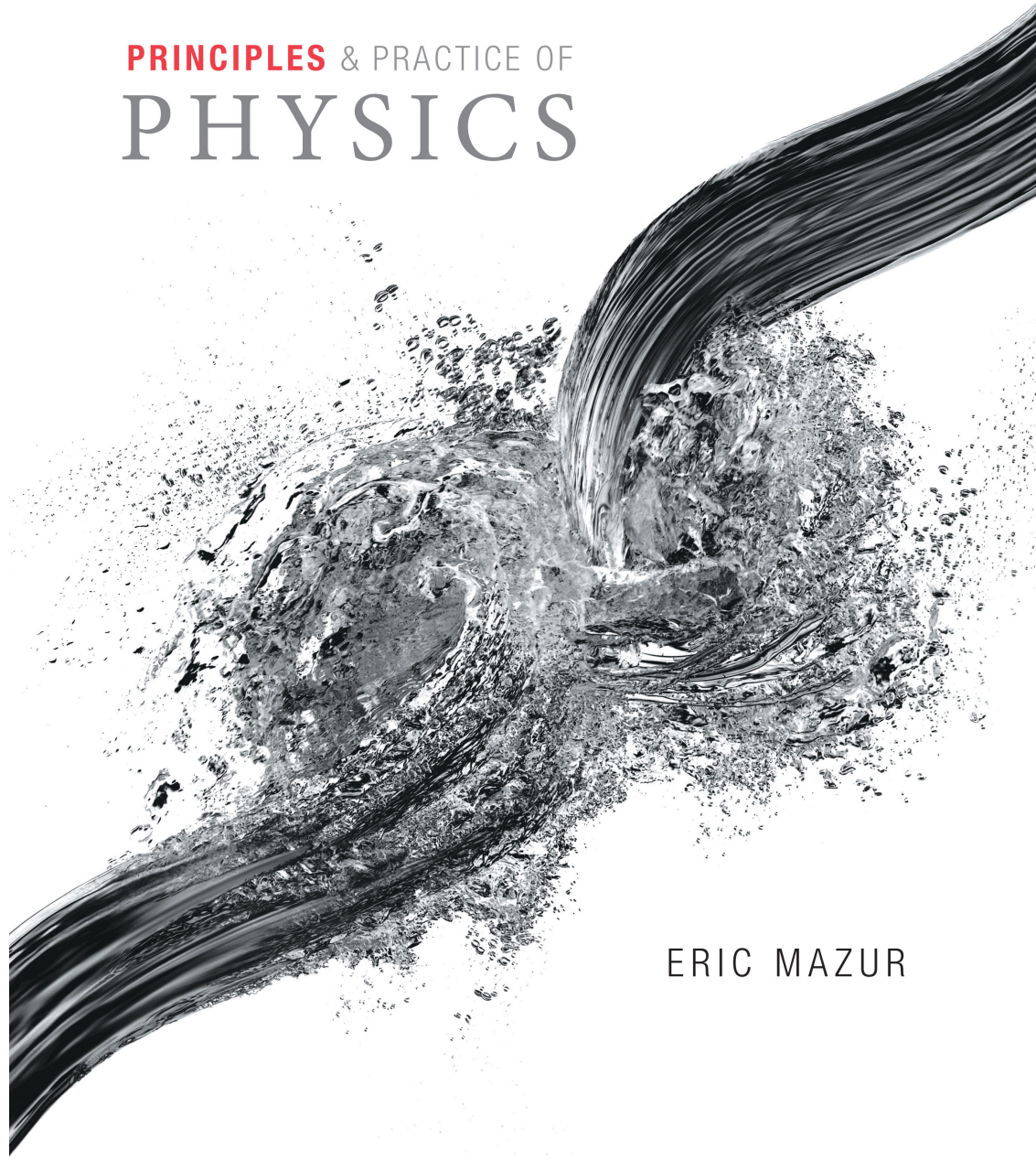

ERIC MAZUR

Schedule

- 3-Nov torque 12.1-5
- 5-Nov torque 12.6-8
- 10-Nov fluids 18.1-8
- 12-Nov periodic motion 15.1-7
- 17-Nov waves in 1D 16.1-6
- 19-Nov waves in 2D, 3D 16.7-9, 17.1-3
- 24-Nov gravity 13.1-8
- 26-Nov **OFF**
- 1-Dec entropy 19.1-8
- 3-Dec thermal energy 20.all

Section 12.1: Torque and angular momentum

Section Goals

You will learn to

- Explain the causes of rotational motion using torque (the rotational analog of force).
- Identify the factors that influence the ability of a force to rotate a rigid object.
- Determine the net torque when multiple forces act on a rigid object, using the superposition principle.
- Identify and apply the conditions that cause an object to be in a state of rotational equilibrium.

Section 12.1: Torque and angular momentum

- If you exert a force on the edge of stationary wheel or a cap of a jar tangential to the rim, it will start to rotate.

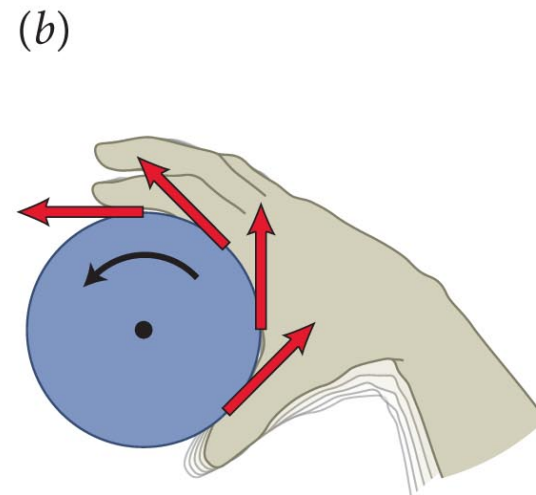
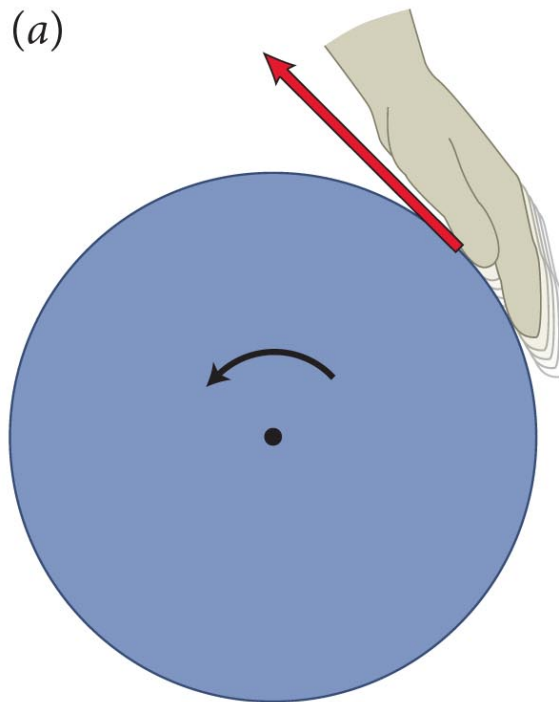

Section 12.1: Torque and angular momentum

- To push a seesaw to lift a child seated on the opposite side as shown in the figure, it is best to push
 1. as far as possible from the pivot, and
 2. in a direction that is perpendicular to the seesaw.
- But, why are these the most effective ways to push the seesaw?
- We will try to answer this in the next few slides.

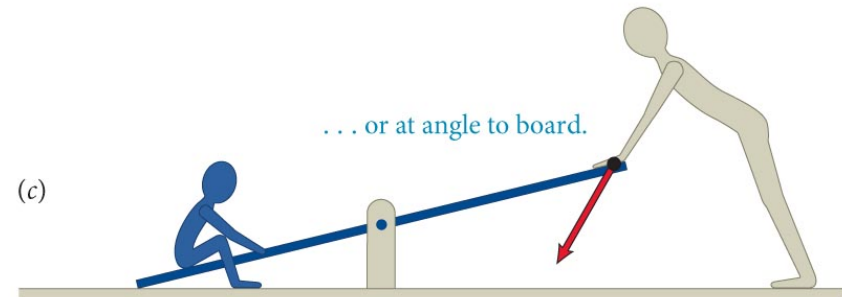
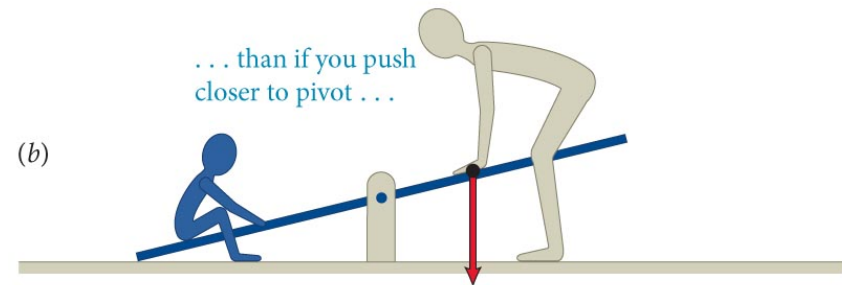
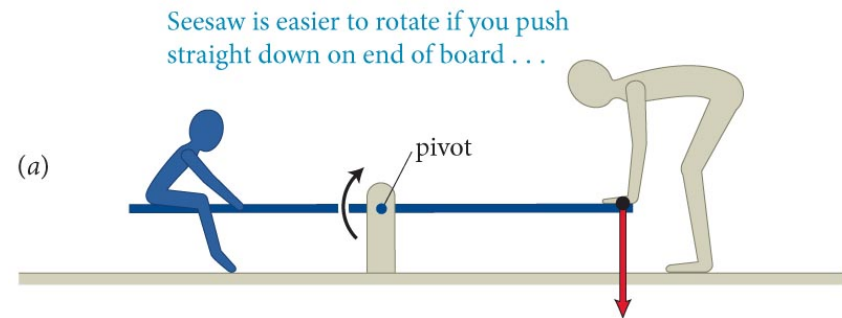

Section 12.1: Torque and angular momentum

- The ability of a force to rotate an object about an axis is called **torque**.
- Experiments indicate that the rod in the figure is balanced if $r_1 F_1 = r_2 F_2$.
- This suggests that
$$\text{torque} = r_{\perp} F,$$
where r_{\perp} (referred to as *lever arm*) is the perpendicular distance from the location of force to the pivot.
- We can see that applying the force as far as possible from the pivot point increases the torque.

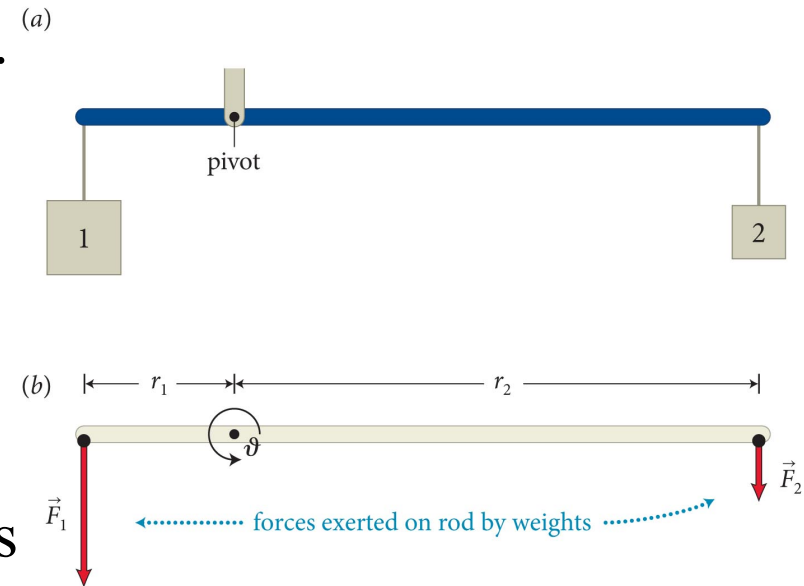

Section 12.1: Torque and angular momentum

- A force is most effective at rotating the seesaw when it is oriented perpendicular to the seesaw.
- Reason: Only the component of the force perpendicular to the seesaw (F_{\perp}) that causes the seesaw to rotate.

(c) Only the component of \vec{F} perpendicular to board does work on seesaw.

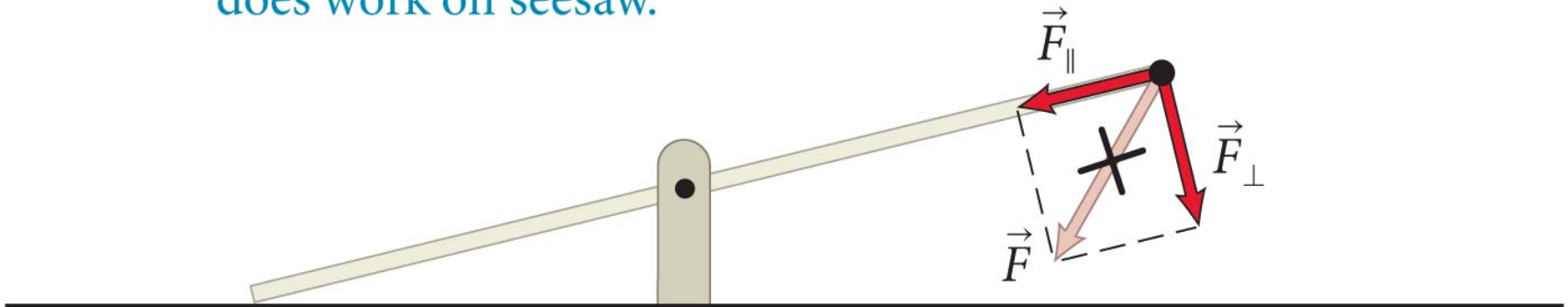

Checkpoint 12.1



12.1 (a) Draw a free-body diagram for the rod of the figure below. Let the inertia of the rod be negligible compared to m_1 and m_2 .

(b) Would the free-body diagram change if you slide object 2 to the left?

(c) Experiments show that when $m_1 = 2m_2$ the rod is balanced for $r_2 = 2r_1$. How is the ratio r_1/r_2 related to the ratio m_1/m_2 ?

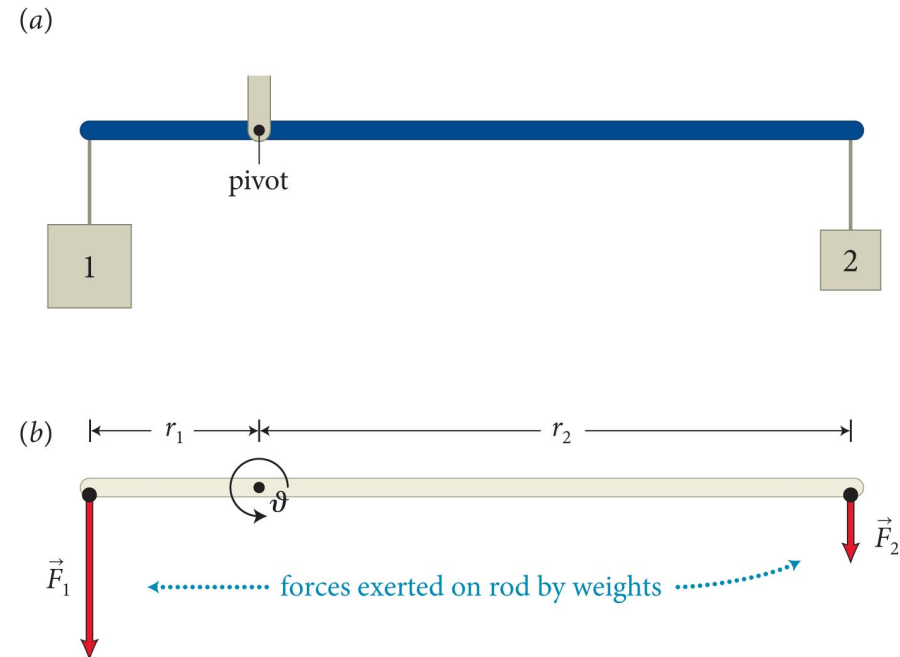

Checkpoint 12.1

- four forces on rod:
 - gravity (negligible)
 - downward contact forces of the two objects
 - upward force by pivot
- rod is still subject to the same forces
 - no change to free body diagram
 - it will rotate, but free body diagram misses this!
- $r_1/r_2 = m_2/m_1$

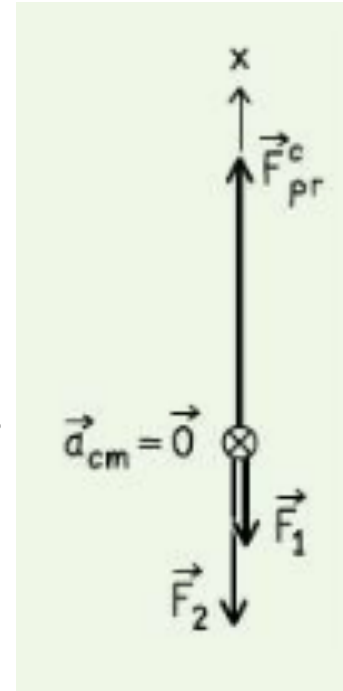

Checkpoint 12.1 (cont.)



12.1 (d) What would happen if you remove object 1?

(e) What would happen if you double the inertia of object 1?

(f) What would happen if you carefully place a penny on top of object 1? Let the inertia of the two objects be significantly larger than that of the penny.

(g) Is there a difference between what would happen in parts e and f?

(a)



(b)

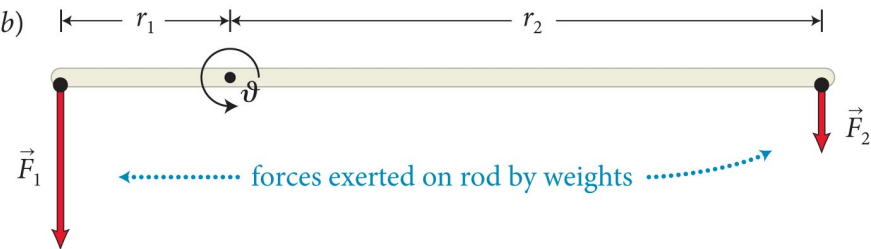

Checkpoint 12.1

- remove object 1 – that end shoots up, object 2 falls
- double object 1 – $2m_1$ goes down, object 2 pulled up
- penny on object 1 – no longer balanced, m_1 falls
- speed of rotation is fast in e , slow in f

(a)



(b)

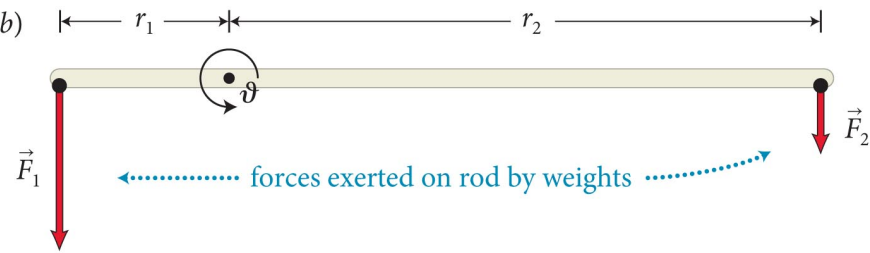

Section 12.1: Torque and angular momentum

- Torque is the product of the magnitude of the force and its lever arm distance.

Two ways to determine torque:

$$\text{torque} = rF_{\perp} = r(F \sin \theta)$$

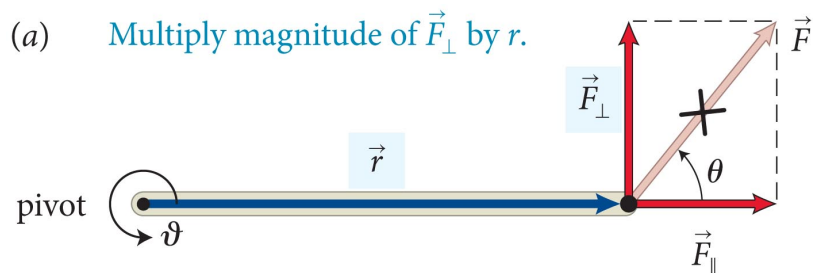

$$\text{torque} = r_{\perp}F = (r \sin \theta)F$$

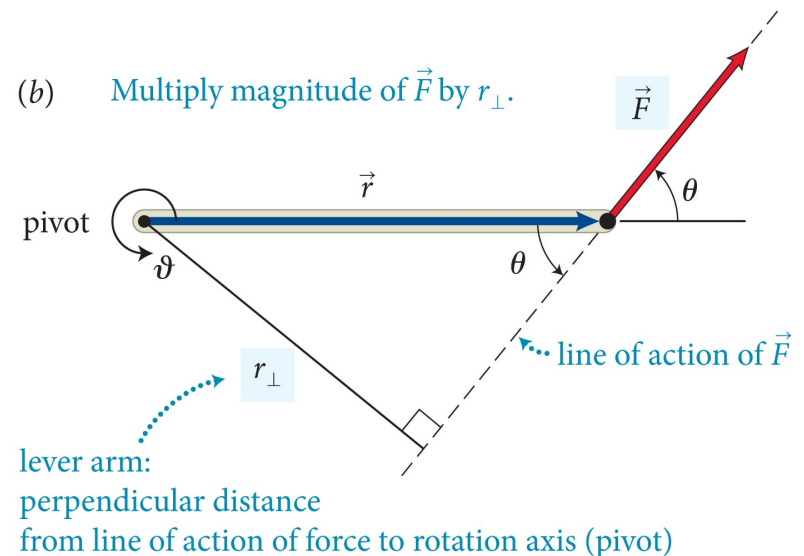

Section 12.1: Torque and angular momentum

- The mathematical expression for torque is

$$\text{torque} = r(F \sin \theta)$$

- The effectiveness of a force to rotate an object about an axis depends on
 - the magnitude of the applied force (F).
 - the distance from the pivot to the point force is applied (r).
 - the angle at which the force is applied (θ).

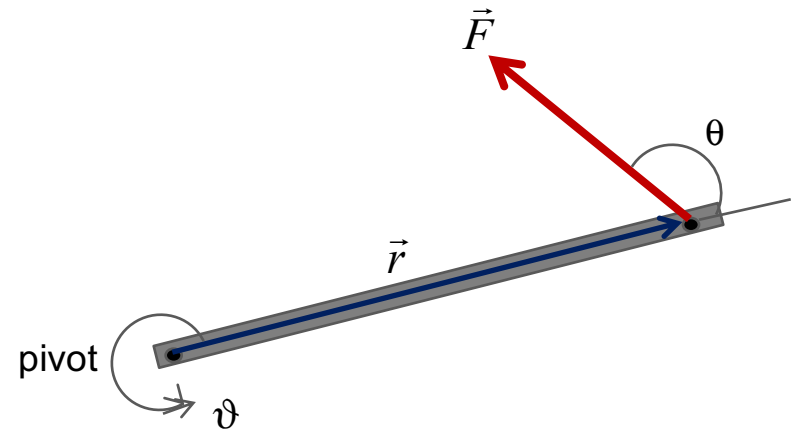

Section 12.1: Torque and angular momentum

Torque has a sign.

- The sign of the torque depends on the choice of direction for increasing θ .
- In the figure the torque caused by \vec{F}_1 is positive because it tends to increase θ (CCW)
- The torque caused by \vec{F}_2 is negative (CW)
- Therefore, the sum of the two torques is $r_1F_1 - r_2F_2$.

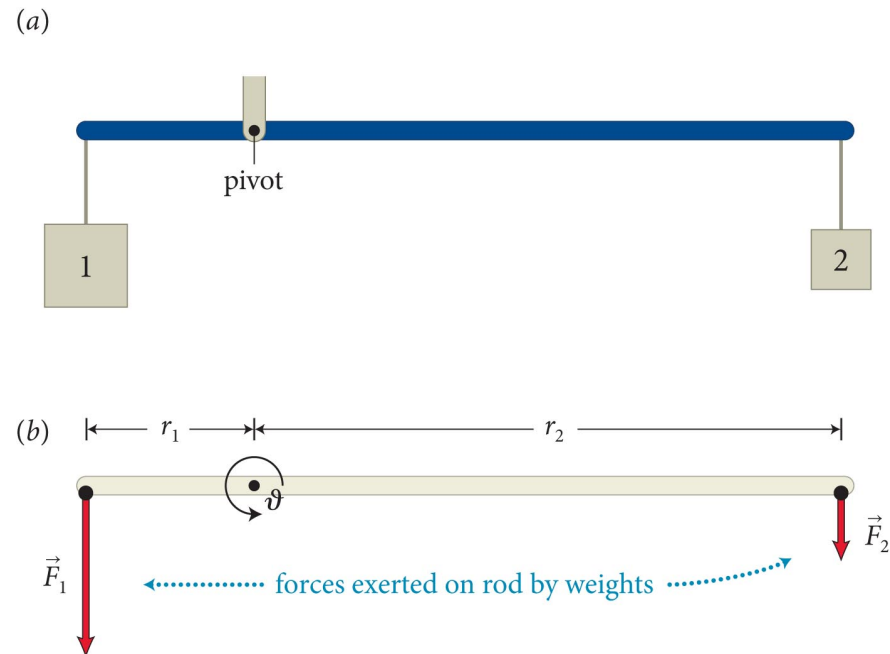

For stationary objects, the sum of torques is zero.

Checkpoint 12.2



12.2 In the situation depicted in Figure 12.2a, you must continue to exert a force on the seesaw to keep the child off the ground. The force you exert causes a torque on the seesaw, and yet the seesaw's rotational acceleration is zero. How can this be if torques cause objects to accelerate rotationally?

Seesaw is easier to rotate if you push straight down on end of board . . .

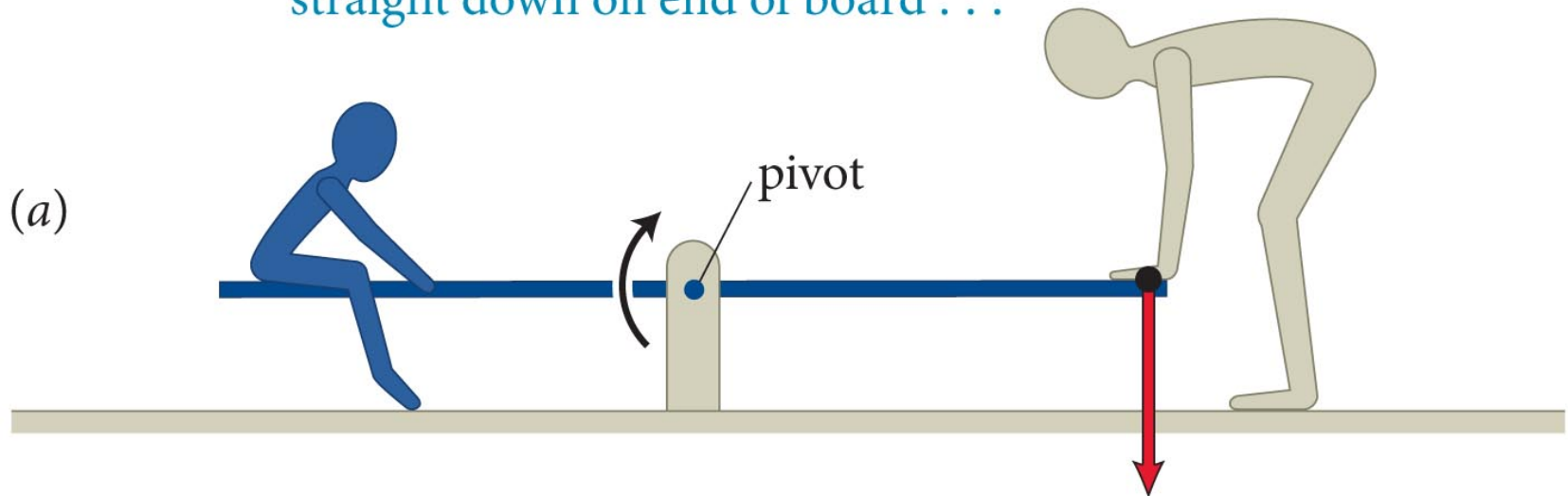

Checkpoint 12.2

Seesaw

- The seesaw remains at rest because the child causes a torque on the seesaw that is equal in magnitude to yours, but tends to rotate the seesaw in the opposite direction

Section 12.1

Question 1

You are trying to open a door that is stuck by pulling on the doorknob in a direction perpendicular to the door. If you instead tie a rope to the doorknob and then pull with the same force, is the torque you exert increased?

1. Yes
2. No

Section 12.1

Question 1

You are trying to open a door that is stuck by pulling on the doorknob in a direction perpendicular to the door. If you instead tie a rope to the doorknob and then pull with the same force, is the torque you exert increased?

1. Yes
- ✓ 2. No – perpendicular distance to pivot and force have not changed

Section 12.1

Question 2

You are using a wrench and trying to loosen a rusty nut. Which of the arrangements shown is most effective in loosening the nut? List in order of descending efficiency the following arrangements:

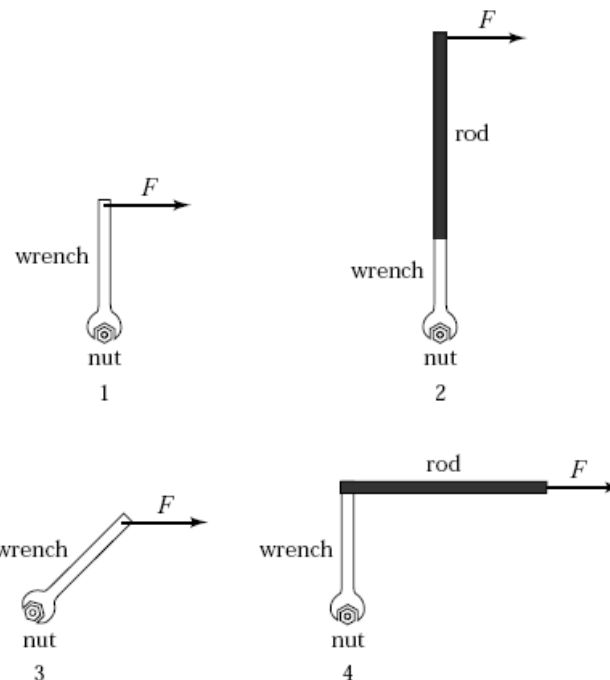

Section 12.1

Question 2

You are using a wrench and trying to loosen a rusty nut. Which of the arrangements shown is most effective in loosening the nut? List in order of descending efficiency the following arrangements:

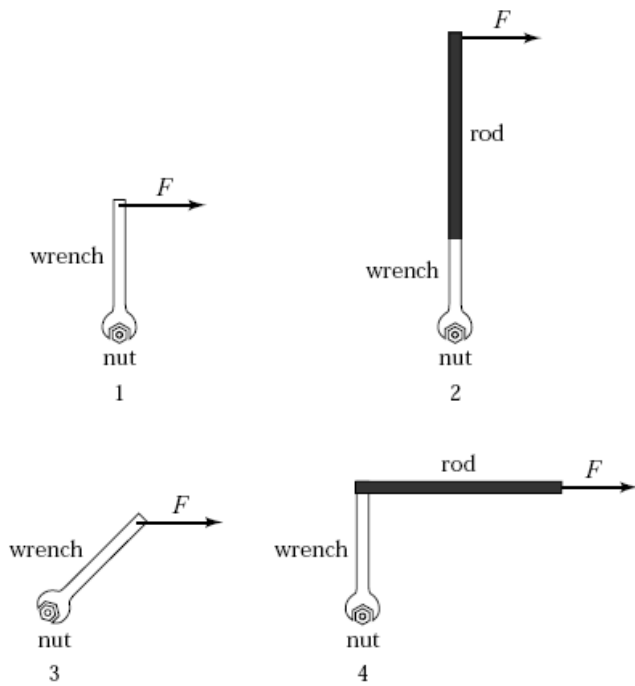

$2 > 1 = 4 > 3$

Section 12.1: Torque and angular momentum

Example 12.2 Torques on lever

Three forces are exerted on the lever of Figure 12.7. Forces \vec{F}_1 and \vec{F}_3 are equal in magnitude, and the magnitude of \vec{F}_2 is half as great. Force \vec{F}_1 is horizontal, \vec{F}_2 and \vec{F}_3 are vertical, and the lever makes an angle of 45° with the horizontal. Do these forces cause the lever to rotate about the pivot? If so, in which direction?

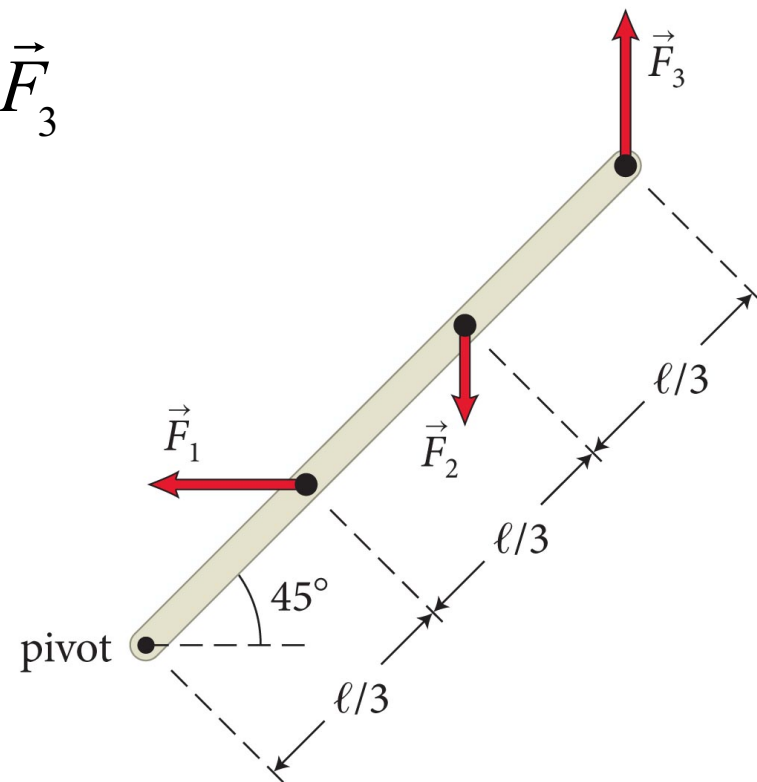

Section 12.1: Torque and angular momentum

Example 12.2 Torques on lever (cont.)

1 GETTING STARTED I begin by arbitrarily choosing counter-clockwise as the direction of increasing θ . With that choice of θ , \vec{F}_1 and \vec{F}_3 cause positive torques about the pivot, while \vec{F}_2 causes a negative torque. To answer the question, I need to determine the magnitude and sign of the sum of these three torques about the pivot.

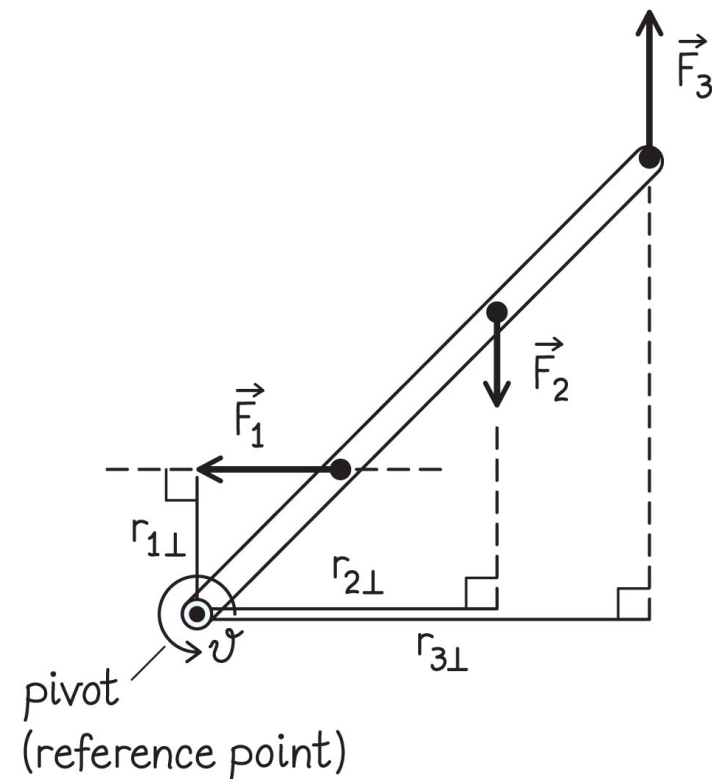

Section 12.1: Torque and angular momentum

Example 12.2 Torques on lever (cont.)

② DEVISE PLAN The forces are not perpendicular to the long axis of the lever, and so I need to follow one of the two procedures shown in Figure 12.5 (in text) to determine the torques about the pivot. I arbitrarily choose to determine the lever arm distances.

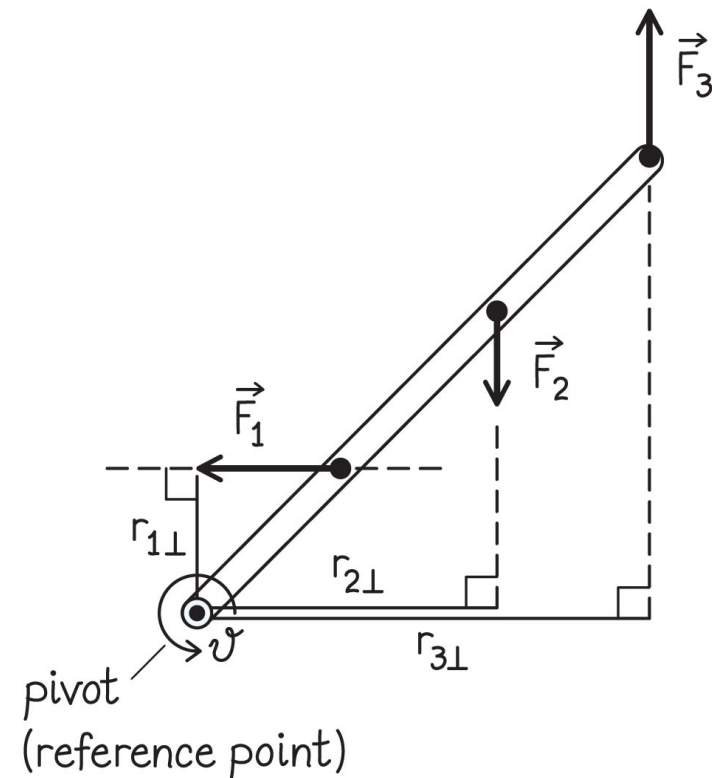

Section 12.1: Torque and angular momentum

Example 12.2 Torques on lever (cont.)

② DEVISE PLAN To determine these distances relative to the pivot, I make a sketch showing the forces and the perpendicular distance from the pivot to the line of action of each force. I can then get the magnitude of each torque by multiplying each force magnitude by the corresponding lever arm distance. Knowing the sign and magnitude of each torque, I can determine the combined effect of the three torques.

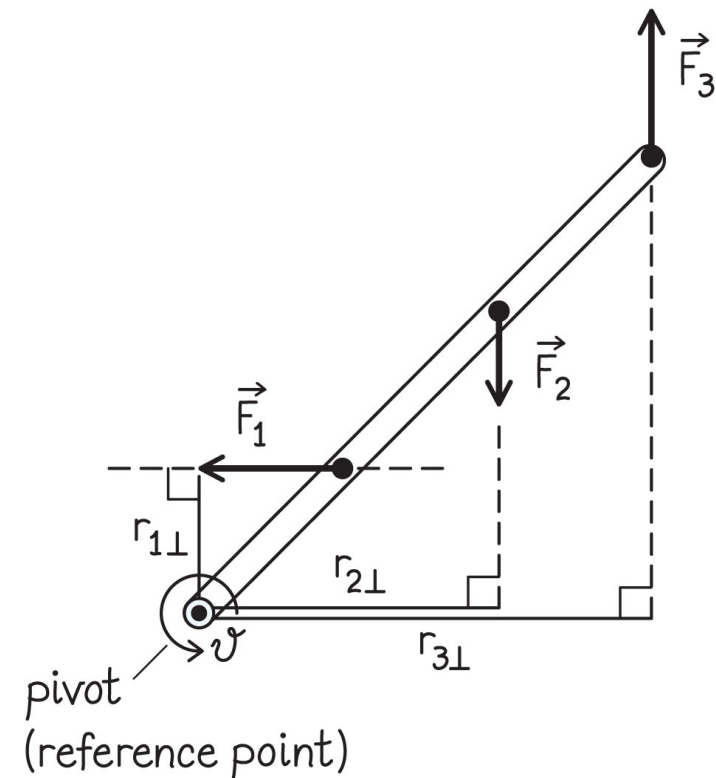

Section 12.1: Torque and angular momentum

Example 12.2 Torques on lever (cont.)

3 EXECUTE PLAN I know that $F_1 = 2F_2$. My sketch tells me that $r_{1\perp} = (\ell/3)\sin 45^\circ$ and $r_{2\perp} = (2\ell/3)\cos 45^\circ$, and so $r_{1\perp} = \frac{1}{2} r_{2\perp}$ because $\sin 45^\circ = \cos 45^\circ$. Therefore the torques caused by these two forces about the pivot are equal in magnitude:

$$r_{1\perp} F_1 = \left(\frac{1}{2} r_{2\perp}\right) (2F_2) = r_{2\perp} F_2.$$

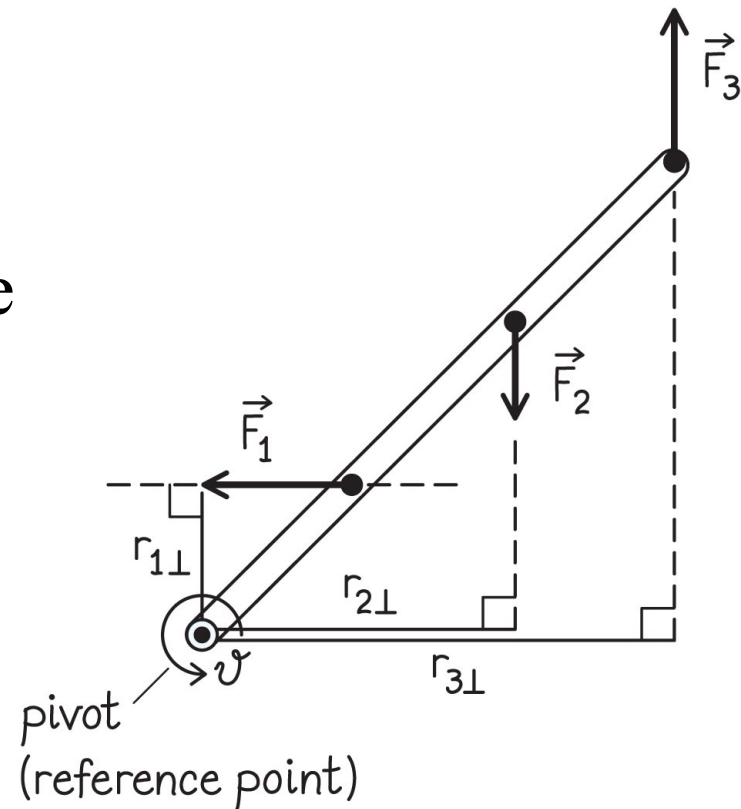

Section 12.1: Torque and angular momentum

Example 12.2 Torques on lever (cont.)

③ EXECUTE PLAN Because the two torques carry opposite signs, their sum is thus zero and their effects cancel. This means that the torque caused by \vec{F}_3 determines whether or not the lever rotates and, if so, in which direction. Because this torque is nonzero and counterclockwise, the lever rotates in a counterclockwise direction. ✓

Section 12.1: Torque and angular momentum

Example 12.2 Torques on lever (cont.)

④ EVALUATE RESULT Looking at Figure 12.7, I see that the two larger forces (\vec{F}_1 and \vec{F}_3) cause counterclockwise torques about the pivot, and only the smaller force \vec{F}_2 causes a clockwise torque. Thus it makes sense that the lever rotates in the counterclockwise direction.

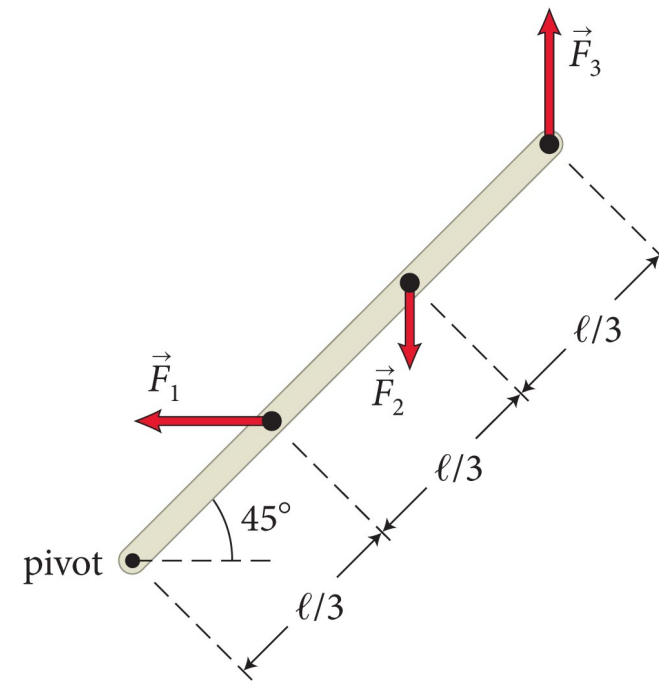

Checkpoint 12.3

 **12.3** (a) Without changing the magnitude of any of the forces in Example 12.2, how must you adjust the direction of \vec{F}_3 to prevent the lever from rotating? (b) If, instead of adjusting the direction of \vec{F}_3 , you adjust the magnitude of \vec{F}_2 , by what factor must you change it?

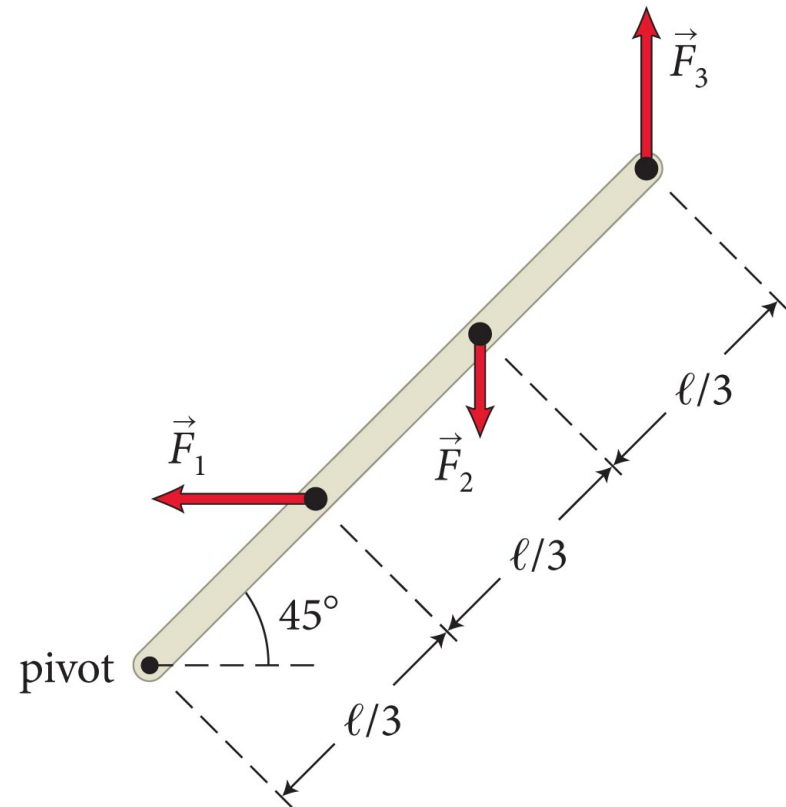

Checkpoint 12.3

- could align F_3 along the axis of the rod – no torque
- was balanced before. now need F_2 to overcome F_3
- noting $F_1 = F_3$, $r_{2\perp} = 2r_{1\perp}$, and $r_{3\perp} = 3r_{1\perp}$:

$$r_{1\perp}F_1 - 2r_{1\perp}F_2 + 3r_{1\perp}F_1 = 0$$

- requires $F_2 = 2F_1$, so have to increase F_2 by 4 times

Section 12.2: Free rotation

Section Goals

You will learn to

- Extend the concept of rotation to situations where the axis of rotation of an object is free to move in space.
- Understand how the center of mass determines the axis of rotation for unconstrained objects.

Section 12.2: Free rotation

- This figure shows the free rotation of a wrench thrown vertically upward with a clockwise spin.
- Notice that the center of mass of the wrench executes a nearly vertical trajectory as it rises.
- But notice that the motion of a point near the handle of the wrench is somewhat complicated; it is neither circular nor linear.

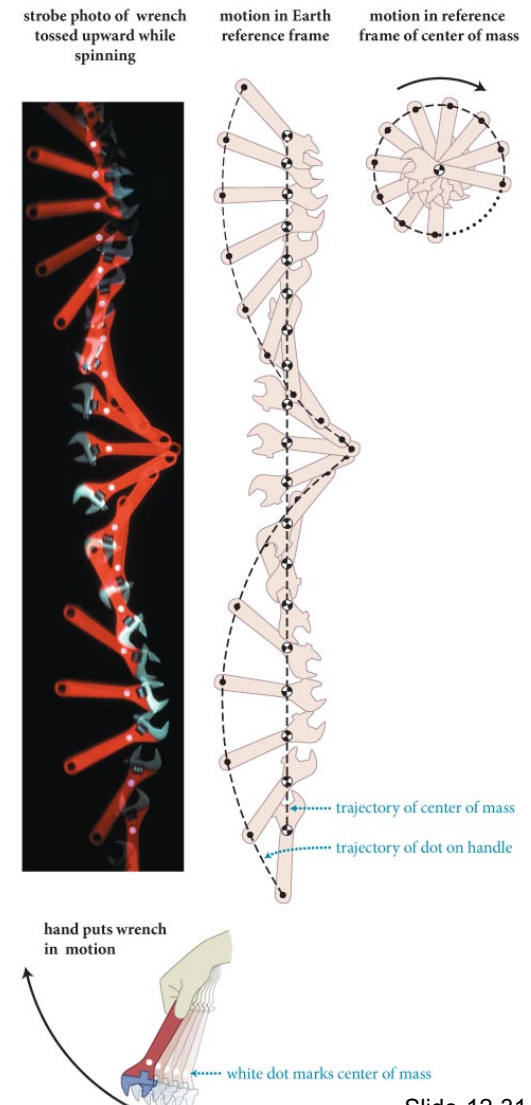

Section 12.2: Free rotation

- The center of mass motion of the wrench is consistent with free fall. Notice how the spacing of the center of mass location decreases slightly as it rises.
- This is the same as one would expect for a point particle launched upward under the influence of gravity.
- But, notice that the motion of the dot on the wrench about the center of mass is that of uniform circular motion.
- This is consistent with the wrench having no external rotational influences after it is launched.

Section 12.2: Free rotation

- The analysis of this situation leads to a powerful generalization:

Objects that are made to rotate without external constraints always rotate about the center of mass.

Checkpoint 12.4

 **12.4** As the wrench in Figure 12.9 moves upward, the upward translational motion of its center of mass slows down. Does the rotation about the center of mass also slow down? Which way does the wrench rotate when it falls back down after reaching its highest position?

Neglecting air resistance, rotation is steady. Translational and rotational motions are uncoupled – gravity doesn't alter rotation. It keeps rotating the same way.

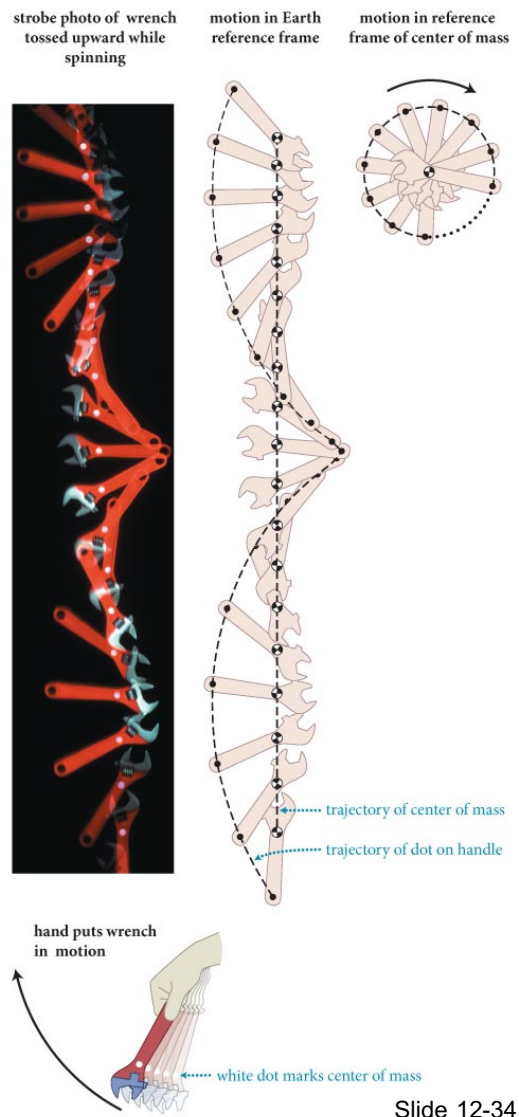

Section 12.3: Extended free-body diagram

Section Goal

You will learn to

- Construct extended force diagrams that account for rotation of objects.

Section 12.3: Extended free-body diagram

Procedure: Extended free-body diagram

1. Begin by making a standard free-body diagram for the object of interest (the *system*) to determine what forces are exerted on it. Determine the direction of the acceleration of the center of mass of the object, and draw an arrow to represent this acceleration.
2. Draw a cross section of the object in the plane of rotation (that is, a plane perpendicular to the rotation axis) or, if the object is stationary, in the plane in which the forces of interest lie.

Section 12.3: Extended free-body diagram

Procedure: Extended free-body diagram (cont.)

3. Choose a reference point. If the object is rotating about a hinge, pivot, or axle, choose that point. If the object is rotating freely, choose the center of mass. If the object is stationary, you can choose any reference point.

Section 12.3: Extended free-body diagram

Procedure: Extended free-body diagram (cont.)

3(cont.). Because forces exerted at the reference point cause no torque, it is most convenient to choose the point where the largest number of forces are exerted or where an unknown force is exerted. Mark the location of your reference point and choose a positive direction of rotation. Indicate the reference point in your diagram by the symbol \odot .

Section 12.3: Extended free-body diagram

Procedure: Extended free-body diagram (cont.)

4. Draw vectors to represent the forces that are exerted on the object and that lie in the plane of the drawing. Place the tail of each force vector at the point where the force is exerted on the object. Place the tail of the gravitational force exerted by Earth on the object at the object's center of mass. Label each force.
5. Indicate the object's rotational acceleration in the diagram (for example, if the object accelerates in the positive θ direction, write $\alpha_\theta > 0$ near the rotation axis). If the rotational acceleration is zero, write $\alpha_\theta = 0$.

Section 12.3: Extended free-body diagram

Exercise 12.3 Holding a ball

You hold a ball in the palm of your hand, as shown in Figure 12.10. The bones in your forearm act like a horizontal lever pivoted at the elbow. The bones are held up by the biceps muscle, which makes an angle of about 15° with the vertical. Draw an extended free-body diagram for your forearm.

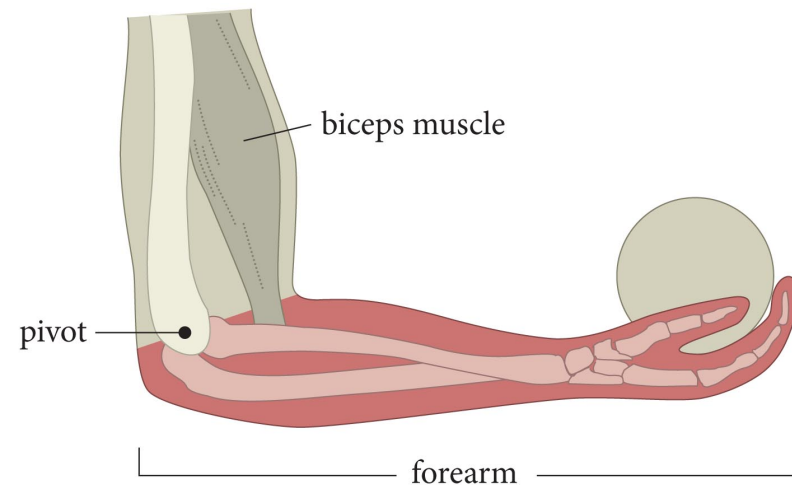

Section 12.3: Extended free-body diagram

Exercise 12.3 Holding a ball (cont.)

(a) Free-body diagram

(b) Extended free-body diagram

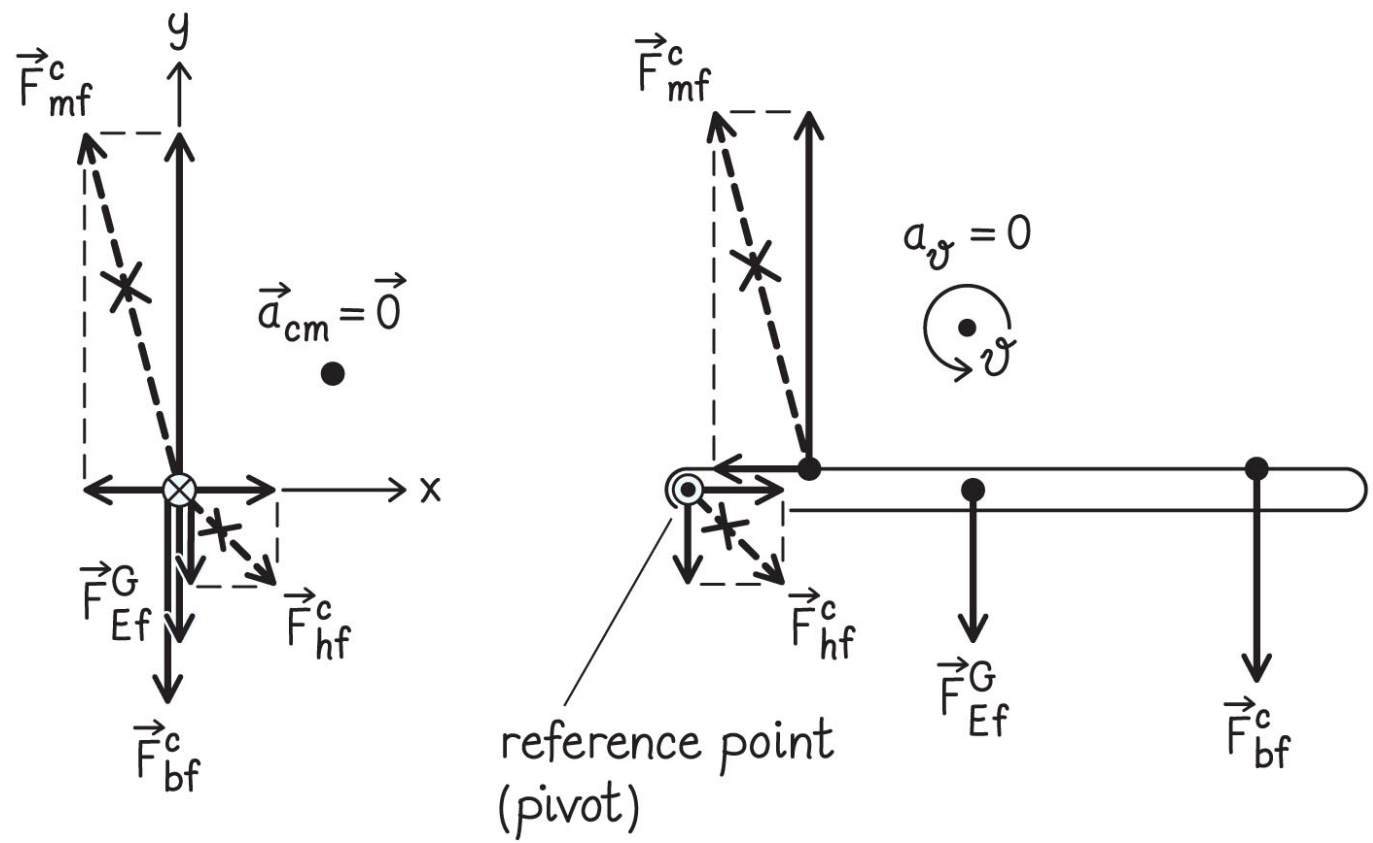

how to get direction of F_{hf} ? Overall vector sum is zero

Checkpoint 12.5



- 12.5** (a) If the biceps muscle in Figure 12.10 were attached farther out toward the wrist, would the torque generated by the muscle about the pivot get greater, get smaller, or stay the same?
- (b) As the hand is raised above the level of the elbow, so that the forearm makes an angle of 15° with the horizontal, does the arm's capacity to lift objects increase, decrease, or stay the same?

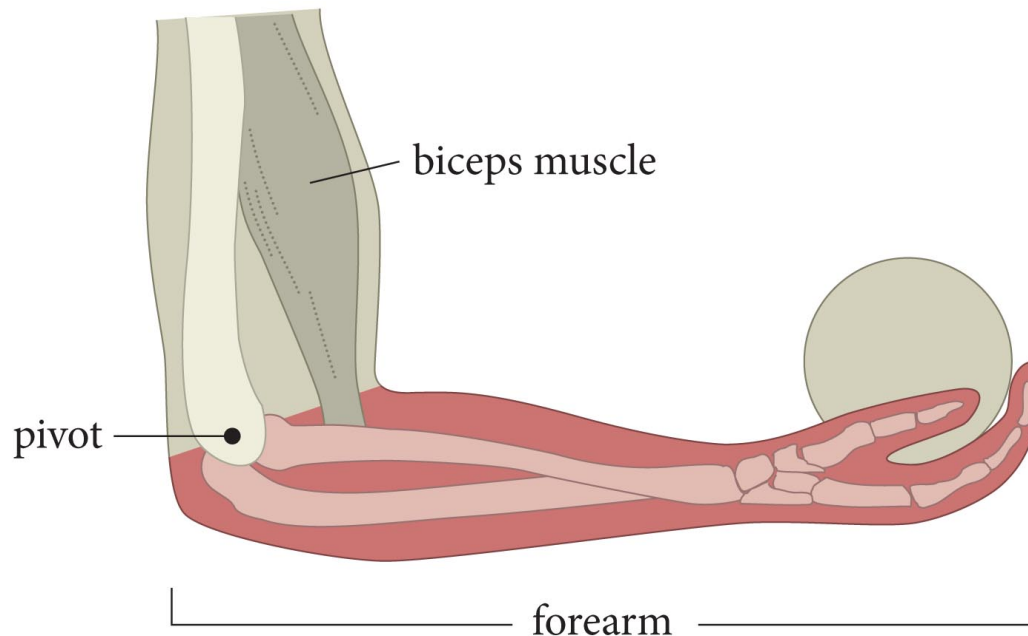

Checkpoint 12.5

- Bicep attached farther out? Lever arm distance increases, so torque increases
- As the arm is raised, F_{mf} becomes more perpendicular to the forearm, so torque increases. This increases lifting ability.

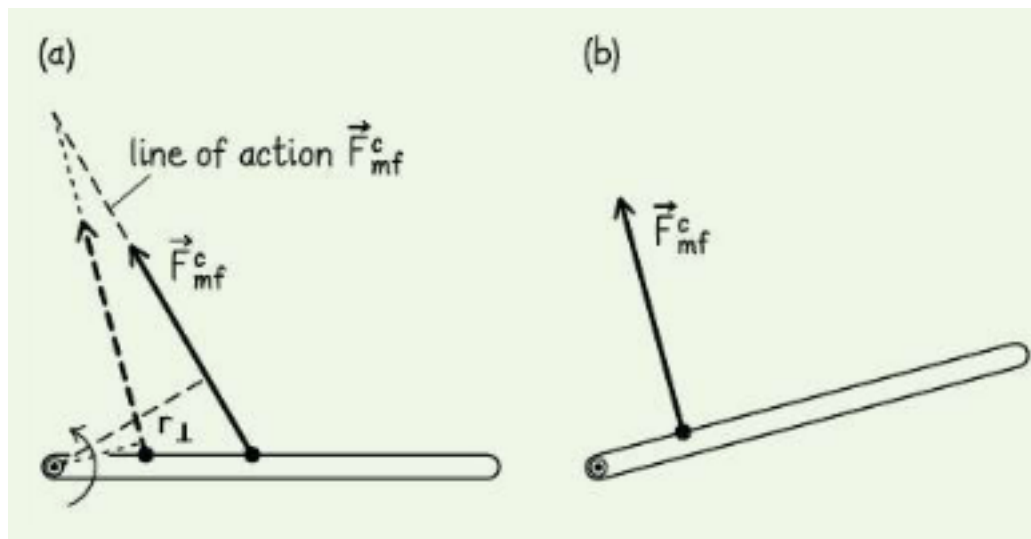

Section 12.3

Question 3

A 1-kg rock is suspended by a massless string from one end of a 1-m measuring stick. What is the mass of the measuring stick if it is balanced by a support force at the 0.25-m mark? Assume the stick has uniform density.

1. 0.25 kg
2. 0.5 kg
3. 1 kg
4. 2 kg
5. 4 kg
6. Impossible to determine

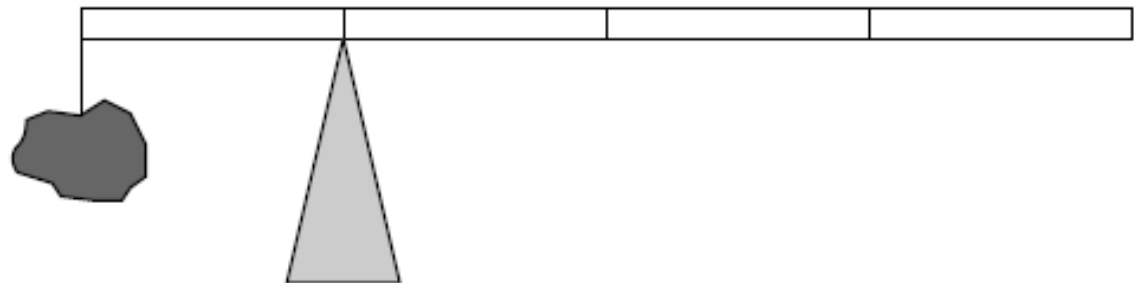

Section 12.3

Question 3

A 1-kg rock is suspended by a massless string from one end of a 1-m measuring stick. What is the mass of the measuring stick if it is balanced by a support force at the 0.25-m mark? Assume the stick has uniform density.



✓ 1 kg – two bits on the end (half the mass) have to balance the rock at a distance of 0.50 m.

$$(1\text{kg})(0.25\text{m}) = (x/2)(0.5\text{m})$$

Section 12.4: The vector nature of rotation

Section Goals

You will learn to

- Extend the concept of the direction of rotation from rotations in a plane to three-dimensions.
- Visualize how the vector nature of rotation is determined when the direction of rotation and the direction of the axis of rotation in space are specified.
- Demonstrate how the rotational kinematic quantities, $\Delta\theta$, ω , and α can be described using rotation vectors.

Section 12.4: The vector nature of rotation

- The case of rotations that lie in a plane is shown below.

(b) Rotational motion in a plane

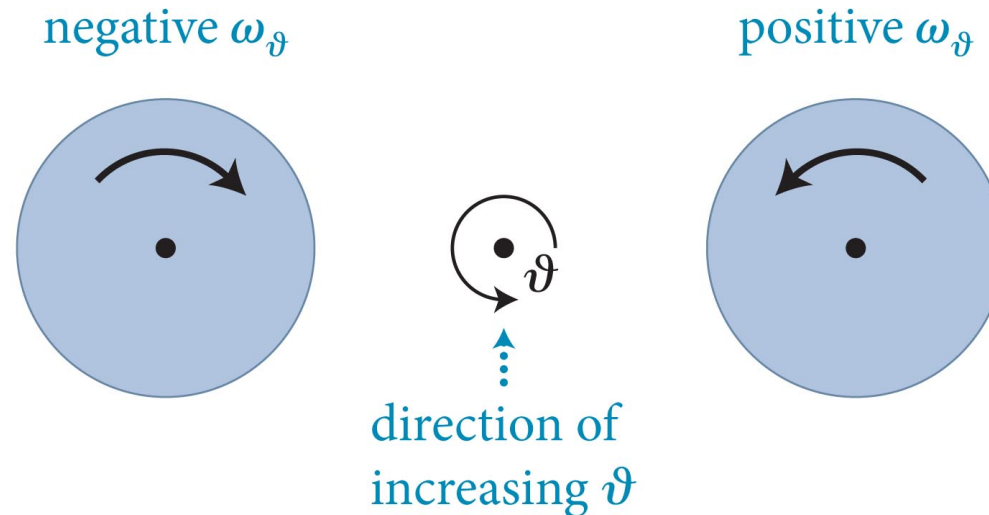

- Notice that only an algebraic sign is needed to specify the direction of rotation about the axis of rotation
- The sign conventions “counterclockwise quantities are positive” and “clockwise quantities are negative” are used.

Section 12.4: The vector nature of rotation

- The vector description can be determined by using the right-hand rule:
(b) The right-hand rule connects direction of rotation about an axis with a direction along the rotation axis

Right-hand rule: Curl fingers of right hand in direction of rotation; thumb will point in direction of vector representing rotation.

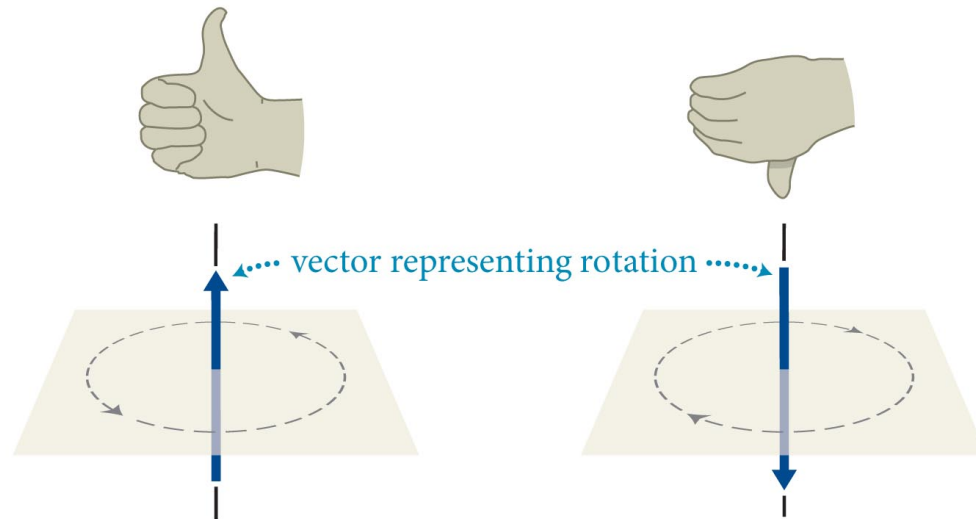

- Notice that if the fingers of the right hand are curled around the rotation, the thumb points in the direction of the vector representing the rotation.

Section 12.4: The vector nature of rotation

- The right-hand rule can be used to determine the vector for the rotations of two spinning disks with their edges touching.

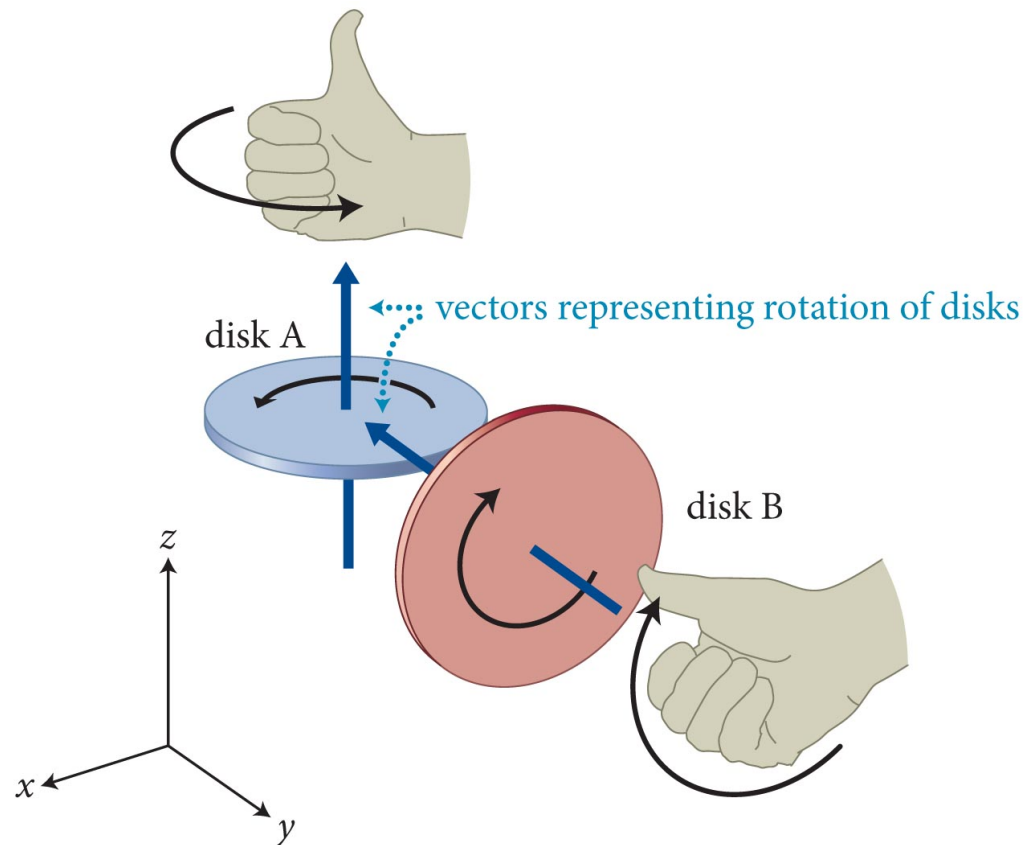

Section 12.4: The vector nature of rotation

- The right-hand rule can be used to determine the vector directions for the rotations of two spinning disks with their edges in contact.

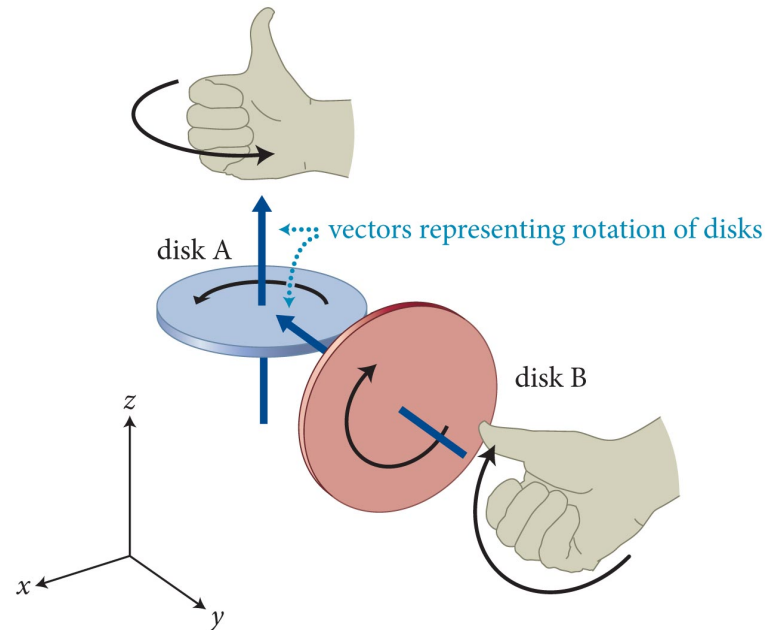

- The rotation vector for disk A points in the z -direction and has vector components $(0, 0, A)$, where A is a positive number.
- The rotation vector for disk B points in the negative y -direction and has components $(0, -B, 0)$ where B is a positive number.

Section 12.4: The vector nature of rotation

- The right-hand rule can be used in “reverse” to determine the corresponding rotation for a rotational vector.

Given rotating object . . .

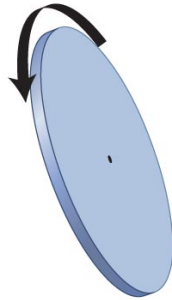

. . . curl right-hand fingers in direction of rotation . . .



. . . thumb specifies unique direction in space.

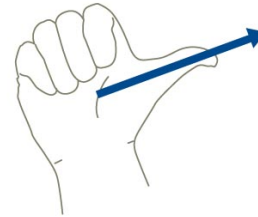

Given direction in space . . .



. . . point right-hand thumb in that direction . . .

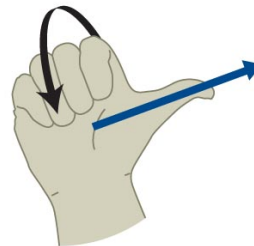

. . . curled fingers specify unique rotation.



Section 12.4: The vector nature of rotation

- Displacement vectors for motion commute. That means that the sum of several displacements is independent of the order added.
- **Rotational displacements do not commute, however.**

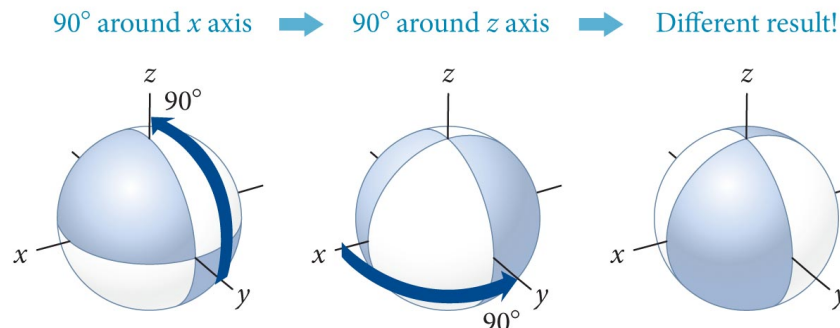
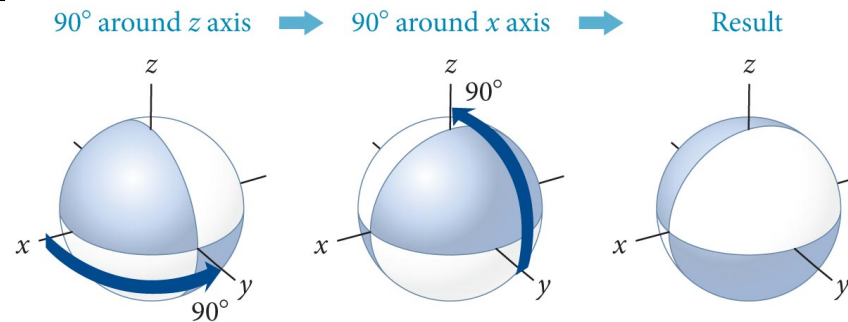

- See how the orientation of the ball is different depending on the order of rotation!

Section 12.4: The vector nature of rotation

- Rotational displacements for small displacements do commute, however.

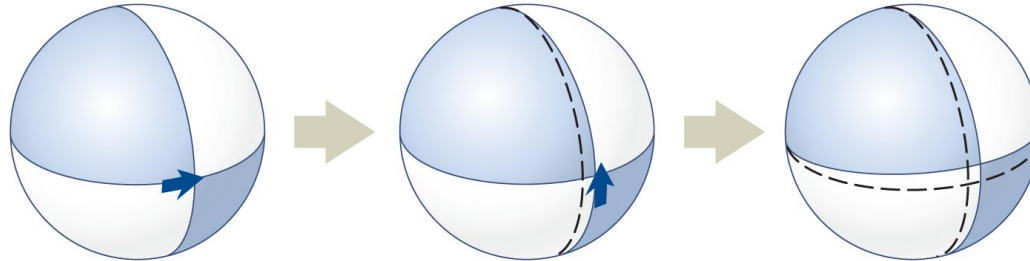

For successive rotations over very small angles, order doesn't matter.

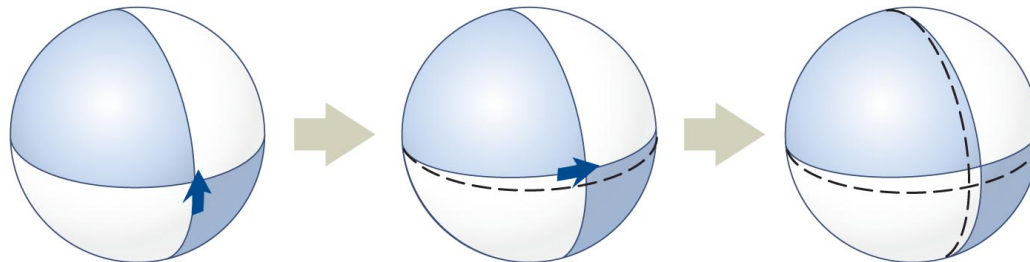

- See how the orientation of the ball is same for the two different orders of rotation.
- Implies the instantaneous rotational velocity, $\omega = d\theta/dt$, does commute and can be associated with a vector by the right-hand rule.

Section 12.4: The vector nature of rotation

- The vector nature of rotational velocity is given by an **axial vector** defining the direction of rotation from the right-hand rule and a magnitude defining the speed of rotation. **Axial vectors have ‘handedness.’**

Rotational velocity vector:

- Direction* indicates rotation direction (via right-hand rule).
- Length* indicates speed of rotation.

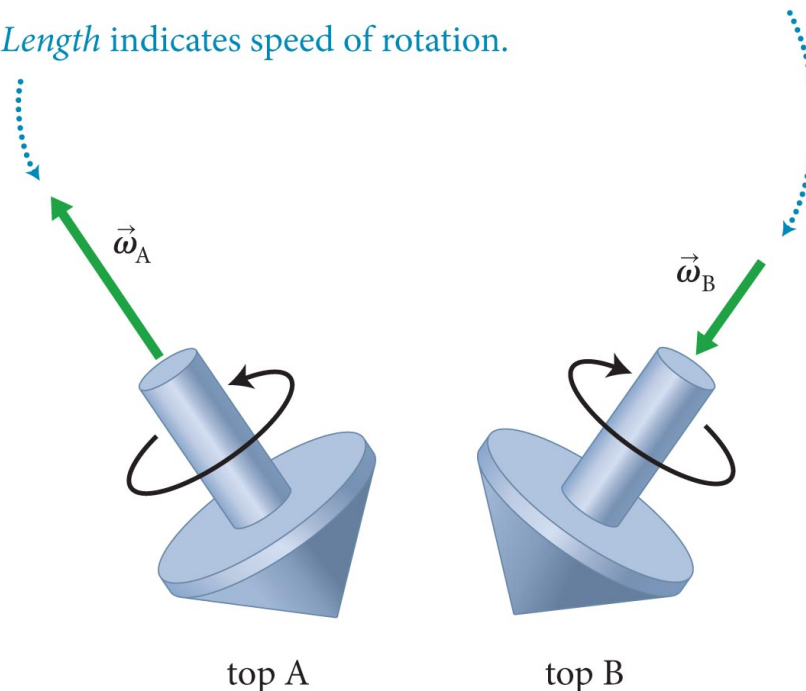

Checkpoint 12.7

 **12.7** Suppose the rotation of top A in Figure 12.23 slows down without a change in the direction of its axis of rotation. (a) In which direction does the vector $\Delta\vec{\omega}$ point? (b) Can the top's rotational acceleration be represented by a vector? If so, in which direction does this vector point?

Rotational velocity vector:

- *Direction* indicates rotation direction (via right-hand rule).
- *Length* indicates speed of rotation.

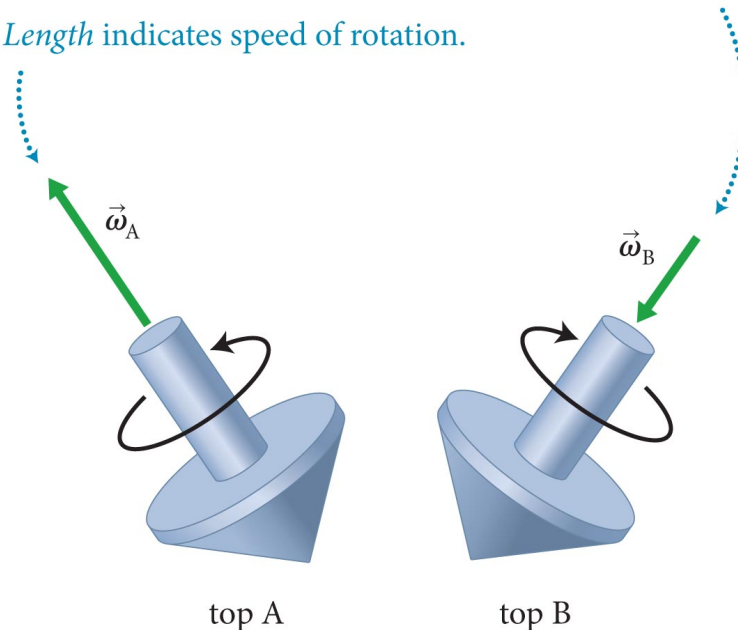

Checkpoint 12.7

- Since the rotation slows down, final angular velocity is smaller. Since $\Delta\vec{\omega}$ points from initial to final, it is opposite the direction of the angular velocity.
- Yes, the rotational acceleration is the change in rotational velocity per unit time, so it points in the direction of $\Delta\vec{\omega}$



Section 12.4

Question 4

Consider the uniformly rotating object shown below. If the object's angular velocity is a vector (in other words, it points in a certain direction in space) is there a particular direction we should associate with the angular velocity?

1. Yes, $\pm x$
2. Yes, $\pm y$
3. Yes, $\pm z$
4. Yes, some other direction
5. No, the choice is really arbitrary.

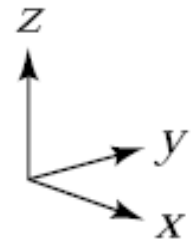
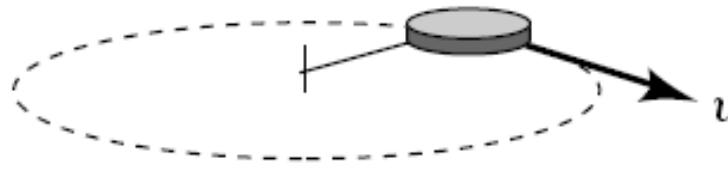

Section 12.4

Question 4

Consider the uniformly rotating object shown below. If the object's angular velocity is a vector (in other words, it points in a certain direction in space) is there a particular direction we should associate with the angular velocity?

1. Yes, $\pm x$

2. Yes, $\pm y$

✓ 3. Yes, $\pm z$

4. Yes, some other direction

5. No, the choice is really arbitrary.

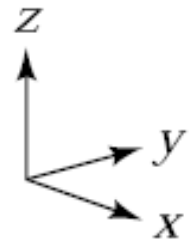
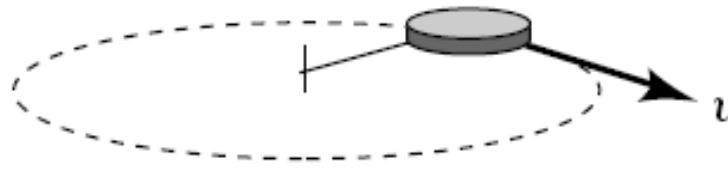

Section 12.4

Question 5

Consider the situation shown at left below. A puck of mass m , moving at speed v hits an identical puck which is fastened to a pole using a string of length r . After the collision, the puck attached to the string revolves around the pole. Suppose we now lengthen the string by a factor 2, as shown on the right, and repeat the experiment. Compared to the angular speed in the first situation, the new angular speed is

1. Twice as high.
2. The same.
3. Half as much.
4. None of the above

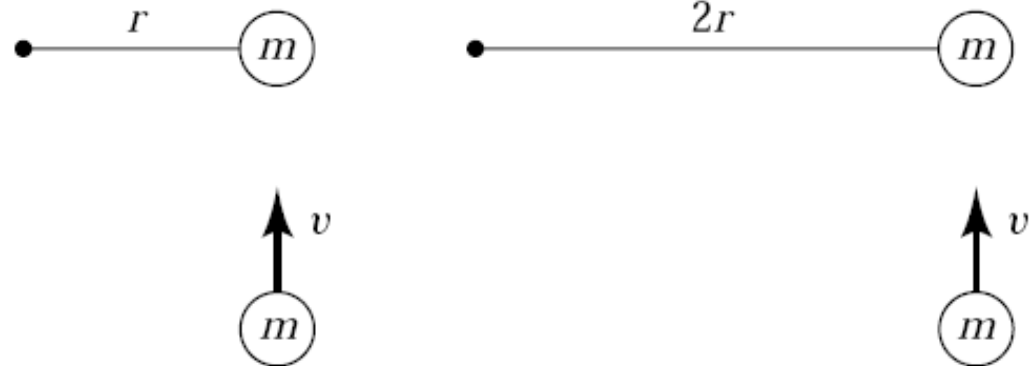

Section 12.4

Question 5

Consider the situation shown at left below. A puck of mass m , moving at speed v hits an identical puck which is fastened to a pole using a string of length r . After the collision, the puck attached to the string revolves around the pole. Suppose we now lengthen the string by a factor 2, as shown on the right, and repeat the experiment. Compared to the angular speed in the first situation, the new angular speed is

✓ Half as much – conservation of L , $mvr = I\omega$

I is increased by doubling the radius, so ω goes down

(or: same torque due to collision, but greater rotational inertia)

Chapter 12: Self-Quiz #1

A rope supports one end of a beam as shown in Figure 12.24. Draw the lever arm distance for the torque caused by the rope about the pivot.

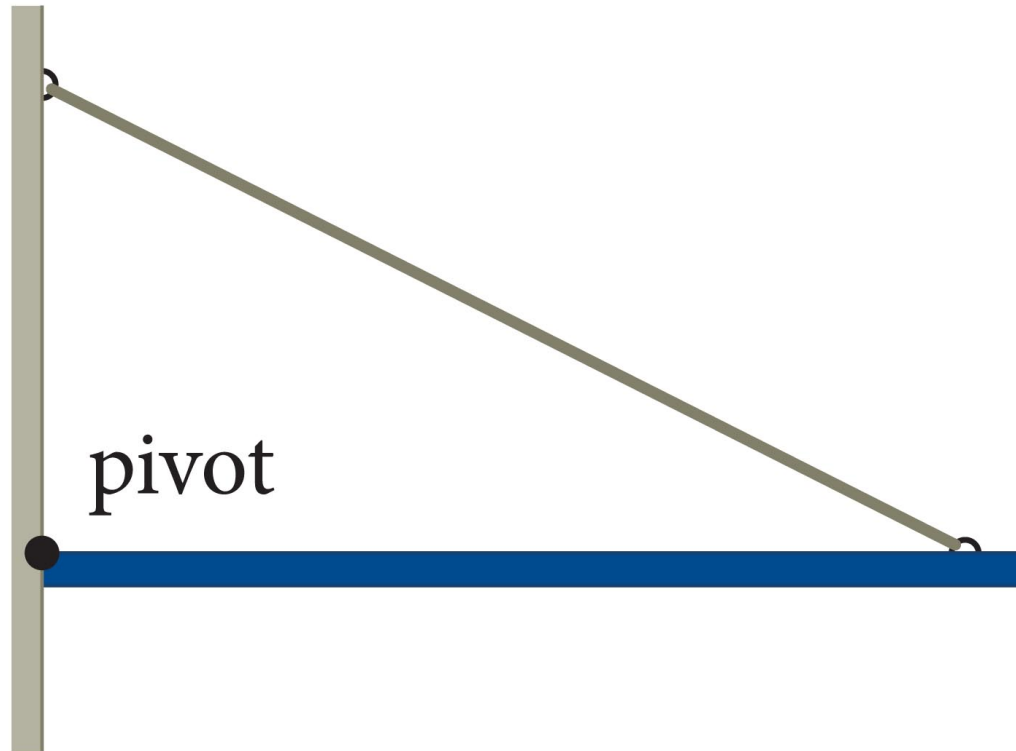

Chapter 12: Self-Quiz #1

Answer

The lever arm distance r_{\perp} is the perpendicular distance between the pivot and the line of action of the force exerted by the rope on the beam, as shown in Figure 12.27.

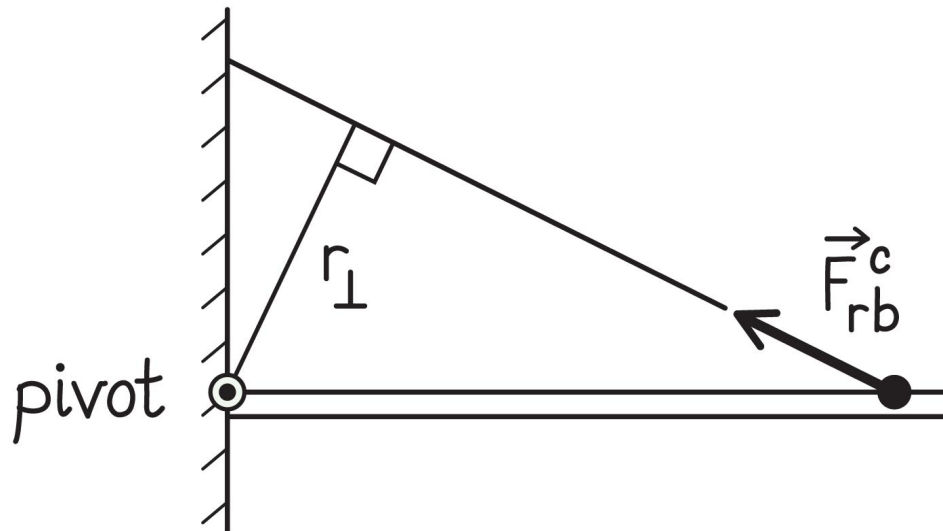

Chapter 12: Self-Quiz #2

Draw a free-body diagram and an extended free-body diagram for (a) a door hanging on two hinges and (b) a bridge supported from each end, with a car positioned at one-quarter of the bridge's length from one support.

Chapter 12: Self-Quiz #2

Answer

See Figure 12.28. (a) The door interacts with three objects: Earth, the top hinge, and the bottom hinge. Without the top hinge, the force of gravity would tend to rotate the door about an axis perpendicular to the door through the bottom hinge.

The force exerted by the top hinge must balance the clockwise torque caused by the force of gravity about the axis through the bottom hinge. The horizontal components of the forces exerted by the hinges must cancel each other.

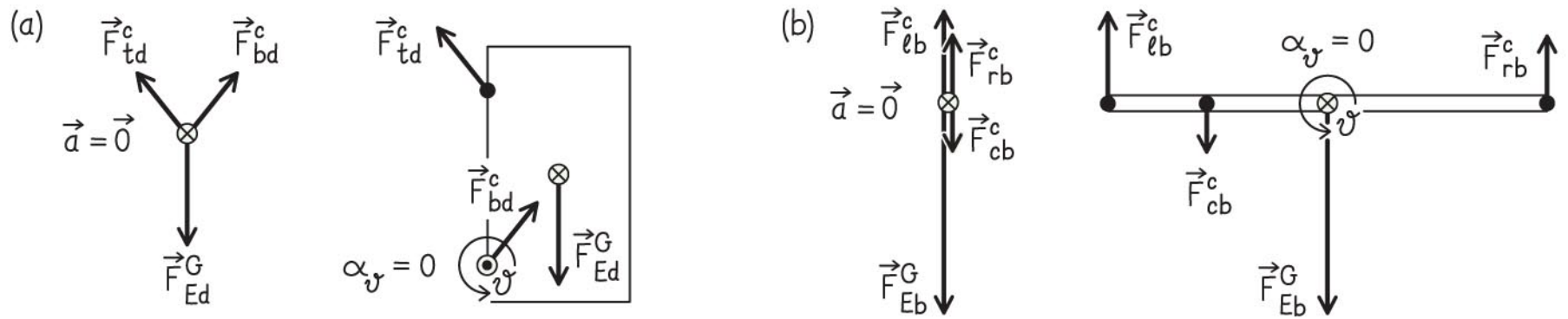

Chapter 12: Self-Quiz #2

Answer (cont.)

See Figure 12.28. (b) The bridge interacts with four objects: Earth, the right support, the left support, and the car. The upward forces from the supports must balance the downward gravitational forces of the car and the bridge.

Because these forces must also counteract the counterclockwise torque caused by the car, the force exerted by the support closer to the car must be greater than the force exerted by the other support.

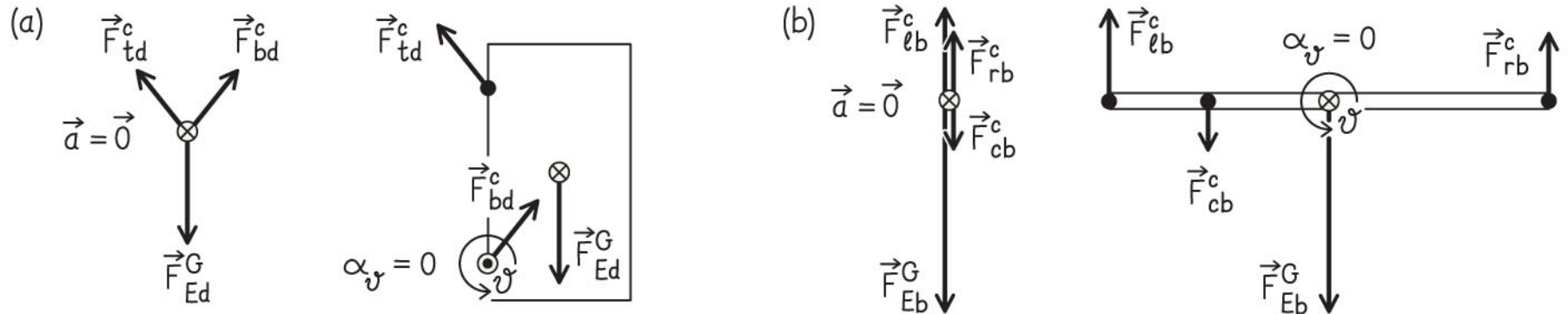

Chapter 12: Self-Quiz #3

Which diagram in Figure 12.25—1, 2, or 3—shows the alarm clock on the left after it has been rotated in the directions indicated by (a) 90° about the x axis and then 90° about the y axis and (b) 90° about the y axis and then 90° about the x axis? Does the order of the rotation change your answer?

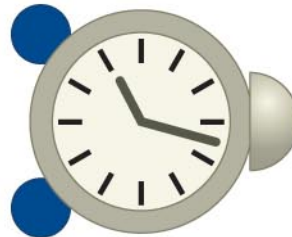
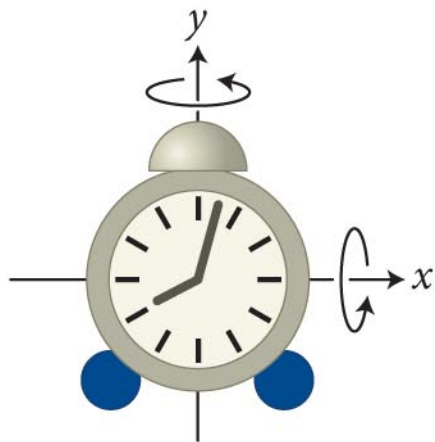

1



2



3

Chapter 12: Self-Quiz #3

Answer

(a) 3; (b) 2. The order of rotation does make a difference.

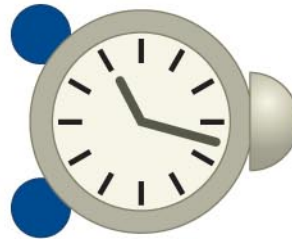
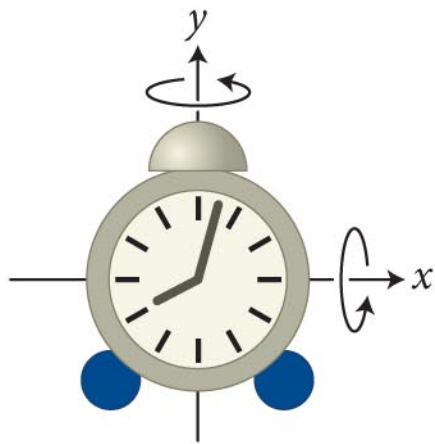

1



2



3

Chapter 12: Self-Quiz #4

Give the direction of the rotational velocity vector associated with each spinning object shown in the figure below.

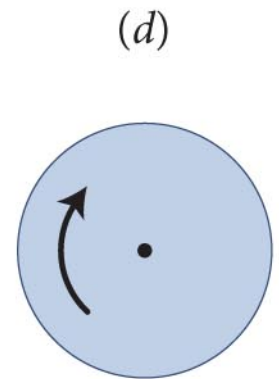
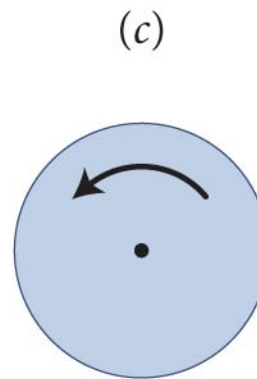
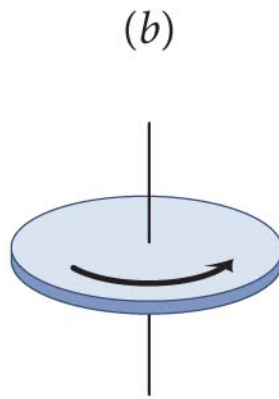
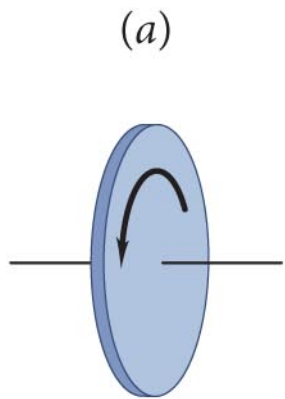

Chapter 12: Self-Quiz #4

Answer

Wrapping the fingers of your right hand in the direction of spin gives rotational velocity vectors that point (a) to the right, (b) up, (c) out of the page, and (d) into the page.

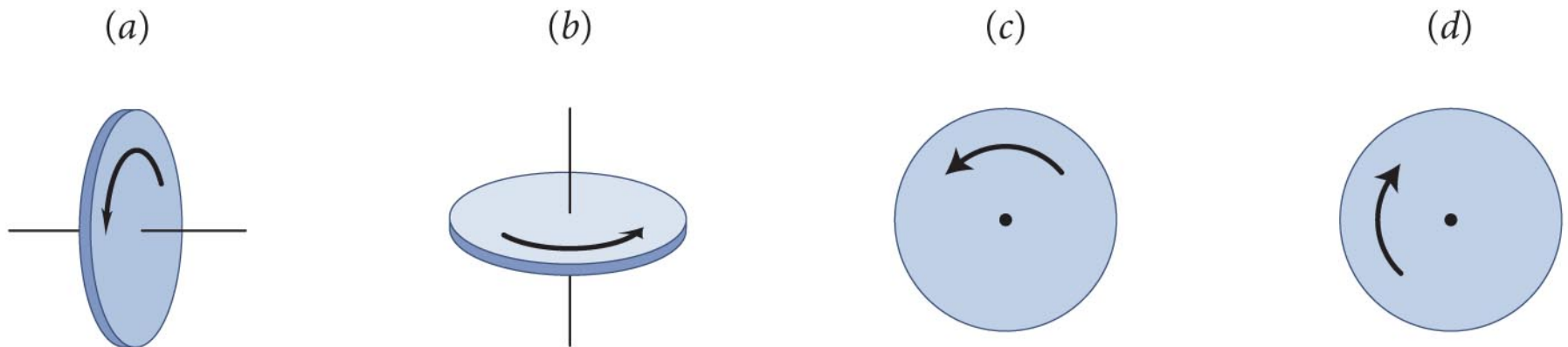

Chapter 12 Torque

Quantitative Tools

Section 12.5: Conservation of angular momentum

Section Goals

You will learn to

- Apply Newton's Second Law for rotation to the rotational motion of extended objects.
- Establish the conditions under which rotational angular momentum is conserved.

Section 12.5: Conservation of angular momentum

- Consider the situation shown in the figure below: A force \vec{F} is exerted on a particle constrained to move in a circle.

- The magnitude of the torque caused by \vec{F} is:

$$\tau \equiv rF \sin \theta = r_{\perp} F = rF_{\perp}$$

- SI units of torque are $\text{N} \cdot \text{m}$.

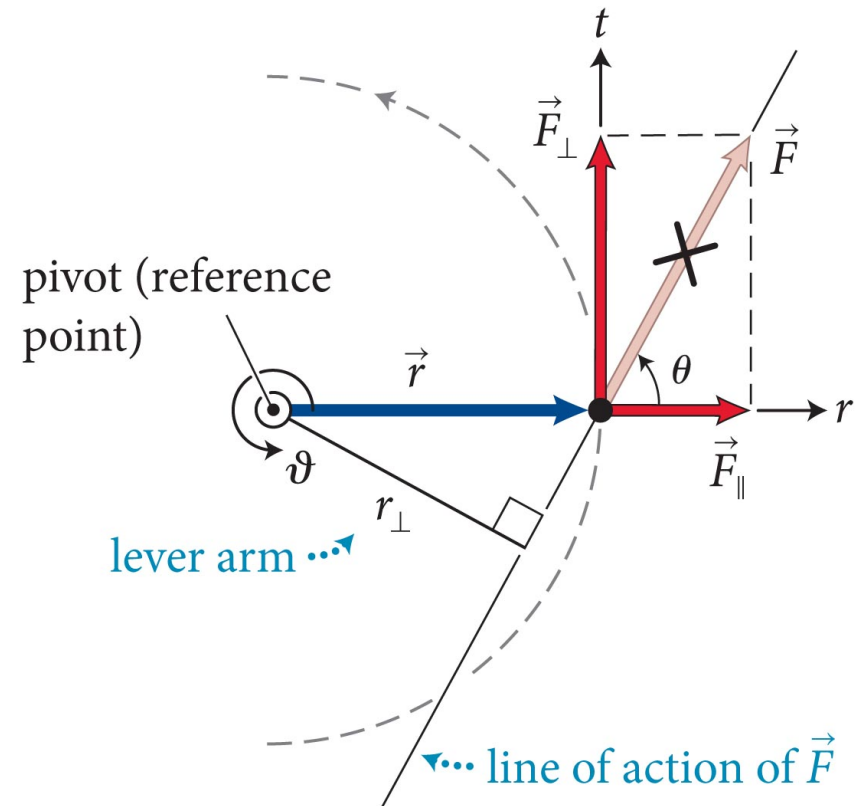

Section 12.5: Conservation of angular momentum

- The tangential component of force $F_{\perp} = |F_t|$ causes the particle to have a tangential acceleration (a_t) given by

$$F_t = ma_t$$

- Combining equations 12.1 and 12.2 and using the relation $a_t = r\alpha_t$ we obtain

$$\tau_{\theta} = rm(r\alpha_{\theta}) = mr^2\alpha_{\theta} = I\alpha_{\theta}$$

where $I = mr^2$ is the rotational inertia of the particle

Section 12.5: Conservation of angular momentum

- Now let us consider the case of an extended object.
- Imagine breaking down the object into small particles of inertia δm_n , as shown in the figure.
- Let each particle be subject to a torque $\tau_{n\theta}$
- Using Eq. 12.4 we can write,

$$\tau_{n\theta} = \delta m_n r_n^2 \alpha_{n\theta}$$

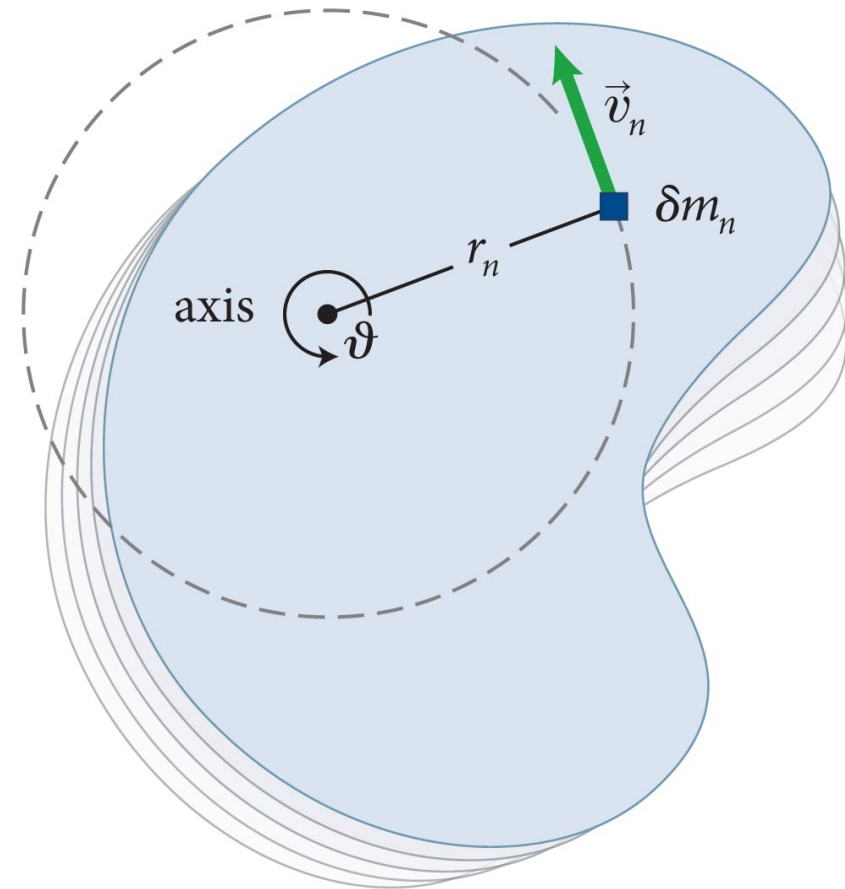

Section 12.5: Conservation of angular momentum

- Then, the sum of the torques on all particles can be written as

$$\sum_n \tau_{n\vartheta} = \sum_n (\delta m_n r_n^2 \alpha_{n\vartheta}) = \left(\sum_n \delta m_n r_n^2 \right) \alpha_{\vartheta}$$

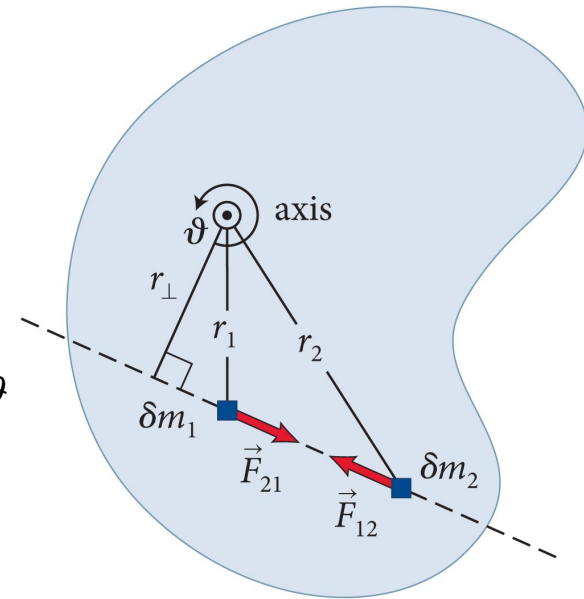

- The sum on the left side of Eq. 12.7 contains torques due to external and internal forces.
- But, the torques due to internal forces cancel out, giving us

$$\sum \tau_{\text{ext}\vartheta} = I \alpha_{\vartheta}$$

Section 12.5: Conservation of angular momentum

- Now let's look at the angular momentum of the extended object.
- Recalling from Chapter 11 that angular momentum is given by $L_\theta = I\omega_\theta$ and the relation $\sum \tau_{\text{ext}\vartheta} = I\alpha_\vartheta$, we get

$$dL_\theta/dt = I(d\omega_\theta/dt) = I\alpha = \tau$$

Section 12.5: Conservation of angular momentum

- If the sum of the torques caused by the external forces on an extended object is zero (isolated system), then

$$\Sigma \tau_{\text{ext}\vartheta} = \frac{dL_{\vartheta}}{dt} = 0 \Rightarrow \Delta L_{\vartheta} = 0$$

and the object is in **rotational equilibrium**.

- An object in both translational and rotational equilibrium is said to be in **mechanical equilibrium**, and satisfies the conditions

$$\Sigma \tau_{\text{ext}\vartheta} = 0 \quad \text{and} \quad \Sigma \vec{F}_{\text{ext}} = \vec{0} \Leftrightarrow \text{mechanical equilibrium}$$

Section 12.5: Conservation of angular momentum

- For a system that is not in rotational equilibrium, we have the **angular momentum law**:

$$\Delta L_{\vartheta} = J_{\vartheta}$$

where J_{θ} represents the transfer of angular momentum from the environment.

- J_{θ} is called the **rotational impulse** given by

$$J_{\vartheta} = (\Sigma \tau_{\text{ext}\vartheta}) \Delta t \text{ (constant torques)}$$

Section 12.5: Conservation of angular momentum

- The figure below illustrates how conservation of angular momentum gives rise to the angular momentum law and how to treat isolated and nonisolated systems.

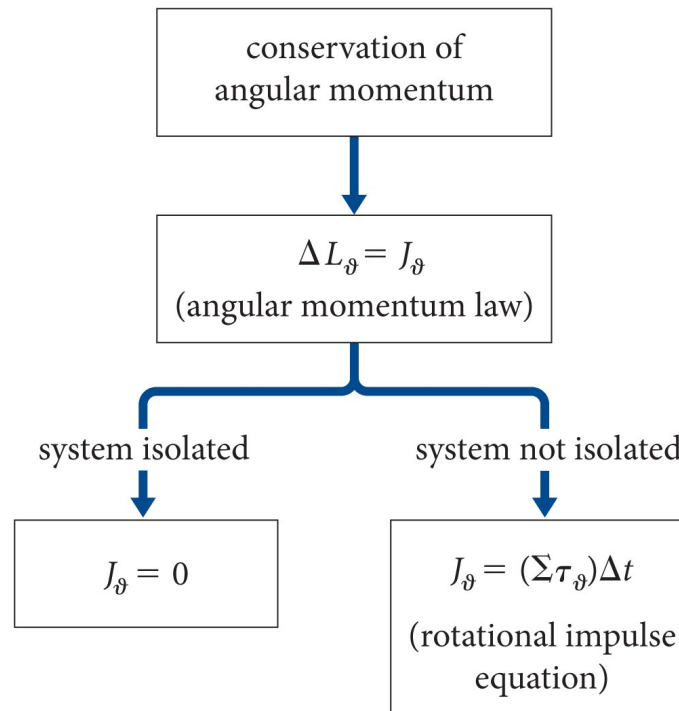

Section 12.5

Question 6

A figure skater stands on one spot on the ice (assumed frictionless) and spins around with her arms extended. When she pulls in her arms, she reduces her rotational inertia and her angular speed increases so that her angular momentum is conserved. Compared to her initial rotational kinetic energy, her rotational kinetic energy after she has pulled in her arms must be

1. The same.
2. Larger because she's rotating faster.
3. Smaller because her rotational inertia is smaller.

Section 12.5

Question 6

A figure skater stands on one spot on the ice (assumed frictionless) and spins around with her arms extended. When she pulls in her arms, she reduces her rotational inertia and her angular speed increases so that her angular momentum is conserved. Compared to her initial rotational kinetic energy, her rotational kinetic energy after she has pulled in her arms must be

1. The same.
- ✓ 2. Larger because she's rotating faster.
3. Smaller because her rotational inertia is smaller.

Section 12.5: Conservation of angular momentum

Example 12.5 Flywheel

A motor exerts a constant force of 120 N tangential to the rim of a 20-kg cylindrical flywheel of radius 0.50 m. The flywheel is free to rotate about an axis through its center and runs perpendicular to its face. If the flywheel is initially at rest and the motor is turned on for 2.0 s, how much work does the motor do on the flywheel?

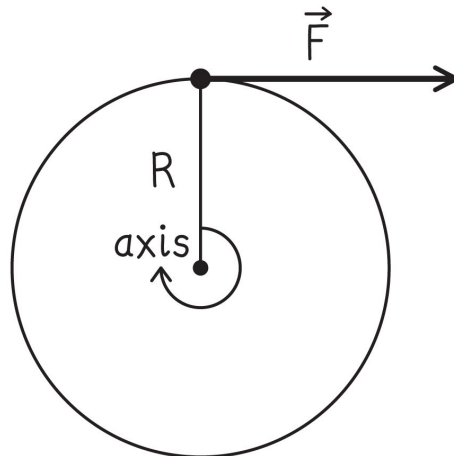

$$\begin{aligned}F &= 120 \text{ N} \\R &= 0.50 \text{ m} \\m &= 20 \text{ kg} \\\Delta t &= 2.0 \text{ s}\end{aligned}$$

Section 12.5: Conservation of angular momentum

Example 12.5 Flywheel (cont.)

① GETTING STARTED I begin by making a sketch of the situation to organize the information (Figure 12.33). The force exerted by the motor causes the flywheel to start spinning, which means the wheel's rotational kinetic energy changes. This is the only energy change in the system, and I know from the energy law (Eq. 9.1) that $\Delta E = W$.

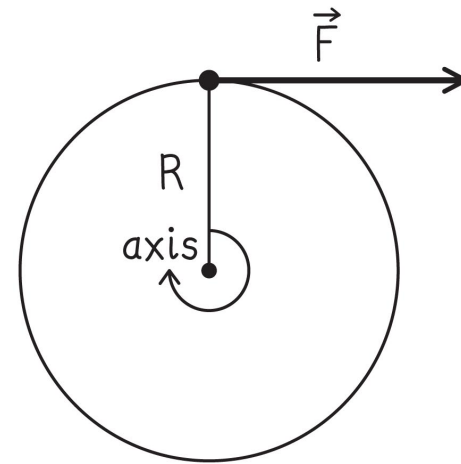

$$\begin{aligned} F &= 120 \text{ N} \\ R &= 0.50 \text{ m} \\ m &= 20 \text{ kg} \\ \Delta t &= 2.0 \text{ s} \end{aligned}$$

Section 12.5: Conservation of angular momentum

Example 12.5 Flywheel (cont.)

1 GETTING STARTED Therefore $\Delta K_{\text{rot}} = W$, and so to calculate the work done by the motor, I need to determine this change in rotational kinetic energy. Because the flywheel is at rest initially, I know that $\Delta K_{\text{rot}} = K_{\text{rot},f}$.

Section 12.5: Conservation of angular momentum

Example 12.5 Flywheel (cont.)

② **DEVISE PLAN** To obtain $K_{\text{rot},f}$, I can use Eq. 11.31, $K_{\text{rot}} = \frac{1}{2} I\omega^2$. The rotational inertia I of the flywheel (which is a solid cylinder) is $\frac{1}{2} mR^2$ (see Table 11.3). Because I'm interested in $K_{\text{rot},f}$, I need the final value for ω , the wheel's rotational speed. How can I connect ω_f to anything I know in this problem?

Section 12.5: Conservation of angular momentum

Example 12.5 Flywheel (cont.)

② DEVISE PLAN The relationship between ω and angular momentum is $L_\vartheta \equiv I\omega_\vartheta$ (Eq. 11.34), and I know from Eq. 12.16 that $\Delta L_\theta = \tau_\theta \Delta t$. I know Δt , but do I know anything about τ in terms of the information given—a force, an inertia, and a wheel radius? Yes, Eq. 12.1: $\tau = rF_\perp$. Thus my plan is to express ω_f in terms of R and F and then use that expression for ω_f in $K_{\text{rot}} = \frac{1}{2}I\omega^2$ to calculate $K_{\text{rot},f} = W$.

Section 12.5: Conservation of angular momentum

Example 12.5 Flywheel (cont.)

③ EXECUTE PLAN The magnitude of the torque caused by the motor is $\tau = RF$, where R is the radius of the wheel and F is the magnitude of the force exerted by the motor. Equation 12.16 then gives

$$\Delta L_{\vartheta} = \left(\sum \tau_{\text{ext}\vartheta} \right) \Delta t = +RF \Delta t$$

Because the initial angular momentum is zero, I know that $\Delta L = I\omega_f = +I\omega_f$ and so I have

$$\Delta L = RF\Delta t = I\omega_f$$

$$\omega_f = \frac{RF\Delta t}{I}$$

Section 12.5: Conservation of angular momentum

Example 12.5 Flywheel (cont.)

③ EXECUTE PLAN The final rotational kinetic energy is thus

$$\begin{aligned} K_{\text{rot,f}} &= \frac{1}{2} I \omega_f^2 = \frac{1}{2} I \left(\frac{RF \Delta t}{I} \right)^2 \\ &= \frac{(RF \Delta t)^2}{2I} = \frac{(RF \Delta t)^2}{mR^2} = \frac{(F \Delta t)^2}{m} \end{aligned}$$

and the work done on the flywheel is

$$W = K_{\text{rot,f}} = \frac{[(120 \text{ N}) (2.0 \text{ s})]^2}{20 \text{ kg}} = 2880 \text{ J} = 2.9 \text{ kJ} \checkmark$$

Section 12.5: Conservation of angular momentum

Example 12.5 Flywheel (cont.)

④ EVALUATE RESULT Delivering 2.9 kJ in 2.0 s corresponds to a power of $(2.9 \text{ kJ})/(2.0 \text{ s}) = 1.4 \text{ kW}$, which is not an unreasonable amount for a large motor.

Section 12.5: Conservation of angular momentum

Example 12.6 Spinning up a compact disc

When you load a compact disc into a drive, a spinning conical shaft rises up into the opening in the center of the disc, and the disc begins to spin (Figure 12.34). Suppose the disc's rotational inertia is I_d , that of the shaft is I_s , and the shaft's initial rotational speed is ω_i . Does the rotational kinetic energy of the disc-shaft system remain constant in this process? Assume for simplicity that no external forces cause torques on the shaft.

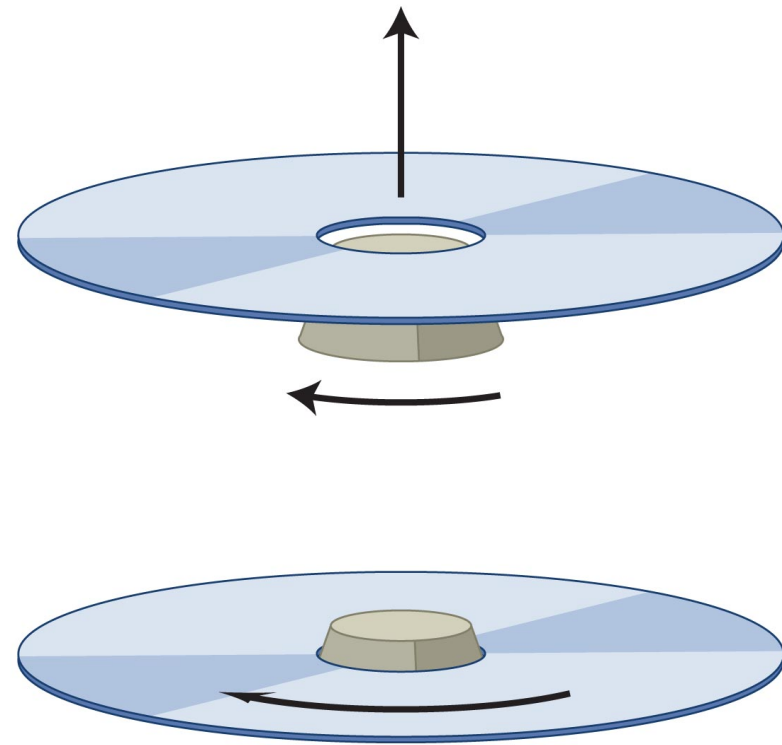

Section 12.5: Conservation of angular momentum

Example 12.6 Spinning up a compact disc (cont.)

① GETTING STARTED I am given rotational inertias for a disc and a shaft, plus the initial rotational speed of the shaft, and my task is to determine whether or not the system's rotational kinetic energy changes when these two units interact: $\Delta K_{\text{rot}} \stackrel{?}{=} 0$. The disc is initially at rest, but as the shaft comes in contact with it, the two exert on each other forces that cause torques.

Section 12.5: Conservation of angular momentum

Example 12.6 Spinning up a compact disc (cont.)

1 GETTING STARTED The shaft speeds up the rotation of the disc, and the disc slows down the rotation of the shaft. The disc has no rotational velocity before the shaft touches it, and so initially all the system's rotational kinetic energy is in the shaft. After they reach a common rotational speed ω_f , both have rotational kinetic energy. I need to calculate the initial and final rotational kinetic energies of the shaft-disc system to answer the question.

Section 12.5: Conservation of angular momentum

Example 12.6 Spinning up a compact disc (cont.)

② **DEVISE PLAN** The rotational kinetic energy of a rotating object is given by Eq. 11.31, $K = \frac{1}{2} I \omega^2$. I know the initial rotational speed of the shaft and its rotational inertia, so I can use this equation to calculate the initial rotational kinetic energy of the shaft-disc system. I do not know the final rotational speed of the system, but I do know that because there are no external torques on the system, Eq. 12.13 tells me that the angular momentum must remain constant: $\Delta L_\theta = 0$.

Section 12.5: Conservation of angular momentum

Example 12.6 Spinning up a compact disc (cont.)

② DEVISE PLAN Expressing ΔL_θ as the difference between the final and initial values gives me an expression containing ω_f and ω_i , which means I can probably get an expression for ω_f/ω_i that I can then use to compare the ratio $K_{\text{rot},f}/K_{\text{rot},i}$ and thereby determine whether or not $\Delta K_{\text{rot}} = 0$. Because the problem is stated in symbols rather than numerical values, my comparison will be between two algebraic expressions.

Section 12.5: Conservation of angular momentum

Example 12.6 Spinning up a compact disc (cont.)

3 EXECUTE PLAN Because the torques that the disc and shaft cause on each other are internal and because there are no external torques, I have for the system's angular momentum

$$\Delta L_{\theta} = (I_s + I_d)\omega_{\theta,f} - I_s\omega_{\theta,i} = 0 \quad (1)$$

If I let the initial direction of rotation of the shaft be positive, $\omega_{\theta,i} = +\omega_i$ and so $\omega_{\theta,f}$ is also positive. Rearranging terms in Eq. 1, I find that the ratio of the final and initial rotational speeds is

$$\frac{\omega_f}{\omega_i} = \frac{I_s}{I_s + I_d}$$

Section 12.5: Conservation of angular momentum

Example 12.6 Spinning up a compact disc (cont.)

3 EXECUTE PLAN The system's initial rotational kinetic energy is $K_i = \frac{1}{2} I_s \omega_i^2$, its final rotational kinetic energy is $K_f = \frac{1}{2} (I_s + I_d) \omega_f^2$, and the ratio of the two is

$$\frac{K_f}{K_i} = \frac{\frac{1}{2} (I_s + I_d) \omega_f^2}{\frac{1}{2} I_s \omega_i^2} = \frac{I_s}{I_s + I_d} < 1$$

so $K_f < K_i$, or $\Delta K \neq 0$. The rotational kinetic energy of the system is not constant. ✓

Section 12.5: Conservation of angular momentum

Example 12.6 Spinning up a compact disc (cont.)

④ EVALUATE RESULT The spinning up of the disc is like an inelastic “rotational collision”: The disc initially at rest comes in contact with the spinning shaft, and the two reach a common rotational speed. While the disc is spinning up, some of the system’s initial rotational kinetic energy is converted to thermal energy because of friction between disc and shaft, and so it makes sense that the system’s rotational kinetic energy decreases.

Checkpoint 12.9

 **12.9** Consider the situation in Example 12.6. (a) Is the vector sum of the forces exerted by the shaft on the compact disc nonzero while the disc is spinning up? (b) Is the disc isolated?

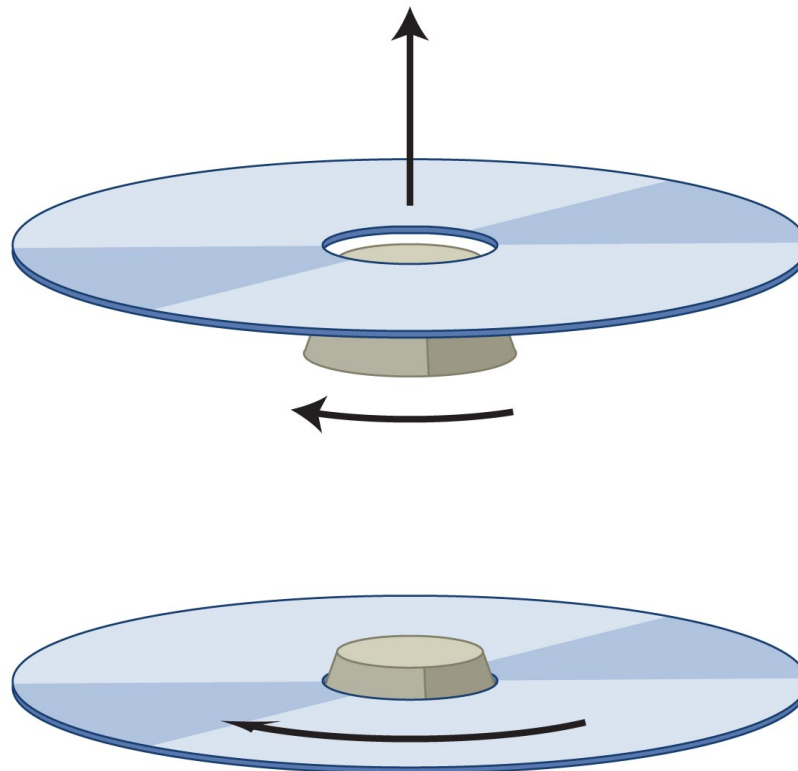

Checkpoint 12.9

- No – a nonzero sum of forces would cause the center of the disc to accelerate. We know it stays put.
- No – the system is not isolated. Even though the vector sum of forces is zero, the individual forces give a nonzero torque. This causes rotational acceleration and an increase of its rotational kinetic energy.

Section 12.6: Rolling motion

Section Goals

You will learn to

- Use the concepts of simultaneous translational motion and rotational motion of an extended object to predict the kinematics and dynamics for rolling motion.
- Interpret that rolling motion is an intermediate situation between the cases of fixed and free rotations.
- Explain how in rolling motion an object revolves about its geometric center.

Section 12.6: Rolling motion

- This figure shows the rolling motion of an object that moves without slipping.

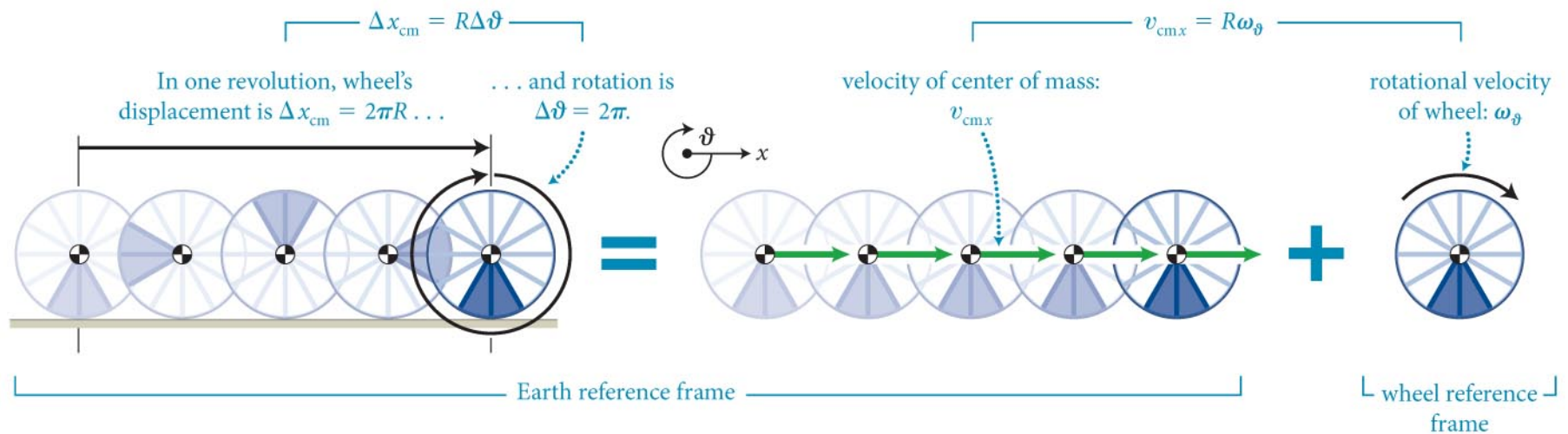

- The relationship between the displacement of the center of mass, Δx_{cm} , and the rotational displacement $\Delta\vartheta$ is given by

$$\Delta x_{\text{cm}} = R\Delta\vartheta$$

Section 12.6: Rolling motion

- The corresponding relationship between the velocity of the center-of-mass, $v_{\text{cm } x}$, and the rotational velocity, ω_{ϑ} , is given by

$$v_{\text{cm } x} = R\omega_{\vartheta} \text{ (rolling motion without slipping)}$$

- This condition describes the kinematic constraint for an object rolling without slipping.

Section 12.6: Rolling motion

- A point of the rim of a wheel that is in contact with the surface when rolling without slipping has zero instantaneous velocity. *Static* friction!
- See how a point on the rim of the wheel moves in a direction perpendicular to the surface before and after reaching the bottom.

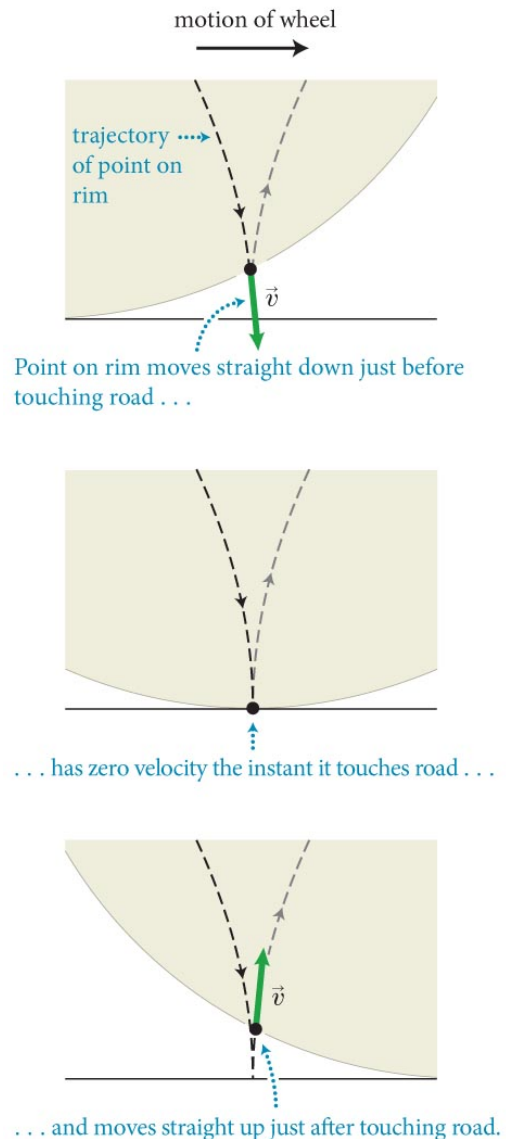

Section 12.6: Rolling motion

- Now let's consider the dynamics of rolling motion. Consider an object rolling down a ramp without slipping.

(a) Object rolls down ramp

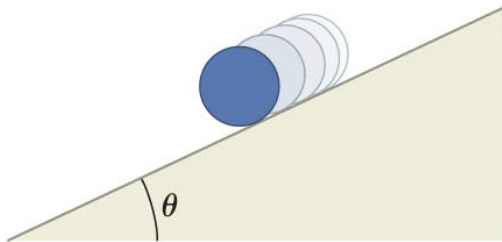

(b) Free-body diagram

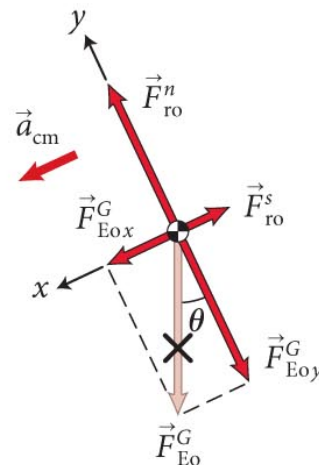

(c) Extended free-body diagram

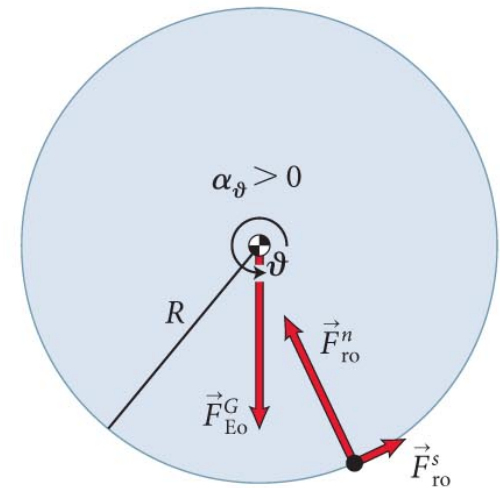

Section 12.6: Rolling motion

- Rolling rather than sliding occurs in this case because the force of static friction exerts a torque about the center of the object.
- The vector sum of the forces and the center-of-mass acceleration are related by

$$\sum F_x = F_{Eo\ x}^G - F_{ro}^s = mg \sin \theta - F_{ro}^s = ma_{cm\ x}$$

Section 12.6: Rolling motion

- The net torque about the axis ϑ is given by

$$\sum \tau_{\text{ext}\vartheta} = +F_{\text{ro}}^s R = I\alpha_{\vartheta}$$

where I is the rotational inertia and α_{ϑ} is the rotational acceleration.

- Solving these equations simultaneously yields

$$a_{\text{cm},x} = + \frac{g \sin \theta}{1 + \frac{I}{mR^2}} = + \frac{g \sin \theta}{1 + c}$$

$$F_{\text{ro}}^s = \frac{I}{R^2} a_{\text{cm},x} = \frac{cmR^2}{R^2} \frac{g \sin \theta}{1 + c} = \frac{mg \sin \theta}{c^{-1} + 1}$$

Section 12.6: Rolling motion

- Notice that the static friction plays a dual role in this analysis:
 1. It decreases the center-of-mass speed and acceleration of the rolling object, and
 2. It also causes the torque that gives the rotational acceleration.
- Smaller I means larger acceleration
 - Smaller I reaches the bottom of the ramp first

Section 12.6

Question 7

A wheel rolls without slipping along a horizontal surface. The center of the wheel has a translational speed v . The lowermost point on the wheel has a forward velocity of magnitude

1. $2v$.
2. v .
3. Zero.
4. We need more information.

Section 12.6

Question 7

A wheel rolls without slipping along a horizontal surface. The center of the wheel has a translational speed v . The lowermost point on the wheel has a forward velocity of magnitude

1. $2v$.

2. v .

 3. Zero – at that instant, it is in contact with the road

4. We need more information.

Section 12.7: Torque and energy

Section Goal

You will learn to

- Use the concept of total mechanical energy to compute the total kinetic energy of an object that is in both translational and rotational motion.

Section 12.7: Torque and energy

- Torques causes objects to accelerate rotationally and thus cause a change in their rotational kinetic energy.

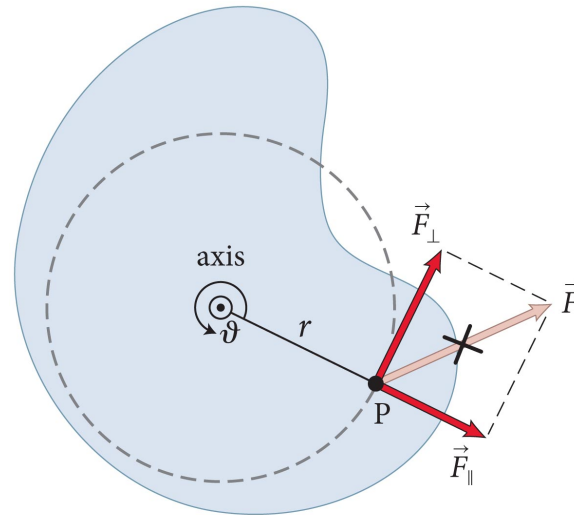

- Consider the object in the figure. A force \vec{F} is exerted at point P on the object. Using Eq. 12.10 we can write

$$\sum \tau_{\text{ext } \vartheta} = I \alpha_{\vartheta} = I \frac{d\omega_{\vartheta}}{dt} = I \frac{d\omega_{\vartheta}}{d\vartheta} \frac{d\vartheta}{dt} = I \frac{d\omega_{\vartheta}}{d\vartheta} \omega_{\vartheta}$$

$$\left(\sum \tau_{\text{ext } \vartheta} \right) d\vartheta = I \omega_{\vartheta} d\omega_{\vartheta}$$

Section 12.7: Torque and energy

- Integrating the left- and right-hand sides of Eq. 12.28, we will get an equation for the change in rotational kinetic energy:

$$\Delta K_{\text{rot}} = (\Sigma \tau_{\text{ext}}) \Delta \vartheta \quad (\text{constant torques, rigid object})$$

- Non-constant torque, integrate $\tau d\theta$

Section 12.7: Torque and energy

- Now, if the object is in both translational and rotational motion, then its kinetic energy is given by

$$K = K_{\text{cm}} + K_{\text{rot}} = \frac{1}{2}mv_{\text{cm}}^2 + \frac{1}{2}I\omega^2$$

- And the change in kinetic energy is given by

$$\Delta K = \Delta K_{\text{cm}} + \Delta K_{\text{rot}}$$

Section 12.7

Question 8

Two cylinders of the same size and mass roll down an incline. Cylinder A has most of its weight concentrated at the rim, while cylinder B has most of its weight concentrated at the center. Which reaches the bottom of the incline first?

1. A
2. B
3. Both reach the bottom at the same time.

Section 12.7

Question 8

Two cylinders of the same size and mass roll down an incline. Cylinder A has most of its weight concentrated at the rim, while cylinder B has most of its weight concentrated at the center. Which reaches the bottom of the incline first?

1. A
- ✓ 2. B – more mass at center = lower I = larger a
3. Both reach the bottom at the same time.

Section 12.7

Question 9

A solid disk and a ring roll down an incline. The ring is slower than the disk if

1. $m_{\text{ring}} = m_{\text{disk}}$, where m is the inertial mass.
2. $r_{\text{ring}} = r_{\text{disk}}$, where r is the radius.
3. $m_{\text{ring}} = m_{\text{disk}}$ and $r_{\text{ring}} = r_{\text{disk}}$.
4. The ring is always slower regardless of the relative values of m and r .

Section 12.7

Question 9

A solid disk and a ring roll down an incline. The ring is slower than the disk if

1. $m_{\text{ring}} = m_{\text{disk}}$, where m is the inertial mass.

2. $r_{\text{ring}} = r_{\text{disk}}$, where r is the radius.

3. $m_{\text{ring}} = m_{\text{disk}}$ and $r_{\text{ring}} = r_{\text{disk}}$.

✓ 4. The ring is always slower regardless of the relative values of m and r . Acceleration depends on I/mr^2 , which is independent of m and r .

Section 12.7: Torque and energy

Example 12.8 Rolling down a ramp

A solid cylindrical object of inertia m , rotational inertia I , and radius R rolls down a ramp that makes an angle θ with the horizontal. By how much does the cylinder's energy increase if it is released from rest and its center of mass drops a vertical distance h ?

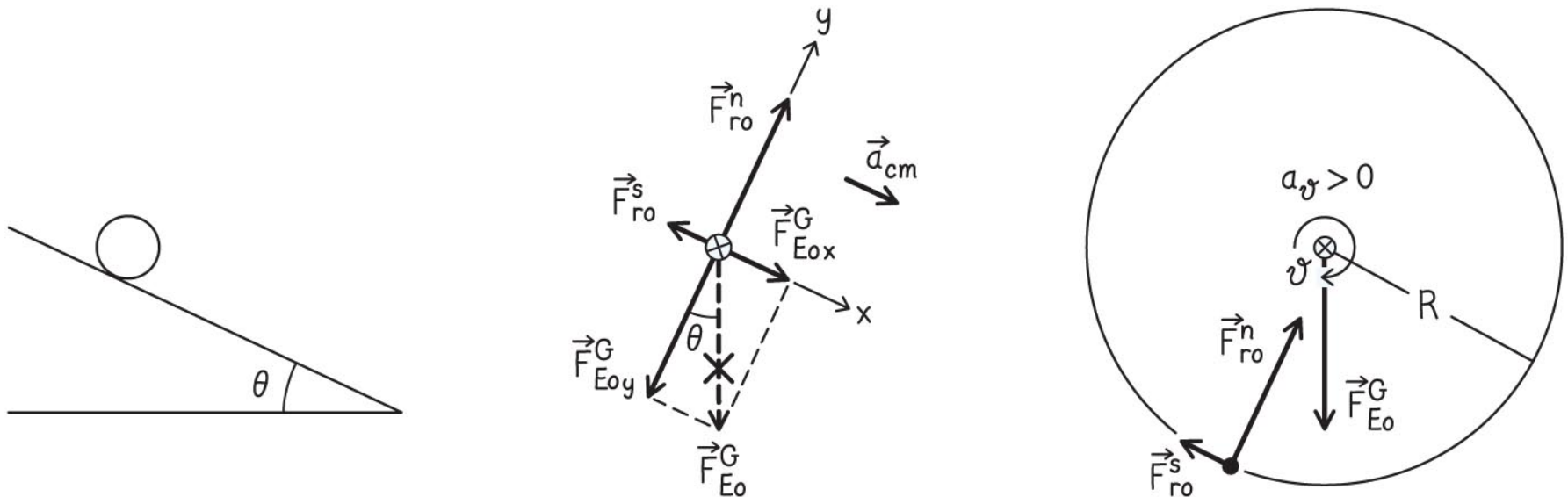

Section 12.7: Torque and energy

Example 12.8 Rolling down a ramp (cont.)

1 GETTING STARTED I am given information about an object in the shape of a solid cylinder—inertia, rotational inertia, radius, and initial speed—and my task is to find out how much the object's energy has increased once it has rolled down a ramp such that its center of mass has traveled a vertical distance h .

Section 12.7: Torque and energy

Example 12.8 Rolling down a ramp (cont.)

1 GETTING STARTED The object accelerates down the incline under the influence of the force of gravity. I therefore begin by making a sketch of the situation and drawing both free-body and extended free-body diagrams (Figure 12.42). The object is subject to a gravitational force exerted by Earth and a contact force exerted by the ramp.

Section 12.7: Torque and energy

Example 12.8 Rolling down a ramp (cont.)

1 GETTING STARTED If I choose my axes as shown in my sketch, the contact force exerted by the ramp has a normal component \vec{F}_{ro}^n in the y direction and a tangential component \vec{F}_{ro}^s in the negative x direction due to static friction.

Section 12.7: Torque and energy

Example 12.8 Rolling down a ramp (cont.)

② **DEVISE PLAN** As the object rolls, both its translational and rotational kinetic energies increase. Because the shape of the object does not change and because static friction is nondissipative, the object's internal energy does not change. I can use Eq. 12.32 for the change in translational kinetic energy and Eq. 12.31 for the change in rotational kinetic energy. To express the two factors on the right in Eq. 12.32 in terms of my given variables, I use the geometry of the situation to express both factors in terms of $\sin \theta$.

Section 12.7: Torque and energy

Example 12.8 Rolling down a ramp (cont.)

3 EXECUTE PLAN The change in translational kinetic energy is given by Eq. 12.32,

$\Delta K_{\text{cm}} = \left(\sum F_{\text{ext } x} \right) \Delta x_{\text{cm}}$, and the vector sum of the forces exerted on the object in the x direction is

$$\sum F_{\text{ext } x} = mg \sin \theta - F_{\text{ro}}^s$$

Section 12.7: Torque and energy

Example 12.8 Rolling down a ramp (cont.)

③ EXECUTE PLAN or, using Eq. 12.26,

$$\sum F_{\text{ext } x} = +mg \sin \theta \left(1 - \frac{1}{1 + c^{-1}} \right)$$

where c is the object's shape factor. Because the displacement of the object's center of mass along the plane is $\Delta x_{\text{cm}} = h/\sin \theta$, the change in its translational kinetic energy is

$$\Delta K_{\text{cm}} = \left(\sum F_{\text{ext } x} \right) \Delta x_{\text{cm}} = mgh \left(1 - \frac{1}{1 + c^{-1}} \right)$$

Section 12.7: Torque and energy

Example 12.8 Rolling down a ramp (cont.)

3 EXECUTE PLAN Next, I use Eq. 12.31 to calculate the change in the object's rotational kinetic energy.

From my extended free-body diagram I see that only the force of static friction causes a (positive) torque, so

$\sum \tau_{\text{ext } \vartheta} = +F_{\text{ro}}^s R$. I can find the object's rotational displacement $\Delta \vartheta$ from Eq. 12.18:

$$\Delta \vartheta = \frac{\Delta x_{\text{cm}}}{R} = \left(\frac{h}{\sin \theta} \right) \left(\frac{1}{R} \right) = + \frac{h}{R \sin \theta}$$

Section 12.7: Torque and energy

Example 12.8 Rolling down a ramp (cont.)

③ EXECUTE PLAN so, from Eq. 12.31,

$$\Delta K_{\text{rot}} = (F_{\text{ro}}^s R) \left(\frac{h}{R \sin \theta} \right) = \left(\frac{mg \sin \theta}{1 + c^{-1}} \right) \left(\frac{h}{\sin \theta} \right) = \frac{mgh}{1 + c^{-1}}$$

where I have again used Eq. 12.26 to substitute for F_{ro}^s . Adding the two changes in kinetic energy, I obtain

$$\begin{aligned} \Delta E = \Delta K_{\text{cm}} + \Delta K_{\text{rot}} &= mgh \left(1 - \frac{1}{1 + c^{-1}} \right) \\ &+ mgh \left(\frac{1}{1 + c^{-1}} \right) = mgh \checkmark \end{aligned}$$

Section 12.7: Torque and energy

Example 12.8 Rolling down a ramp (cont.)

④ EVALUATE RESULT My result indicates that the object's energy changes by the same amount it would change if it were simply in free fall! In other words, the only work done on the object is the work done by the gravitational force: $F_{\text{Eo}}^G \cdot \Delta\vec{r} = mgh$ (see Section 10.9). This implies that the work done by all other forces on the object is zero. The normal force does no work on the object because it is perpendicular to the displacement of the object, but what is the work done by the force of static friction on the object?

Section 12.7: Torque and energy

Example 12.8 Rolling down a ramp (cont.)

④ EVALUATE RESULT The object's displacement, $h/\sin \theta$, lies along the line of action of the force of static friction, and so it is tempting to write $-F_{\text{ro}}^s (h/\sin \theta)$ for the work done by the force of static friction on the object. However, the point of application for \vec{F}_{ro}^s has zero velocity. At each instant, a different point on the object's surface touches the ramp, but the instantaneous velocity of that point is zero. The force displacement for \vec{F}_{ro}^s is thus zero, so the work done by this force on the object is zero as well.

Homework

12.02 Moving a rock with a rod and another rock

Draw a picture! How would this actually work?

Homework

12.11 Rotating dumbbell

Find the center of mass ...

relative to one object, $x_{\text{com}} = m_1 l / (m_1 + m_2)$

that is the center of rotation

one object revolves with that radius

the other rotates with $l - x_{\text{com}}$

Homework

12.21 Ladder against the wall

Need a free body diagram and an extended free body diagram

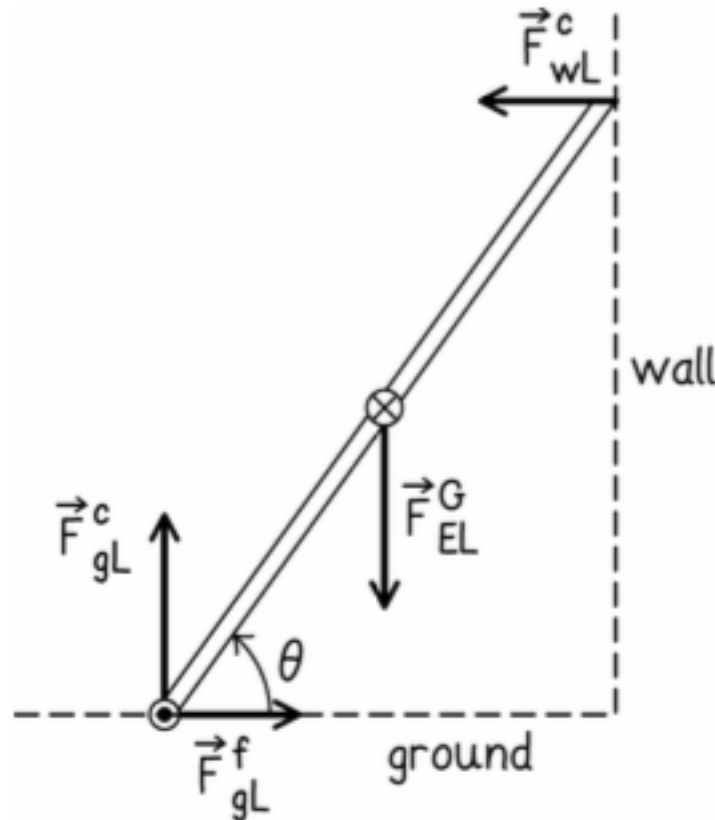

Homework

Forces along x ?

friction – contact force with wall = 0

$$F^f - F_{wl}^c = 0$$

Forces along y ?

contact with ground – weight

$$F_{gl}^c - mg = 0 \quad \text{so } mg = F_{gl}^c$$

Homework

Torque?

weight @ half the length of the rod * cosine
contact with wall at l * sine

$$F_{wl}^c \sin \theta - (l/2)mg \cos \theta = 0$$

For maximum force of friction, $F^f = \mu_s mg$

Put it together: angle depends on μ_s alone
(enter arctangent as “atan”)

Homework

Ladybugs

Angular velocity is the same everywhere, and $v=r\omega$

Tangential acceleration $a_t = r\alpha$, α is the same everywhere

Homework

12.30 A 0.19-kg turntable of radius 0.27 m spins about a vertical axis through its center. A constant rotational acceleration causes the turntable to accelerate from 0 to 28 revolutions per second in 8.0 s.

$$\alpha = \Delta\omega/\Delta t \text{ (revolutions } \rightarrow \text{ radians)}$$

$$\tau = I\alpha$$

Homework

12.36 rod of mass M , sign of mass m

Torque? Two weights, tension

$$lT - mgl \sin \theta - Mg (l/2) \sin \theta = 0$$

This is enough to get tension

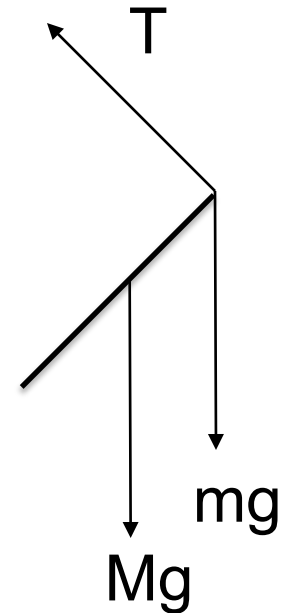

Homework

Forces?

Along x :

$$F_{pr,x} - T \cos \theta = 0$$

Along y :

$$F_{pr,y} + T \sin \theta - mg - Mg = 0$$

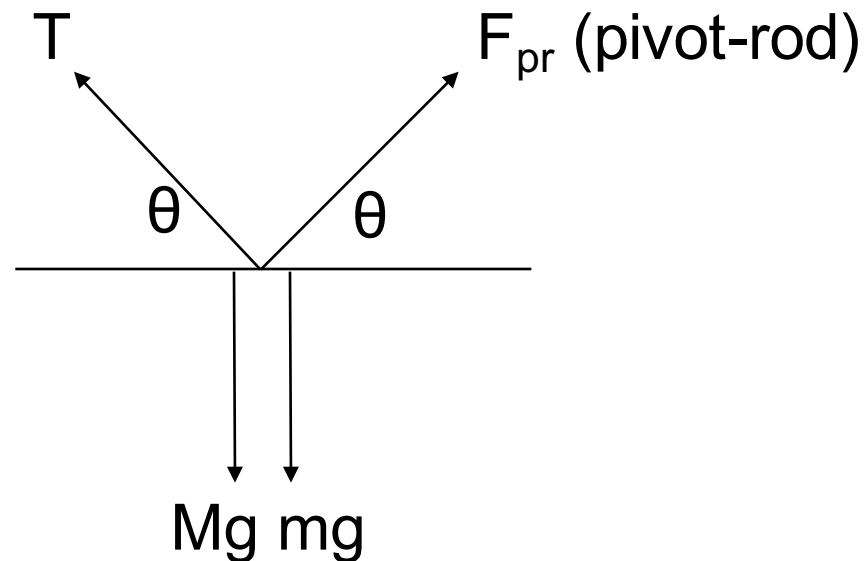

Enough to get both components

Homework

12.51

Rolling: net force along ramp as usual

$$ma_{\text{cm},x} = mg \sin \theta - F^f$$

Torque? Friction applied at distance r from center

$$I\alpha = F^f r$$

Rolling? Know $\alpha = a/r$

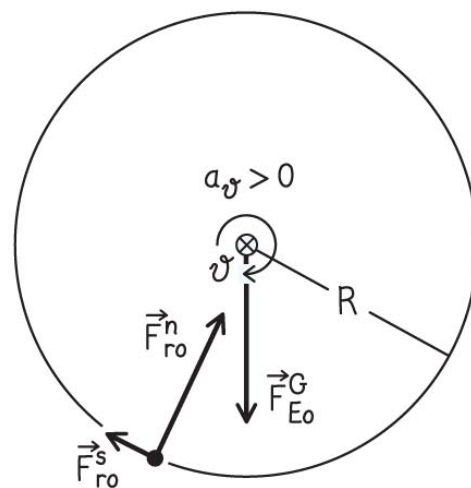
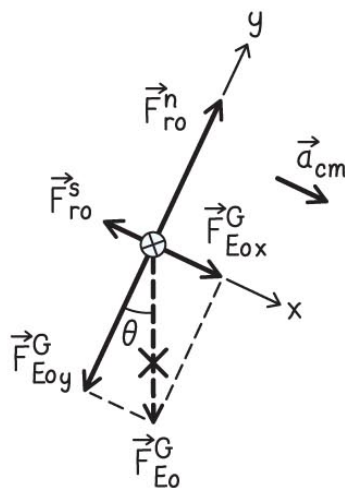
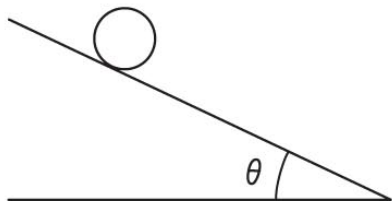

Homework

12.57

From previous, know acceleration

$$a_x = g \sin \theta / (1 + I/mr^2)$$

Kinematics: $d = \frac{1}{2}a_x t^2$

The ratio of times is independent of everything except the shape factors (2/3 for hollow, 2/5 for solid sphere)

Homework

12.69 Energy approach will work here!

$$\Delta U = \Delta K^{\text{rot}} + \Delta K^{\text{lin}}$$

$$\Delta U = mg\Delta y \dots$$

$$\Delta K^{\text{rot}} = \frac{1}{2} I\omega^2$$

$$\Delta K^{\text{lin}} = \frac{1}{2}mv^2$$

Rolling, so $v = \omega r$

Chapter 12: Summary

Concepts: Torque

- **Torque** is due to the tendency of a force applied to an object to give a rotational acceleration.
- The SI units for torque are $\text{N} \cdot \text{m}$.
- **Rotational equilibrium** requires the vector sum of the net external torque on an object equal zero.
- **Mechanical equilibrium** requires in addition that the vector sum of the net external force equal zero.

Chapter 12: Summary

Quantitative Tools: Torque

- If \vec{r} is the position vector from a pivot to the location at which a force \vec{F} is exerted on an object and θ is the angle between \vec{r} and \vec{F} , the torque τ produced by the force about the pivot is

$$\tau \equiv rF \sin \theta = r_{\perp} F = r F_{\perp}$$

where r_{\perp} is the component of \vec{r} perpendicular to \vec{F} and F_{\perp} is the component of \vec{F} perpendicular to \vec{r} .

Chapter 12: Summary

Quantitative Tools: Torque

- Translational equilibrium: $\sum \vec{F}_{\text{ext}} = \vec{0}$.
- Rotational equilibrium: $\sum \tau_{\text{ext } \vartheta} = 0$.
- **Mechanical equilibrium:**

$$\sum \tau_{\text{ext } \vartheta} = 0 \text{ and } \sum \vec{F}_{\text{ext}} = \vec{0}$$

Chapter 12: Summary

Concepts: Rotation of a rigid object

- In **free rotation** an object rotates about its center of mass.
- In rotation about a **fixed axis** an object is constrained to rotate about a physical axis.
- In **rolling motion without slipping** there is no relative motion at the location where the object touches the surface.
- The external force on a rolling object changes the object's center-of-mass kinetic energy.
- The external torque on a rolling object changes its rotational kinetic energy.

Chapter 12: Summary

Quantitative Tools: Rotation of a rigid object

- For both particles and extended bodies, the vector sum of the torques when rotation is about a fixed axis is

$$\sum \tau_{\text{ext } \vartheta} = I\alpha_{\vartheta}$$

- For an object of radius R that is rolling without slipping, the motion of the center of mass is described by

$$v_{\text{cm } x} = R\omega_{\vartheta}$$

$$a_{\text{cm } x} = R\alpha_{\vartheta}$$

$$\sum F_{\text{ext } x} = ma_{\text{cm } x}$$

$$\sum \tau_{\text{ext } \vartheta} = I\alpha_{\vartheta}$$

Chapter 12: Summary

Quantitative Tools: Rotation of a rigid object

- The change in an object's rotational kinetic energy resulting from torques is

$$\Delta K_{\text{rot}} = \left(\sum \tau_{\text{ext } \vartheta} \right) \Delta \vartheta \quad (\text{constant torques, rigid object})$$

- The kinetic energy of a rolling object is

$$K = K_{\text{cm}} + K_{\text{rot}} = \frac{1}{2} m v_{\text{cm}}^2 + \frac{1}{2} I \omega^2$$

- The change in the kinetic energy of a rolling object is

$$\Delta K = \Delta K_{\text{cm}} + \Delta K_{\text{rot}}$$

Chapter 12: Summary

Concepts: Angular momentum

- A **rotational impulse** J_{ϑ} is the amount of angular momentum transferred to a system from the environment by external torques.
- If the sum of the external torques due to forces exerted on a system is zero, the angular momentum of the system remains constant.

Chapter 12: Summary

Quantitative Tools: Angular momentum

- External torque caused by forces exerted on an object causes the object's angular momentum L_{ϑ} to change:

$$\sum \tau_{\text{ext } \vartheta} = \frac{dL_{\vartheta}}{dt}$$

Chapter 12: Summary

Quantitative Tools: Angular momentum

- The **angular momentum** law says that the change in the angular momentum of an object is equal to the **rotational impulse** given to the system:

$$\Delta L_{\vartheta} = J_{\vartheta}$$

- If the constant external torques on a system last for a time interval Δt , the **rotational impulse equation** says that the rotational impulse is

$$J_{\vartheta} = \left(\sum \tau_{\text{ext } \vartheta} \right) \Delta t$$

- The law of conservation of angular momentum states that if $\sum \tau_{\text{ext } \vartheta} = 0$, then $dL_{\vartheta} / dt = 0$. This means that

$$\sum \tau_{\text{ext } \vartheta} = \frac{dL_{\vartheta}}{dt} = 0 \Rightarrow \Delta L_{\vartheta} = 0$$

Chapter 12: Summary

Concepts: Rotational quantities as vectors

- A **polar vector** is a vector associated with a displacement.
- An **axial vector** is a vector associated with a rotation direction. This vector points along the rotation axis.
- The **right-hand rule** for axial vectors: When you curl the fingers of your right hand along the direction of rotation, your outstretched thumb points in the direction of the vector that specifies that rotation.

Chapter 12: Summary

Concepts: Rotational quantities as vectors

- **Right-hand rule** for vector products: When you align the fingers of your right hand along the first vector in a vector product and curl them from that vector to the second vector in the product through the smaller angle between the vectors, your outstretched thumb points in the direction of the vector product.
- The magnitude of the vector product of two vectors is equal to the area of the parallelogram defined by them.

Chapter 12: Summary

Quantitative Tools: Rotational quantities as vectors

- The magnitude of the **vector product** of vectors \vec{A} and \vec{B} that make an angle $\theta \leq 180^\circ$ between them when they are tail to tail is

$$|\vec{A} \times \vec{B}| = AB \sin \theta$$

- If \vec{r} is the vector from the origin of a coordinate system to the location where a force \vec{F} is exerted, the torque about the origin due to \vec{F} is

$$\vec{\tau} = \vec{r} \times \vec{F}$$

- If \vec{r} is the vector from the origin of a coordinate system to a particle that has momentum \vec{p} , the angular momentum of the particle about the origin is

$$\vec{L} = \vec{r} \times \vec{p}$$