

## **Chapter 20**

### **Planar Transformers**

## Table of Contents

1. Introduction .....	
2. Planar Transformer Basic Construction .....	
3. Planar Integrated PC Board Magnetics.....	
4. Core Geometries .....	
5. Planar Transformer and Inductor Design Equations .....	
6. Window Utilization, $K_u$ .....	
7. Current Density, $J$ .....	
8. Printed Circuit Windings .....	
9. Calculating the Mean Length Turn, MLT .....	
10. Winding Resistance and Dissipation .....	
11. PC Winding Capacitance .....	
12. Planar Inductor Design.....	
13. Winding Termination .....	
14. PC Board Base Materials .....	
15. Core Mounting and Assembly .....	
16. References.....	

## Introduction

The planar transformer, or inductor, is a low profile device that covers a large area, whereas, the conventional transformer would be more cubical in volume. Planar Magnetics is the new “buzz” word in the field of power magnetics. It took a few engineers with the foresight to come up with a way to increase the power density, while at the same time increasing the overall performance, and also, making it cost effective. One of the first papers published on planar magnetics was by Alex Estrov, back in 1986. After reviewing this paper, you really get a feeling of what he accomplished. A whole new learning curve can be seen on low profile ferrite cores and printed circuit boards if one is going to do any planar transformer designs. It is an all-new technology for the transformer engineer. The two basic items that made this technology feasible were the power, MOSFETs that increased the switching frequency and enabled the designer to reduce the turns, and the ferrite core, which can be molded and machined into almost any shape. After this paper was written the interest in planar magnetics seems to increase each year.

### Planar Transformer Basic Construction

Here, shown in Figure 20-1 through Figure 20-4 are four views of a typical EE core, planar construction method. The assembled planar transformers have very unique characteristics in their finished construction. In the assembled planar transformer, every primary turn is at a precise location, governed by the PC board. The primary is always the same distance from the secondary. This provides a tight control over the primary to secondary leakage inductance. Using the same insulating material will always provide the same capacitance between primary and secondary; in this way, all parasitics will be the same from unit to unit. With this type of planar construction, the engineer will have a tight control over leakage inductance, the resonant frequency, and the common-mode rejection. A tight control is necessary on all materials used.

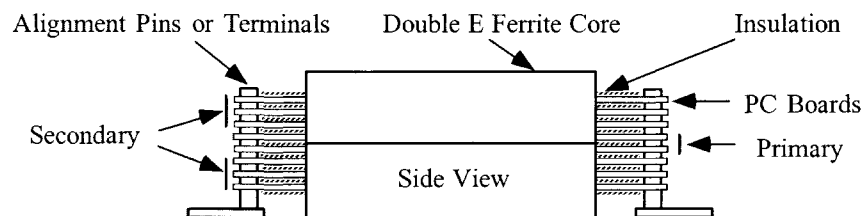
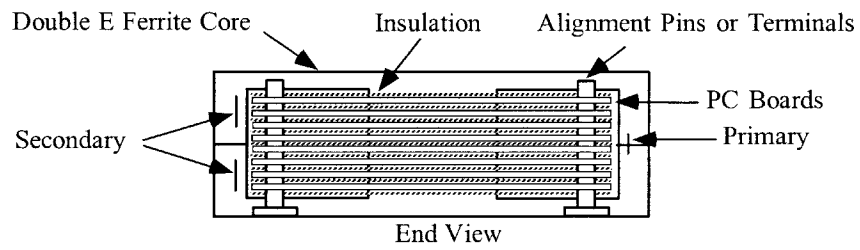
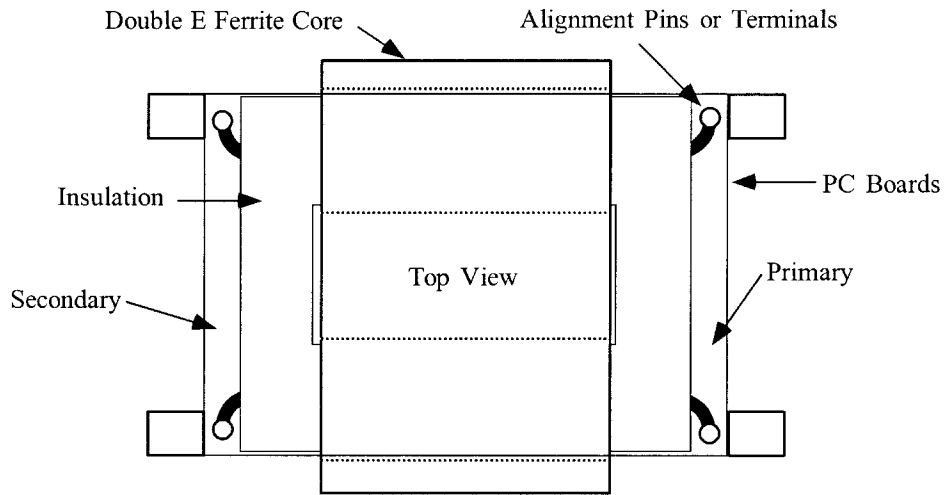

Figure 20-1. Side View of a Typical EE Planar Transformer.



**Figure 20-2.** End View of a Typical EE Planar Transformer.



**Figure 20-3.** Top View of a Typical EE Planar Transformer.

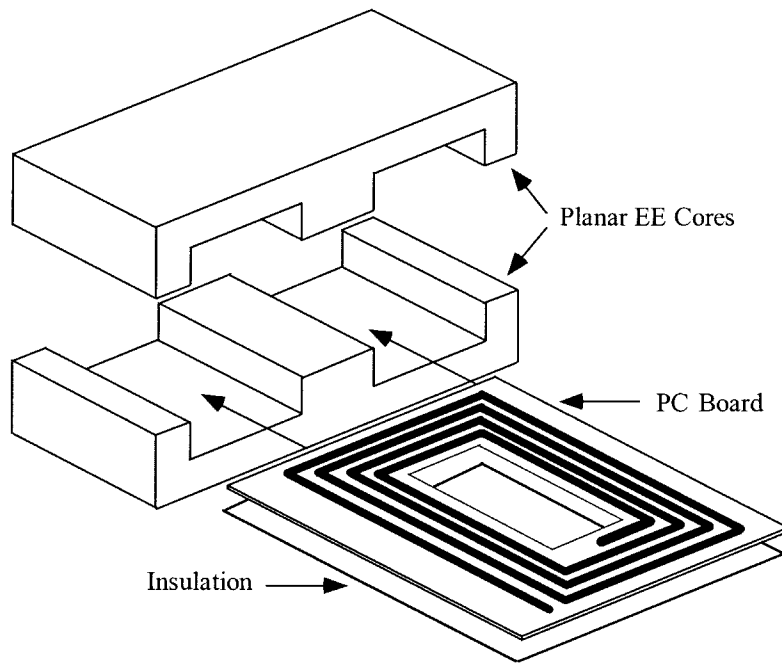

**Figure 20-4.** A Perspective View of a Typical EE Planar Transformer.

## Planar Integrated PC Board Magnetics

Planar transformers and inductors are now being integrated right on the main PC board. Design engineers are pushing the operating frequency higher and higher to where it is commonplace to operate at frequency range between 250-500kHz. As the frequency increases the power supplies are getting smaller and smaller. To reduce the size of the power supply even further engineers are going to planar magnetics that are integrated into the main PC board. An exploded view to show the multi-layers PC board of a planar transformer that has been integrated into the main PC board is shown in Figure 20-5. The final assembly of the same planar transformer is shown in Figure 20-6.

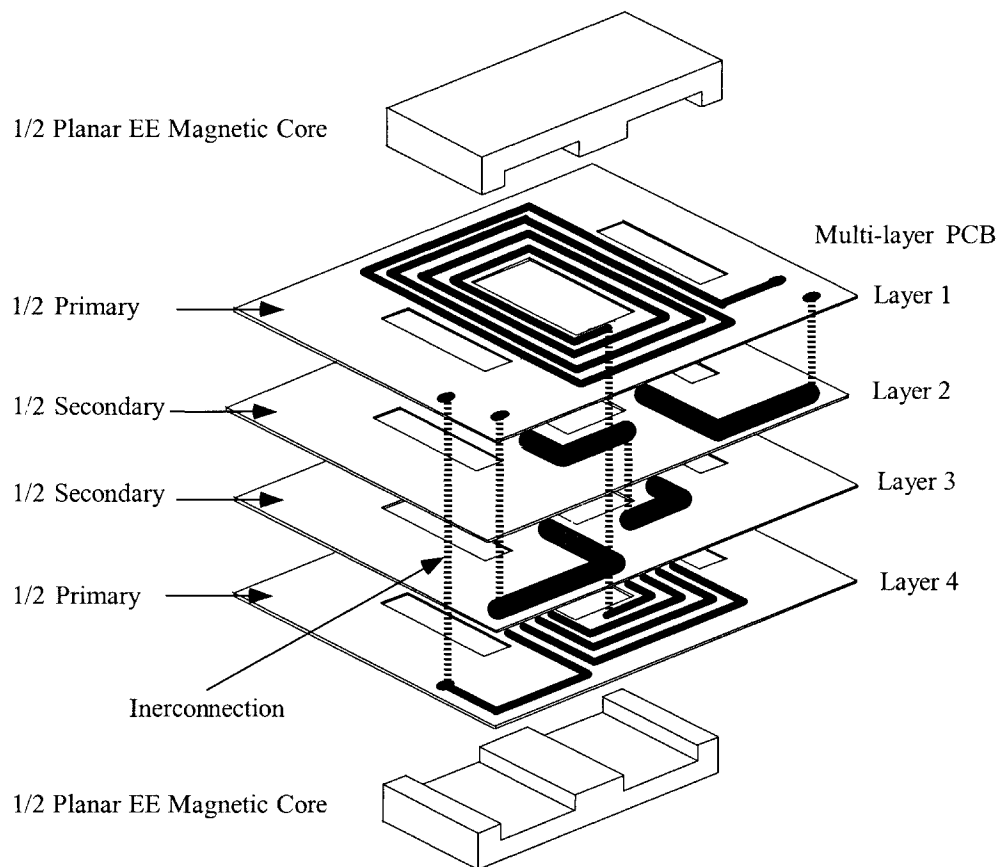

**Figure 20-5.** A Planar Transformer Integrated into the Main PC Board.

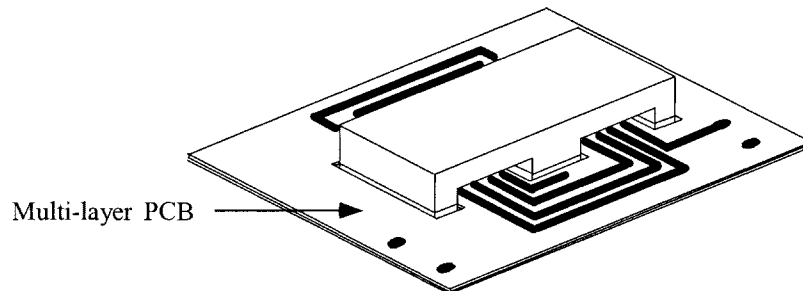

**Figure 20-6.** PC Board Planar Transformer in Final Assembly.

## Core Geometries

The EE and EI are not the only planar geometries now available. There are a few firms in the ferrite industry that offer low profile versions of their standard cores, giving the engineer a few more choices in his design. There are EE and EI cores available from Magnetics Inc. as shown in Figure 20-7; there are ER cores available from Ferroxcube, as shown in Figure 20-8; there are ETD-lp cores available from Ferrite International, as shown in Figure 20-9; there are PQ-lp cores available from Ferrite International, as shown in Figure 20-10; and there are RM-lp cores available from Ferroxcube, as shown in Figure 20-11. There are several advantages, with cores with a round center post, such as PQ-lp, RM-lp, ETD-lp and ER. A round center post results in a more efficient use of copper and a more efficient use of board space. There is a company, Ceramic Magnetics, Inc. (CMI), that can modify any of these cores to your specification or machine a special core for your application. The IEC has a new standard 62313 for planar cores that supercedes standard 61860.

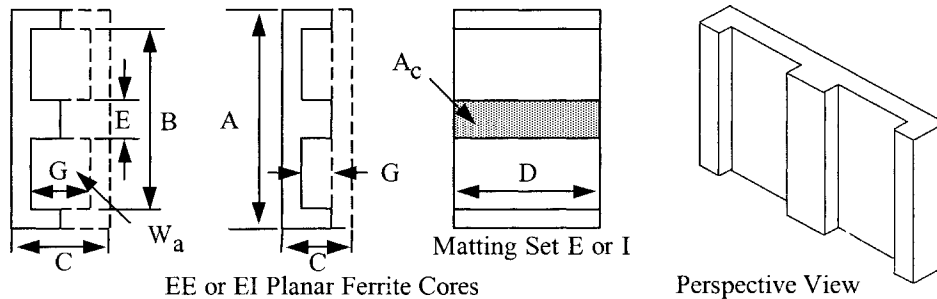

**Figure 20-7.** Magnetic Inc. EE and EI Low Profile Planar Cores.

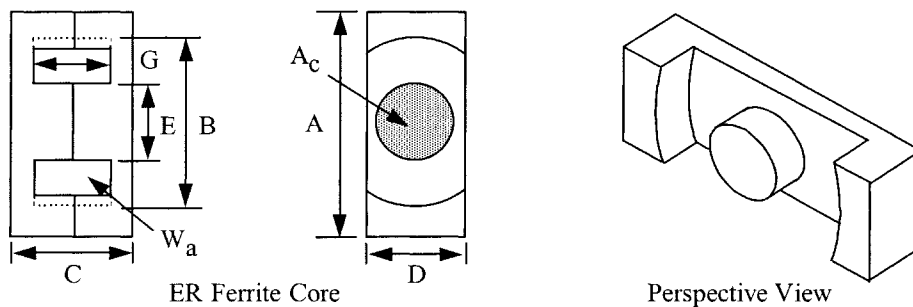

**Figure 20-8.** Ferroxcube ER Low Profile Planar Cores.

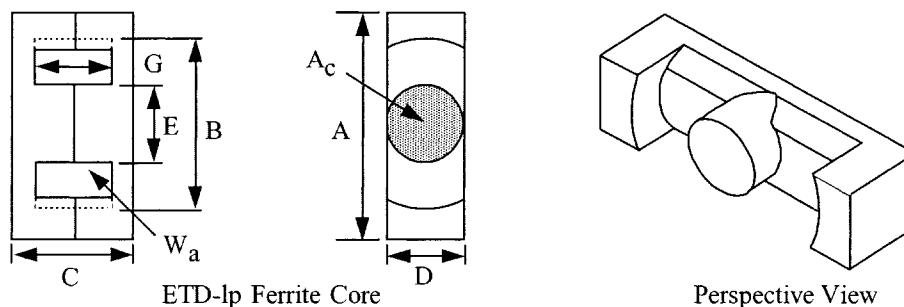

**Figure 20-9.** Ferrite International ETD Low Profile Planar Cores.

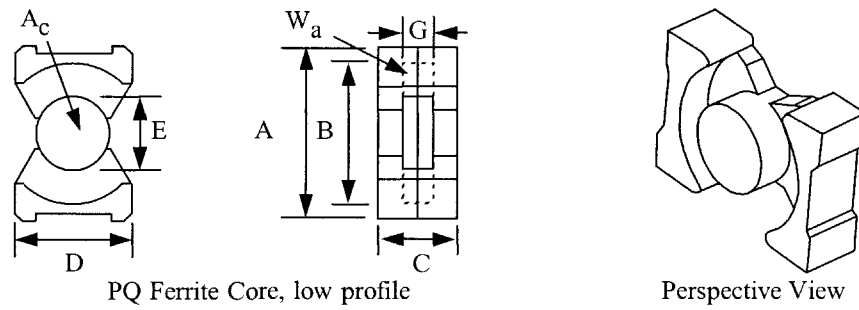

Figure 20-10. Ferrite International PQ Low Profile Planar Cores.

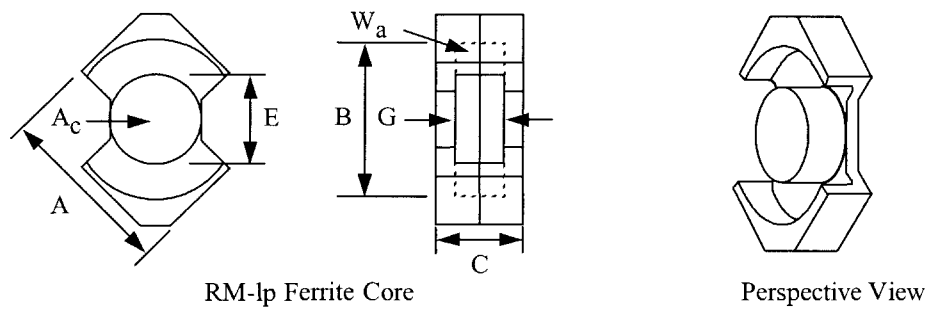

Figure 20-11. Ferroxcube RM Low Profile Planar Cores.

### Planar Transformer and Inductor Design Equations

The same design equations are used, as well as the criteria used to select the proper core, to design a planar transformer as a conventional transformer. Faraday's Law is still used to calculate the required turns:

$$N = \frac{V_p(10^4)}{K_f f A_c B_{ac}}, \text{ [turns]} \quad [20-1]$$

The core power handling equation,  $A_p$ :

$$A_p = \frac{P_t(10^4)}{K_f K_u f A_c B_{ac} J}, \text{ [cm}^4\text{]} \quad [20-2]$$

The gapped inductor equation, L:

$$L = \frac{0.4\pi N^2 A_c (10^{-8})}{l_g + \left(\frac{MPL}{\mu_m}\right)}, \text{ [henrys]} \quad [20-3]$$

The core energy handling equation,  $A_p$ :

$$A_p = \frac{2(\text{Energy})}{K_u B_{ac} J}, \text{ [cm}^4\text{]} \quad [20-4]$$

## Window Utilization, $K_u$

The window utilization factor in the conventional transformer is about 0.40. This means that 40% of the window is filled with copper, the other 60% of the area is devoted to the bobbin or tube, to the insulation both layer and wire, and to the winding technique. The window utilization is explained, in detail, in Chapter 4. Designing a planar transformer and using the PC winding technique, reduces the window utilization factor even further. The window utilization,  $K_u$ , comparison of the two different winding techniques is shown in Figure 20-12.

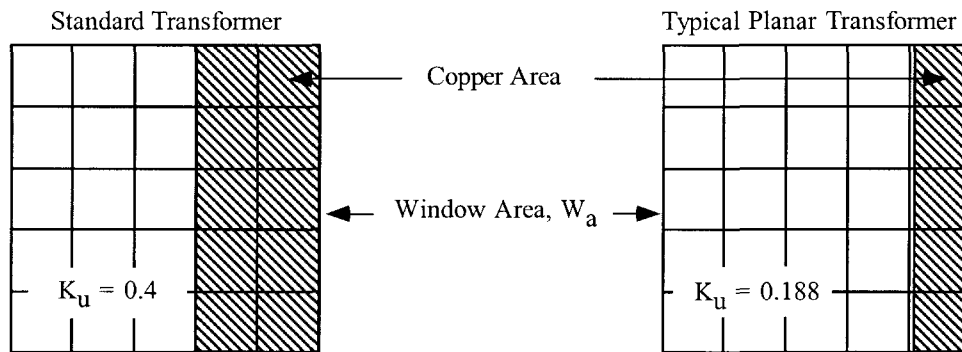

**Figure 20-12.** Comparing the Window Utilization of a Standard Transformer and a Planar Transformer.

A PC board window utilization,  $K_u$ , calculation example will be as follows:

The windings will be placed on a double-sided 2oz PC board 10 mils thick, giving a total thickness of 15.4 mils (0.0391 cm). The Mylar insulation material is between the PC boards, and between the PC boards, and the core will add another 4 mils (0.0102 cm) to the thickness. This will give 19.4 mils (0.0493 cm) per layer. There will be a 20 mil space (margin) between the edge of the board and the copper clad. The copper width will be the window width of 0.551cm minus 2x the margin of 0.102. This will give a total copper width of 0.449. The window utilization,  $K_u$ , will be summed in Table 20-1, using Figure 20-13 as a guide.

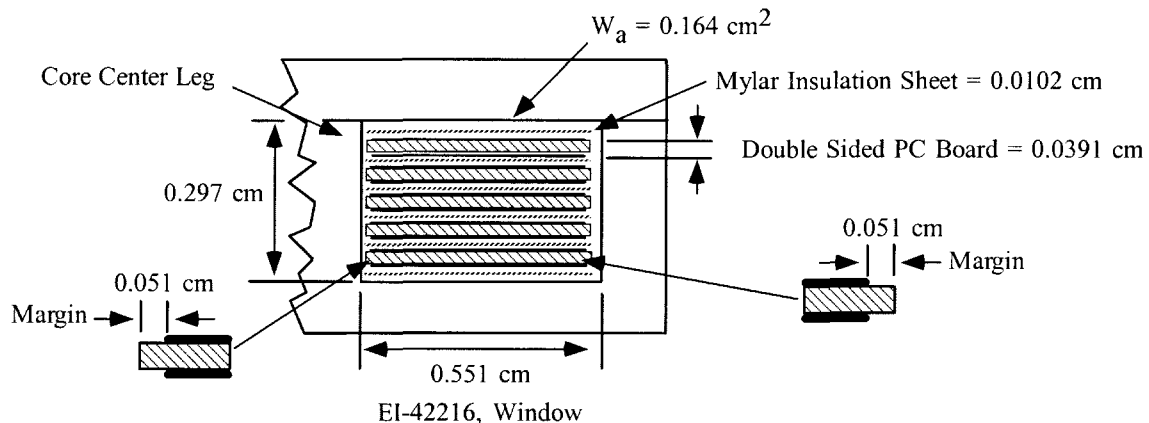

**Figure 20-13.** Window Utilization of a Typical EI Planar Transformer.



**Table 20-1**

EI-42216 Window Utilization	
Window Height, cm	0.2970
Window Width, cm	0.5510
Window Area, cm <sup>2</sup>	0.1640
PC Board Thickness with Copper, cm	0.0391
Sheet Insulator, cm	0.0102
Total Insul. 5+1 Layers Thick, cm	0.0612
Total Thickness 5 Layers, cm	0.2570
Copper Thickness 5 Layers, cm	0.0686
Copper Width, cm	0.4494
Total Copper Area, cm <sup>2</sup>	0.0308
Window Utilization, K <sub>u</sub>	0.1878

### **Current Density, J**

One of the unknown factors in designing planar transformers is the current density, J. The current density controls the copper loss (regulation) and the inherent temperature rise caused by the copper loss. The temperature rise is normally controlled by the surface dissipation of the transformer. The size of a transformer goes up by the cubic law, and the surface area goes up by the square law. Large transformers, such as 60 Hz, are designed with a low current density, while 400 Hz are designed with higher current density for the same temperature rise. There used to be an old rule of thumb, for a large transformer, you use 1000 circular mils per amp, and for a small transformer, you use 500 circular mils per amp:

$$500\text{CM/Amp} \approx 400\text{Amps/cm}^2, \quad [400 \text{ Hertz Aircraft}]$$

$$1000\text{CM/Amp} \approx 200\text{Amps/cm}^2, \quad [60 \text{ Hertz}]$$

Planar transformer designers handle the current density in a different way. When designing planar transformer PC windings, designers use the same technology used by the printed, circuit board designers, and that is the current rating for a given voltage drop and temperature rise. It is another way of saying the same thing. The printed circuit boards are covered with a copper clad. The thickness of this copper is called out in ounces, such as 1oz, 2oz, and 3oz. The weight in ounces comes from an area of one square foot of material. So 1oz of copper clad would be 1 square foot, and have a thickness of 0.00135 inch; 2oz would be 0.0027 inch; and 3oz would be 0.00405 inch. Tables have been made to show the current capacity for a constant temperature rise with different line width. The design data for 1oz copper is shown in Table 20-2. The 2oz copper is shown in Table 20-3, and 3oz copper is shown in Table 20-4. Planar transformer engineers are using the industrial guidelines for their selection of copper trace thickness and line width, based on temperature rise. The first effort for a planar transformer, PC winding should be around:

100CM/Amp  $\approx$  2000Amps/cm<sup>2</sup>, [500 kHz Planar Transformers]

If the current density is based on Table 20-1, with a line width of 0.06 inches, then use:

35CM/Amp  $\approx$  5700Amps/cm<sup>2</sup>, [500 kHz Planar Transformers]

**Table 20-2.** Design Data for 0.00135 Inch Thick Copper Clad.

*Printed Circuit Trace Data for 1oz Copper (Based on 10 Inches Long)							
Line Width Inches	Line Width mm	Resistance micro-ohm per-mm	Copper Weight 1oz Thickness 0.00135 cm <sup>2</sup> **AWG		Temp. °C Increase above Amb. Vs. Current in Amperes		
					5°	20°	40°
0.0200	0.51	989.7	0.000174	35	1.00	3.00	4.00
0.0400	1.02	494.9	0.000348	32	2.25	5.00	6.50
0.0600	1.52	329.9	0.000523	30	3.00	6.50	8.00
0.0800	2.03	247.4	0.000697	29	4.00	7.00	9.50
0.1000	2.54	197.9	0.000871	28	4.50	8.00	11.00
0.1200	3.05	165.0	0.001045	27	5.25	9.25	12.00
0.1400	3.56	141.4	0.001219	26	6.00	10.00	13.00
0.1600	4.06	123.7	0.001394	26	6.50	11.00	14.25
0.1800	4.57	110.0	0.001568	25	7.00	11.75	15.00
0.2000	5.08	99.0	0.001742	25	7.25	12.50	16.60
*Data From: Handbook of Electronic Packaging.							
**This is a close approximation to an equivalent AWG wire size.							

**Table 20-3.** Design Data for 0.0027 Inch Thick Copper Clad.

*Printed Circuit Trace Data for 2oz Copper (Based on 10 Inches Long)							
Line Width Inches	Line Width mm	Resistance micro-ohm per-mm	Copper Weight 2oz Thickness 0.0027 cm <sup>2</sup> **AWG		Temp. °C Increase above Amb. Vs. Current in Amperes		
					5°	20°	40°
0.0200	0.51	494.9	0.000348	32	2.00	4.00	6.25
0.0400	1.02	247.4	0.000697	29	3.25	7.00	9.00
0.0600	1.52	165.0	0.001045	27	4.25	9.00	11.25
0.0800	2.03	123.7	0.001394	26	5.00	10.25	13.25
0.1000	2.54	99.0	0.001742	25	5.25	11.00	15.25
0.1200	3.05	82.5	0.002090	24	5.75	12.25	17.00
0.1400	3.56	70.7	0.002439	23	6.25	13.25	18.50
0.1600	4.06	61.9	0.002787	23	6.50	14.25	20.50
0.1800	4.57	55.0	0.003135	22	7.00	15.25	22.00
0.2000	5.08	49.5	0.003484	22	7.25	16.25	24.00
*Data From: Handbook of Electronic Packaging.							
**This is a close approximation to an equivalent AWG wire size.							

**Table 20-4.** Design Data for 0.00405 Inch Thick Copper Clad.

*Printed Circuit Trace Data for 3oz Copper (Based on 10 Inches Long)							
Line Width Inches	Line Width mm	Resistance micro-ohm per-mm	Copper Weight 3oz Thickness 0.00405		Temp. °C Increase above Amb. Vs. Current in Amperes		
			cm <sup>2</sup>	**AWG	5°	20°	40°
0.0200	0.51	329.9	0.000523	30	2.50	6.00	7.00
0.0400	1.02	165.0	0.001045	27	4.00	8.75	11.00
0.0600	1.52	110.0	0.001568	25	4.75	10.25	13.50
0.0800	2.03	82.5	0.002090	24	5.50	12.00	15.75
0.1000	2.54	66.0	0.002613	23	6.00	13.25	17.50
0.1200	3.05	55.0	0.003135	22	6.75	15.00	19.50
0.1400	3.56	47.1	0.003658	22	7.00	16.00	21.25
0.1600	4.06	41.2	0.004181	21	7.25	17.00	23.00
0.1800	4.57	36.7	0.004703	20	7.75	18.25	25.00
0.2000	5.08	33.0	0.005226	20	8.00	19.75	27.00

\*Data From: Handbook of Electronic Packaging.  
 \*\*This is a close approximation to an equivalent AWG wire size.

### Printed Circuit Windings

There will be a few paths of mystery along the way when engineers first get started in the design of a planar transformer. Therefore, it would be much easier to start on a simple design and use magnet wire, then convert that into a truly all planar approach, using a PC winding board design. In this way the engineer will slide up the learning curve slowly. There are several benefits to a printed circuit winding. Once the printed winding board is finished and the layout is fixed, the winding will not vary and all of the parasitics, including the leakage inductance, will be frozen. This is not necessarily true in conventional transformers. There are two basic core configurations available to the engineer for planar design. The first configuration is the EE or EI with the rectangular center post. A typical high current and low current winding PC board for E cores is shown in Figure 20-14.

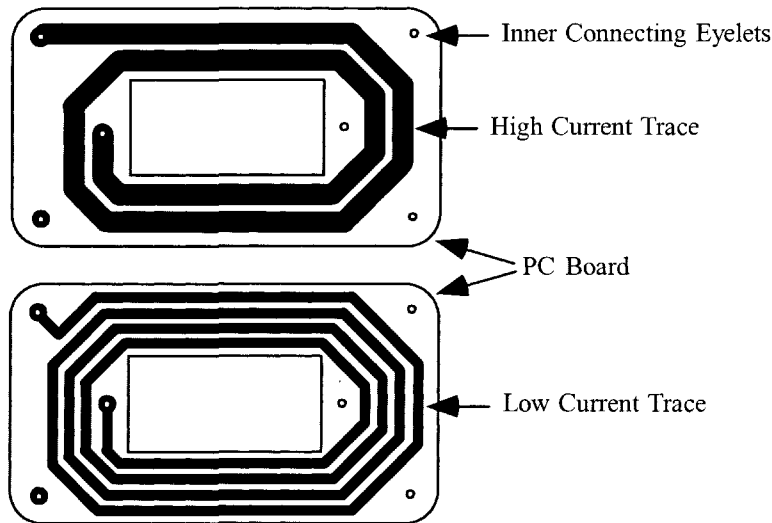

**Figure 20-14.** Typical Planar E Core Winding PC Board.

The second configuration is shown in Figure 20-15. These are four cores with round center legs. Winding PC boards with round center legs are used on PQ-lp, RM-lp, ETD-lp and ER cores. There is an advantage to cores with round center legs. Cores with round center leg will produce a round ID, OD resulting in a more efficient use of copper.

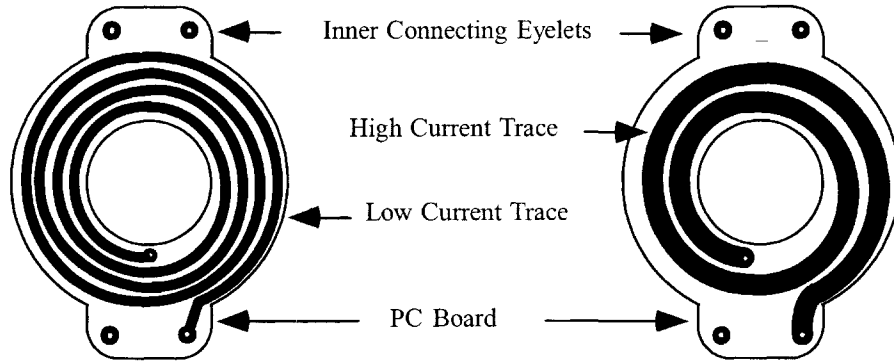

**Figure 20-15.** Typical Circular Winding PC Board for Cores with Round Center Leg.

### Calculating the Mean Length Turn, MLT

The Mean Length Turn (MLT), is required to calculate the dc winding resistance. With the winding resistance known, the winding voltage drop can be calculated at rated load. The winding dimensions, relating to the Mean Length Turn (MLT) for a rectangular winding, is shown in Figure 20-16, along with the MLT equation, and a circular winding is shown in Figure 20-17, along with the MLT equation.

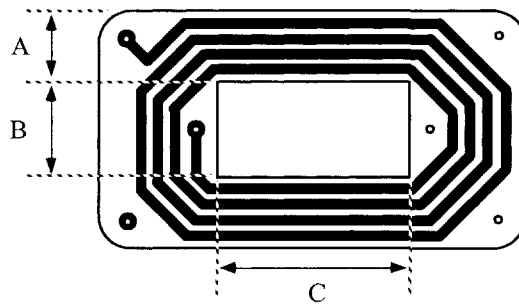

$$MLT = 2B + 2C + 2.82A, \text{ [mm]} \quad [20-5]$$

**Figure 20-16.** Dimensions, Relating to a Rectangular Winding, Mean Length Turn (MLT).

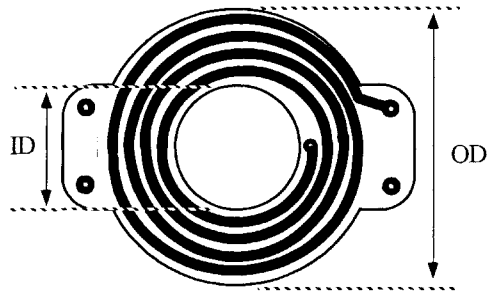

$$MLT = \frac{\pi(OD + ID)}{2}, \text{ [mm]} \quad [20-6]$$

**Figure 20-17.** Dimensions, Relating to a Circular Winding, Mean Length Turn (MLT).

### Winding Resistance and Dissipation

The winding dc resistance and voltage drop will be calculated as follows:

Calculate the Mean Length Turn (MLT) using the winding board configuration and Equation in Figure 20-17. Use the printed winding data in Table 20-5.

**Table 20-5.** PC Board Winding Data

PC Winding Data		
Item		Units
PC Board Turns Each Side	4	
Winding Trace Thickness	0.0027	inches
Winding Trace Width	2.54	mm
Trace Resistance	99	$\mu\Omega/\text{mm}$
Winding Board, OD	31.5	mm
Winding Board, ID	14.65	mm
Winding Current, I	3	amps
PC Board Thickness	0.5	mm
PC Board Dielectric Constant, K	4.7	

Step 1. Calculate the Mean Length Turn, MLT:

$$MLT = \frac{\pi(OD + ID)}{2}, \text{ [mm]}$$

$$MLT = \frac{3.14(31.5 + 14.65)}{2}, \text{ [mm]}$$

$$MLT = 72.5, \text{ [mm]}$$

Step 2. Calculate the winding resistance, R:

$$R = MLT(N) \left( \frac{\mu\Omega}{\text{mm}} \right) (10^{-6}), \text{ [ohms]}$$

$$R = (72.5)(8)(99.0)(10^{-6}), \text{ [ohms]}$$

$$R = 0.057, \text{ [ohms]}$$

Step 3. Calculate the winding voltage drop,  $V_w$ :

$$V_w = IR, \text{ [volts]}$$

$$V_w = (3.0)(0.057), \text{ [volts]}$$

$$V_w = 0.171, \text{ [volts]}$$

Step 4. Calculate the winding dissipation,  $P_w$ :

$$P_w = I^2 R, \text{ [watts]}$$

$$P_w = (3)^2 (0.057), \text{ [watts]}$$

$$P_w = 0.513, \text{ [watts]}$$

### PC Winding Capacitance

The PC winding board traces will have capacitance, to the other side of the board as shown in Figure 20-18. This capacitance could be to another winding, or a Faraday shield to ground.

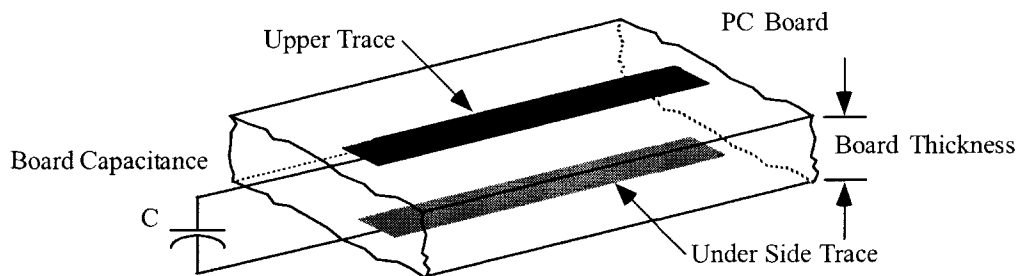

**Figure 20-18.** PC Board Trace Capacitance.

The formula for calculating the winding trace capacitance, to either another winding trace or ground plane, is given in Equation 20-7.

$$C_p = \frac{0.0085 K A}{d}, \text{ [pf]}$$

Where:

$C_p$  = capacitance, [pf] [20-7]

$K$  = dielectric constant

$A$  = area of the trace, [mm<sup>2</sup>]

$d$  = thickness of the PC board, [mm]

A typical square wave power converter, operating at 250kHz, will have extremely fast rise and fall times in the order of 0.05 micro-seconds. This fast excursion will generate a fairly high current pulse depending on the capacitance and source impedance.

The calculation of the winding capacitance is as follows:

Use the PC board winding data in Table 20-5, the outline drawing in Figure 20-19, and Equation 20-7:

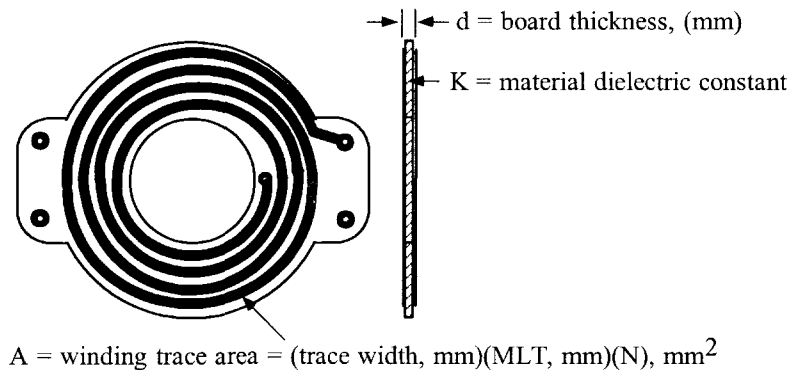

**Figure 20-19.** PC Board Winding Capacitance.

Step 1. Calculate the winding trace area,  $A$ .

$$A = (\text{trace width, mm})(\text{MLT, mm})(\text{turns, } N), \text{ [mm}^2\text{]}$$

$$A = (2.54)(72.5)(8), \text{ [mm}^2\text{]}$$

$$A = 1473, \text{ [mm}^2\text{]}$$

Step 2. Calculate the winding capacitance,  $C_p$ .

$$C_p = \frac{0.0085 K A}{d}, \text{ [pf]}$$

$$C_p = \frac{0.0085(4.7)(1473)}{(0.50)}, \text{ [pf]}$$

$$C_p = 118, \text{ [pf]}$$

## Planar Inductor Design

Planar inductors are designed the same way as the conventional inductors. See Chapter 8. Planar inductors use the same planar cores and PC winding board techniques as the transformers. The main difference is the inductor will have a gap to prevent the dc current from prematurely saturating the core. It is normal to operate planar magnetics at a little higher temperature than conventional designs. It is important to check the maximum operating flux level at maximum operating temperature.

Fringing flux can be severe in any gapped ferrite inductor, but, even more so, on planar construction, because of the printed winding board, as shown in Figure 20-20. When the flux intersects the copper winding, eddy currents are generated, which produces hot spots and reduces the overall efficiency. The use of a PC winding board, (flat traces), can give the eddy currents an added degree of freedom. The resulting loss could be a disaster.

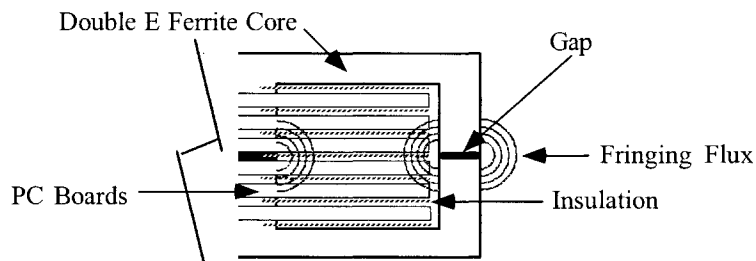
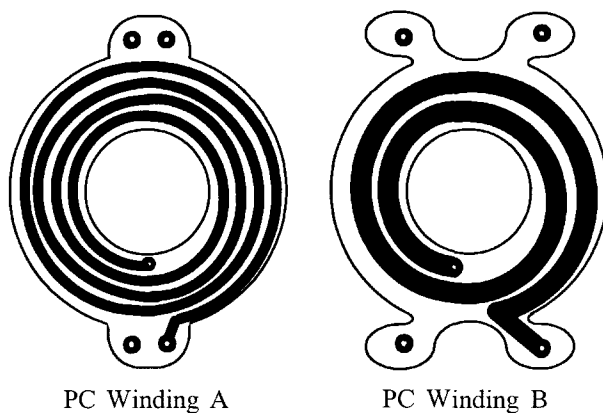

**Figure 20-20.** Fringing Flux Cutting Across PC Winding Boards.

## Winding Termination

Making connections from a planar transformer to the outside world could be very clumsy, if not enough thought is put in for termination. It has to be remembered that this is a high frequency transformer, and skin effect, (ac resistance), has to be addressed. Because of the skin effect it is important the external leads of the planar transformer must be kept as short as possible. Terminations are very important for currents of one amp and above. A poor connection will only get worse. It is recommended to use plated-through holes and eyelets, where possible, but cost will control that. If the transformer has many interconnections, or only a few, there must be provisions made for those connections. When the PC winding boards are stacked, and because of the high density, all connections and interconnections have to be done with extended area pads, as shown in Figure 20-21. The PC winding boards require good artwork registry to make sure the interconnections can be made between boards. Interconnections are usually done, by passing a bus wire through a hole, and at the same time making the connection on the other board. If the solder terminations are to be made on the board, then it is important to leave as much room as possible especially if the connection is to be made with copper foil, as shown in Figure 20-22. When the PC windings have to be paralleled, because of the increased current, the interconnecting jumpers will also have to be increased.





**Figure 20-21.** PC Winding Boards Showing Butterfly Pads.

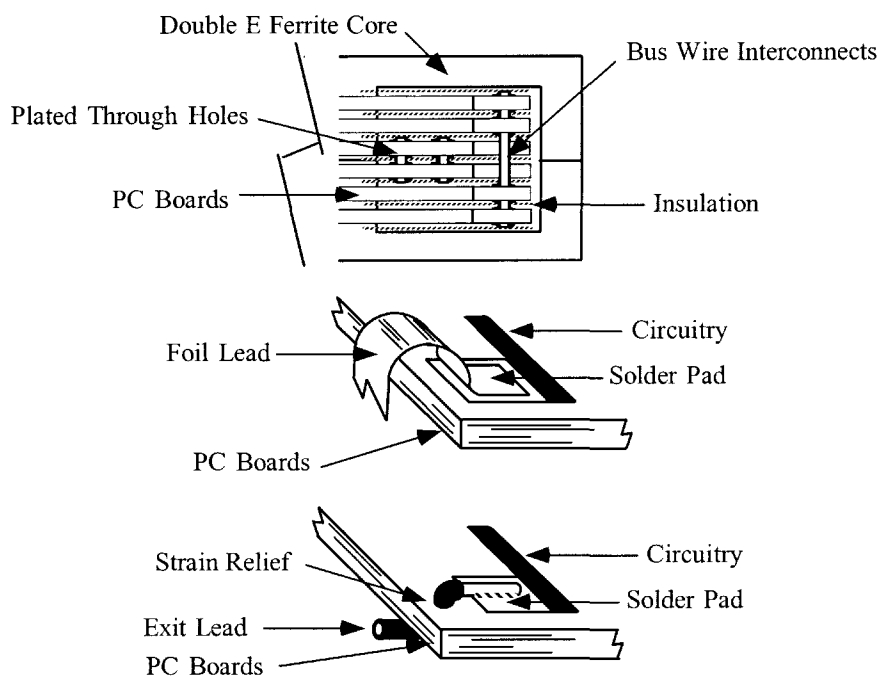

**Figure 20-22.** PC Winding Boards, Showing Interconnections and Exit Leads.

### PC Board Base Materials

PC Board materials are available in various grades, as defined by the National Electrical Manufacturers Association (NEMA). The important properties for PC Board materials are tabulated in Table 20-6. It is very important to choose the correct PC board material for your application. Planar transformers are normally stressed to the last watt for a given temperature rise. This could give rise to hot spots at winding terminations and cause PC Board discoloration. Due to their inherent design Planar transformers will have a wide temperature delta,  $\Delta t$ . It would be wise to stay away from paper/phenolic materials and materials that absorb moisture.

**Table 20-6.** Properties of Typical Printer Circuit Board Materials

Properties of Typical Printed Circuit Board Materials							
Material/Comments	NEMA Grade						
	FR-1 Paper Phenolic	FR-2 Paper Phenolic	FR-3 Paper Epoxy	FR-4 Glass/Cloth Epoxy	FR-5 Glass/Cloth Epoxy	G10 Glass/Cloth Epoxy	G11 Glass/Cloth Epoxy
Mechanical Strength	good	good	good	excellent	excellent	excellent	excellent
Moisture Resistant	poor	good	good	excellent	excellent	excellent	excellent
Insulation	fair	good	good	excellent	excellent	excellent	excellent
Arc Resistance	poor	poor	fair	good	good	good	good
Tool Abrasion	good	good	good	poor	poor	poor	poor
Max. Cont. Temp. °C	105	105	105	130	170	130	170
Dielectric Constant, K	4.2	4.2	4.4	4.7	4.3	4.6	4.5

### Core Mounting and Assembly

Core assembly and mounting should be strong and stable with temperature. One of the most viable methods for securing core halves together is epoxy adhesive. There is one epoxy adhesive that has been around a long time and that's 3M EC-2216A/B. This bonding technique is shown in Figure 20-23 and it seems to work quite well. When the core halves are properly bonded with epoxy adhesive, there will be little or no effect on the electrical performance. This means the epoxy adhesive added little or no gap to the mating surface. Large temperature excursions are normal in planar magnetics. Care should be taken into account for the coefficients of thermal expansion between the core and mounting surfaces. It has to be remembered ferrite is a ceramic and is very brittle. Planar cores have a low silhouette with thin sections that cannot absorb as much strain as other geometries. After the planar transformer has been assembled, there should be a small amount of play in the PC winding assembly to guarantee there will be a minimum of stress over temperature.

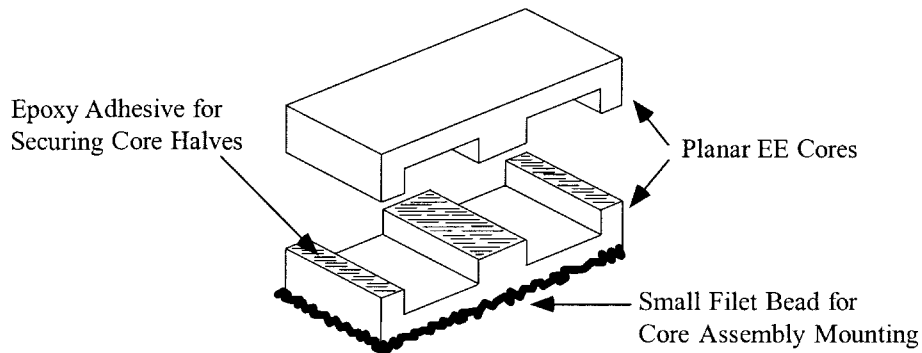

**Figure 20-23.** Epoxy Adhesive for Securing Transformer Assembly.

## References

1. Designing with Planar Ferrite Cores, Technical Bulletin FC-S8, Magnetics, Division of Spang and Company 2001.
2. Brown, E., "Planar Magnetics Simplifies Switchmode Power Supply Design and Production," PCIM, June 1992, pp. 46-52.
3. Van der Linde, Boon, and Klassens, "Design of High-Frequency Planar Power Transformer in Multilayer Technology," IEEE Transaction on Industrial Electronics, Vol. 38, No. 2, April 1991, pp. 135-141.
4. Bloom, E., "Planar Power Magnetics: New Low Profile Approaches for Low-Cost Magnetics Design," Magnetic Business & Technology, June 2002, pp. 26,27.
5. Charles A. Harper, *Handbook of Electronic Packaging*, McGraw-Hill Book Company, pp. 1-51-1-53.
6. Reference Data for Radio Engineers, Fourth Edition, International Telephone and Telegraph Corp. March 1957, pp. 107-111.
7. PC Boards, Casco Circuits, Inc., 10039 D Canoga Ave., Chatsworth, CA 91311. Tel. (818) 882-0972.