

Chapter 3

Integral Relations for a Control Volume

Motivation. In analyzing fluid motion, we might take one of two paths: (1) seeking to describe the detailed flow pattern at every point (x, y, z) in the field or (2) working with a finite region, making a balance of flow in versus flow out, and determining gross flow effects such as the force or torque on a body or the total energy exchange. The second is the “control-volume” method and is the subject of this chapter. The first is the “differential” approach and is developed in Chap. 4.

We first develop the concept of the control volume, in nearly the same manner as one does in a thermodynamics course, and we find the rate of change of an arbitrary gross fluid property, a result called the *Reynolds transport theorem*. We then apply this theorem, in sequence, to mass, linear momentum, angular momentum, and energy, thus deriving the four basic control-volume relations of fluid mechanics. There are many applications, of course. The chapter then ends with a special case of frictionless, shaft-work-free momentum and energy: the *Bernoulli equation*. The Bernoulli equation is a wonderful, historic relation, but it is extremely restrictive and should always be viewed with skepticism and care in applying it to a real (viscous) fluid motion.

3.1 Basic Physical Laws of Fluid Mechanics

It is time now to really get serious about flow problems. The fluid-statics applications of Chap. 2 were more like fun than work, at least in my opinion. Statics problems basically require only the density of the fluid and knowledge of the position of the free surface, but most flow problems require the analysis of an arbitrary state of variable fluid motion defined by the geometry, the boundary conditions, and the laws of mechanics. This chapter and the next two outline the three basic approaches to the analysis of arbitrary flow problems:

1. Control-volume, or large-scale, analysis (Chap. 3)
2. Differential, or small-scale, analysis (Chap. 4)
3. Experimental, or dimensional, analysis (Chap. 5)

The three approaches are roughly equal in importance, but control-volume analysis is “more equal,” being the single most valuable tool to the engineer for flow analysis. It gives “engineering” answers, sometimes gross and crude but always useful. In princi-

ple, the differential approach of Chap. 4 can be used for any problem, but in practice the lack of mathematical tools and the inability of the digital computer to model small-scale processes make the differential approach rather limited. Similarly, although the dimensional analysis of Chap. 5 can be applied to any problem, the lack of time and money and generality often makes experimentation a limited approach. But a control-volume analysis takes about half an hour and gives useful results. Thus, in a trio of approaches, the control volume is best. Oddly enough, it is the newest of the three. Differential analysis began with Euler and Lagrange in the eighteenth century, and dimensional analysis was pioneered by Lord Rayleigh in the late nineteenth century, but the control volume, although proposed by Euler, was not developed on a rigorous basis as an analytical tool until the 1940s.

Systems versus Control Volumes

All the laws of mechanics are written for a *system*, which is defined as an arbitrary quantity of mass of fixed identity. Everything external to this system is denoted by the term *surroundings*, and the system is separated from its surroundings by its *boundaries*. The laws of mechanics then state what happens when there is an interaction between the system and its surroundings.

First, the system is a fixed quantity of mass, denoted by m . Thus the mass of the system is conserved and does not change.¹ This is a law of mechanics and has a very simple mathematical form, called *conservation of mass*:

$$m_{\text{syst}} = \text{const} \quad (3.1)$$

or

$$\frac{dm}{dt} = 0$$

This is so obvious in solid-mechanics problems that we often forget about it. In fluid mechanics, we must pay a lot of attention to mass conservation, and it takes a little analysis to make it hold.

Second, if the surroundings exert a net force \mathbf{F} on the system, Newton's second law states that the mass will begin to accelerate²

$$\mathbf{F} = m\mathbf{a} = m \frac{d\mathbf{V}}{dt} = \frac{d}{dt} (m\mathbf{V}) \quad (3.2)$$

In Eq. (2.12) we saw this relation applied to a differential element of viscous incompressible fluid. In fluid mechanics Newton's law is called the linear-momentum relation. Note that it is a vector law which implies the three scalar equations $F_x = ma_x$, $F_y = ma_y$, and $F_z = ma_z$.

Third, if the surroundings exert a net moment \mathbf{M} about the center of mass of the system, there will be a rotation effect

$$\mathbf{M} = \frac{d\mathbf{H}}{dt} \quad (3.3)$$

where $\mathbf{H} = \sum(\mathbf{r} \times \mathbf{V}) \delta m$ is the angular momentum of the system about its center of

¹We are neglecting nuclear reactions, where mass can be changed to energy.

²We are neglecting relativistic effects, where Newton's law must be modified.

mass. Here we call Eq. (3.3) the angular-momentum relation. Note that it is also a vector equation implying three scalar equations such as $M_x = dH_x/dt$.

For an arbitrary mass and arbitrary moment, \mathbf{H} is quite complicated and contains nine terms (see, e.g., Ref. 1, p. 285). In elementary dynamics we commonly treat only a rigid body rotating about a fixed x axis, for which Eq. (3.3) reduces to

$$M_x = I_x \frac{d}{dt} (\omega_x) \quad (3.4)$$

where ω_x is the angular velocity of the body and I_x is its mass moment of inertia about the x axis. Unfortunately, fluid systems are not rigid and rarely reduce to such a simple relation, as we shall see in Sec. 3.5.

Fourth, if heat dQ is added to the system or work dW is done by the system, the system energy dE must change according to the energy relation, or first law of thermodynamics,

$$dQ - dW = dE \quad (3.5)$$

or

$$\frac{dQ}{dt} - \frac{dW}{dt} = \frac{dE}{dt}$$

Like mass conservation, Eq. (3.1), this is a scalar relation having only a single component.

Finally, the second law of thermodynamics relates entropy change dS to heat added dQ and absolute temperature T :

$$dS \geq \frac{dQ}{T} \quad (3.6)$$

This is valid for a system and can be written in control-volume form, but there are almost no practical applications in fluid mechanics except to analyze flow-loss details (see Sec. 9.5).

All these laws involve thermodynamic properties, and thus we must supplement them with state relations $p = p(\rho, T)$ and $e = e(\rho, T)$ for the particular fluid being studied, as in Sec. 1.6.

The purpose of this chapter is to put our four basic laws into the control-volume form suitable for arbitrary regions in a flow:

1. Conservation of mass (Sec. 3.3)
2. The linear-momentum relation (Sec. 3.4)
3. The angular-momentum relation (Sec. 3.5)
4. The energy equation (Sec. 3.6)

Wherever necessary to complete the analysis we also introduce a state relation such as the perfect-gas law.

Equations (3.1) to (3.6) apply to either fluid or solid systems. They are ideal for solid mechanics, where we follow the same system forever because it represents the product we are designing and building. For example, we follow a beam as it deflects under load. We follow a piston as it oscillates. We follow a rocket system all the way to Mars.

But fluid systems do not demand this concentrated attention. It is rare that we wish to follow the ultimate path of a specific particle of fluid. Instead it is likely that the

fluid forms the environment whose effect on our product we wish to know. For the three examples cited above, we wish to know the wind loads on the beam, the fluid pressures on the piston, and the drag and lift loads on the rocket. This requires that the basic laws be rewritten to apply to a specific *region* in the neighborhood of our product. In other words, where the fluid particles in the wind go after they leave the beam is of little interest to a beam designer. The user's point of view underlies the need for the control-volume analysis of this chapter.

Although thermodynamics is not at all the main topic of this book, it would be a shame if the student did not review at least the first law and the state relations, as discussed, e.g., in Refs. 6 and 7.

In analyzing a control volume, we convert the system laws to apply to a specific region which the system may occupy for only an instant. The system passes on, and other systems come along, but no matter. The basic laws are reformulated to apply to this local region called a control volume. All we need to know is the flow field in this region, and often simple assumptions will be accurate enough (e.g., uniform inlet and/or outlet flows). The flow conditions away from the control volume are then irrelevant. The technique for making such localized analyses is the subject of this chapter.

Volume and Mass Rate of Flow

All the analyses in this chapter involve evaluation of the volume flow Q or mass flow \dot{m} passing through a surface (imaginary) defined in the flow.

Suppose that the surface S in Fig. 3.1a is a sort of (imaginary) wire mesh through which the fluid passes without resistance. How much volume of fluid passes through S in unit time? If, typically, \mathbf{V} varies with position, we must integrate over the elemental surface dA in Fig. 3.1a. Also, typically \mathbf{V} may pass through dA at an angle θ off the normal. Let \mathbf{n} be defined as the unit vector normal to dA . Then the amount of fluid swept through dA in time dt is the volume of the slanted parallelepiped in Fig. 3.1b:

$$d\mathcal{V} = V dt dA \cos \theta = (\mathbf{V} \cdot \mathbf{n}) dA dt$$

The integral of $d\mathcal{V}/dt$ is the total volume rate of flow Q through the surface S

$$Q = \int_S (\mathbf{V} \cdot \mathbf{n}) dA = \int_S V_n dA \quad (3.7)$$

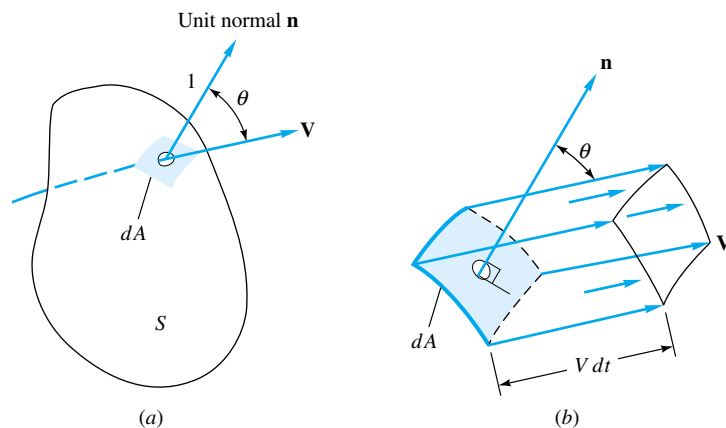

Fig. 3.1 Volume rate of flow through an arbitrary surface: (a) an elemental area dA on the surface; (b) the incremental volume swept through dA equals $V dt dA \cos \theta$.

We could replace $\mathbf{V} \cdot \mathbf{n}$ by its equivalent, V_n , the component of \mathbf{V} normal to dA , but the use of the dot product allows Q to have a sign to distinguish between inflow and outflow. By convention throughout this book we consider \mathbf{n} to be the *outward* normal unit vector. Therefore $\mathbf{V} \cdot \mathbf{n}$ denotes outflow if it is positive and inflow if negative. This will be an extremely useful housekeeping device when we are computing volume and mass flow in the basic control-volume relations.

Volume flow can be multiplied by density to obtain the mass flow \dot{m} . If density varies over the surface, it must be part of the surface integral

$$\dot{m} = \int_s \rho(\mathbf{V} \cdot \mathbf{n}) dA = \int_s \rho V_n dA$$

If density is constant, it comes out of the integral and a direct proportionality results:

Constant density:
$$\dot{m} = \rho Q$$

3.2 The Reynolds Transport Theorem

To convert a system analysis to a control-volume analysis, we must convert our mathematics to apply to a specific region rather than to individual masses. This conversion, called the *Reynolds transport theorem*, can be applied to all the basic laws. Examining the basic laws (3.1) to (3.3) and (3.5), we see that they are all concerned with the time derivative of fluid properties m , \mathbf{V} , \mathbf{H} , and E . Therefore what we need is to relate the time derivative of a system property to the rate of change of that property within a certain region.

The desired conversion formula differs slightly according to whether the control volume is fixed, moving, or deformable. Figure 3.2 illustrates these three cases. The fixed control volume in Fig. 3.2a encloses a stationary region of interest to a nozzle designer. The control surface is an abstract concept and does not hinder the flow in any way. It slices through the jet leaving the nozzle, circles around through the surrounding atmosphere, and slices through the flange bolts and the fluid within the nozzle. This particular control volume exposes the stresses in the flange bolts, which contribute to applied forces in the momentum analysis. In this sense the control volume resembles the *free-body* concept, which is applied to systems in solid-mechanics analyses.

Figure 3.2b illustrates a moving control volume. Here the ship is of interest, not the ocean, so that the control surface chases the ship at ship speed V . The control volume is of fixed volume, but the relative motion between water and ship must be considered.

Fig. 3.2 Fixed, moving, and deformable control volumes: (a) fixed control volume for nozzle-stress analysis; (b) control volume moving at ship speed for drag-force analysis; (c) control volume deforming within cylinder for transient pressure-variation analysis.

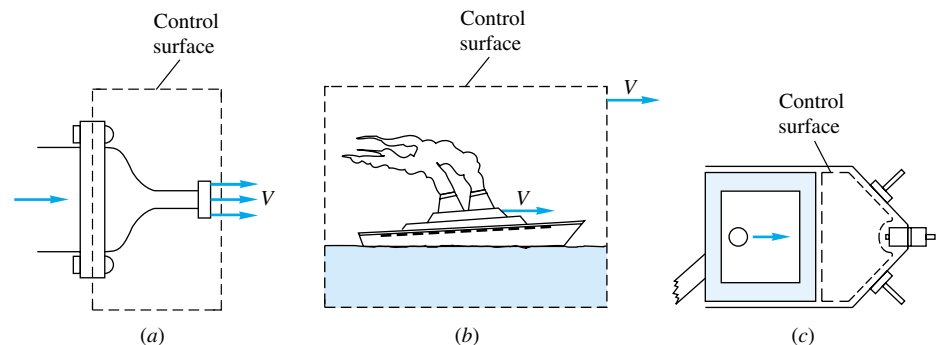

If V is constant, this relative motion is a steady-flow pattern, which simplifies the analysis.³ If V is variable, the relative motion is unsteady, so that the computed results are time-variable and certain terms enter the momentum analysis to reflect the noninertial frame of reference.

Figure 3.2c shows a deforming control volume. Varying relative motion at the boundaries becomes a factor, and the rate of change of shape of the control volume enters the analysis. We begin by deriving the fixed-control-volume case, and we consider the other cases as advanced topics.

One-Dimensional Fixed Control Volume

As a simple first example, consider a duct or streamtube with a nearly one-dimensional flow $V = V(x)$, as shown in Fig. 3.3. The selected control volume is a portion of the duct which happens to be filled exactly by system 2 at a particular instant t . At time $t + dt$, system 2 has begun to move out, and a sliver of system 1 has entered from the left. The shaded areas show an outflow sliver of volume $A_b V_b dt$ and an inflow volume $A_a V_a dt$.

Now let B be any property of the fluid (energy, momentum, etc.), and let $\beta = dB/dm$ be the *intensive* value or the amount of B per unit mass in any small portion of the fluid. The total amount of B in the control volume is thus

$$B_{CV} = \int_{CV} \beta \rho dV \quad \beta = \frac{dB}{dm} \quad (3.8)$$

³A *wind tunnel* uses a fixed model to simulate flow over a body moving through a fluid. A *tow tank* uses a moving model to simulate the same situation.

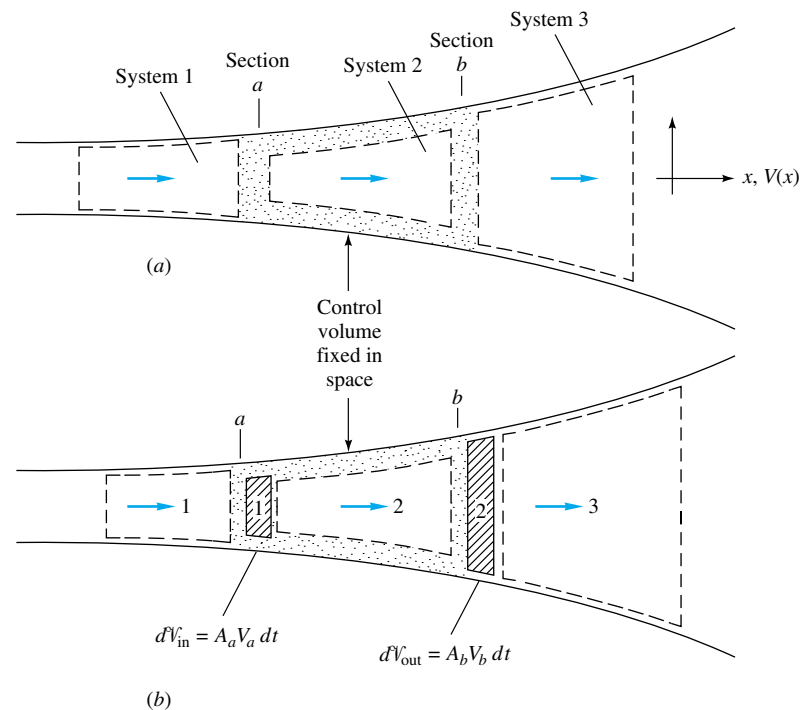

Fig. 3.3 Example of inflow and outflow as three systems pass through a control volume: (a) System 2 fills the control volume at time t ; (b) at time $t + dt$ system 2 begins to leave and system 1 enters.

where ρd^3V is a differential mass of the fluid. We want to relate the rate of change of B_{CV} to the rate of change of the amount of B in system 2 which happens to coincide with the control volume at time t . The time derivative of B_{CV} is defined by the calculus limit

$$\begin{aligned}\frac{d}{dt}(B_{CV}) &= \frac{1}{dt} B_{CV}(t + dt) - \frac{1}{dt} B_{CV}(t) \\ &= \frac{1}{dt} [B_2(t + dt) - (\beta\rho d^3V)_{\text{out}} + (\beta\rho d^3V)_{\text{in}}] - \frac{1}{dt} [B_2(t)] \\ &= \frac{1}{dt} [B_2(t + dt) - B_2(t)] - (\beta\rho AV)_{\text{out}} + (\beta\rho AV)_{\text{in}}\end{aligned}$$

The first term on the right is the rate of change of B within system 2 at the instant it occupies the control volume. By rearranging the last line of the above equation, we have the desired conversion formula relating changes in any property B of a local system to one-dimensional computations concerning a fixed control volume which instantaneously encloses the system.

$$\frac{d}{dt}(B_{\text{sys}}) = \frac{d}{dt} \left(\int_{CV} \beta\rho d^3V \right) + (\beta\rho AV)_{\text{out}} - (\beta\rho AV)_{\text{in}} \quad (3.9)$$

This is the one-dimensional Reynolds transport theorem for a fixed volume. The three terms on the right-hand side are, respectively,

1. The rate of change of B within the control volume
2. The flux of B passing out of the control surface
3. The flux of B passing into the control surface

If the flow pattern is steady, the first term vanishes. Equation (3.9) can readily be generalized to an arbitrary flow pattern, as follows.

Arbitrary Fixed Control Volume

Figure 3.4 shows a generalized fixed control volume with an arbitrary flow pattern passing through. The only additional complication is that there are variable slivers of inflow and outflow of fluid all about the control surface. In general, each differential area dA of surface will have a different velocity \mathbf{V} making a different angle θ with the local normal to dA . Some elemental areas will have inflow volume $(VA \cos \theta)_{\text{in}} dt$, and others will have outflow volume $(VA \cos \theta)_{\text{out}} dt$, as seen in Fig. 3.4. Some surfaces might correspond to streamlines ($\theta = 90^\circ$) or solid walls ($\mathbf{V} = 0$) with neither inflow nor outflow. Equation (3.9) generalizes to

$$\frac{d}{dt}(B_{\text{sys}}) = \frac{d}{dt} \left(\int_{CV} \beta\rho d^3V \right) + \int_{CS} \beta\rho V \cos \theta dA_{\text{out}} - \int_{CS} \beta\rho V \cos \theta dA_{\text{in}} \quad (3.10)$$

This is the Reynolds transport theorem for an arbitrary fixed control volume. By letting the property B be mass, momentum, angular momentum, or energy, we can rewrite all the basic laws in control-volume form. Note that all three of the control-volume integrals are concerned with the intensive property β . Since the control volume is fixed in space, the elemental volumes d^3V do not vary with time, so that the time derivative of the volume integral vanishes unless either β or ρ varies with time (unsteady flow).

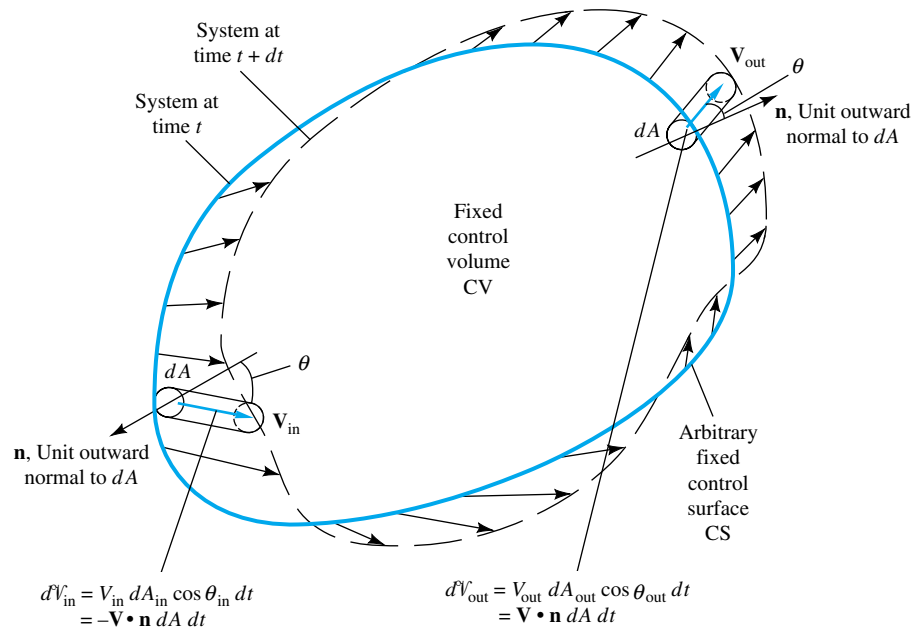

Fig. 3.4 Generalization of Fig. 3.3 to an arbitrary control volume with an arbitrary flow pattern.

Equation (3.10) expresses the basic formula that a system derivative equals the rate of change of B within the control volume plus the flux of B out of the control surface minus the flux of B into the control surface. The quantity B (or β) may be any vector or scalar property of the fluid. Two alternate forms are possible for the flux terms. First we may notice that $V \cos \theta$ is the component of V normal to the area element of the control surface. Thus we can write

$$\text{Flux terms} = \int_{CS} \beta \rho V_n dA_{out} - \int_{CS} \beta \rho V_n dA_{in} = \int_{CS} \beta dm_{out} - \int_{CS} \beta dm_{in} \quad (3.11a)$$

where $dm = \rho V_n dA$ is the differential mass flux through the surface. Form (3.11a) helps visualize what is being calculated.

A second alternate form offers elegance and compactness as advantages. If \mathbf{n} is defined as the *outward* normal unit vector everywhere on the control surface, then $\mathbf{V} \cdot \mathbf{n} = V_n$ for outflow and $\mathbf{V} \cdot \mathbf{n} = -V_n$ for inflow. Therefore the flux terms can be represented by a single integral involving $\mathbf{V} \cdot \mathbf{n}$ which accounts for both positive outflow and negative inflow

$$\text{Flux terms} = \int_{CS} \beta \rho (\mathbf{V} \cdot \mathbf{n}) dA \quad (3.11b)$$

The compact form of the Reynolds transport theorem is thus

$$\frac{d}{dt} (B_{\text{system}}) = \frac{d}{dt} \left(\int_{CV} \beta \rho dV \right) + \int_{CS} \beta \rho (\mathbf{V} \cdot \mathbf{n}) dA \quad (3.12)$$

This is beautiful but only occasionally useful, when the coordinate system is ideally suited to the control volume selected. Otherwise the computations are easier when the flux of B out is added and the flux of B in is subtracted, according to (3.10) or (3.11a).

The time-derivative term can be written in the equivalent form

$$\frac{d}{dt} \left(\int_{\text{CV}} \beta \rho \, d^3\mathcal{V} \right) = \int_{\text{CV}} \frac{\partial}{\partial t} (\beta \rho) \, d^3\mathcal{V} \quad (3.13)$$

for the fixed control volume since the volume elements do not vary.

Control Volume Moving at Constant Velocity

If the control volume is moving uniformly at velocity \mathbf{V}_s , as in Fig. 3.2*b*, an observer fixed to the control volume will see a relative velocity \mathbf{V}_r of fluid crossing the control surface, defined by

$$\mathbf{V}_r = \mathbf{V} - \mathbf{V}_s \quad (3.14)$$

where \mathbf{V} is the fluid velocity relative to the same coordinate system in which the control volume motion \mathbf{V}_s is observed. Note that Eq. (3.14) is a vector subtraction. The flux terms will be proportional to \mathbf{V}_r , but the volume integral is unchanged because the control volume moves as a fixed shape without deforming. The Reynolds transport theorem for this case of a uniformly moving control volume is

$$\frac{d}{dt} (B_{\text{sys}}) = \frac{d}{dt} \left(\int_{\text{CV}} \beta \rho \, d^3\mathcal{V} \right) + \int_{\text{CS}} \beta \rho (\mathbf{V}_r \cdot \mathbf{n}) \, dA \quad (3.15)$$

which reduces to Eq. (3.12) if $\mathbf{V}_s \equiv 0$.

Control Volume of Constant Shape but Variable Velocity⁴

If the control volume moves with a velocity $\mathbf{V}_s(t)$ which retains its shape, then the volume elements do not change with time but the boundary relative velocity $\mathbf{V}_r = \mathbf{V}(\mathbf{r}, t) - \mathbf{V}_s(t)$ becomes a somewhat more complicated function. Equation (3.15) is unchanged in form, but the area integral may be more laborious to evaluate.

Arbitrarily Moving and Deformable Control Volume⁵

The most general situation is when the control volume is both moving and deforming arbitrarily, as illustrated in Fig. 3.5. The flux of volume across the control surface is again proportional to the relative normal velocity component $\mathbf{V}_r \cdot \mathbf{n}$, as in Eq. (3.15). However, since the control surface has a deformation, its velocity $\mathbf{V}_s = \mathbf{V}_s(\mathbf{r}, t)$, so that the relative velocity $\mathbf{V}_r = \mathbf{V}(\mathbf{r}, t) - \mathbf{V}_s(\mathbf{r}, t)$ is or can be a complicated function, even though the flux integral is the same as in Eq. (3.15). Meanwhile, the volume integral in Eq. (3.15) must allow the volume elements to distort with time. Thus the time derivative must be applied *after* integration. For the deforming control volume, then, the transport theorem takes the form

$$\frac{d}{dt} (B_{\text{sys}}) = \frac{d}{dt} \left(\int_{\text{CV}} \beta \rho \, d^3\mathcal{V} \right) + \int_{\text{CS}} \beta \rho (\mathbf{V}_r \cdot \mathbf{n}) \, dA \quad (3.16)$$

This is the most general case, which we can compare with the equivalent form for a fixed control volume

⁴This section may be omitted without loss of continuity.

⁵This section may be omitted without loss of continuity.

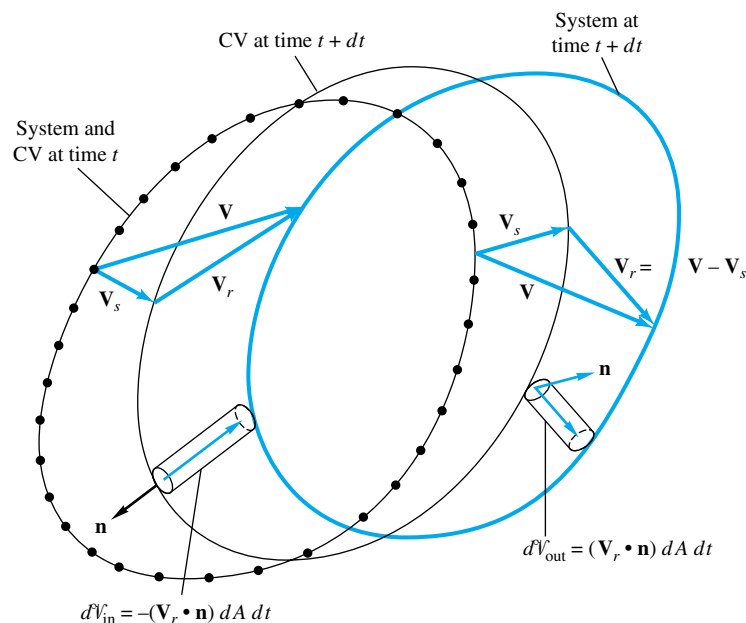

Fig. 3.5 Relative-velocity effects between a system and a control volume when both move and deform. The system boundaries move at velocity \mathbf{V} , and the control surface moves at velocity \mathbf{V}_s .

$$\frac{d}{dt} (B_{\text{system}}) = \int_{\text{CV}} \frac{\partial}{\partial t} (\beta\rho) d^3V + \int_{\text{CS}} \beta\rho(\mathbf{V} \cdot \mathbf{n}) dA \quad (3.17)$$

The moving and deforming control volume, Eq. (3.16), contains only two complications: (1) The time derivative of the first integral on the right must be taken outside, and (2) the second integral involves the *relative* velocity \mathbf{V}_r between the fluid system and the control surface. These differences and mathematical subtleties are best shown by examples.

One-Dimensional Flux-Term Approximations

In many applications, the flow crosses the boundaries of the control surface only at certain simplified inlets and exits which are approximately *one-dimensional*; i.e., the flow properties are nearly uniform over the cross section of the inlet or exit. Then the double-integral flux terms required in Eq. (3.16) reduce to a simple sum of positive (exit) and negative (inlet) product terms involving the flow properties at each cross section

$$\int_{\text{CS}} \beta\rho(\mathbf{V}_r \cdot \mathbf{n}) dA = \sum (\beta_i\rho_i V_{r_i} A_i)_{\text{out}} - \sum (\beta_i\rho_i V_{r_i} A_i)_{\text{in}} \quad (3.18)$$

An example of this situation is shown in Fig. 3.6. There are inlet flows at sections 1 and 4 and outflows at sections 2, 3, and 5. For this particular problem Eq. (3.18) would be

$$\int_{\text{CS}} \beta\rho(\mathbf{V}_r \cdot \mathbf{n}) dA = \beta_2\rho_2 V_{r2} A_2 + \beta_3\rho_3 V_{r3} A_3 + \beta_5\rho_5 V_{r5} A_5 - \beta_1\rho_1 V_{r1} A_1 - \beta_4\rho_4 V_{r4} A_4 \quad (3.19)$$

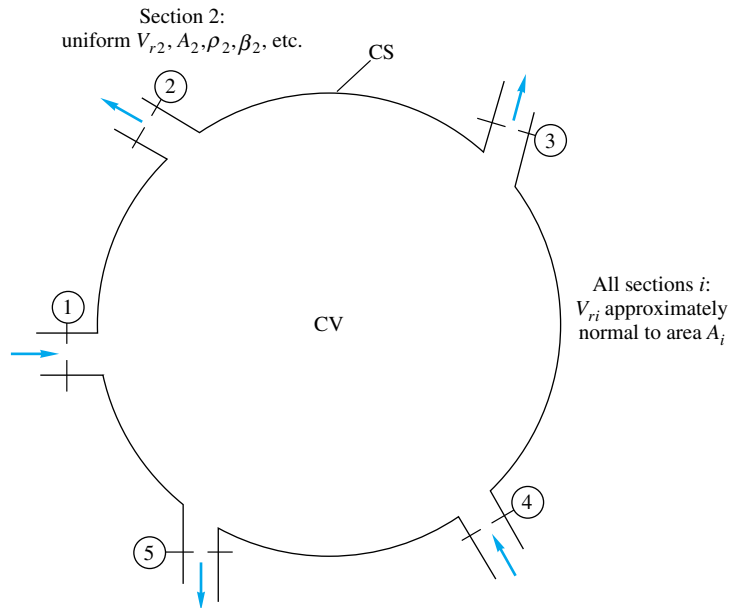
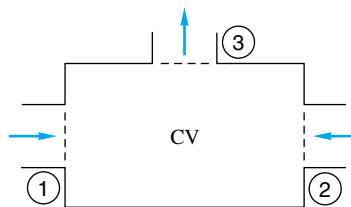

Fig. 3.6 A control volume with simplified one-dimensional inlets and exits.

with no contribution from any other portion of the control surface because there is no flow across the boundary.

EXAMPLE 3.1

A fixed control volume has three one-dimensional boundary sections, as shown in Fig. E3.1. The flow within the control volume is steady. The flow properties at each section are tabulated below. Find the rate of change of energy of the system which occupies the control volume at this instant.



E3.1

Section	Type	ρ , kg/m ³	V , m/s	A , m ²	e , J/kg
1	Inlet	800	5.0	2.0	300
2	Inlet	800	8.0	3.0	100
3	Outlet	800	17.0	2.0	150

Solution

The property under study here is energy, and so $B = E$ and $\beta = dE/dm = e$, the energy per unit mass. Since the control volume is fixed, Eq. (3.17) applies:

$$\left(\frac{dE}{dt}\right)_{\text{syst}} = \int_{\text{CV}} \frac{\partial}{\partial t} (e\rho) d^3V + \int_{\text{CS}} e\rho(\mathbf{V} \cdot \mathbf{n}) dA$$

The flow within is steady, so that $\partial(e\rho)/\partial t \equiv 0$ and the volume integral vanishes. The area integral consists of two inlet sections and one outlet section, as given in the table

$$\left(\frac{dE}{dt}\right)_{\text{syst}} = -e_1\rho_1A_1V_1 - e_2\rho_2A_2V_2 + e_3\rho_3A_3V_3$$

Introducing the numerical values from the table, we have

$$\begin{aligned} \left(\frac{dE}{dt}\right)_{\text{sys}} &= -(300 \text{ J/kg})(800 \text{ kg/m}^3)(2 \text{ m}^2)(5 \text{ m/s}) - 100(800)(3)(8) + 150(800)(2)(17) \\ &= (-2,400,000 - 1,920,000 + 4,080,000) \text{ J/s} \\ &= -240,000 \text{ J/s} = -0.24 \text{ MJ/s} \end{aligned} \quad \text{Ans.}$$

Thus the system is losing energy at the rate of $0.24 \text{ MJ/s} = 0.24 \text{ MW}$. Since we have accounted for all fluid energy crossing the boundary, we conclude from the first law that there must be heat loss through the control surface or the system must be doing work on the environment through some device not shown. Notice that the use of SI units leads to a consistent result in joules per second without any conversion factors. We promised in Chap. 1 that this would be the case.

Note: This problem involves energy, but suppose we check the balance of mass also. Then $B = \text{mass } m$, and $B = dm/dm = \text{unity}$. Again the volume integral vanishes for steady flow, and Eq. (3.17) reduces to

$$\begin{aligned} \left(\frac{dm}{dt}\right)_{\text{sys}} &= \int_{\text{CS}} \rho(\mathbf{V} \cdot \mathbf{n}) dA = -\rho_1 A_1 V_1 - \rho_2 A_2 V_2 + \rho_3 A_3 V_3 \\ &= -(800 \text{ kg/m}^3)(2 \text{ m}^2)(5 \text{ m/s}) - 800(3)(8) + 800(17)(2) \\ &= (-8000 - 19,200 + 27,200) \text{ kg/s} = 0 \text{ kg/s} \end{aligned}$$

Thus the system mass does not change, which correctly expresses the law of conservation of system mass, Eq. (3.1).

EXAMPLE 3.2

The balloon in Fig. E3.2 is being filled through section 1, where the area is A_1 , velocity is V_1 , and fluid density is ρ_1 . The average density within the balloon is $\rho_b(t)$. Find an expression for the rate of change of system mass within the balloon at this instant.

Solution

It is convenient to define a deformable control surface just outside the balloon, expanding at the same rate $R(t)$. Equation (3.16) applies with $V_r = 0$ on the balloon surface and $V_r = V_1$ at the pipe entrance. For mass change, we take $B = m$ and $\beta = dm/dm = 1$. Equation (3.16) becomes

$$\left(\frac{dm}{dt}\right)_{\text{sys}} = \frac{d}{dt} \left(\int_{\text{CS}} \rho d^3V \right) + \int_{\text{CS}} \rho(\mathbf{V}_r \cdot \mathbf{n}) dA$$

Mass flux occurs only at the inlet, so that the control-surface integral reduces to the single negative term $-\rho_1 A_1 V_1$. The fluid mass within the control volume is approximately the average density times the volume of a sphere. The equation thus becomes

$$\left(\frac{dm}{dt}\right)_{\text{sys}} = \frac{d}{dt} \left(\rho_b \frac{4}{3} \pi R^3 \right) - \rho_1 A_1 V_1 \quad \text{Ans.}$$

This is the desired result for the system mass rate of change. Actually, by the conservation law

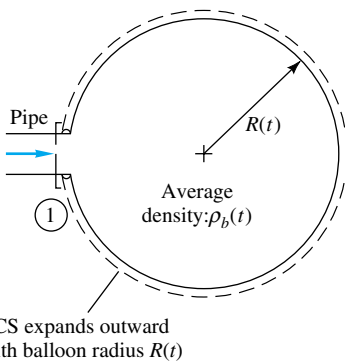

E3.2

(3.1), this change must be zero. Thus the balloon density and radius are related to the inlet mass flux by

$$\frac{d}{dt} (\rho_b R^3) = \frac{3}{4\pi} \rho_1 A_1 V_1$$

This is a first-order differential equation which could form part of an engineering analysis of balloon inflation. It cannot be solved without further use of mechanics and thermodynamics to relate the four unknowns ρ_b , ρ_1 , V_1 , and R . The pressure and temperature and the elastic properties of the balloon would also have to be brought into the analysis.

For advanced study, many more details of the analysis of deformable control volumes can be found in Hansen [4] and Potter and Foss [5].

3.3 Conservation of Mass

The Reynolds transport theorem, Eq. (3.16) or (3.17), establishes a relation between system rates of change and control-volume surface and volume integrals. But system derivatives are related to the basic laws of mechanics, Eqs. (3.1) to (3.5). Eliminating system derivatives between the two gives the control-volume, or *integral*, forms of the laws of mechanics of fluids. The dummy variable B becomes, respectively, mass, linear momentum, angular momentum, and energy.

For conservation of mass, as discussed in Examples 3.1 and 3.2, $B = m$ and $\beta = dm/dm = 1$. Equation (3.1) becomes

$$\left(\frac{dm}{dt} \right)_{\text{syst}} = 0 = \frac{d}{dt} \left(\int_{\text{CV}} \rho \, d\mathcal{V} \right) + \int_{\text{CS}} \rho (\mathbf{V}_{\mathbf{r}} \cdot \mathbf{n}) \, dA \quad (3.20)$$

This is the integral mass-conservation law for a deformable control volume. For a fixed control volume, we have

$$\int_{\text{CV}} \frac{\partial \rho}{\partial t} \, d\mathcal{V} + \int_{\text{CS}} \rho (\mathbf{V} \cdot \mathbf{n}) \, dA = 0 \quad (3.21)$$

If the control volume has only a number of one-dimensional inlets and outlets, we can write

$$\int_{\text{CV}} \frac{\partial \rho}{\partial t} \, d\mathcal{V} + \sum_i (\rho_i A_i V_i)_{\text{out}} - \sum_i (\rho_i A_i V_i)_{\text{in}} = 0 \quad (3.22)$$

Other special cases occur. Suppose that the flow within the control volume is steady; then $\partial \rho / \partial t \equiv 0$, and Eq. (3.21) reduces to

$$\int_{\text{CS}} \rho (\mathbf{V} \cdot \mathbf{n}) \, dA = 0 \quad (3.23)$$

This states that in steady flow the mass flows entering and leaving the control volume must balance exactly.⁶ If, further, the inlets and outlets are one-dimensional, we have

⁶Throughout this section we are neglecting *sources* or *sinks* of mass which might be embedded in the control volume. Equations (3.20) and (3.21) can readily be modified to add source and sink terms, but this is rarely necessary.

for steady flow

$$\sum_i (\rho_i A_i V_i)_{\text{in}} = \sum_i (\rho_i A_i V_i)_{\text{out}} \quad (3.24)$$

This simple approximation is widely used in engineering analyses. For example, referring to Fig. 3.6, we see that if the flow in that control volume is steady, the three outlet mass fluxes balance the two inlets:

$$\begin{aligned} \text{Outflow} &= \text{inflow} \\ \rho_2 A_2 V_2 + \rho_3 A_3 V_3 + \rho_5 A_5 V_5 &= \rho_1 A_1 V_1 + \rho_4 A_4 V_4 \end{aligned} \quad (3.25)$$

The quantity ρAV is called the *mass flow* \dot{m} passing through the one-dimensional cross section and has consistent units of kilograms per second (or slugs per second) for SI (or BG) units. Equation (3.25) can be rewritten in the short form

$$\dot{m}_2 + \dot{m}_3 + \dot{m}_5 = \dot{m}_1 + \dot{m}_4 \quad (3.26)$$

and, in general, the steady-flow–mass-conservation relation (3.23) can be written as

$$\sum_i (\dot{m}_i)_{\text{out}} = \sum_i (\dot{m}_i)_{\text{in}} \quad (3.27)$$

If the inlets and outlets are not one-dimensional, one has to compute \dot{m} by integration over the section

$$\dot{m}_{\text{cs}} = \int_{\text{cs}} \rho(\mathbf{V} \cdot \mathbf{n}) \, dA \quad (3.28)$$

where “cs” stands for cross section. An illustration of this is given in Example 3.4.

Incompressible Flow

Still further simplification is possible if the fluid is incompressible, which we may define as having density variations which are negligible in the mass-conservation requirement.⁷As we saw in Chap. 1, all liquids are nearly incompressible, and gas flows can *behave* as if they were incompressible, particularly if the gas velocity is less than about 30 percent of the speed of sound of the gas.

Again consider the fixed control volume. If the fluid is nearly incompressible, $\partial\rho/\partial t$ is negligible and the volume integral in Eq. (3.21) may be neglected, after which the density can be slipped outside the surface integral and divided out since it is nonzero. The result is a conservation law for incompressible flows, whether steady or unsteady:

$$\int_{\text{CS}} (\mathbf{V} \cdot \mathbf{n}) \, dA = 0 \quad (3.29)$$

If the inlets and outlets are one-dimensional, we have

$$\sum_i (V_i A_i)_{\text{out}} = \sum_i (V_i A_i)_{\text{in}} \quad (3.30)$$

or

$$\sum Q_{\text{out}} = \sum Q_{\text{in}}$$

where $Q_i = V_i A_i$ is called the *volume flow* passing through the given cross section.

⁷Be warned that there is subjectivity in specifying incompressibility. Oceanographers consider a 0.1 percent density variation very significant, while aerodynamicists often neglect density variations in highly compressible, even hypersonic, gas flows. Your task is to justify the incompressible approximation when you make it.

Again, if consistent units are used, $Q = VA$ will have units of cubic meters per second (SI) or cubic feet per second (BG). If the cross section is not one-dimensional, we have to integrate

$$Q_{CS} = \int_{CS} (\mathbf{V} \cdot \mathbf{n}) dA \quad (3.31)$$

Equation (3.31) allows us to define an *average velocity* V_{av} which, when multiplied by the section area, gives the correct volume flow

$$V_{av} = \frac{Q}{A} = \frac{1}{A} \int (\mathbf{V} \cdot \mathbf{n}) dA \quad (3.32)$$

This could be called the *volume-average velocity*. If the density varies across the section, we can define an average density in the same manner:

$$\rho_{av} = \frac{1}{A} \int \rho dA \quad (3.33)$$

But the mass flow would contain the product of density and velocity, and the average product $(\rho V)_{av}$ would in general have a different value from the product of the averages

$$(\rho V)_{av} = \frac{1}{A} \int \rho(\mathbf{V} \cdot \mathbf{n}) dA \approx \rho_{av} V_{av} \quad (3.34)$$

We illustrate average velocity in Example 3.4. We can often neglect the difference or, if necessary, use a correction factor between mass average and volume average.

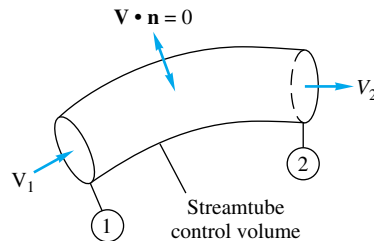

E3.3

EXAMPLE 3.3

Write the conservation-of-mass relation for steady flow through a streamtube (flow everywhere parallel to the walls) with a single one-dimensional exit 1 and inlet 2 (Fig. E3.3).

Solution

For steady flow Eq. (3.24) applies with the single inlet and exit

$$\dot{m} = \rho_1 A_1 V_1 = \rho_2 A_2 V_2 = \text{const}$$

Thus, in a streamtube in steady flow, the mass flow is constant across every section of the tube. If the density is constant, then

$$Q = A_1 V_1 = A_2 V_2 = \text{const} \quad \text{or} \quad V_2 = \frac{A_1}{A_2} V_1$$

The volume flow is constant in the tube in steady incompressible flow, and the velocity increases as the section area decreases. This relation was derived by Leonardo da Vinci in 1500.

EXAMPLE 3.4

For steady viscous flow through a circular tube (Fig. E3.4), the axial velocity profile is given approximately by

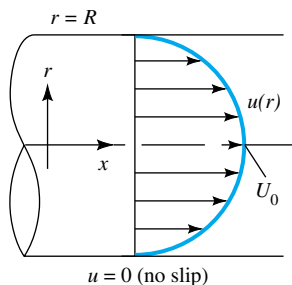

E3.4

$$u = U_0 \left(1 - \frac{r}{R}\right)^m$$

so that u varies from zero at the wall ($r = R$), or no slip, up to a maximum $u = U_0$ at the centerline $r = 0$. For highly viscous (laminar) flow $m \approx \frac{1}{2}$, while for less viscous (turbulent) flow $m \approx \frac{1}{7}$. Compute the average velocity if the density is constant.

Solution

The average velocity is defined by Eq. (3.32). Here $\mathbf{V} = u\mathbf{i}$ and $\mathbf{n} = \mathbf{i}$, and thus $\mathbf{V} \cdot \mathbf{n} = u$. Since the flow is symmetric, the differential area can be taken as a circular strip $dA = 2\pi r dr$. Equation (3.32) becomes

$$V_{\text{av}} = \frac{1}{A} \int u dA = \frac{1}{\pi R^2} \int_0^R U_0 \left(1 - \frac{r}{R}\right)^m 2\pi r dr$$

$$\text{or} \quad V_{\text{av}} = U_0 \frac{2}{(1+m)(2+m)} \quad \text{Ans.}$$

For the laminar-flow approximation, $m \approx \frac{1}{2}$ and $V_{\text{av}} \approx 0.53U_0$. (The exact laminar theory in Chap. 6 gives $V_{\text{av}} = 0.50U_0$.) For turbulent flow, $m \approx \frac{1}{7}$ and $V_{\text{av}} \approx 0.82U_0$. (There is no exact turbulent theory, and so we accept this approximation.) The turbulent velocity profile is more uniform across the section, and thus the average velocity is only slightly less than maximum.

EXAMPLE 3.5

Consider the constant-density velocity field

$$u = \frac{V_0 x}{L} \quad v = 0 \quad w = -\frac{V_0 z}{L}$$

similar to Example 1.10. Use the triangular control volume in Fig. E3.5, bounded by $(0, 0)$, (L, L) , and $(0, L)$, with depth b into the paper. Compute the volume flow through sections 1, 2, and 3, and compare to see whether mass is conserved.

Solution

The velocity field everywhere has the form $\mathbf{V} = u\mathbf{i} + w\mathbf{k}$. This must be evaluated along each section. We save section 2 until last because it looks tricky. Section 1 is the plane $z = L$ with depth b . The unit outward normal is $\mathbf{n} = \mathbf{k}$, as shown. The differential area is a strip of depth b varying with x : $dA = b dx$. The normal velocity is

$$(\mathbf{V} \cdot \mathbf{n})_1 = (u\mathbf{i} + w\mathbf{k}) \cdot \mathbf{k} = w|_1 = -\frac{V_0 z}{L} \Big|_{z=L} = -V_0$$

The volume flow through section 1 is thus, from Eq. (3.31),

$$Q_1 = \int_1 (\mathbf{V} \cdot \mathbf{n}) dA = \int_0^L (-V_0)b dx = -V_0 b L \quad \text{Ans. 1}$$

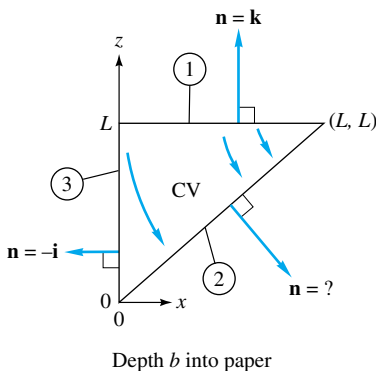

E3.5

Since this is negative, section 1 is a net inflow. Check the units: $V_0 b L$ is a velocity times an area; OK.

Section 3 is the plane $x = 0$ with depth b . The unit normal is $\mathbf{n} = -\mathbf{i}$, as shown, and $dA = b dz$. The normal velocity is

$$(\mathbf{V} \cdot \mathbf{n})_3 = (\mathbf{i}u + \mathbf{k}w) \cdot (-\mathbf{i}) = -u \Big|_{s=0} = -\frac{V_0 x}{L} \Big|_{s=0} = 0 \quad \text{Ans. 3}$$

Thus $V_n \equiv 0$ all along section 3; hence $Q_3 = 0$.

Finally, section 2 is the plane $x = z$ with depth b . The normal direction is to the right \mathbf{i} and down $-\mathbf{k}$ but must have *unit* value; thus $\mathbf{n} = (1/\sqrt{2})(\mathbf{i} - \mathbf{k})$. The differential area is either $dA = \sqrt{2}b dx$ or $dA = \sqrt{2}b dz$. The normal velocity is

$$\begin{aligned} (\mathbf{V} \cdot \mathbf{n})_2 &= (\mathbf{i}u + \mathbf{k}w) \cdot \frac{1}{\sqrt{2}}(\mathbf{i} - \mathbf{k}) = \frac{1}{\sqrt{2}}(u - w)_2 \\ &= \frac{1}{\sqrt{2}} \left[V_0 \frac{x}{L} - \left(-V_0 \frac{z}{L} \right) \right]_{x=z} = \frac{\sqrt{2}V_0 x}{L} \quad \text{or} \quad \frac{\sqrt{2}V_0 z}{L} \end{aligned}$$

Then the volume flow through section 2 is

$$Q_2 = \int_2 (\mathbf{V} \cdot \mathbf{n}) dA = \int_0^L \frac{\sqrt{2}V_0 x}{L} (\sqrt{2}b dx) = V_0 b L \quad \text{Ans. 2}$$

This answer is positive, indicating an outflow. These are the desired results. We should note that the volume flow is zero through the front and back triangular faces of the prismatic control volume because $V_n = v = 0$ on those faces.

The sum of the three volume flows is

$$Q_1 + Q_2 + Q_3 = -V_0 b L + V_0 b L + 0 = 0$$

Mass is conserved in this constant-density flow, and there are no net sources or sinks within the control volume. This is a very realistic flow, as described in Example 1.10

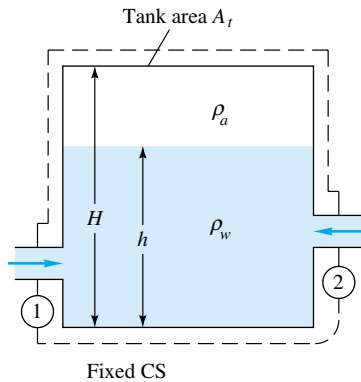

E3.6

EXAMPLE 3.6

The tank in Fig. E3.6 is being filled with water by two one-dimensional inlets. Air is trapped at the top of the tank. The water height is h . (a) Find an expression for the change in water height dh/dt . (b) Compute dh/dt if $D_1 = 1$ in, $D_2 = 3$ in, $V_1 = 3$ ft/s, $V_2 = 2$ ft/s, and $A_t = 2$ ft², assuming water at 20°C.

Solution

Part (a) A suggested control volume encircles the tank and cuts through the two inlets. The flow within is unsteady, and Eq. (3.22) applies with no outlets and two inlets:

$$\frac{d}{dt} \left(\int_{\text{CV}} \rho d^3V \right) - \rho_1 A_1 V_1 - \rho_2 A_2 V_2 = 0 \quad (1)$$

Now if A_t is the tank cross-sectional area, the unsteady term can be evaluated as follows:

$$\frac{d}{dt} \left(\int_{\text{CV}} \rho d^3V \right) = \frac{d}{dt} (\rho_w A_t h) + \frac{d}{dt} [\rho_a A_t (H - h)] = \rho_w A_t \frac{dh}{dt} \quad (2)$$

The ρ_a term vanishes because it is the rate of change of air mass and is zero because the air is trapped at the top. Substituting (2) into (1), we find the change of water height

$$\frac{dh}{dt} = \frac{\rho_1 A_1 V_1 + \rho_2 A_2 V_2}{\rho_w A_t} \quad \text{Ans. (a)}$$

For water, $\rho_1 = \rho_2 = \rho_w$, and this result reduces to

$$\frac{dh}{dt} = \frac{A_1 V_1 + A_2 V_2}{A_t} = \frac{Q_1 + Q_2}{A_t} \quad (3)$$

Part (b) The two inlet volume flows are

$$Q_1 = A_1 V_1 = \frac{1}{4} \pi \left(\frac{1}{12} \text{ ft}\right)^2 (3 \text{ ft/s}) = 0.016 \text{ ft}^3/\text{s}$$

$$Q_2 = A_2 V_2 = \frac{1}{4} \pi \left(\frac{3}{12} \text{ ft}\right)^2 (2 \text{ ft/s}) = 0.098 \text{ ft}^3/\text{s}$$

Then, from Eq. (3),

$$\frac{dh}{dt} = \frac{(0.016 + 0.098) \text{ ft}^3/\text{s}}{2 \text{ ft}^2} = 0.057 \text{ ft/s} \quad \text{Ans. (b)}$$

Suggestion: Repeat this problem with the top of the tank open.

An illustration of a mass balance with a deforming control volume has already been given in Example 3.2.

The control-volume mass relations, Eq. (3.20) or (3.21), are fundamental to all fluid-flow analyses. They involve only velocity and density. Vector directions are of no consequence except to determine the normal velocity at the surface and hence whether the flow is *in* or *out*. Although your specific analysis may concern forces or moments or energy, you must always make sure that mass is balanced as part of the analysis; otherwise the results will be unrealistic and probably rotten. We shall see in the examples which follow how mass conservation is constantly checked in performing an analysis of other fluid properties.

3.4 The Linear Momentum Equation

In Newton's law, Eq. (3.2), the property being differentiated is the linear momentum $m\mathbf{V}$. Therefore our dummy variable is $\mathbf{B} = m\mathbf{V}$ and $\boldsymbol{\beta} = d\mathbf{B}/dm = \mathbf{V}$, and application of the Reynolds transport theorem gives the linear-momentum relation for a deformable control volume

$$\frac{d}{dt} (m\mathbf{V})_{\text{sys}} = \sum \mathbf{F} = \frac{d}{dt} \left(\int_{\text{CV}} \mathbf{V} \rho \, d\mathcal{V} \right) + \int_{\text{CS}} \mathbf{V} \rho (\mathbf{V}_r \cdot \mathbf{n}) \, dA \quad (3.35)$$

The following points concerning this relation should be strongly emphasized:

1. The term \mathbf{V} is the fluid velocity relative to an *inertial* (nonaccelerating) coordinate system; otherwise Newton's law must be modified to include noninertial relative-acceleration terms (see the end of this section).
2. The term $\sum \mathbf{F}$ is the *vector* sum of all forces acting on the control-volume material considered as a free body; i.e., it includes surface forces on all fluids and

solids cut by the control surface plus all body forces (gravity and electromagnetic) acting on the masses within the control volume.

3. The entire equation is a vector relation; both the integrals are vectors due to the term \mathbf{V} in the integrands. The equation thus has three components. If we want only, say, the x component, the equation reduces to

$$\sum F_x = \frac{d}{dt} \left(\int_{\text{CV}} u\rho \, d^3V \right) + \int_{\text{CS}} u\rho(\mathbf{V}_r \cdot \mathbf{n}) \, dA \quad (3.36)$$

and similarly, $\sum F_y$ and $\sum F_z$ would involve v and w , respectively. Failure to account for the vector nature of the linear-momentum relation (3.35) is probably the greatest source of student error in control-volume analyses.

For a fixed control volume, the relative velocity $\mathbf{V}_r \equiv \mathbf{V}$, and

$$\sum \mathbf{F} = \frac{d}{dt} \left(\int_{\text{CV}} \mathbf{V}\rho \, d^3V \right) + \int_{\text{CS}} \mathbf{V}\rho(\mathbf{V} \cdot \mathbf{n}) \, dA \quad (3.37)$$

Again we stress that this is a vector relation and that \mathbf{V} must be an inertial-frame velocity. Most of the momentum analyses in this text are concerned with Eq. (3.37).

One-Dimensional Momentum Flux

By analogy with the term *mass flow* used in Eq. (3.28), the surface integral in Eq. (3.37) is called the *momentum-flux term*. If we denote momentum by \mathbf{M} , then

$$\dot{\mathbf{M}}_{\text{CS}} = \int_{\text{sec}} \mathbf{V}\rho(\mathbf{V} \cdot \mathbf{n}) \, dA \quad (3.38)$$

Because of the dot product, the result will be negative for inlet momentum flux and positive for outlet flux. If the cross section is one-dimensional, \mathbf{V} and ρ are uniform over the area and the integrated result is

$$\dot{\mathbf{M}}_{\text{sec}i} = \mathbf{V}_i(\rho_i V_{ni} A_i) = \dot{m}_i \mathbf{V}_i \quad (3.39)$$

for outlet flux and $-\dot{m}_i \mathbf{V}_i$ for inlet flux. Thus if the control volume has only one-dimensional inlets and outlets, Eq. (3.37) reduces to

$$\sum \mathbf{F} = \frac{d}{dt} \left(\int_{\text{CV}} \mathbf{V}\rho \, d^3V \right) + \sum (\dot{m}_i \mathbf{V}_i)_{\text{out}} - \sum (\dot{m}_i \mathbf{V}_i)_{\text{in}} \quad (3.40)$$

This is a commonly used approximation in engineering analyses. It is crucial to realize that we are dealing with vector sums. Equation (3.40) states that the net vector force on a fixed control volume equals the rate of change of vector momentum within the control volume plus the vector sum of outlet momentum fluxes minus the vector sum of inlet fluxes.

Net Pressure Force on a Closed Control Surface

Generally speaking, the surface forces on a control volume are due to (1) forces exposed by cutting through solid bodies which protrude through the surface and (2) forces due to pressure and viscous stresses of the surrounding fluid. The computation of pressure force is relatively simple, as shown in Fig. 3.7. Recall from Chap. 2 that the external pressure force on a surface is normal to the surface and *inward*. Since the unit vector \mathbf{n} is defined as *outward*, one way to write the pressure force is

$$\mathbf{F}_{\text{press}} = \int_{\text{CS}} p(-\mathbf{n}) \, dA \quad (3.41)$$

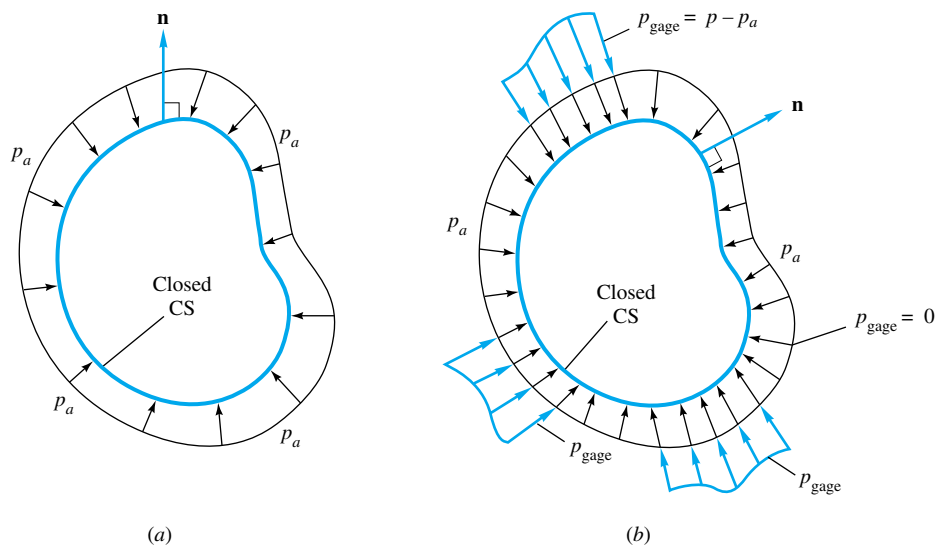

Fig. 3.7 Pressure-force computation by subtracting a uniform distribution: (a) uniform pressure, $\mathbf{F} = -p_a \int \mathbf{n} dA \equiv 0$; (b) nonuniform pressure, $\mathbf{F} = -\int (p - p_a) \mathbf{n} dA$.

Now if the pressure has a uniform value p_a all around the surface, as in Fig. 3.7a, the net pressure force is zero

$$\mathbf{F}_{\text{UP}} = \int p_a (-\mathbf{n}) dA = -p_a \int \mathbf{n} dA \equiv 0 \quad (3.42)$$

where the subscript UP stands for uniform pressure. This result is *independent of the shape of the surface*⁸ as long as the surface is closed and all our control volumes are closed. Thus a seemingly complicated pressure-force problem can be simplified by subtracting any convenient uniform pressure p_a and working only with the pieces of gage pressure which remain, as illustrated in Fig. 3.7b. Thus Eq. (3.41) is entirely equivalent to

$$\mathbf{F}_{\text{press}} = \int_{\text{CS}} (p - p_a) (-\mathbf{n}) dA = \int_{\text{CS}} p_{\text{gage}} (-\mathbf{n}) dA$$

This trick can mean quite a saving in computation.

EXAMPLE 3.7

A control volume of a nozzle section has surface pressures of 40 lbf/in² absolute at section 1 and atmospheric pressure of 15 lbf/in² absolute at section 2 and on the external rounded part of the nozzle, as in Fig. E3.7a. Compute the net pressure force if $D_1 = 3$ in and $D_2 = 1$ in.

Solution

We do not have to bother with the outer surface if we subtract 15 lbf/in² from all surfaces. This leaves 25 lbf/in² gage at section 1 and 0 lbf/in² gage everywhere else, as in Fig. E3.7b.

⁸Can you prove this? It is a consequence of Gauss' theorem from vector analysis.

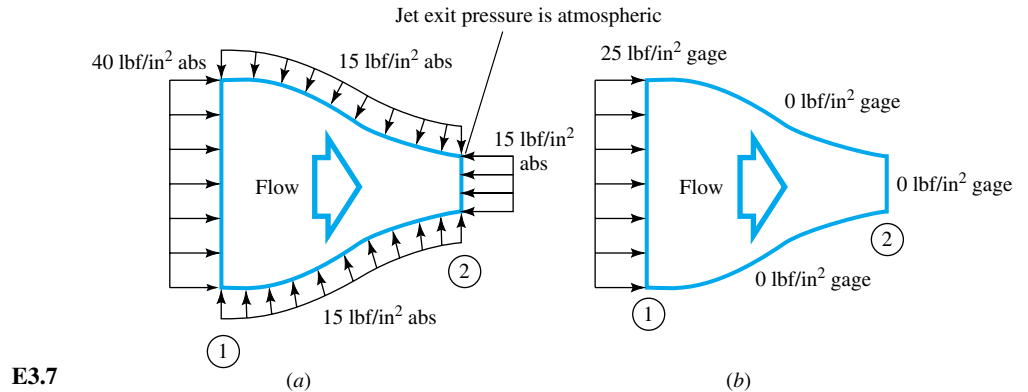

Then the net pressure force is computed from section 1 only

$$\mathbf{F} = p_{g1}(-\mathbf{n})_1 A_1 = (25 \text{ lbf/in}^2) \frac{\pi}{4} (3 \text{ in})^2 \mathbf{i} = 177 \mathbf{i} \text{ lbf} \quad \text{Ans.}$$

Notice that we did not change inches to feet in this case because, with pressure in pounds-force per square inch and area in square inches, the product gives force directly in pounds. More often, though, the change back to standard units is necessary and desirable. *Note:* This problem computes pressure force only. There are probably other forces involved in Fig. E3.7, e.g., nozzle-wall stresses in the cuts through sections 1 and 2 and the weight of the fluid within the control volume.

Pressure Condition at a Jet Exit

Figure E3.7 illustrates a pressure boundary condition commonly used for jet exit-flow problems. When a fluid flow leaves a confined internal duct and exits into an ambient “atmosphere,” its free surface is exposed to that atmosphere. Therefore the jet itself will essentially be at atmospheric pressure also. This condition was used at section 2 in Fig. E3.7.

Only two effects could maintain a pressure difference between the atmosphere and a free exit jet. The first is surface tension, Eq. (1.31), which is usually negligible. The second effect is a *supersonic* jet, which can separate itself from an atmosphere with expansion or compression waves (Chap. 9). For the majority of applications, therefore, we shall set the pressure in an exit jet as atmospheric.

EXAMPLE 3.8

A fixed control volume of a streamtube in steady flow has a uniform inlet flow (ρ_1, A_1, V_1) and a uniform exit flow (ρ_2, A_2, V_2), as shown in Fig. 3.8. Find an expression for the net force on the control volume.

Solution

Equation (3.40) applies with one inlet and exit

$$\sum \mathbf{F} = \dot{m}_2 \mathbf{V}_2 - \dot{m}_1 \mathbf{V}_1 = (\rho_2 A_2 V_2) \mathbf{V}_2 - (\rho_1 A_1 V_1) \mathbf{V}_1$$

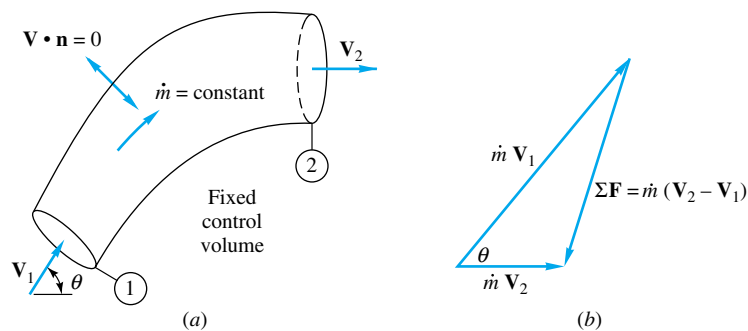

Fig. 3.8 Net force on a one-dimensional streamtube in steady flow: (a) streamtube in steady flow; (b) vector diagram for computing net force.

The volume-integral term vanishes for steady flow, but from conservation of mass in Example 3.3 we saw that

$$\dot{m}_1 = \dot{m}_2 = \dot{m} = \text{const}$$

Therefore a simple form for the desired result is

$$\sum \mathbf{F} = \dot{m} (\mathbf{V}_2 - \mathbf{V}_1) \quad \text{Ans.}$$

This is a *vector* relation and is sketched in Fig. 3.8b. The term $\sum \mathbf{F}$ represents the net force acting on the control volume due to all causes; it is needed to balance the change in momentum of the fluid as it turns and decelerates while passing through the control volume.

EXAMPLE 3.9

As shown in Fig. 3.9a, a fixed vane turns a water jet of area A through an angle θ without changing its velocity magnitude. The flow is steady, pressure is p_a everywhere, and friction on the vane is negligible. (a) Find the components F_x and F_y of the applied vane force. (b) Find expressions for the force magnitude F and the angle ϕ between F and the horizontal; plot them versus θ .

Solution

Part (a) The control volume selected in Fig. 3.9a cuts through the inlet and exit of the jet and through the vane support, exposing the vane force \mathbf{F} . Since there is no cut along the vane-jet interface,

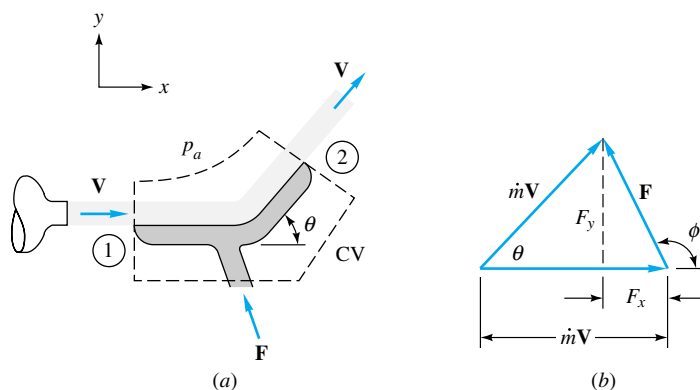

Fig. 3.9 Net applied force on a fixed jet-turning vane: (a) geometry of the vane turning the water jet; (b) vector diagram for the net force.

vane friction is internally self-canceling. The pressure force is zero in the uniform atmosphere. We neglect the weight of fluid and the vane weight within the control volume. Then Eq. (3.40) reduces to

$$\mathbf{F}_{\text{vane}} = \dot{m}_2 \mathbf{V}_2 - \dot{m}_1 \mathbf{V}_1$$

But the magnitude $V_1 = V_2 = V$ as given, and conservation of mass for the streamtube requires $\dot{m}_1 = \dot{m}_2 = \dot{m} = \rho AV$. The vector diagram for force and momentum change becomes an isosceles triangle with legs $\dot{m}V$ and base \mathbf{F} , as in Fig. 3.9*b*. We can readily find the force components from this diagram

$$F_x = \dot{m}V(\cos \theta - 1) \quad F_y = \dot{m}V \sin \theta \quad \text{Ans. (a)}$$

where $\dot{m}V = \rho AV^2$ for this case. This is the desired result.

Part (b) The force magnitude is obtained from part (a):

$$F = (F_x^2 + F_y^2)^{1/2} = \dot{m}V[\sin^2 \theta + (\cos \theta - 1)^2]^{1/2} = 2\dot{m}V \sin \frac{\theta}{2} \quad \text{Ans. (b)}$$

From the geometry of Fig. 3.9*b* we obtain

$$\phi = 180^\circ - \tan^{-1} \frac{F_y}{F_x} = 90^\circ + \frac{\theta}{2} \quad \text{Ans. (b)}$$

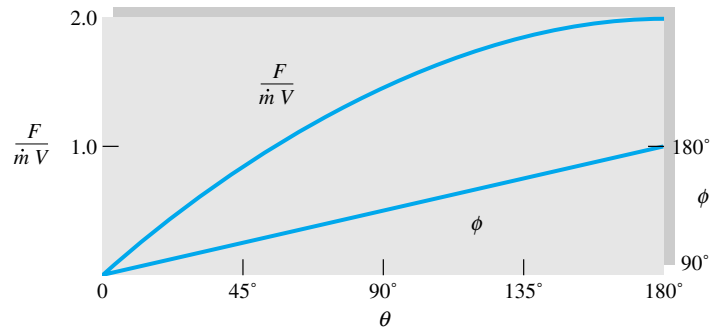

E3.9

These can be plotted versus θ as shown in Fig. E3.9. Two special cases are of interest. First, the maximum force occurs at $\theta = 180^\circ$, that is, when the jet is turned around and thrown back in the opposite direction with its momentum completely reversed. This force is $2\dot{m}V$ and acts to the left; that is, $\phi = 180^\circ$. Second, at very small turning angles ($\theta < 10^\circ$) we obtain approximately

$$F \approx \dot{m}V\theta \quad \phi \approx 90^\circ$$

The force is linearly proportional to the turning angle and acts nearly normal to the jet. This is the principle of a lifting vane, or airfoil, which causes a slight change in the oncoming flow direction and thereby creates a lift force normal to the basic flow.

EXAMPLE 3.10

A water jet of velocity V_j impinges normal to a flat plate which moves to the right at velocity V_c , as shown in Fig. 3.10*a*. Find the force required to keep the plate moving at constant velocity if the jet density is 1000 kg/m^3 , the jet area is 3 cm^2 , and V_j and V_c are 20 and 15 m/s, re-

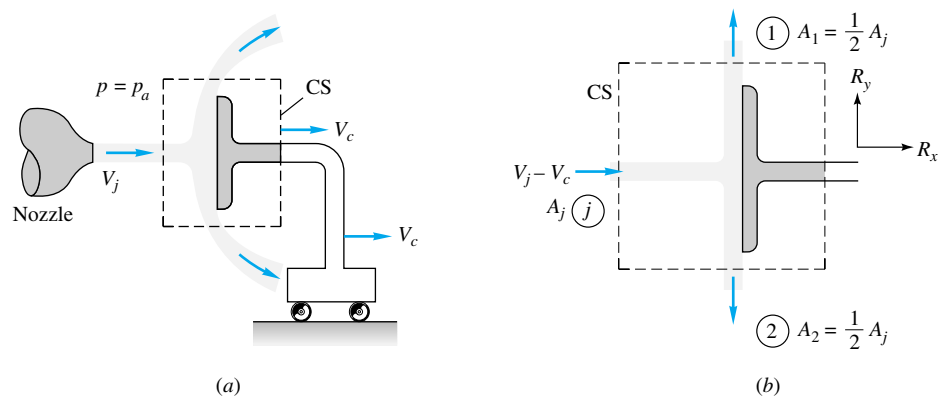

Fig. 3.10 Force on a plate moving at constant velocity: (a) jet striking a moving plate normally; (b) control volume fixed relative to the plate.

spectively. Neglect the weight of the jet and plate, and assume steady flow with respect to the moving plate with the jet splitting into an equal upward and downward half-jet.

Solution

The suggested control volume in Fig. 3.10a cuts through the plate support to expose the desired forces R_x and R_y . This control volume moves at speed V_c and thus is fixed relative to the plate, as in Fig. 3.10b. We must satisfy both mass and momentum conservation for the assumed steady-flow pattern in Fig. 3.10b. There are two outlets and one inlet, and Eq. (3.30) applies for mass conservation

$$\dot{m}_{\text{out}} = \dot{m}_{\text{in}}$$

$$\text{or} \quad \rho_1 A_1 V_1 + \rho_2 A_2 V_2 = \rho_j A_j (V_j - V_c) \quad (1)$$

We assume that the water is incompressible $\rho_1 = \rho_2 = \rho_j$, and we are given that $A_1 = A_2 = \frac{1}{2} A_j$. Therefore Eq. (1) reduces to

$$V_1 + V_2 = 2(V_j - V_c) \quad (2)$$

Strictly speaking, this is all that mass conservation tells us. However, from the symmetry of the jet deflection and the neglect of fluid weight, we conclude that the two velocities V_1 and V_2 must be equal, and hence (2) becomes

$$V_1 = V_2 = V_j - V_c \quad (3)$$

For the given numerical values, we have

$$V_1 = V_2 = 20 - 15 = 5 \text{ m/s}$$

Now we can compute R_x and R_y from the two components of momentum conservation. Equation (3.40) applies with the unsteady term zero

$$\sum F_x = R_x = \dot{m}_1 u_1 + \dot{m}_2 u_2 - \dot{m}_j u_j \quad (4)$$

where from the mass analysis, $\dot{m}_1 = \dot{m}_2 = \frac{1}{2} \dot{m}_j = \frac{1}{2} \rho_j A_j (V_j - V_c)$. Now check the flow directions at each section: $u_1 = u_2 = 0$, and $u_j = V_j - V_c = 5 \text{ m/s}$. Thus Eq. (4) becomes

$$R_x = -\dot{m}_j u_j = -[\rho_j A_j (V_j - V_c)](V_j - V_c) \quad (5)$$

For the given numerical values we have

$$R_x = -(1000 \text{ kg/m}^3)(0.0003 \text{ m}^2)(5 \text{ m/s})^2 = -7.5 \text{ (kg} \cdot \text{m/s}^2) = -7.5 \text{ N} \quad \text{Ans.}$$

This acts to the *left*; i.e., it requires a restraining force to keep the plate from accelerating to the right due to the continuous impact of the jet. The vertical force is

$$F_y = R_y = \dot{m}_1 v_1 + \dot{m}_2 v_2 - \dot{m}_j v_j$$

Check directions again: $v_1 = V_1$, $v_2 = -V_2$, $v_j = 0$. Thus

$$R_y = \dot{m}_1(V_1) + \dot{m}_2(-V_2) = \frac{1}{2}\dot{m}_j(V_1 - V_2) \quad (6)$$

But since we found earlier that $V_1 = V_2$, this means that $R_y = 0$, as we could expect from the symmetry of the jet deflection.⁹ Two other results are of interest. First, the relative velocity at section 1 was found to be 5 m/s up, from Eq. (3). If we convert this to absolute motion by adding on the control-volume speed $V_c = 15$ m/s to the right, we find that the absolute velocity $\mathbf{V}_1 = 15\mathbf{i} + 5\mathbf{j}$ m/s, or 15.8 m/s at an angle of 18.4° upward, as indicated in Fig. 3.10a. Thus the absolute jet speed changes after hitting the plate. Second, the computed force R_x does not change if we assume the jet deflects in all radial directions along the plate surface rather than just up and down. Since the plate is normal to the x axis, there would still be zero outlet x -momentum flux when Eq. (4) was rewritten for a radial-deflection condition.

EXAMPLE 3.11

The previous example treated a plate at normal incidence to an oncoming flow. In Fig. 3.11 the plate is parallel to the flow. The stream is not a jet but a broad river, or *free stream*, of uniform velocity $\mathbf{V} = U_0\mathbf{i}$. The pressure is assumed uniform, and so it has no net force on the plate. The plate does not block the flow as in Fig. 3.10, so that the only effect is due to boundary shear, which was neglected in the previous example. The no-slip condition at the wall brings the fluid there to a halt, and these slowly moving particles retard their neighbors above, so that at the end of the plate there is a significant retarded shear layer, or *boundary layer*, of thickness $y = \delta$. The

⁹Symmetry can be a powerful tool if used properly. Try to learn more about the uses and misuses of symmetry conditions. Here we doggedly computed the results without invoking symmetry.

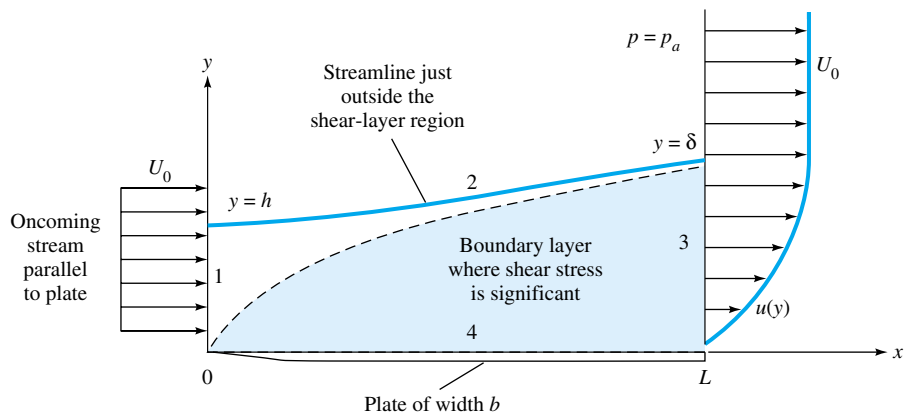

Fig. 3.11 Control-volume analysis of drag force on a flat plate due to boundary shear.

viscous stresses along the wall can sum to a finite drag force on the plate. These effects are illustrated in Fig. 3.11. The problem is to make an integral analysis and find the drag force D in terms of the flow properties ρ , U_0 , and δ and the plate dimensions L and b .[†]

Solution

Like most practical cases, this problem requires a combined mass and momentum balance. A proper selection of control volume is essential, and we select the four-sided region from 0 to h to δ to L and back to the origin 0, as shown in Fig. 3.11. Had we chosen to cut across horizontally from left to right along the height $y = h$, we would have cut through the shear layer and exposed unknown shear stresses. Instead we follow the streamline passing through $(x, y) = (0, h)$, which is outside the shear layer and also has no mass flow across it. The four control-volume sides are thus

1. From $(0, 0)$ to $(0, h)$: a one-dimensional inlet, $\mathbf{V} \cdot \mathbf{n} = -U_0$
2. From $(0, h)$ to (L, δ) : a streamline, no shear, $\mathbf{V} \cdot \mathbf{n} \equiv 0$
3. From (L, δ) to $(L, 0)$: a two-dimensional outlet, $\mathbf{V} \cdot \mathbf{n} = +u(y)$
4. From $(L, 0)$ to $(0, 0)$: a streamline just above the plate surface, $\mathbf{V} \cdot \mathbf{n} = 0$, shear forces summing to the drag force $-D\mathbf{i}$ acting from the plate onto the retarded fluid

The pressure is uniform, and so there is no net pressure force. Since the flow is assumed incompressible and steady, Eq. (3.37) applies with no unsteady term and fluxes only across sections 1 and 3:

$$\begin{aligned} \sum F_x = -D &= \rho \int_1 u(\mathbf{V} \cdot \mathbf{n}) dA + \rho \int_3 u(\mathbf{V} \cdot \mathbf{n}) dA \\ &= \rho \int_0^h U_0(-U_0)b dy + \rho \int_0^\delta u(+u)b dy \end{aligned}$$

Evaluating the first integral and rearranging give

$$D = \rho U_0^2 b h - \rho b \int_0^\delta u^2 dy \quad (1)$$

This could be considered the answer to the problem, but it is not useful because the height h is not known with respect to the shear-layer thickness δ . This is found by applying mass conservation, since the control volume forms a streamtube

$$\rho \int_{\text{CS}} (\mathbf{V} \cdot \mathbf{n}) dA = 0 = \rho \int_0^h (-U_0)b dy + \rho \int_0^\delta ub dy$$

$$\text{or} \quad U_0 h = \int_0^\delta u dy \quad (2)$$

after canceling b and ρ and evaluating the first integral. Introduce this value of h into Eq. (1) for a much cleaner result

$$D = \rho b \int_0^\delta u(U_0 - u) dy \Big|_{x=L} \quad \text{Ans. (3)}$$

This result was first derived by Theodore von Kármán in 1921.¹⁰ It relates the friction drag on

[†]The general analysis of such wall-shear problems, called *boundary-layer theory*, is treated in Sec. 7.3.

¹⁰The autobiography of this great twentieth-century engineer and teacher [2] is recommended for its historical and scientific insight.

one side of a flat plate to the integral of the *momentum defect* $u(U_0 - u)$ across the trailing cross section of the flow past the plate. Since $U_0 - u$ vanishes as y increases, the integral has a finite value. Equation (3) is an example of *momentum-integral theory* for boundary layers, which is treated in Chap. 7. To illustrate the magnitude of this drag force, we can use a simple parabolic approximation for the outlet-velocity profile $u(y)$ which simulates low-speed, or *laminar*, shear flow

$$u \approx U_0 \left(\frac{2y}{\delta} - \frac{y^2}{\delta^2} \right) \quad \text{for } 0 \leq y \leq \delta \quad (4)$$

Substituting into Eq. (3) and letting $\eta = y/\delta$ for convenience, we obtain

$$D = \rho b U_0^2 \delta \int_0^1 (2\eta - \eta^2)(1 - 2\eta + \eta^2) d\eta = \frac{2}{15} \rho U_0^2 b \delta \quad (5)$$

This is within 1 percent of the accepted result from laminar boundary-layer theory (Chap. 7) in spite of the crudeness of the Eq. (4) approximation. This is a happy situation and has led to the wide use of Kármán's integral theory in the analysis of viscous flows. Note that D increases with the shear-layer thickness δ , which itself increases with plate length and the viscosity of the fluid (see Sec. 7.4).

Momentum-Flux Correction Factor

For flow in a duct, the axial velocity is usually nonuniform, as in Example 3.4. For this case the simple momentum-flux calculation $\int u \rho (\mathbf{V} \cdot \mathbf{n}) dA = \dot{m} V = \rho A V^2$ is somewhat in error and should be corrected to $\beta \rho A V^2$, where β is the dimensionless momentum-flux correction factor, $\beta \geq 1$.

The factor β accounts for the variation of u^2 across the duct section. That is, we compute the exact flux and set it equal to a flux based on average velocity in the duct

$$\rho \int u^2 dA = \beta \dot{m} V_{\text{av}} = \beta \rho A V_{\text{av}}^2$$

or

$$\beta = \frac{1}{A} \int \left(\frac{u}{V_{\text{av}}} \right)^2 dA \quad (3.43a)$$

Values of β can be computed based on typical duct velocity profiles similar to those in Example 3.4. The results are as follows:

Laminar flow:
$$u = U_0 \left(1 - \frac{r^2}{R^2} \right) \quad \beta = \frac{4}{3} \quad (3.43b)$$

Turbulent flow:
$$u \approx U_0 \left(1 - \frac{r}{R} \right)^m \quad \frac{1}{9} \leq m \leq \frac{1}{5}$$

$$\beta = \frac{(1+m)^2(2+m)^2}{2(1+2m)(2+2m)} \quad (3.43c)$$

The turbulent correction factors have the following range of values:

Turbulent flow:	m	$\frac{1}{5}$	$\frac{1}{6}$	$\frac{1}{7}$	$\frac{1}{8}$	$\frac{1}{9}$
	β	1.037	1.027	1.020	1.016	1.013

These are so close to unity that they are normally neglected. The laminar correction may sometimes be important.

To illustrate a typical use of these correction factors, the solution to Example 3.8 for nonuniform velocities at sections 1 and 2 would be given as

$$\sum \mathbf{F} = \dot{m}(\beta_2 \mathbf{V}_2 - \beta_1 \mathbf{V}_1) \quad (3.43d)$$

Note that the basic parameters and vector character of the result are not changed at all by this correction.

Noninertial Reference Frame¹¹

All previous derivations and examples in this section have assumed that the coordinate system is inertial, i.e., at rest or moving at constant velocity. In this case the rate of change of velocity equals the absolute acceleration of the system, and Newton's law applies directly in the form of Eqs. (3.2) and (3.35).

In many cases it is convenient to use a *noninertial*, or accelerating, coordinate system. An example would be coordinates fixed to a rocket during takeoff. A second example is any flow on the earth's surface, which is accelerating relative to the fixed stars because of the rotation of the earth. Atmospheric and oceanographic flows experience the so-called *Coriolis acceleration*, outlined below. It is typically less than $10^{-5}g$, where g is the acceleration of gravity, but its accumulated effect over distances of many kilometers can be dominant in geophysical flows. By contrast, the Coriolis acceleration is negligible in small-scale problems like pipe or airfoil flows.

Suppose that the fluid flow has velocity \mathbf{V} relative to a noninertial xyz coordinate system, as shown in Fig. 3.12. Then $d\mathbf{V}/dt$ will represent a noninertial acceleration which must be added vectorially to a relative acceleration \mathbf{a}_{rel} to give the absolute acceleration \mathbf{a}_i relative to some inertial coordinate system XYZ , as in Fig. 3.12. Thus

$$\mathbf{a}_i = \frac{d\mathbf{V}}{dt} + \mathbf{a}_{\text{rel}} \quad (3.44)$$

¹¹This section may be omitted without loss of continuity.

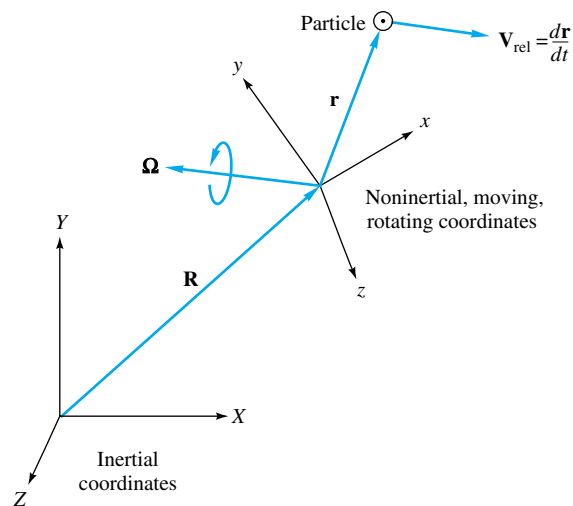

Fig. 3.12 Geometry of fixed versus accelerating coordinates.

Since Newton's law applies to the absolute acceleration,

$$\sum \mathbf{F} = m\mathbf{a}_i = m\left(\frac{d\mathbf{V}}{dt} + \mathbf{a}_{\text{rel}}\right)$$

or

$$\sum \mathbf{F} - m\mathbf{a}_{\text{rel}} = m\frac{d\mathbf{V}}{dt} \quad (3.45)$$

Thus Newton's law in noninertial coordinates xyz is equivalent to adding more "force" terms $-m\mathbf{a}_{\text{rel}}$ to account for noninertial effects. In the most general case, sketched in Fig. 3.12, the term \mathbf{a}_{rel} contains four parts, three of which account for the angular velocity $\boldsymbol{\Omega}(t)$ of the inertial coordinates. By inspection of Fig. 3.12, the absolute displacement of a particle is

$$\mathbf{S}_i = \mathbf{r} + \mathbf{R} \quad (3.46)$$

Differentiation gives the absolute velocity

$$\mathbf{V}_i = \mathbf{V} + \frac{d\mathbf{R}}{dt} + \boldsymbol{\Omega} \times \mathbf{r} \quad (3.47)$$

A second differentiation gives the absolute acceleration:

$$\mathbf{a}_i = \frac{d\mathbf{V}}{dt} + \frac{d^2\mathbf{R}}{dt^2} + \frac{d\boldsymbol{\Omega}}{dt} \times \mathbf{r} + 2\boldsymbol{\Omega} \times \mathbf{V} + \boldsymbol{\Omega} \times (\boldsymbol{\Omega} \times \mathbf{r}) \quad (3.48)$$

By comparison with Eq. (3.44), we see that the last four terms on the right represent the additional relative acceleration:

1. $d^2\mathbf{R}/dt^2$ is the acceleration of the noninertial origin of coordinates xyz .
2. $(d\boldsymbol{\Omega}/dt) \times \mathbf{r}$ is the angular-acceleration effect.
3. $2\boldsymbol{\Omega} \times \mathbf{V}$ is the Coriolis acceleration.
4. $\boldsymbol{\Omega} \times (\boldsymbol{\Omega} \times \mathbf{r})$ is the centripetal acceleration, directed from the particle normal to the axis of rotation with magnitude $\Omega^2 L$, where L is the normal distance to the axis.¹²

Equation (3.45) differs from Eq. (3.2) only in the added inertial forces on the left-hand side. Thus the control-volume formulation of linear momentum in noninertial coordinates merely adds inertial terms by integrating the added relative acceleration over each differential mass in the control volume

$$\sum \mathbf{F} - \int_{\text{CV}} \mathbf{a}_{\text{rel}} dm = \frac{d}{dt} \left(\int_{\text{CV}} \mathbf{V} \rho d^3V \right) + \int_{\text{CS}} \mathbf{V} \rho (\mathbf{V}_r \cdot \mathbf{n}) dA \quad (3.49)$$

where

$$\mathbf{a}_{\text{rel}} = \frac{d^2\mathbf{R}}{dt^2} + \frac{d\boldsymbol{\Omega}}{dt} \times \mathbf{r} + 2\boldsymbol{\Omega} \times \mathbf{V} + \boldsymbol{\Omega} \times (\boldsymbol{\Omega} \times \mathbf{r})$$

This is the noninertial equivalent to the inertial form given in Eq. (3.35). To analyze such problems, one must have knowledge of the displacement \mathbf{R} and angular velocity $\boldsymbol{\Omega}$ of the noninertial coordinates.

If the control volume is nondeformable, Eq. (3.49) reduces to

¹²A complete discussion of these noninertial coordinate terms is given, e.g., in Ref. 4, pp. 49–51.

$$\sum \mathbf{F} - \int_{\text{CV}} \mathbf{a}_{\text{rel}} dm = \frac{d}{dt} \left(\int_{\text{CV}} \mathbf{V} \rho dV \right) + \int_{\text{CS}} \mathbf{V} \rho (\mathbf{V} \cdot \mathbf{n}) dA \quad (3.50)$$

In other words, the right-hand side reduces to that of Eq. (3.37).

EXAMPLE 3.12

A classic example of an accelerating control volume is a rocket moving straight up, as in Fig. E3.12. Let the initial mass be M_0 , and assume a steady exhaust mass flow \dot{m} and exhaust velocity V_e relative to the rocket, as shown. If the flow pattern within the rocket motor is steady and air drag is neglected, derive the differential equation of vertical rocket motion $V(t)$ and integrate using the initial condition $V = 0$ at $t = 0$.

Solution

The appropriate control volume in Fig. E3.12 encloses the rocket, cuts through the exit jet, and accelerates upward at rocket speed $V(t)$. The z -momentum equation (3.49) becomes

$$\sum F_z - \int a_{\text{rel}} dm = \frac{d}{dt} \left(\int_{\text{CV}} w dm \right) + (\dot{m}w)_e$$

or

$$-mg - m \frac{dV}{dt} = 0 + \dot{m} V_e \quad \text{with} \quad m = m(t) = M_0 - \dot{m}t$$

The term $a_{\text{rel}} = dV/dt$ of the rocket. The control volume integral vanishes because of the steady rocket-flow conditions. Separate the variables and integrate, assuming $V = 0$ at $t = 0$:

$$\int_0^V dV = \dot{m} V_e \int_0^t \frac{dt}{M_0 - \dot{m}t} - g \int_0^t dt \quad \text{or} \quad V(t) = -V_e \ln \left(1 - \frac{\dot{m}t}{M_0} \right) - gt \quad \text{Ans.}$$

This is a classic approximate formula in rocket dynamics. The first term is positive and, if the fuel mass burned is a large fraction of initial mass, the final rocket velocity can exceed V_e .

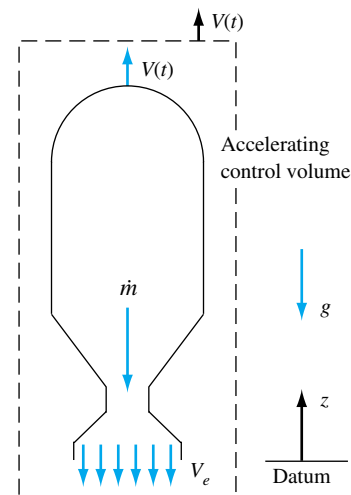

E3.12

3.5 The Angular-Momentum Theorem¹³

A control-volume analysis can be applied to the angular-momentum relation, Eq. (3.3), by letting our dummy variable \mathbf{B} be the angular-momentum vector \mathbf{H} . However, since the system considered here is typically a group of nonrigid fluid particles of variable velocity, the concept of mass moment of inertia is of no help and we have to calculate the instantaneous angular momentum by integration over the elemental masses dm . If O is the point about which moments are desired, the angular momentum about O is given by

$$\mathbf{H}_O = \int_{\text{sys}} (\mathbf{r} \times \mathbf{V}) dm \quad (3.51)$$

where \mathbf{r} is the position vector from O to the elemental mass dm and \mathbf{V} is the velocity of that element. The amount of angular momentum per unit mass is thus seen to be

$$\boldsymbol{\beta} = \frac{d\mathbf{H}_O}{dm} = \mathbf{r} \times \mathbf{V}$$

¹³This section may be omitted without loss of continuity.

The Reynolds transport theorem (3.16) then tells us that

$$\frac{d\mathbf{H}_O}{dt} \Big|_{\text{sys}} = \frac{d}{dt} \left[\int_{\text{CV}} (\mathbf{r} \times \mathbf{V}) \rho \, d\mathcal{V} \right] + \int_{\text{CS}} (\mathbf{r} \times \mathbf{V}) \rho (\mathbf{V}_r \cdot \mathbf{n}) \, dA \quad (3.52)$$

for the most general case of a deformable control volume. But from the angular-momentum theorem (3.3), this must equal the sum of all the moments about point O applied to the control volume

$$\frac{d\mathbf{H}_O}{dt} = \sum \mathbf{M}_O = \sum (\mathbf{r} \times \mathbf{F})_O$$

Note that the total moment equals the summation of moments of all applied forces about point O . Recall, however, that this law, like Newton's law (3.2), assumes that the particle velocity \mathbf{V} is relative to an *inertial* coordinate system. If not, the moments about point O of the relative acceleration terms \mathbf{a}_{rel} in Eq. (3.49) must also be included

$$\sum \mathbf{M}_O = \sum (\mathbf{r} \times \mathbf{F})_O - \int_{\text{CV}} (\mathbf{r} \times \mathbf{a}_{\text{rel}}) \, dm \quad (3.53)$$

where the four terms constituting \mathbf{a}_{rel} are given in Eq. (3.49). Thus the most general case of the angular-momentum theorem is for a deformable control volume associated with a noninertial coordinate system. We combine Eqs. (3.52) and (3.53) to obtain

$$\sum (\mathbf{r} \times \mathbf{F})_O - \int_{\text{CV}} (\mathbf{r} \times \mathbf{a}_{\text{rel}}) \, dm = \frac{d}{dt} \left[\int_{\text{CV}} (\mathbf{r} \times \mathbf{V}) \rho \, d\mathcal{V} \right] + \int_{\text{CS}} (\mathbf{r} \times \mathbf{V}) \rho (\mathbf{V}_r \cdot \mathbf{n}) \, dA \quad (3.54)$$

For a nondeformable inertial control volume, this reduces to

$$\sum \mathbf{M}_O = \frac{\partial}{\partial t} \left[\int_{\text{CV}} (\mathbf{r} \times \mathbf{V}) \rho \, d\mathcal{V} \right] + \int_{\text{CS}} (\mathbf{r} \times \mathbf{V}) \rho (\mathbf{V} \cdot \mathbf{n}) \, dA \quad (3.55)$$

Further, if there are only one-dimensional inlets and exits, the angular-momentum flux terms evaluated on the control surface become

$$\int_{\text{CS}} (\mathbf{r} \times \mathbf{V}) \rho (\mathbf{V} \cdot \mathbf{n}) \, dA = \sum (\mathbf{r} \times \mathbf{V})_{\text{out}} \dot{m}_{\text{out}} - \sum (\mathbf{r} \times \mathbf{V})_{\text{in}} \dot{m}_{\text{in}} \quad (3.56)$$

Although at this stage the angular-momentum theorem can be considered to be a supplementary topic, it has direct application to many important fluid-flow problems involving torques or moments. A particularly important case is the analysis of rotating fluid-flow devices, usually called *turbomachines* (Chap. 11).

EXAMPLE 3.13

As shown in Fig. E3.13a, a pipe bend is supported at point A and connected to a flow system by flexible couplings at sections 1 and 2. The fluid is incompressible, and ambient pressure p_a is zero. (a) Find an expression for the torque T which must be resisted by the support at A , in terms of the flow properties at sections 1 and 2 and the distances h_1 and h_2 . (b) Compute this torque if $D_1 = D_2 = 3$ in, $p_1 = 100$ lbf/in² gage, $p_2 = 80$ lbf/in² gage, $V_1 = 40$ ft/s, $h_1 = 2$ in, $h_2 = 10$ in, and $\rho = 1.94$ slugs/ft³.

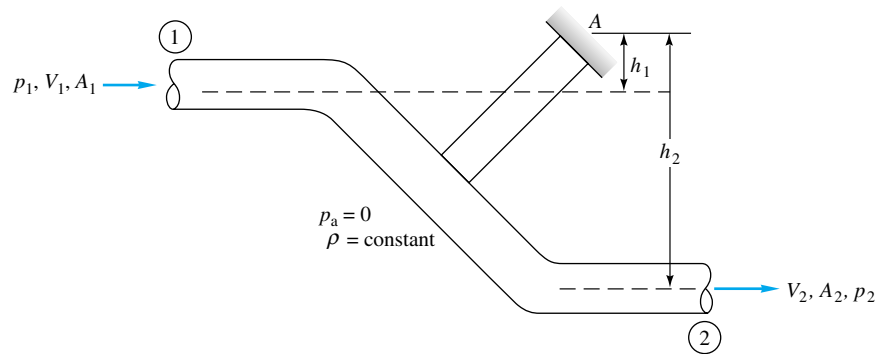

E3.13a

Solution

Part (a) The control volume chosen in Fig. E3.13b cuts through sections 1 and 2 and through the support at A , where the torque T_A is desired. The flexible-couplings description specifies that there is no torque at either section 1 or 2, and so the cuts there expose no moments. For the angular-momentum terms $\mathbf{r} \times \mathbf{V}$, \mathbf{r} should be taken from point A to sections 1 and 2. Note that the gage pressure forces $p_1 A_1$ and $p_2 A_2$ both have moments about A . Equation (3.55) with one-dimensional flux terms becomes

$$\begin{aligned} \sum \mathbf{M}_A &= \mathbf{T}_A + \mathbf{r}_1 \times (-p_1 A_1 \mathbf{n}_1) + \mathbf{r}_2 \times (-p_2 A_2 \mathbf{n}_2) \\ &= (\mathbf{r}_2 \times \mathbf{V}_2)(+\dot{m}_{\text{out}}) + (\mathbf{r}_1 \times \mathbf{V}_1)(-\dot{m}_{\text{in}}) \end{aligned} \quad (1)$$

Figure E3.13c shows that all the cross products are associated either with $r_1 \sin \theta_1 = h_1$ or $r_2 \sin \theta_2 = h_2$, the perpendicular distances from point A to the pipe axes at 1 and 2. Remember that $\dot{m}_{\text{in}} = \dot{m}_{\text{out}}$ from the steady-flow continuity relation. In terms of counterclockwise moments, Eq. (1) then becomes

$$T_A + p_1 A_1 h_1 - p_2 A_2 h_2 = \dot{m}(h_2 V_2 - h_1 V_1) \quad (2)$$

Rewriting this, we find the desired torque to be

$$T_A = h_2(p_2 A_2 + \dot{m} V_2) - h_1(p_1 A_1 + \dot{m} V_1) \quad \text{Ans. (a) (3)}$$

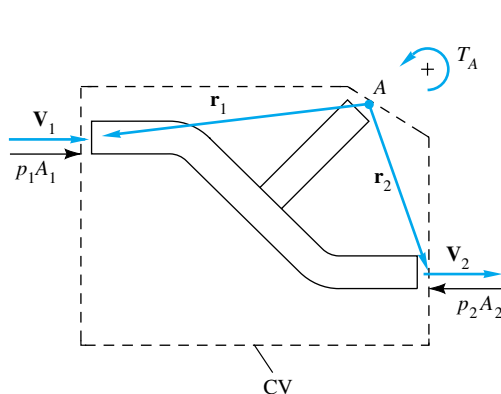

E3.13b

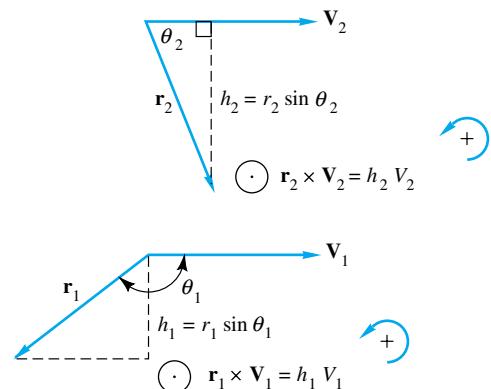

E3.13c

counterclockwise. The quantities p_1 and p_2 are gage pressures. Note that this result is independent of the shape of the pipe bend and varies only with the properties at sections 1 and 2 and the distances h_1 and h_2 .[†]

Part (b) The inlet and exit areas are the same:

$$A_1 = A_2 = \frac{\pi}{4} (3)^2 = 7.07 \text{ in}^2 = 0.0491 \text{ ft}^2$$

Since the density is constant, we conclude from continuity that $V_2 = V_1 = 40 \text{ ft/s}$. The mass flow is

$$\dot{m} = \rho A_1 V_1 = 1.94(0.0491)(40) = 3.81 \text{ slug/s}$$

Equation (3) can be evaluated as

$$\begin{aligned} T_A &= \left(\frac{10}{12} \text{ ft}\right)[80(7.07) \text{ lbf} + 3.81(40) \text{ lbf}] - \left(\frac{2}{12} \text{ ft}\right)[100(7.07) \text{ lbf} + 3.81(40) \text{ lbf}] \\ &= 598 - 143 = 455 \text{ ft} \cdot \text{lbf counterclockwise} \end{aligned} \quad \text{Ans. (b)}$$

We got a little daring there and multiplied p in lbf/in² gage times A in in² to get lbf without changing units to lbf/ft² and ft².

EXAMPLE 3.14

Figure 3.13 shows a schematic of a centrifugal pump. The fluid enters axially and passes through the pump blades, which rotate at angular velocity ω ; the velocity of the fluid is changed from V_1 to V_2 and its pressure from p_1 to p_2 . (a) Find an expression for the torque T_O which must be applied to these blades to maintain this flow. (b) The power supplied to the pump would be $P = \omega T_O$. To illustrate numerically, suppose $r_1 = 0.2 \text{ m}$, $r_2 = 0.5 \text{ m}$, and $b = 0.15 \text{ m}$. Let the pump rotate at 600 r/min and deliver water at 2.5 m³/s with a density of 1000 kg/m³. Compute the idealized torque and power supplied.

Solution

Part (a) The control volume is chosen to be the angular region between sections 1 and 2 where the flow passes through the pump blades (see Fig. 3.13). The flow is steady and assumed incompressible. The contribution of pressure to the torque about axis O is zero since the pressure forces at 1 and 2 act radially through O . Equation (3.55) becomes

$$\sum \mathbf{M}_O = \mathbf{T}_O = (\mathbf{r}_2 \times \mathbf{V}_2)\dot{m}_{\text{out}} - (\mathbf{r}_1 \times \mathbf{V}_1)\dot{m}_{\text{in}} \quad (1)$$

where steady-flow continuity tells us that

$$\dot{m}_{\text{in}} = \rho V_{n1} 2\pi r_1 b = \dot{m}_{\text{out}} = \rho V_{n2} 2\pi r_2 b = \rho Q$$

The cross product $\mathbf{r} \times \mathbf{V}$ is found to be clockwise about O at both sections:

$$\mathbf{r}_2 \times \mathbf{V}_2 = r_2 V_{t2} \sin 90^\circ \mathbf{k} = r_2 V_{t2} \mathbf{k} \quad \text{clockwise}$$

$$\mathbf{r}_1 \times \mathbf{V}_1 = r_1 V_{t1} \mathbf{k} \quad \text{clockwise}$$

Equation (1) thus becomes the desired formula for torque

$$\mathbf{T}_O = \rho Q (r_2 V_{t2} - r_1 V_{t1}) \mathbf{k} \quad \text{clockwise} \quad \text{Ans. (a)} \quad (2a)$$

[†]Indirectly, the pipe-bend shape probably affects the pressure change from p_1 to p_2 .

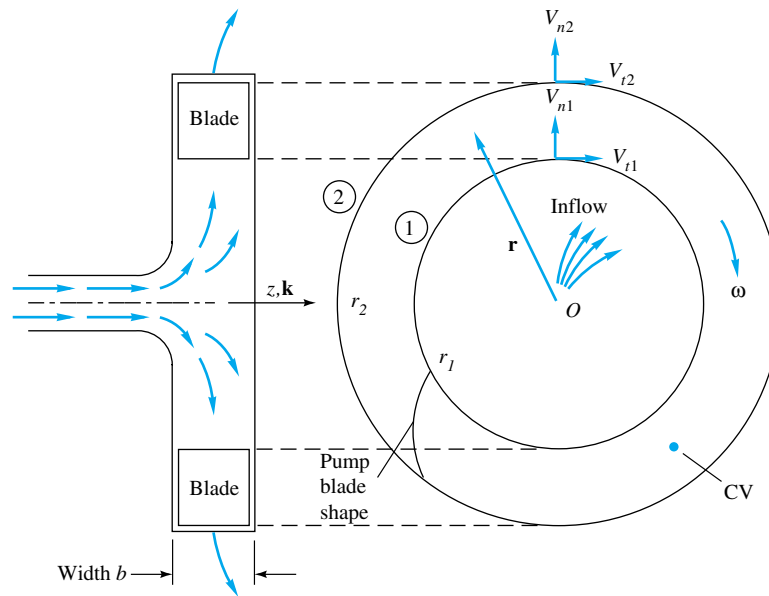

Fig. 3.13 Schematic of a simplified centrifugal pump.

This relation is called *Euler's turbine formula*. In an idealized pump, the inlet and outlet tangential velocities would match the blade rotational speeds $V_{t1} = \omega r_1$ and $V_{t2} = \omega r_2$. Then the formula for torque supplied becomes

$$T_O = \rho Q \omega (r_2^2 - r_1^2) \quad \text{clockwise} \quad (2b)$$

Part (b) Convert ω to $600(2\pi/60) = 62.8$ rad/s. The normal velocities are not needed here but follow from the flow rate

$$V_{n1} = \frac{Q}{2\pi r_1 b} = \frac{2.5 \text{ m}^3/\text{s}}{2\pi(0.2 \text{ m})(0.15 \text{ m})} = 13.3 \text{ m/s}$$

$$V_{n2} = \frac{Q}{2\pi r_2 b} = \frac{2.5}{2\pi(0.5)(0.15)} = 5.3 \text{ m/s}$$

For the idealized inlet and outlet, tangential velocity equals tip speed

$$V_{t1} = \omega r_1 = (62.8 \text{ rad/s})(0.2 \text{ m}) = 12.6 \text{ m/s}$$

$$V_{t2} = \omega r_2 = 62.8(0.5) = 31.4 \text{ m/s}$$

Equation (2a) predicts the required torque to be

$$\begin{aligned} T_O &= (1000 \text{ kg/m}^3)(2.5 \text{ m}^3/\text{s})[(0.5 \text{ m})(31.4 \text{ m/s}) - (0.2 \text{ m})(12.6 \text{ m/s})] \\ &= 33,000 \text{ (kg} \cdot \text{m}^2/\text{s}^2) = 33,000 \text{ N} \cdot \text{m} \end{aligned} \quad \text{Ans.}$$

The power required is

$$\begin{aligned} P &= \omega T_O = (62.8 \text{ rad/s})(33,000 \text{ N} \cdot \text{m}) = 2,070,000 \text{ (N} \cdot \text{m)/s} \\ &= 2.07 \text{ MW (2780 hp)} \end{aligned} \quad \text{Ans.}$$

In actual practice the tangential velocities are considerably less than the impeller-tip speeds, and the design power requirements for this pump may be only 1 MW or less.

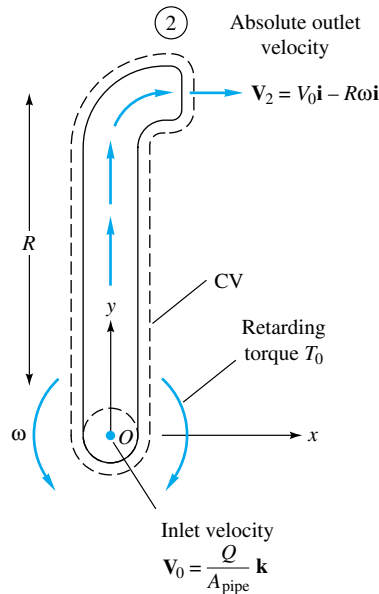

Fig. 3.14 View from above of a single arm of a rotating lawn sprinkler.

EXAMPLE 3.15

Figure 3.14 shows a lawn-sprinkler arm viewed from above. The arm rotates about O at constant angular velocity ω . The volume flux entering the arm at O is Q , and the fluid is incompressible. There is a retarding torque at O , due to bearing friction, of amount $-T_O \mathbf{k}$. Find an expression for the rotation ω in terms of the arm and flow properties.

Solution

The entering velocity is $V_0 \mathbf{k}$, where $V_0 = Q/A_{\text{pipe}}$. Equation (3.55) applies to the control volume sketched in Fig. 3.14 only if \mathbf{V} is the absolute velocity relative to an inertial frame. Thus the exit velocity at section 2 is

$$\mathbf{V}_2 = V_0 \mathbf{i} - R\omega \mathbf{i}$$

Equation (3.55) then predicts that, for steady flow,

$$\sum \mathbf{M}_O = -T_O \mathbf{k} = (\mathbf{r}_2 \times \mathbf{V}_2) \dot{m}_{\text{out}} - (\mathbf{r}_1 \times \mathbf{V}_1) \dot{m}_{\text{in}} \quad (1)$$

where, from continuity, $\dot{m}_{\text{out}} = \dot{m}_{\text{in}} = \rho Q$. The cross products with reference to point O are

$$\mathbf{r}_2 \times \mathbf{V}_2 = R \mathbf{j} \times (V_0 - R\omega) \mathbf{i} = (R^2 \omega - RV_0) \mathbf{k}$$

$$\mathbf{r}_1 \times \mathbf{V}_1 = 0 \mathbf{j} \times V_0 \mathbf{k} = 0$$

Equation (1) thus becomes

$$-T_O \mathbf{k} = \rho Q (R^2 \omega - RV_0) \mathbf{k}$$

$$\omega = \frac{V_0}{R} - \frac{T_O}{\rho Q R^2} \quad \text{Ans.}$$

The result may surprise you: Even if the retarding torque T_O is negligible, the arm rotational speed is limited to the value V_0/R imposed by the outlet speed and the arm length.

3.6 The Energy Equation¹⁴

As our fourth and final basic law, we apply the Reynolds transport theorem (3.12) to the first law of thermodynamics, Eq. (3.5). The dummy variable B becomes energy E , and the energy per unit mass is $\beta = dE/dm = e$. Equation (3.5) can then be written for a fixed control volume as follows:¹⁵

$$\frac{dQ}{dt} - \frac{dW}{dt} = \frac{dE}{dt} = \frac{d}{dt} \left(\int_{\text{CV}} e \rho d^3V \right) + \int_{\text{CS}} e \rho (\mathbf{V} \cdot \mathbf{n}) dA \quad (3.57)$$

Recall that positive Q denotes heat added to the system and positive W denotes work done by the system.

The system energy per unit mass e may be of several types:

$$e = e_{\text{internal}} + e_{\text{kinetic}} + e_{\text{potential}} + e_{\text{other}}$$

¹⁴This section should be read for information and enrichment even if you lack formal background in thermodynamics.

¹⁵The energy equation for a deformable control volume is rather complicated and is not discussed here. See Refs. 4 and 5 for further details.

where e_{other} could encompass chemical reactions, nuclear reactions, and electrostatic or magnetic field effects. We neglect e_{other} here and consider only the first three terms as discussed in Eq. (1.9), with z defined as “up”:

$$e = \hat{u} + \frac{1}{2}V^2 + gz \quad (3.58)$$

The heat and work terms could be examined in detail. If this were a heat-transfer book, dQ/dT would be broken down into conduction, convection, and radiation effects and whole chapters written on each (see, e.g., Ref. 3). Here we leave the term untouched and consider it only occasionally.

Using for convenience the overdot to denote the time derivative, we divide the work term into three parts:

$$\dot{W} = \dot{W}_{\text{shaft}} + \dot{W}_{\text{press}} + \dot{W}_{\text{viscous stresses}} = \dot{W}_s + \dot{W}_p + \dot{W}_v$$

The work of gravitational forces has already been included as potential energy in Eq. (3.58). Other types of work, e.g., those due to electromagnetic forces, are excluded here.

The shaft work isolates that portion of the work which is deliberately done by a machine (pump impeller, fan blade, piston, etc.) protruding through the control surface into the control volume. No further specification other than \dot{W}_s is desired at this point, but calculations of the work done by turbomachines will be performed in Chap. 11.

The rate of work \dot{W}_p done on pressure forces occurs at the surface only; all work on internal portions of the material in the control volume is by equal and opposite forces and is self-canceling. The pressure work equals the pressure force on a small surface element dA times the normal velocity component into the control volume

$$d\dot{W}_p = -(p \, dA)V_{n,\text{in}} = -p(-\mathbf{V} \cdot \mathbf{n}) \, dA$$

The total pressure work is the integral over the control surface

$$\dot{W}_p = \int_{\text{CS}} p(\mathbf{V} \cdot \mathbf{n}) \, dA \quad (3.59)$$

A cautionary remark: If part of the control surface is the surface of a machine part, we prefer to delegate that portion of the pressure to the *shaft work* term \dot{W}_s , not to \dot{W}_p , which is primarily meant to isolate the fluid-flow pressure-work terms.

Finally, the shear work due to viscous stresses occurs at the control surface, the internal work terms again being self-canceling, and consists of the product of each viscous stress (one normal and two tangential) and the respective velocity component

$$d\dot{W}_v = -\boldsymbol{\tau} \cdot \mathbf{V} \, dA$$

or

$$\dot{W}_v = - \int_{\text{CS}} \boldsymbol{\tau} \cdot \mathbf{V} \, dA \quad (3.60)$$

where $\boldsymbol{\tau}$ is the stress vector on the elemental surface dA . This term may vanish or be negligible according to the particular type of surface at that part of the control volume:

Solid surface. For all parts of the control surface which are solid confining walls, $\mathbf{V} = 0$ from the viscous no-slip condition; hence $\dot{W}_v = 0$ identically.

Surface of a machine. Here the viscous work is contributed by the machine, and so we absorb this work in the term \dot{W}_s .

An inlet or outlet. At an inlet or outlet, the flow is approximately normal to the element dA ; hence the only viscous-work term comes from the normal stress $\tau_{nn}V_n dA$. Since viscous normal stresses are extremely small in all but rare cases, e.g., the interior of a shock wave, it is customary to neglect viscous work at inlets and outlets of the control volume.

Streamline surface. If the control surface is a streamline such as the upper curve in the boundary-layer analysis of Fig. 3.11, the viscous-work term must be evaluated and retained if shear stresses are significant along this line. In the particular case of Fig. 3.11, the streamline is outside the boundary layer, and viscous work is negligible.

The net result of the above discussion is that the rate-of-work term in Eq. (3.57) consists essentially of

$$\dot{W} = \dot{W}_s + \int_{CS} p(\mathbf{V} \cdot \mathbf{n}) dA - \int_{CS} (\boldsymbol{\tau} \cdot \mathbf{V})_{SS} dA \quad (3.61)$$

where the subscript SS stands for stream surface. When we introduce (3.61) and (3.58) into (3.57), we find that the pressure-work term can be combined with the energy-flux term since both involve surface integrals of $\mathbf{V} \cdot \mathbf{n}$. The control-volume energy equation thus becomes

$$\dot{Q} - \dot{W}_s - (\dot{W}_v)_{SS} = \frac{\partial}{\partial t} \left(\int_{CV} ep d^3V \right) + \int_{CS} \left(e + \frac{p}{\rho} \right) \rho(\mathbf{V} \cdot \mathbf{n}) dA \quad (3.62)$$

Using e from (3.58), we see that the enthalpy $\hat{h} = \hat{u} + p/\rho$ occurs in the control-surface integral. The final general form for the energy equation for a fixed control volume becomes

$$\dot{Q} - \dot{W}_s - \dot{W}_v = \frac{\partial}{\partial t} \left[\int_{CV} \left(\hat{u} + \frac{1}{2} V^2 + gz \right) \rho d^3V \right] + \int_{CS} \left(\hat{h} + \frac{1}{2} V^2 + gz \right) \rho(\mathbf{V} \cdot \mathbf{n}) dA \quad (3.63)$$

As mentioned above, the shear-work term \dot{W}_v is rarely important.

One-Dimensional Energy-Flux Terms

If the control volume has a series of one-dimensional inlets and outlets, as in Fig. 3.6, the surface integral in (3.63) reduces to a summation of outlet fluxes minus inlet fluxes

$$\begin{aligned} \int_{CS} \left(\hat{h} + \frac{1}{2} V^2 + gz \right) \rho(\mathbf{V} \cdot \mathbf{n}) dA \\ = \sum \left(\hat{h} + \frac{1}{2} V^2 + gz \right)_{\text{out}} \dot{m}_{\text{out}} - \sum \left(\hat{h} + \frac{1}{2} V^2 + gz \right)_{\text{in}} \dot{m}_{\text{in}} \end{aligned} \quad (3.64)$$

where the values of \hat{h} , $\frac{1}{2}V^2$, and gz are taken to be averages over each cross section.

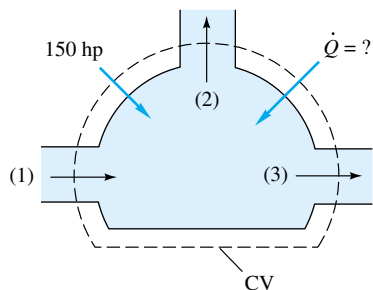

E3.16

EXAMPLE 3.16

A steady-flow machine (Fig. E3.16) takes in air at section 1 and discharges it at sections 2 and 3. The properties at each section are as follows:

Section	A , ft ²	Q , ft ³ /s	T , °F	p , lbf/in ² abs	z , ft
1	0.4	100	70	20	1.0
2	1.0	40	100	30	4.0
3	0.25	50	200	?	1.5

Work is provided to the machine at the rate of 150 hp. Find the pressure p_3 in lbf/in² absolute and the heat transfer \dot{Q} in Btu/s. Assume that air is a perfect gas with $R = 1715$ and $c_p = 6003$ ft · lbf/(slug · °R).

Solution

The control volume chosen cuts across the three desired sections and otherwise follows the solid walls of the machine. Therefore the shear-work term \dot{W}_s is negligible. We have enough information to compute $V_i = Q_i/A_i$ immediately

$$V_1 = \frac{100}{0.4} = 250 \text{ ft/s} \quad V_2 = \frac{40}{1.0} = 40 \text{ ft/s} \quad V_3 = \frac{50}{0.25} = 200 \text{ ft/s}$$

and the densities $\rho_i = p_i/(RT_i)$

$$\rho_1 = \frac{20(144)}{1715(70 + 460)} = 0.00317 \text{ slug/ft}^3$$

$$\rho_2 = \frac{30(144)}{1715(560)} = 0.00450 \text{ slug/ft}^3$$

but p_3 is determined from the steady-flow continuity relation:

$$\dot{m}_1 = \dot{m}_2 + \dot{m}_3$$

$$\rho_1 Q_1 = \rho_2 Q_2 + \rho_3 Q_3 \quad (1)$$

$$0.00317(100) = 0.00450(40) + \rho_3(50)$$

or

$$50\rho_3 = 0.317 - 0.180 = 0.137 \text{ slug/s}$$

$$\rho_3 = \frac{0.137}{50} = 0.00274 \text{ slug/ft}^3 = \frac{144p_3}{1715(660)}$$

$$p_3 = 21.5 \text{ lbf/in}^2 \text{ absolute} \quad \text{Ans.}$$

Note that the volume flux $Q_1 \neq Q_2 + Q_3$ because of the density changes.

For steady flow, the volume integral in (3.63) vanishes, and we have agreed to neglect viscous work. With one inlet and two outlets, we obtain

$$\dot{Q} - \dot{W}_s = -\dot{m}_1(\hat{h}_1 + \frac{1}{2}V_1^2 + gz_1) + \dot{m}_2(\hat{h}_2 + \frac{1}{2}V_2^2 + gz_2) + \dot{m}_3(\hat{h}_3 + \frac{1}{2}V_3^2 + gz_3) \quad (2)$$

where \dot{W}_s is given in hp and can be quickly converted to consistent BG units:

$$\begin{aligned} \dot{W}_s &= -150 \text{ hp} [550 \text{ ft} \cdot \text{lbf}/(\text{s} \cdot \text{hp})] \\ &= -82,500 \text{ ft} \cdot \text{lbf/s} \quad \text{negative work on system} \end{aligned}$$

For a perfect gas with constant c_p , $\hat{h} = c_p T$ plus an arbitrary constant. It is instructive to separate the flux terms in Eq. (2) above to examine their magnitudes:

Enthalpy flux:

$$\begin{aligned} c_p(-\dot{m}_1 T_1 + \dot{m}_2 T_2 + \dot{m}_3 T_3) &= [6003 \text{ ft} \cdot \text{lb}/(\text{slug} \cdot ^\circ\text{R})][(-0.317 \text{ slug/s})(530 ^\circ\text{R}) \\ &\quad + 0.180(560) + 0.137(660)] \\ &= -1,009,000 + 605,000 + 543,000 \\ &= +139,000 \text{ ft} \cdot \text{lb}/\text{s} \end{aligned}$$

Kinetic-energy flux:

$$\begin{aligned} -\dot{m}_1(\tfrac{1}{2}V_1^2) + \dot{m}_2(\tfrac{1}{2}V_2^2) + \dot{m}_3(\tfrac{1}{2}V_3^2) &= \tfrac{1}{2}[-0.317(250)^2 + 0.180(40)^2 + 0.137(200)^2] \\ &= -9900 + 150 + 2750 = -7000 \text{ ft} \cdot \text{lb}/\text{s} \end{aligned}$$

Potential-energy flux:

$$\begin{aligned} g(-\dot{m}_1 z_1 + \dot{m}_2 z_2 + \dot{m}_3 z_3) &= 32.2[-0.317(1.0) + 0.180(4.0) + 0.137(1.5)] \\ &= -10 + 23 + 7 = +20 \text{ ft} \cdot \text{lb}/\text{s} \end{aligned}$$

These are typical effects: The potential-energy flux is negligible in gas flows, the kinetic-energy flux is small in low-speed flows, and the enthalpy flux is dominant. It is only when we neglect heat-transfer effects that the kinetic and potential energies become important. Anyway, we can now solve for the heat flux

$$\dot{Q} = -82,500 + 139,000 - 7000 + 20 = 49,520 \text{ ft} \cdot \text{lb}/\text{s} \quad (3)$$

Converting, we get

$$\dot{Q} = \frac{49,520}{778.2 \text{ ft} \cdot \text{lb}/\text{Btu}} = +63.6 \text{ Btu/s} \quad \text{Ans.}$$

The Steady-Flow Energy Equation

For steady flow with one inlet and one outlet, both assumed one-dimensional, Eq. (3.63) reduces to a celebrated relation used in many engineering analyses. Let section 1 be the inlet and section 2 the outlet. Then

$$\dot{Q} - \dot{W}_s - \dot{W}_v = -\dot{m}_1(\hat{h}_1 + \tfrac{1}{2}V_1^2 + gz_1) + \dot{m}_2(\hat{h}_2 + \tfrac{1}{2}V_2^2 + gz_2) \quad (3.65)$$

But, from continuity, $\dot{m}_1 = \dot{m}_2 = \dot{m}$, and we can rearrange (3.65) as follows:

$$\hat{h}_1 + \tfrac{1}{2}V_1^2 + gz_1 = (\hat{h}_2 + \tfrac{1}{2}V_2^2 + gz_2) - q + w_s + w_v \quad (3.66)$$

where $q = \dot{Q}/\dot{m} = dQ/dm$, the heat transferred to the fluid per unit mass. Similarly, $w_s = \dot{W}_s/\dot{m} = dW_s/dm$ and $w_v = \dot{W}_v/\dot{m} = dW_v/dm$. Equation (3.66) is a general form of the *steady-flow energy equation*, which states that the upstream *stagnation enthalpy* $H_1 = (\hat{h} + \tfrac{1}{2}V^2 + gz)_1$ differs from the downstream value H_2 only if there is heat transfer, shaft work, or viscous work as the fluid passes between sections 1 and 2. Recall that q is positive if heat is added to the control volume and that w_s and w_v are positive if work is done by the fluid on the surroundings.

Each term in Eq. (3.66) has the dimensions of energy per unit mass, or velocity squared, which is a form commonly used by mechanical engineers. If we divide through by g , each term becomes a length, or head, which is a form preferred by civil engineers. The traditional symbol for head is h , which we do not wish to confuse with enthalpy. Therefore we use internal energy in rewriting the head form of the energy relation:

$$\frac{p_1}{\gamma} + \frac{\hat{u}_1}{g} + \frac{V_1^2}{2g} + z_1 = \frac{p_2}{\gamma} + \frac{\hat{u}_2}{g} + \frac{V_2^2}{2g} + z_2 - h_q + h_s + h_v \quad (3.67)$$

where $h_q = q/g$, $h_s = w_s/g$, and $h_v = w_v/g$ are the head forms of the heat added, shaft work done, and viscous work done, respectively. The term p/γ is called *pressure head* and the term $V^2/2g$ is denoted as *velocity head*.

Friction Losses in Low-Speed Flow

A very common application of the steady-flow energy equation is for low-speed flow with no shaft work and negligible viscous work, such as liquid flow in pipes. For this case Eq. (3.67) may be written in the form

$$\frac{p_1}{\gamma} + \frac{V_1^2}{2g} + z_1 = \left(\frac{p_2}{\gamma} + \frac{V_2^2}{2g} + z_2 \right) + \frac{\hat{u}_2 - \hat{u}_1 - q}{g} \quad (3.68)$$

The term in parentheses is called the useful head or *available head* or *total head* of the flow, denoted as h_0 . The last term on the right is the difference between the available head upstream and downstream and is normally *positive*, representing the loss in head due to friction, denoted as h_f . Thus, in low-speed (nearly incompressible) flow with one inlet and one exit, we may write

$$\left(\frac{p}{\gamma} + \frac{V^2}{2g} + z \right)_{\text{in}} = \left(\frac{p}{\gamma} + \frac{V^2}{2g} + z \right)_{\text{out}} + h_{\text{friction}} - h_{\text{pump}} + h_{\text{turbine}} \quad (3.69)$$

Most of our internal-flow problems will be solved with the aid of Eq. (3.69). The h terms are all positive; that is, friction loss is always positive in real (viscous) flows, a pump adds energy (increases the left-hand side), and a turbine extracts energy from the flow. If h_p and/or h_t are included, the pump and/or turbine must lie *between* points 1 and 2. In Chaps. 5 and 6 we shall develop methods of correlating h_f losses with flow parameters in pipes, valves, fittings, and other internal-flow devices.

EXAMPLE 3.17

Gasoline at 20°C is pumped through a smooth 12-cm-diameter pipe 10 km long, at a flow rate of 75 m³/h (330 gal/min). The inlet is fed by a pump at an absolute pressure of 24 atm. The exit is at standard atmospheric pressure and is 150 m higher. Estimate the frictional head loss h_f , and compare it to the velocity head of the flow $V^2/(2g)$. (These numbers are quite realistic for liquid flow through long pipelines.)

Solution

For gasoline at 20°C, from Table A.3, $\rho = 680 \text{ kg/m}^3$, or $\gamma = (680)(9.81) = 6670 \text{ N/m}^3$. There is no shaft work; hence Eq. (3.69) applies and can be evaluated:

$$\frac{p_{\text{in}}}{\gamma} + \frac{V_{\text{in}}^2}{2g} + z_{\text{in}} = \frac{p_{\text{out}}}{\gamma} + \frac{V_{\text{out}}^2}{2g} + z_{\text{out}} + h_f \quad (1)$$

The pipe is of uniform cross section, and thus the average velocity everywhere is

$$V_{\text{in}} = V_{\text{out}} = \frac{Q}{A} = \frac{(75/3600) \text{ m}^3/\text{s}}{(\pi/4)(0.12 \text{ m})^2} \approx 1.84 \text{ m/s}$$

Being equal at inlet and exit, this term will cancel out of Eq. (1) above, but we are asked to compute the velocity head of the flow for comparison purposes:

$$\frac{V^2}{2g} = \frac{(1.84 \text{ m/s})^2}{2(9.81 \text{ m/s}^2)} \approx 0.173 \text{ m}$$

Now we are in a position to evaluate all terms in Eq. (1) except the friction head loss:

$$\frac{(24)(101,350 \text{ N/m}^2)}{6670 \text{ N/m}^3} + 0.173 \text{ m} + 0 \text{ m} = \frac{101,350 \text{ N/m}^2}{6670 \text{ N/m}^3} + 0.173 \text{ m} + 150 \text{ m} + h_f$$

$$\text{or} \quad h_f = 364.7 - 15.2 - 150 \approx 199 \text{ m} \quad \text{Ans.}$$

The friction head is larger than the elevation change Δz , and the pump must drive the flow against both changes, hence the high inlet pressure. The ratio of friction to velocity head is

$$\frac{h_f}{V^2/(2g)} \approx \frac{199 \text{ m}}{0.173 \text{ m}} \approx 1150 \quad \text{Ans.}$$

This high ratio is typical of long pipelines. (Note that we did not make direct use of the 10,000-m pipe length, whose effect is hidden within h_f .) In Chap. 6 we can state this problem in a more direct fashion: Given the flow rate, fluid, and pipe size, what inlet pressure is needed? Our correlations for h_f will lead to the estimate $p_{\text{inlet}} \approx 24 \text{ atm}$, as stated above.

EXAMPLE 3.18

Air [$R = 1715$, $c_p = 6003 \text{ ft} \cdot \text{lb}/(\text{slug} \cdot ^\circ\text{R})$] flows steadily, as shown in Fig. E3.18, through a turbine which produces 700 hp. For the inlet and exit conditions shown, estimate (a) the exit velocity V_2 and (b) the heat transferred \dot{Q} in Btu/h.

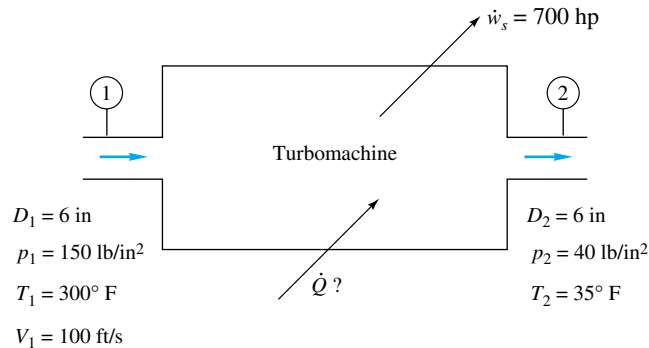

E3.18

Solution

Part (a) The inlet and exit densities can be computed from the perfect-gas law:

$$\rho_1 = \frac{p_1}{RT_1} = \frac{150(144)}{1715(460 + 300)} = 0.0166 \text{ slug/ft}^3$$

$$\rho_2 = \frac{p_2}{RT_2} = \frac{40(144)}{1715(460 + 35)} = 0.00679 \text{ slug/ft}^3$$

The mass flow is determined by the inlet conditions

$$\dot{m} = \rho_1 A_1 V_1 = (0.0166) \frac{\pi}{4} \left(\frac{6}{12} \right)^2 (100) = 0.325 \text{ slug/s}$$

Knowing mass flow, we compute the exit velocity

$$\dot{m} = 0.325 = \rho_2 A_2 V_2 = (0.00679) \frac{\pi}{4} \left(\frac{6}{12} \right)^2 V_2$$

or

$$V_2 = 244 \text{ ft/s} \quad \text{Ans. (a)}$$

Part (b) The steady-flow energy equation (3.65) applies with $\dot{W}_v = 0$, $z_1 = z_2$, and $\hat{h} = c_p T$:

$$\dot{Q} - \dot{W}_s = \dot{m} (c_p T_2 + \frac{1}{2} V_2^2 - c_p T_1 - \frac{1}{2} V_1^2)$$

Convert the turbine work to foot-pounds-force per second with the conversion factor 1 hp = 550 ft · lbf/s. The turbine work is positive

$$\begin{aligned} \dot{Q} - 700(550) &= 0.325[6003(495) + \frac{1}{2}(244)^2 - 6003(760) - \frac{1}{2}(100)^2] \\ &= -510,000 \text{ ft} \cdot \text{lbf/s} \end{aligned}$$

or

$$\dot{Q} = -125,000 \text{ ft} \cdot \text{lbf/s}$$

Convert this to British thermal units as follows:

$$\begin{aligned} \dot{Q} &= (-125,000 \text{ ft} \cdot \text{lbf/s}) \frac{3600 \text{ s/h}}{778.2 \text{ ft} \cdot \text{lbf/Btu}} \\ &= -576,000 \text{ Btu/h} \quad \text{Ans. (b)} \end{aligned}$$

The negative sign indicates that this heat transfer is a *loss* from the control volume.

Kinetic-Energy Correction Factor

Often the flow entering or leaving a port is not strictly one-dimensional. In particular, the velocity may vary over the cross section, as in Fig. E3.4. In this case the kinetic-energy term in Eq. (3.64) for a given port should be modified by a dimensionless correction factor α so that the integral can be proportional to the square of the average velocity through the port

$$\int_{\text{port}} (\frac{1}{2} V^2) \rho (\mathbf{V} \cdot \mathbf{n}) dA \equiv \alpha (\frac{1}{2} V_{\text{av}}^2) \dot{m}$$

where
$$V_{\text{av}} = \frac{1}{A} \int u dA \quad \text{for incompressible flow}$$

If the density is also variable, the integration is very cumbersome; we shall not treat this complication. By letting u be the velocity normal to the port, the first equation above becomes, for incompressible flow,

$$\frac{1}{2}\rho \int u^3 dA = \frac{1}{2}\rho\alpha V_{\text{av}}^3 A$$

$$\text{or} \quad \alpha = \frac{1}{A} \int \left(\frac{u}{V_{\text{av}}} \right)^3 dA \quad (3.70)$$

The term α is the kinetic-energy correction factor, having a value of about 2.0 for fully developed laminar pipe flow and from 1.04 to 1.11 for turbulent pipe flow. The complete incompressible steady-flow energy equation (3.69), including pumps, turbines, and losses, would generalize to

$$\left(\frac{p}{\rho g} + \frac{\alpha}{2g} V^2 + z \right)_{\text{in}} = \left(\frac{p}{\rho g} + \frac{\alpha}{2g} V^2 + z \right)_{\text{out}} + h_{\text{turbine}} - h_{\text{pump}} + h_{\text{friction}} \quad (3.71)$$

where the head terms on the right (h_t , h_p , h_f) are all numerically positive. All additive terms in Eq. (3.71) have dimensions of length $\{L\}$. In problems involving turbulent pipe flow, it is common to assume that $\alpha \approx 1.0$. To compute numerical values, we can use these approximations to be discussed in Chap. 6:

$$\text{Laminar flow:} \quad u = U_0 \left[1 - \left(\frac{r}{R} \right)^2 \right]$$

$$\text{from which} \quad V_{\text{av}} = 0.5U_0$$

$$\text{and} \quad \alpha = 2.0 \quad (3.72)$$

$$\text{Turbulent flow:} \quad u \approx U_0 \left(1 - \frac{r}{R} \right)^m \quad m \approx \frac{1}{7}$$

from which, in Example 3.4,

$$V_{\text{av}} = \frac{2U_0}{(1+m)(2+m)}$$

Substituting into Eq. (3.70) gives

$$\alpha = \frac{(1+m)^3(2+m)^3}{4(1+3m)(2+3m)} \quad (3.73)$$

and numerical values are as follows:

Turbulent flow:	m	$\frac{1}{5}$	$\frac{1}{6}$	$\frac{1}{7}$	$\frac{1}{8}$	$\frac{1}{9}$
	α	1.106	1.077	1.058	1.046	1.037

These values are only slightly different from unity and are often neglected in elementary turbulent-flow analyses. However, α should never be neglected in laminar flow.

EXAMPLE 3.19

A hydroelectric power plant (Fig. E3.19) takes in $30 \text{ m}^3/\text{s}$ of water through its turbine and discharges it to the atmosphere at $V_2 = 2 \text{ m/s}$. The head loss in the turbine and penstock system is $h_f = 20 \text{ m}$. Assuming turbulent flow, $\alpha \approx 1.06$, estimate the power in MW extracted by the turbine.

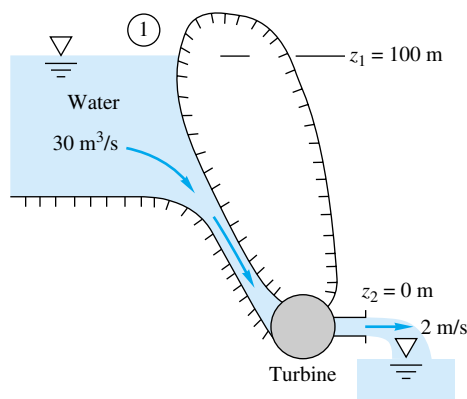
**E3.19****Solution**

We neglect viscous work and heat transfer and take section 1 at the reservoir surface (Fig. E3.19), where $V_1 \approx 0$, $p_1 = p_{\text{atm}}$, and $z_1 = 100 \text{ m}$. Section 2 is at the turbine outlet. The steady-flow energy equation (3.71) becomes, in head form,

$$\frac{p_1}{\gamma} + \frac{\alpha_1 V_1^2}{2g} + z_1 = \frac{p_2}{\gamma} + \frac{\alpha_2 V_2^2}{2g} + z_2 + h_t + h_f$$

$$\frac{p_a}{\gamma} + \frac{1.06(0)^2}{2(9.81)} + 100 \text{ m} = \frac{p_a}{\gamma} + \frac{1.06(2.0 \text{ m/s})^2}{2(9.81 \text{ m/s}^2)} + 0 \text{ m} + h_t + 20 \text{ m}$$

The pressure terms cancel, and we may solve for the turbine head (which is positive):

$$h_t = 100 - 20 - 0.2 \approx 79.8 \text{ m}$$

The turbine extracts about 79.8 percent of the 100-m head available from the dam. The total power extracted may be evaluated from the water mass flow:

$$P = \dot{m}w_s = (\rho Q)(gh_t) = (998 \text{ kg/m}^3)(30 \text{ m}^3/\text{s})(9.81 \text{ m/s}^2)(79.8 \text{ m})$$

$$= 23.4 \text{ E6 kg} \cdot \text{m}^2/\text{s}^3 = 23.4 \text{ E6 N} \cdot \text{m/s} = 23.4 \text{ MW} \quad \text{Ans. 7}$$

The turbine drives an electric generator which probably has losses of about 15 percent, so the net power generated by this hydroelectric plant is about 20 MW.

EXAMPLE 3.20

The pump in Fig. E3.20 delivers water (62.4 lbf/ft^3) at $3 \text{ ft}^3/\text{s}$ to a machine at section 2, which is 20 ft higher than the reservoir surface. The losses between 1 and 2 are given by $h_f = KV_2^2/(2g)$,

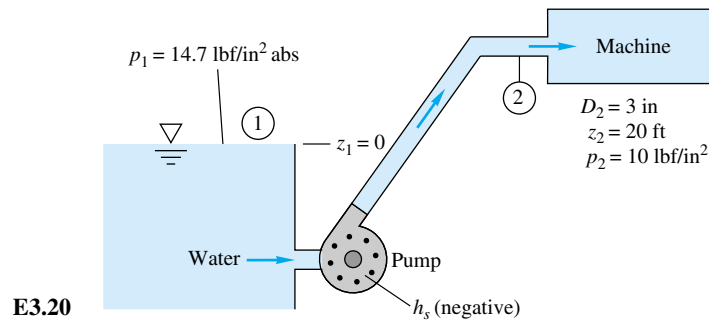

where $K \approx 7.5$ is a dimensionless loss coefficient (see Sec. 6.7). Take $\alpha \approx 1.07$. Find the horsepower required for the pump if it is 80 percent efficient.

Solution

If the reservoir is large, the flow is steady, with $V_1 \approx 0$. We can compute V_2 from the given flow rate and the pipe diameter:

$$V_2 = \frac{Q}{A_2} = \frac{3 \text{ ft}^3/\text{s}}{(\pi/4)(\frac{3}{12} \text{ ft})^2} = 61.1 \text{ ft/s}$$

The viscous work is zero because of the solid walls and near-one-dimensional inlet and exit. The steady-flow energy equation (3.71) becomes

$$\frac{p_1}{\gamma} + \frac{\alpha_1 V_1^2}{2g} + z_1 = \frac{p_2}{\gamma} + \frac{\alpha_2 V_2^2}{2g} + z_2 + h_s + h_f$$

Introducing $V_1 \approx 0$, $z_1 = 0$, and $h_f = KV_2^2/(2g)$, we may solve for the pump head:

$$h_s = \frac{p_1 - p_2}{\gamma} - z_2 - (\alpha_2 + K) \left(\frac{V_2^2}{2g} \right)$$

The pressures should be in lbf/ft^2 for consistent units. For the given data, we obtain

$$\begin{aligned} h_s &= \frac{(14.7 - 10.0)(144) \text{ lbf/ft}^2}{62.4 \text{ lbf/ft}^3} - 20 \text{ ft} - (1.07 + 7.5) \frac{(61.1 \text{ ft/s})^2}{2(32.2 \text{ ft/s}^2)} \\ &= 11 - 20 - 497 = -506 \text{ ft} \end{aligned}$$

The pump head is negative, indicating work done *on* the fluid. As in Example 3.19, the power delivered is computed from

$$P = \dot{m}w_s = \rho Qgh_s = (1.94 \text{ slug/ft}^3)(3.0 \text{ ft}^3/\text{s})(32.2 \text{ ft/s}^2)(-507 \text{ ft}) = -94,900 \text{ ft} \cdot \text{lbf/s}$$

or

$$\text{hp} = \frac{94,900 \text{ ft} \cdot \text{lbf/s}}{550 \text{ ft} \cdot \text{lbf/(s} \cdot \text{hp)}} \approx 173 \text{ hp}$$

We drop the negative sign when merely referring to the “power” required. If the pump is 80 percent efficient, the input power required to drive it is

$$P_{\text{input}} = \frac{P}{\text{efficiency}} = \frac{173 \text{ hp}}{0.8} \approx 216 \text{ hp} \quad \text{Ans.}$$

The inclusion of the kinetic-energy correction factor α in this case made a difference of about 1 percent in the result.

3.7 Frictionless Flow: The Bernoulli Equation

Closely related to the steady-flow energy equation is a relation between pressure, velocity, and elevation in a frictionless flow, now called the *Bernoulli equation*. It was stated (vaguely) in words in 1738 in a textbook by Daniel Bernoulli. A complete derivation of the equation was given in 1755 by Leonhard Euler. The Bernoulli equation is very famous and very widely used, but one should be wary of its restrictions—all fluids are viscous and thus all flows have friction to some extent. To use the Bernoulli equation correctly, one must confine it to regions of the flow which are nearly frictionless. This section (and, in more detail, Chap. 8) will address the proper use of the Bernoulli relation.

Consider Fig. 3.15, which is an elemental fixed streamtube control volume of variable area $A(s)$ and length ds , where s is the streamline direction. The properties (ρ , V , p) may vary with s and time but are assumed to be uniform over the cross section A . The streamtube orientation θ is arbitrary, with an elevation change $dz = ds \sin \theta$. Friction on the streamtube walls is shown and then neglected—a very restrictive assumption.

Conservation of mass (3.20) for this elemental control volume yields

$$\frac{d}{dt} \left(\int_{\text{CV}} \rho \, d^3\mathcal{V} \right) + \dot{m}_{\text{out}} - \dot{m}_{\text{in}} = 0 \approx \frac{\partial \rho}{\partial t} d^3\mathcal{V} + d\dot{m}$$

where $\dot{m} = \rho AV$ and $d^3\mathcal{V} \approx A \, ds$. Then our desired form of mass conservation is

$$d\dot{m} = d(\rho AV) = -\frac{\partial \rho}{\partial t} A \, ds \quad (3.74)$$

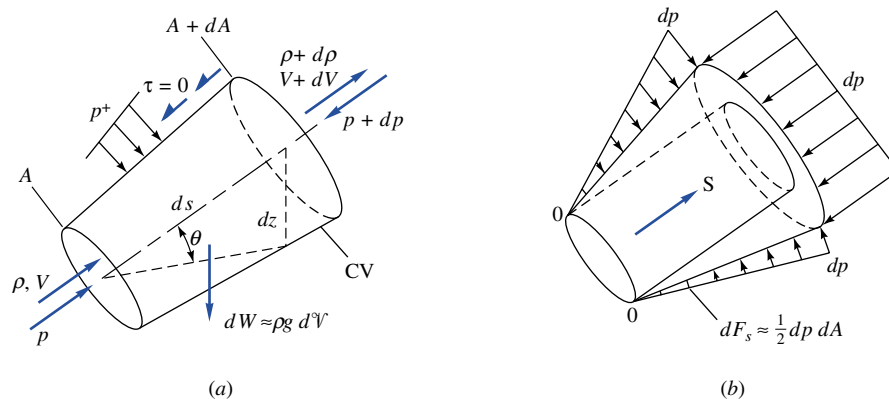

Fig. 3.15 The Bernoulli equation for frictionless flow along a streamline: (a) forces and fluxes; (b) net pressure force after uniform subtraction of p .

This relation does not require an assumption of frictionless flow.

Now write the linear-momentum relation (3.37) in the streamwise direction:

$$\sum dF_s = \frac{d}{dt} \left(\int_{CV} V \rho d^3V \right) + (\dot{m}V)_{\text{out}} - (\dot{m}V)_{\text{in}} \approx \frac{\partial}{\partial t} (\rho V) A ds + d(\dot{m}V)$$

where $V_s = V$ itself because s is the streamline direction. If we neglect the shear force on the walls (frictionless flow), the forces are due to pressure and gravity. The streamwise gravity force is due to the weight component of the fluid within the control volume:

$$dF_{s,\text{grav}} = -dW \sin \theta = -\gamma A ds \sin \theta = -\gamma A dz$$

The pressure force is more easily visualized, in Fig. 3.15*b*, by first subtracting a uniform value p from all surfaces, remembering from Fig. 3.7 that the net force is not changed. The pressure along the slanted side of the streamtube has a streamwise component which acts not on A itself but on the outer ring of area increase dA . The net pressure force is thus

$$dF_{s,\text{press}} = \frac{1}{2} dp dA - dp(A + dA) \approx -A dp$$

to first order. Substitute these two force terms into the linear-momentum relation:

$$\begin{aligned} \sum dF_s &= -\gamma A dz - A dp = \frac{\partial}{\partial t} (\rho V) A ds + d(\dot{m}V) \\ &= \frac{\partial \rho}{\partial t} VA ds + \frac{\partial V}{\partial t} \rho A ds + \dot{m} dV + V d\dot{m} \end{aligned}$$

The first and last terms on the right cancel by virtue of the continuity relation (3.74). Divide what remains by ρA and rearrange into the final desired relation:

$$\frac{\partial V}{\partial t} ds + \frac{dp}{\rho} + V dV + g dz = 0 \quad (3.75)$$

This is Bernoulli's equation for *unsteady frictionless flow along a streamline*. It is in differential form and can be integrated between any two points 1 and 2 on the streamline:

$$\int_1^2 \frac{\partial V}{\partial t} ds + \int_1^2 \frac{dp}{\rho} + \frac{1}{2} (V_2^2 - V_1^2) + g(z_2 - z_1) = 0 \quad (3.76)$$

To evaluate the two remaining integrals, one must estimate the unsteady effect $\partial V/\partial t$ and the variation of density with pressure. At this time we consider only steady ($\partial V/\partial t = 0$) incompressible (constant-density) flow, for which Eq. (3.76) becomes

$$\frac{p_2 - p_1}{\rho} + \frac{1}{2} (V_2^2 - V_1^2) + g(z_2 - z_1) = 0$$

or

$$\frac{p_1}{\rho} + \frac{1}{2} V_1^2 + gz_1 = \frac{p_2}{\rho} + \frac{1}{2} V_2^2 + gz_2 = \text{const} \quad (3.77)$$

This is the Bernoulli equation for steady frictionless incompressible flow along a streamline.

Relation between the Bernoulli and Steady-Flow Energy Equations

Equation (3.77) is a widely used form of the Bernoulli equation for incompressible steady frictionless streamline flow. It is clearly related to the steady-flow energy equation for a streamtube (flow with one inlet and one outlet), from Eq. (3.66), which we state as follows:

$$\frac{p_1}{\rho} + \frac{\alpha_1 V_1^2}{2} + gz_1 = \frac{p_2}{\rho} + \frac{\alpha_2 V_2^2}{2} + gz_2 + (\hat{u}_2 - \hat{u}_1 - q) + w_s + w_v \quad (3.78)$$

This relation is much more general than the Bernoulli equation, because it allows for (1) friction, (2) heat transfer, (3) shaft work, and (4) viscous work (another frictional effect).

If we compare the Bernoulli equation (3.77) with the energy equation (3.78), we see that the Bernoulli equation contains even more restrictions than might first be realized. The complete list of assumptions for Eq. (3.77) is as follows:

1. *Steady flow*—a common assumption applicable to many flows.
2. *Incompressible flow*—acceptable if the flow Mach number is less than 0.3.
3. *Frictionless flow*—very restrictive, solid walls introduce friction effects.
4. *Flow along a single streamline*—different streamlines may have different “Bernoulli constants” $w_0 = p/\rho + V^2/2 + gz$, depending upon flow conditions.
5. *No shaft work between 1 and 2*—no pumps or turbines on the streamline.
6. *No heat transfer between 1 and 2*—either added or removed.

Thus our warning: Be wary of misuse of the Bernoulli equation. Only a certain limited set of flows satisfies all six assumptions above. The usual momentum or “mechanical force” derivation of the Bernoulli equation does not even reveal items 5 and 6, which are thermodynamic limitations. The basic reason for restrictions 5 and 6 is that heat transfer and work transfer, in real fluids, are married to frictional effects, which therefore invalidate our assumption of frictionless flow.

Figure 3.16 illustrates some practical limitations on the use of Bernoulli’s equation (3.77). For the wind-tunnel model test of Fig. 3.16a, the Bernoulli equation is valid in the core flow of the tunnel but not in the tunnel-wall boundary layers, the model surface boundary layers, or the wake of the model, all of which are regions with high friction.

In the propeller flow of Fig. 3.16b, Bernoulli’s equation is valid both upstream and downstream, but with a different constant $w_0 = p/\rho + V^2/2 + gz$, caused by the work addition of the propeller. The Bernoulli relation (3.77) is not valid near the propeller blades or in the helical vortices (not shown, see Fig. 1.12a) shed downstream of the blade edges. Also, the Bernoulli constants are higher in the flowing “slipstream” than in the ambient atmosphere because of the slipstream kinetic energy.

For the chimney flow of Fig. 3.16c, Eq. (3.77) is valid before and after the fire, but with a change in Bernoulli constant that is caused by heat addition. The Bernoulli equation is not valid within the fire itself or in the chimney-wall boundary layers.

The moral is to apply Eq. (3.77) only when all six restrictions can be satisfied: steady incompressible flow along a streamline with no friction losses, no heat transfer, and no shaft work between sections 1 and 2.

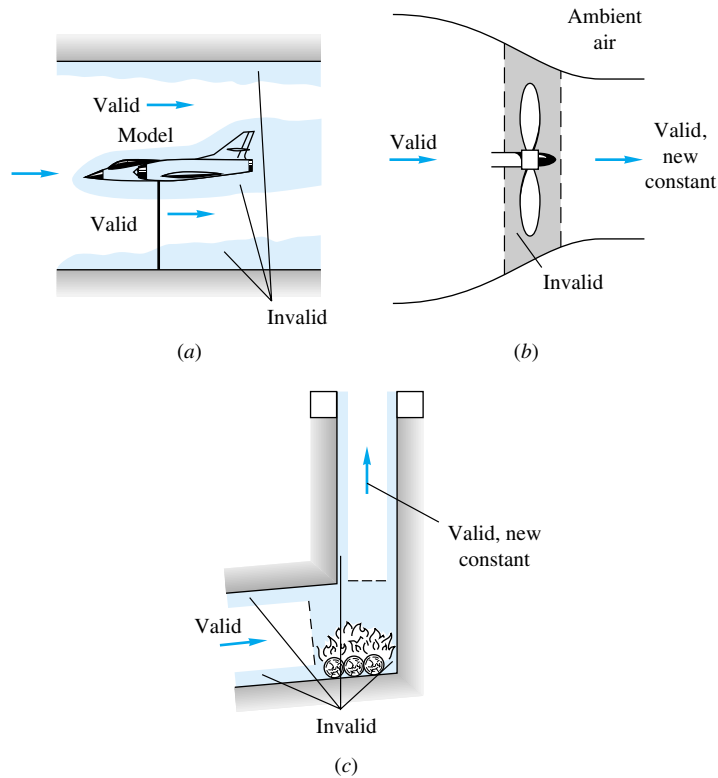

Fig. 3.16 Illustration of regions of validity and invalidity of the Bernoulli equation: (a) tunnel model, (b) propeller, (c) chimney.

Hydraulic and Energy Grade Lines

A useful visual interpretation of Bernoulli's equation is to sketch two grade lines of a flow. The *energy grade line* (EGL) shows the height of the total Bernoulli constant $h_0 = z + p/\gamma + V^2/(2g)$. In frictionless flow with no work or heat transfer, Eq. (3.77), the EGL has constant height. The *hydraulic grade line* (HGL) shows the height corresponding to elevation and pressure head $z + p/\gamma$, that is, the EGL minus the velocity head $V^2/(2g)$. The HGL is the height to which liquid would rise in a piezometer tube (see Prob. 2.11) attached to the flow. In an open-channel flow the HGL is identical to the free surface of the water.

Figure 3.17 illustrates the EGL and HGL for frictionless flow at sections 1 and 2 of a duct. The piezometer tubes measure the static-pressure head $z + p/\gamma$ and thus outline the HGL. The pitot stagnation-velocity tubes measure the total head $z + p/\gamma + V^2/(2g)$, which corresponds to the EGL. In this particular case the EGL is constant, and the HGL rises due to a drop in velocity.

In more general flow conditions, the EGL will drop slowly due to friction losses and will drop sharply due to a substantial loss (a valve or obstruction) or due to work extraction (to a turbine). The EGL can rise only if there is work addition (as from a pump or propeller). The HGL generally follows the behavior of the EGL with respect to losses or work transfer, and it rises and/or falls if the velocity decreases and/or increases.

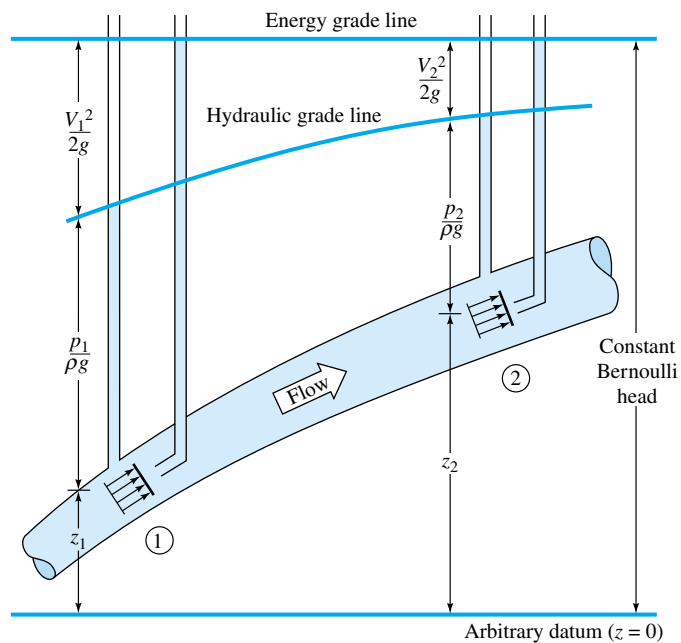

Fig. 3.17 Hydraulic and energy grade lines for frictionless flow in a duct.

As mentioned before, no conversion factors are needed in computations with the Bernoulli equation if consistent SI or BG units are used, as the following examples will show.

In all Bernoulli-type problems in this text, we consistently take point 1 upstream and point 2 downstream.

EXAMPLE 3.21

Find a relation between nozzle discharge velocity V^2 and tank free-surface height h as in Fig. E3.21. Assume steady frictionless flow.

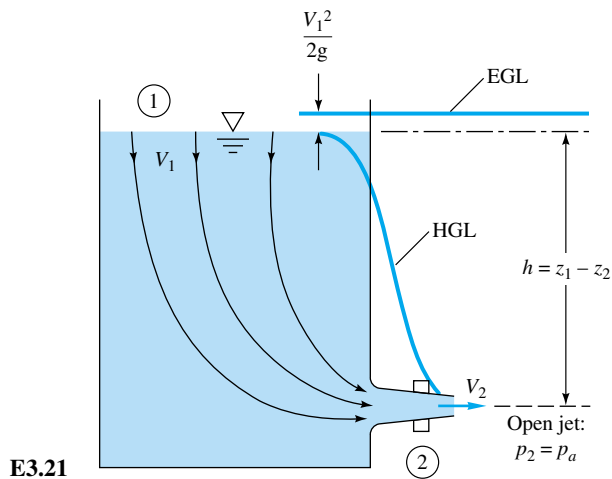

E3.21

Solution

As mentioned, we always choose point 1 upstream and point 2 downstream. Try to choose points 1 and 2 where maximum information is known or desired. Here we select point 1 as the tank free surface, where elevation and pressure are known, and point 2 as the nozzle exit, where again pressure and elevation are known. The two unknowns are V_1 and V_2 .

Mass conservation is usually a vital part of Bernoulli analyses. If A_1 is the tank cross section and A_2 the nozzle area, this is approximately a one-dimensional flow with constant density, Eq. (3.30),

$$A_1 V_1 = A_2 V_2 \quad (1)$$

Bernoulli's equation (3.77) gives

$$\frac{p_1}{\rho} + \frac{1}{2}V_1^2 + gz_1 = \frac{p_2}{\rho} + \frac{1}{2}V_2^2 + gz_2$$

But since sections 1 and 2 are both exposed to atmospheric pressure $p_1 = p_2 = p_a$, the pressure terms cancel, leaving

$$V_2^2 - V_1^2 = 2g(z_1 - z_2) = 2gh \quad (2)$$

Eliminating V_1 between Eqs. (1) and (2), we obtain the desired result:

$$V_2^2 = \frac{2gh}{1 - A_2^2/A_1^2} \quad \text{Ans. (3)}$$

Generally the nozzle area A_2 is very much smaller than the tank area A_1 , so that the ratio A_2^2/A_1^2 is doubly negligible, and an accurate approximation for the outlet velocity is

$$V_2 \approx (2gh)^{1/2} \quad \text{Ans. (4)}$$

This formula, discovered by Evangelista Torricelli in 1644, states that the discharge velocity equals the speed which a frictionless particle would attain if it fell freely from point 1 to point 2. In other words, the potential energy of the surface fluid is entirely converted to kinetic energy of efflux, which is consistent with the neglect of friction and the fact that no net pressure work is done. Note that Eq. (4) is independent of the fluid density, a characteristic of gravity-driven flows.

Except for the wall boundary layers, the streamlines from 1 to 2 all behave in the same way, and we can assume that the Bernoulli constant h_0 is the same for all the core flow. However, the outlet flow is likely to be nonuniform, not one-dimensional, so that the average velocity is only approximately equal to Torricelli's result. The engineer will then adjust the formula to include a dimensionless *discharge coefficient* c_d

$$(V_2)_{\text{av}} = \frac{Q}{A_2} = c_d(2gh)^{1/2} \quad (5)$$

As discussed in Sec. 6.10, the discharge coefficient of a nozzle varies from about 0.6 to 1.0 as a function of (dimensionless) flow conditions and nozzle shape.

Before proceeding with more examples, we should note carefully that a solution by Bernoulli's equation (3.77) does *not* require a control-volume analysis, only a selection of two points 1 and 2 along a given streamline. The control volume was used to derive the differential relation (3.75), but the integrated form (3.77) is valid all along

the streamline for frictionless flow with no heat transfer or shaft work, and a control volume is not necessary.

EXAMPLE 3.22

Rework Example 3.21 to account, at least approximately, for the unsteady-flow condition caused by the draining of the tank.

Solution

Essentially we are asked to include the unsteady integral term involving $\partial V/\partial t$ from Eq. (3.76). This will result in a new term added to Eq. (2) from Example 3.21:

$$2 \int_1^2 \frac{\partial V}{\partial t} ds + V_2^2 - V_1^2 = 2gh \quad (1)$$

Since the flow is incompressible, the continuity equation still retains the simple form $A_1 V_1 = A_2 V_2$ from Example 3.21. To integrate the unsteady term, we must estimate the acceleration all along the streamline. Most of the streamline is in the tank region where $\partial V/\partial t \approx dV_1/dt$. The length of the average streamline is slightly longer than the nozzle depth h . A crude estimate for the integral is thus

$$\int_1^2 \frac{\partial V}{\partial t} ds \approx \int_1^2 \frac{dV_1}{dt} ds \approx -\frac{dV_1}{dt} h \quad (2)$$

But since A_1 and A_2 are constant, $dV_1/dt \approx (A_2/A_1)(dV_2/dt)$. Substitution into Eq. (1) gives

$$-2h \frac{A_2}{A_1} \frac{dV_2}{dt} + V_2^2 \left(1 - \frac{A_2^2}{A_1^2}\right) \approx 2gh \quad (3)$$

This is a first-order differential equation for $V_2(t)$. It is complicated by the fact that the depth h is variable; therefore $h = h(t)$, as determined by the variation in $V_1(t)$

$$h(t) = h_0 - \int_0^t V_1 dt \quad (4)$$

Equations (3) and (4) must be solved simultaneously, but the problem is well posed and can be handled analytically or numerically. We can also estimate the size of the first term in Eq. (3) by using the approximation $V_2 \approx (2gh)^{1/2}$ from the previous example. After differentiation, we obtain

$$2h \frac{A_2}{A_1} \frac{dV_2}{dt} \approx -\left(\frac{A_2}{A_1}\right)^2 V_2^2 \quad (5)$$

which is negligible if $A_2 \ll A_1$, as originally postulated.

EXAMPLE 3.23

A constriction in a pipe will cause the velocity to rise and the pressure to fall at section 2 in the throat. The pressure difference is a measure of the flow rate through the pipe. The smoothly necked-down system shown in Fig. E3.23 is called a *venturi tube*. Find an expression for the mass flux in the tube as a function of the pressure change.

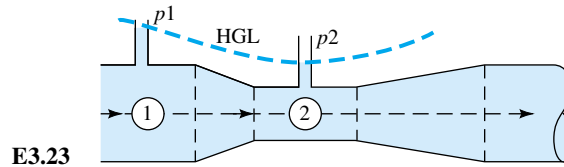

Solution

Bernoulli's equation is assumed to hold along the center streamline

$$\frac{p_1}{\rho} + \frac{1}{2}V_1^2 + gz_1 = \frac{p_2}{\rho} + \frac{1}{2}V_2^2 + gz_2$$

If the tube is horizontal, $z_1 = z_2$ and we can solve for V_2 :

$$V_2^2 - V_1^2 = \frac{2 \Delta p}{\rho} \quad \Delta p = p_1 - p_2 \quad (1)$$

We relate the velocities from the incompressible continuity relation

$$A_1 V_1 = A_2 V_2$$

or

$$V_1 = \beta^2 V_2 \quad \beta = \frac{D_2}{D_1} \quad (2)$$

Combining (1) and (2), we obtain a formula for the velocity in the throat

$$V_2 = \left[\frac{2 \Delta p}{\rho(1 - \beta^4)} \right]^{1/2} \quad (3)$$

The mass flux is given by

$$\dot{m} = \rho A_2 V_2 = A_2 \left(\frac{2\rho \Delta p}{1 - \beta^4} \right)^{1/2} \quad (4)$$

This is the ideal frictionless mass flux. In practice, we measure $\dot{m}_{\text{actual}} = c_d \dot{m}_{\text{ideal}}$ and correlate the discharge coefficient c_d .

EXAMPLE 3.24

A 10-cm fire hose with a 3-cm nozzle discharges 1.5 m³/min to the atmosphere. Assuming frictionless flow, find the force F_B exerted by the flange bolts to hold the nozzle on the hose.

Solution

We use Bernoulli's equation and continuity to find the pressure p_1 upstream of the nozzle and then we use a control-volume momentum analysis to compute the bolt force, as in Fig. E3.24.

The flow from 1 to 2 is a constriction exactly similar in effect to the venturi in Example 3.23 for which Eq. (1) gave

$$p_1 = p_2 + \frac{1}{2}\rho(V_2^2 - V_1^2) \quad (1)$$

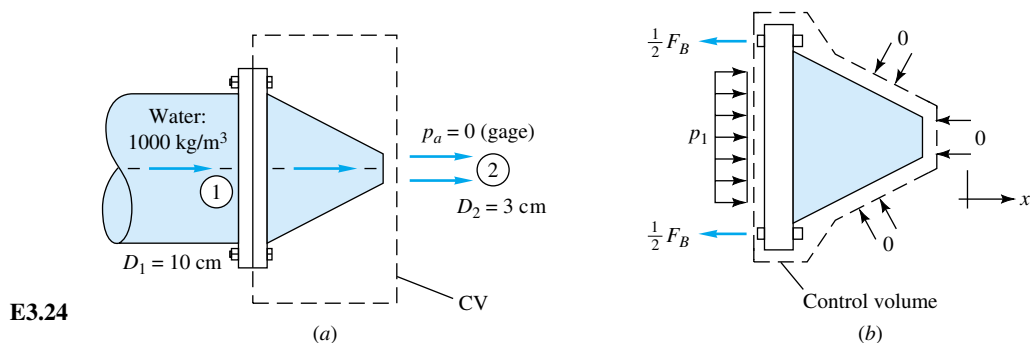

The velocities are found from the known flow rate $Q = 1.5 \text{ m}^3/\text{min}$ or $0.025 \text{ m}^3/\text{s}$:

$$V_2 = \frac{Q}{A_2} = \frac{0.025 \text{ m}^3/\text{s}}{(\pi/4)(0.03 \text{ m})^2} = 35.4 \text{ m/s}$$

$$V_1 = \frac{Q}{A_1} = \frac{0.025 \text{ m}^3/\text{s}}{(\pi/4)(0.1 \text{ m})^2} = 3.2 \text{ m/s}$$

We are given $p_2 = p_a = 0$ gage pressure. Then Eq. (1) becomes

$$\begin{aligned} p_1 &= \frac{1}{2}(1000 \text{ kg/m}^3)[(35.4^2 - 3.2^2) \text{ m}^2/\text{s}^2] \\ &= 620,000 \text{ kg}/(\text{m} \cdot \text{s}^2) = 620,000 \text{ Pa gage} \end{aligned}$$

The control-volume force balance is shown in Fig. E3.24b:

$$\sum F_x = -F_B + p_1 A_1$$

and the zero gage pressure on all other surfaces contributes no force. The x -momentum flux is $+\dot{m}V_2$ at the outlet and $-\dot{m}V_1$ at the inlet. The steady-flow momentum relation (3.40) thus gives

$$-F_B + p_1 A_1 = \dot{m}(V_2 - V_1)$$

or
$$F_B = p_1 A_1 - \dot{m}(V_2 - V_1) \quad (2)$$

Substituting the given numerical values, we find

$$\dot{m} = \rho Q = (1000 \text{ kg/m}^3)(0.025 \text{ m}^3/\text{s}) = 25 \text{ kg/s}$$

$$A_1 = \frac{\pi}{4} D_1^2 = \frac{\pi}{4} (0.1 \text{ m})^2 = 0.00785 \text{ m}^2$$

$$\begin{aligned} F_B &= (620,000 \text{ N/m}^2)(0.00785 \text{ m}^2) - (25 \text{ kg/s})[(35.4 - 3.2) \text{ m/s}] \\ &= 4872 \text{ N} - 805 \text{ (kg} \cdot \text{m)/s}^2 = 4067 \text{ N (915 lbf)} \end{aligned}$$

Ans.

This gives an idea of why it takes more than one firefighter to hold a fire hose at full discharge.

Notice from these examples that the solution of a typical problem involving Bernoulli's equation almost always leads to a consideration of the continuity equation

as an equal partner in the analysis. The only exception is when the complete velocity distribution is already known from a previous or given analysis, but that means that the continuity relation has already been used to obtain the given information. The point is that the continuity relation is always an important element in a flow analysis.

Summary

This chapter has analyzed the four basic equations of fluid mechanics: conservation of (1) mass, (2) linear momentum, (3) angular momentum, and (4) energy. The equations were attacked “in the large,” i.e., applied to whole regions of a flow. As such, the typical analysis will involve an approximation of the flow field within the region, giving somewhat crude but always instructive quantitative results. However, the basic control-volume relations are rigorous and correct and will give exact results if applied to the exact flow field.

There are two main points to a control-volume analysis. The first is the selection of a proper, clever, workable control volume. There is no substitute for experience, but the following guidelines apply. The control volume should cut through the place where the information or solution is desired. It should cut through places where maximum information is already known. If the momentum equation is to be used, it should *not* cut through solid walls unless absolutely necessary, since this will expose possible unknown stresses and forces and moments which make the solution for the desired force difficult or impossible. Finally, every attempt should be made to place the control volume in a frame of reference where the flow is steady or quasi-steady, since the steady formulation is much simpler to evaluate.

The second main point to a control-volume analysis is the reduction of the analysis to a case which applies to the problem at hand. The 24 examples in this chapter give only an introduction to the search for appropriate simplifying assumptions. You will need to solve 24 or 124 more examples to become truly experienced in simplifying the problem just enough and no more. In the meantime, it would be wise for the beginner to adopt a very general form of the control-volume conservation laws and then make a series of simplifications to achieve the final analysis. Starting with the general form, one can ask a series of questions:

1. Is the control volume nondeforming or nonaccelerating?
2. Is the flow field steady? Can we change to a steady-flow frame?
3. Can friction be neglected?
4. Is the fluid incompressible? If not, is the perfect-gas law applicable?
5. Are gravity or other body forces negligible?
6. Is there heat transfer, shaft work, or viscous work?
7. Are the inlet and outlet flows approximately one-dimensional?
8. Is atmospheric pressure important to the analysis? Is the pressure hydrostatic on any portions of the control surface?
9. Are there reservoir conditions which change so slowly that the velocity and time rates of change can be neglected?

In this way, by approving or rejecting a list of basic simplifications like those above, one can avoid pulling Bernoulli’s equation off the shelf when it does not apply.

Problems

Most of the problems herein are fairly straightforward. More difficult or open-ended assignments are labeled with an asterisk. Problems labeled with an EES icon, for example, Prob. 3.5, will benefit from the use of the Engineering Equation Solver (EES), while figures labeled with a computer disk may require the use of a computer. The standard end-of-chapter problems 3.1 to 3.182 (categorized in the problem list below) are followed by word problems W3.1 to W3.7, fundamentals of engineering (FE) exam problems FE3.1 to FE3.10, comprehensive problems C3.1 to C3.4, and design project D3.1.

Problem Distribution

Section	Topic	Problems
3.1	Basic physical laws; volume flow	3.1–3.8
3.2	The Reynolds transport theorem	3.9–3.11
3.3	Conservation of mass	3.12–3.38
3.4	The linear momentum equation	3.39–3.109
3.5	The angular momentum theorem	3.110–3.125
3.6	The energy equation	3.126–3.146
3.7	The Bernoulli equation	3.147–3.182

- P3.1** Discuss Newton's second law (the linear-momentum relation) in these three forms:

$$\sum \mathbf{F} = m\mathbf{a} \quad \sum \mathbf{F} = \frac{d}{dt}(m\mathbf{V})$$

$$\sum \mathbf{F} = \frac{d}{dt} \left(\int_{\text{system}} \mathbf{V} \rho d^3V \right)$$

Are they all equally valid? Are they equivalent? Are some forms better for fluid mechanics as opposed to solid mechanics?

- P3.2** Consider the angular-momentum relation in the form

$$\sum \mathbf{M}_O = \frac{d}{dt} \left[\int_{\text{system}} (\mathbf{r} \times \mathbf{V}) \rho d^3V \right]$$

What does \mathbf{r} mean in this relation? Is this relation valid in both solid and fluid mechanics? Is it related to the linear-momentum equation (Prob. 3.1)? In what manner?

- P3.3** For steady low-Reynolds-number (laminar) flow through a long tube (see Prob. 1.12), the axial velocity distribution is given by $u = C(R^2 - r^2)$, where R is the tube radius and $r \leq R$. Integrate $u(r)$ to find the total volume flow Q through the tube.

- P3.4** Discuss whether the following flows are steady or unsteady: (a) flow near an automobile moving at 55 mi/h, (b) flow of the wind past a water tower, (c) flow in a pipe as the downstream valve is opened at a uniform rate, (d) river flow over the spillway of a dam, and (e) flow in the ocean beneath a series of uniform propagating surface waves. Elaborate if these questions seem ambiguous.

- *P3.5** A theory proposed by S. I. Pai in 1953 gives the following velocity values $u(r)$ for turbulent (high-Reynolds-number) airflow in a 4-cm-diameter tube:

r , cm	0	0.25	0.5	0.75	1.0	1.25	1.5	1.75	2.0
u , m/s	6.00	5.97	5.88	5.72	5.51	5.23	4.89	4.43	0.00

Comment on these data vis-à-vis laminar flow, Prob. 3.3. Estimate, as best you can, the total volume flow Q through the tube, in m^3/s .

- P3.6** When a gravity-driven liquid jet issues from a slot in a tank, as in Fig. P3.6, an approximation for the exit velocity distribution is $u \approx \sqrt{2g(h-z)}$, where h is the depth of the jet centerline. Near the slot, the jet is horizontal, two-dimensional, and of thickness $2L$, as shown. Find a general expression for the total volume flow Q issuing from the slot; then take the limit of your result if $L \ll h$.

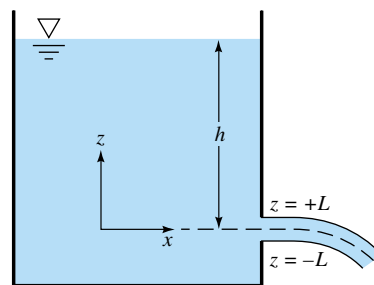

P3.6

- P3.7** Consider flow of a uniform stream U toward a circular cylinder of radius R , as in Fig. P3.7. An approximate theory for the velocity distribution near the cylinder is developed in Chap. 8, in polar coordinates, for $r \geq R$:

$$v_r = U \cos \theta \left(1 - \frac{R^2}{r^2} \right) \quad v_\theta = -U \sin \theta \left(1 + \frac{R^2}{r^2} \right)$$

where the positive directions for radial (v_r) and circumferential (v_θ) velocities are shown in Fig. P3.7. Compute the volume flow Q passing through the (imaginary) surface CC in the figure. (Comment: If CC were far upstream of the cylinder, the flow would be $Q = 2URb$.)

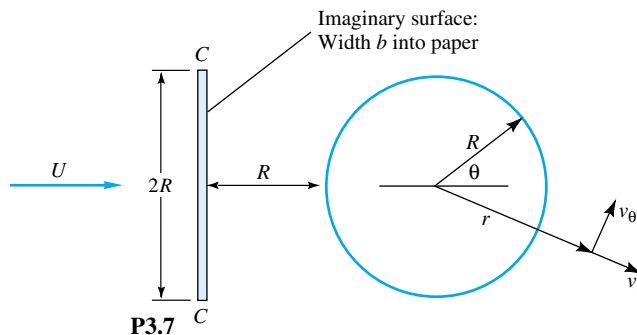

P3.7

P3.8 Consider the two-dimensional stagnation flow of Example 1.10, where $u = Kx$ and $v = -Ky$, with $K > 0$. Evaluate the volume flow Q , per unit depth into the paper, passing through the rectangular surface normal to the paper which stretches from $(x, y) = (0, 0)$ to $(1, 1)$.

P3.9 A laboratory test tank contains seawater of salinity S and density ρ . Water enters the tank at conditions (S_1, ρ_1, A_1, V_1) and is assumed to mix immediately in the tank. Tank water leaves through an outlet A_2 at velocity V_2 . If salt is a “conservative” property (neither created nor destroyed), use the Reynolds transport theorem to find an expression for the rate of change of salt mass M_{salt} within the tank.

P3.10 Laminar steady flow, through a tube of radius R and length L , is being heated at the wall. The fluid entered the tube at uniform temperature $T_0 = T_w/3$. As the fluid exits the tube, its axial velocity and enthalpy profiles are approximated by

$$u = U_0 \left(1 - \frac{r^2}{R^2}\right) \quad h = \frac{c_p T_w}{2} \left(1 + \frac{r^2}{R^2}\right)$$

$$c_p = \text{const}$$

(a) Sketch these profiles and comment on their physical realism. (b) Compute the total flux of enthalpy through the exit section.

P3.11 A room contains dust of uniform concentration $C = \rho_{\text{dust}}/\rho$. It is to be cleaned up by introducing fresh air at velocity V_i through a duct of area A_i on one wall and exhausting the room air at velocity V_o through a duct A_o on the opposite wall. Find an expression for the instantaneous rate of change of dust mass within the room.

P3.12 Water at 20°C flows steadily through a closed tank, as in Fig. P3.12. At section 1, $D_1 = 6$ cm and the volume flow is 100 m³/h. At section 2, $D_2 = 5$ cm and the average velocity is 8 m/s. If $D_3 = 4$ cm, what is (a) Q_3 in m³/h and (b) average V_3 in m/s?

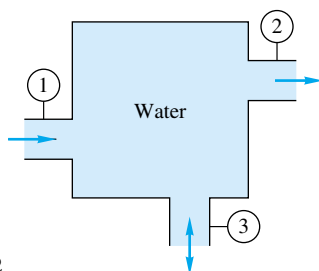

P3.12

P3.13 Water at 20°C flows steadily at 40 kg/s through the nozzle in Fig. P3.13. If $D_1 = 18$ cm and $D_2 = 5$ cm, compute the average velocity, in m/s, at (a) section 1 and (b) section 2.

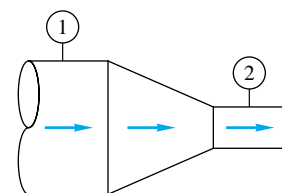

P3.13

P3.14 The open tank in Fig. P3.14 contains water at 20°C and is being filled through section 1. Assume incompressible flow. First derive an analytic expression for the water-level change dh/dt in terms of arbitrary volume flows (Q_1, Q_2, Q_3) and tank diameter d . Then, if the water level h is constant, determine the exit velocity V_2 for the given data $V_1 = 3$ m/s and $Q_3 = 0.01$ m³/s.

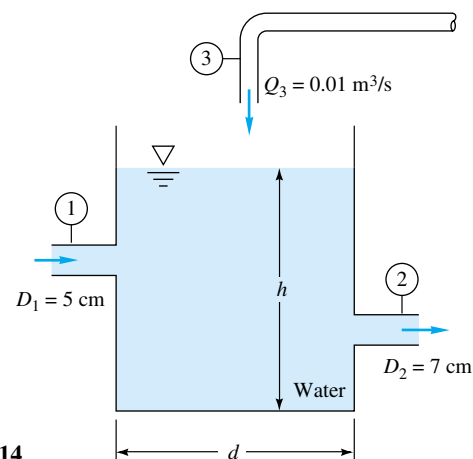

P3.14

P3.15 Water, assumed incompressible, flows steadily through the round pipe in Fig. P3.15. The entrance velocity is constant, $u = U_0$, and the exit velocity approximates turbulent flow, $u = u_{\text{max}}(1 - r/R)^{1/7}$. Determine the ratio U_0/u_{max} for this flow.

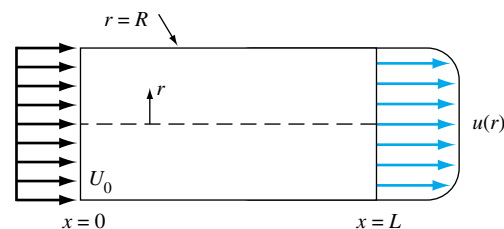

P3.15

P3.16 An incompressible fluid flows past an impermeable flat plate, as in Fig. P3.16, with a uniform inlet profile $u = U_0$ and a cubic polynomial exit profile

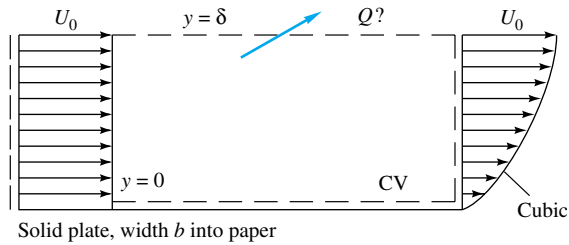

P3.16

$$u \approx U_0 \left(\frac{3\eta - \eta^3}{2} \right) \quad \text{where } \eta = \frac{y}{\delta}$$

Compute the volume flow Q across the top surface of the control volume.

- P3.17** Incompressible steady flow in the inlet between parallel plates in Fig. P3.17 is uniform, $u = U_0 = 8$ cm/s, while downstream the flow develops into the parabolic laminar profile $u = az(z_0 - z)$, where a is a constant. If $z_0 = 4$ cm and the fluid is SAE 30 oil at 20°C , what is the value of u_{\max} in cm/s?

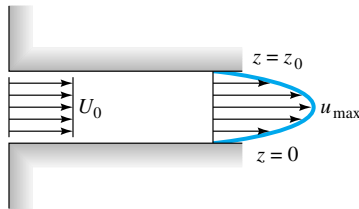

P3.17

- P3.18** An incompressible fluid flows steadily through the rectangular duct in Fig. P3.18. The exit velocity profile is given approximately by

$$u = u_{\max} \left(1 - \frac{y^2}{b^2} \right) \left(1 - \frac{z^2}{h^2} \right)$$

(a) Does this profile satisfy the correct boundary conditions for viscous fluid flow? (b) Find an analytical expression for the volume flow Q at the exit. (c) If the inlet flow is 300 ft³/min, estimate u_{\max} in m/s for $b = h = 10$ cm.

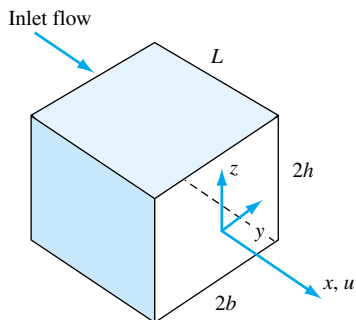

P3.18

- P3.19** A partly full water tank admits water at 20°C and 85 N/s weight flow while ejecting water on the other side at 5500 cm³/s. The air pocket in the tank has a vent at the top and is at 20°C and 1 atm. If the fluids are approximately incompressible, how much air in N/h is passing through the vent? In which direction?

- P3.20** Oil (SG = 0.89) enters at section 1 in Fig. P3.20 at a weight flow of 250 N/h to lubricate a thrust bearing. The steady oil flow exits radially through the narrow clearance between thrust plates. Compute (a) the outlet volume flux in mL/s and (b) the average outlet velocity in cm/s.

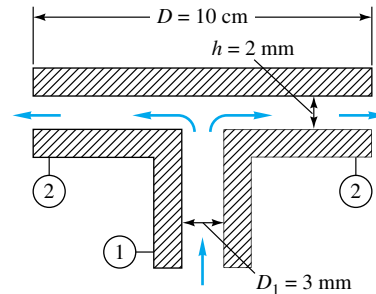

P3.20

- P3.21** A dehumidifier brings in saturated wet air (100 percent relative humidity) at 30°C and 1 atm, through an inlet of 8 -cm diameter and average velocity 3 m/s. After some of the water vapor condenses and is drained off at the bottom, the somewhat drier air leaves at approximately 30°C , 1 atm, and 50 percent relative humidity. For steady operation, estimate the amount of water drained off in kg/h. (This problem is idealized from a real dehumidifier.)

- P3.22** The converging-diverging nozzle shown in Fig. P3.22 expands and accelerates dry air to supersonic speeds at the exit, where $p_2 = 8$ kPa and $T_2 = 240$ K. At the throat, $p_1 = 284$ kPa, $T_1 = 665$ K, and $V_1 = 517$ m/s. For steady compressible flow of an ideal gas, estimate (a) the mass flow in kg/h, (b) the velocity V_2 , and (c) the Mach number Ma_2 .

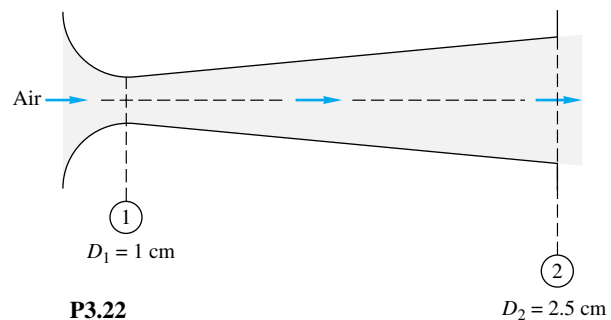

P3.22

- P3.23** The hypodermic needle in Fig. P3.23 contains a liquid serum (SG = 1.05). If the serum is to be injected steadily at $6 \text{ cm}^3/\text{s}$, how fast in in/s should the plunger be advanced (a) if leakage in the plunger clearance is neglected and (b) if leakage is 10 percent of the needle flow?

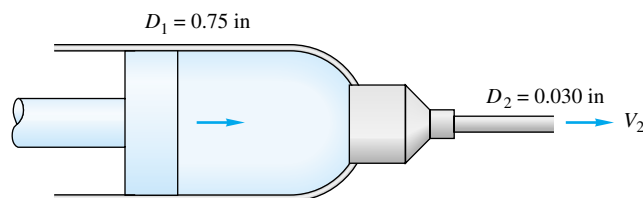
P3.23

- *P3.24** Water enters the bottom of the cone in Fig. P3.24 at a uniformly increasing average velocity $V = Kt$. If d is very small, derive an analytic formula for the water surface rise $h(t)$ for the condition $h = 0$ at $t = 0$. Assume incompressible flow.

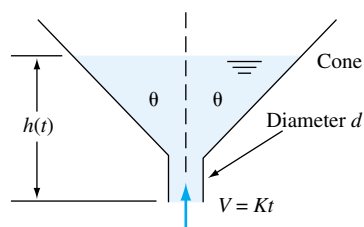
P3.24

- P3.25** As will be discussed in Chaps. 7 and 8, the flow of a stream U_0 past a blunt flat plate creates a broad low-velocity wake behind the plate. A simple model is given in Fig. P3.25, with only half of the flow shown due to symmetry. The velocity profile behind the plate is idealized as “dead air” (near-zero velocity) behind the plate, plus a higher velocity, decaying vertically above the wake according to the variation $u \approx U_0 + \Delta U e^{-z/L}$, where L is the plate height and $z = 0$ is the top of the wake. Find ΔU as a function of stream speed U_0 .

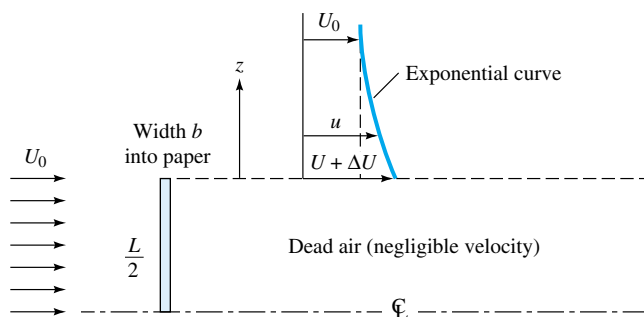
P3.25

- P3.26** A thin layer of liquid, draining from an inclined plane, as in Fig. P3.26, will have a laminar velocity profile $u \approx U_0(2y/h - y^2/h^2)$, where U_0 is the surface velocity. If the plane has width b into the paper, determine the volume rate of flow in the film. Suppose that $h = 0.5$ in and the flow rate per foot of channel width is 1.25 gal/min. Estimate U_0 in ft/s.

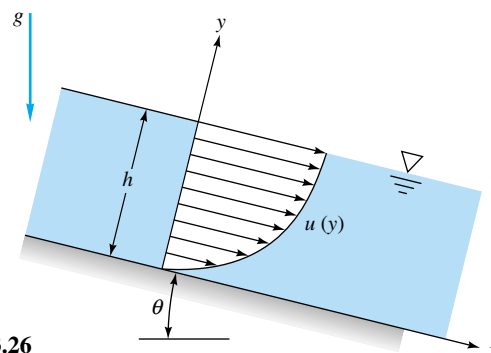

P3.26

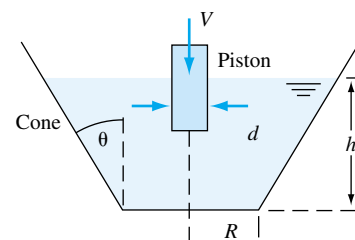
- *P3.27** The cone frustum in Fig. P3.27 contains incompressible liquid to depth h . A solid piston of diameter d penetrates the surface at velocity V . Derive an analytic expression for the rate of rise dh/dt of the liquid surface.

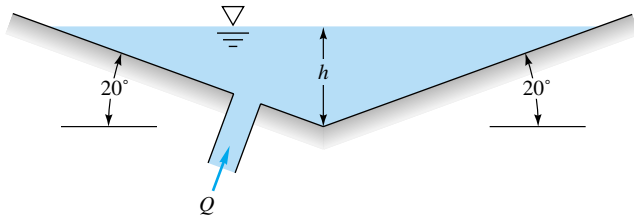

P3.27

- P3.28** Consider a cylindrical water tank of diameter D and water depth h . According to elementary theory, the flow rate from a small hole of area A in the bottom of the tank would be $Q \approx CA \sqrt{2gh}$, where $C \approx 0.61$. If the initial water level is h_0 and the hole is opened, derive an expression for the time required for the water level to drop to $\frac{1}{3}h_0$.
- P3.29** In elementary compressible-flow theory (Chap. 9), compressed air will exhaust from a small hole in a tank at the mass flow rate $\dot{m} \approx C\rho$, where ρ is the air density in the tank and C is a constant. If ρ_0 is the initial density in a tank of volume \mathcal{V} , derive a formula for the density change $\rho(t)$ after the hole is opened. Apply your formula to the following case: a spherical tank of diameter 50 cm, with initial pressure 300 kPa and temperature 100°C , and a hole whose initial exhaust rate is 0.01 kg/s. Find the time required for the tank density to drop by 50 percent.

- *P3.30** The V-shaped tank in Fig. P3.30 has width b into the paper and is filled from the inlet pipe at volume flow Q . Derive expressions for (a) the rate of change dh/dt and (b) the time required for the surface to rise from h_1 to h_2 .

P3.30

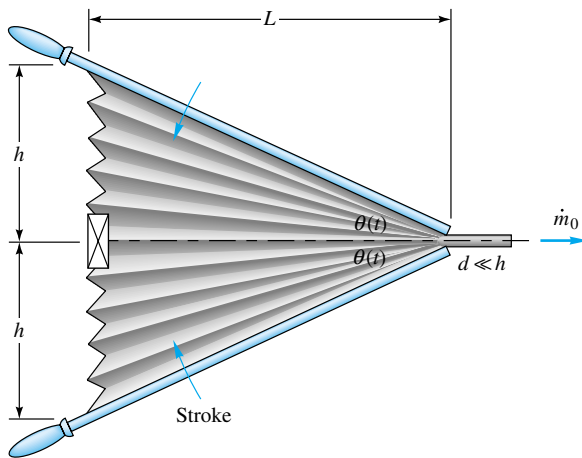
- P3.31** A bellows may be modeled as a deforming wedge-shaped volume as in Fig. P3.31. The check valve on the left (pleated) end is closed during the stroke. If b is the bellows width into the paper, derive an expression for outlet mass flow \dot{m}_0 as a function of stroke $\theta(t)$.

P3.31

- P3.32** Water at 20°C flows steadily through the piping junction in Fig. P3.32, entering section 1 at 20 gal/min. The average velocity at section 2 is 2.5 m/s. A portion of the flow is diverted through the showerhead, which contains 100 holes of 1-mm diameter. Assuming uniform shower flow, estimate the exit velocity from the showerhead jets.

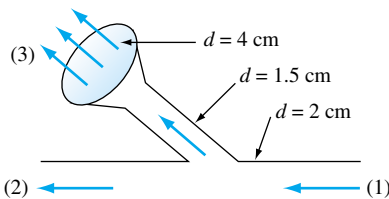
P3.32

- P3.33** In some wind tunnels the test section is perforated to suck out fluid and provide a thin viscous boundary layer. The test section wall in Fig. P3.33 contains 1200 holes of 5-mm diameter each per square meter of wall area. The suction velocity through each hole is $V_s = 8$ m/s, and the test-section entrance velocity is $V_1 = 35$ m/s. Assuming incompressible steady flow of air at 20°C, compute (a) V_0 , (b) V_2 , and (c) V_f in m/s.

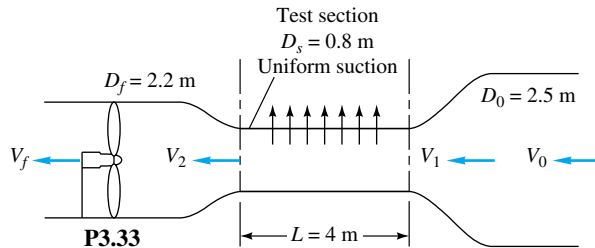
P3.33

- P3.34** A rocket motor is operating steadily, as shown in Fig. P3.34. The products of combustion flowing out the exhaust nozzle approximate a perfect gas with a molecular weight of 28. For the given conditions calculate V_2 in ft/s.

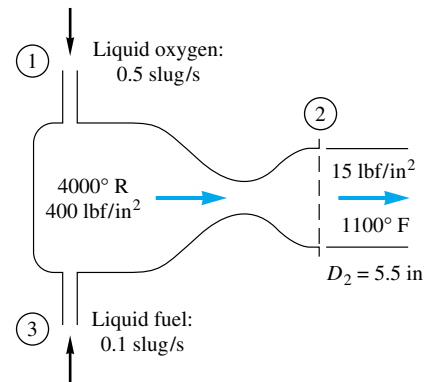
P3.34

- P3.35** In contrast to the liquid rocket in Fig. P3.34, the solid-propellant rocket in Fig. P3.35 is self-contained and has no entrance ducts. Using a control-volume analysis for the conditions shown in Fig. P3.35, compute the rate of mass loss of the propellant, assuming that the exit gas has a molecular weight of 28.

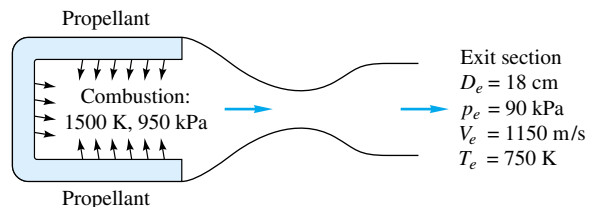
P3.35

- P3.36** The jet pump in Fig. P3.36 injects water at $U_1 = 40$ m/s through a 3-in-pipe and entrains a secondary flow of water $U_2 = 3$ m/s in the annular region around the small pipe. The two flows become fully mixed downstream, where U_3 is approximately constant. For steady incompressible flow, compute U_3 in m/s.

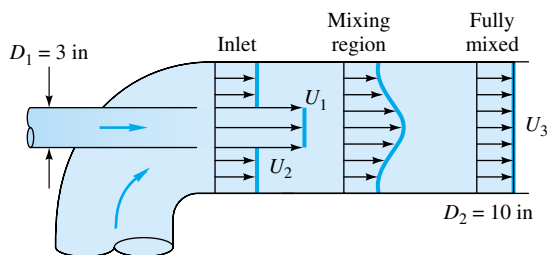
P3.36

- P3.37** A solid steel cylinder, 4.5 cm in diameter and 12 cm long, with a mass of 1500 g, falls concentrically through a 5-cm-diameter vertical container filled with oil (SG = 0.89). Assuming the oil is incompressible, estimate the oil average velocity in the annular clearance between cylinder and container (a) relative to the container and (b) relative to the cylinder.
- P3.38** An incompressible fluid in Fig. P3.38 is being squeezed outward between two large circular disks by the uniform downward motion V_0 of the upper disk. Assuming one-dimensional radial outflow, use the control volume shown to derive an expression for $V(r)$.

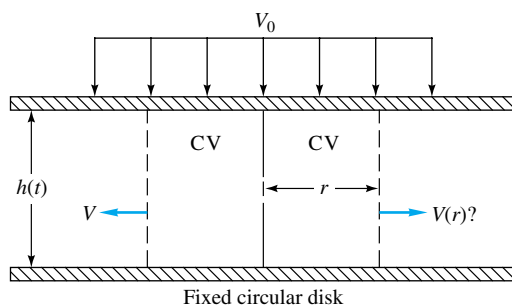
P3.38

- P3.39** For the elbow duct in Fig. P3.39, SAE 30 oil at 20°C enters section 1 at 350 N/s, where the flow is laminar, and exits at section 2, where the flow is turbulent:

$$u_1 \approx V_{av,1} \left(1 - \frac{r^2}{R_1^2} \right) \quad u_2 \approx V_{av,2} \left(1 - \frac{r}{R_2} \right)^{1/7}$$

Assuming steady incompressible flow, compute the force, and its direction, of the oil on the elbow due to momentum change only (no pressure change or friction effects) for (a) unit momentum-flux correction factors and (b) actual correction factors β_1 and β_2 .

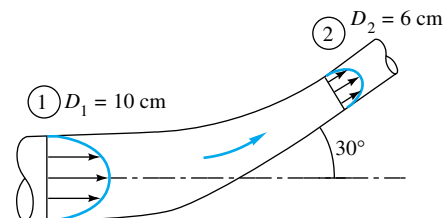
P3.39

- P3.40** The water jet in Fig. P3.40 strikes normal to a fixed plate. Neglect gravity and friction, and compute the force F in newtons required to hold the plate fixed.

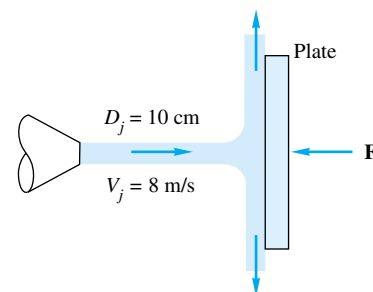

P3.40

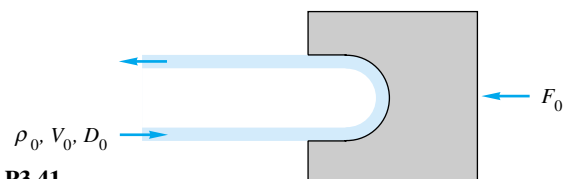
- P3.41** In Fig. P3.41 the vane turns the water jet completely around. Find an expression for the maximum jet velocity V_0 if the maximum possible support force is F_0 .

P3.41

- P3.42** A liquid of density ρ flows through the sudden contraction in Fig. P3.42 and exits to the atmosphere. Assume uniform conditions (p_1, V_1, D_1) at section 1 and (p_2, V_2, D_2) at sec-

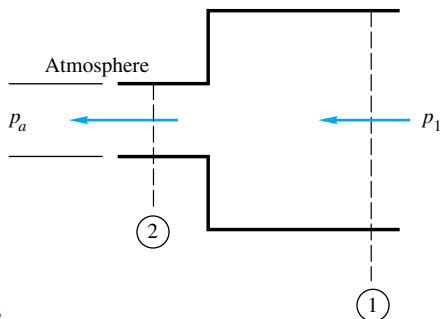
tion 2. Find an expression for the force F exerted by the fluid on the contraction.



P3.42

P3.43 Water at 20°C flows through a 5-cm-diameter pipe which has a 180° vertical bend, as in Fig. P3.43. The total length of pipe between flanges 1 and 2 is 75 cm. When the weight flow rate is 230 N/s, $p_1 = 165$ kPa and $p_2 = 134$ kPa. Neglecting pipe weight, determine the total force which the flanges must withstand for this flow.

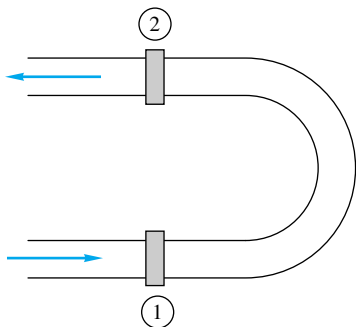

P3.43

***P3.44** When a uniform stream flows past an immersed thick cylinder, a broad low-velocity wake is created downstream, idealized as a V shape in Fig. P3.44. Pressures p_1 and p_2 are approximately equal. If the flow is two-dimensional and incompressible, with width b into the paper, derive a

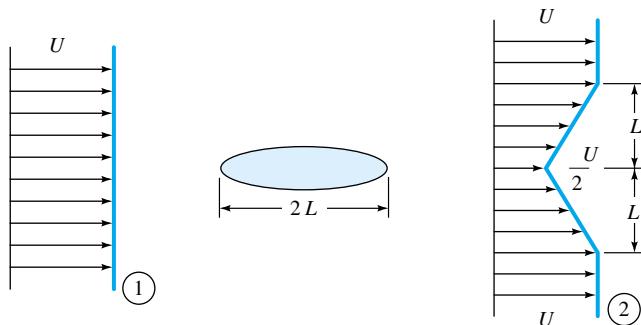

P3.44

formula for the drag force F on the cylinder. Rewrite your result in the form of a dimensionless *drag coefficient* based on body length $C_D = F/(\rho U^2 b L)$.

P3.45 In Fig. P3.45 a perfectly balanced weight and platform are supported by a steady water jet. If the total weight supported is 700 N, what is the proper jet velocity?

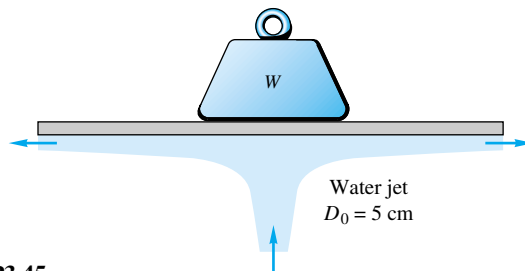

P3.45

P3.46 When a jet strikes an inclined fixed plate, as in Fig. P3.46, it breaks into two jets at 2 and 3 of equal velocity $V = V_{\text{jet}}$ but unequal fluxes αQ at 2 and $(1 - \alpha)Q$ at section 3, α being a fraction. The reason is that for frictionless flow the fluid can exert no tangential force F_t on the plate. The condition $F_t = 0$ enables us to solve for α . Perform this analysis, and find α as a function of the plate angle θ . Why doesn't the answer depend upon the properties of the jet?

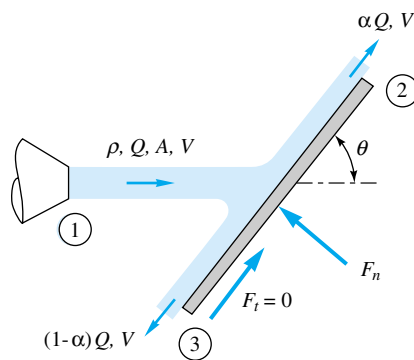

P3.46

P3.47 A liquid jet of velocity V_j and diameter D_j strikes a fixed hollow cone, as in Fig. P3.47, and deflects back as a conical sheet at the same velocity. Find the cone angle θ for which the restraining force $F = \frac{3}{2}\rho A_j V_j^2$.

P3.48 The small boat in Fig. P3.48 is driven at a steady speed V_0 by a jet of compressed air issuing from a 3-cm-diameter hole at $V_e = 343$ m/s. Jet exit conditions are $p_e = 1$ atm and $T_e = 30^\circ\text{C}$. Air drag is negligible, and the hull drag is kV_0^2 , where $k \approx 19 \text{ N} \cdot \text{s}^2/\text{m}^2$. Estimate the boat speed V_0 , in m/s.

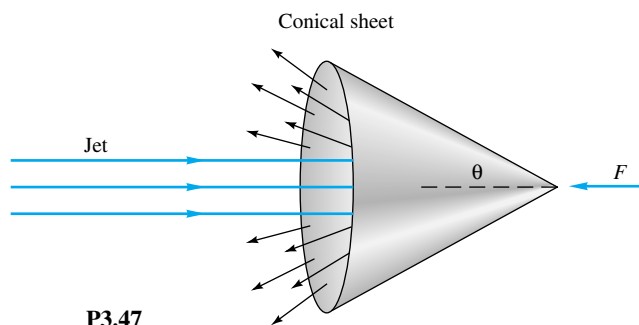

P3.47

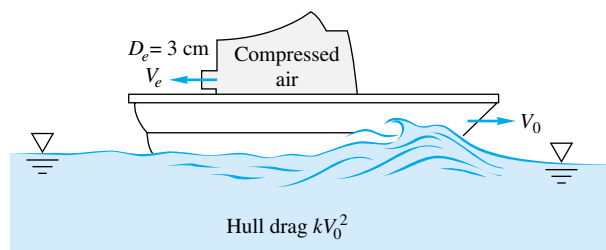

P3.48

- P3.49** The horizontal nozzle in Fig. P3.49 has $D_1 = 12$ in and $D_2 = 6$ in, with inlet pressure $p_1 = 38$ lbf/in² absolute and $V_2 = 56$ ft/s. For water at 20°C, compute the horizontal force provided by the flange bolts to hold the nozzle fixed.

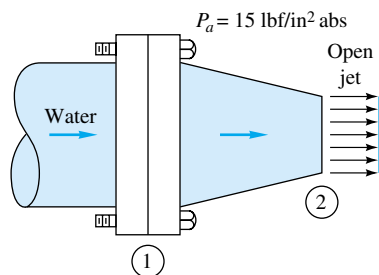

P3.49

- P3.50** The jet engine on a test stand in Fig. P3.50 admits air at 20°C and 1 atm at section 1, where $A_1 = 0.5$ m² and $V_1 = 250$ m/s. The fuel-to-air ratio is 1:30. The air leaves sec-

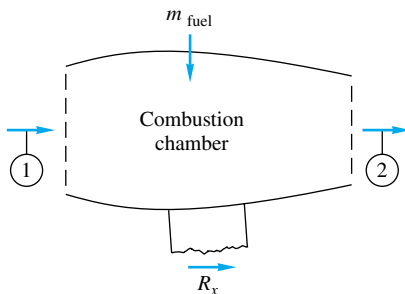

P3.50

tion 2 at atmospheric pressure and higher temperature, where $V_2 = 900$ m/s and $A_2 = 0.4$ m². Compute the horizontal test stand reaction R_x needed to hold this engine fixed.

- P3.51** A liquid jet of velocity V_j and area A_j strikes a single 180° bucket on a turbine wheel rotating at angular velocity Ω , as in Fig. P3.51. Derive an expression for the power P delivered to this wheel at this instant as a function of the system parameters. At what angular velocity is the maximum power delivered? How would your analysis differ if there were many, many buckets on the wheel, so that the jet was continually striking at least one bucket?

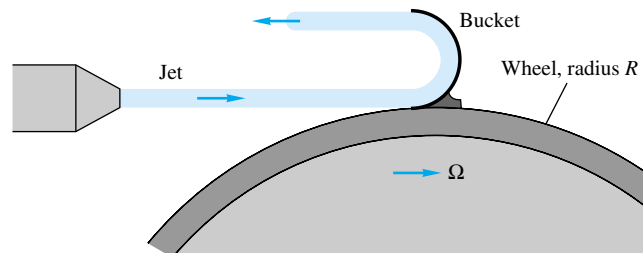

P3.51

- P3.52** The vertical gate in a water channel is partially open, as in Fig. P3.52. Assuming no change in water level and a hydrostatic pressure distribution, derive an expression for the streamwise force F_x on one-half of the gate as a function of $(\rho, h, w, \theta, V_1)$. Apply your result to the case of water at 20°C, $V_1 = 0.8$ m/s, $h = 2$ m, $w = 1.5$ m, and $\theta = 50^\circ$.

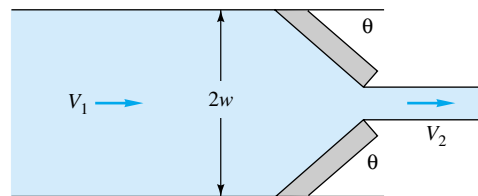

Top view

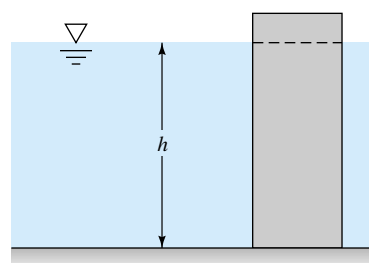

Side view

P3.52

P3.53 Consider incompressible flow in the entrance of a circular tube, as in Fig. P3.53. The inlet flow is uniform, $u_1 = U_0$. The flow at section 2 is developed pipe flow. Find the wall drag force F as a function of (p_1, p_2, ρ, U_0, R) if the flow at section 2 is

- (a) Laminar: $u_2 = u_{\max} \left(1 - \frac{r^2}{R^2}\right)$
 (b) Turbulent: $u_2 \approx u_{\max} \left(1 - \frac{r}{R}\right)^{1/7}$

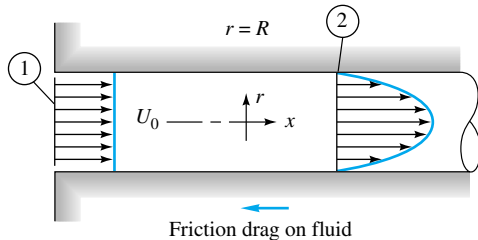

P3.53

P3.54 For the pipe-flow-reducing section of Fig. P3.54, $D_1 = 8$ cm, $D_2 = 5$ cm, and $p_2 = 1$ atm. All fluids are at 20°C . If $V_1 = 5$ m/s and the manometer reading is $h = 58$ cm, estimate the total force resisted by the flange bolts.

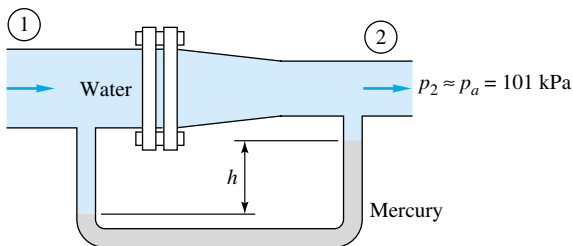

P3.54

P3.55 In Fig. P3.55 the jet strikes a vane which moves to the right at constant velocity V_c on a frictionless cart. Compute (a) the force F_x required to restrain the cart and (b)

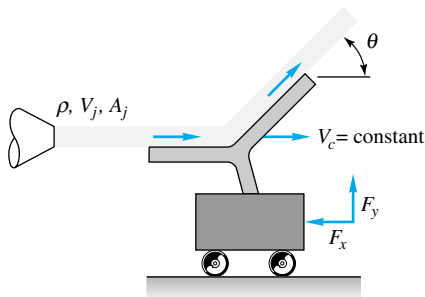

P3.55

the power P delivered to the cart. Also find the cart velocity for which (c) the force F_x is a maximum and (d) the power P is a maximum.

P3.56 For the flat-plate boundary-layer flow of Fig. 3.11, assume that the exit profile is given by $u \approx U_0 \sin[\pi y/(2\delta)]$ for water flow at 20°C : $U_0 = 3$ m/s, $\delta = 2$ mm, and $L = 45$ cm. Estimate the total drag force on the plate, in N, per unit depth into the paper.

***P3.57** Laminar-flow theory [Ref. 3 of Chap. 1, p. 260] gives the following expression for the wake behind a flat plate of length L (see Fig. P3.44 for a crude sketch of wake):

$$u = U \left[1 - \frac{0.664}{\pi} \left(\frac{L}{x} \right)^{1/2} \exp\left(-\frac{y^2 \rho U}{4x\mu} \right) \right]$$

where U is the stream velocity, x is distance downstream of the plate, and $y = 0$ is the plane of the plate. Sketch two wake profiles, for $u_{\min} = 0.9U$ and $u_{\min} = 0.8U$. For these two profiles, evaluate the momentum-flux defect, i.e., the difference between the momentum of a uniform stream U and the actual wake profile. Comment on your results.

P3.58 The water tank in Fig. P3.58 stands on a frictionless cart and feeds a jet of diameter 4 cm and velocity 8 m/s, which is deflected 60° by a vane. Compute the tension in the supporting cable.

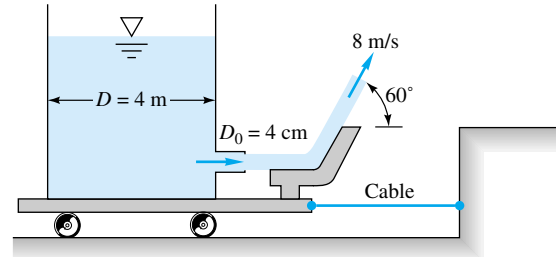

P3.58

P3.59 When a pipe flow suddenly expands from A_1 to A_2 , as in Fig. P3.59, low-speed, low-friction eddies appear in the

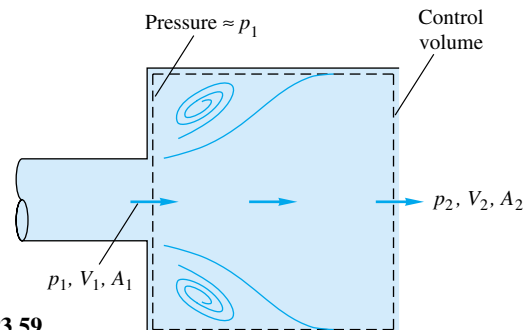

P3.59

corners and the flow gradually expands to A_2 downstream. Using the suggested control volume for incompressible steady flow and assuming that $p \approx p_1$ on the corner annular ring as shown, show that the downstream pressure is given by

$$p_2 = p_1 + \rho V_1^2 \frac{A_1}{A_2} \left(1 - \frac{A_1}{A_2}\right)$$

Neglect wall friction.

- P3.60** Water at 20°C flows through the elbow in Fig. P3.60 and exits to the atmosphere. The pipe diameter is $D_1 = 10$ cm, while $D_2 = 3$ cm. At a weight flow rate of 150 N/s, the pressure $p_1 = 2.3$ atm (gage). Neglecting the weight of water and elbow, estimate the force on the flange bolts at section 1.

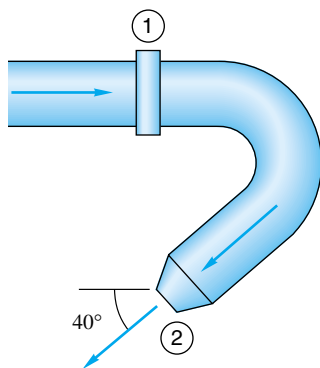

P3.60

- P3.61** A 20°C water jet strikes a vane mounted on a tank with frictionless wheels, as in Fig. P3.61. The jet turns and falls into the tank without spilling out. If $\theta = 30^\circ$, evaluate the horizontal force F required to hold the tank stationary.

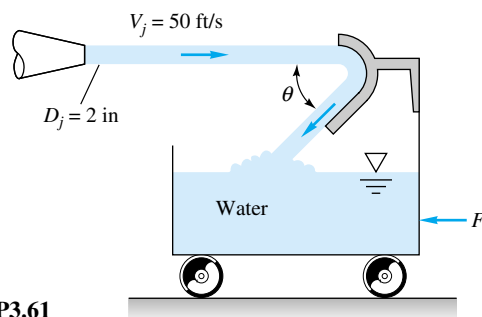

P3.61

- P3.62** Water at 20°C exits to the standard sea-level atmosphere through the split nozzle in Fig. P3.62. Duct areas are $A_1 = 0.02$ m² and $A_2 = A_3 = 0.008$ m². If $p_1 = 135$ kPa (absolute) and the flow rate is $Q_2 = Q_3 = 275$ m³/h, compute the force on the flange bolts at section 1.

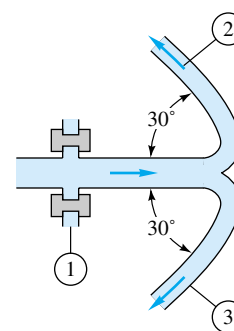

P3.62

- *P3.63** The sluice gate in Fig. P3.63 can control and measure flow in open channels. At sections 1 and 2, the flow is uniform and the pressure is hydrostatic. The channel width is b into the paper. Neglecting bottom friction, derive an expression for the force F required to hold the gate. For what condition h_2/h_1 is the force largest? For very low velocity $V_1^2 \ll gh_1$, for what value of h_2/h_1 will the force be one-half of the maximum?

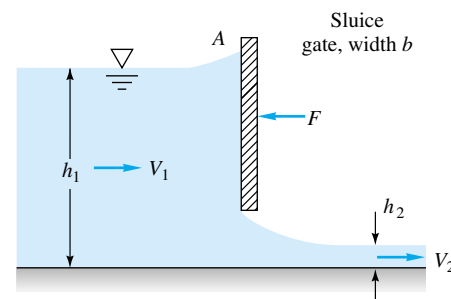

P3.63

- P3.64** The 6-cm-diameter 20°C water jet in Fig. P3.64 strikes a plate containing a hole of 4-cm diameter. Part of the jet

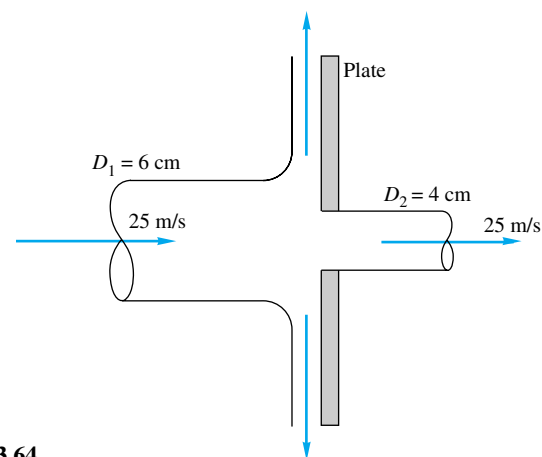

P3.64

passes through the hole, and part is deflected. Determine the horizontal force required to hold the plate.

- P3.65** The box in Fig. P3.65 has three 0.5-in holes on the right side. The volume flows of 20°C water shown are steady, but the details of the interior are not known. Compute the force, if any, which this water flow causes on the box.

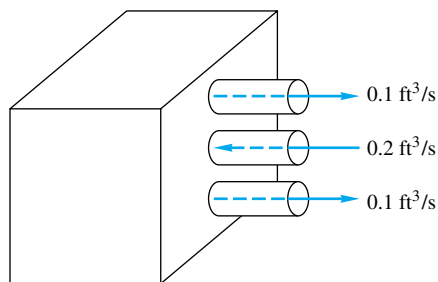

P3.65

- P3.66** The tank in Fig. P3.66 weighs 500 N empty and contains 600 L of water at 20°C. Pipes 1 and 2 have equal diameters of 6 cm and equal steady volume flows of 300 m³/h. What should the scale reading W be in N?

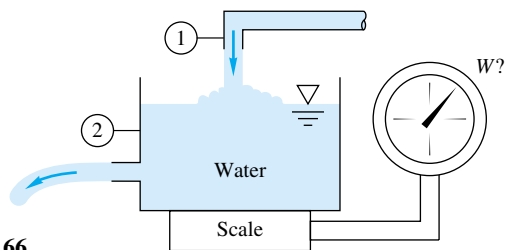

P3.66

- P3.67** Gravel is dumped from a hopper, at a rate of 650 N/s, onto a moving belt, as in Fig. P3.67. The gravel then passes off the end of the belt. The drive wheels are 80 cm in diameter and rotate clockwise at 150 r/min. Neglecting system friction and air drag, estimate the power required to drive this belt.

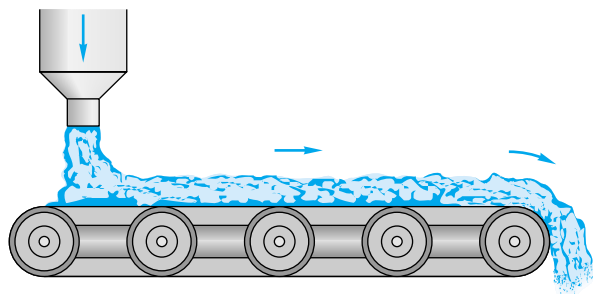

P3.67

- P3.68** The rocket in Fig. P3.68 has a supersonic exhaust, and the exit pressure p_e is not necessarily equal to p_a . Show that the force F required to hold this rocket on the test stand is $F = \rho_e A_e V_e^2 + A_e(p_e - p_a)$. Is this force F what we term the *thrust* of the rocket?

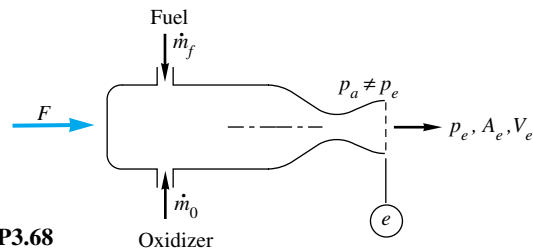

P3.68

- P3.69** The solution to Prob. 3.22 is a mass flow of 218 kg/h with $V_2 = 1060$ m/s and $\text{Ma}_2 = 3.41$. If the conical section 1–2 in Fig. P3.22 is 12 cm long, estimate the force on these conical walls caused by this high-speed gas flow.
- P3.70** The dredger in Fig. P3.70 is loading sand (SG = 2.6) onto a barge. The sand leaves the dredger pipe at 4 ft/s with a weight flux of 850 lbf/s. Estimate the tension on the mooring line caused by this loading process.

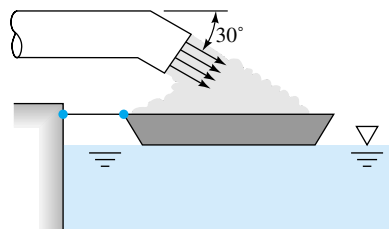

P3.70

- P3.71** Suppose that a deflector is deployed at the exit of the jet engine of Prob. 3.50, as shown in Fig. P3.71. What will the reaction R_x on the test stand be now? Is this reaction sufficient to serve as a braking force during airplane landing?

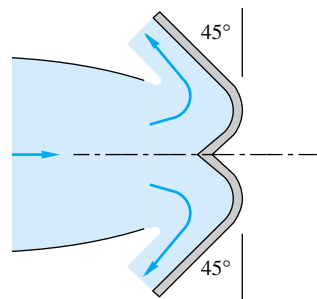

P3.71

- *P3.72** When immersed in a uniform stream, a thick elliptical cylinder creates a broad downstream wake, as idealized in

Fig. P3.72. The pressure at the upstream and downstream sections are approximately equal, and the fluid is water at 20°C. If $U_0 = 4$ m/s and $L = 80$ cm, estimate the drag force on the cylinder per unit width into the paper. Also compute the dimensionless drag coefficient $C_D = 2F/(\rho U_0^2 bL)$.

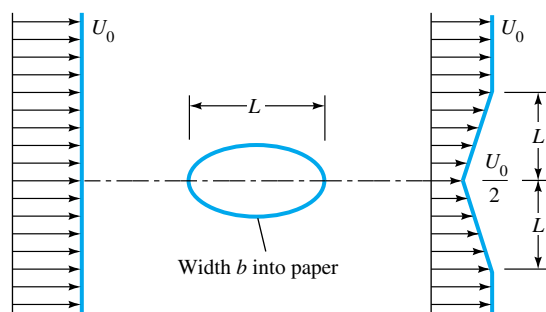

P3.72

- P3.73** A pump in a tank of water at 20°C directs a jet at 45 ft/s and 200 gal/min against a vane, as shown in Fig. P3.73. Compute the force F to hold the cart stationary if the jet follows (a) path A or (b) path B. The tank holds 550 gal of water at this instant.

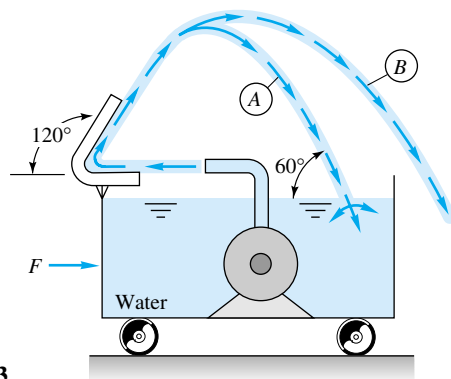

P3.73

- P3.74** Water at 20°C flows down through a vertical, 6-cm-diameter tube at 300 gal/min, as in Fig. P3.74. The flow then turns horizontally and exits through a 90° radial duct segment 1 cm thick, as shown. If the radial outflow is uniform and steady, estimate the forces (F_x , F_y , F_z) required to support this system against fluid momentum changes.
- *P3.75** A jet of liquid of density ρ and area A strikes a block and splits into two jets, as in Fig. P3.75. Assume the same velocity V for all three jets. The upper jet exits at an angle θ and area αA . The lower jet is turned 90° downward. Neglecting fluid weight, (a) derive a formula for the forces (F_x , F_y) required to support the block against fluid mo-

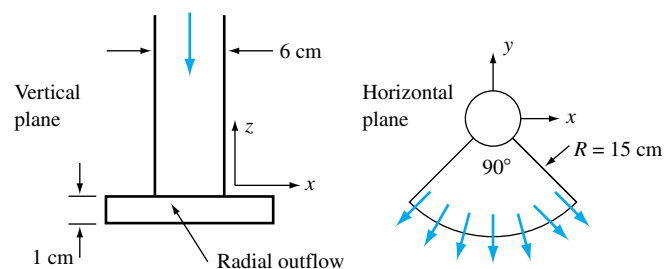

P3.74

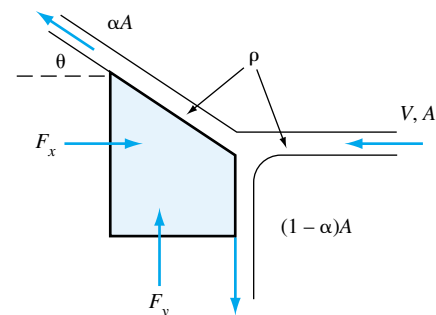

P3.75

mentum changes. (b) Show that $F_y = 0$ only if $\alpha \geq 0.5$. (c) Find the values of α and θ for which both F_x and F_y are zero.

- *P3.76** The rocket engine of Prob. 3.35 has an initial mass of 250 kg and is mounted on the rear of a 1300-kg racing car. The rocket is fired up, and the car accelerates on level ground. If the car has an air drag of kV^2 , where $k \approx 0.65$ N · s²/m², and rolling resistance cV , where $c \approx 16$ N · s/m, estimate the velocity of the car after it travels 0.25 mi (1320 ft).
- P3.77** Water at 20°C flows steadily through a reducing pipe bend, as in Fig. P3.77. Known conditions are $p_1 = 350$ kPa, $D_1 = 25$ cm, $V_1 = 2.2$ m/s, $p_2 = 120$ kPa, and $D_2 = 8$ cm. Neglecting bend and water weight, estimate the total force which must be resisted by the flange bolts.

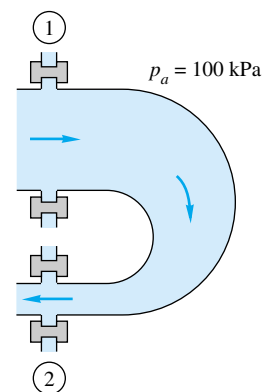

P3.77

- P3.78** A fluid jet of diameter D_1 enters a cascade of moving blades at absolute velocity V_1 and angle β_1 , and it leaves at absolute velocity V_2 and angle β_2 , as in Fig. P3.78. The blades move at velocity u . Derive a formula for the power P delivered to the blades as a function of these parameters.

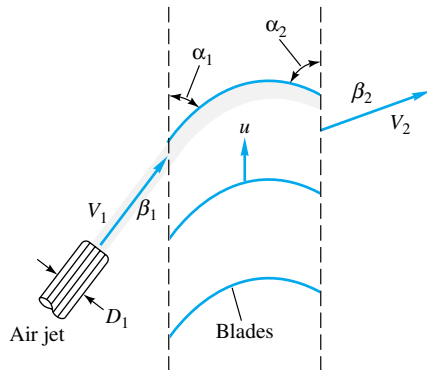
P3.78

- P3.79** Air at 20°C and 1 atm enters the bottom of an 85° conical flowmeter duct at a mass flow of 0.3 kg/s , as shown in Fig. P3.79. It is able to support a centered conical body by steady annular flow around the cone, as shown. The air velocity at the upper edge of the body equals the entering velocity. Estimate the weight of the body, in newtons.

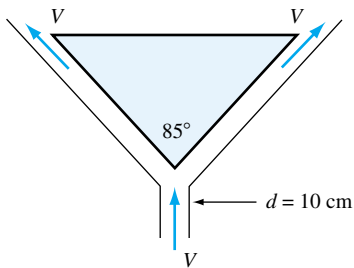
P3.79

- P3.80** A river of width b and depth h_1 passes over a submerged obstacle, or “drowned weir,” in Fig. P3.80, emerging at a new flow condition (V_2, h_2). Neglect atmospheric pressure, and assume that the water pressure is hydrostatic at both sections 1 and 2. Derive an expression for the

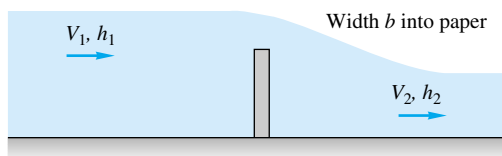
P3.80

force exerted by the river on the obstacle in terms of $V_1, h_1, h_2, b, \rho,$ and g . Neglect water friction on the river bottom.



- P3.81** Torricelli’s idealization of efflux from a hole in the side of a tank is $V = \sqrt{2gh}$, as shown in Fig. P3.81. The cylindrical tank weighs 150 N when empty and contains water at 20°C . The tank bottom is on very smooth ice (static friction coefficient $\zeta \approx 0.01$). The hole diameter is 9 cm . For what water depth h will the tank just begin to move to the right?

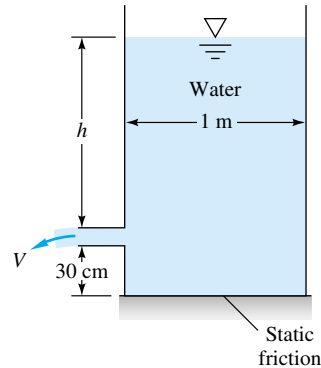

P3.81

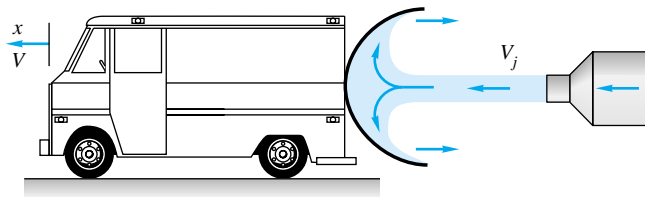
- *P3.82** The model car in Fig. P3.82 weighs 17 N and is to be accelerated from rest by a 1-cm -diameter water jet moving at 75 m/s . Neglecting air drag and wheel friction, estimate the velocity of the car after it has moved forward 1 m .

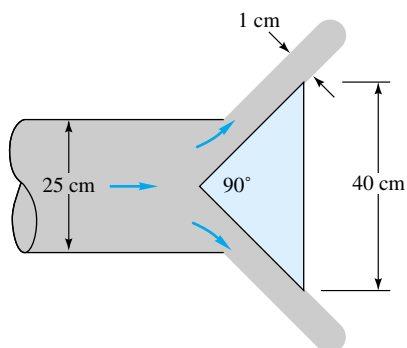

P3.82

- P3.83** Gasoline at 20°C is flowing at $V_1 = 12\text{ m/s}$ in a 5-cm -diameter pipe when it encounters a 1-m length of uniform radial wall suction. At the end of this suction region, the average fluid velocity has dropped to $V_2 = 10\text{ m/s}$. If $p_1 = 120\text{ kPa}$, estimate p_2 if the wall friction losses are neglected.

- P3.84** Air at 20°C and 1 atm flows in a 25-cm -diameter duct at 15 m/s , as in Fig. P3.84. The exit is choked by a 90° cone, as shown. Estimate the force of the airflow on the cone.

P3.84

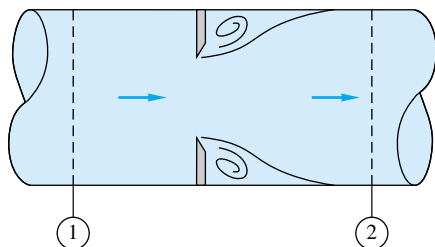
- P3.85** The thin-plate orifice in Fig. P3.85 causes a large pressure drop. For 20°C water flow at 500 gal/min, with pipe $D = 10$ cm and orifice $d = 6$ cm, $p_1 - p_2 \approx 145$ kPa. If the wall friction is negligible, estimate the force of the water on the orifice plate.

P3.85

- P3.86** For the water-jet pump of Prob. 3.36, add the following data: $p_1 = p_2 = 25$ lbf/in², and the distance between sections 1 and 3 is 80 in. If the average wall shear stress between sections 1 and 3 is 7 lbf/ft², estimate the pressure p_3 . Why is it higher than p_1 ?
- P3.87** Figure P3.87 simulates a *manifold* flow, with fluid removed from a porous wall or perforated section of pipe. Assume incompressible flow with negligible wall friction and small suction $V_w \ll V_1$. If (p_1, V_1, V_w, ρ, D) are known, derive expressions for (a) V_2 and (b) p_2 .

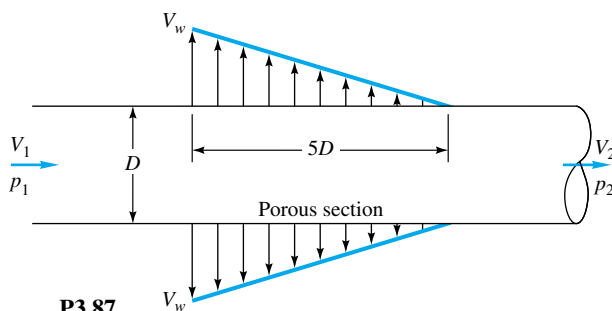
P3.87

- P3.88** The boat in Fig. P3.88 is jet-propelled by a pump which develops a volume flow rate Q and ejects water out the stern at velocity V_j . If the boat drag force is $F = kV^2$, where k is a constant, develop a formula for the steady forward speed V of the boat.

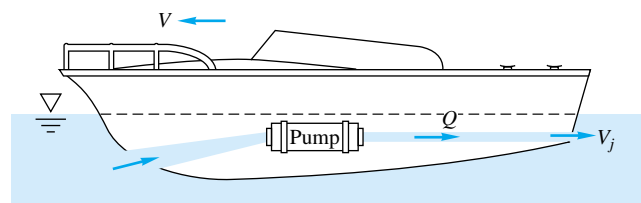

P3.88

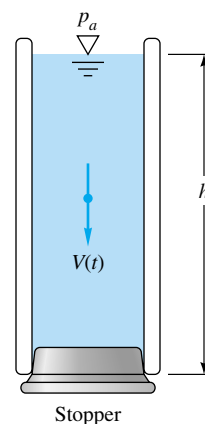
- P3.89** Consider Fig. P3.36 as a general problem for analysis of a mixing ejector pump. If all conditions (p, ρ, V) are known at sections 1 and 2 and if the wall friction is negligible, derive formulas for estimating (a) V_3 and (b) p_3 .
- P3.90** As shown in Fig. P3.90, a liquid column of height h is confined in a vertical tube of cross-sectional area A by a stopper. At $t = 0$ the stopper is suddenly removed, exposing the bottom of the liquid to atmospheric pressure. Using a control-volume analysis of mass and vertical momentum, derive the differential equation for the downward motion $V(t)$ of the liquid. Assume one-dimensional, incompressible, frictionless flow.

P3.90

- P3.91** Extend Prob. 3.90 to include a linear (laminar) average wall shear stress resistance of the form $\tau \approx cV$, where c is a constant. Find the differential equation for dV/dt and then solve for $V(t)$, assuming for simplicity that the wall area remains constant.
- *P3.92** A more involved version of Prob. 3.90 is the elbow-shaped tube in Fig. P3.92, with constant cross-sectional area A and diameter $D \ll h, L$. Assume incompressible flow, neglect

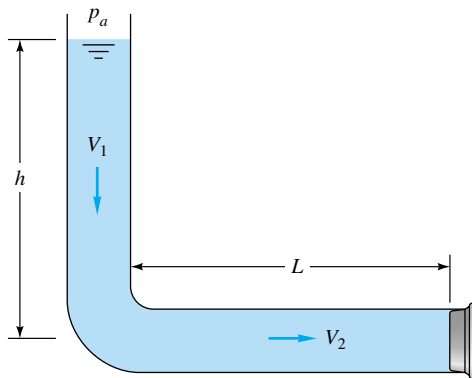
friction, and derive a differential equation for dV/dt when the stopper is opened. *Hint:* Combine two control volumes, one for each leg of the tube.

P3.92

P3.93 Extend Prob. 3.92 to include a linear (laminar) average wall shear stress resistance of the form $\tau \approx cV$, where c is a constant. Find the differential equation for dV/dt and then solve for $V(t)$, assuming for simplicity that the wall area remains constant.

P3.94 Attempt a numerical solution of Prob. 3.93 for SAE 30 oil at 20°C. Let $h = 20$ cm, $L = 15$ cm, and $D = 4$ mm. Use the laminar shear approximation from Sec. 6.4: $\tau \approx 8\mu V/D$, where μ is the fluid viscosity. Account for the decrease in wall area wetted by the fluid. Solve for the time required to empty (a) the vertical leg and (b) the horizontal leg.

P3.95 Attempt a numerical solution of Prob. 3.93 for mercury at 20°C. Let $h = 20$ cm, $L = 15$ cm, and $D = 4$ mm. For mercury the flow will be *turbulent*, with the wall shear stress estimated from Sec. 6.4: $\tau \approx 0.005\rho V^2$, where ρ is the fluid density. Account for the decrease in wall area wetted by the fluid. Solve for the time required to empty (a) the vertical leg and (b) the horizontal leg. Compare with a frictionless flow solution.

P3.96 Extend Prob. 3.90 to the case of the liquid motion in a frictionless U-tube whose liquid column is displaced a distance Z upward and then released, as in Fig. P3.96. Neglect the short horizontal leg and combine control-volume analyses for the left and right legs to derive a single differential equation for $V(t)$ of the liquid column.

***P3.97** Extend Prob. 3.96 to include a linear (laminar) average wall shear stress resistance of the form $\tau \approx 8\mu V/D$, where μ is the fluid viscosity. Find the differential equation for dV/dt and then solve for $V(t)$, assuming an initial displacement $z = z_0$, $V = 0$ at $t = 0$. The result should be a damped oscillation tending toward $z = 0$.

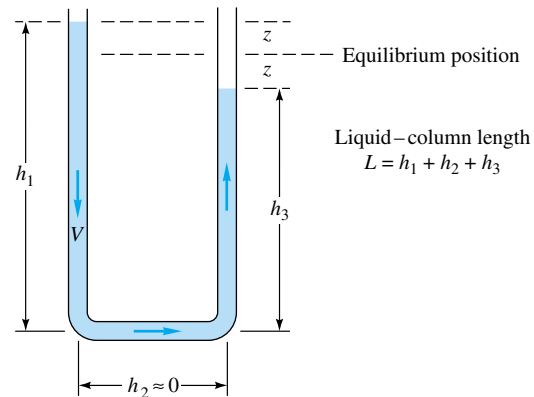
P3.96

***P3.98** As an extension of Example 3.10, let the plate and its cart (see Fig. 3.10a) be unrestrained horizontally, with frictionless wheels. Derive (a) the equation of motion for cart velocity $V_c(t)$ and (b) a formula for the time required for the cart to accelerate from rest to 90 percent of the jet velocity (assuming the jet continues to strike the plate horizontally). (c) Compute numerical values for part (b) using the conditions of Example 3.10 and a cart mass of 2 kg.

P3.99 Suppose that the rocket motor of Prob. 3.34 is attached to a missile which starts from rest at sea level and moves straight up, as in Fig. E3.12. If the system weighs 950 lbf, which includes 300 lbf of fuel and oxidizer, estimate the velocity and height of the missile (a) after 10 s and (b) after 20 s. Neglect air drag.

P3.100 Suppose that the solid-propellant rocket of Prob. 3.35 is built into a missile of diameter 70 cm and length 4 m. The system weighs 1800 N, which includes 700 N of propellant. Neglect air drag. If the missile is fired vertically from rest at sea level, estimate (a) its velocity and height at fuel burnout and (b) the maximum height it will attain.

P3.101 Modify Prob. 3.100 by accounting for air drag on the missile $F \approx C\rho D^2 V^2$, where $C \approx 0.02$, ρ is the air density, D is the missile diameter, and V is the missile velocity. Solve numerically for (a) the velocity and altitude at burnout and (b) the maximum altitude attained.

P3.102 As can often be seen in a kitchen sink when the faucet is running, a high-speed channel flow (V_1, h_1) may “jump” to a low-speed, low-energy condition (V_2, h_2) as in Fig. P3.102. The pressure at sections 1 and 2 is approximately hydrostatic, and wall friction is negligible. Use the continuity and momentum relations to find h_2 and V_2 in terms of (h_1, V_1).

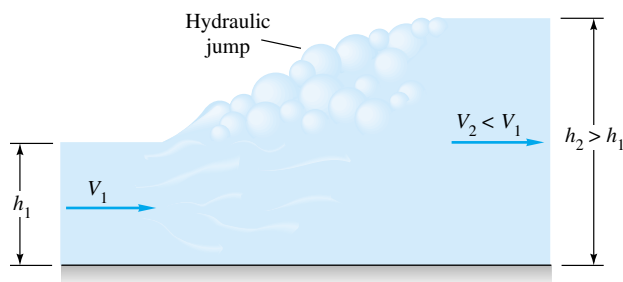
P3.102

***P3.103** Suppose that the solid-propellant rocket of Prob. 3.35 is mounted on a 1000-kg car to propel it up a long slope of 15° . The rocket motor weighs 900 N, which includes 500 N of propellant. If the car starts from rest when the rocket is fired, and if air drag and wheel friction are neglected, estimate the maximum distance that the car will travel up the hill.

P3.104 A rocket is attached to a rigid horizontal rod hinged at the origin as in Fig. P3.104. Its initial mass is M_0 , and its exit properties are \dot{m} and V_e relative to the rocket. Set up the differential equation for rocket motion, and solve for the angular velocity $\omega(t)$ of the rod. Neglect gravity, air drag, and the rod mass.

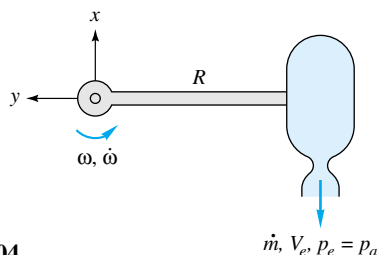
P3.104

P3.105 Extend Prob. 3.104 to the case where the rocket has a linear air drag force $F = cV$, where c is a constant. Assuming no burnout, solve for $\omega(t)$ and find the *terminal* angular velocity, i.e., the final motion when the angular acceleration is zero. Apply to the case $M_0 = 6$ kg, $R = 3$ m, $m = 0.05$ kg/s, $V_e = 1100$ m/s, and $c = 0.075$ N · s/m to find the angular velocity after 12 s of burning.

P3.106 Extend Prob. 3.104 to the case where the rocket has a quadratic air drag force $F = kV^2$, where k is a constant. Assuming no burnout, solve for $\omega(t)$ and find the *terminal* angular velocity, i.e., the final motion when the angular acceleration is zero. Apply to the case $M_0 = 6$ kg, $R = 3$ m, $m = 0.05$ kg/s, $V_e = 1100$ m/s, and $k = 0.0011$ N · s²/m² to find the angular velocity after 12 s of burning.

P3.107 The cart in Fig. P3.107 moves at constant velocity $V_0 = 12$ m/s and takes on water with a scoop 80 cm wide which

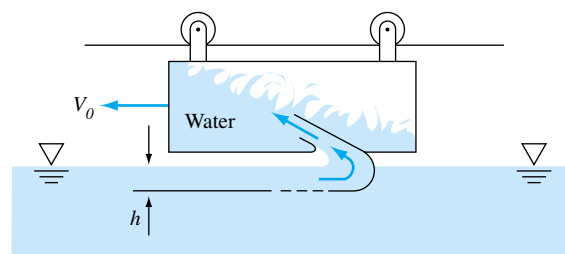
P3.107

dips $h = 2.5$ cm into a pond. Neglect air drag and wheel friction. Estimate the force required to keep the cart moving.

***P3.108** A rocket sled of mass M is to be decelerated by a scoop, as in Fig. P3.108, which has width b into the paper and dips into the water a depth h , creating an upward jet at 60° . The rocket thrust is T to the left. Let the initial velocity be V_0 , and neglect air drag and wheel friction. Find an expression for $V(t)$ of the sled for (a) $T = 0$ and (b) finite $T \neq 0$.

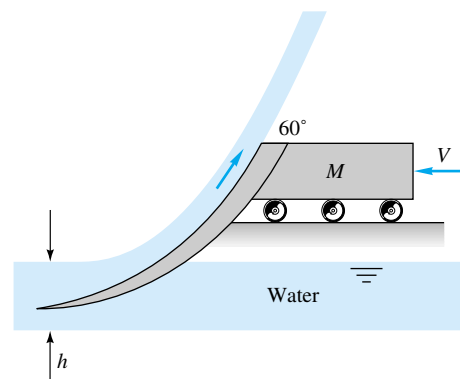
P3.108

P3.109 Apply Prob. 3.108 to the following case: $M_{\text{total}} = 900$ kg, $b = 60$ cm, $h = 2$ cm, $V_0 = 120$ m/s, with the rocket of Prob. 3.35 attached and burning. Estimate V after 3 s.

P3.110 The horizontal lawn sprinkler in Fig. P3.110 has a water flow rate of 4.0 gal/min introduced vertically through the center. Estimate (a) the retarding torque required to keep the arms from rotating and (b) the rotation rate (r/min) if there is no retarding torque.

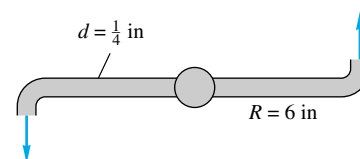
P3.110

P3.111 In Prob. 3.60 find the torque caused around flange 1 if the center point of exit 2 is 1.2 m directly below the flange center.

P3.112 The wye joint in Fig. P3.112 splits the pipe flow into equal amounts $Q/2$, which exit, as shown, a distance R_0 from the axis. Neglect gravity and friction. Find an expression for the torque T about the x -axis required to keep the system rotating at angular velocity Ω .

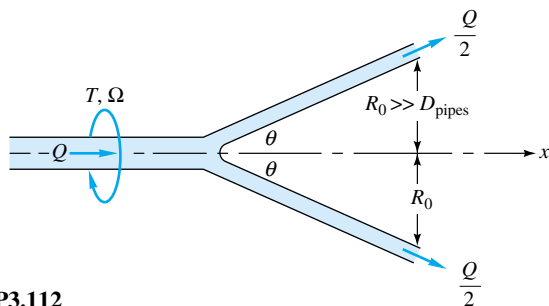

P3.112

P3.113 Modify Example 3.14 so that the arm starts from rest and spins up to its final rotation speed. The moment of inertia of the arm about O is I_0 . Neglecting air drag, find $d\omega/dt$ and integrate to determine the angular velocity $\omega(t)$, assuming $\omega = 0$ at $t = 0$.

P3.114 The three-arm lawn sprinkler of Fig. P3.114 receives 20°C water through the center at 2.7 m³/h. If collar friction is negligible, what is the steady rotation rate in r/min for (a) $\theta = 0^\circ$ and (b) $\theta = 40^\circ$?

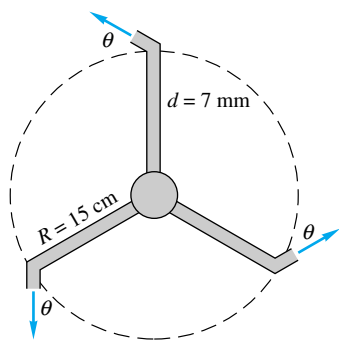

P3.114

P3.115 Water at 20°C flows at 30 gal/min through the 0.75-in-diameter double pipe bend of Fig. P3.115. The pressures are $p_1 = 30$ lbf/in² and $p_2 = 24$ lbf/in². Compute the torque T at point B necessary to keep the pipe from rotating.

P3.116 The centrifugal pump of Fig. P3.116 has a flow rate Q and exits the impeller at an angle θ_2 relative to the blades, as shown. The fluid enters axially at section 1. Assuming incompressible flow at shaft angular velocity ω , derive a formula for the power P required to drive the impeller.

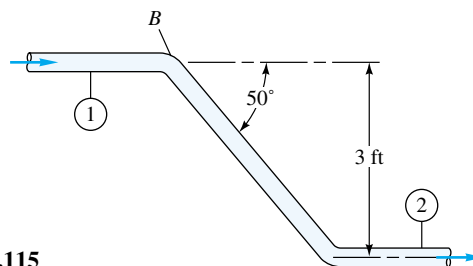

P3.115

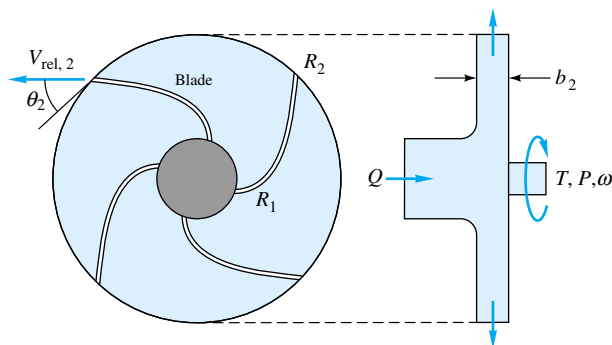

P3.116

P3.117 A simple turbomachine is constructed from a disk with two internal ducts which exit tangentially through square holes, as in Fig. P3.117. Water at 20°C enters normal to the disk at the center, as shown. The disk must drive, at 250 r/min, a small device whose retarding torque is 1.5 N · m. What is the proper mass flow of water, in kg/s?

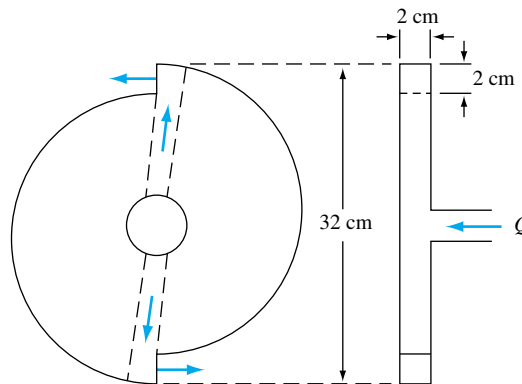

P3.117

P3.118 Reverse the flow in Fig. P3.116, so that the system operates as a radial-inflow turbine. Assuming that the outflow into section 1 has no tangential velocity, derive an expression for the power P extracted by the turbine.

- P3.119** Revisit the turbine cascade system of Prob. 3.78, and derive a formula for the power P delivered, using the *angular-momentum* theorem of Eq. (3.55).
- P3.120** A centrifugal pump impeller delivers 4000 gal/min of water at 20°C with a shaft rotation rate of 1750 r/min. Neglect losses. If $r_1 = 6$ in, $r_2 = 14$ in, $b_1 = b_2 = 1.75$ in, $V_{r1} = 10$ ft/s, and $V_{r2} = 110$ ft/s, compute the absolute velocities (a) V_1 and (b) V_2 and (c) the horsepower required. (d) Compare with the ideal horsepower required.
- P3.121** The pipe bend of Fig. P3.121 has $D_1 = 27$ cm and $D_2 = 13$ cm. When water at 20°C flows through the pipe at 4000 gal/min, $p_1 = 194$ kPa (gage). Compute the torque required at point B to hold the bend stationary.

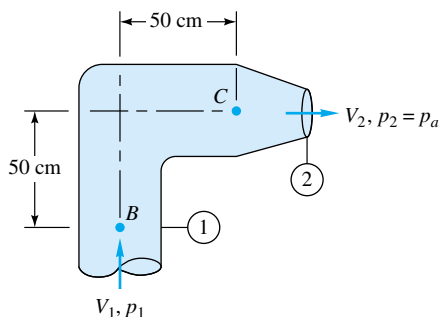
**P3.121**

- *P3.122** Extend Prob. 3.46 to the problem of computing the center of pressure L of the normal face F_n , as in Fig. P3.122. (At the center of pressure, no moments are required to hold the plate at rest.) Neglect friction. Express your result in terms of the sheet thickness h_1 and the angle θ between the plate and the oncoming jet 1.

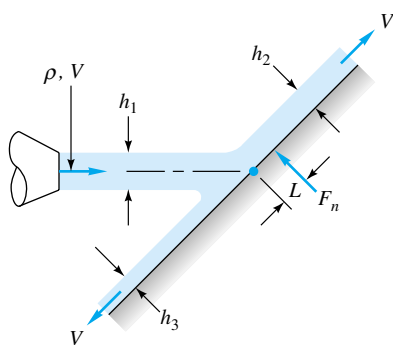
**P3.122**

- P3.123** The waterwheel in Fig. P3.123 is being driven at 200 r/min by a 150-ft/s jet of water at 20°C. The jet diameter is 2.5 in. Assuming no losses, what is the horsepower developed by the wheel? For what speed Ω r/min will the horsepower developed be a maximum? Assume that there are many buckets on the waterwheel.

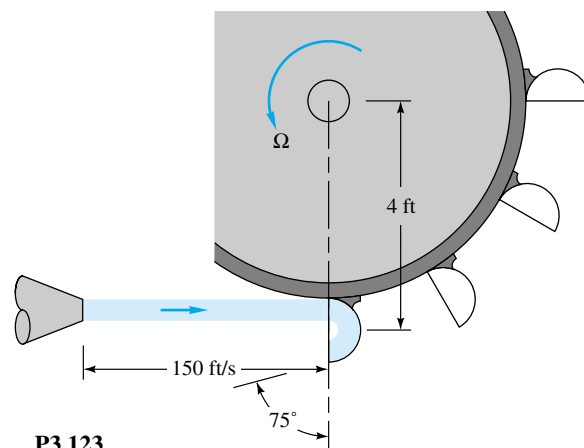
**P3.123**

- P3.124** A rotating dishwasher arm delivers at 60°C to six nozzles, as in Fig. P3.124. The total flow rate is 3.0 gal/min. Each nozzle has a diameter of $\frac{3}{16}$ in. If the nozzle flows are equal and friction is neglected, estimate the steady rotation rate of the arm, in r/min.

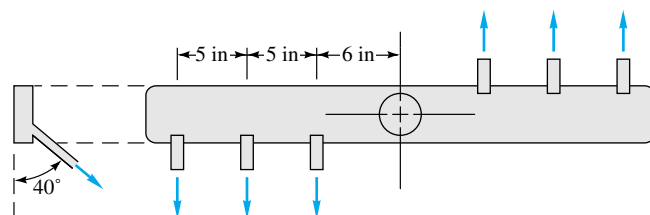
**P3.124**

- *P3.125** A liquid of density ρ flows through a 90° bend as shown in Fig. P3.125 and issues vertically from a uniformly porous section of length L . Neglecting pipe and liquid weight, derive an expression for the torque M at point O required to hold the pipe stationary.

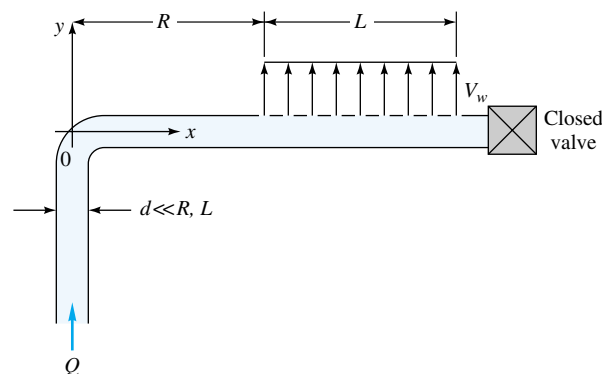
**P3.125**

- P3.126** There is a steady isothermal flow of water at 20°C through the device in Fig. P3.126. Heat-transfer, gravity, and temperature effects are negligible. Known data are $D_1 = 9\text{ cm}$, $Q_1 = 220\text{ m}^3/\text{h}$, $p_1 = 150\text{ kPa}$, $D_2 = 7\text{ cm}$, $Q_2 = 100\text{ m}^3/\text{h}$, $p_2 = 225\text{ kPa}$, $D_3 = 4\text{ cm}$, and $p_3 = 265\text{ kPa}$. Compute the rate of shaft work done for this device and its direction.

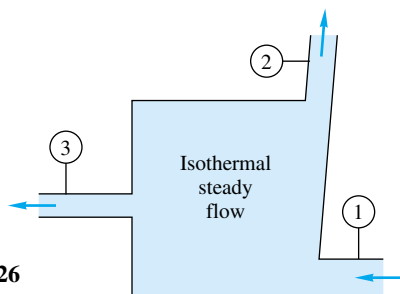

P3.126

- P3.127** A power plant on a river, as in Fig. P3.127, must eliminate 55 MW of waste heat to the river. The river conditions upstream are $Q_i = 2.5\text{ m}^3/\text{s}$ and $T_i = 18^\circ\text{C}$. The river is 45 m wide and 2.7 m deep. If heat losses to the atmosphere and ground are negligible, estimate the downstream river conditions (Q_o , T_o).

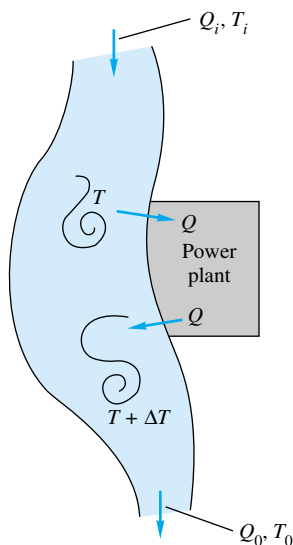

P3.127

- P3.128** For the conditions of Prob. 3.127, if the power plant is to heat the nearby river water by no more than 12°C , what should be the minimum flow rate Q , in m^3/s , through the plant heat exchanger? How will the value of Q affect the downstream conditions (Q_o , T_o)?

- P3.129** Multnomah Falls in the Columbia River Gorge has a sheer drop of 543 ft. Using the steady-flow energy equation, estimate the water temperature change in $^\circ\text{F}$ caused by this drop.
- P3.130** When the pump in Fig. P3.130 draws $220\text{ m}^3/\text{h}$ of water at 20°C from the reservoir, the total friction head loss is 5 m. The flow discharges through a nozzle to the atmosphere. Estimate the pump power in kW delivered to the water.

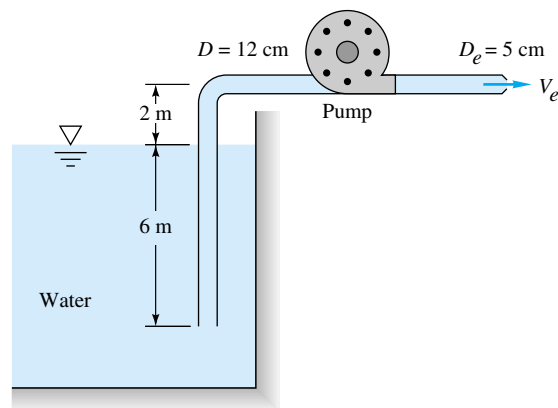

P3.130

- P3.131** When the pump in Fig. P3.130 delivers 25 kW of power to the water, the friction head loss is 4 m. Estimate (a) the exit velocity V_e and (b) the flow rate Q .

- P3.132** Consider a turbine extracting energy from a penstock in a dam, as in Fig. P3.132. For turbulent pipe flow (Chap. 6), the friction head loss is approximately $h_f = CQ^2$, where the constant C depends upon penstock dimensions and the properties of water. Show that, for a given penstock geometry and variable river flow Q , the maximum turbine power possible in this case is $P_{\max} = 2\rho gHQ/3$ and occurs when the flow rate is $Q = \sqrt{H/(3C)}$.

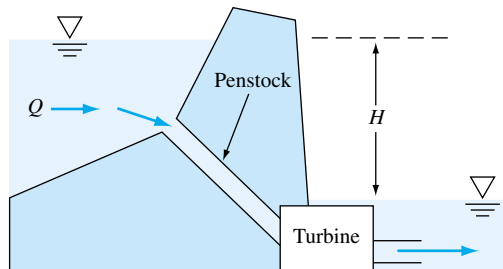

P3.132

- P3.133** The long pipe in Fig. P3.133 is filled with water at 20°C . When valve A is closed, $p_1 - p_2 = 75\text{ kPa}$. When the valve is open and water flows at $500\text{ m}^3/\text{h}$, $p_1 - p_2 = 160\text{ kPa}$.

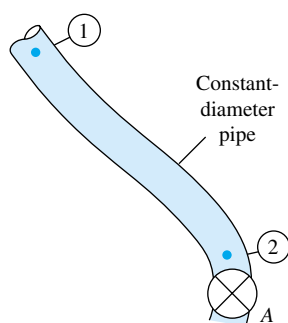

P3.133

What is the friction head loss between 1 and 2, in m, for the flowing condition?

P3.134 A 36-in-diameter pipeline carries oil ($SG = 0.89$) at 1 million barrels per day (bbl/day) (1 bbl = 42 U.S. gal). The friction head loss is 13 ft/1000 ft of pipe. It is planned to place pumping stations every 10 mi along the pipe. Estimate the horsepower which must be delivered to the oil by each pump.

P3.135 The *pump-turbine* system in Fig. P3.135 draws water from the upper reservoir in the daytime to produce power for a city. At night, it pumps water from lower to upper reservoirs to restore the situation. For a design flow rate of 15,000 gal/min in either direction, the friction head loss is 17 ft. Estimate the power in kW (a) extracted by the turbine and (b) delivered by the pump.

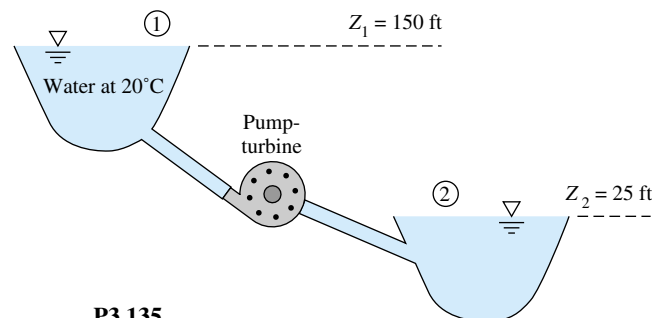

P3.135

P3.136 A pump is to deliver water at 20°C from a pond to an elevated tank. The pump is 1 m above the pond, and the tank free surface is 20 m above the pump. The head loss in the system is $h_f \approx cQ^2$, where $c = 0.08 \text{ h}^2/\text{m}^5$. If the pump is 72 percent efficient and is driven by a 500-W motor, what flow rate $Q \text{ m}^3/\text{h}$ will result?

P3.137 A fireboat draws seawater ($SG = 1.025$) from a submerged pipe and discharges it through a nozzle, as in Fig. P3.137. The total head loss is 6.5 ft. If the pump efficiency is 75 percent, what horsepower motor is required to drive it?

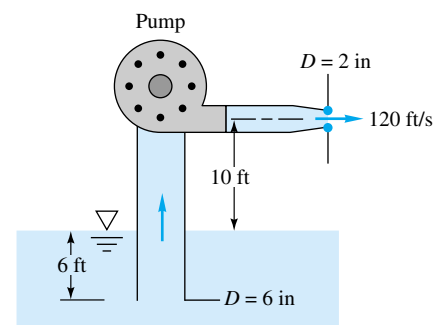

P3.137

***P3.138** Students in the fluid mechanics laboratory at Penn State use a very simple device to measure the viscosity of water as a function of temperature. The viscometer, shown in Fig. P3.138, consists of a tank, a long vertical capillary tube, a graduated cylinder, a thermometer, and a stopwatch. Because the tube has such a small diameter, the flow remains laminar. Because the tube is so long, entrance losses are negligible. It will be shown in Chap. 6 that the laminar head loss through a long pipe is given by $h_{f, \text{laminar}} = (32\mu LV)/(\rho g d^2)$, where V is the average speed through the pipe. (a) In a given experiment, diameter d , length L , and water level height H are known, and volume flow rate Q is measured with the stopwatch and graduated cylinder. The temperature of the water is also measured. The water density at this tempera-

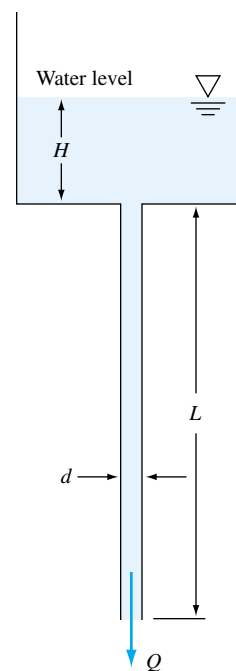

P3.138

ture is obtained by weighing a known volume of water. Write an expression for the viscosity of the water as a function of these variables. (b) Here are some actual data from an experiment: $T = 16.5^\circ\text{C}$, $\rho = 998.7 \text{ kg/m}^3$, $d = 0.041 \text{ in}$, $Q = 0.310 \text{ mL/s}$, $L = 36.1 \text{ in}$, and $H = 0.153 \text{ m}$. Calculate the viscosity of the water in $\text{kg}/(\text{m} \cdot \text{s})$ based on these experimental data. (c) Compare the experimental result with the published value of μ at this temperature, and report a percentage error. (d) Compute the percentage error in the calculation of μ which would occur if a student forgot to include the kinetic energy flux correction factor in part (b) above (compare results with and without inclusion of kinetic energy flux correction factor). Explain the importance (or lack of importance) of kinetic energy flux correction factor in a problem such as this.

- P3.139** The horizontal pump in Fig. P3.139 discharges 20°C water at $57 \text{ m}^3/\text{h}$. Neglecting losses, what power in kW is delivered to the water by the pump?

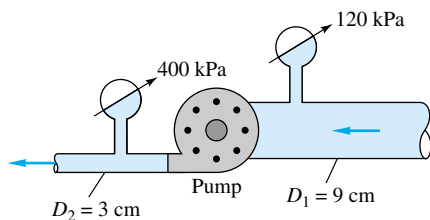

P3.139

- P3.140** Steam enters a horizontal turbine at 350 lbf/in^2 absolute, 580°C , and 12 ft/s and is discharged at 110 ft/s and 25°C saturated conditions. The mass flow is 2.5 lbm/s , and the heat losses are 7 Btu/lb of steam. If head losses are negligible, how much horsepower does the turbine develop?

- P3.141** Water at 20°C is pumped at 1500 gal/min from the lower to the upper reservoir, as in Fig. P3.141. Pipe friction losses are approximated by $h_f \approx 27V^2/(2g)$, where V is the average velocity in the pipe. If the pump is 75 percent efficient, what horsepower is needed to drive it?

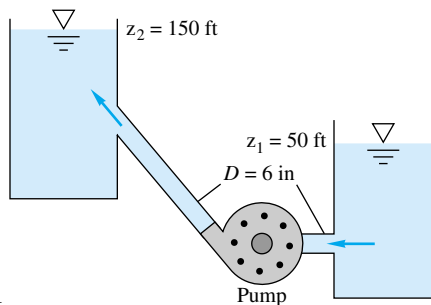

P3.141

- P3.142** A typical pump has a head which, for a given shaft rotation rate, varies with the flow rate, resulting in a *pump performance curve* as in Fig. P3.142. Suppose that this pump

is 75 percent efficient and is used for the system in Prob. 3.141. Estimate (a) the flow rate, in gal/min , and (b) the horsepower needed to drive the pump.

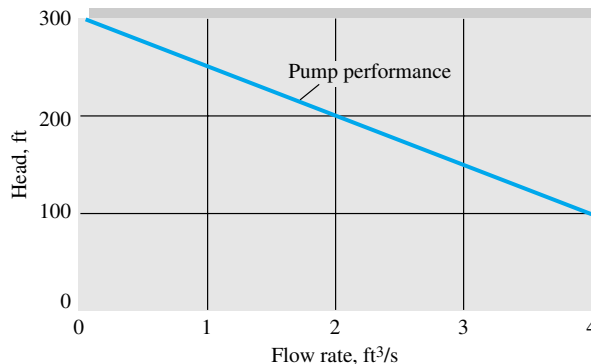

P3.142

- P3.143** The insulated tank in Fig. P3.143 is to be filled from a high-pressure air supply. Initial conditions in the tank are $T = 20^\circ\text{C}$ and $p = 200 \text{ kPa}$. When the valve is opened, the initial mass flow rate into the tank is 0.013 kg/s . Assuming an ideal gas, estimate the initial rate of temperature rise of the air in the tank.

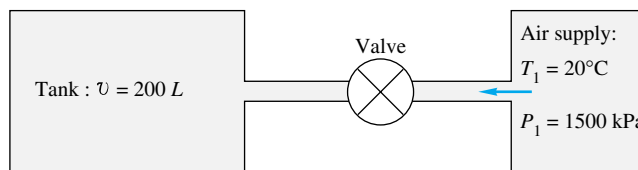

P3.143

- P3.144** The pump in Fig. P3.144 creates a 20°C water jet oriented to travel a maximum horizontal distance. System friction head losses are 6.5 m . The jet may be approximated by the trajectory of frictionless particles. What power must be delivered by the pump?

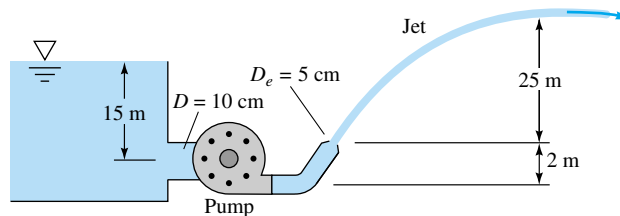

P3.144

- P3.145** The large turbine in Fig. P3.145 diverts the river flow under a dam as shown. System friction losses are $h_f = 3.5V^2/(2g)$, where V is the average velocity in the supply

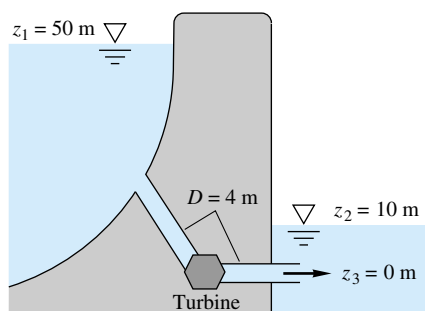

P3.145

pipe. For what river flow rate in m^3/s will the power extracted be 25 MW? Which of the *two* possible solutions has a better “conversion efficiency”?

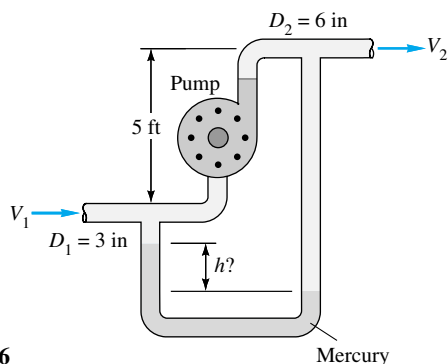
- P3.146** Kerosine at 20°C flows through the pump in Fig. P3.146 at $2.3 \text{ ft}^3/\text{s}$. Head losses between 1 and 2 are 8 ft, and the pump delivers 8 hp to the flow. What should the mercury-manometer reading h ft be?

P3.146

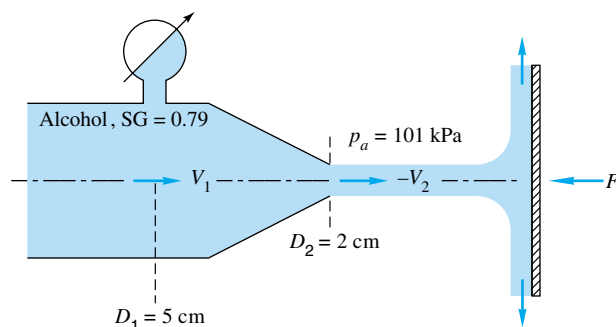
- P3.147** Repeat Prob. 3.49 by assuming that p_1 is unknown and using Bernoulli’s equation with no losses. Compute the new bolt force for this assumption. What is the head loss between 1 and 2 for the data of Prob. 3.49?
- P3.148** Reanalyze Prob. 3.54 to estimate the manometer reading h if Bernoulli’s equation is valid with zero losses. For the reading $h \approx 58 \text{ cm}$ in Prob. 3.54, what is the head loss between sections 1 and 2?
- P3.149** A jet of alcohol strikes the vertical plate in Fig. P3.149. A force $F \approx 425 \text{ N}$ is required to hold the plate stationary. Assuming there are no losses in the nozzle, estimate (a) the mass flow rate of alcohol and (b) the absolute pressure at section 1.
- P3.150** Verify that Bernoulli’s equation is not valid for the sudden expansion of Prob. 3.59 and that the actual head loss is given by

P3.149

$$h_f \approx \frac{V_1^2}{2g} \left(1 - \frac{A_1}{A_2} \right)^2$$

See Sec. 6.7 for further details.

- P3.151** In Prob. 3.63 the velocity approaching the sluice gate was assumed to be known. If Bernoulli’s equation is valid with no losses, derive an expression for V_1 as a function of only h_1 , h_2 , and g .
- P3.152** A free liquid jet, as in Fig. P3.152, has constant ambient pressure and small losses; hence from Bernoulli’s equation $z + V^2/(2g)$ is constant along the jet. For the fire nozzle in the figure, what are (a) the minimum and (b) the maximum values of θ for which the water jet will clear the corner of the building? For which case will the jet velocity be higher when it strikes the roof of the building?

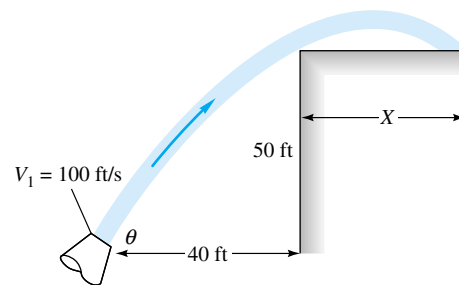

P3.152

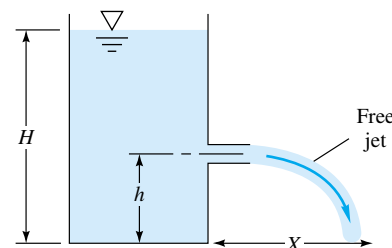
- P3.153** For the container of Fig. P3.153 use Bernoulli’s equation to derive a formula for the distance X where the free jet

P3.153

leaving horizontally will strike the floor, as a function of h and H . For what ratio h/H will X be maximum? Sketch the three trajectories for $h/H = 0.4, 0.5,$ and 0.6 .

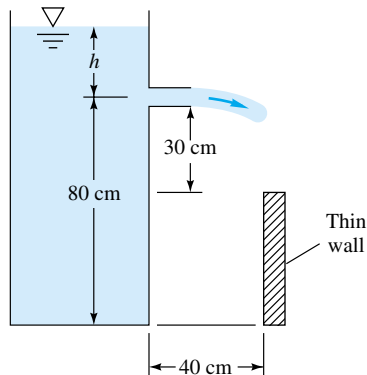
- P3.154** In Fig. P3.154 the exit nozzle is horizontal. If losses are negligible, what should the water level h cm be for the free jet to just clear the wall?



P3.154

- P3.155** Bernoulli's 1738 treatise *Hydrodynamica* contains many excellent sketches of flow patterns related to his frictionless relation. One, however, redrawn here as Fig. P3.155, seems physically misleading. Can you explain what might be wrong with the figure?

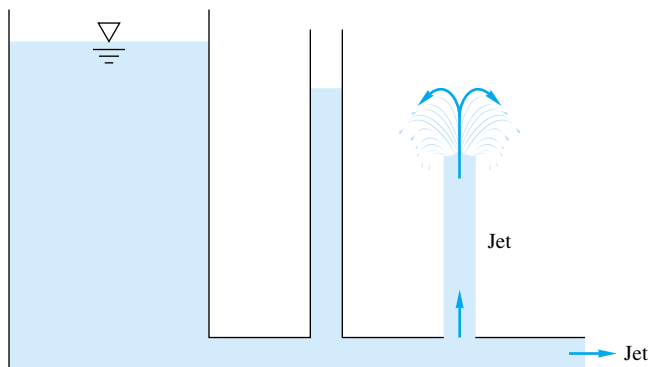

P3.155

- P3.156** A blimp cruises at 75 mi/h through sea-level standard air. A differential pressure transducer connected between the nose and the side of the blimp registers 950 Pa. Estimate (a) the absolute pressure at the nose and (b) the absolute velocity of the air near the blimp side.
- P3.157** The manometer fluid in Fig. P3.157 is mercury. Estimate the volume flow in the tube if the flowing fluid is (a) gasoline and (b) nitrogen, at 20°C and 1 atm.
- P3.158** In Fig. P3.158 the flowing fluid is CO₂ at 20°C. Neglect losses. If $p_1 = 170$ kPa and the manometer fluid is Meriam

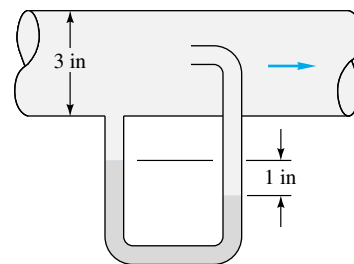

P3.157

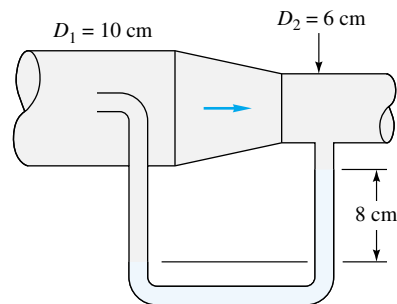

P3.158

red oil (SG = 0.827), estimate (a) p_2 and (b) the gas flow rate in m³/h.

- P3.159** Our 0.625-in-diameter hose is too short, and it is 125 ft from the 0.375-in-diameter nozzle exit to the garden. If losses are neglected, what is the minimum gage pressure required, inside the hose, to reach the garden?
- P3.160** The air-cushion vehicle in Fig. P3.160 brings in sea-level standard air through a fan and discharges it at high velocity through an annular skirt of 3-cm clearance. If the vehicle weighs 50 kN, estimate (a) the required airflow rate and (b) the fan power in kW.

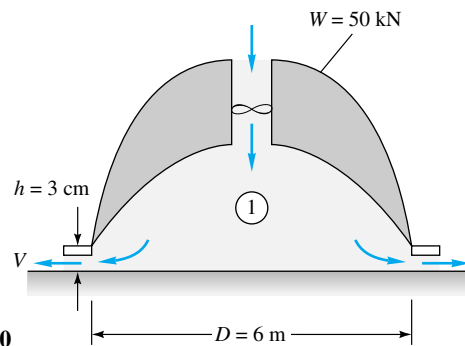

P3.160

- P3.161** A necked-down section in a pipe flow, called a *venturi*, develops a low throat pressure which can aspirate fluid upward from a reservoir, as in Fig. P3.161. Using Bernoulli's

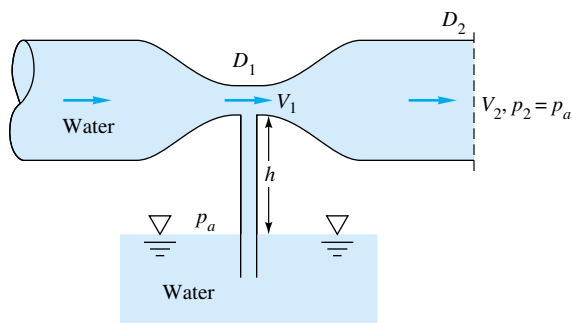
**P3.161**

equation with no losses, derive an expression for the velocity V_1 which is just sufficient to bring reservoir fluid into the throat.

- P3.162** Suppose you are designing an air hockey table. The table is 3.0×6.0 ft in area, with $\frac{1}{16}$ -in-diameter holes spaced every inch in a rectangular grid pattern (2592 holes total). The required jet speed from each hole is estimated to be 50 ft/s. Your job is to select an appropriate blower which will meet the requirements. Estimate the volumetric flow rate (in ft^3/min) and pressure rise (in lb/in^2) required of the blower. *Hint:* Assume that the air is stagnant in the large volume of the manifold under the table surface, and neglect any frictional losses.

- P3.163** The liquid in Fig. P3.163 is kerosine at 20°C . Estimate the flow rate from the tank for (a) no losses and (b) pipe losses $h_f \approx 4.5V^2/(2g)$.

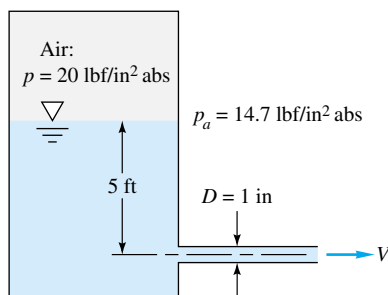
**P3.163**

- P3.164** In Fig. P3.164 the open jet of water at 20°C exits a nozzle into sea-level air and strikes a stagnation tube as shown.

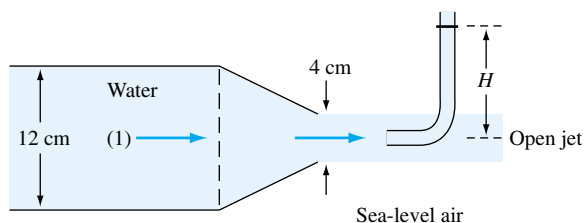
**P3.164**

If the pressure at the centerline at section 1 is 110 kPa, and losses are neglected, estimate (a) the mass flow in kg/s and (b) the height H of the fluid in the stagnation tube.

- P3.165** A venturi meter, shown in Fig. P3.165, is a carefully designed constriction whose pressure difference is a measure of the flow rate in a pipe. Using Bernoulli's equation for steady incompressible flow with no losses, show that the flow rate Q is related to the manometer reading h by

$$Q = \frac{A_2}{\sqrt{1 - (D_2/D_1)^4}} \sqrt{\frac{2gh(\rho_M - \rho)}{\rho}}$$

where ρ_M is the density of the manometer fluid.

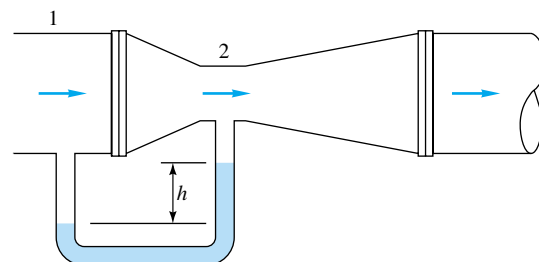
**P3.165**

- P3.166** An open-circuit wind tunnel draws in sea-level standard air and accelerates it through a contraction into a 1-m by 1-m test section. A differential transducer mounted in the test section wall measures a pressure difference of 45 mm of water between the inside and outside. Estimate (a) the test section velocity in mi/h and (b) the absolute pressure on the front nose of a small model mounted in the test section.

- P3.167** In Fig. P3.167 the fluid is gasoline at 20°C at a weight flux of 120 N/s. Assuming no losses, estimate the gage pressure at section 1.

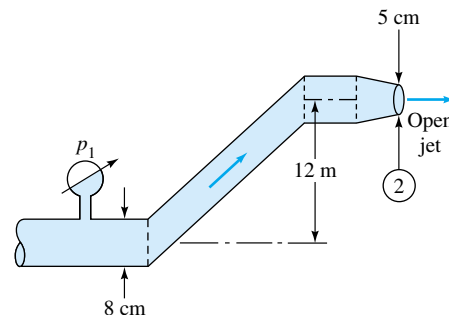
**P3.167**

- P3.168** In Fig. P3.168 both fluids are at 20°C . If $V_1 = 1.7$ ft/s and losses are neglected, what should the manometer reading h ft be?

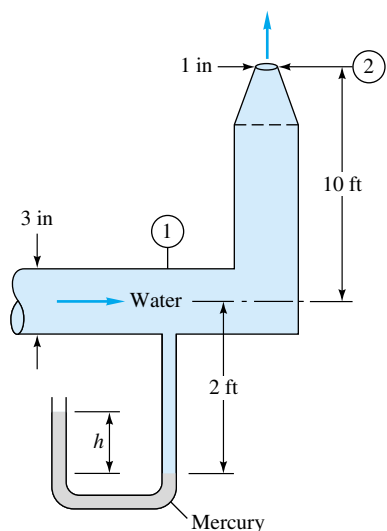

P3.168

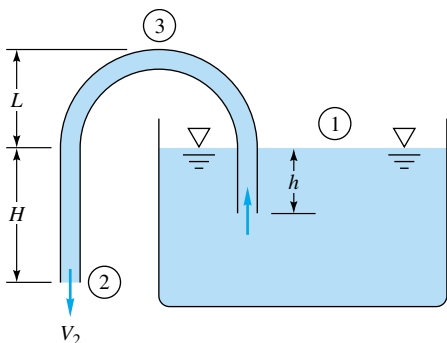
- P3.169** Once it has been started by sufficient suction, the *siphon* in Fig. P3.169 will run continuously as long as reservoir fluid is available. Using Bernoulli's equation with no losses, show (a) that the exit velocity V_2 depends only upon gravity and the distance H and (b) that the lowest (vacuum) pressure occurs at point 3 and depends on the distance $L + H$.

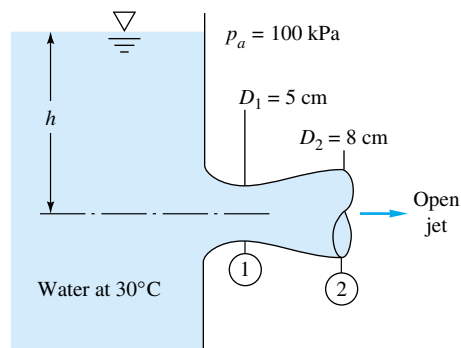
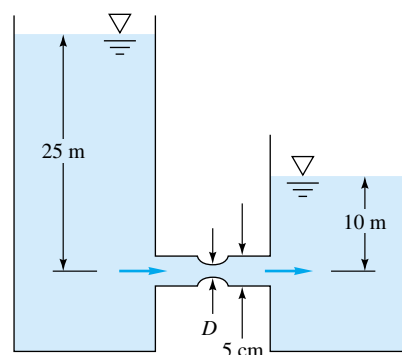

P3.169

- P3.170** If losses are neglected in Fig. P3.170, for what water level h will the flow begin to form vapor cavities at the throat of the nozzle?

- *P3.171** For the 40°C water flow in Fig. P3.171, estimate the volume flow through the pipe, assuming no losses; then explain what is wrong with this seemingly innocent question. If the actual flow rate is $Q = 40 \text{ m}^3/\text{h}$, compute (a) the head loss in ft and (b) the constriction diameter D which causes cavitation, assuming that the throat divides the head loss equally and that changing the constriction causes no additional losses.

P3.170

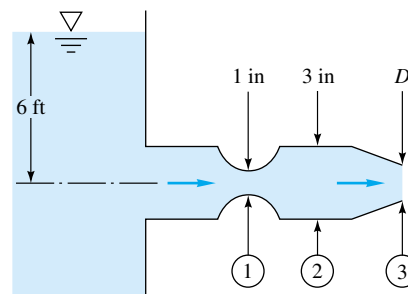
P3.171

- P3.172** The 35°C water flow of Fig. P3.172 discharges to sea-level standard atmosphere. Neglecting losses, for what nozzle diameter D will cavitation begin to occur? To avoid cavitation, should you increase or decrease D from this critical value?

P3.172

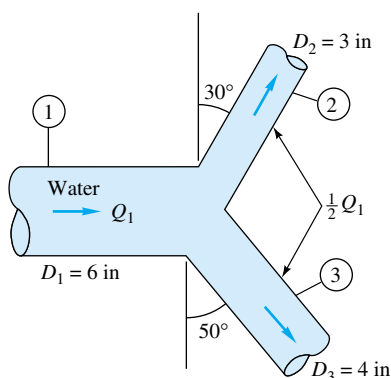
- P3.173** The horizontal wye fitting in Fig. P3.173 splits the 20°C water flow rate equally. If $Q_1 = 5 \text{ ft}^3/\text{s}$ and $p_1 = 25 \text{ lbf/in}^2(\text{gage})$ and losses are neglected, estimate (a) p_2 , (b) p_3 , and (c) the vector force required to keep the wye in place.

P3.173

P3.174 In Fig. P3.174 the piston drives water at 20°C. Neglecting losses, estimate the exit velocity V_2 ft/s. If D_2 is further constricted, what is the maximum possible value of V_2 ?

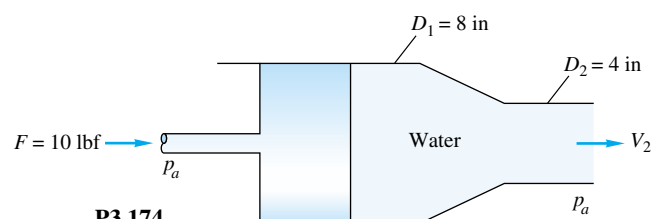

P3.174

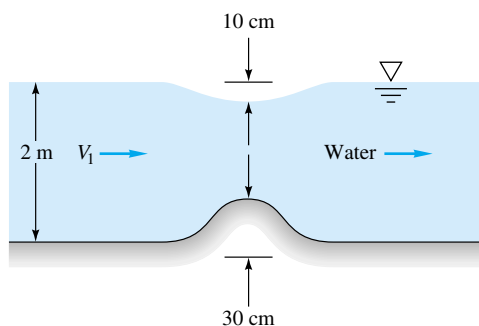
P3.175 If the approach velocity is not too high, a hump in the bottom of a water channel causes a dip Δh in the water level, which can serve as a flow measurement. If, as shown in Fig. P3.175, $\Delta h = 10$ cm when the bump is 30 cm high, what is the volume flow Q_1 per unit width, assuming no losses? In general, is Δh proportional to Q_1 ?

P3.175

P3.176 In the spillway flow of Fig. P3.176, the flow is assumed uniform and hydrostatic at sections 1 and 2. If losses are neglected, compute (a) V_2 and (b) the force per unit width of the water on the spillway.

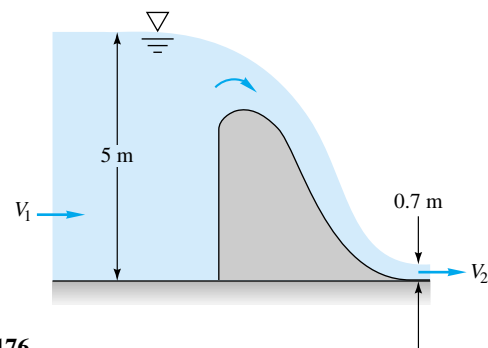
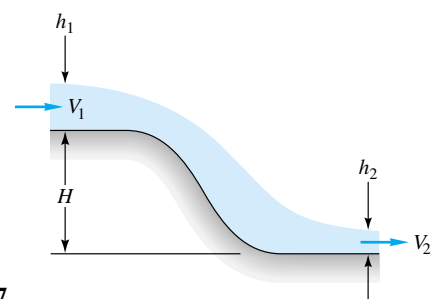
P3.177 For the water-channel flow of Fig. P3.177, $h_1 = 1.5$ m, $H = 4$ m, and $V_1 = 3$ m/s. Neglecting losses and assuming uniform flow at sections 1 and 2, find the down-

P3.176

P3.177

stream depth h_2 , and show that *two* realistic solutions are possible.

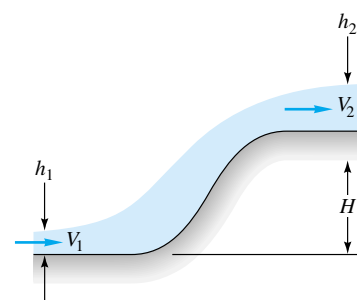
P3.178 For the water-channel flow of Fig. P3.178, $h_1 = 0.45$ ft, $H = 2.2$ ft, and $V_1 = 16$ ft/s. Neglecting losses and assuming uniform flow at sections 1 and 2, find the downstream depth h_2 ; show that *two* realistic solutions are possible.

P3.178

***P3.179** A cylindrical tank of diameter D contains liquid to an initial height h_0 . At time $t = 0$ a small stopper of diameter d is removed from the bottom. Using Bernoulli's equation with no losses, derive (a) a differential equation for the free-surface height $h(t)$ during draining and (b) an expression for the time t_0 to drain the entire tank.

***P3.180** The large tank of incompressible liquid in Fig. P3.180 is at rest when, at $t = 0$, the valve is opened to the atmos-

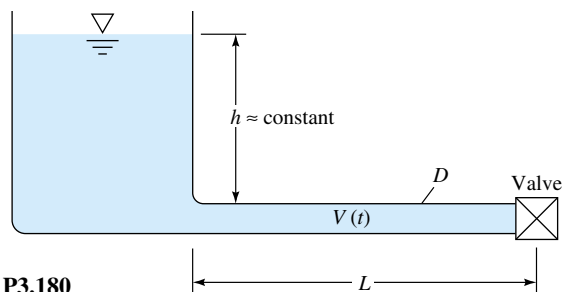

P3.180

where. Assuming $h \approx \text{constant}$ (negligible velocities and accelerations in the tank), use the unsteady frictionless

Bernoulli equation to derive and solve a differential equation for $V(t)$ in the pipe.

***P3.181** Modify Prob. 3.180 as follows. Let the top of the tank be enclosed and under constant gage pressure p_0 . Repeat the analysis to find $V(t)$ in the pipe.

P3.182 The incompressible-flow form of Bernoulli's relation, Eq. (3.77), is accurate only for Mach numbers less than about 0.3. At higher speeds, variable density must be accounted for. The most common assumption for compressible fluids is *isentropic flow of an ideal gas*, or $p = C\rho^k$, where $k = c_p/c_v$. Substitute this relation into Eq. (3.75), integrate, and eliminate the constant C . Compare your compressible result with Eq. (3.77) and comment.

Word Problems

W3.1 Derive a control-volume form of the *second* law of thermodynamics. Suggest some practical uses for your relation in analyzing real fluid flows.

W3.2 Suppose that it is desired to estimate volume flow Q in a pipe by measuring the axial velocity $u(r)$ at specific points. For cost reasons only *three* measuring points are to be used. What are the best radii selections for these three points?

W3.3 Consider water flowing by gravity through a short pipe connecting two reservoirs whose surface levels differ by an amount Δz . Why does the incompressible frictionless Bernoulli equation lead to an absurdity when the flow rate through the pipe is computed? Does the paradox have something to do with the length of the short pipe? Does the paradox disappear if we round the entrance and exit edges of the pipe?

W3.4 Use the steady-flow energy equation to analyze flow through a water faucet whose supply pressure is p_0 . What

physical mechanism causes the flow to vary continuously from zero to maximum as we open the faucet valve?

W3.5 Consider a long sewer pipe, half full of water, sloping downward at angle θ . Antoine Chézy in 1768 determined that the average velocity of such an open-channel flow should be $V \approx C\sqrt{R} \tan \theta$, where R is the pipe radius and C is a constant. How does this famous formula relate to the steady-flow energy equation applied to a length L of the channel?

W3.6 Put a table tennis ball in a funnel, and attach the small end of the funnel to an air supply. You probably won't be able to blow the ball either up or down out of the funnel. Explain why.

W3.7 How does a *siphon* work? Are there any limitations (e.g., how high or how low can you siphon water away from a tank)? Also, how far—could you use a flexible tube to siphon water from a tank to a point 100 ft away?

Fundamentals of Engineering Exam Problems

FE3.1 In Fig. FE3.1 water exits from a nozzle into atmospheric pressure of 101 kPa. If the flow rate is 160 gal/min, what is the average velocity at section 1?

- (a) 2.6 m/s, (b) 0.81 m/s, (c) 93 m/s, (d) 23 m/s, (e) 1.62 m/s

FE3.2 In Fig. FE3.1 water exits from a nozzle into atmospheric pressure of 101 kPa. If the flow rate is 160 gal/min and friction is neglected, what is the gage pressure at section 1?

- (a) 1.4 kPa, (b) 32 kPa, (c) 43 kPa, (d) 29 kPa, (e) 123 kPa

FE3.3 In Fig. FE3.1 water exits from a nozzle into atmospheric pressure of 101 kPa. If the exit velocity is $V_2 = 8$ m/s and

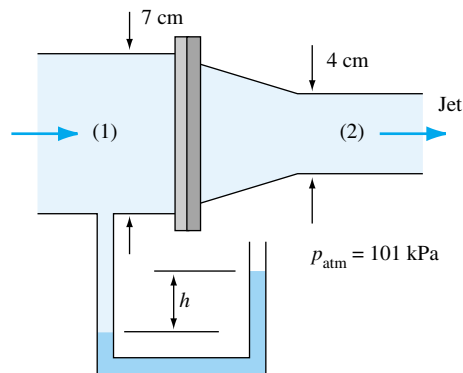

FE3.1

friction is neglected, what is the axial flange force required to keep the nozzle attached to pipe 1?

(a) 11 N, (b) 56 N, (c) 83 N, (d) 123 N, (e) 110 N

- FE3.4** In Fig. FE3.1 water exits from a nozzle into atmospheric pressure of 101 kPa. If the manometer fluid has a specific gravity of 1.6 and $h = 66$ cm, with friction neglected, what is the average velocity at section 2?

(a) 4.55 m/s, (b) 2.4 m/s, (c) 2.95 m/s, (d) 5.55 m/s, (e) 3.4 m/s

- FE3.5** A jet of water 3 cm in diameter strikes normal to a plate as in Fig. FE3.5. If the force required to hold the plate is 23 N, what is the jet velocity?

(a) 2.85 m/s, (b) 5.7 m/s, (c) 8.1 m/s, (d) 4.0 m/s, (e) 23 m/s

- FE3.6** A fireboat pump delivers water to a vertical nozzle with a 3:1 diameter ratio, as in Fig. FE3.6. If friction is neglected and the flow rate is 500 gal/min, how high will the outlet water jet rise?

(a) 2.0 m, (b) 9.8 m, (c) 32 m, (d) 64 m, (e) 98 m

- FE3.7** A fireboat pump delivers water to a vertical nozzle with a 3:1 diameter ratio, as in Fig. FE3.6. If friction is neglected and the pump increases the pressure at section 1 to 51 kPa (gauge), what will be the resulting flow rate?

(a) 187 gal/min, (b) 199 gal/min, (c) 214 gal/min, (d) 359 gal/min, (e) 141 gal/min

- FE3.8** A fireboat pump delivers water to a vertical nozzle with a 3:1 diameter ratio, as in Fig. FE3.6. If duct and nozzle friction are neglected and the pump provides 12.3 ft of head to the flow, what will be the outlet flow rate?

(a) 85 gal/min, (b) 120 gal/min, (c) 154 gal/min, (d) 217 gal/min, (e) 285 gal/min

- FE3.9** Water flowing in a smooth 6-cm-diameter pipe enters a venturi contraction with a throat diameter of 3 cm. Upstream pressure is 120 kPa. If cavitation occurs in the throat at a flow rate of 155 gal/min, what is the estimated fluid vapor pressure, assuming ideal frictionless flow?

(a) 6 kPa, (b) 12 kPa, (c) 24 kPa, (d) 31 kPa, (e) 52 kPa

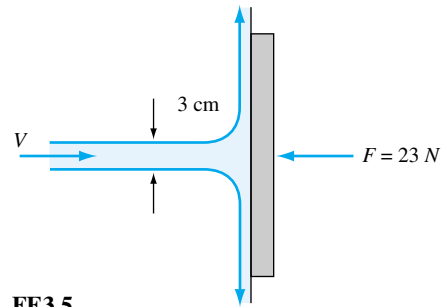

FE3.5

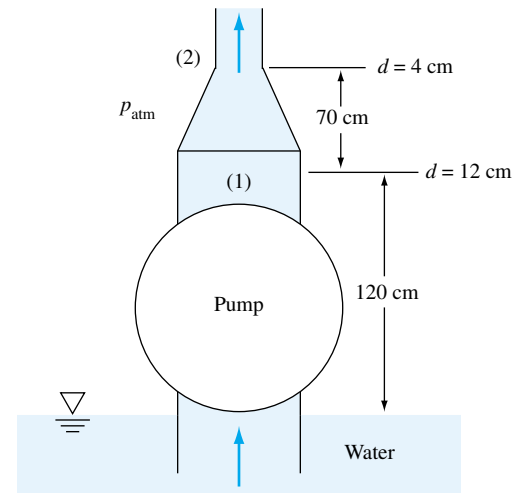

FE3.6

- FE3.10** Water flowing in a smooth 6-cm-diameter pipe enters a venturi contraction with a throat diameter of 4 cm. Upstream pressure is 120 kPa. If the pressure in the throat is 50 kPa, what is the flow rate, assuming ideal frictionless flow?

(a) 7.5 gal/min, (b) 236 gal/min, (c) 263 gal/min, (d) 745 gal/min, (e) 1053 gal/min

Comprehensive Problems

- C3.1** In a certain industrial process, oil of density ρ flows through the inclined pipe in Fig. C3.1. A U -tube manometer, with fluid density ρ_m , measures the pressure difference between points 1 and 2, as shown. The pipe flow is steady, so that the fluids in the manometer are stationary. (a) Find an analytic expression for $p_1 - p_2$ in terms of the system parameters. (b) Discuss the conditions on h necessary for there to be no flow in the pipe. (c) What about flow up, from 1 to 2? (d) What about flow down, from 2 to 1?

- C3.2** A rigid tank of volume $v = 1.0$ m³ is initially filled with air at 20°C and $p_0 = 100$ kPa. At time $t = 0$, a vacuum

pump is turned on and evacuates air at a constant volume flow rate $Q = 80$ L/min (regardless of the pressure). Assume an ideal gas and an isothermal process. (a) Set up a differential equation for this flow. (b) Solve this equation for t as a function of (v, Q, p, p_0) . (c) Compute the time in minutes to pump the tank down to $p = 20$ kPa. *Hint:* Your answer should lie between 15 and 25 min.

- C3.3** Suppose the same steady water jet as in Prob. 3.40 (jet velocity 8 m/s and jet diameter 10 cm) impinges instead on a cup cavity as shown in Fig. C3.3. The water is turned 180° and exits, due to friction, at lower velocity, $V_e =$

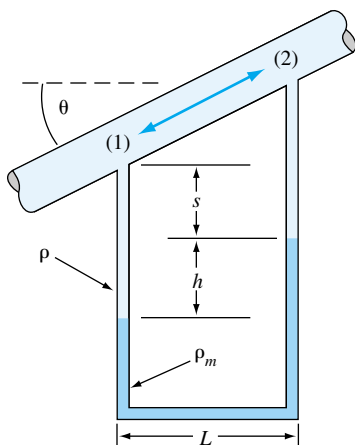

C3.1

4 m/s. (Looking from the left, the exit jet is a circular annulus of outer radius R and thickness h , flowing toward the viewer.) The cup has a radius of curvature of 25 cm. Find (a) the thickness h of the exit jet and (b) the force F required to hold the cupped object in place. (c) Compare part (b) to Prob. 3.40, where $F \approx 500$ N, and give a physical explanation as to why F has changed.

C3.4 The air flow underneath an air hockey puck is very complex, especially since the air jets from the air hockey

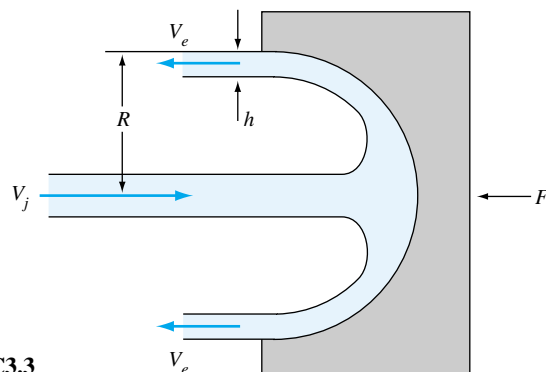

C3.3

table impinge on the underside of the puck at various points nonsymmetrically. A reasonable approximation is that at any given time, the gage pressure on the bottom of the puck is halfway between zero (i.e., atmospheric pressure) and the stagnation pressure of the impinging jets. (Stagnation pressure is defined as $p_0 = \frac{1}{2}\rho V_{\text{jet}}^2$.) (a) Find the jet velocity V_{jet} required to support an air hockey puck of weight W and diameter d . Give your answer in terms of W , d , and the density ρ of the air. (b) For $W = 0.05$ lbf and $d = 2.5$ in, estimate the required jet velocity in ft/s.

Design Project



D3.1 Let us generalize Probs. 3.141 and 3.142, in which a pump performance curve was used to determine the flow rate between reservoirs. The particular pump in Fig. P3.142 is one of a family of pumps of similar shape, whose dimensionless performance is as follows:

Head:

$$\phi \approx 6.04 - 161\zeta \quad \phi = \frac{gh}{n^2 D_p^2} \quad \text{and} \quad \zeta = \frac{Q}{n D_p^3}$$

Efficiency:

$$\eta \approx 70\zeta - 91,500\zeta^3 \quad \eta = \frac{\text{power to water}}{\text{power input}}$$

where h_p is the pump head (ft), n is the shaft rotation rate (r/s), and D_p is the impeller diameter (ft). The range of validity is $0 < \zeta < 0.027$. The pump of Fig. P3.142 had $D_p = 2$ ft in diameter and rotated at $n = 20$ r/s (1200 r/min). The solution to Prob. 3.142, namely, $Q \approx 2.57$ ft³/s and $h_p \approx 172$ ft, corresponds to $\phi \approx 3.46$, $\zeta \approx 0.016$, $\eta \approx 0.75$ (or 75 percent), and power to the water = $\rho g Q h_p \approx 27,500$ ft · lbf/s (50 hp). Please check these numerical values before beginning this project.

Now restudy Prob. 3.142 to select a *low-cost* pump which rotates at a rate no slower than 600 r/min and delivers no less than 1.0 ft³/s of water. Assume that the cost of the pump is linearly proportional to the power input required. Comment on any limitations to your results.

References

1. D. T. Greenwood, *Principles of Dynamics*, Prentice-Hall, Englewood Cliffs, NJ, 1965.
2. T. von Kármán, *The Wind and Beyond*, Little, Brown, Boston, 1967.
3. J. P. Holman, *Heat Transfer*, 7th ed., McGraw-Hill, New York, 1990.
4. A. G. Hansen, *Fluid Mechanics*, Wiley, New York, 1967.
5. M. C. Potter and J. F. Foss, *Fluid Mechanics*, Ronald, New York, 1975.
6. G. J. Van Wylene and R. E. Sonntag, *Fundamentals of Classical Thermodynamics*, 3d ed., Wiley, New York, 1985.
7. W. C. Reynolds and H. C. Perkins, *Engineering Thermodynamics*, 2d ed., McGraw-Hill, New York, 1977.

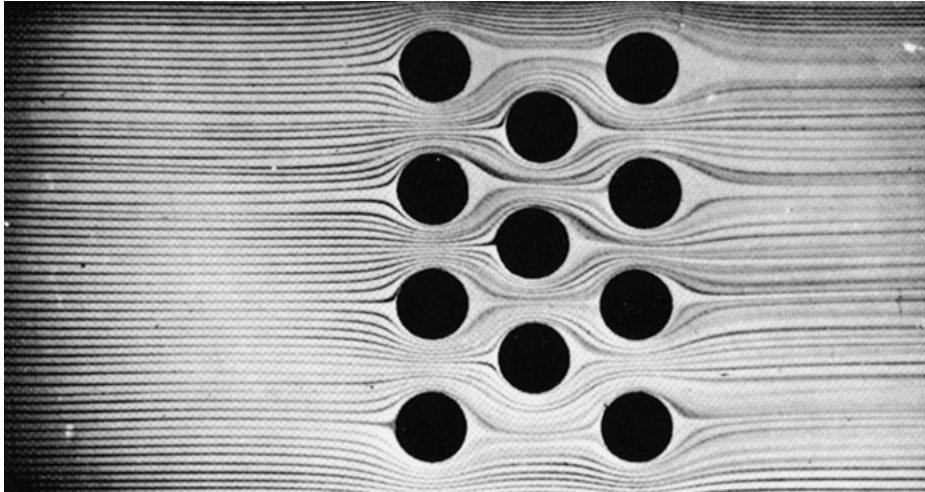

Inviscid potential flow past an array of cylinders. The mathematics of potential theory, presented in this chapter, is both beautiful and manageable, but results may be unrealistic when there are solid boundaries. See Figure 8.13b for the real (viscous) flow pattern. (*Courtesy of Tecquipment Ltd., Nottingham, England*)