

## CHAPTER 4

# Microwave and radio frequency in sterilization and pasteurization applications

J. Tang & Tse V. Chow Ting Chan

*Department of Biological Systems Engineering, Washington State University (WSU), Pullman, WA, USA.*

### Abstract

Microwave and radio frequency (RF) heating represents new means of delivering thermal energy to foods, as compared to transitional hot water and air heating practices used over the centuries in homes and in commercial food processing plants. These new methods rely on volumetric interaction of dielectric materials with electromagnetic energy to generate thermal energy in foods, thus providing more rapid and often more uniform heating than any possible conventional surface heating methods. But in spite of over a half century efforts in research and development, we are still at an early stage of utilizing their potentials in improving industrial heating operations, especially in pasteurization and sterilization applications. A major technical hurdle is to design appropriate applicators, in both microwave and RF heating, to provide predictable and uniform heating patterns in treated foods in order to take full advantage of volumetric heating and shorten the process time. Standing wave patterns and changes of dielectric properties of products with temperature often complicated the design processes. Computer simulation with increasingly powerful simulation packages on ever fast computers has greatly assisted the design of microwave and RF heating systems and processes. This chapter provides fundamental information about the propagation of microwave and RF energy in foods. It describes unique properties of foods in connection with microwave and RF heating, and introduces basic configurations of microwave and RF heating systems. It also provides an overview of current efforts and important issues related to research and development in advancing microwave and RF heating applications in food pasteurization and sterilization to provide safe, high quality, and convenient foods to consumers.



## 1 Introduction

Microwave and radio frequency (RF) heating take place in nonconductive materials due to the polarization effect of electromagnetic radiation at frequencies between 3 and 300,000 MHz. Microwave frequencies are between 300 and 300,000 MHz and RF between 3 and 300 MHz.

Microwave heating started as a by-product of the radar technology developed during World War II, and microwave ovens are now common household appliances. The modern food industry uses microwave energy in different heating processes, including tempering frozen meat or fish blocks for further processing, precooking bacon, and final drying of pasta products. In those applications, microwave heating has demonstrated significant advantages over conventional methods in reducing process time and improving food quality. In spite of the many advantages of microwave heating over conventional steam or hot air heating methods, its use in the food industry has been hindered by relatively expensive equipment, the higher price of electricity than fossil fuels, and a lack of basic information on the dielectric properties of foods and their relationship to microwave heating characteristics. The food processing industry is, in general, reluctant to make expensive investments in a technology that has not been proven to be reliable for large-scale or long-term use [1].

With the development of reliable magnetrons and use of circulators to protect microwave generators, microwave equipment is more stable and has a long operating life. In addition, the cost of microwave equipment has been reduced over the years, making the use of microwave heating more attractive in food processing applications.

RF dielectric heating has been used in different nonfood industrial applications, including welding thin sheets of plastic materials to form fabricated articles, curing glue in plywood, and heating rubber. RF is used extensively in drying textile products, paper, glass fiber and wool spools, water-based glues, wood and sawdust, and cigarette leaves. The largest application of RF heating in the food industry is the postbake drying of cookies, biscuits, and crackers. In drying applications, RF energy is directly coupled with the food material and converted into thermal energy needed for the phase change of water, thus sharply reducing drying time. RF has the ability to automatically level the moisture variation in foods, and is often used to reduce drying time and improve the moisture uniformity of foods in falling rate drying stages.

Microwave and RF heating can be particularly beneficial in modern sterilization and pasteurization operations to control pathogenic and spoilage microorganisms in packaged foods. Conventional food sterilization or pasteurization processes use heated water or steam to treat packaged foods and make them safe. The processing times necessary for thermal energy to transfer from a product's surface to the interior can be very long, due to the small thermal conductivities within foods. Long thermal treatments may result in considerable and sometimes unacceptable changes in the sensory quality of foods. High temperature short time (HTST) processing, using plate heat exchangers or steam flashing methods, has been developed for liquid



foods to reduce adverse thermal degradation while still ensuring food safety. HTST processes with conventional heating methods for solid or semi-solid foods packaged in meaningful size containers is, however, impossible because of the slow heat conduction in foods which often causes over-heating at the solid's surface during the time needed for the heat to be transferred to the center (least processed spot). Microwave and RF heating offer the possibility of overcoming this limitation. Direct interaction between electromagnetic energy and foods that are hermetically sealed in microwave or RF transparent pouches or trays can significantly reduce the time for products to reach the desired temperatures and control the targeted bacteria, thus improving organoleptic quality, appearance, and nutritional values [2–5]. Another potential advantage of microwave and RF in thermal processing is energy saving. Since the system is designed to directly heat the products, there is no need to exhaust air by using steam, like in a retort system. The processes can be highly automated and provide a cleaner work environment.

Microwave and RF heating of foods are complicated physical processes that depend on the propagation of electromagnetic waves governed by Maxwell's equations, interactions between electromagnetic waves and foods determined by their dielectric properties, and heat dissipation governed by basic heat and mass transfer theories. This chapter provides an overview of the fundamental principles that determine the unique features of microwave and RF heating, a description of microwave and RF systems, and a discussion on past research with regards to the mechanism for control of microorganisms with microwave or RF energy, followed by a review of the related research and applications of microwave and RF in pasteurization and sterilization of prepackaged foods. The chapter concludes with comments on furthering the development of microwave and RF sterilization technologies.

## 2 Basic principles of microwave and RF heating

### 2.1 Mechanisms of microwave and RF heating

Food materials are, in general, poor electric insulators; they have the ability to store and dissipate electric energy when subjected to an electromagnetic field. Dielectric properties play a critical role in determining the interaction between electric fields and foods [6]. The dielectric properties of a material are given by

$$\epsilon_r = \epsilon' - j\epsilon'' = |\epsilon| e^{-j\delta} \quad (1)$$

where  $\epsilon_r$  is the complex relative dielectric constant,  $\epsilon'$  the relative dielectric constant (relative to that of air),  $\epsilon''$  the relative dielectric loss factor,  $\delta$  dielectric loss angle ( $\tan \delta = \epsilon''/\epsilon'$ ), and  $j = \sqrt{-1}$ .

$\epsilon'$  reflects the material's ability to store electric energy (for vacuum  $\epsilon' = 1$ ), whereas  $\epsilon''$  indicates the ability to convert electric energy into thermal energy.

Microwave energy is converted into thermal energy in a foodstuff according to [7]:

$$P_v = 5.56 \times 10^{-11} \times f \epsilon''_{\text{eff}} E^2 \quad (2)$$



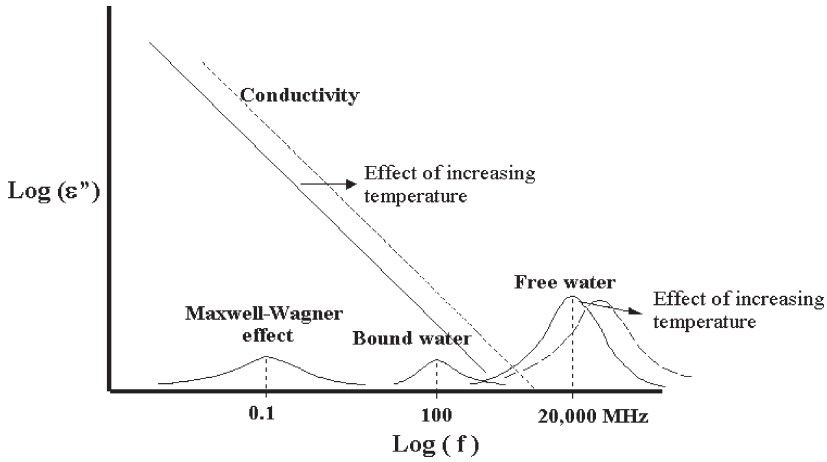

Figure 1: Contributions of various mechanisms of the loss factor of moist materials as a function of frequency. The critical frequencies indicate the relative locations of the peaks [10].

where  $P_v$  is the power conversion per unit volume ( $W/m^3$ ),  $f$  the frequency (Hz),  $\epsilon''_{eff}$  the effective relative dielectric loss factor as defined below, and  $E$  the electric field (V/m).

Ionic conduction and various polarization mechanisms (including dipole, electronic, atomic, and Maxwell–Wagner) all contribute to the dielectric loss factor [8, 9]. But in microwave and RF ranges used in food applications (e.g. 13.6 MHz to 2450 MHz in North America), ionic conduction and dipole rotation are the main loss mechanisms (Fig. 1). That is,

$$\epsilon''_{eff} = \epsilon''_d + \epsilon''_\sigma = \epsilon''_d + \frac{\sigma}{\epsilon_0 \omega} \tag{3}$$

where subscripts d and  $\sigma$  stand for the contribution due to dipole rotation and ionic conduction, respectively.  $\omega$  is the angular frequency of the waves, and  $\epsilon_0$  is the permittivity of free space ( $10^{-9}/36\pi$  F/m). Maxwell–Wagner polarization arises from build-up of charges at the interface between components in heterogeneous systems. It peaks at about 100 kHz [8]. The influence of Maxwell–Wagner polarization is very weak at the frequency ranges used in industrial microwave and RF applications.

## 2.2 Frequencies allocated for industrial heating applications

The electromagnetic spectrum that covers microwave and RF frequencies is congested with assigned bands for various communication purposes. Only a small number of microwave and RF bands are allocated for industrial, scientific, and medical (ISM) applications, including food processing applications (Table 1). The frequency bands centered at 13.56, 27.12, 40.68, 896, 915, and 2450 MHz are most



Table 1: Important RF and microwave frequency allocations for ISM use [6, 8, 11].

Frequency $f$ (MHz)	Frequency tolerance (MHz)	Wavelength in free space $\lambda$ (m)	Typical applications	Countries
<b>RF frequencies</b>				
13.56	$\pm 0.067$	22.1	Curing of ceramic, final drying of bakery products, textile and wood drying and curing, bonding	Worldwide
27.12	$\pm 0.160$	11.1	Same as above	Worldwide
40.68	$\pm 0.020$	7.4	Same as above	Worldwide
<b>Microwave frequencies</b>				
896	$\pm 10$	0.335	Tempering of frozen products	UK
915*	$\pm 13$	0.327	Precooking of bacon, tempering of frozen products	North and South America
2375	$\pm 50$	0.126	Domestic microwave ovens	Albania, Bulgaria, Hungary, Romania, Czechoslovakia, former USSR
2450	$\pm 50$	0.122	Domestic microwave ovens, precooking of bacon, pasteurization and sterilization of packaged foods	Worldwide, except where 2375 MHz is used

\*A number of US manufacturers had 915-MHz equipment accepted for use in Europe by keeping interference emissions below the acceptable level for the country of installation [6].



commonly used in ISM applications. Off-the-shelf power generators at those frequency bands are readily available from commercial suppliers. Other frequencies are also allocated for ISM uses in different countries. For example, 42, 49, 56, 84, and 168 MHz are permitted in Great Britain, and 433.92 MHz is allocated in the Netherlands, Austria, Portugal, Germany, and Switzerland [8].

### 2.3 Governing equations for electromagnetic waves

In microwave and RF heating, energy is delivered to the products through propagation of electromagnetic waves as a result of interactive and oscillating electric and magnetic field components, governed by time-harmonic Maxwell's equations [8, 12, 13]:

$$\nabla \times \mathbf{E} = -j\omega\mu\mu_0\mathbf{H} \quad (4)$$

$$\nabla \times \mathbf{H} = (\sigma + \omega\varepsilon_0\varepsilon''_d)\mathbf{E} + j\omega\varepsilon'\varepsilon_0\mathbf{E} \quad (5)$$

where  $\mathbf{E}$  is the electric field strength,  $\mathbf{H}$  is the magnetic field strength,  $\mu$  is the permeability, and  $\mu_0$  is the permeability of free space with a value of  $4\pi \times 10^{-7}$  H/m. The term  $(\sigma\mathbf{E})$  in eqn (5) represents the conduction current density (in A/m<sup>2</sup>) of moving electrons or charged particles. The last term in eqn (5) is known as the displacement current density associated with the propagation of electromagnetic fields. In food products, the oscillating electric field causes polarization and generates heat. The magnetic component does not interact with foods. However, magnetic materials such as ferrite, often used in susceptors and browning dishes, will interact with the magnetic field and result in substantial heating [6].

Eqns (4) and (5) can be combined to form the wave equation

$$\nabla^2\mathbf{E} - \gamma^2\mathbf{E} = 0 \quad (6)$$

$\gamma$ , the propagation constant, is given by [12]:

$$\gamma = \sqrt{j\omega\mu_0[(\sigma + \omega\varepsilon_0\varepsilon''_d) + j\omega\varepsilon_0\varepsilon']} \quad (7)$$

The above relationship determines the speed of propagating electromagnetic waves and the difference between the electric and magnetic field phases.  $\gamma$  is a complex quantity, and can be expressed as

$$\gamma = \alpha + j\beta \quad (8)$$

where  $\alpha$  is the attenuation factor and  $\beta$  is the phase constant.

From eqn (8),

$$\alpha = \omega \sqrt{\frac{\mu\varepsilon_0\varepsilon'}{2} \left[ \sqrt{1 + \left[ \frac{\sigma + \omega\varepsilon_0\varepsilon''_d}{\omega\varepsilon_0\varepsilon'} \right]^2} - 1 \right]} \quad (9)$$



and

$$\beta = \omega \sqrt{\frac{\mu \epsilon_0 \epsilon'}{2} \left[ \sqrt{1 + \left[ \frac{\sigma + \omega \epsilon_0 \epsilon''_d}{\omega \epsilon_0 \epsilon'} \right]^2} + 1 \right]} \quad (10)$$

The speed of wave,  $u$ , is given by [12]

$$u = \frac{\omega}{\beta} = \frac{2\pi f}{\beta} \quad (11)$$

and the wavelength,  $\lambda$ , is calculated by

$$\lambda = \frac{u}{f} = \frac{2\pi}{\beta} \quad (12)$$

In free space,  $\sigma = 0$ ,  $\mu = \mu_0$ ,  $\epsilon'' = 0$ , and  $\epsilon' = 1$  from eqns (7) and (8):

$$\alpha = 0, \quad \beta = \omega \sqrt{\mu_0 \epsilon_0}$$

Therefore, the speed of electromagnetic waves in free space,  $u_0$ , according to eqn (11) is

$$u_0 = \frac{\omega}{\beta} = \frac{1}{\sqrt{\mu_0 \epsilon_0}} = \frac{1}{\sqrt{(4\pi \times 10^{-7}) \times (10^{-9}/36\pi)}} = 3 \times 10^8 \text{ m/s} \quad (13)$$

This value is the same as the speed of light in free space.

## 2.4 Electromagnetic wave propagation

When a wave from one medium meets a different medium, it is partially reflected and partially transmitted. The proportion of the incident wave that is reflected or transmitted depends on the difference between the intrinsic impedances of the two media.

### 2.4.1 Intrinsic impedance

The intrinsic impedance,  $\eta$ , is defined as the ratio between the electric and magnetic fields [12]:

$$\eta = \sqrt{\frac{j\omega\mu}{(\sigma + \omega\epsilon_0\epsilon''_d) + j\omega\epsilon_0\epsilon'}} = |\eta| e^{j\theta_\eta} \quad (14)$$

The magnitude of the impedance is calculated as

$$|\eta| = \frac{\sqrt{\mu/\epsilon'\epsilon_0}}{\left[1 + \left(\frac{\sigma + \omega\epsilon_0\epsilon''_d}{\omega\epsilon_0\epsilon'}\right)^2\right]^{1/4}} = \frac{\eta_0/\sqrt{\epsilon'}}{\left[1 + \left(\frac{\epsilon''_{\text{eff}}}{\epsilon'}\right)^2\right]^{1/4}} \quad (15)$$



$\eta_o (= \sqrt{\mu_o}/\sqrt{\epsilon_o})$  is the intrinsic impedance of free space, and the phase angle is calculated as

$$\tan 2\theta_\eta = \frac{\sigma + \omega\epsilon_o\epsilon''_d}{\omega\epsilon_o\epsilon'} = \frac{\epsilon''_{eff}}{\epsilon'} \tag{16}$$

Substituting the values for  $\mu_o$  and  $\epsilon_o$  into  $\eta_o = \sqrt{\mu_o}/\sqrt{\epsilon_o}$  yields a value of  $377\Omega$  for free space. Based on eqn (14), water at  $25^\circ\text{C}$  has an intrinsic impedance of  $43\Omega$ , and ice has an intrinsic impedance of  $210\ \Omega$  at  $2450\ \text{MHz}$ .

**2.4.2 Refraction and reflection**

A difference between the intrinsic impedance of two media causes mismatch, which leads to a portion of the wave being reflected at the interface of two different materials and the transmitted waves changing the direction (refraction) of propagation when entering a different material (see Fig. 2).

Snell’s law describes the extent of refraction for transmitted waves [1]:

$$\sin \psi = \frac{\eta \sin \phi}{\eta_o} \tag{17}$$

where  $\psi$  is the angle of refraction and  $\phi$  is the angle of incidence.

Dielectric properties of foods are much larger than that of air. As a result, the refracted waves in spherical and cylindrical foods are directed toward the center. Most foods have dielectric constants  $\epsilon' > 40$ . Buffler [6] estimated that in those foods all the incident microwaves travel within a cone angle of  $9^\circ$  from the internal normal toward the center of the spheres (Fig. 3). When the sphere diameter is less than 2.5–3 times the wave penetration depth,  $dp$  (see Section 2.5 for further details), the focused power at the center would cause severe core heating [14]. This is often observed when heating eggs or small potatoes in a domestic oven.

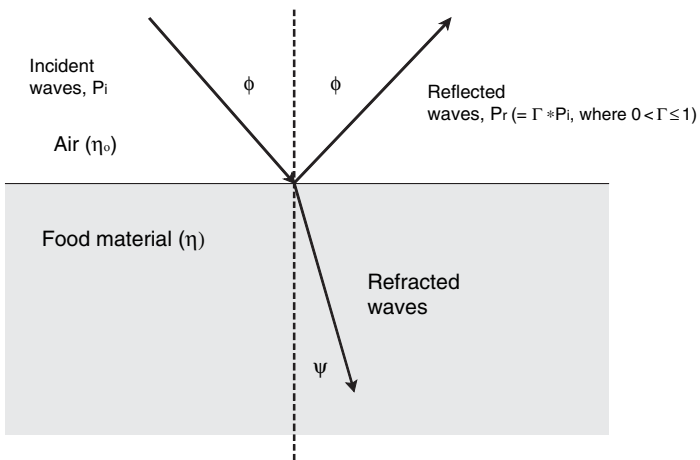

Figure 2: Refraction and reflection of electromagnetic waves when entering a different media [10].



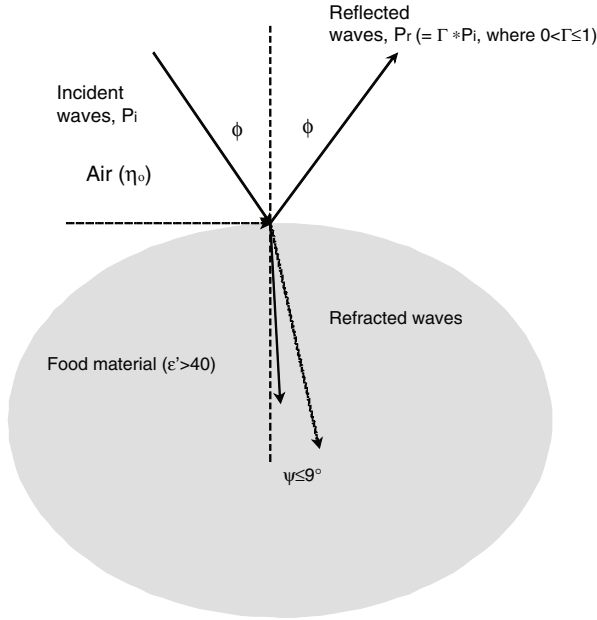

Figure 3: Behavior of microwaves when entering a curved medium.

For electric wave that is polarized in parallel to an interface, the reflected index (ratio of the magnitude of the reflected electric intensity  $E_r$  and incident electric intensity  $E_i$ ) can be calculated as [15]

$$\rho = \frac{E_r}{E_i} = \frac{\eta_0 \cos \psi - \eta \cos \phi}{\eta_0 \cos \psi + \eta \cos \phi} \tag{18}$$

Since power dissipation in dielectric materials is proportional to  $E^2$  (see eqn (2)), the transmitted power  $P_t$  is only a fraction of the incident power  $P_i$  and is given by

$$P_t = P_i(1 - \rho^2) \tag{19}$$

Thus, when the intrinsic impedance of a food is much different from the free space, only a small portion of incident waves is transmitted into the food and a large portion of the waves is reflected. For example, Table 2 shows the percentage of transmitted power at 2450 MHz into a large body of ice or water based on eqns (17) and (19).

In a perfect conductor,  $\sigma = \infty$ . According to eqn (14), the intrinsic impedance  $\eta$  is zero. From eqn (18),  $\rho = 1$ . This means that waves are completely reflected at the surface of a perfect conductor. A similar conclusion can be drawn for metals that are not perfect conductors but have high electric conductivities.

Table 2: Refraction angle and percentage of transmitted power at a flat interface between air and ice or water as a function of the incident angle [10].

Material	Intrinsic impedance/ $\Omega$	Incident angle	Refracted angle (based on eqn (17))	Percentage of transmitted power (based on eqn (19))
Ice	210	0	0	92
		30°	16.17°	89
		90°	33.85°	0
Water (at 5°C)	43	0	0	37
		30°	3.27°	33
		90°	6.55°	0

### 2.4.3 Changes of wavelength in different media

The wavelength of electromagnetic waves in free space,  $\lambda_o$ , can be calculated from eqn (12):

$$\lambda_o = \frac{2\pi}{\beta} = \frac{2\pi}{\omega\sqrt{\mu_o\epsilon_o}} = \frac{2\pi}{2\pi f\sqrt{\mu_o\epsilon_o}} = \frac{1}{f\sqrt{\mu_o\epsilon_o}} \quad (20)$$

The wavelength in foods can also be calculated from

$$\lambda = \frac{2\pi}{\beta} = \frac{2\pi}{\omega\sqrt{\frac{\mu\epsilon_o\epsilon'}{2}\left[\sqrt{1+\left(\frac{\epsilon''}{\epsilon'}\right)^2}+1\right]}} = \frac{\lambda_o}{\sqrt{\frac{\epsilon'}{2}\left[\sqrt{1+\left(\frac{\epsilon''}{\epsilon'}\right)^2}+1\right]}} \quad (21)$$

For example, the value of  $\epsilon'$  of water at 2450 MHz is about 78 at room temperature. Thus, the wavelength of electromagnetic waves traveling within a body of water is about one-ninth that of the waves in free space, approximately 0.014 m at 2450 MHz and 0.037 m at 915 MHz, compared to 0.122 and 0.328 m, respectively, in free space. Similarly,  $\epsilon'$  in moist foods is close to that of the water, the wavelength of electromagnetic waves in those materials is much shorter than in free space  $\lambda_o$ . Because of the short wavelength in moist foods, it is likely that standing wave patterns will develop even though the size of the foods may be smaller than the wavelength of electromagnetic waves in free space. These standing wave patterns may cause nonuniform heating.

### 2.4.4 Coupling of power in a microwave oven

The coupling of power into food in a multimode domestic microwave oven depends on the dielectric properties and total volume of the food. The microwave power absorbed by the foods  $P$  can be related to the net generated system power  $P_o$  and



the volume of foods  $V$  by the following empirical relation [1]:

$$P_o = P(1 - e^{-bV}) \quad (22)$$

where  $b$  depends on the geometry and dielectric properties of foods and on the characteristics of the microwave oven.

## 2.5 Penetration depth of microwave and RF waves in foods

When propagating through a dielectric material, a portion of electromagnetic energy is converted into thermal energy, the remaining power decays with distance from the surface. The reduction of electromagnetic power as the waves travel into a semi-infinite dielectric body can be described by Lambert's law:

$$P(z) = P_o e^{-2\alpha z} \quad (23)$$

where  $P_o$  is incident wave power at the surface, and  $P(z)$  is wave power at distance  $z$  in the direction of wave propagation within the material.

But Lambert's law applies only to a relatively large body of a dielectric material in which waves are attenuated and when there is little reflection within the material at the opposite interface with the air. Ayappa *et al.* [16] have shown that Lambert's Law applies to a slab when its thickness satisfies the following condition:

$$L \geq L_{\text{crit}} = 5.4 \text{ dp} - 0.08 \text{ cm} \quad (24)$$

where  $\text{dp}$ , as mentioned earlier, is the penetration depth of the waves in food. The power penetration depth,  $\text{dp}$ , is defined as the distance where the power is reduced to  $1/e$  ( $e = 2.718$ ) of the power entering the food's surface:

$$P(\text{dp}) = \frac{P_o}{e} \quad (25)$$

In general, 915 MHz microwaves have deeper penetration depths in foods than 2450 MHz. But the penetration depth of microwaves also varies with temperature (Table 3). The limiting depth or penetration of microwaves in foods often causes nonuniform heating.

When satisfying eqn (24), calculations using Lambert's law lead to less than 1% error as compared to more rigorous analysis with Maxwell's equations for plane waves. Otherwise, the interference between transmitted and reflected waves between the two slab surfaces creates standing waves, causing internal hot and cold spots. As described by Lambert's law, the wave intensity reduces exponentially with depth into a lossy material (Fig. 4).

Tables 3 and 4 show a comparison between the penetration depths of microwaves and RF in selected foods. Although these data do not allow direct one-to-one comparison for a given food, they nevertheless provide an overall idea of the vast difference between the penetration depths of microwave and RF energy in food systems. More discussion differences between dielectric properties of food systems in microwave and RF frequencies can be found elsewhere [18, 19].



Table 3: Penetration depth of microwaves in selected foods (data were measured in the Washington State University (WSU) laboratory, unless otherwise indicated) [10].

Material	Temperature (°C)	915 MHz			2450 MHz		
		$\epsilon'$	$\epsilon''_{\text{eff}}$	dp (mm)	$\epsilon'$	$\epsilon''_{\text{eff}}$	dp (mm)
Deionized water	20	79.5	3.8	122.5	78.2	10.3	16.8
Ice	-12	-	-	-	3.2	0.003	11.62
Water with 0.5% salt	23	77.2	20.8	21.5	75.8	15.6	10.9
Ham*	25	61	96	5.1	60	42	3.8
	50	50	140	3.7	53	55	2.9
Yogurt (premixed)	22	71	21	21.2	68	17.5	9.3
Apple (red delicious)	22	60	9.5	42.7	57	12	12.3
Potato (raw)	25	65.1	19.6	21.7	53.7	15.7	9.2
Asparagus	21	73.6	20.6	22.2	71.34	16	10.4
Whey protein gel (20% solid)	22	50.9	17.0	22.4	40.1	12.9	10.6
Corn oil	25	2.6	0.18	481.1	2.5	0.14	216.7

\*From Mudgett [1].

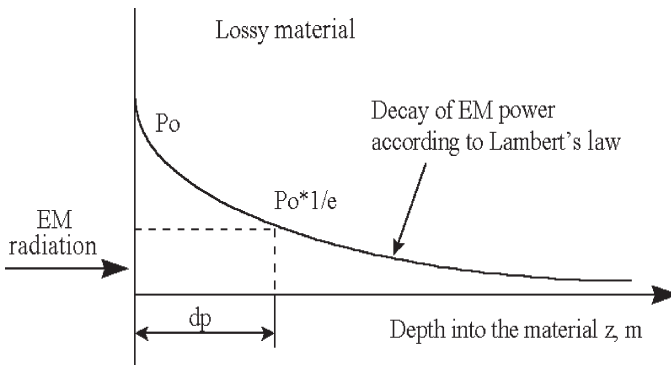

Figure 4: Definition of penetration depth.

### 2.6 Effect of temperature on food dielectric properties

Many factors, including the frequency of electromagnetic waves, temperature, product moisture content, salt content, and other food constituents, directly influence the dielectric properties of foods and, therefore, the interactions between foods



Table 4: Dielectric properties of selected foods at radio frequencies [17].

Product	MHz	MC (%)	Temperature (°C)	$\epsilon'$	$\epsilon''$	Penetration depth (m)	
Pure water	10		85	58	0.73	49.8	
			25	78	0.36	117.1	
			1.5	87	0.174	256.0	
			-12	3.7	0.067	137.1	
			-20	1.2	0.045	116.3	
Flour/water	27	10	20	10	2	2.81	
		30	20	30	10	0.98	
		60	20	66	70	0.23	
		90	20	76	30	0.52	
Lean meat	35		10	78	234	0.07	
			0	75	195	0.08	
			-10	10	4	1.10	
	10		10	100	800	0.13	
			0	90	540	0.16	
Cod fish	35		-10	12	12	1.51	
			10	76	304	0.06	
			0	74	222	0.08	
	10		-10	10	8	0.58	
			10	92	1104	0.11	
			0	92	773	0.13	
Beef fat	35		-10	12	19	1.04	
			10	7.3	6.8	0.59	
			0	6.7	5.4	0.70	
			-10	2	0.45	4.31	
Pork fat	35		10	8.2	4.9	0.83	
			0	7.2	3.5	1.08	
			-10	4	0.8	3.43	
Corn	50		10	24	4	3.83	
			30	24	7	1.70	
			50	24	10	5.0	0.62
	20		10	24	4	0.3	15.9
			30	24	6.5	1	6.10
			50	24	12	7	1.23

and electromagnetic waves [8, 10, 13]. Such influencing factors need to be considered in selecting the appropriate frequency for processing, design of package geometry, and product development. Of particular importance to thermal processing is the effect of temperature on dielectric properties, which may change the heating pattern in a product as its temperature increases during heating. Special consideration



should be given in designing processes and/or products to ensure the effectiveness of thermal processes based on electromagnetic energy. From a mathematical viewpoint, changes in dielectric properties with temperature require consideration of coupled electromagnetic (Maxwell's equations) and thermal phenomena (thermal diffusion equations), which creates a major challenge in the numerical simulation of dielectric heating.

In a food system, the change of dielectric properties with respect to temperature depends on the frequency, bound water to free water ratio, ionic conductivity, and material composition. A detailed discussion of the dielectric properties of foods as a function of temperature can be found elsewhere [20]. At RF frequencies 10–100 MHz, where ionic conduction is the dominant dispersion mechanism in dielectric heating of moist foods containing a certain amount of dissolved ions, dielectric loss factors often increase with temperature. Figure 5 shows the effect of temperature on mashed potato samples with different salt content at 27 MHz. It is clear that the higher the salt content, the higher the loss factor, which results in a sharp increase in loss factor with increasing temperature and a phenomenon commonly referred to as 'thermal runaway' in which the high-temperature portion of a product has a higher heating rate than the colder portion. It is very difficult to provide uniform heating when the initial product temperature or electromagnetic field is not uniform. This should be a major concern in the design of RF applicators and RF heating processes.

In the microwave frequency range of practical importance in food heating applications (800–3000 MHz), both ionic conduction and dipole rotation (eqn (3)) play important roles. The changes of the loss factor in foods over this frequency range are highly dependent upon salt content. Figure 6 shows the effect of temperature

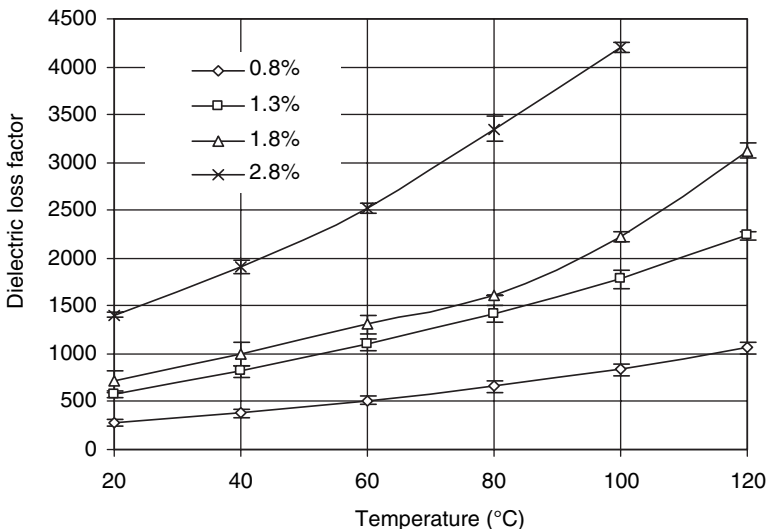

Figure 5: Effect of added salt (in %) on the dielectric loss factor of mashed potatoes (moisture content: 85.9%, w.b.) at 27 MHz [18].

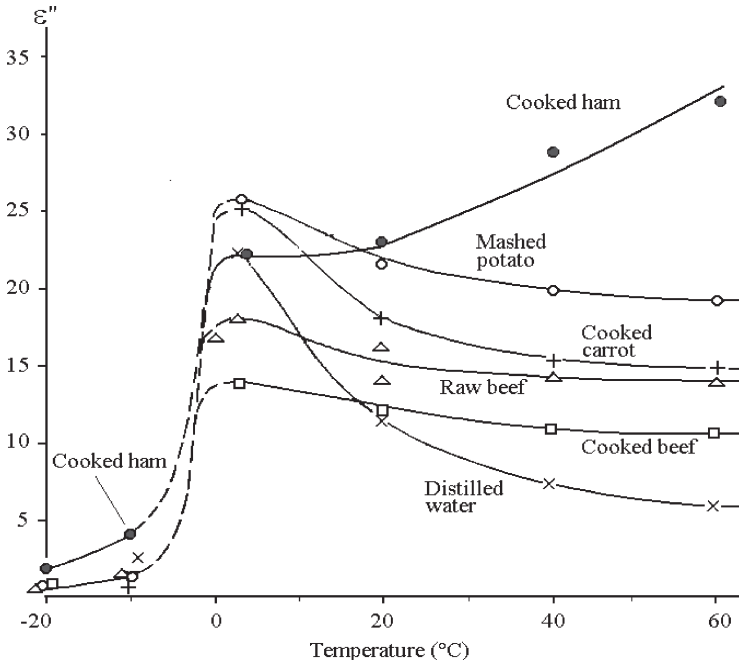

Figure 6: The dielectric loss factor ( $\epsilon''$ ) of selected foods at 3000 MHz as affected by temperature (adapted from [21]).

on the loss factor of different foods at 2450 MHz [21]. The high salt content of the ham makes its dielectric properties quite different from the rest of the materials included in the graph. Due to ionic conduction, the loss factors increase with temperature above the freezing point, which is contrary to the trend of dielectric properties in other foods in which the loss mechanisms are mostly determined by the dipole polarization of free water at 2450 MHz. One advantage of the reduced loss factor with increasing temperature is the so-called temperature leveling effect. That is, when a given portion of a food is over-heated, the loss factor of that part is reduced, which results in less conversion of microwave energy to heat at that part of the food and helps to reduce nonuniform spatial temperature distribution.

### 3 Microwave and RF heating systems

#### 3.1 Microwave heating systems

Microwave heating systems fall into three broad categories: multimode resonant, single-mode resonant, and traveling wave applicators. This section briefly describes each of the applicators. For more details on the different types of applicators, the reader is referred to Metaxas and Meredith [8] and Chow Ting Chan and Reader [22].



### 3.1.1 Multimode resonant applicators

By far the most widely used is the multimode resonant cavities applicator. A mode corresponds to a fixed field pattern within a metal cavity at a specific resonant frequency. Microwaves in domestic microwave ovens and industrial food heating systems are generated by magnetrons. These devices generate microwaves over a narrow band of frequencies rather than a fixed frequency, as illustrated in Fig. 7 for a 5 kW 915 MHz microwave generator. A multimode cavity is typically rectangular in shape, with large-enough dimensions to sustain many different modes over the frequency spectrum of the magnetron. The familiar domestic microwave oven is an example of a multimode applicator. Most industrial microwave systems are simply a scaled-up version of the domestic microwave oven; however, besides being larger and more powerful than its domestic counterparts, industrial microwave systems have open ends to allow products to move from one end to the other on a conveyor belt.

Because the frequency range of a magnetron can excite multiple modes in large cavities, those multimode cavities are generally considered to provide relatively good uniform heating. The argument is based on the fact that since each mode has its own specific heating pattern, i.e. hot and cold regions, and there are many modes with their own distinct patterns, the overall combined pattern tends to be better than an applicator with a single mode. A domestic microwave oven either uses a rotary metal mode stirrer at the top of the cavity to change field patterns or a rotary turntable to move foods through field patterns to improve heating uniformity (Fig. 8). Similarly, mode stirrers and/or conveyor belts are used in multimode microwave tunnels in industrial systems (Fig. 9). A major challenge with the multimode cavity is that the field pattern is unpredictable and, often, unstable with minor

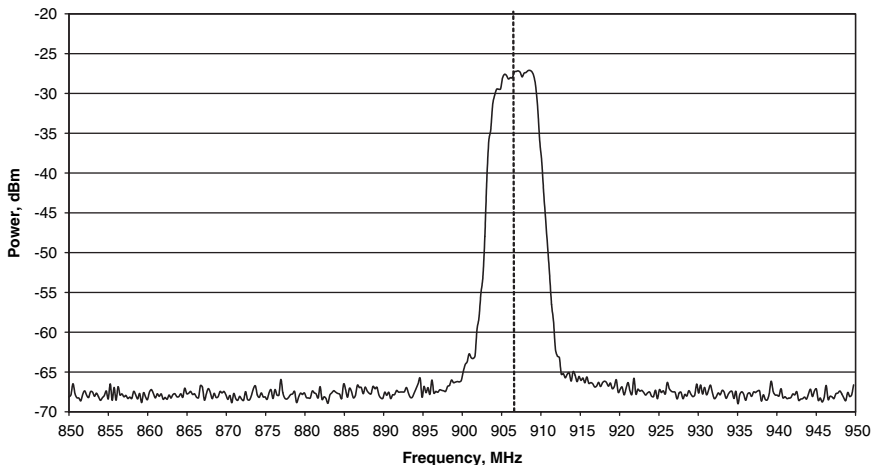

Figure 7: Frequency spectrum of a 915 MHz generator measured with a spectrum analyzer at Washington State University (WSU).





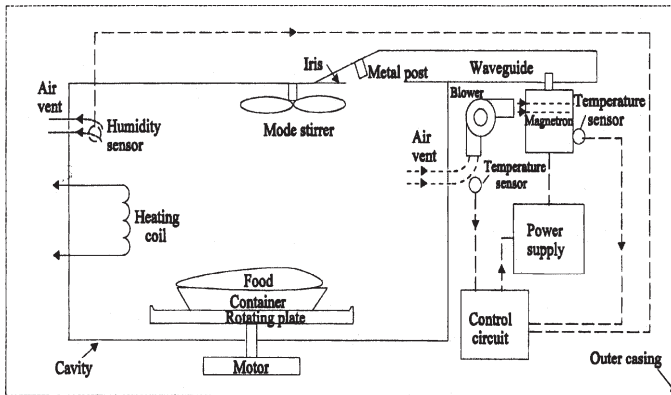

Figure 8: A multimode domestic microwave oven [22].

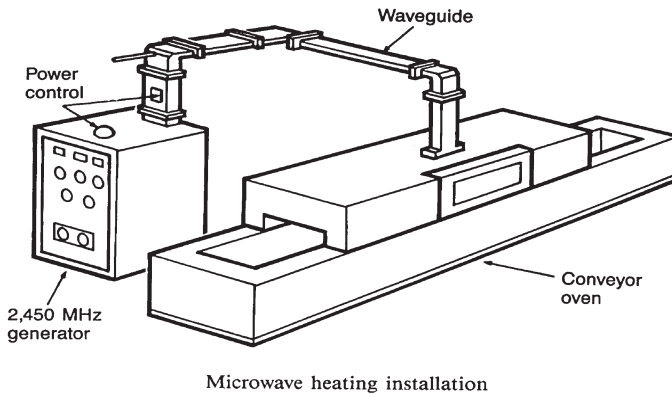

Figure 9: A multimode 2450 MHz industrial microwave system [11].

changes in process conditions. Researchers often experience difficulty in reproducing results published by other researchers with multimode systems because of the difficulty in replicating each of the following important factors: the dimensions of the cavity; shape, volume and placement of the load; spectrum bandwidth and center frequency of the magnetron; and waveguide feeding position, critical in exciting modes inside the cavity.

The number of excited modes in a loaded cavity may be totally different from than when it is empty. Although distinctive number of modes in an empty cavity can be calculated analytically, when loaded, hybrid modes are present in the cavity.

### 3.1.2 Single-mode resonant applicator

Unlike multimode cavities, a single-mode cavity, as its name implies, can sustain only one mode. The advantage of a single-mode cavity is that the heating pattern



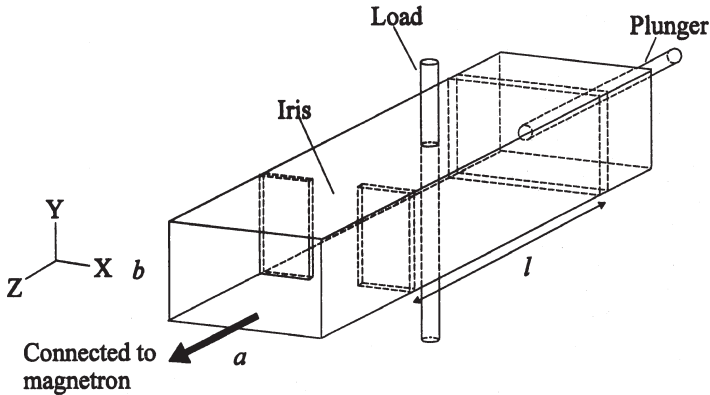

Figure 10: A  $TE_{10l}$  single-mode cavity [22].

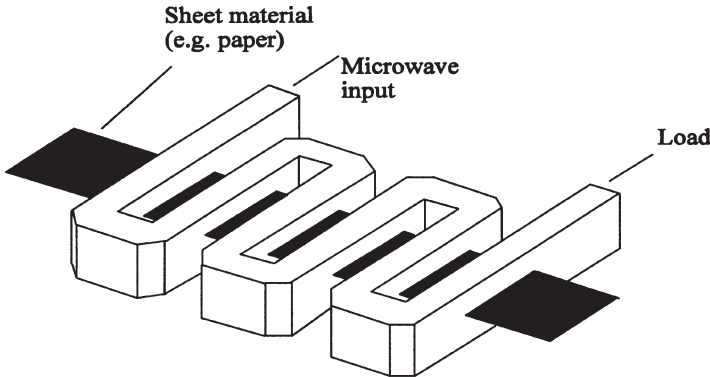

Figure 11: Applicator for heating sheet materials [22].

is well defined within the frequency range of the magnetron. The most common mode used for a cylindrical cavity is the  $TM_{010}$ , which has a uniform electric field along its cylindrical axis.

An example of a single-mode cavity is shown in Fig. 10. A piece of rectangular waveguide is excited at one end and shorted at the other. A plunger is used to tune the system so that optimum power is coupled to the load. Mode  $TE_{10l}$  is the most commonly used in a rectangular waveguide. Subscript  $l$  refers to the number of half-sinusoidal variations of the field along the principal coordinate axis.

### 3.1.3 Traveling wave applicator

By matching a source to a load, a traveling wave is produced. Figures 11 and 12 show examples of traveling wave applicators. The first one is for drying sheet materials such as paper, whereas the second is used to heat filamentary materials.

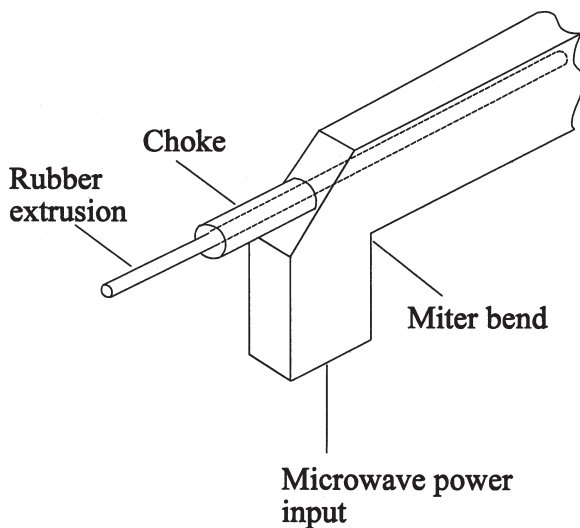

Figure 12: Applicator for heating filamentary materials [22].

### 3.2 RF heating systems

Similar to microwave systems, an RF heating system consists mainly of two sections: a generator and an applicator.

#### 3.2.1 RF generators

The RF heating system falls into two categories: the free running oscillator or the 50 Ω system. The free running oscillator system represents about 99% of the RF systems used in the industry.

A schematic view of a free running oscillator RF heating system is shown in Fig. 13. Alternating current (AC) voltage from the mains is stepped up by a

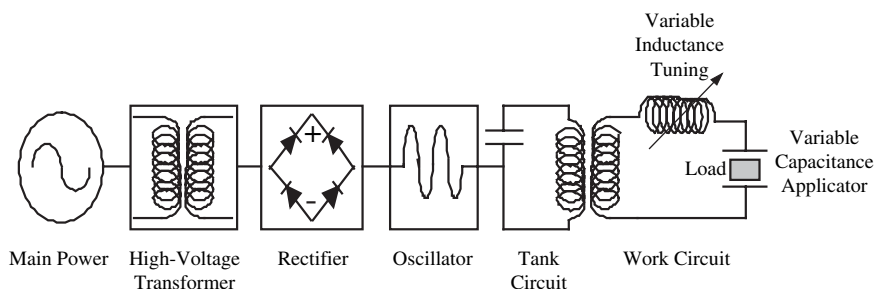

Figure 13: Schematic view of the circuits for a free running oscillator RF heating system [17].

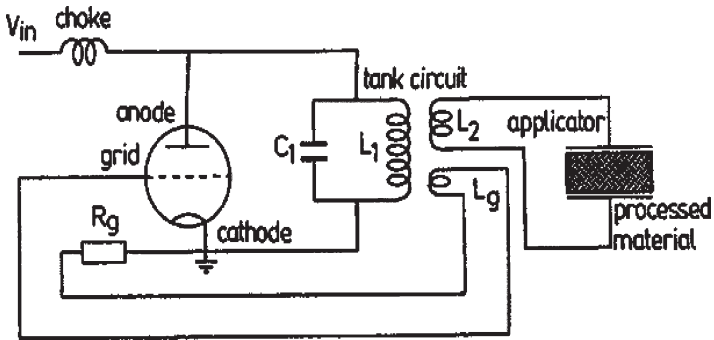

Figure 14: Self-excited class C oscillator circuit [23].

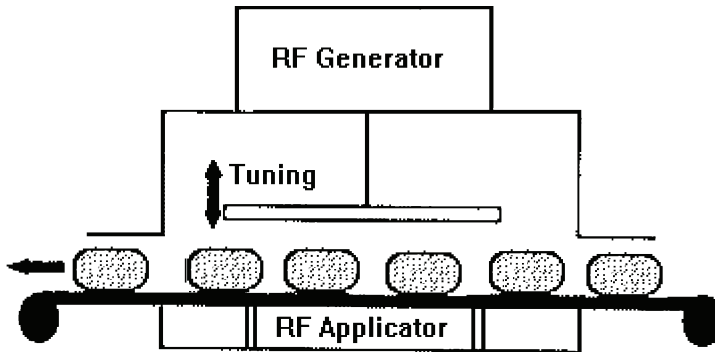

Figure 15: Schematic view of a free running oscillator RF heating system [24].

transformer to several kilovolts. The AC voltage from the output of the transformer is then converted to direct current (DC) voltage using a smoothed rectifier circuit. The DC voltage is applied to a triode valve. The latter, operating under class C conditions, is part of an oscillator circuit which converts the DC input from the rectifier to high frequency power. Energy efficiency in RF power generation is between 55% and 70%, and overall system efficiency is between 50% and 60% [23].

Figure 14 shows a self-excited class C oscillator circuit. The material to be processed is placed between the capacitive electrodes. It becomes an integral part of the applicator circuit. The applicator circuit is inductively coupled to the tank circuit, consisting of  $C_1$  and  $L_1$ , via inductor  $L_2$ . The applicator circuit is matched to the tank circuit by changing a series or parallel variable inductance (Fig. 13) or adjusting the position of one electrode to change capacitance (Fig. 15), thus allowing desired coupling of power from the generator to the processed materials.

In the  $50 \Omega$  system (Fig. 16), a crystal oscillator provides a weak signal at a stable frequency (e.g. 27.12 MHz). This signal is subsequently amplified and transmitted through a coaxial cable to the applicator. An impedance-matching network

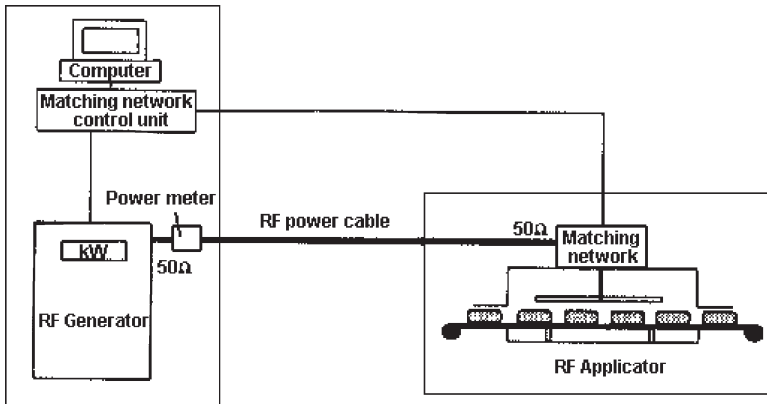

Figure 16: The components of a typical 50  $\Omega$  dielectric heating system [24].

is automatically tuned to maintain a fixed impedance of 50  $\Omega$  in the applicator's circuit to ensure that maximum coupling of energy is achieved.

The 50  $\Omega$  technology is fairly new compared to the class C self-excited oscillatory circuit system. An advantage of the 50  $\Omega$  technology is that it provides a fixed frequency compared to the free running oscillator circuit which contains several harmonics. The disadvantage of the 50  $\Omega$  technology is relatively high cost. But because of its compliance with stringent EMC regulations, the 50  $\Omega$  technology is gaining acceptance.

### 3.2.2 RF applicators

RF applicators of different types are used in industry to suit various applications, but the basic applicator design for commercial RF systems can be classified into one of four main configurations [23, 24, 26].

The through-field applicator, shown in Fig. 17a, is the most common RF system design used in RF heating. The electric field originates from a high frequency voltage. It is applied across two plate electrodes to form a parallel plate capacitor. The material is heated between the two plate electrodes.

The fringe-field applicator (also called stray-field electrodes), shown in Fig. 17b, consists of a series of electrodes in the shape of a bar, rod, or narrow plate that is alternatively connected to either side of the RF voltage supply. This applicator concentrates high energy density in a sheet material that passes over or under an array of electrodes.

The staggered through-field applicator (also called Garland electrodes), shown in Fig. 17c, consists of electrodes (rods or tubes) staggered on either side of a belt. This arrangement can transfer a high power in the order of 30–100 kW/m<sup>2</sup> to the material on the moving belt.

Tubular applicator has been specifically designed to heat liquid or other pumpable foods in the early 1980s. A typical RF tubular applicator is shown in Fig. 17d where

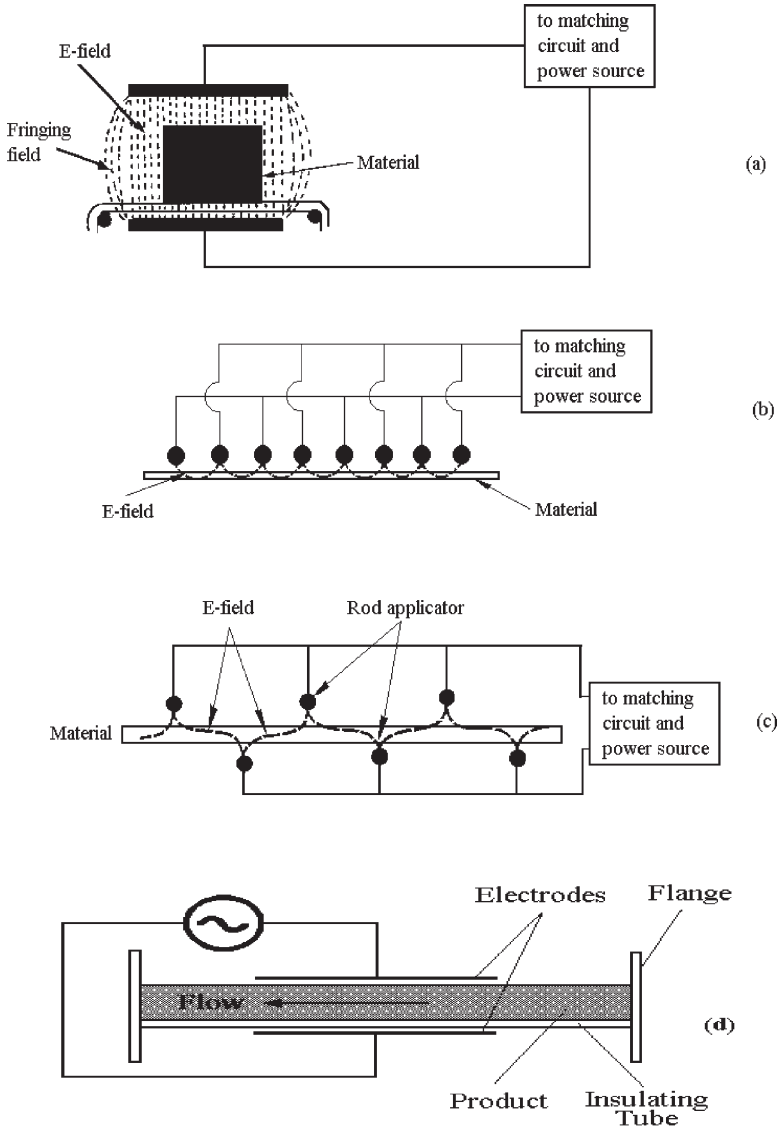

Figure 17: Electrode configurations for RF applicators: (a) through-field applicator; (b) fringe-field applicator; (c) stagger through-field applicator [26], and (d) tubular applicator.

foods are pumped through a plastic tube. RF energy is applied to the tube by a pair of curved electrodes. The tube can be placed vertically, horizontally, or inclined to an angle, depending on the need of applications.

Through-field applicators are often used to heat thick materials; fringe-field applicators are best suited for heating or drying thin layer (<10 mm) products, e.g. paper;

staggered through-field applicators are used for products of intermediate thickness; and tubular applicators are only suited for pumpable materials.

## 4 Review of research and industrial applications

### 4.1 Microwave sterilization

#### 4.1.1 Laboratory and pilot-scale microwave sterilization systems

Over the past four decades, several groups conducted research to advance industrial microwave sterilization processes. In the 1960s and early 1970s, US Army Natick Soldier Center (Natick, MA, USA) started experimental studies to develop a continuous microwave sterilization system for foods in flexible pouches [27, 28]. The pouches were heated on a conveyor belt inside a closed plastic pipe within a microwave multimode cavity equipped with a 10 kW generator operating at 2450 MHz. The pipe was pressurized with compressed air at ambient temperature to prevent the pouches from bursting. Each pouch was wrapped with insulating papers to prevent heat loss.

Results showed that the food suffered from severe edge-heating. The temperature spread between the edge and the center of beef slices ( $5.2 \times 14.6 \times 0.5 \text{ cm}^3$ ) was up to  $17^\circ\text{C}$  as measured by paper thermometers (having a sensitivity of  $\pm 5^\circ\text{C}$ ) after the product was heated to a minimum of  $120^\circ\text{C}$  [28]. The process time was not reported.

Research activities initiated by the US Army Natick Soldier Center were later moved to the US Department of Agriculture's Western Regional Center in Albany, CA, where a more sophisticated design was used. A cylindrical multimode microwave cavity operating at 2450 MHz served as the applicator, and pouches mounted on a rotating frame were treated in pressurized air space [29]. The air over-pressure between 40 and 45 psig maintained the food package integrity, but severe edge heating was still observed in the treated foods.

Strong interest in microwave sterilization of packaged foods was demonstrated by Alfa-Laval in Europe during the same period of time when the US Army Natick Soldier Center was studying using microwave energy as a new means to process high-quality shelf-stable military rations. But Stenstrom [30, 31] at Alfa-Laval (Tumba, Sweden) took a different approach from his counterparts in the USA by designing a microwave sterilization system in which packaged foods were immersed in water during heating with 2450 MHz microwaves. This method improved the control of edge and surface over-heating for some products, but was very complicated in design. Although product temperatures at various locations in selected foods were reported, the method of temperature measurement was not reported.

More research on microwave sterilization was conducted at the Swedish Institute for Food and Biotechnology (SIK) between the mid 1970s and late 1980s. Ohlsson [32] summarized the results of a research at SIK with a 2450 MHz pilot plant system developed by Alfa-Laval. This system was similar to that patented by Stenstrom, where packaged foods were heated in water in a pressurized microwave system. Thermocouple probes were used to monitor the temperature variation in



the pouches. When heated from 70°C to 130°C in 2.5 min, the maximum temperature variation for an 18-mm thick pouch of peas was  $\pm 3^\circ\text{C}$  (convection in the brine might have evened out the temperature). For meats and formulated foods, the temperature variation was  $\pm 6^\circ\text{C}$ .

#### 4.1.2 Food quality from early studies

Ohlsson [33, 34] compared the quality of packaged foods processed with a HTST microwave process and two conventional sterilization processes, all delivering  $F_0 = 6$ . The HTST microwave process (128°C final product temperature with 3 min cooking time) resulted in superior texture and nutritional value in vegetables compared to canning (120°C retort temperature and 45 min processing time) and retorting foil pouches (125°C retort temperature and 13 min cooking time). For example, the appearance and taste of microwave sterilized carrots after 6 months storage at 25°C were much better than those of carrots processed with canning or retorting, and superior or equal to their frozen counterparts. Studies by Stenstrom [31] and O'Meara [35] also showed that microwave processing produced better products than conventional sterilization processes.

#### 4.1.3 Limitation of earlier R&D activities

Several articles have commented on the limitations and challenges that faced early research on microwave sterilization [36, 37]. These include inherent nonuniform electromagnetic fields in multimode microwave cavities, lack of high-barrier plastic package materials that can stand sterilization temperatures, and lack of a reliable means to monitor product temperature. In addition, little is known about the dielectric properties of foods over the temperature range used in thermal processing.

Most early research and commercial activities reported to date used 2450 MHz microwaves. This frequency has the disadvantage of relatively shallow penetration depths, and can only process foods of limited thickness (2.4–4.5 cm for vegetables, 2.5–3.5 cm for meat and fish without salt, and 1.5–2.5 cm for salty foods) [34]. In addition, the multimode cavity design for 2450 MHz systems makes it difficult to predict the location of cold spots in packaged foods.

The 915 MHz frequency is used extensively in the food industry for tempering frozen meat and fish blocks and pasteurizing packaged foods because it penetrates deeper in foods compared to 2450 MHz microwaves, and thus may provide more uniform heating. Most importantly, the relatively longer wavelength at 915 MHz (33 cm in free space) compared to that of 2450 MHz (12 cm) makes it possible to design single-mode applicators with adequate size to treat foods in most single-meal packages. The single-mode cavity design is able to provide predictable field patterns in foods, a critical requirement for FDA approval of microwave sterilization systems for applications in the US food industry. This design concept has been used at the Washington State University (WSU) [4, 38, 39, 109].

#### 4.1.4 Commercial microwave sterilization operations

In spite of limited reports on microwave sterilization from research institutions, several commercial microwave sterilization systems can be found in the literature,





including those of OMAC and Berstorff systems [40, 41]. Currently microwave sterilization processes are used at Otsuka Chemical Company (Osaka, Japan) and TOP's Foods (Olen, Belgium). Products from these two companies demonstrated that microwave sterilized products containing pasta, rice, and vegetables have better organoleptic quality and appearance than frozen products because ice crystal formation in frozen foods reduces food texture.

In addition to new marketing opportunities, microwave sterilized products were found useful in emergency situations. For example, following the devastating earthquake in Kobe, Japan, in 1995, Otsuka Chemical Company shipped large quantities of their microwave-sterilized, shelf-stable meals to victims of the earthquake [41].

Tang [42] wrote an article in 2000 to describe the microwave sterilization and pasteurization processes at TOP's Foods in Belgium. The company developed its own microwave heating systems, operating at 2450 MHz to process meals in multicompartment polymeric trays. At the time Tang wrote that article, the TOP's microwave sterilization system produced 12 different sterilized meals with a shelf-life of one year at room temperature, and 14 different pasteurized meals with a shelf-life of 35 days at a recommended storage temperature of less than 7°C. The meals included Italian cuisine such as lasagna con spinaci, tagliatelle alla carne, spaghetti bolognese, and fettuccine tonno, and Chinese or Japanese meals such as chicken satay and tikka madras, each containing 375 g (sterilized) to 400 g (pasteurized) foods. The products were sold across Europe. The process line handled about 50–75 meals per minute, with only seven people per shift looking after the whole plant.

At the center of the TOP's plant was a four-step microwave sterilization/pasteurization system. The thermal processes were carried out in a semi-continuous mode in four different steps: (1) microwave and hot air heating with an over-pressure that increased gradually from 0 to 1 bar; (2) microwave and hot air heating with an over-pressure that increased from 1 to 2.5 bar; (3) holding under an over-pressure of 2.5 bar; and (4) cold-air cooling, also under an over-pressure. Over-pressure was used to balance the pressure generated by the heated meals in trays and prevent breaking the tray seals during the thermal process. The microwave system consisted of insulated multimode microwave tunnels made of metal ducts and equipped with automatic gates to separate each of the four process sections. Conveyor belts transported the meals into each cavity and move back and forth in each section so that the meals received more even microwave heating. Multiple magnetrons of 2450 MHz evenly distributed along the tunnels fed microwave power into the heating sections. Process times, microwave power, hot air, and cooling temperatures were recorded to monitor the process and detect possible deviations from established schedules. The product holding temperature was set at 121°C for the sterilization processes ( $F_0 = 10$  min) and 80°C for pasteurization processes. After cooling in a pressurized duct, the products were further cooled in a tunnel with blast cold air. The residence time of a product in a sterilization process is about 28 min: 14 min heating (in two separate microwave heating sections), 7 min holding, and 7 min cooling.



Prior to the microwave process, pieces of chicken/beef, sauce, and rice (or pasta) were filled into separate tray compartments at different temperatures to ensure a similar final temperature and a properly processed product. The microwave processes were checked regularly using wireless data tracers and maximum temperature indicators placed with the meals in selected trays. To ensure food safety, processed meals were taken from the process line at regular intervals and incubated at 37°C for seven days before release. Microbial loads of the raw materials and final products were regularly checked by microbial tests in specialized laboratories in Belgium and Italy. All sterilized foods were incubated for a certain period of time before being released to the market.

Since the report by Tang, TOP's Foods added a new microwave sterilization system that has tripled the company's production. The new system differs from that described above in that microwaves are directly delivered to each compartment of a multicomponent tray by individual magnetrons through specially designed applicators.

The USA does not have a commercial microwave sterilization process line because of (1) perceived unpredictability of heating patterns in microwave sterilization systems, and (2) lack of a reliable method to validate commercial microwave thermal processes to meet the food safety assurance requirements of the FDA for low-acid foods in hermetically sealed containers. Despite these limitations, interest from the food industry in microwave cooking/sterilization has been strong. For example, the Executive Advisory Panel for the *Food Engineering* magazine [43] forecasted microwave sterilization as one of the major manufacturing trends in the twenty-first century. The executives polled were individuals in top management of production, engineering, R&D, purchasing, packaging, and marketing. Among 10 emerging food processing technologies, microwave cooking/sterilization was rated as having high potential by the largest percentage of respondents (28.6%), followed by gamma radiation (22.6%).

## 4.2 Microwave pasteurization

Numerous research studies have been reported on the application of microwave energy to pasteurize packaged meals. These processes were designed to inactivate vegetative pathogen bacteria such as *Salmonella* and *Campylobacter* in early studies [44], but recent outbreaks of *Escherichia coli* and *Listeria monocytogenes* have spurred interest in process to inactivate additional bacteria. A process that heats a product to 80–85°C and maintains this temperature for a few minutes is generally regarded adequate [45].

Temperature uniformity is a major concern in studies on microwave pasteurization because too large a temperature variation may render a product unsafe. While most research has focused on 2450 MHz, a few studies used 915 MHz or 896 MHz (in the UK). Burfoot *et al.* [45] studied the heating uniformity of prepared meals when using 896 MHz or 2450 MHz microwave energy. They reported much better heating uniformity using a 896 MHz tunnel applicator than a 2450 MHz cavity.



The temperature distribution patterns for the two different frequencies were also totally different. For example, after 2.4 min heating in a 7 kW 896 MHz system, the corner temperature was lower than at the edge. For a mean temperature of 90°C in a packaged meal ( $14 \times 10 \times 2.2 \text{ cm}^3$ ), the standard deviations of six replicates were less than 6°C, with a maximum temperature difference of 17°C within a single product. In a 6 kW 2450 MHz pilot-scale system, temperatures at the corner and edge of the product were significantly higher than at the center, and the temperature differences within a single package in a pilot-scale tunnel were up to 36°C.

Because treatment temperatures are much lower in pasteurization than sterilization, microwave pasteurization systems (e.g. OMAC and Berstorff systems) are used commercially to pasteurize prepared meals, bread, pasta, and/or acidified products in the USA, Europe [46, 47], and Asia. In the USA, recent statutory requirement that mandates all ready-to-eat foods be pasteurized against potential pathogens will likely spur increased interest in using microwave pasteurization technology.

### 4.3 RF heating

#### 4.3.1 Commercial RF heating applications

RF heating systems are used in large-scale drying of textiles and papers, plastic welding, and curing the glue in plywood. The most successful application of RF heating in the food industry is postbaking drying of biscuits and crackers. In these operations, RF drying immediately follows baking to facilitate the removal of moisture at the center of the product. The unique moisture-leveling effect of RF heating helps to improve moisture uniformity and product quality and shorten the total time for a complete baking process by 50%. Today hundreds of RF postbaking systems operate in the bakery industry. RF energy is also used to defrost frozen poultry, reducing defrosting time from 4 days by conventional methods to a few hours, and in the meantime reducing drip loss and microbial contamination.

#### 4.3.2 Research on RF sterilization and pasteurization

Research has been conducted to extend the use of RF heating to pasteurization and sterilization of foods under the premise that RF energy can penetrate deep into foods and RF systems can provide simple and uniform field patterns, as opposed to the complex nonuniform standing wave patterns in multimode microwave ovens [48].

The earliest research on RF sterilization was reported by Pircon *et al.* [49], who developed a pressure-proof processing vessel (10 cm diameter, 60 cm height) to sterilize cured ground pork luncheon meat with RF energy. The vessel wall was a borosilicate glass tube sealed at the top and bottom with steel plates. A sample of 5.9 kg meat was heated by a 9 MHz RF unit with plate electrodes to an average temperature of 121.7°C in 4.8 min. The temperature along the center axis of the meat sample was relatively uniform ( $121.7 \pm 3.3^\circ\text{C}$ ), but varied as much as 28°C in the cross-section. Such nonuniform heating and problems encountered in designing high pressure-proof processing vessels for industrial-scale operation



have since presented major challenges to the research and commercialization of RF sterilization processes.

In a recent study, Starkweather [50] evaluated the use of RF to pasteurize chum salmon (*Oncorhynchus keta*) eggs (caviar) in bottle jars. Since caviars are sensitive to heat, low pasteurization temperatures were used to prevent protein denaturation which would cause change in product color and appearance. To prevent edge heating, a water immersion technique was used. In the experiments, glass jars containing 110 g of 3% salt eggs inoculated with  $10^7$  CFU/ml *Listeria innocua* (ATCC 51742) were sealed with a metal lid, immersed in water, and heated to 60°C in 10.3 min in a 27.12 MHz RF unit at 1 kW power. The center temperature of the containers was monitored with Nortech fiber optic temperature sensors. After RF heating, the jars were immediately removed and placed in a 60°C water bath and held for 34.5 min. This process completely eliminated the *L. innocua* in the treated products. A similar treatment using a 60°C circulating water bath to achieve the same kill of *L. innocua* in the bottled caviar would require 54.3 min heating and 34.5 min holding. RF-treated caviar also had better texture and color than that treated with water baths alone.

Zhong and Sandeep [51] and Zhong *et al.* [52] studied RF heating of liquid and particulate foods using a 30 kW RF system with a tubular applicator (14.6 cm diameter, 209.6 cm length) operating at 40.68 MHz. Tap water, 1% carboxymethylcellulose (CMC) solution, carrot cubes ( $2 \times 2 \times 2 \text{ cm}^3$ ) and potato cubes ( $2 \times 2 \times 2 \text{ cm}^3$ ) in 1% (w/w) CMC solution were heated in the RF unit. Temperature changes and variations were monitored with fiber optic sensors and infrared camera during and after RF heating, respectively. Tap water was heated from 25°C to 95°C in 10 min in a recycling batch mode with a fairly uniform temperature distribution at the applicator exit. Small variations of temperature (1–4°C) were observed within the carrot and potato cubes after 1.5–2 min RF heating and temperature rises between 20 and 40°C [51]. But for the viscous solution of 1% CMC, the liquid in the center of the applicator was 20°C higher than close to the wall. This can be beneficial for a continuous heating process because the residence time for the liquid in the center of the tube is shorter than that close to the wall. However, significant engineering efforts would be required to match the velocity profile of a liquid in a tube with that of an RF field pattern to provide uniform heating in a continuous in-tube process.

A pilot-scale pressurized RF system was developed at Washington State University (WSU) for studying RF pasteurization and sterilization of foods packaged in polymeric trays (Fig. 18). The system consists of a 6 kW 27.12 MHz RF power generator (COMBI 6-S; Strayfield Fastran, UK) and plate applicators. A pressurized vessel sandwiched between two plate electrodes provides an over-pressure of up to 40 psig and allows foods in large polymeric trays in the vessel to be heated up to 135°C without bursting.

The WSU pressurized vessel is made of four vertical polyetherimide (PEI) plastic walls with two parallel aluminum plates at the top and bottom. Provisions allow the insertion of fiber optic sensors into food packaging through sealed thermal wells. The pressurized vessel provides adequate space for circulating water to submerge



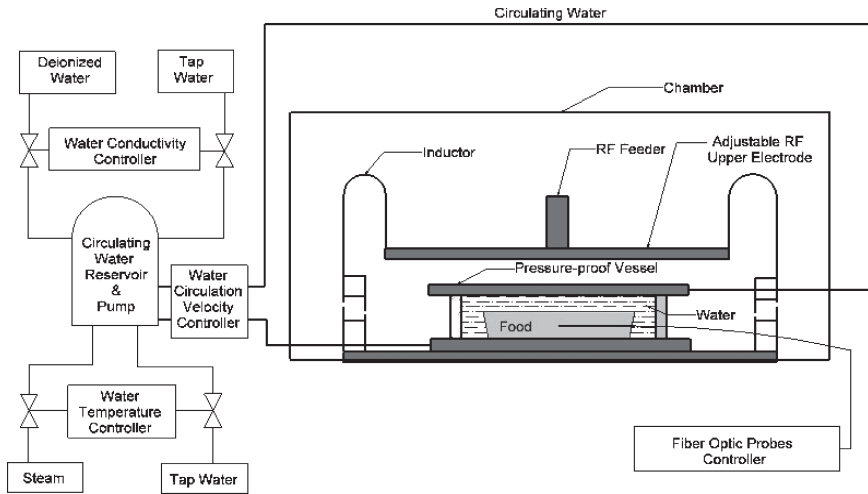

Figure 18: Simplified schematic diagram of WSU's RF sterilization unit with a water circulating system.

3 kg capacity or four 500 g trays of food packages to reduce corner and edge overheating. Over-pressure is supplied by an external compressed air system into a water circulation tank. Detailed information about this system is provided in Luechapattaporn [53].

The chemical maker (M-1) formed in a Maillard reaction was used to determine the cold spot in whey protein gels packaged in a 3 kg polymeric tray [5]. Fiber optical temperature sensors inserted to the cold spots during the RF sterilization processes were used to monitor and control the thermal process.

Figure 19 shows the temperature profiles for three locations in macaroni and cheese in a 3-kg capacity polymeric tray ( $24.5 \times 23.5 \times 4.5 \text{ cm}^3$ ) during RF sterilization and conventional retort processes. The polymeric trays were standard containers used for US Army shelf-stable group rations; they were sealed with a lid-stock containing aluminum foil as an oxygen barrier. In spite of the aluminum foil on top of the trays, the RF field was uniformly distributed through the thickness of the food, as demonstrated by the measured yield of M-1 (see [5] and also Section 5.1). For a similar lethality ( $F_0 \sim 8$ ) to *Clostridium botulinum* spores, the RF process took one-third the time required in a conventional retort process, and also significantly improved product quality [5].

Luechapattaporn [53] conducted microbial challenge studies for a thermal process based on the RF pilot-scale system developed at WSU. They used *Clostridium sporogenes* (PA 3679) as a surrogate for *C. botulinum* spores to validate the commercial lethality of RF sterilization procedures developed based on cold-spot temperature measurement for mashed potatoes. Before RF processing,  $10^7$  viable spores of *Clostridium sporogenes* (PA 3679) were inoculated in each of the 3-kg capacity trays. Results showed that measured microbial reduction caused by

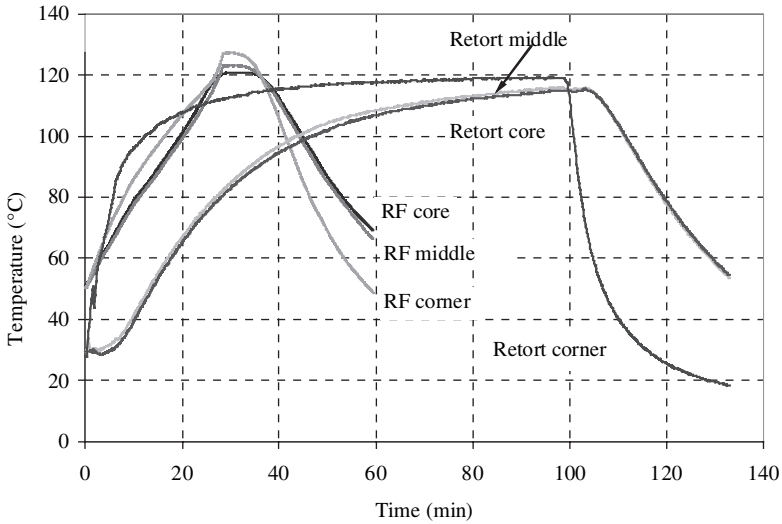

Figure 19: Time–temperature profile for macaroni and cheese (in a 3-kg capacity polymeric trays) thermally processed by RF and conventional retort methods [5].

RF processes agreed with calculated sterilization values (see Section 4.4.3) based on temperature–time history measured at cold spots.

#### 4.4 Bacterial considerations

##### 4.4.1 Nonthermal effects

Many researchers have tried to determine the so-called nonthermal microwave or RF effects on microorganisms. It is believed that the cell membrane may interact with microwave or RF radiation due to the existence of large potential gradients, cell surface charge densities, ion mobility, and structural water [54, 55]. Liburdy and co-workers [55, 56] suggested that exposure of membranes to microwave energy at 2450 MHz could alter the permeability of erythrocytes and phospholipid vesicles. Fisun [57] concluded from a theoretical study that the surface charge oscillations on a lipid layer might respond to alternating electric fields when exposed to electromagnetic radiation. A study reported by Ponne *et al.* [58] indicated that exposure of liposomes to RF fields of 27 and 100 MHz resulted in lyses of liposome vesicles. Barnes and Hu [59] concluded from a model study that both RF and microwaves may affect the shifts in ion concentrations across a membrane and orientation of long chain molecules.

Although many biochemical studies suggest possible membrane damage caused by RF and microwaves at sublethal temperatures, it is not conclusive if the damage is sufficient to cause nonthermal kill of microorganisms. In the same study in which Ponne *et al.* [58] demonstrated that RF fields caused possible cell damage to a model cell, they found that RF fields at sublethal temperatures did not cause a reduction

in population of *Erwinia carotovora* cells. In addition, when they used RF energy as a heat treatment, they detected no added effects other than thermal.

Khalil and Villota [60] reported membrane damage in the cells of *Staphylococcus aureus* FRI-100 after exposure to microwaves for 30 min at a sublethal temperature of 50°C. They hypothesized that these damages were caused by possible preferential heating of subcellular components such as membrane lipids. Sastry and Palaniappan [61], however, did heat transfer calculations and concluded that an extremely large surface-to-volume ratio of microorganisms makes it very unlikely for these organisms to be preferentially heated to lethal temperatures while foods are still at sublethal temperatures. They also found that a 1°C difference between a microorganism and its surrounding liquid would require 20–300 times the preferential energy generation in the organisms for practical microwave heating applications. Because of the much smaller dimensions of microorganisms compared with microwave wavelengths, such a high level of preferential heat generation in a microorganism is very unlikely.

While several reports, including Dessel *et al.* [62], Grecz *et al.* [63], Culkin and Fung [64], Wayland *et al.* [65], and Dreyfuss and Chipley [66], suggested nonthermal inactivation of microorganisms, other reports denied the nonthermal inactivation capability of RF and microwave radiation [67–70]. Welt *et al.* [71] listed four possible difficulties in early experiments as the main reasons for this controversy: (1) lack of reliable online temperature measurement methods (before the advent of fiber optic temperature sensors); (2) uneven (and often unpredictable) microwave or RF heating; (3) inability to control sample temperature; and (4) material losses due to evaporation. Rosen [72] and Heddleson and Doores [73] also attributed inaccurate temperature measurements, nonuniform and unpredictable heating pattern, and not using equivalent temperature–time treatments or poor temperature control as possible reasons for the observed ‘nonthermal’ effects in early studies.

Fung and Cunningham [74] emphasized the need to use the same temperature–time history to compare the effect of microwave and conventional methods. To address those problems, Welt *et al.* [71] developed a special microwave kinetic reactor (MWKR) apparatus to study the nonthermal effect of microwave energy on microorganism inactivation. The apparatus consisted of a 500-ml pressurized vessel placed in a 900 W 2450 MHz microwave cavity. A liquid sample in the vessel was agitated to ensure uniform exposure to microwave energy. The temperature of the sample was monitored by optical fiber temperature sensors and maintained at 90, 100, or 110°C ( $\pm 0.1^\circ\text{C}$ ) through a feedback loop to control microwave power. A similar system was developed that used an oil bath to provide the same time–temperature history. From these two sets of experiments, they detected no nonthermal effect of microwave energy in inactivating spores of *Clostridium sporogenes* (PA 3679).

Improper design of experimental systems may contribute to misleading results with regard to the nonthermal effects of microwave or RF energy. For example, Kozempel *et al.* [75] used a batch-type recycling flow system to study the nonthermal effect of microwave heating. The fluid passed through a microwave cavity while simultaneously cooled by tap water to maintain a sublethal temperature in



the bulk of the treated fluid. They observed a 3-log reduction of *Pediococcus sp.* in water, sugar solution, and apple juice at fluid temperatures between 20°C and 30°C, and attributed this to a possible nonthermal effect. In a later study [76], however, the authors made significant improvements to the test by changing the batch system into a continuous one to eliminate possible recontamination, and replaced the laminar flow with a turbulent flow to ensure a more uniform residence time of the treated samples. The treatment section was placed in a 7 kW 2450 MHz microwave cavity. Results indicated no detectable nonthermal effects from microwave energy for yeast, *Pediococcus sp.*, *E. coli*, *L. innocua*, and *Enterobacter aerogenes* in water, liquid egg, beer, apple juice, apple cider, and tomato juice at sublethal temperatures between 15°C and 45°C and after a dwell time of 2–7 min. Using the same flow system on a fluid sample with an RF applicator operating at 18 MHz and 0.5 kW/cm intensity, Geveke *et al.* [77] observed no nonthermal effect of RF energy on yeast, *E. coli* K-12, and *L. innocua* in apple cider, beer, liquid whole egg, and tomato juice at sublethal temperatures, nor any synergistic effects of RF energy with thermal energy at lethal temperatures.

Critical reviews of the nonthermal effects of microwaves on microorganisms can be found in Rosen [72], Heddleson and Doores [73], and Anon [78].

#### 4.4.2 Kinetics of inactivating microorganisms and targeted bacterium

Based on the above discussion, it appears that the literature still lacks convincing evidence to support the claim that nonthermal effects enhance microorganism inactivation at the frequencies and power intensity used in practical microwave or RF heating applications. A recent FDA report written by A.K. Datta and P.M. Davidson [78] concluded that ‘since the studies reporting non-thermal effects have been inconclusive, only thermal effects are presumed to exist. Thus, microbial inactivation kinetics for microwaves are essentially the same as the inactivation kinetics of conventional thermal processing.’

On the other hand, no food-borne pathogens or spoilage microorganisms appear to exist that are more resistant to microwave or RF heating than conventional heating when experiencing the same time–temperature history. Therefore, the food-borne pathogens or spoilage bacterium selected as target bacteria for conventional processes and surrogates in process validation can be used for developing microwave or RF sterilization and pasteurization processes.

#### 4.4.3 Process development and validation methods

Standard procedures for developing conventional thermal processes for packaged foods generally consist of four major steps: (1) conducting temperature distribution tests to determine the locations where food packages are least heated in a retort system; (2) performing heat penetration tests to determine the heat transfer characteristics at the least processed location (commonly referred to as the cold spot) in packaged foods located in the least heated place of a retort system. (3) conducting process calculations based on heat penetration data (temperature-time history from the cold spot) to determine the required operation time to ensure the desired level of sterility to a selected target bacterium (e.g. *C. botulinum*, in low-acid foods [pH >





4.6) at the coldest spots in packaged foods. The Ball's method, Stumbo's method, and Improved General Methods for estimating the lethality at the coldest location in a can for a given process were developed and refined over the years [79]; and (4) validating the process using a microbiological method (e.g. an inoculated pack study with a surrogate 3679 PA for canning operations). Detailed description of some or all of these steps is presented in several documents [80].

Similar steps can be followed to develop microwave or RF sterilization/pasteurization processes. Special attention, however, should be given to the unique features of microwave or RF systems with regard to the specific electromagnetic field distribution within each system and heating pattern for a given food package. For example, in microwave or RF heating, the coldest spots in packaged foods differ from that of conventional thermal processes. Their locations depend on many factors including the design of the applicators; frequency of microwave or RF; product shape, size, density, and dielectric properties. Once the coldest location in a package is determined, the improved general method can be used to calculate the needed lethality of the process to target bacterium [78]:

$$F = \int_0^t 10^{\frac{T(t)-T_{\text{ref}}}{z}} dt \quad (26)$$

where  $T(t)$  is the time–temperature history of the least heated location in a food. For sterilization, *C. botulinum* is the target bacterium,  $T_{\text{ref}}$  is taken as 121°C, and the  $z$  value is 10°C [79]. For pasteurization, the targeted bacteria may be vegetative pathogens, e.g. *L. monocytogenes*, and  $T_{\text{ref}}$  may be a selected temperature between 65°C and 80°C [81]. The formula methods, e.g. Ball's method or derivatives thereof, developed for thermal lethality delivered by conventional thermal processes, do not apply to microwave or RF process because of the fundamentally different means of delivering thermal energy to the cold spots.

As discussed earlier in Section 2.6, the dielectric properties of certain foods may change dramatically with temperature. As a result, the coldest location in a food package may shift in some microwave or RF heating systems [81]. Therefore, predicting the thermal lethality for those foods in microwave or RF processes may not be as straightforward as in conventional heating, and it is very important to conduct microbial validation tests after process calculation for each packaged product under a given process condition to ensure food safety. It is also advisable to provide an adequate safety margin in process operation procedures to allow for possible variations in product mass, composition, location of the treatment in a microwave or RF applicator, and initial product temperature, in spite of the fact that those parameters are often strictly controlled in industrial practices [42].

#### 4.5 Effect of microwaves on chemical reactions

The effect of microwave radiation on the nutritional components of foods has been reviewed by Rosen [72] and Cross and Fung [82], none of which were able to find convincing data to support nonthermal effects. Rosen [72] pointed out that the



quantum energy of microwaves ( $\sim 0.00001$  eV) and RF energy ( $\sim 0.0000001$  eV) is too low to break any chemical bonds and cause chemical changes, which would require at least 5.2 eV. Goldblith *et al.* [83] conducted experiments to study the effect of microwaves on thiamine (vitamin B<sub>1</sub>), and found only thermal destruction. Welt and Tong [84] used their microwave kinetics reactor to study such effects on thiamin degradation, and found no difference between microwave and conventional heating.

The kinetic data obtained to describe product degradation in foods during conventional thermal processes can also be used to evaluate the impact of microwave or RF processes. For example, the cook value C has been extensively used to compare effect of microwave sterilization processes on food quality to that of conventional thermal processes [33, 53]:

$$C = \int_0^t 10^{\frac{T(t)-100}{z}} dt \quad (27)$$

where  $T(t)$  is the time–temperature history and  $z$  represents quality changes, typically ranging from 16 to 34°C, depending upon the type of food and cooking criteria (e.g. taste, texture, or appearance) [85].

## 5 New developments in microwave and RF sterilization research

The three major developments that have significantly improved our ability to effectively research microwave and RF sterilization are (1) development of chemical marker methods to evaluate cumulative heating uniformity in foods, (2) the advancement of fiber optic sensors for accurate online temperature measurement, and (3) more advanced computer modeling with faster and cheaper computer resources.

### 5.1 Chemical marker methods

As discussed in Section 4.4.3, in order to design an effective thermal process that will ensure the commercial sterility of shelf-stable foods, it is essential to determine the least heated locations in packaged foods [86]. In conventional thermal processes using steam or pressurized heated water, heat is transferred from the container's surface to the food's interior via conduction in solid or semi-solid foods or convection in liquid foods. The least heated location in those containers is well defined, e.g. normally at the geometrical center in solid or semi-solid foods [81] or in the central axis at about one-third the height of canned liquid foods [87]. To ensure food safety, a single temperature probe is typically inserted at the least heated location to record time–temperature history which is then used to develop the thermal process schedule. However, in microwave or RF heating that relies on direct interaction with



food [11], temperature distribution depends on many factors, including applicator design, food geometry and composition, and the penetration depth and frequency of the waves, among others. That is, the heating pattern is product, process, and system dependent. Development of a thermal processing method based on microwave or RF energy therefore cannot rely on single or several temperature sensors to assess the 3-D heating patterns in packaged foods [88].

The complexity of measuring microwave and RF heating stimulated the development of a noninvasive chemical marker method [89], which allows an assessment of integrated time–temperature effects at any location in packaged foods [5, 38, 90, 91]. The US Army Natick Soldier Center identified three markers in various food systems as a result of thermal processing: 2,3-dihydro-3,5-dihydroxy-6-methyl-(4H)-pyran-4-one (M-1), 4-hydroxy-5-methyl-3(2H)-furanone (M-2), and 5-hydroxymethylfurfural (M-3) [90, 92]. Of these three markers, M-1 and M-2 are particularly useful. Marker M-1 is formed by a Maillard reaction between glucose and proteins, whereas marker M-2 is formed by Maillard reaction between ribose and proteins. Both reactions can take place at sterilization temperatures in low-acid foods ( $\text{pH} > 4.6$ ) containing amines and reduced sugars.

### 5.1.1 Mechanisms of M-1 and M-2 formations

At food sterilization temperatures ( $100\text{--}130^\circ\text{C}$ ), amino acids interact with glucose through a nonenzymatic browning reaction to form Amadori compounds, which then leads to the formation of an M-1 compound through 2,3-enolization at  $\text{pH} > 5$  [93, 94]. A summary of reaction pathways leading to the M-1 formation is shown in Fig. 20:

During a sterilization process, certain amino acids, particularly lysine, arginine, histidine, and methionine, also interact with ribose through Maillard

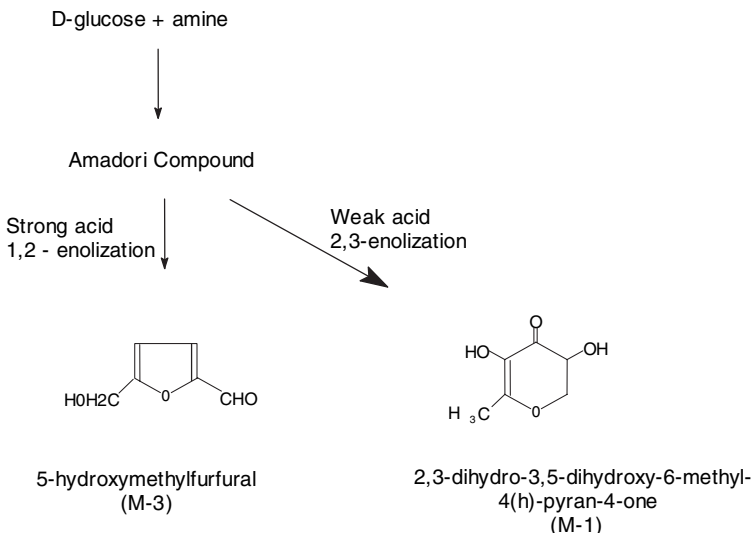

Figure 20: Summary of reaction pathways for the formation of M-1 [89].

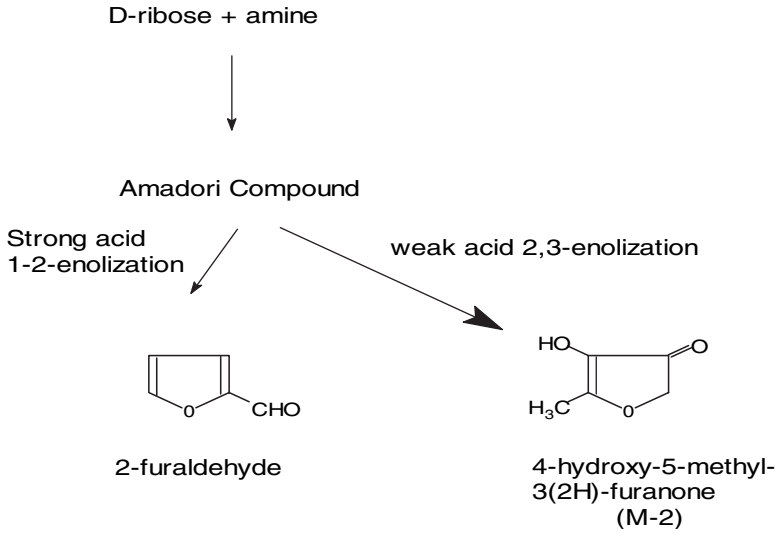

Figure 21: Summary of reaction pathways leading to the chemical marker M-2 formation [89].

(nonenzymatic browning) reactions to form Amadori compounds [95, 96]. At  $\text{pH} > 5$ , a 2,3-enolization of Amadori compounds leads to the formation of furanones (M-2 compound) (Fig. 21) [94, 97].

### 5.1.2 Kinetics of M-1 and M-2 formations

In addition to providing a qualitative evaluation of heating uniformity by detecting color changes in a uniform substrate such as whey protein gel, quantitative information on the concentration of chemical markers M-1 and M-2 can be used to more accurately assess the accumulative time-temperature effect within food systems, provided the kinetic information is known. Research at the US Army Natick Solder Center has shown that quantitative information of the concentrations of M-1 and M-2 in a substrate may lead to a fairly good estimation of *C. botulinum* reduction in a thermal process [98].

When using chemical marker methods, a small amount of marker precursor (about 2–10% glucose for M-1 and 0.5–1% ribose for M-2) is added to a protein-rich substrate such as ground beef [89], broccoli extract [90], or whey protein gel [99], so that the precursor is the limiting compound in the reaction of forming M-1 or M-2. Lau *et al.* [38] and Wang *et al.* [91] studied the kinetics of M-2 and M-1 formation, respectively, in whey protein gels heated in capillary tubes using oil baths, and determined that both marker formations follow a first-order reaction:

$$\frac{dM}{dt} = k(M_{\infty} - M) \quad (28)$$

Table 5: Rate constants  $k$  ( $\text{min}^{-1}$ ) and activation energy  $E_a$  (kcal/mol) for M-1 and M-2 formations.

Rate constant at temperature °C	M-1		M-2
	Whey protein gel <sup>1</sup>	Broccoli extract <sup>2</sup>	Whey protein gel <sup>3</sup>
$k_{116}$	0.0193	0.00584	0.110
$k_{121}$	0.0288	0.0151	0.152
$k_{126}$	0.0426	0.0329	0.207
$k_{131}$	0.0625	0.0540	0.281
$k_{\text{ref}} (T = 123.5^\circ\text{C})$	0.0351	0.0198	0.178
Activation energy (kcal/mol)	28.92	23.7	19.48

<sup>1</sup>Wang *et al.* [91].

<sup>2</sup>Kim and Taub [90].

<sup>3</sup>Lau *et al.* [38].

where  $M_\infty$  represents the maximum marker yield for a given sample. The rate constant  $k$  was related to temperature by an Arrhenius relationship:

$$k = k_{\text{ref}} e^{\left(-\frac{E_a}{R} \left[\frac{1}{T} - \frac{1}{T_{\text{ref}}}\right]\right)} \quad (29)$$

where  $k_{\text{ref}}$  is the rate constant at the reference temperature  $T_{\text{ref}}$  (K),  $E_a$  is the activation energy, and  $R$  is the universal gas constant, which is 1.987 cal/molK.

The first-order rate constants for M-1 formation in broccoli extract and 20% whey protein gel with 2% glucose and for M-2 formation in 20% whey protein gels with 1% ribose were determined by Kim and Taub [90], Lau *et al.* [38], and Wang *et al.* [91], respectively. They are presented in Table 5. It is clear from these data that M-1 formation is much slower than M-2 at any given temperature. In assessing heating patterns, M-2 is best suited for HTST microwave processes, whereas M-1 is more applicable to conventional thermal processes and RF processing of foods in large polymeric trays [5, 91].

### 5.1.3 Determination of chemical markers

The concentrations of M-1 or M-2 markers formed in food systems containing marker precursors such as glucose or ribose and amino acids can be determined on a high performance liquid chromatography (HPLC) system with a photodiode array detector (e.g. Hewlett-Packard 1040A, Plainsboro, NJ) and a solvent delivery system (e.g. ISCO model 2350). Using the above system and 10 mM  $\text{H}_2\text{SO}_4$  as the mobile phase at a flow rate of 1 ml/min, Kim and Taub [90] determined that M-2 had a maximum UV absorption at 285 nm and a retention time of 5.6 min, whereas the M-1 compound had a maximum UV absorption at 298 nm and retention time



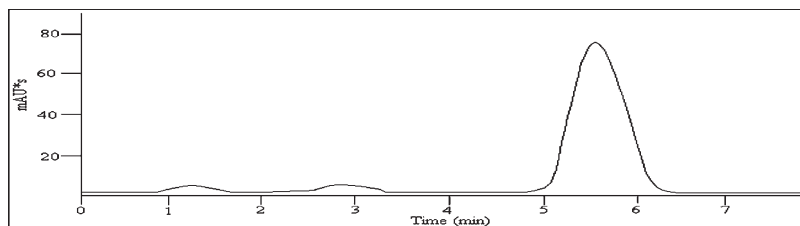

Figure 22: The chromatogram of M-2 formation at 285 nm from HPLC analysis [38].

of 4.2 min (Fig. 22). Detailed procedures to determine M-1 and M-2 yields can be found in Kim *et al.* [89], Kim and Taub [90], Lau *et al.* [38], and Wang *et al.* [91].

#### 5.1.4 Application of M-1 and M-2

Researchers have used M-1 and M-2 yields in model food systems as a temperature–time indicator to study the efficacy of aseptic processing and ohmic heating [89, 90, 100] and assess heating uniformity in microwave and RF sterilization processes [5, 38, 94, 99, 101]. For example, Kim *et al.* [89] used M-2 to study the heating uniformity produced by microwaves at 2450 MHz in ham samples as affected by salt content. Cylindrical ham samples (3 cm diameter, 6 cm tall) were prepared with 0.5%, 1.0%, 2.6%, and 3.5% salt and heated to 121°C in a pressurized container placed in a CEM microwave system (MDS-2000, CEM Corporation, Matthews, NC). At 0.5% salt content, higher M-2 marker yield was obtained in the core than the outer ring, suggesting significant focusing of microwave energy at the core. At 1.0% salt concentration, no detectable difference was observed in M-2 yield between the inner and outer ring of the sample, indicating a uniform heating, while at 2.6 and 3.5 salt concentrations, the outer ring had a much higher M-2 yield than the core, showing a shallow penetration of microwave energy. The heating patterns indicated by M-2 yields correlated with those directly measured with temperature probes in Mudgett [1]. The study reported in Kim *et al.* [89] clearly indicated that marker yields can be used to evaluate the heating pattern in microwave-heated solid food.

A drawback in using foods as the substrates for the chemical marker technique is the possible inconsistency in food composition that may lead to large variations in marker yields even if the heating is uniform. A different approach is to develop a consistent substrate for M-1 and M-2 determination. Concentration of marker yields in uniform substrates may be used for one or two purposes: (1) assessing heating uniformity during microwave or RF processing and locating the least heated locations; and (2) serving as indirect indicators of the lethality of a thermal process.

Whey protein gels as a consistent substrate were used as model foods to study microwave or RF heating [91, 99]. In [99] whey protein gel (20% whey protein concentrates) containing ribose was heated in a pressurized Teflon vessel in a 2450 MHz microwave oven to 121°C. After microwave heating, the gel samples were cored

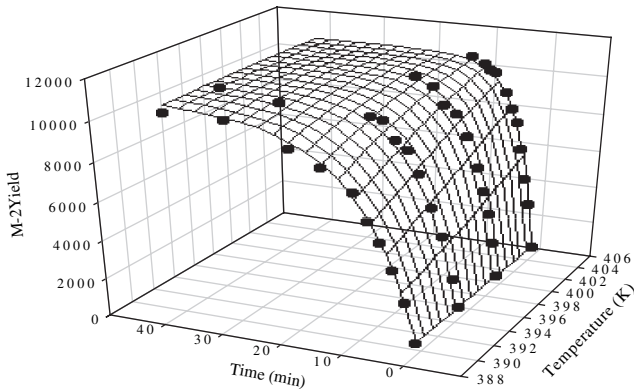

Figure 23: Increase in M-2 yield as a function of heating time at four different temperatures [38].

from different locations for marker analysis. The marker yields from different gel sections were used to compare with the destruction of *Bacillus stearothermophilus* spores in alginate beads imbedded in the whey protein gel samples. Again, the M-2 marker yields correlated with the destruction of *B. stearothermophilus* spores.

More recently, Pandit *et al.* [101, 102] used M-2 marker in combination with computer imaging method to locate cold spots in whey protein gels during microwave sterilization. Studies at WSU [101] indicate that the chemical marker method can be used to locate the least heated location in foods system. After locating the least heated part in the packaged foods, fiber optic temperature sensors can then be used to determine the time–temperature history of the least processed location to develop a microwave or RF sterilization process that provides the desired sterility, much like the procedure to determine conventional thermal processes.

In using chemical markers, it is essential that their concentration be in the approximately linear range of the kinetic curve (e.g. <70% of maximum yield in Fig. 23) to ensure a detectable increase in marker yield with increased process time. The marker yield becomes a less reliable indicator of heating intensity when it approaches maximum value (Fig. 23).

## 5.2 Fiber optic sensors

Temperature measurements are necessary for process development, control, and validation in microwave sterilization or pasteurization. Conventional temperature sensors based on thermoelectric effects (e.g. thermocouples, RTD, and thermistors) distort the electromagnetic field in the vicinity of the probes and give erroneous readings. Fiber optic sensors, however, do not interact with electromagnetic energy and are, therefore, now commonly used in microwave/RF research [103, 104].

Fiber optic temperature sensors provide comparable accuracy to thermocouples in a normal heating medium. The probe sizes of fiber optic sensors are generally

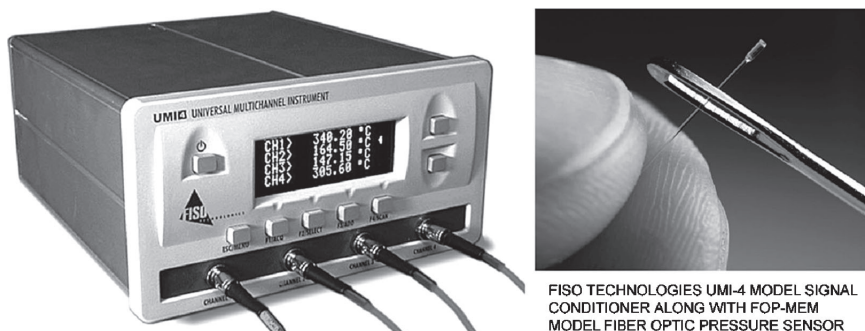

Figure 24: A four-channel FISO temperature measurement system (courtesy of FISO Technologies, Inc.).

small (e.g. 0.3 mm in diameter for sensors made by FISO Technologies, Inc., Quebec, QC, Canada, Fig. 24). The response times of those sensors varied between 0.05 and 2 s in water, making them well suited for relatively fast microwave or RF heating.

Fiber optic sensors have been used extensively to monitor temperature and pressure changes during HTST microwave and RF sterilization processes [4, 5, 53]. The US Food Products Association is soliciting FDA approval of electronic temperature sensors, including fiber optic sensors, as the principal means to monitor conventional and novel thermal processes in industrial operations.

### 5.2.1 Principles of fiber optic temperature sensors

Commercial fiber optic temperature sensors are developed based on one of the following three methods: fluorescence decay time, Fabry-Pérot interferometer (FPI), and transmission spectrum shift in semiconductor crystals.

**5.2.1.1 Fluorescence decay time** This technique is used by Luxtron (Santa Clara, CA) [105] and Ipitek (Carlsbad, CA). In the Luxtron system, the fluoroptic thermometry relies on the use of phosphor (magnesium fluorogermanate activated with tetravalent manganese) as the sensing element. This material fluoresces to deep red when excited with ultraviolet or blueviolet radiation. The decay time of the afterglow (to 1/e of the original strength) of this material varies with temperature (e.g. 5 ms at  $-200^{\circ}\text{C}$  and 0.5 ms at  $450^{\circ}\text{C}$ ). Measuring the rate of afterglow decay allows an indirect determination of temperature. In Luxtron's temperature probe, a phosphor is attached to the tip of a silica fiber connected to a light source. During the measurement, light is sent from an LED through the silica fiber to the tip, causing the phosphor to glow. The red fluorescence is returned by the same fiber to a detecting device. The decay of the afterglow is measured electronically, allowing a phosphor temperature determination typically to a precision of  $0.1\text{--}0.2^{\circ}\text{C}$ .

**5.2.1.2 Fabry-Pérot interferometer** Two companies, FISO Technologies (Quebec, QC, Canada) and Photonetics (Peabody, MA, USA, ceased operation in 2002),





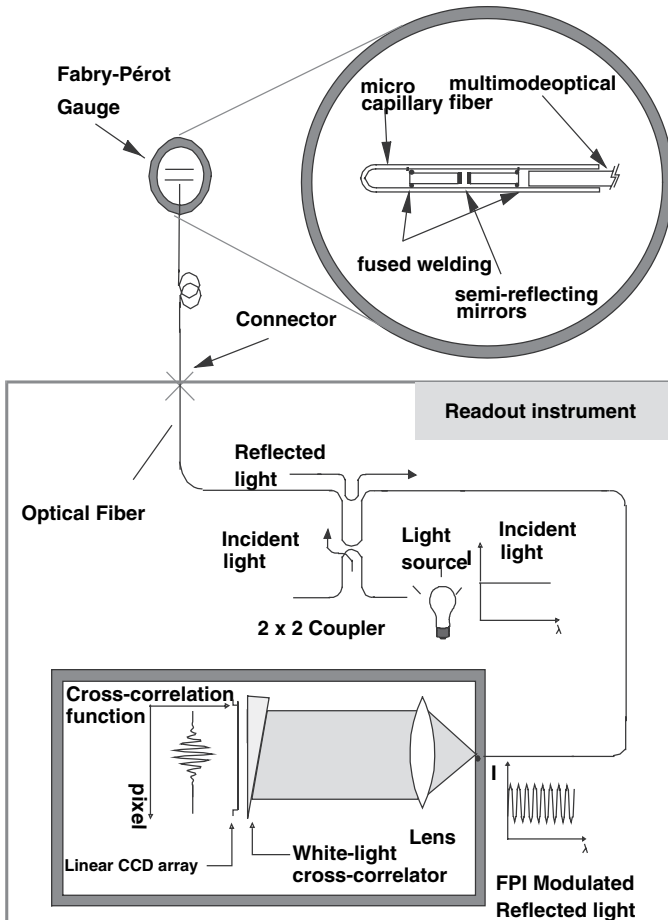

Figure 25: Schematics showing the principles of FPI for the FISO system (courtesy of FISO Technologies).

developed their temperature and pressure sensors based on the interferometer. The FPI, which is permanently attached to the tip of an optical fiber, consists of two parallel reflective surfaces that form a cavity resonator (Fig. 25). The space separating these two surfaces, also called the FPI cavity depth (1–2 wavelengths deep), varies with temperature. Alternatively, a film with a refractive index that is highly dependent on temperature is used (e.g. in Photonetics sensors) instead of a space (e.g. in FISO’s sensors) in the resonator. A change in temperature alters the optical length (refractive index multiplied by cavity depth) of this resonator, even though the actual physical thickness of the film does not go through measurable changes. When used in microwave or RF processes, changes in the FPI cavity path or optical path length of the light resonators are measured to determine the temperature of the sensing element [104].

**5.2.1.3 Transmission spectrum shift in semiconductor crystal** Nortech (Quebec, QC, Canada) developed their temperature measurement sensors using the temperature-dependent light absorption/transmission characteristics of a semiconductor gallium arsenide (or GaAs). A unique feature of this crystal is that when temperature increases, the crystal's transmission spectrum shifts to a higher wavelength. Measuring the position of the absorption shift also measures the temperature of the sensing element. While Nortech ceased to provide temperature sensors in 2002, this technology is now manufactured and marketed by Neoptix, Inc. (Quebec, QC, Canada).

Because microwave and RF heating are fast, it is critical that sensor response time is small enough to accurately follow rapid temperature changes in microwave or RF sterilization operations. The following relationship provides information to assess if a temperature sensor has an adequately short response time for a rapid heating process, assuming a linear ramping temperature change [105]:

$$\tau = \frac{\Delta T}{\dot{T}} \quad (30)$$

where  $\tau$  is the thermal response time of the sensor in the measured product, is maximum allowable temperature lag, and  $\dot{T}$  represents heating rates.

In conventional thermal processes, it is desirable to limit temperature measurement errors to less than  $0.5^{\circ}\text{C}$ . In the microwave sterilization processes reported by Ohlsson [2] and Guan *et al.* [3], the heating rate was  $1^{\circ}\text{C/s}$  and  $0.33^{\circ}\text{C/s}$ , respectively. Based on eqn (30), the response time of the fiber optic sensors should be less than 0.5 and 1.67 s, respectively, in order to limit the measurement error due to thermal lag to less than  $0.5^{\circ}\text{C}$  for the above two microwave sterilization processes.

### 5.3 Computer simulation

Computer simulation should play a key role in future design of microwave and RF heating systems. Issues such as improving heating uniformity and maximum power coupling into applicators can be addressed once the model is validated with experiment. The parameters of interest when modeling an RF or microwave heating system are electric fields, power density, and temperature.

Without a computer modeling tool, experienced manufacturers have to rely on intuition and experiences to build a system to meet their customers' needs. During experimentation, time and money is wasted in troubleshooting and modifying systems that do not meet the design requirements. Although using a computer to reach a targeted requirement is faster than conducting actual experiments, one must be cautious that the model first be validated. Without firm proof of the model's accuracy, the model will give erroneous results which render the design process irrelevant.

Among the various modeling techniques such as the finite element method (FEM), finite difference time domain (FDTD), method of moments (MoM), transmission line matrix (TLM), etc., to model RF and microwave heating systems, the FDTD and FEM methods seem to be the most widely used. The FEM and FDTD



methods are based on the solution of Maxwell's equations in their differential form (PDE techniques). Commercially available software can implement the various numerical techniques involved with these methods, but inhouse software is gaining importance because it can continuously be modified, whereas commercial software does not allow such flexibility.

Since simulation is a complex topic in its own right, the following sections will only briefly touch on the FEM and FDTD methods. Interested readers should refer to Taflovie [106] and Sadiku [107] for detailed descriptions of the various numerical methods used to simulate electromagnetic fields. An overview of commercial software packages implementing the different numerical methods can be found in Datta [108].

### 5.3.1 Finite element method (FEM)

The FEM was first formulated in the 1940s for use in electromagnetics. Its performance has been improved over the years, especially with the introduction of edge elements. The FEM is now a very versatile method and can handle problems with complex geometries. It is computationally efficient because it yields sparse matrices, and it has been used in a wide variety of microwave problems such as waveguides, transmission lines, and microwave heating cavities.

The FEM normally involves a few steps. First the domain concerned, i.e. the model, is discretized into subregions referred to as finite elements. The elements used depend on whether the shape is a 1-D, 2-D, or 3-D (see Fig. 26). In the case of a 3-D model, the elements could be hexagonal or tetrahedral in shape. Figure 27 shows a waveguide discretized with tetrahedral elements.

The numerical expressions for each element are derived from the Maxwell's equations and boundary and or initial conditions imposed. The elements are then assembled and the resulting systems of numerical equations solved. Depending on

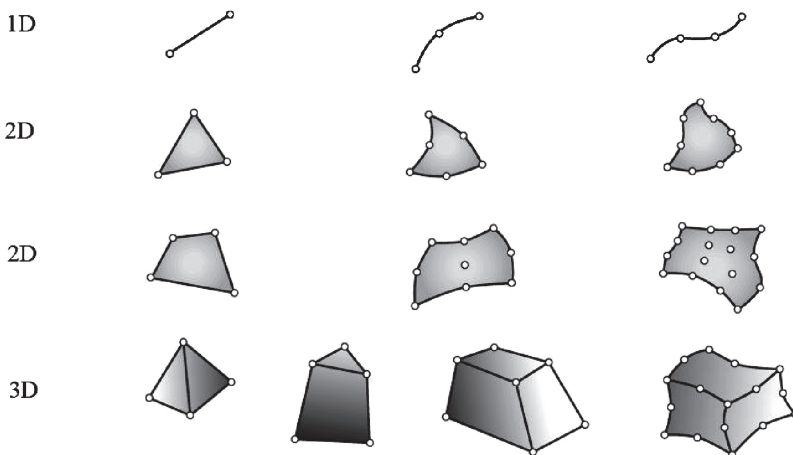

Figure 26: Elements used for 1-D, 2-D, and 3-D shapes.

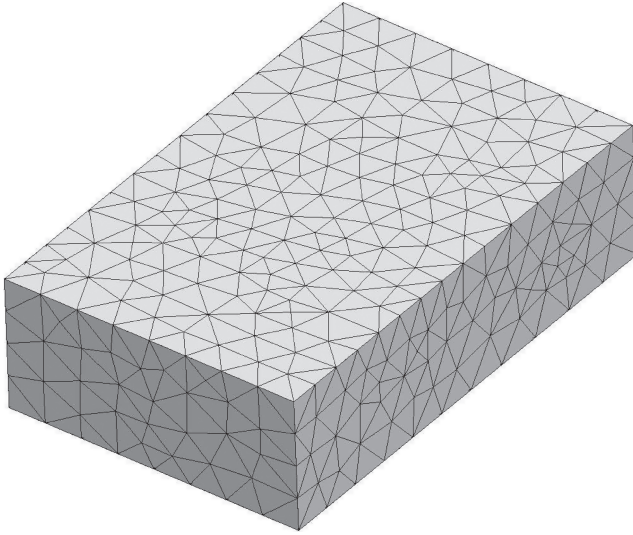

Figure 27: Waveguide meshed with tetrahedral elements.

the size of the model, this is a very time-consuming process that cannot typically be achieved on a PC due to the size of a typical microwave or RF cavity; extensive computer resources on a workstation will likely be required.

### 5.3.2 Finite Difference Time Domain Method (FDTD)

In contrast to FEM, the FDTD is a time-domain technique, gives it an advantage in that it can cover a wide frequency range with a single simulation run. Generally, FDTD can be run on a PC without the rigorous computer requirements for FEM.

The FDTD method was first proposed by Yee in 1966. It is a simple and elegant way to discretize the differential form of Maxwell's equations. Yee used an electric field grid offset both in space and time from a magnetic field grid to obtain updated equations that yielded the present fields throughout the computational domain, i.e. a microwave cavity, in terms of the past fields (Fig. 28). The update equations are used in a leap-frog scheme to incrementally march the electric and magnetic fields forward in time. In other words, the electric field is solved at a given instant in time, then the magnetic field is solved at the next instant in time, and the process is repeated over and over again until a steady state condition is reached. WSU has successfully used a 3-D FDTD package, Quickwave-3D (QWED, Warsaw, Poland) to develop a single-mode 915 MHz sterilization system for packaged foods [39, 109].

### 5.3.3 Microwave heating modeling

**5.3.3.1 Multimode cavity** The two most common types of cavities used for heating are multimode and single mode. Although a multimode cavity can theoretically

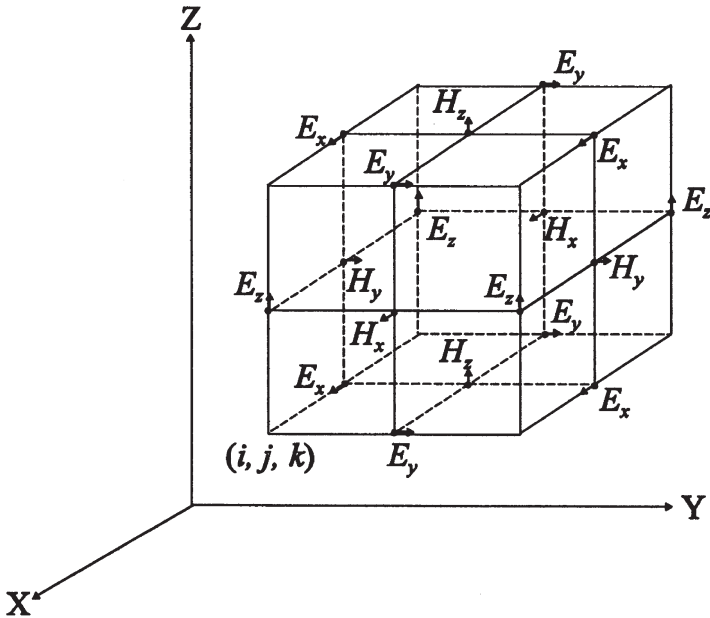

Figure 28: Standard Yee cell.

provide better heating uniformity because of the relatively large number of modes within the spectrum of the magnetron, modeling such systems does present a challenge. Numerous attempts in the past to design a multimode system based on empty cavity modes revealed that hybrid modes are created with the addition of a load, which make the system unreliable [22]. These hybrid mode patterns are remotely related to empty cavity modes, as can be seen in Figs 29 and 30. Besides the difference in patterns, the modal resonant frequencies of an empty multimode cavity are different from that of a loaded cavity, as one would expect.

**5.3.3.2 Single-mode cavity** Unlike the multimode cavity, a single-mode cavity has a fairly defined pattern. Having a predictable pattern enables the researcher to achieve optimum placement of a load for uniform heating. The two widely used systems are represented by the shorted rectangular waveguide sustaining a  $TE_{10}$  (see Fig. 10) and the cylindrical  $TM_{010}$  cavity mode. Figure 31 shows a  $TE_{102}$  mode with two heating spots. Figure 32 shows a  $TM_{010}$  cylindrical cavity, indicative of a single mode that has a uniform field distribution along the cylinder axis.

### 5.3.4 RF heating modeling

According to Neophytou and Metaxas [110], the modeling of RF heating systems has not received the same attention as its corresponding microwave heating systems, even though the latter only represent 10% of the total market of dielectric heating systems.

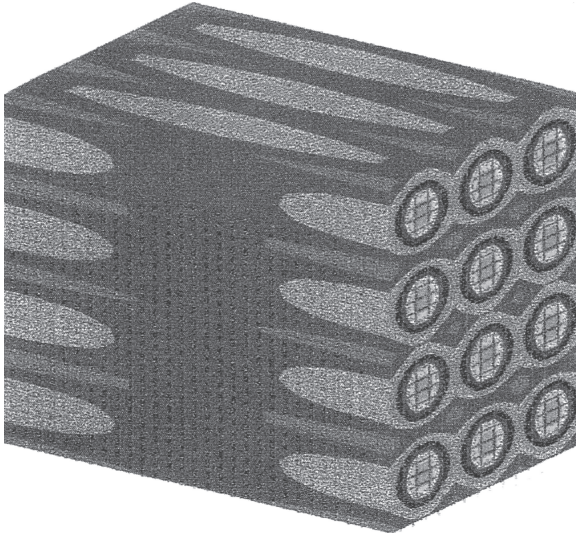

Figure 29: Example of a mode in an empty multimode cavity. Notice the well-defined pattern [22].

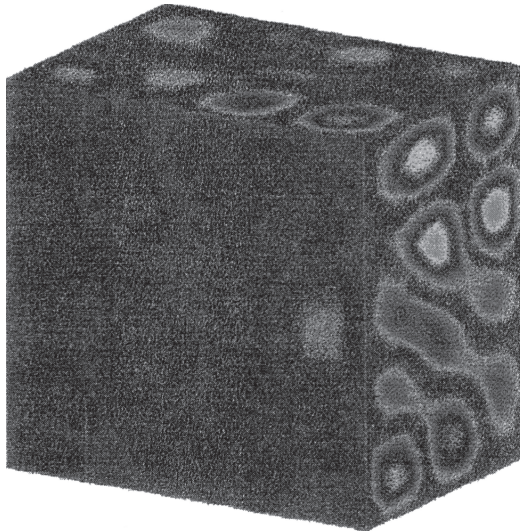

Figure 30: Example of a hybrid mode in a loaded multimode cavity with no defined patterns. Pattern is determined by load size, location, shape, etc. [22].

Most of the work done in the past decade or so in simulating RF heating systems was based on the assumption of quasielectrostatic conditions because the wavelengths are large (in the order of meters, refer to Table 1) compared to the applicator cavity size which is only a fraction of a wavelength. The Laplace equation has

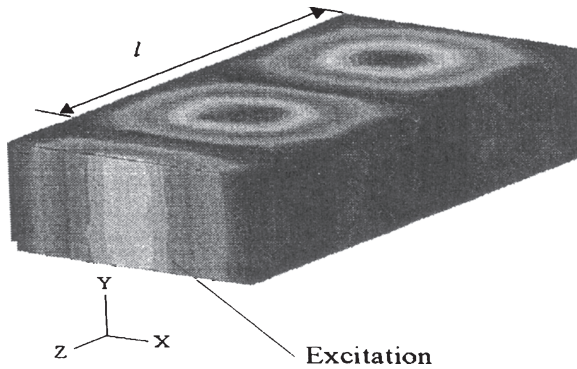

Figure 31:  $TE_{102}$  mode in a single-mode cavity [22].

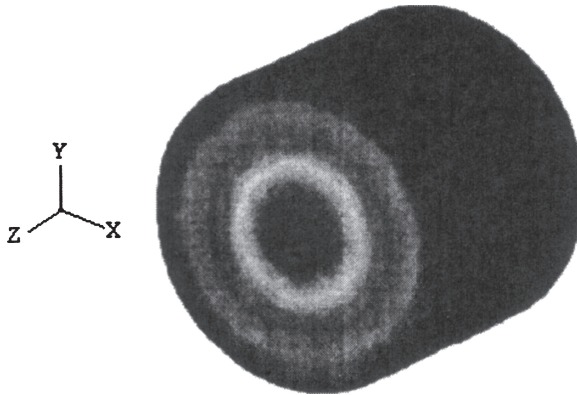

Figure 32: Single mode in a cylindrical shape cavity [22].

been used to calculate the electromagnetic fields within an applicator, which was modeled independently of the generator unit by using simplified 1-D or 2-D models.

Neophytou and Metaxas [110] have found limitations in the modeling of RF systems by simply testing the method on 1-D or 2-D models. They also found that the quasiolestatic assumption applies to very small-sized applicators, and accurate prediction of an RF heating model can only be obtained by using the wave equation in three dimensions of the model and taking the generator circuit into account, as shown in Figure 33.

Successful modeling of RF heating using a 3-D FEM package has been conducted at WSU [111]. Figure 33 shows a 3-D view of a 6 kW industrial RF heating system manufactured by Strayfield Ltd. (Theale, Berkshire, UK). The left section is the generator and the right section is the applicator where the load is placed for processing. The applicator consists of two plates with one plate fixed (ground) and the other movable for proper tuning of the system, normally referred to as a throughfield applicator. Figure 34 shows good agreement between the measured

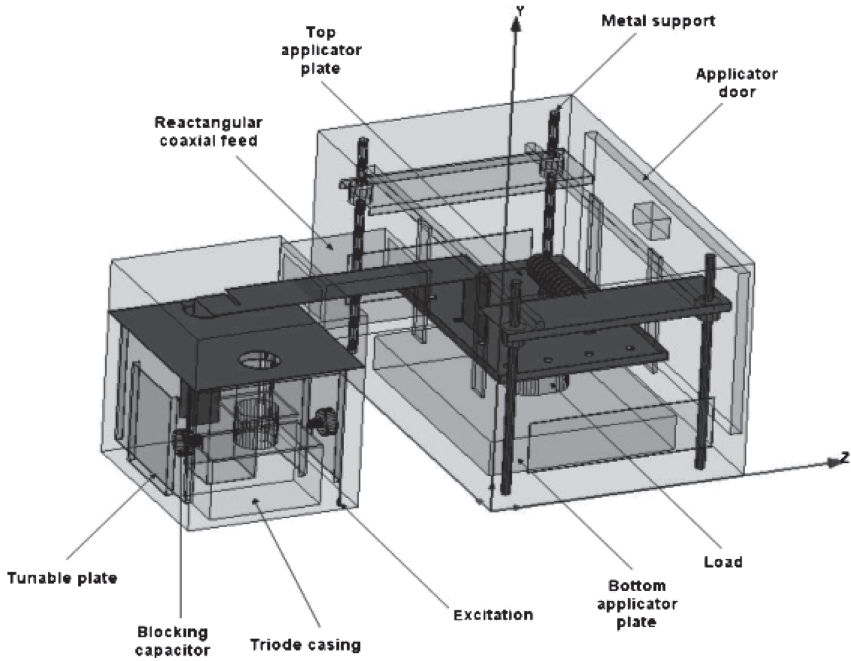

Figure 33: 3-D view of tank and applicator sections [110].

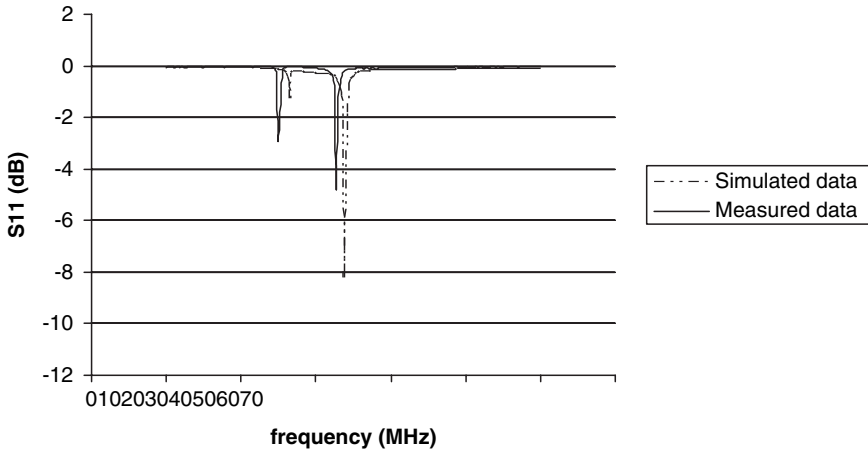

Figure 34: Measured and simulated comparison of an RF heating system’s S11 parameter [111].

and simulated S11 system parameter. Figure 35 shows a comparison of the resulting heating patterns using 1% CMC as the load. Once the model is successfully validated, it is then possible to study and understand the complex interaction between the RF field and the load.



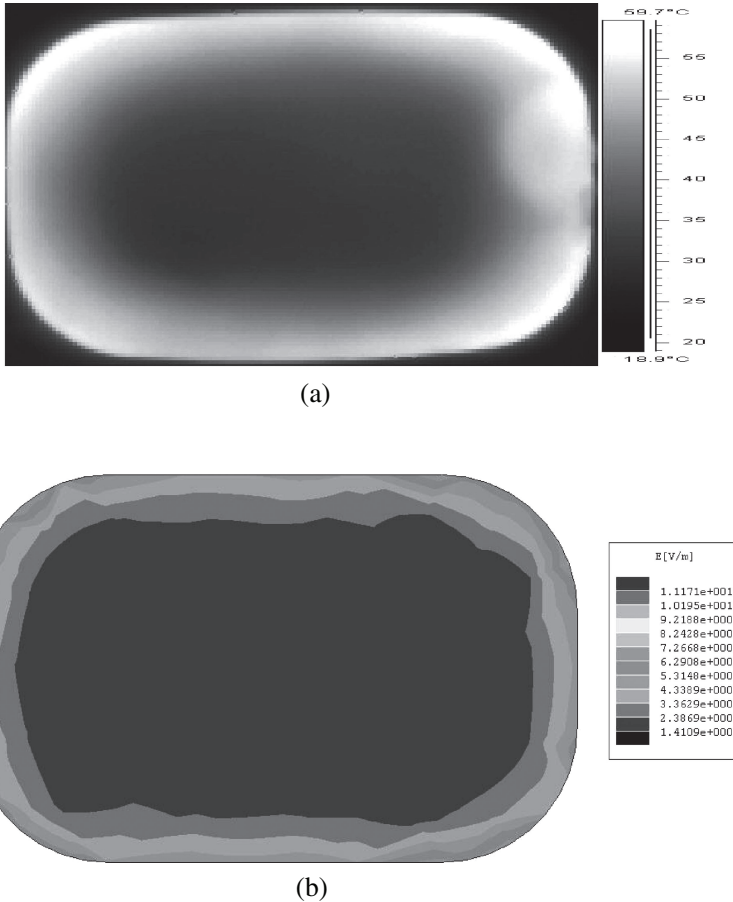

Figure 35: Measured temperature of (a) a 1% CMC solution in an oval container at the center of an RF applicator, and (b) a simulated electric field of the 1% CMC solution in an oval container at the applicator center [111].

### Nomenclature

- C** cook value (time in min at 100°C)
- E** electric field strength (vector)
- E** electric field (V/m)
- $E_a$  activation energy (cal/mole)
- F** thermal lethality for a selected bacteria, in min
- H** magnetic field strength (vector)
- M** chemical marker yield (mg/g)
- $M_\infty$  chemical marker yield at saturation (mg/g)
- $P_V$  power conversion per unit volume ( $W/m^3$ )
- $P_O$  incident wave power at a surface ( $W/m^3$ )



$P(z)$	power at distance $z$ in the direction of wave propagation ( $\text{W/m}^3$ )
$R$	universal gas constant (1.987 cal/mol K)
$\dot{T}$	heating rate (K/s)
$f$	frequency (Hz)
$k$	rate constant
$k_{\text{ref}}$	rate constant at the reference temperature $T_{\text{ref}}$ (K)
$u$	wave speed (m/s)
$u_0$	wave speed in free space ( $3 \times 10^8$ m/s)
$\alpha$	attenuation factor
$\beta$	phase constant
$\gamma$	propagation constant
$\tau$	thermal response time (s)
$\mu$	permeability (H/m)
$\mu_0$	permeability of free space ( $4\pi \times 10^{-7}$ H/m)
$\eta$	intrinsic impedence ( $\Omega$ )
$\eta_0$	intrinsic impedence of free space (377 $\Omega$ )
$\psi$	angle of refraction
$\phi$	angle of incidence
$\theta$	phase angle
$\rho$	reflected index
$\lambda$	wavelength (m)
$\varepsilon_r$	complex relative dielectric constant
$\varepsilon'$	relative dielectric constant (relative to that of air)
$\varepsilon''$	relative dielectric loss factor
$\varepsilon_0$	permittivity of free space ( $10^{-9}/36\pi$ F/m)
$\delta$	dielectric loss angle ( $\tan \delta = \varepsilon''/\varepsilon'$ )
$j$	$\sqrt{-1}$
$\omega$	angular frequency

### Subscripts

eff	effective
d	contribution of dipole ratio to dielectric properties
$\sigma$	contribution of ionic conductivity to dielectric properties

### References

- [1] Mudgett, R.E., Microwave properties of foods in microwave processing. *Food Technol.*, **36(6)**, pp. 109–115, 1986.
- [2] Ohlsson, T., Sterilization of food by microwaves. Paper presented at the International Seminar on New Trends in Aseptic Processing and Packaging of Foodstuffs, Munich, Oct. 22–23, 1987, SIK (the Swedish Institute for Food and Biotechnology), Report No. 564, 1989.
- [3] Guan, D., Gray, P., Kang, D.-H., Tang, J., Shafer, B., Ito, K., Younce, F. & Yang, T.C.S., Microbiological validation of microwave-circulated water



- combination heating technology by inoculated pack studies. *J. Food Sci.*, **68(4)**, pp. 1428–1432, 2003.
- [4] Guan, D., Plotka, V.C.F., Clark, S. & Tang, J., Sensory evaluation of microwave treated macaroni and cheese. *J. Food Processing and Preservation*, **26**, pp. 307–322, 2002.
- [5] Wang, Y., Wig, T., Tang, J. & Hallberg, L.M., Sterilization of foodstuffs using radio frequency heating. *J. Food Sci.*, **68(2)**, pp. 539–544, 2003.
- [6] Buffler, C.R., *Microwave Cooking and Processing*, Van Nostrand Reinhold: New York, 1993.
- [7] Goldblith, S.A. & Wang, D.I.C., Effect of microwaves on *Escherichia coli* and *Bacillus subtilis*. *Appl. Microbiol.*, **15**, pp. 1371–1375, 1968.
- [8] Metaxas, A.C. & Meredith, R.J., *Industrial Microwave Heating*, Peter Peregrinus: London, UK, 1993.
- [9] Kuang, W. & Nelson, S.O., Low frequency dielectric properties of biological tissues: A review with some new insights. *Trans. ASAE*, **41(1)**, pp. 173–184, 1998.
- [10] Tang, J., Feng, H. & Lau, M., Microwave heating in food processing, in *Advances in Bioprocessing Engineering*, ed. X. Young, & J. Tang, World Scientific Publisher, New Jersey, pp. 1–43, 2002.
- [11] Decareau, R.V., *Microwaves in the Food Processing Industry*, Academic Press: New York, 1985.
- [12] Sadiku, M.N.O., *Elements of Electromagnetics*, 2nd edition. Oxford University Press: New York, 1995.
- [13] Metaxas, A.C., *Foundations of Electroheat – A Unified Approach*. John Wiley & Sons: New York, 1996.
- [14] Lu, L., Tang, J. & Liang, L., Moisture distribution in spherical foods in microwave drying. *Drying Tech.*, **16(3)**, pp. 503–524, 1998.
- [15] Skilling, H.H., *Fundamentals of Electric Waves*, 2nd edition. John Wiley & Sons: New York, pp. 159–245, 1948.
- [16] Ayappa, K.G., Davis, H.T., Crapiste, G., Davis, E.A. & Gordon, J., Microwave heating, an evaluation of power formulations. *Chem. Eng. Sci.*, **46(4)**, pp. 1005–1016, 1991.
- [17] Tang, J., Wang, Y. & Chow Ting Chan, T.V., Radio frequency heating in food processing, in *Novel Food Processing Technologies*, ed. G.V. Barbosa-Canavas, M.S. Tapia & M.P. Cano, CRC Press, New York, pp. 501–524, 2005.
- [18] Guan, D., Cheng, M., Wang, Y. & Tang, J., Dielectric properties of mashed potatoes relevant to microwave and radio-frequency pasteurization and sterilization processes. *J. Food Sci.*, **69(1)**, pp. 30–37, 2004.
- [19] Wang, Y., Wig, T., Tang, J. & Hallberg, L.M., Dielectric properties of food relevant to RF and microwave pasteurization and sterilization. *J. Food Eng.* **57(3)**, pp. 257–268, 2003.
- [20] Tang, J., Dielectric properties of food (Chapter 2), in *Microwave Processing of Food*, ed. H.S. Schubert & M. Regier, CRC Press, New York, pp. 22–40, 2005.



- [21] Bengtsson, N.E. & Risman, P.O., Dielectric properties of foods at 3 GHz as determined by a cavity perturbation technique. *J. Microwave Power*, **6(2)**, pp. 107–123, 1971.
- [22] Chow Ting Chan, T.V. & Reader, H.C., *Understanding Microwave Heating Cavities*, Boston: Artech House, 2000.
- [23] Neophytou, R.I. & Metaxas, A.C., Characterisation of radio frequency heating systems in industry using a network analyzer. *IEE Proc. Sci. MEas. Technol.*, **144(5)**, pp. 215–222, 1997.
- [24] Jones, P.L. & Rowley, A.T., Dielectric drying. *Drying Tech.*, **14(5)**, pp. 1063–1098, 1996.
- [25] Orfeuil, M., *Electric Process Heating*. Battelle Memorial Institute, 1987.
- [26] Metaxas, A.C. & Clee, M., Coupling and matching of radio frequency industrial applicators. *J. Power Eng.*, **7(2)**, pp. 85–93, 1993.
- [27] Kenyon, E.M., Westcott, D.E., LA Casse, P. & Gould, J.W., A system for continuous thermal processing of pouches using microwave energy. *J. Food Sci.*, **36**, p. 289, 1971.
- [28] Ayoub, J.A., Berkowitz, D., Kenyon, E.M. & Wadsworth, C.K., Continuous microwave sterilization of meat in flexible pouches. *J. Food Sci.*, **39**, p. 309, 1974.
- [29] O'Meara, J.P., Tinga, W.R., Wadsworth, C.K. & Farkas, D.F., Food sterilization in a microwave pressure retort. *J. Microwave Power*, **11**, p. 213, 1976.
- [30] Stenstrom, L.A., Taming microwave for solid food sterilization. Paper 7.4 Presented at the IMPI Symposium, Ottawa, Canada, May 24–26, 1972.
- [31] Stenstrom, L.A., US Patents 3,809,844; 3,809,845; 3,814,889, 1974.
- [32] Ohlsson, T., Development and evaluation of a microwave sterilization process for plastic pouches. Paper presented at the 8th World Conference of Food Science and Technology, Toronto, Sept. 29–October 4, 1992.
- [33] Ohlsson, T., Sterilization of foods by microwaves. Presented at the International Seminar on New Trends in Aseptic Processing and Packaging of Foodstuffs, Munich, Oct. 22–23, 1987.
- [34] Ohlsson, T., Dielectric properties and microwave processing, in *Food Properties and Computer-aided Engineering of Food Processing Systems*, ed. R.P. Single & A.G. Medina, Kluwer Academic Publishers, Dordrecht, the Netherlands, 1989, 1991.
- [35] O'Meara, J.P., Farkas, D.F. & Wadsworth, C.K., Flexible pouch sterilization using combined microwave-hot water hold simulator. Contact No. (PN)DRXNM 77–120, U.S. Army Natick Research & Development Laboratories, Natick, MA, 01760 (unpublished report), 1977.
- [36] Shukla, T.P., Microwave sterilization. *Cereal Foods World*, **36(12)**, p. 1031, 1992.
- [37] Decareau, R.V., The microwave sterilization process. *Microwave World*, **15(2)**, pp. 12–15, 1994.
- [38] Lau, H., Tang, J., Taub, I.A., Yang, T.C.S., Edwards, C.G. & Mao, R., Kinetics of chemical marker formation in whey protein gels for studying

- high temperature short time microwave sterilization. *J. Food Eng.*, **60**, pp. 397–405, 2003.
- [39] Pathak, S., Fen, L. & Tang, J., Finite difference time domain simulation of single-mode 915 MHz cavities in processing pre-packaged foods. *J. Microwave Power and Electromagnetic Energy*, **38(1)**, pp. 37–48, 2003.
- [40] Harlfinger, L., Microwave sterilization. *Food Tech.*, Dec., pp. 57–60, 1992.
- [41] Schlegel, W., Commercial pasteurization and sterilization of food products using microwave technology. *Food Tech.*, Dec., pp. 62–63, 1992.
- [42] Tang, J., Microwave sterilization/pasteurization of foods – thermal process technology for the future: Visit to TOP's Foods. *Microwave Food Heating News*, 2000.
- [43] Morris, C.E., Manufacturing forecast accelerating changes. *Food Eng.*, Mar., pp. 73–77, 1996.
- [44] Tomlins, R.I. & Ordal, Z.J., Thermal injury and inactivation in vegetative bacteria, in *Inhibition and Inactivation of Vegetable Microbes*, ed. F.A. Skinner & W.B. Hugo (Soc. Appl. Bacteriol. Symp. Ser. No. 5, pp. 153–190), Academic Press, London, 1976.
- [45] Burfoot, D., Griffin, W.J. & James, S.J., Microwave pasteurization of prepared meals. *J. Food Eng.*, **8**, pp. 145–156, 1988.
- [46] Schiffmann, R.F., Microwave pasteurization of foods: An overview. *Proceedings of 27th Microwave Power Symposium*, International Microwave Power Institute, Manassas, VA, pp. 111–115, Aug. 2–5, 1992.
- [47] Brody, A.L., Microwave food pasteurization, sterilization and packaging. *J. Food Tech. Int.*, Europe, pp. 67–71, 1992.
- [48] Zhao, Y., Flugstad, B., Kolbe, E., Park, J.W. & Wells, J.H., Using capacitive (radio frequency) dielectric heating in food processing and preservation – a review. *J. of Food Processing Engineering*, **23**, pp. 25–55, 2000.
- [49] Pircon, L.J., Loquercio, P. & Doty, D.M., High frequency heating as a unit operation in meat processing. *Agri. Food Chem.*, **1(13)**, pp. 844–847, 1953.
- [50] Starkweather, K.A., Radio frequency thermal Inactivation of *Listeria innocua* in salmon caviar. MS thesis, Washington State University, Pullman, WA, 2000.
- [51] Zhong, Q. & Sandeep, K.P., Continuous flow radio frequency heating of liquid and particulate foods. Paper Presented at the 93rd Annual International Meeting of ASAE, Milwaukee, WI, July 9–12, 2000.
- [52] Zhong, Q., Sandeep, K.P. & Swartzel, K.R., Continuous flow radio frequency heating of water and carboxymethylcellulos solutions. *J. Food Sci.*, **68(1)**, pp. 217–223, 2003.
- [53] Luechapattanaorn, K., Wang, Y., Wang, J., Tang, J. & Hallberg, L.M., Microbial safety in radio frequency processing of packaged foods. *J. Food Sci.*, **67(7)**, pp. 201–206, 2004.
- [54] Straub, K.D. & Carver, P., Effects of electromagnetic fields on microsomal ATPase and mitochondrial oxidative phosphorylation. *Annals of the New York Academy of Science*, **247**, pp. 292–300, 1975.



- [55] Liburdy, R.P. & Vanek, P.V., Jr., Microwaves and the cell membrane. 2. Temperature, plasma and oxygen mediated microwave-induced membrane permeability in the erythrocyte. *Radiation Research*, **102**, pp. 190–205, 1985.
- [56] Liburdy, R.P. & Magin, R.L., Microwave-stimulated drug release from liposomes. *Radiation Research*, **103**, pp. 266–275, 1985.
- [57] Fisun, O.I., 2D Plasmon excitation and nonthermal effects of microwaves on biological membranes. *Bioelectromagnetics*, **14**, pp. 57–66, 1993.
- [58] Ponne, T.C., Balk, M., Hancioglu, O. & Gorris, L.G.M., Effect of radio frequency on biological membrane and microorganisms. *Lebensm.-Wiss. U.-Technol.*, **29**, pp. 41–48, 1996.
- [59] Barnes, F.S. & Hu, C.L.H., Model for some non-thermal effects of radio and microwave fields on biological membranes. *IEEE Transactions on Microwave Theory and Techniques*, **25**, pp. 742–746, 1977.
- [60] Khalil, H. & Villota, R., Comparative study on injury and recovery of *Staphylococcus aureus* using microwaves and conventional heating. *J. Food Protection*, **51(3)**, pp. 181–186, 1988.
- [61] Sastry, S.K. & Palaniappan, S., The temperature difference between a microorganism and liquid medium during microwave heating. *J. Food Processing and Preservation*, **15**, pp. 225–230, 1991.
- [62] Dessel, M.M., Bowersox, E.M. & Jeter, W.S., Bacteria in electronically cooked foods. *J. American Dietetic Association*, **37**, pp. 230–233, 1960.
- [63] Grecz, N., Walke, A.A. & Anellis, A., Effect of radio frequency energy (2450 mc) on bacteria spores. *Bacterio. Proc.*, p. 145, 1964.
- [64] Culkin, K.A. & Fung, D.Y.C., Destruction of *Escherichia coli* and *Salmonella typhimurium* in microwave cooked soups. I. *Milk Food Technology*, **38(1)**, pp. 8–15, 1975.
- [65] Wayland, J.R., Brannen, J.P. & Morris, M.E., On the interdependence of thermal and electromagnetic effects in the response of *Bacillus subtilis* spores to microwave exposure. *Radiation Research*, **71**, pp. 251–258, 1977.
- [66] Dreyfuss, M.S. & Chipley, J.R., Comparison of effects of sublethal microwave radiation and conventional heating on the metabolic activity of *Staphylococcus aureus*. *Applied and Environmental Microbiology*, **39(1)**, pp. 13–16, 1980.
- [67] Ockerman, H.W., Cahill, V.R., Plimpton, R.F. & Parrett, N.A., Cooking inoculated pork in microwave and conventional ovens. *J. Milk Food Technol.*, **39**, pp. 771–773, 1976.
- [68] Diaz-Cinco, M. & Martinelli, S., The use of microwaves in sterilization. *Dairy, Food and Environmental Sanitations*, **11(12)**, pp. 722–724, 1991.
- [69] Coote, P.J., Holyoak, C.D. & Cole, M.B., Thermal inactivation of *Listeria monocytogenes* during a process simulating temperatures achieved during microwave heating. *J. Appl. Bacteriol.*, **70**, pp. 489–494, 1991.
- [70] Fujikawa, F., Ushioda, H. & Kudo, Y., Kinetics of *Escherichia coli* destruction by microwave irradiation. *Applied and Environmental Microbiology*, **58**, pp. 920–924, 1991.



- [71] Welt, B.A., Tong, C.H., Rossen, J.L. & Lund, D.B., Effects of microwave radiation on inactivation of *Clostridium sporogenes* (PA 3679) spores. *Applied and Environmental Microbiology*, **60**(2), pp. 482–488, 1994.
- [72] Rosen, C.G., Effects of microwaves on food and related materials. *Food Tech.*, **26**, pp. 36–40, 55, 1972.
- [73] Heddleson, R.A. & Doores, S., Factors affecting microwave heating of foods and microwaves induced destruction of foodborne pathogens – a review. *J. Food Protect.*, **57**(11), pp. 1025–1037, 1994.
- [74] Fung, D.Y.C. & Cunningham, F.E., Effect of microwaves on microorganisms in foods. *J. Food Protect.*, **43**(8), pp. 641–650, 1980.
- [75] Kozempel, M., Scullen, O.J., Cook, R.D. & Whiting, R., Preliminary investigation using a batch flow process to determine bacteria destruction by microorganisms at low temperature. *Lebensm.-Wiss.u.-Technol.*, **30**, pp. 691–696, 1997.
- [76] Kozempel, M., Cook, R.D., Scullen, O.J. & Annous, B.A., Development of a process for detecting nonthermal effects of microwave energy on microorganisms at low temperature. *J. Food Processing and Preservation*, **24**, pp. 287–301, 2000.
- [77] Geveke, D.J., Kozempel, M., Scullen, O.J. & Brunkhorst, C., The combined effects of RF and thermal energy on microorganisms. ASAE Annual Meeting, Paper No. 6104, ASAE: St. Joseph, MI, pp. 49085–9659, 2000.
- [78] Anonymous, *Kinetics of Microbial Inactivation for Alternative Food Processing Technology*. IFT report for (IFT/FDA Contract 223-98-2333) the Center for Food Safety and Applied Nutrition, U.S. Food and Drug Administration, 2000.
- [79] Stumbo, C.R., *Thermobacteriology in Food Processing*, 2nd edition. Academic Press, New York, 1973.
- [80] Pflug, I.J., *Selected Papers on the Microbiology and Engineering of Sterilization Processes*, 5th edition. Environmental Sterilization Laboratory, University of Minnesota, St. Paul, MN, 1988.
- [81] Holdsworth, S.D., *Thermal Processing of Packaged Foods*. Chapman & Hall, New York, 1997.
- [82] Cross, G.A. & Fung, D.Y.C., The effect of microwaves on nutritional values of foods. *CRC Crit. Rev. Food Sci. Nutr.* **16**, pp. 355–382, 1982.
- [83] Goldblith, S.A., Tannenbaum, S.R. & Wang, D.I.C., Thermal and 2450 MHz microwave energy effect on the destruction of thiamine. *Food Tech.*, **22**(10), pp. 1266–1268, 1968.
- [84] Welt, B.A. & Tong, C.H., Effects of microwave radiation on thiamin degradation kinetics. *Journal of Microwave Power and Electromagnetic Energy*, **28**(4), pp. 187–195, 1993.
- [85] Lund, D.B., Kinetics of physical changes in foods, in *Physical and Chemical Properties of Food*, ed. M.R. Okos, American Society of Agriculture Engineers, St Joseph, MI, 1986.
- [86] FDA, Code of Federal Regulations. Title 21. Food and Drug, Food and Drug Administration, Government Services Administration, Washington, DC, 1977.



- [87] National Canners Association Research Laboratories, Heat penetration and heat distribution, *Laboratory Manual for Food Canners and Processors*, 3rd edition, AVI Publishing, Westport, CT, 1968.
- [88] Ohlsson, T., Possibilities and limits of microwave sterilization. *Proceeding of International Symposium*, Karlsruhe, Germany, 1972.
- [89] Kim, H.J., Taub, I.A., Choi, Y.M. & Prakash, A., Principles and applications of chemical markers of sterility in high-temperature-short-time processing of particulate foods (Chapter 6), in *Chemical Markers for Processed and Stored Foods*, ed. T.C. Lee & H.J. Kim, American Chemical Society, Washington, DC, pp. 54–69, 1996.
- [90] Kim, H.J. & Taub, I.A., Intrinsic chemical markers for aseptic processing of particulate foods. *Food Tech.*, **47(1)**, pp. 91–97, 99, 1993.
- [91] Wang, Y., Lau, M.H., Tang, J. & Mao, R., Kinetics of chemical marker M-1 formation in whey protein gels for developing sterilization processes based on dielectric heating. *J. Food Eng.*, **64(1)**, pp. 111–118, 2004.
- [92] Kim, H.J., Ball, D., Giles, J. & White, F., Analysis of thermally produced compounds in foods by thermospray liquid chromatography – mass spectrometry and gas chromatography. *Journal of Agriculture Food and Chemistry*, **42(12)**, pp. 2812–2816, 1994.
- [93] Kato, H., Nakayama, T., Sugimoto, S. & Hayase, F., Volatile and non-volatile Maillard reaction products between L-lysine and D-glucose. *Agricultural Biology Chemistry*, **46**, pp. 2599–2600, 1982.
- [94] Kim, H.J., Choi, Y.M., Yang, T.C.S., Taub, I.A., Tempest, P., Skudder, P., Tucker, G. & Parroott, D.L., Validation of ohmic heating for quality enhancement of food products. *Food Tech.*, **50(3)**, pp. 253–261, 1996.
- [95] Whistler, R.L. & Daniel, J.R., Carbohydrates, in *Food Chemistry*, 2nd edition, ed. O.R. Fennema, Marcel Dekker, New York, pp. 69–137, 1985.
- [96] Yaylayan, V.A., Fichtali, J. & van de Voort, F.R., Formation and degradation of tryptophan amadori products during extrusion processing, in *Thermally Generated Flavors Maillard, Microwave and Extrusion Processes*, ed. T.H. Parliment, M.J. Morello & R.J. McGorin, American Chemical Society, Washington, DC, pp. 348–355, 1994.
- [97] Feather, M.S., *Maillard Reactions in Food*, Vol. 5, ed. C. Eriksson, Program in Food and Nutrition Science, Pergamon Press, New York, pp. 37–45, 1981.
- [98] Ross, E.W., Relation of bacterial destruction to chemical marker formation during processing by thermal pulses. *Journal of Food Process Engineering*, **16**, pp. 247–270, 1993.
- [99] Prakash, A., Kim, H.J. & Taub, I.A., Assessment of microwave sterilization of foods using intrinsic chemical markers. *Journal of Microwave Power and Electromagnetic Energy*, **32(1)**, pp. 50–57, 1997.
- [100] Ramaswamy, H.S., Awuah, G.B., Kim, H.J. & Choi, Y.M., Evaluation of a chemical marker for process lethality measurement at 110°C in a continuous flow holding tube. *J. Food Processing and Preservation*, **20**, pp. 235–249, 1996.





- [101] Pandit, R.B., Tang, J., Liu, F. & Pitts, M., Development of a novel approach to determine heating pattern using computer vision and chemical marker (M-2). *J. Food Engineering*, **78(2)**, pp. 522–528, 2007.
- [102] Pandit, R.B., Tang, J., Mikhaylenko, G. & Liu, F., Kinetics of chemical marker M-2 formation in mashed potato – a tool to locate cold spots under microwave sterilization. *Food Engineering*, **76(3)**, pp. 353–361, 2006.
- [103] Berek, H.E. & Wickersheim, K.A., Measuring temperatures in microwaveable packages. *J. Packaging Technology*, pp. 164–168, 1988.
- [104] Cable, D.W. & Saaski, E., Fiber-optic pressure measurement of spontaneous bumping/splattering of foods during microwaving. *Food Tech.*, **44(6)**, p. 120, 1990.
- [105] Wang, S., Tang, J. & Younce, F., Temperature measurement, in *Encyclopedia of Agricultural, Food and Biological Engineering*, Marcel Dekker, New York, 2003.
- [106] Taflove, A., *Computational Electrodynamics: The Finite-Difference Time-Domain Method*. Artech House: Boston, 1995.
- [107] Sadiku, M.N.O., *Numerical Techniques in Electromagnetics*. CRC Press: New York, 1992.
- [108] Datta, A.K., Computer-aided engineering in food process and product design. *Food Tech.*, **52(10)**, pp. 44–52, 1998.
- [109] Tang, J., Liu, F., Pathak, S. & Eves, G., Apparatus and method for heating objects with microwaves, US Patent No. 7,119,313, October 10, 2006.
- [110] Neophytou, R.I. & Metaxas, A.C., Combined 3D FE and circuit modeling of radio frequency heating systems. *J. Microwave Power and Electromagnetic Energy*, **33(4)**, pp. 243–262, 1998.
- [111] Chow Ting Chan, T.V., Tang, J. & Younce, F., Three-dimensional numerical modeling of an industrial radio frequency heating system using finite elements. *J. Microwave Power and Electromagnetic Energy*, **39(2)**, pp. 87–105, 2004.

