

NOTE: This chapter is currently being re-written and its content will be included in Chapter 305 in the future.

CHAPTER 46

Intersections At-Grade

Design Memorandum	Revision Date	Sections Affected
16-12	Mar. 2016	46-11.02(04), 46-11.02(07)
18-18	Aug. 2018	Fig. 46-4M
18-19	Aug. 2018	Fig. 46-4J

TABLE OF CONTENTS

TABLE OF CONTENTS.....	2
LIST OF FIGURES	5
46-1.0 GENERAL DESIGN CONTROLS.....	7
46-1.01 Design Speed	7
46-1.02 Intersection Alignment	8
46-1.03 Intersection Profile	8
46-1.03(01) Approach Grade	9
46-1.03(02) Cross-Section Transition.....	9
46-1.03(03) Vertical Profile.....	10
46-1.03(04) Drainage.....	11
46-1.04 Capacity and Level of Service.....	12
46-1.05 Types of Intersections.....	12
46-1.05(01) Number of Legs	12
46-1.05(02) Public Road Approach	12
46-1.05(03) Determining Pavement Section [Rev. Sep. 2019]	13
46-1.06 Intersection Spacing	14
46-1.07 Design Vehicle	14
46-1.07(01) Types.....	14
46-1.07(02) Selection.....	15
46-2.0 TURNING RADIUS FOR RIGHT TURN	15
46-2.01 Design for Pavement Edge or Curb Line.....	15
46-2.01(01) Inside Clearance.....	15
46-2.01(02) Encroachment	16
46-2.01(03) Parking Lane or Shoulder	16
46-2.01(04) Pedestrians	17
46-2.01(05) Type of Turning Design.....	17
46-2.01(06) Turning Template.....	17
46-2.02 Summary.....	18
46-2.03 Turning-Radius Design.....	18
46-3.0 TURNING ROADWAY	18
46-3.01 Guidelines.....	19
46-3.02 Design Criteria.....	20
46-3.02(01) Design Speed	20
46-3.02(02) Width.....	20
46-3.02(03) Pavement Thickness.....	21
46-3.02(04) Horizontal Alignment	21
46-3.02(05) Deceleration or Acceleration Lane	24
46-3.02(06) Pavement Markings	25
46-4.0 RIGHT- OR LEFT-TURN LANE.....	25

46-4.01	Turn-Lane Warrants	25
46-4.01(01)	Warrants for a Right-Turn Lane	25
46-4.01(02)	Warrants for a Left-Turn Lane.....	26
46-4.02	Design of Left- or Right-Turn Lane	26
46-4.02(01)	Turn-Lane Width	26
46-4.02(02)	Turn-Lane Length	27
46-4.02(03)	Channelized Left-Turn Lane.....	28
46-4.02(04)	Slotted Left-Turn Lane	29
46-4.02(05)	Turn-Lane Extension	29
46-4.03	Passing Blister	31
46-4.04	Multiple Turn Lane.....	32
46-4.04(01)	Warrants.....	32
46-4.04(02)	Design	32
46-5.0	TWO-WAY LEFT-TURN LANE (TWLTL).....	33
46-5.01	Guidelines.....	33
46-5.02	Design Criteria.....	35
46-5.02(01)	Lane Width.....	35
46-5.02(02)	Intersection Treatment	35
46-5.03	6-Lane Section.....	36
46-6.0	INTERSECTION ACCELERATION LANE	38
46-6.01	Acceleration Lane for Right-Turning Vehicle.....	38
46-6.02	Acceleration Lane in Median	38
46-6.03	Design Criteria.....	39
46-7.0	ADDITIONAL THROUGH LANE AT INTERSECTION	39
46-8.0	MEDIAN OPENING.....	40
46-8.01	Non-Freeway	40
46-8.01(01)	Warrants.....	40
46-8.01(02)	Design	40
46-8.02	Median Opening on Freeway	43
46-9.0	CHANNELIZING ISLAND.....	43
46-9.01	Types of Islands.....	43
46-9.02	Selection of Island Type	44
46-9.03	Minimum Size	45
46-9.04	Delineation.....	45
46-9.05	Island Offset to Through Lanes	45
46-9.06	Typical Channelizing Intersection.....	46
46-10.0	INTERSECTION SIGHT DISTANCE (ISD).....	46
46-10.01	No Traffic Control.....	47
46-10.02	Yield Control	47
46-10.02(01)	Intersection With Yield Control on the Minor Road	47
46-10.02(02)	Left- or Right-Turn Maneuver.....	47

46-10.02(03) Turning Roadway.....	48
46-10.03 Stop Control.....	49
46-10.03(01) Departure Sight Triangle and Time Gap.....	49
46-10.03(02) Measures to Improve Intersection Sight Distance	51
46-10.04 Left Turn From the Major Road.....	51
46-10.05 Signal-Controlled Intersection.....	52
46-10.06 Effect of Skew	52
46-11.0 DRIVE DESIGN	53
46-11.01 General Information	53
46-11.01(01) Definitions of Drives and Types.....	53
46-11.01(02) Drive Spacing and Corner Clearance.....	54
46-11.01(03) Drive Sight Distance	54
46-11.01(04) Auxiliary Lane	55
46-11.01(05) Joint Residential or Commercial Drive.....	55
46-11.02 Design Criteria.....	55
46-11.02(01) Class Determination Considerations.....	55
46-11.02(02) Radii.....	55
46-11.02(03) Width.....	56
46-11.02(04) Drive Grade [Rev. Mar. 2016].....	56
46-11.02(05) Grading	57
46-11.02(06) Paving	57
46-11.02(07) Sidewalk-Driveway Crossings [Rev. Mar. 2016].....	57
46-11.03 Impacts to Project with Drive Design Complete and Right of Way Acquisition Under Way.....	57
46-12.0 TURNING TEMPLATES	58
FIGURES.....	59

LIST OF FIGURES

Figure	Title
46-1A	Treatments for Skewed Intersections
46-1B	Pavement Transitions Through Intersections
46-1C	Vertical Profiles of Intersecting Roads
46-1C(1)	Public Road Approach Types and Corresponding Design Vehicles
46-1D	Typical Semitrailer Combination Design Vehicle
46-1E	Suggested Design Vehicle Selection (Intersections)
46-2A	Guidelines for Encroachment for Right Turns (Urban Intersections)
46-2B	Effect of Curb Radii and Parking on Turning Paths
46-2C	Turning Radii Design
46-2D	Turning Radii for Typical Design Vehicles
46-2E	Typical Turning Radii Design Assumptions
46-3A	Typical Turning Roadway (Stop Controlled on Minor Road)
46-3B	Derived Pavement Widths, ft, for Turning Roadways for Different Design Vehicles
46-3C	Superelevation Rates (Turning Roadways)
46-3D	Development of Superelevation at Turning Roadway Terminals
46-3E	Typical Designs for Turning Roadways
46-3E(1)	Stopping Sight Distance for Turning Roadways
46-3F	Pavement Cross Slope at Turning Roadway Terminals
46-3G	Additional Length of Turning Roadway (Signalized Intersection)
46-3H	Typical Pavement Markings for Turning Roadways
46-4A	Guidelines for Right-Turn Lanes at Unsignalized Intersections on 2-Lane Highways
46-4B	Guidelines for Right-Turn Lanes at Unsignalized Intersection on 4-Lane Highways
46-4C	Volume Guidelines for Left-Turn Lanes on Two-Lane Highways
46-4H	Functional Lengths of Auxiliary Turning Lanes
46-4 I	Typical Auxiliary Lanes at an Intersection
46-4J	Deceleration Distances for Turning Lanes [Rev. Aug. 2018]
46-4K	Storage Length Adjustment Factors
46-4K(1)	Recommended Storage Length for Signalized Intersection
46-4L	Recommended Storage Lengths (LS) for Unsignalized Intersections
46-4M	Channelized Left-Turn Lane for 2-Lane Highway [Rev. Aug. 2018]
46-4N	Typical Slotted Tapered Left-Turn Lane (Signalized Intersections)
46-4N(1)	Typical Slotted Parallel Left-Turn (Signalized Intersection)
46-4 O	Typical Passing Blister for a 2-Lane Highway
46-4P	Schematic For Multiple Turn Lanes
46-5A	Typical Pavement Markings for a TWLTL
46-7A	Extension of Additional Through Lanes
46-8A	Recommended Median Opening Spacing (Non-Freeway)
46-8B	Median Opening Design
46-8C	Minimum Design of Median Openings, Design Vehicle: P, Control Radius: 70'
46-8D	Minimum Design of Median Openings, Design Vehicle: SU, Control Radius: 85'
46-8E	Minimum Design of Median Openings, Design Vehicle WB-50,Control Radius: 100'
46-9A	Triangular Island
46-9B	Elongated Islands

- 46-9C Example of a Channelizing Intersection
- 46-10A Intersection Sight Distance with No Traffic Control
- 46-10B Adjustment Factors for Sight Distance with No Traffic Control
- 46-10C Time Gaps for Left or Right Turns, Yield Control
- 46-10D Design Intersection Sight Distance, Left or Right Turn at Yield- Controlled Intersection
- 46-10E Intersection Sight Distance for Turning Roadways
- 46-10F Departure Sight Triangles
- 46-10G Intersection Sight Distance for Stop-Controlled Intersection
- 46-10H Intersection Sight Distance for Passenger Car to Turn Right from a Stop or to Make a Crossing Maneuver
- 46-10H(1) Time Gaps for Crossing Maneuver
- 46-10 I Time Gaps for Left Turn from the Major Road
- 46-10J Intersection Sight Distance for Left Turn from the Major Road
- 46-10K Sight Triangles at Skewed Intersections
- 46-11A Drive Embankment Slopes Within Clear Zone
- 46-12A P - Design Vehicle (1" = 20' Scale)
- 46-12B P - Design Vehicle (1" = 50' Scale)
- 46-12C SU - Design Vehicle (1" = 20' Scale)
- 46-12D SU - Design Vehicle (1" = 50' Scale)
- 46-12D(1) S-BUS-36 - Design Vehicle (1" = 20' Scale)
- 46-12D(2) S-BUS-36 - Design Vehicle (1" = 50' Scale)
- 46-12E WB-40 - Design Vehicle (1" = 30' Scale)
- 46-12F WB-40 - Design Vehicle (1" = 50' Scale)
- 46-12G WB-50 - Design Vehicle (1" = 30' Scale)
- 46-12H WB-50 - Design Vehicle (1" = 50' Scale)
- 46-12 I WB-62 - Design Vehicle (1" = 30' Scale)
- 46-12J WB-62 - Design Vehicle (1" = 50' Scale)
- 46-12K WB-65 (IDV) - Design Vehicle (1" = 30' Scale)
- 46-12L WB-65 (IDV) - Design Vehicle (1" = 50' Scale)
- 46-12N WB-109D - Design Vehicle (1" = 50' Scale)
- 46-12 O MH/B - Design Vehicle (1" = 30' Scale)
- 46-12P MH/B - Design Vehicle (1" = 50' Scale)

INTERSECTIONS AT-GRADE

This Chapter discusses the geometric design of an at-grade intersection. The intersection is an important part of the highway system. The operational efficiency, capacity, safety, and cost of the system depend largely upon its design, especially in an urban area. The primary objective of intersection design is to reduce potential conflicts between vehicles, bicycles, and pedestrians while providing for the convenience, ease, and comfort of those traversing the intersection.

46-1.0 GENERAL DESIGN CONTROLS

46-1.01 Design Speed

The design speed for the intersection approaches should be equal to the design speed of the approach facility. However, this should not discourage the designer from using reduced geometric criteria if necessary to produce a more desirable result (e.g., to reduce driver speed prior to the intersection). If the designer can reasonably justify the design exception, the reduced criteria should be considered. To determine if reduced criteria may be applicable, the designer should consider the factors as follows:

1. heavy development along the road;
2. a posted speed limit lower than the design speed;
3. stopping sight distance;
4. adverse impacts to property owners;
5. adverse impacts to the environment;
6. low AADT;
7. construction costs;
8. adequate advance signing;
9. stop-sign control;
10. violation of driver expectancy;
11. T intersection;
12. short frontage road (See Section 45-7.04); or
13. access road with only one outlet (See Section 45-7.04).

For more information on using reduced criteria for a frontage road or local-road intersection, see Section 45-7.04.

46-1.02 Intersection Alignment

All legs of an intersection should be on a tangent section. Where a minor road intersects a major road on a horizontal curve, the geometric design of the intersection becomes significantly more complicated, particularly for sight distance, turning movements, channelization, and superelevation. If relocation of the intersection is not practical, the minor road may be realigned to intersect the major road perpendicular to the tangent at a point on the horizontal curve. Although an improvement, this arrangement may still result in difficult turning movements if the major road is superelevated. Intersection sight distance should be considered.

Roadways should intersect at right angles. An intersection at an acute angle is undesirable for the reasons as follows:

1. Vehicular turning movements become more restricted.
2. The accommodation of large trucks may require additional pavement and channelization.
3. The exposure time for vehicles and pedestrians crossing the main traffic flow is increased.
4. The driver's line of sight for one of the sight triangles becomes restricted.

The angle of intersection should be within 20 deg of perpendicular. This amount of skew can often be tolerated because the impact on sight lines and turning movements may not be significant. Under restricted conditions where obtaining the right of way to straighten the angle of intersection would be impractical, an intersection angle up to 30 deg from perpendicular may be used. A more-acute intersection angle may warrant more positive traffic control (all-stop or traffic signalization) or geometric improvements (realignment, greater corner sight distance). The practice of realigning roads that intersect at an acute angle as shown in Figure [46-1A](#), Treatment for Skewed Intersection, diagrams A and B, has proven to be beneficial. The practice of constructing short-radius curves on the side-road approaches to achieve a right-angle intersection should be avoided where practical, because it may result in increased lane encroachments.

46-1.03 Intersection Profile

The designer should avoid combinations of grade lines that make vehicular control difficult at an intersection. The following criteria will apply.

46-1.03(01) Approach Grade

The grades of the intersecting highways should be as flat as practical on those portions that will be used for storage of stopped vehicles. This is referred to as the storage platform. The storage platform grade should be 0.5%, not to exceed 2% where practical, on each intersecting leg within the expected storage distance on the leg (see Section [46-4.02](#)). At a minimum, the storage platform should be at least 50 ft long where there are less than 10% trucks, or 100 ft long where there are 10% or more trucks. A grade of steeper than 3% should be avoided, if practical. However, a grade through the intersection must reflect the practicalities of matching the basic profiles of the intersecting roadways and shoulders. The intersecting-roadway grade should not exceed the grade differences (ΔG) as defined in Section [46-1.03\(03\)](#) with respect to the mainline cross slope. The mainline shoulder or turn-lane cross slope and the mainline cross slope should not exceed the breakover cross slope differences shown in Figure [46-3F](#).

46-1.03(02) Cross-Section Transition

One or both of the approaching minor-road legs of an intersection may need to be transitioned (or warped) to meet the cross section of the major road. The designer should consider the following:

1. Stop-Controlled. Where the minor road is stop controlled, the profile and cross section of the major road will be maintained through the intersection. The cross slope of the stop-controlled leg will be transitioned to match the major-road cross slope and profile.
2. Signalized Intersection. At a signalized or a potentially signalized intersection, the cross section of the minor road will be transitioned to meet the profile and cross slope of the major road. If both intersecting roads have approximately equal importance, the designer may want to consider transitioning both roadways to form a plane section through the intersection. Where compromises are necessary between two such major roadways, the smoother riding characteristics should be provided for the roadway with the higher traffic volume and operating speed.

3. Transition Rate. Where one or both intersecting roadways are transitioned, the designer must determine the length and rate of transition from the normal section to the modified section. See Figure [46-1B](#), Pavement Transition Through Intersection. The transition should be designed to meet the general principles of superelevation transition which apply to that roadway (i.e., open-road or low-speed urban street condition). See Section 43-3.0 for a complete discussion on superelevation development. Where these criteria are applied to the transition rate, the applied design speed is typically one of the following:
 - a. 30 mph for a stop-controlled leg;
 - b. the highway design speed for a free-flowing leg; or
 - c. the highway design speed for each leg of a signalized intersection.

At a minimum, the approaching legs of an intersection should be transitioned within the curb or curve radius length of the intersection consistent with practical field conditions (see Figure [46-1B](#), Pavement Transition Through Intersection).

46-1.03(03) Vertical Profile

Where the cross section of the minor road is warped to meet that of the major road, this will result in angular breaks for traffic on the minor road if no vertical curve is inserted. If the vertical curve at the intersection cannot be designed for full stopping sight distance as discussed in Item 1 below, lighting of the intersection should be considered. The following options are provided in order from the most desirable to the least desirable (see Figure [46-1C](#), Vertical Profile of Intersecting Road).

1. Vertical Curve (SSD). A vertical curve should be used through an intersection which meets the criteria for stopping sight distance as described in Chapter Forty-four. For stop-controlled legs, the vertical curve should be designed to meet a design speed of 30 mph. At free-flowing legs or at a signalized intersection, the design speed of the roadway should be used to design the vertical curve.
2. Sag Vertical Curve (Comfort). For a sag vertical curve, the next most desirable option is to design the sag to meet the comfort criteria. The length of vertical curve can be determined as follows:

$$L = \frac{AV^2}{46.5}$$

Where:

- L = length of vertical curve, ft
- A = algebraic difference between grades, %
- V = design speed, mph

3. Vertical Curve (Minimum Comfort). Under restricted conditions where a design based on SSD or comfort is not practical and where the design speed is 30 mph or lower, a vertical curve at an intersection approach may be based on the formulas as follows:

$$K = (0.10V)^2 \quad (\text{Sag Curve})$$

$$K = (0.07V)^2 \quad (\text{Crest Curve})$$

$$L = K A$$

Where:

K = the horizontal distance in feet needed to produce a 1% change in the gradient along the curve

A = algebraic difference between the two tangent grades, %

V = design speed, mph

L = length of vertical curve, ft

4. Angular Breaks. Under restricted conditions, it may be impractical to provide vertical curves on the approaches, as angular breaks are necessary through the intersection. Angular breaks may allow other intersection geometric features, such as sight distance, storage platform, and drainage, to function better. Figure [46-1C](#), Vertical Profile of Intersecting Road, provides a schematic of vertical profiles through an intersection. The figure also indicates maximum angular breaks for a design speed of 30 mph or lower. For a higher design speed, a vertical curve as discussed in Items 1 and 2 above should be used. Where angular breaks are used, the minimum chord distance between angle points should be at least 15 ft.

46-1.03(04) Drainage

The profile and transitions at each intersection should be evaluated for impacts on drainage. This may require spot elevations to be shown for an intersection which may have exceptional drainage problems (e.g., an intersection which occurs in a sag vertical curve).

46-1.04 Capacity and Level of Service

The Office of Environmental Services will perform a capacity analysis of the intersection during the preparation of the Engineer's Report. This analysis will influence geometric design features including the number of approach lanes, lane widths, channelization, and number of departure lanes. These determinations will be based on a selected level of service and design-year traffic (i.e., 20 years into the future). Level-of-service criteria are shown in the geometric-design figures in Chapters Fifty-three through Fifty-six. Once the level of service and design traffic volume are determined, the detailed capacity analysis is performed using the *Highway Capacity Manual* and the criteria provided in Chapter Forty-one.

46-1.05 Types of Intersections

46-1.05(01) Number of Legs

An at-grade intersection is usually a 3-leg (T or Y shape), 4-leg, or multi-leg design. An individual intersection may vary in size and shape and may be non-channelized, flared, or channelized. The principal factors which affect the selection of intersection type and its design characteristics are the design hourly traffic volume, turning movements, traffic character or composition, design speed, intersection angle, topography, desired type of operations, and safety.

A multi-leg intersection is that with five or more intersection legs, and should be avoided where practical. Where traffic volume is light and stop control is used, it may be satisfactory to have all legs intersect at a common paved area. At other than a minor intersection, safety and efficiency are improved by rearrangement that removes some conflicting movements from the major intersection. This may be accomplished by realigning one or more of the intersecting legs and combining some of the traffic movements at adjacent subsidiary intersections or, making one or more legs one-way away from the intersection.

45-1.05(02) Public Road Approach

The warrants for each type of public-road approach are as follows:

1. Public Road Approach Type A. This approach should be used where the mainline shoulder is unpaved, or, if paved, is less than 8 ft in paved width.
2. Public Road Approach Type B. This approach should be used where the mainline shoulder is paved, and is 8 ft or wider in paved width. A paved shoulder of this width or greater will encourage use by a right-turning vehicle to clear the mainline traffic lane when decelerating for the turn.

Public-road approach types A and B are designed to accommodate a design vehicle of WB-50 or smaller, which makes a right-hand turn beginning and ending in the traffic lanes. Right-turn lanes are not provided for these approaches. Either of these approaches should be used for a public road serving a residential, light-commercial, or light-industrial area.

3. Public Road Approach Type C. This approach should be used where the mainline shoulder is paved, is 8 ft or wider in paved width, and an auxiliary right-turn lane along the mainline is warranted due to the right-turning traffic volume. This approach is designed to accommodate a design vehicle of WB-50 or smaller without encroaching onto the adjoining traffic lane. It will also accommodate a WB-65 design vehicle if a portion of the adjoining traffic lane is utilized. This approach should be used for a public road serving a residential, light-commercial, or light-industrial area.
4. Public Road Approach Type D. This approach should be used where the mainline shoulder is paved, is 8 ft or wider in paved width, and an auxiliary right-turn lane along the mainline is warranted due to the right-turning traffic volume. This approach is designed to accommodate a design vehicle of WB-65 or smaller. This approach should be used where two Department-maintained routes intersect, or for a public road serving a commercial area, heavy-industrial area, or truck stop.

Figure [46-1C\(1\)](#), Public Road Approach Types and Corresponding Design Vehicles, summarizes each type of public-road approach and the corresponding appropriate design vehicles it can accommodate.

46-1.05(03) Determining Pavement Section [Rev. Sep. 2019]

If, for a public road approach type A, B, C or D the ADTT of FHWA Class 4 trucks is 50 or less, the minimum pavement section shown on the INDOT *Standard Drawings* series 610-PRAP should be specified.

If, for a public road approach type A, B, C, or D the AADTT of FHWA Class 4 trucks is greater than 50, ESALs must be determined as described in Section 601-4.0

For an HMA approach, the required mix type (HMA Category) is determined based on ESALs as shown in Figure 601-4F. The courses and densities should be those identified in the minimum pavement section shown on the INDOT *Standard Drawings*.

For a PCCP approach, the pavement thickness is determined as described in Section 604-2.03.

46-1.06 Intersection Spacing

If creating a new intersection, the designer must ensure that there is sufficient distance between the new and adjacent intersections so that they form distinct intersections. A short distance between intersections should be avoided, if practical, because it tends to impede traffic operations. For example, if two intersections are close together and require signalization, they may need to be considered as one intersection for signalization purposes. To operate safely, each leg of the intersection may require a separate green cycle, thereby greatly reducing the capacity for both intersections. To operate efficiently, signalized intersections should be at least 1300 ft apart. New intersections should preferably be at least 400 ft apart.

A short gap between opposing T intersections should be avoided. A driver tends to encroach into the opposing lanes (corner cutting) to make the turn in one movement.

46-1.07 Design Vehicle

46-1.07(01) Types

The design vehicles used for intersection design are as follows.

1. P Passenger car, light panel truck, or pickup truck
2. SU Single-unit truck
3. CITY-BUS City transit bus
4. S-BUS-36 Conventional school bus (65 passengers)
5. A-BUS Articulated bus
6. WB-40 Intermediate semitrailer combination
7. WB-50 Intermediate semitrailer combination
8. WB-62 Interstate-route semitrailer combination
9. WB-65 (Indiana Design Vehicle, or IDV) Interstate-route semitrailer combination
10. WB-100T Semitrailer combination with three trailers
11. WB-109D Turnpike semitrailer combination with two trailers
12. MH Recreational vehicle: motor home
13. P/T Recreational vehicle: passenger car and camper trailer
14. P/B Recreational vehicle: passenger car and boat trailer
15. MH/B Recreational vehicle: motor home and boat trailer

See Figure [46-1D](#), Typical Semitrailer Combination Design Vehicle illustrates a turning path of a semitrailer design vehicle. Section [46-12.0](#) provides turning templates for the design vehicles which are used by the Department.

46-1.07(02) Selection

The selected design vehicle should be based on the largest vehicle that will use the intersection with some frequency. Figure [46-1E](#), Suggested Design-Vehicle Selection (Intersection), identifies the desirable and minimum design vehicle based on the functional classification of the intersecting highways which the vehicle is turning from and onto.

Some portions of an intersection may be designed with one design vehicle and other portions with another vehicle. For example, it is desirable to design physical characteristics such as curbs or islands for the IDV but to provide painted channelization markings for a passenger car. This will provide a positive indicator for the more-frequent-turning vehicle.

The SU vehicle is the smallest vehicle used in the design of an intersection. This reflects that in a residential area, a delivery truck will be negotiating turns with some frequency. On a facility accommodating regular truck traffic, one of the semitrailer combinations should be used for design. For design purposes, the IDV is permitted to operate on each public highway.

The WB-100T and WB-109D design vehicles are only permitted to operate on the Indiana Toll Road or within 15 mi of its toll gates.

46-2.0 TURNING RADIUS FOR RIGHT TURN

The turning-radius treatment for an intersection at-grade influences the operation, safety, and construction costs of the intersection. Turning-radius design may not receive sufficient attention. Therefore, the designer should ensure that the design is compatible with the intersection operation. Section [46-2.01](#) provides guidance in determining an acceptable turning-radius design. Section [46-2.03](#) provides the turning-radius design which may be used for preliminary design purposes.

46-2.01 Design for Pavement Edge or Curb Line

Once the designer has selected the design vehicle (Section [46-1.07](#)), the proper pavement-edge or curb-line location must be determined, as described below.

46-2.01(01) Inside Clearance

The selected design vehicle will make a right turn while maintaining approximately a 2-ft clearance from the pavement edge or curb line and, at a minimum, will not come closer than 1 ft.

46-2.01(02) Encroachment

To determine the acceptable encroachment, the designer should evaluate factors including traffic volume, one-way or two-way operation, urban or rural location, and functional classifications of the intersecting roads or streets. The following will apply.

1. Urban. The selected design vehicle should not encroach into the opposing travel lanes. However, this is not always practical or cost effective. Figure [46-2A](#) provides recommended criteria for acceptable encroachment for a right-turning vehicle at an urban intersection. The designer must evaluate these encroachment recommendations against the construction and right-of-way impacts. For example, if the impacts are significant and if through or turning volume is relatively low, the designer may decide to accept an encroachment of the design vehicle which exceeds the criteria in shown Figure [46-2A](#).
2. Rural. The selected design vehicle should not encroach onto the adjacent lane on the road from which the turn is made nor into the opposing lanes of traffic onto the road which the turn is made.

If there are two or more lanes of traffic in the same direction on the road onto which the turn is made, the selected design vehicle can occupy both travel lanes. The turning vehicle should be able to make the turn while remaining entirely in the right through lane.

46-2.01(03) Parking Lane or Shoulder

A parking lane or shoulder will be available on one or both approach legs, and this additional roadway width may be carried through the intersection. This will greatly ease the turning problem for a large vehicle at an intersection with a small curbed radius. Figure [46-2B](#) illustrates the turning paths of design vehicles where the radius is 15 ft or 25 ft and where an 8- to 10-ft parking lane is provided. The presence of a shoulder of 8 to 10 ft width will have the same impact as a parking lane.

The figure also illustrates the necessary distance to restrict parking before the PC (15 ft) and after the PT (20 to 40 ft) on the cross street. The designer will, of course, need to check the proposed design with the applicable turning template and encroachment criteria. The designer should not consider the beneficial effects of a parking lane if the lane will be used for through traffic for part of the day.

Where the turning volume is low, the typical shoulder pavement structure may be used. However, where the turning volume is high or where there is a significant number of turning trucks, a full-depth shoulder pavement should be constructed. Figure [46-2B](#) also indicates where the parking lane or shoulder should have a full-depth pavement structure. This treatment is critical to avoid pavement deterioration from trucks turning at the intersection.

46-2.01(04) Pedestrians

The greater the turning radius, the farther a pedestrian must walk across the roadway. This is especially important for pedestrians with disabilities. Therefore, the designer should consider the number of pedestrians when determining the pavement-edge or curb-line location. This may lead to, for example, the decision to use a simple curve with taper offsets or a turning roadway (see Section [46-3.0](#)) to provide a pedestrian refuge.

46-2.01(05) Type of Turning Design

Once the designer has determined the basic turning parameters (e.g., design vehicle, encroachment, inside clearance), it is necessary to select a type of turning design for the curb return or pavement edge which will be in accordance with the criteria described below and will fit the intersection constraints.

The simple radius is the easiest to design and construct and is used at an urban intersection. However, the simple radius with an entering and exiting taper provides a better fit to the transitional turning path of a vehicle. The simple radius with tapers should be used at a rural intersections, or, desirably, at an urban intersection. A simple radius without tapers may be used for an urban intersection design. Advantages of the simple radius with exiting and entering tapers as compared to the simple radius without tapers are as follows.

1. To accommodate a specific design vehicle, a simple radius with tapers requires less intersection pavement than a simple radius without tapers. Another benefit is the reduced right-of-way impact at the intersection corners. For a large vehicle, a simple radius is often an unreasonable design, unless a channelized island is used and, in effect, a turning roadway is installed.
3. A simple radius without tapers results in a greater distance for a pedestrian to cross than a simple radius with tapers.
4. For an angle of turn greater than 90 deg, a simple radius with tapers is a better design than a simple radius without tapers, primarily because less intersection area is required.

46-2.01(06) Turning Template

To determine the final design, the designer must use a turning template for the selected design vehicle. The template will be applied to the intersection to determine how best to meet the criteria for turning-radius design.

46-2.02 Summary

Figure [46-2C](#) illustrates the factors which should be evaluated in determining the proper design for a right turns at an intersection. In summary, the following procedure applies.

1. Select the design vehicle; see Figure [46-1E](#).
2. Determine the acceptable inside clearance; see Section [46-2.01\(01\)](#).
3. Determine the acceptable encroachment; see Section [46-2.01\(02\)](#).
4. Consider the benefits of a parking lane or shoulder; see Section [46-2.01\(03\)](#).
5. Consider impacts on pedestrians; see Section [46-2.01\(04\)](#).
6. Select the type of turning treatment see Section [46-2.01\(05\)](#) (simple radius or simple radius with entering and exiting tapers).
7. Check the proposed design with the applicable vehicular turning template.
8. Revise the design as necessary to accommodate the right-turning vehicle or determine that it is not practical to meet this design because of adverse impacts.

46-2.03 Turning-Radius Design

Figure [46-2D](#) provides recommended the minimum turning radius for various design vehicles, angles of turn, and acceptable encroachment which may be used in the preliminary design. Figure [46-2E](#) illustrates the assumptions used to develop these figures. As an alternative, the designer may want to consider using the public-road approach details in the INDOT *Standard Drawings*. For the final design, the designer should check the intersection layout using the procedures described in Section [46-2.01](#).

46-3.0 TURNING ROADWAY

A turning roadway is a channelized area (separated by an island) at an intersection at-grade which allows for a moderate-speed, free-flowing right turn. An interchange ramps is not considered to be a turning roadway.

46-3.01 Guidelines

1. **Area Classification.** A turning roadway is provided in the areas as follows.
 - a. Rural. At the intersection of two rural arterials, a turning roadway is provided for each right-turn movement. At the intersection of other functionally-classified roadways, the need for a turning roadway will be determined as required.
 - b. Urban. A turning roadway is provided at the intersection of two urban arterials if they are within the suburban or intermediate sub-classifications. Because a turning roadway requires more right of way than a simple intersection, its use will rarely be practical in a built-up area. At the intersection of other functionally-classified roadways, the need for a turning roadway will be determined as required.
2. **Speed.** A turning roadway is desirable if the turning speed is 10 mph or higher.
3. **Angle of Turn.** A turning roadway should be considered if the angle of turn is greater than 90 deg. An intersection with an angle of turn of less than 90 deg does not lend itself to the use of a turning roadway.
4. **Island Size.** If there is a significant amount of unused pavement, the designer should consider using a turning roadway. The island size should be at least 100 ft². The minimum island size in a rural area should be at least 75 ft², or in an urban area should be at least 50 ft². If the island will provide a refuge area for pedestrians, the minimum island size should be at least 160 ft².
5. **Island Type.** An island of 75 ft² or greater should be constructed as raised and corrugated, and delineated with paint or raised pavement markings, or color-contrasting pavements. An island of less than 75 ft² should only be painted.
6. **Traffic Volume.** A turning roadway should be considered if, during the design hour, there are 50 or more right-turning vehicles from a 2-lane facility or 100 or more right-turning vehicles from a 4-lane facility. The design hour is considered to be 20 years in the future.
7. **Level of Service.** Installation of a turning roadway can often improve the level of service through the intersection. At a signalized intersection, a turning roadway may significantly improve the capacity of the intersection by not requiring the right-turning vehicles to obey the signal. Level-of-service criteria are provided in the geometric-design figures in Chapters Fifty-three and Fifty-five.

8. Crash. A turning roadway should be considered if there are significant numbers of rear-end type crashes at an intersection. A turning roadway permits a vehicle to make the turning movement at a higher speed and, consequently, should reduce this type of accident.
9. Pedestrians. If pedestrian volume is high, a turning roadway provides a refuge area for a pedestrian crossing a wide intersection.
10. Truck. A turning roadway should be considered if the selected design vehicle is a semi-trailer combination.
11. Width. A turning-roadway width should not be less than 14 ft.

Figure [46-3A](#) illustrates a typical design for a turning roadway. The figure illustrates a turning roadway with a simple-curve radius with entering and exiting tapers. A turning roadway with a simple curve radius without entering and exiting tapers is also acceptable.

46-3.02 Design Criteria

46-3.02(01) Design Speed

The design speed on a turning roadway should be within 20 mph of the mainline design speed. However, a turning roadway with a low design speed (e.g., 10 mph) will still provide a significant benefit to the turning vehicle regardless of the speed on the approaching highway. The design speed for a turning roadway will therefore be in the range of 10 to 20 mph.

46-3.02(02) Width

The turning-roadway width is dependent upon the turning radius and design vehicle selected. Figure [46-1E](#) provides the criteria for selection of the appropriate design vehicle. Figure [46-3B](#) provides turning-roadway pavement width for various design vehicles based on one-lane, one-way operation with no provision for passing a stalled vehicle. The pavement width shown in Figure [46-3B](#) provides an extra 6-ft clearance beyond the design vehicle's swept path. This additional width provides extra room for maneuverability and driver variances.

In selecting the turning roadway width, the designer should also consider the possibility that a larger vehicle may also use the turning roadway. The extra 6-ft clearance shown in Figure [46-3B](#) will allow for the accommodation of the occasional larger vehicle, although at a lower speed and with less clearance. For example, a turning-roadway for a WB-50 vehicle with a 10-ft radius will still accommodate an occasional WB-62 vehicle. However, it would not accommodate a WB-65 vehicle.

If there are a significant number of larger vehicles using the turning roadway, it should be selected as the design vehicle.

A shoulder is provided on the right side of a right-turning roadway in a rural area. The width of the shoulder should be the same as the preceding mainline shoulder. However, at a restricted intersection, a narrower shoulder or none may be provided. Where a shoulder is provided, a full-depth shoulder pavement should be constructed.

Additional information on turning-roadway width can be found in AASHTO's *A Policy on Geometric Design of Highways and Streets*, such as one-lane, one-way operation with provision for passing a stalled vehicle by another of the same type, or two-lane operation).

46-3.02(03) Pavement Thickness

The entire turning-roadway width, including shoulders and curb offsets, should have a uniform pavement thickness. See Chapter Fifty-two for additional information on pavement design.

46-3.02(04) Horizontal Alignment

The horizontal alignment differs from that of the open-roadway condition, which is discussed in Chapter Forty-three. In comparison, a turning-roadway design is less restrictive, which reflects more-restrictive field conditions, and less-demanding driver expectation and driver acceptance of design limitations. The following discusses the assumptions used to design horizontal alignment for a turning roadway.

1. Curvature Arrangement. A simple curve with an entrance and exit taper is the typical curvature arrangement.
2. Superelevation. A turning roadway is relatively short in length. This greatly increases the difficulty of superelevating the roadway. Therefore, a flexible approach is used for a superelevated turning roadway. Figure [46-3C](#) provides a range of superelevation rates that the designer may select for the appropriate combination of curve radius and design speed. For a turning roadway with a design speed of 10 to 20 mph, the superelevation rate will be 2%, the normal cross slope. The maximum superelevation rate for a turning roadway should not exceed 6%. Selection of the appropriate superelevation rate will be based on field conditions.

3. Superelevation Transition. If a turning roadway is superelevated, the transition length should be in accordance with the criteria shown in Chapter Forty-three for the relative longitudinal slope. For an open roadway, the relative slope is measured between the centerline of the roadway and either pavement edge. The relative longitudinal slope is measured between the left edge of the turning roadway and the right pavement edge. For a turning roadway, the axis of rotation is about the left edge of the traveled way.

Due to the restrictive nature of a turning roadway and its short length, the minimum transition length will be determined as required. The designer should review the field conditions, deceleration and acceleration taper lengths, right-of-way restrictions, and construction costs to produce a practical design for the superelevation-transition length at a turning roadway.

4. Superelevation Development. Figure [46-3D](#) illustrates a schematic of superelevation development at a turning roadway. The actual development will depend upon the practical field conditions combined with a reasonable consideration of the theory behind horizontal curvature. The criteria to be considered are as follows.
 - a. No change in the normal cross slope is necessary up to Section B-B. Here, the width of the turning roadway is about 2 ft.
 - b. The full width of the turning roadway should be attained at Section D-D. The amount of superelevation at D-D will depend upon the practical field conditions.
 - c. Beyond Section D-D, the turning-roadway pavement should be rotated as needed to provide the required superelevation for the design speed of the turning roadway.
 - d. The minimum superelevation-transition length should meet the criteria set forth in Item 3 above.
 - e. The superelevation treatment for the exiting portion of the turning roadway should be similar to that described for the entering portion. However, for a merge at a stop-controlled intersection, the superelevation on the turning roadway should match the cross slope on the merging highway or street.

See the associated discussion shown in the AASTHO *Policy on Geometric Design of Highways and Streets* for more information regarding the specific situations as follows:

- a. turning roadway leaves a through road that is on tangent;
 - b. turning roadway and through lanes curve in same direction;
 - c. turning roadway and through lanes curve in opposite directions; and
 - d. there is a speed-change lane.
5. Minimum Radius. The minimum turning-roadway radius is based on design speed, side-friction factor, and superelevation (see Chapter Forty-three). Figure [46-3E](#) provides the minimum radius for various turning-roadway conditions. As discussed in Item 2, a range of superelevation rates is available.
6. Cross-Slope Rollover. Figure [46-3F](#) provides the maximum allowable algebraic difference in the cross slopes between the mainline and turning roadway where these are adjacent to each other. In Figure [46-3D](#), these criteria apply between Section A-A and Section D-D. This will be a factor only where a superelevated mainline is curving to the left.
7. Stopping Sight Distance. The value for stopping sight distance for the open highway condition is applicable to a turning-roadway intersection of the same design speed. The value shown in Figure 42-1A, together with the value for a design speed of 10 mph, are shown in Figure [46-3E\(1\)](#).

The sight distance should be available at all points along a turning roadway. Where practical, a longer sight distance should be provided. It applies as a control in the design of both horizontal and vertical alignments.

For a design speed lower than 40 mph, a sag vertical curve, as governed by headlight sight distance, theoretically should be longer than a crest vertical curve. Because the design speed of a turning roadway is governed by the horizontal curvature, and the curvature is relatively sharp, a headlight beam parallel to the longitudinal axis of the vehicle ceases to be a control. Where practical, a longer length for either a crest or sag vertical curve should be used.

The sight-distance control as applied to horizontal alignment has an equal, if not greater effect on design of a turning roadway than vertical control. The sight line along the centerline of the inside lane around the curve, clear of obstruction, should be such that the sight distance measured on an arc along the vehicle path equals or exceeds the stopping sight distance shown in Figure [46-3E\(1\)](#). A likely obstruction may be a bridge abutment or line of columns, wall, cut sideslope, or a side or corner of a building.

46-3.02(05) Deceleration or Acceleration Lane

A deceleration or acceleration lane is desirable where a turning roadway is used. However, it may not always be practical when considering field conditions, right-of-way restrictions, and construction costs. The following should be considered in determining the need for a deceleration or acceleration lane with a turning roadway.

1. Turning-Roadway Design Speed. The use of a deceleration or acceleration lane should be considered where the turning roadway design speed is more than 20 mph lower than that of the mainline.
2. Mainline Design Speed. A deceleration or acceleration lane should be considered if the mainline design speed is 50 mph or higher.
3. Traffic Volume. An acceleration or deceleration lane should be considered where the following conditions exist.
 - a. Two-Lane Facility. An acceleration or deceleration lane should be considered where the mainline AADT is 5000 or more and there are 75 or more turning vehicles during the design peak hour.
 - b. Four-Lane Facility. An acceleration or deceleration lane should be considered where the mainline AADT is 10,000 or more and there are 125 or more turning vehicles during the design peak hour.
4. Storage Length. A deceleration lane may be beneficial at a signalized intersection where the through-lane storage may limit access to the turning roadway. The designer should consider a deceleration lane which extends upstream beyond the storage requirements of the intersection to allow access for a right-turning vehicle into the turning roadway (see Figure [46-3G](#)).
5. Traffic Condition. An acceleration lane should be provided if the merging-traffic condition is free-flowing. An acceleration lane should not be considered for a yield- or stop-control condition.

The length of a deceleration or acceleration lane is based on the design speed of the turning roadway and the design speed of the mainline. The length should be in accordance with Section 48-4.0 for a ramp at an interchange.

46-3.02(06) Pavement Markings

Figure [46-3H](#) illustrates the pavement-marking details for a turning roadway. For additional information on pavement markings, the designer should review Chapter Seventy-six.

46-4.0 RIGHT- OR LEFT-TURN LANE

Where the turning maneuver for a left- or right-turning vehicle occurs in a through travel lane, it disrupts the flow of through traffic. To minimize potential conflicts, the use of a turn lane may be warranted to improve the level of service and safety at the intersection.

46-4.01 Turn-Lane Warrants

46-4.01(01) Warrants for a Right-Turn Lane

The use of a right-turn lane can significantly improve operations. An exclusive right-turn lane should be considered as follows.

1. at an unsignalized intersection on a 2-lane urban or rural highway which satisfies the criteria shown in Figure [46-4A](#).
2. at an unsignalized intersection on a high-speed 4-lane urban or rural highway which satisfies the criteria shown in Figure [46-4B](#);
3. at an intersection where a capacity analysis determines that a right-turn lane is necessary to meet the level-of-service criteria;
4. for uniformity of intersection design along the highway if other intersections have right-turn lanes; or
5. at an intersection where the accident experience, existing traffic operations, sight-distance restrictions (e.g., intersection beyond a crest vertical curve), or engineering judgment indicates a significant conflict related to a right-turning vehicle.

46-4.01(02) Warrants for a Left-Turn Lane

The accommodation of left turns is often the critical factor in proper intersection and median-opening design. A left-turn lane can significantly improve both the level of service and intersection safety. An exclusive left-turn lane should be provided as follows:

1. at each intersection on an arterial, where practical;
2. at each intersection on a divided urban or rural highway with a median wide enough to accommodate a left-turn lane, provided that adequate spacing exists between intersections;
3. at a unsignalized intersection on a 2-lane urban or rural highway which satisfies the criteria shown in Figure [46-4C](#), Volume Guidelines for Left-Turn Lane on a Two-Lane Highway;
4. at an intersection where a capacity analysis determines that a left-turn lane is necessary to meet the level-of-service criteria, including multiple left-turn lanes;
5. at a signalized intersection where the design-hour left-turning volume is 60 veh/h or more for a single turn lane, or where a capacity analysis determines the need for a left-turn lane;
6. for uniformity of intersection design along the highway if other intersections have left-turn lanes in order to satisfy driver expectancy;
7. at an intersection where the accident experience, traffic operations, sight distance restrictions (e.g., intersection beyond a crest vertical curve), or engineering judgment indicates a significant conflict related to left-turning vehicles; or
8. at a median opening where there is a high volume of left turns, or where vehicular speeds are 50 mph or higher.

46-4.02 Design of Left- or Right-Turn Lane

46-4.02(01) Turn-Lane Width

The width of the turn lane should be determined relative to the functional classification, urban or rural location, and project scope of work. Chapters Fifty-three and Fifty-five provide the applicable width for an auxiliary lane. Those chapters provide criteria for the applicable shoulder width adjacent to an auxiliary lane.

46-4.02(02) Turn-Lane Length

The length of a right- or left-turn lane at an intersection should allow both safe vehicular deceleration and storage of turning vehicles outside of the through lanes. However, it is often not practical to provide a turn-lane length which provides for deceleration. Therefore, the full-width length will often only be sufficient for storage.

The length of an auxiliary lane will be determined by some combination of its taper length, L_T , deceleration length, L_D , and storage length, L_S , and by the mainline functional classification. Figure [46-4H](#), Functional Length of Auxiliary Turn Lane, provides the length considerations for each functional classification. See Figure [46-4 I](#), Typical Auxiliary Lane at an Intersection. The following will apply.

1. Taper. For tangent approaches, the Department's practice is to use a 100-ft straight-line taper at the beginning of a single turn lane, or a 150-ft straight-line taper at the beginning of dual turn lanes for an urban street. On a curvilinear alignment, the entrance taper should be designed with a constant rate of divergence throughout the curve. The entrance taper length should be at least 50 ft.
2. Deceleration. For a rural facility, the deceleration distance, L_D , should meet the criteria shown in Figure [46-4J](#), Deceleration Distance for Turning Lane. The values determined from Figure [46-4J](#) should be adjusted for grades. Figure [46-4J](#) also provides the grade-adjustment factor. This distance is desirable on an urban facility. However, this is not always feasible. Under restricted urban conditions, deceleration may have to be accomplished entirely within the travel lane. For this situation, the length of turn lane will be determined solely on the basis of providing adequate vehicle storage, i.e., $L_D = 0$ ft.
3. Storage Length for Signalized Intersection. The storage length, L_S , for a turn lane should be sufficient to store the number of vehicles likely to accumulate in a signal cycle during the design hour. The following should be considered in determining the recommended storage length for a signalized intersection.
 - a. The storage length should be based on the cycle length and the traffic volumes during the design hour. For a cycle of less than 120 s, the storage length should be based on 2 times the average number of vehicles that would store during the cycle during the design hour. For a cycle of 120 s or longer, the storage length should be based on 1.5 times the average number of vehicles that would store during the cycle during the design hour. Average vehicle length is assumed to be 20 ft. At a minimum, space should be provided for two passenger cars.

- b. Figure [46-4K\(1\)](#), Recommended Storage Length for Signalized Intersection, illustrates an alternative method to determine the recommended storage length for a left-turn lane, or a right-turn lane where a turn on red is prohibited, for a signalized intersection for which the v/c ratio is known. The values obtained from the figure are for a cycle length of 75 s and a v/c ratio of 0.80. For other values, the length obtained in the figure should be multiplied by the appropriate adjustment factor shown in Figure [46-4K](#), Storage Length Adjustment Factor. The v/c ratio is determined from a capacity analysis as described in the *Highway Capacity Manual*.
 - c. Where a turn on red is permitted or where a separate right-turn signal phase is provided, the length of the right-turn lane may be reduced due to less accumulation of turning vehicles.
4. Storage Length for Unsignalized Intersection. The storage length should be sufficient to avoid the possibility of a left-turning vehicle stopping in the through lanes and waiting for a gap in the opposing traffic flow. The minimum storage length should have sufficient length to accommodate the expected number of turning vehicles likely to arrive in an average 2-min period within the design hour. At a minimum, space should be provided for two passenger cars. If truck traffic exceeds 10%, space should be provided for at least one passenger car and one truck. See Figure [46-4L](#), Recommended Storage Length (Ls) for Unsignalized Intersection.
5. Minimum Turn-Lane Length. Under restricted conditions, the minimum full-width right- or left-turn lane length, including deceleration and storage, may be 50 ft where there are less than 10% trucks, or 100 ft where there are 10% or more trucks. This is exclusive of the taper. See Item 1 above for minimum taper length.

At a signalized intersection, the right- or left-turn lane length should exceed the storage length of the adjacent through lane. Otherwise, a vehicular queue in the through lane will block entry into the turn lane for turning vehicles.

46-4.02(03) Channelized Left-Turn Lane

If a left-turn lane is required on a 2-lane highway, it should be designed as a channelized left-turn lane as illustrated in Figure [46-4M](#), Channelized Left-Turn Lane for 2-Lane Highway. As an alternative, based on site conditions and turning volume, a passing blister may be used at a T intersection. See Section [46-4.03](#).

46-4.02(04) Slotted Left-Turn Lane

On a 4-lane facility with a wide median, slotted left-turn lanes are desirable where the median width is equal to or greater than 24-ft. The advantages are as follows:

1. better visibility of opposing through traffic;
2. decreased possibility of conflict between opposing left-turning vehicles; and
3. more left-turning vehicles are served.

Figure [46-4N](#) illustrates typical parallel and tapered slotted left-turn lanes. The designer should consider the following.

1. Slot Length. The slotted section of the turn lane should be at least 50 ft long with a minimum of 100 ft. The slotted section should not include the required deceleration distance for the turn lane.
2. Nose Width. The nose of the slotted lane should be a minimum of 4 ft plus shoulder- or curb-offset width (or return taper) from the opposing through lanes. The nose position should be checked for interference with the turning paths from the cross street.
3. Slot Angle. The angle of the slot should not diverge more than 10 deg from the through mainline alignment.
4. Island. To delineate the slotted portion, the channelized island for the slotted lane should be a raised corrugated island. Raised pavement markers may be used for further delineation.

46-4.02(05) Turn-Lane Extension

On a 2-lane highway, it may be desirable to extend the right-turn lane, if provided, beyond the intersection to allow mainline vehicles to bypass left-turning vehicles on the right. See Section [46-4.03](#) for passing-blister design at a three-legged intersection. Upon determining the need for a turn lane extension, the designer should consider the following.

1. Traffic Volume. A turn-lane extension may be provided at the intersection of public road or street with a 2-lane State highway with a design-year AADT of 5000 or greater. For a 2-lane State highway with a design-year AADT of less than 5000, a turn-lane extension should be used only if one or more of the following occurs.
 - a. There is an existing turn lane extension.
 - b. There are 20 or more left-turning vehicles during the design hour.
 - c. Accident reports or site evidence, such as skid marks in the through lane displaying emergency braking, indicate potential problems with left-turning vehicles.
 - d. Shoulders indicate heavy use (e.g., dropped shoulders, severe pavement distress).
2. Scope of Work. A turn-lane extension should only be used in conjunction with a 3R or partial 3R project. For a new or reconstruction project, a channelized left-turn lane should be provided; see Figure [46-4M](#).
3. Right-Turn-Lane Warrant. A turn-lane extension may be appropriate at a four-legged intersection if a right-turn lane is not warranted.
4. Design. If designing a turn-lane extension, the designer should consider the following.
 - a. Geometrics. The beginning of the turn lane should be designed as a right-turn lane including width and length (taper, deceleration, and storage). The extension beyond the intersection should be designed as a 300-ft tapered acceleration lane; see Section [46-6.0](#). Under restricted conditions, the turn-lane extension length may be shortened to meet field conditions, but not to less than 200 ft.
 - b. Pavement. The turn lane and turn-lane extension should have the same color and pavement texture as the through lanes. The shoulder adjacent to the turn-lane extension should be of contrasting color and texture. The turn-lane extension pavement should be a full-depth shoulder with an additional 200 ft of full-depth shoulder provided after the exiting taper.
 - c. Sight Distance. Decision sight distance should be provided on the mainline to the intersection to allow a mainline driver enough time to consider whether to pass the left-turning vehicle or come to a stop. Sufficient sight distance should be available so that a side-street driver will not encroach into the auxiliary lane. A stop line should be provided to delineate the proper location for stopping.

- d. Concerns. Consideration should be given at an offset intersection to ensure that the turn-lane extension will not lead to operational problems. Distractions such as location of a drive, commercial background lighting, or highway lighting should also be considered in the design.
5. Channelized Left-turn Lane. The decision on whether to use either a channelized left-turn lane or a turn-lane extension should be based on accident history, right-of-way availability, through- and turning-traffic volumes, design speed, and available sight distance. A channelized left-turn lane should be provided if the left-turning volume is high enough that a left-turn lane is warranted as discussed in Section [46-4.01](#).

46-4.03 Passing Blister

At a three-legged intersection, it may be desirable to provide a passing blister to relieve congestion due to left-turning vehicles. The designer should review the following when determining the need for a passing blister.

1. Traffic Volume. A passing blister may be provided at the intersection of a public road or street with a 2-lane State highway with a design-year AADT of 5000 or greater. For a 2-lane State highway with a design-year AADT of less than 5000, a passing blister should be used only if one or more of the following occurs.
 - a. There is an existing passing blister.
 - b. There are 20 or more left-turning vehicles during the design hour.
 - c. Accident reports or site evidence, such as skid marks in the through lane displaying emergency braking, indicate potential problems with left-turning vehicles.
 - d. The shoulder indicates heavy use (e.g., dropped shoulder, severe pavement distress).
2. Design. Figure [46-4 O](#) illustrates and provides the design criteria for a passing blister. An alternative design should be considered if successive passing blisters overlap each other or are within close proximity to each other.

3. Channelized Left-turn Lane. The decision on whether to use either a channelized left-turn lane or a passing blister should be based on accident history, right-of-way availability, through- and turning-traffic volumes, design speed, and available sight distance. A channelized left-turn lane should be provided if the left-turning volume is high enough that a left-turn lane is warranted as discussed in Section [46-4.01](#).

46-4.04 Multiple Turn Lane

46-4.04(01) Warrants

Multiple right- or left-turn lanes should be considered as follows:

1. there is insufficient space to provide the necessary length of a single turn lane because of restrictive site conditions (e.g., closely spaced intersections); or
2. based on a capacity analysis, the necessary time for a protected left-turn phase for a single lane becomes unattainable to meet the level-of-service criteria (average delay per vehicle).

Two right-turn lanes do not function as well as two left-turn lanes because of the more restrictive turning movement for a two-abreast right turn. If practical, the designer should find an alternative means to accommodate the high number of right-turning vehicles. For example, a turning roadway may be more efficient.

At an intersection with a very high volume of turning vehicles, two right-turn lanes and three left-turn lanes may be considered. However, multiple turn lanes may cause problems with right of way, lane alignment, crossing pedestrians, and lane confusion for approaching drivers. Therefore, if practical, the designer should consider an alternative design, such as indirect left turns or an interchange.

46-4.04(02) Design

For multiple turn lanes to function properly, design elements must be evaluated. Figure [46-4P](#) illustrates both multiple right- and left-turn lanes. The designer should consider the following.

1. Throat Width. Because of the off-tracking characteristics of a turning vehicle, the normal width of two turning lanes may be inadequate to properly receive two vehicles turning abreast. Therefore, the receiving throat width may need to be adjusted. The throat width should be determined from the application of the turning template for the design vehicle (see Item 4 below).

2. Pavement Markings. As illustrated in Figure [46-4P](#), pavement markings can effectively guide two lines of vehicles turning abreast. The Office of Traffic Engineering will determine the selection and placement of pavement markings.
3. Opposing Left-Turning Traffic. If simultaneous, opposing multiple left turns will be allowed, the designer should ensure that there is sufficient space for all turning movements. This separation should be 30 ft (See Figure [46-4P](#)). Two left-turn lanes with their two-abreast vehicles can cause problems. Two turning lanes should only be used with signalization providing a separate turning phase.
4. Turning Template. The intersection-design elements for multiple turn lanes must be checked by using the applicable turning template. The designer should assume that the selected design vehicle will turn from the outside lane of the multiple turn lanes. The inside vehicle should be a single-unit truck but, as a minimum, the other vehicle can be a passenger vehicle turning side by side with the selected design vehicle.

46-5.0 TWO-WAY LEFT-TURN LANE (TWLTL)

A two-way left-turn lane (TWLTL) is a cost-effective method to accommodate a continuous left-turn demand and to reduce delay and accidents. This type of lane will often improve operations on a roadway which was originally intended to serve the through movement but now must accommodate the demand for accessibility created by changes in adjacent land use.

46-5.01 Guidelines

The following provides guidelines for where a TWLTL should be considered.

1. General. The physical conditions under which a TWLTL should be considered include the following:
 - a. an area with at least 50 drives per mile, total for both sides;
 - b. an area of high-density commercial development; or
 - c. an area with substantial mid-block left turns.

The applicability of the TWLTL is a function of the traffic conditions resulting from the adjacent land use. The designer should evaluate the area to determine the relative attractiveness of a TWLTL as compared to an alternative access technique. For example, a TWLTL may perpetuate more strip development. If this is not desirable, a raised median may be more appropriate.

2. Functional Classification. An undivided 2-lane or 4-lane urban or suburban arterial is the most common candidate for the implementation of a TWLTL. This is commonly referred to as a 3-lane or 5-lane facility, respectively. The use of a TWLTL on a 6-lane arterial (i.e., a 7-lane facility) is not appropriate. See Section [46-5.03](#).
3. Traffic Volume. Traffic volume is a significant factor in the consideration of a TWLTL. The design year which should be used to determine the traffic volume is 20 years. The following should be considered.
 - a. On an existing 2-lane roadway, a TWLTL will be advantageous for AADT between 5,000 and 12,500.
 - b. On an existing 4-lane highway, a TWLTL will be advantageous for AADT between 10,000 and 25,000.
 - c. For an AADT greater than 25,000, a raised median may be more appropriate. For a 6-lane highway, a raised median is recommended.
 - d. Pedestrian-crossing volume is also a consideration because of the large paved area which must be traversed where a TWLTL is present (i.e., no pedestrian refuge exists).
4. Speed. The design speed is a major factor in TWLTL application. A design speed of 25 to 50 mph will properly accommodate a TWLTL. For a posted speed limit higher than 50 mph, its use should be considered only as required.
5. Accident History. On a high-volume urban or suburban arterial, traffic conflicts often result because of a significant number of mid-block left turns combine with significant opposing traffic volume. This may lead to a disproportionate number of mid-block, rear-end, or sideswipe accidents. A TWLTL is likely to reduce these types of accidents. The designer should review and evaluate the available accident data to determine if unusually high numbers of these accidents are occurring.

46-5.02 Design Criteria

46-5.02(01) Lane Width

Recommended lane width is shown in Chapter Fifty-three or Fifty-five. An existing highway that warrants the installation of a TWLTL is often located in an area of restricted right of way, so conversion of the existing cross section may be difficult. To obtain the TWLTL width, the designer may have to consider the following:

1. removing an existing raised median;
2. reducing the width of existing through lanes;
3. reducing the number of existing through lanes;
4. eliminating an existing parking lane;
5. eliminating or reducing the width of an existing shoulder; or
6. acquiring additional right of way to expand the pavement width by the amount needed for the TWLTL.

Item 1 or 6 listed above would be the most advantageous alternative. If this is not practical, the designer will have to evaluate the trade-offs between the benefits of the TWLTL and the negative impacts of eliminating or reducing the width of one or more existing cross-section elements. This may involve a capacity analysis or an in-depth evaluation of the existing accident history.

46-5.02(02) Intersection Treatment

A TWLTL must either be terminated in advance of an intersection to allow the development of an exclusive left-turn lane or be extended up to the intersection. Where the TWLTL is extended up to the intersection, the pavement marking will switch from two opposing left-turn arrows to one left-turn arrow only. In determining the intersection treatment, the following should be considered.

1. Signalization. The TWLTL should be terminated, as this type of intersection will warrant an exclusive left-turn lane. At an unsignalized intersection, the TWLTL may be extended through the intersection because an exclusive left-turn lane is usually not required.

2. Turning Volume. The left-turn demand into the intersecting road is a factor in determining the proper intersection treatment. If the minimum storage length will govern (Section [46-4.02](#)), it will probably be preferable to extend the TWLTL up to the intersection (i.e., provide no exclusive left-turn lane).
3. Minimum Length of TWLTL. The TWLTL should have sufficient length to operate properly. The type of intersection treatment will determine the length of the TWLTL. The appropriate minimum length is influenced by the operating speed on the highway. The following guidance may be used.
 - a. On a facility where $V \leq 30$ mph, the minimum uninterrupted length of a TWLTL should be 500 to 1000 ft.
 - b. On a facility where $V > 30$ mph, the minimum uninterrupted length of a TWLTL should be at least 1000 ft.

The final decision on the length of the TWLTL will be based on site conditions.

4. Operational or Safety Factors. Extending the TWLTL up to an intersection could result in operational or safety problems. A driver may, for example, pass through the intersection in the TWLTL and turn left just beyond the intersection into a drive which is within 30 ft of the intersection. If operational or safety problems are known or anticipated at an intersection, it may be preferable to remove the TWLTL prior to the intersection (i.e., provide an exclusive left-turn lane).
5. Pavement Markings. Figure [46-5A](#) illustrates the typical pavement markings for a TWLTL at an unsignalized or signalized intersection. Chapter Seventy-six provides additional information for marking a TWLTL.

46-5.03 6-Lane Section

For AADT greater than 25,000, the designer should use a 6-lane section with a raised median. The decision on whether to provide a TWLTL instead of a raised median will be determined as required for the project. The following lists the factors the designer should consider in making this determination.

1. A TWLTL tends to be safer under the existing or proposed conditions as follows:
 - a. at least 70 drives per mile;
 - b. fewer than 2 signalized intersections per mile; and
 - c. a maximum of 4 to 6 approaches per mile, depending on the number of signals per mile.
2. There may be insufficient gaps available in the oncoming traffic to allow a vehicle to make a left turn from the TWLTL in an acceptable period of time.
3. A left-turning vehicle from a roadside drive may try to use the TWLTL as an acceleration lane or as a waiting area before merging in with the mainline traffic.
4. There may be significant delays at a signal to handle crossing pedestrians with a TWLTL. A raised median may be able to provide a refuge area for crossing pedestrians.
5. At a signalized intersection requiring two turn lanes, it will be more difficult to develop the additional lane with a TWLTL. There may be more lane confusion at the intersection for the approaching driver.
6. A raised median forces a driver to make all left turns at intersections, which may overload the capacity of the intersection and increase driver travel time.
7. With a raised median, the left-turn movements are concentrated at the intersections, thereby reducing the conflict area of the overall facility.
8. A raised median may discourage patrons from using facilities on the other side of the road (e.g., gas station, convenience store, restaurant).
9. A raised median discourages new strip development, whereas a TWLTL may encourage such development.

46-6.0 INTERSECTION ACCELERATION LANE

It may be necessary to provide an acceleration lane for turning vehicles at an intersection to allow these vehicles to accelerate before merging with the through traffic.

46-6.01 Acceleration Lane for Right-Turning Vehicle

An acceleration lane should be considered as follows:

1. where the intersection is near or at capacity (LOS of E) in the design year;
2. where a turning roadway is used (see Section [46-3.0](#));
3. where the turning traffic at an unsignalized intersection must merge with a high-speed, high-volume facility;
4. where there is a significant history of rear-end or sideswipe accidents;
5. where there is inadequate intersection sight distance available; or
6. where there is a high volume of trucks turning onto the mainline.

46-6.02 Acceleration Lane in Median

An acceleration lane should be considered for left-turning vehicles as follows:

1. where the turning traffic at an unsignalized intersection must merge with a high-speed, high-volume facility. The acceleration lane may reduce the need for a signalized intersection;
2. where there is a significant history of rear-end or sideswipe accidents;
3. where there is inadequate intersection sight distance available; or
4. where there is a high volume of trucks turning onto the mainline.

46-6.03 Design Criteria

1. **Types.** An acceleration lane is of the parallel design. Chapter Forty-eight provides additional information.
2. **Length.** A right-turn or median acceleration lane should be in accordance with Chapter Forty-eight. The controlling curve at an intersection is the design speed of the turning roadway or the speed at which a vehicle can make the right or left turn, usually less than 10 mph. For a 2-lane mainline, the truck acceleration length should be considered where there are 20 to 50 or more turning trucks per day. For a 4-lane facility, it should be considered where there are 75 to 100 or more turning trucks per day.
3. **Taper.** A 300-ft taper should be used at the end of a parallel acceleration lane.

46-7.0 ADDITIONAL THROUGH LANE AT INTERSECTION

To meet the level-of-service criteria for the design year, it may be necessary to add at least one through lane to an intersection approach. However, an additional lane should be extended beyond the intersection to fully realize the capacity benefits. Figure [46-7A](#) provides criteria for determining how far such a lane should be extended beyond the intersection.

The minimum full-width length of the through lane extension, D_E , is that distance needed for the stopped vehicle to accelerate to 5 mph below the average running speed of the highway. The full-width length of the through-lane extension will be the stored-vehicle length which will cross the intersection during a green cycle.

The length shown in Figure [46-7A](#) may or may not be sufficient for the vehicle to merge into the primary through lane. Therefore, Figure [46-7A](#) should only be used for preliminary design purposes. The final design will be based on site conditions and traffic volume.

The taper rate at the end of the additional through lane will be based on the criteria provided in Figure [46-7A](#). If curbing is used within the taper area, the curbing should be painted to provide better delineation of the taper.

46-8.0 MEDIAN OPENING

46-8.01 Non-Freeway

46-8.01(01) Warrants

A median opening should be provided on a divided non-freeway at each intersection with a public road or major traffic generator (e.g., shopping center). However, this may result in close intersection spacing which impairs the operation of the facility. The following minimum spacings should be evaluated when determining the warrant for a median opening.

1. Rural Intersection. An opening is provided at each public-road intersection. An opening may not be provided at a minor public road.
2. Urban Intersection. A median opening is provided at each intersection. However, to improve capacity and traffic efficiency, the designer may elect not to provide an opening for a traffic generator if there are other points of access within a reasonable distance of the generator.

The minimum spacing between median openings should be 400 ft. The desirable spacing should be 800 ft. See Figure [46-8A](#). This allows for the development of a future exclusive left-turn lane with the proper taper, deceleration, and storage length.

If determining the median-opening location, the designer also needs to consider the available sight distance (see Section [46-10](#)). An opening with restricted sight distance may require additional design considerations (e.g., traffic signal, closing the opening).

46-8.01(02) Design

Figure [46-8B](#) illustrates the turning path for a semi-trailer design vehicle and other design criteria at a median opening. The following will apply.

1. Design Vehicle. The path of each design vehicle making a minimum left turn at 10 to 20 mph should be considered. Where the volume and types of vehicles making the left-turn movement require a speed higher than the minimum, the radius of turn should correspond to the speed deemed appropriate. However, the minimum turning path at low speed is required for minimum design, and for testing a layout developed for one design vehicle when used by an occasional larger vehicle.

2. Radius. The following control radius should be used for the design of a median opening.
 - a. 40 ft. Accommodates a P vehicle and an occasional SU vehicle sometimes swinging wide.
 - b. 50 ft. Accommodates an SU vehicle and an occasional WB-40 vehicle sometimes swinging wide.
 - c. 75 ft. Accommodates a WB-40 or WB-50 vehicle with only minor swinging at the end of the turn.

3. Encroachment. The design should be to allow the design vehicle to make a left turn and remain entirely within the inside travel lane of the divided facility (i.e., there will be no encroachment into the through lane adjacent to the inside travel lane). It will be acceptable for the design vehicle to occupy both travel lanes in its turn.

4. Width. The median width will be determined by the design of the major highway and the available right of way. The designer should consider the following:
 - a. If practical, the median width at the intersection should be wide enough to fully protect a stopped passenger car within the median.
 - b. A slotted left-turn lane may be used with a median width greater than 24 ft; see Section [46-4.02\(04\)](#).
 - c. The median width should be wide enough to accommodate a left-turn bay and, where necessary, a two-left-turn-lanes bay.

5. Median-Nose Design. The median nose will have either a semicircular end or a bullet-nose end. The median-nose design selection is dependent upon the median-opening function and the median width. The INDOT *Standard Drawings* illustrate the layout for a median nose.

6. Length of Opening. The length of a median opening should properly accommodate the turning path of the design vehicle. The minimum median-opening length is 40 ft. It should be as great as the width of crossroad's traveled way plus its shoulders. If the crossroad is a divided highway, the length of opening should be at least equal to the width of the crossroad's traveled way plus that of the median. However, each median opening should be evaluated individually to determine the proper length of opening. Figures [46-8C](#), [46-8D](#), and [46-8E](#) illustrate median-opening criteria for various design vehicles. The designer should consider the following in the evaluation.

- a. **Turning Template.** The designer should check the proposed design with the turning template for the design vehicle most likely to use the intersection. Consideration should be given to the frequency of the turn and to the encroachment onto adjacent travel lanes or shoulders by the turning vehicle.
- b. **Nose Offset.** At a 4-leg intersection, traffic passing through the median opening (going straight) will pass the median nose. To provide a sense of comfort for such a driver, the offset between the nose and the through travel lane (extended) should be at least 2 ft.
- c. **Lane Alignment.** The designer should ensure that lanes line up properly for crossing traffic.
- d. **Location of Crosswalk.** A pedestrian crosswalk will intersect the median nose to provide some refuge for pedestrians. Therefore, the median-opening design should be coordinated with the location of the crosswalk.

A median opening longer than 80 ft should be avoided, regardless of skew.

7. **U-turn.** A median opening is sometimes used only to accommodate a U-turn on a divided non-freeway. Where needed, the spacing should be 1300 to 2500 ft. The design for a U-turn maneuver on an arterial should permit the design vehicle to turn from an auxiliary left-turn lane in the median into the lane next to the outside shoulder or outside curb and gutter on the roadway of the opposing traffic lanes. The INDOT *Standard Drawings* provide additional information on the Department's U-turn median-opening.
8. **Pavement.** The median-opening pavement will be the same material type and design strength as the adjacent mainline. Chapter Fifty-two provides additional information on pavement design.
9. **Drainage.** The designer should ensure that drainage from the mainline is not allowed to flow or pond within the median opening. See Part IV for INDOT roadway drainage criteria.

10. Skew. A control radius for the design vehicle as the basis for the minimum design of a median opening results in a length of opening that increases with the skew angle of the intersection. The skew introduces other variations in the shape of the nose. At a skewed crossing, such control radius should be used in the acute angle used to locate the beginning of the nose on the median edge.

A channelization lane, left-turn lane, or adjustment to reduce the crossroad skew may be required to limit the opening to the maximum length shown in Item 6 above. An asymmetrical bullet nose is preferable.

46-8.02 Median Opening on Freeway

On a fully-access-controlled freeway, median crossing is denied to the public. However, an occasional median opening or emergency crossover is required to accommodate a maintenance or emergency vehicle. Section 54-6.0 provides the Department's criteria for a median opening on a fully-access-controlled facility.

46-9.0 CHANNELIZING ISLAND

The treatments described in this Chapter may require a channelizing island within the intersection area (e.g., turning roadway). The design of an island should consider site-specific functions, including definition of vehicular path, separation of traffic movements, prohibition of movements, protection of pedestrians, and placement of traffic control devices.

46-9.01 Types of Islands

Islands are grouped into the following functional classes. Most islands serve at least two of these functions.

1. Directional Island. A directional island (e.g., for turning roadways) controls and directs traffic movements and guides the driver into the proper channel.
2. Divisional Island. A divisional island separates opposing traffic flows, alerts the driver to the crossroad ahead, and regulates traffic through the intersection. Such an island is introduced at an intersection on an undivided highway, and is particularly advantageous in controlling left turns at a skewed intersection.

3. Refuge Island. A refuge island at or near a crosswalk aids or protects a pedestrian crossing a wide roadway. Such an island may be required for a pedestrian where complex signal phasing is used.
4. Protection Island. A protection island is used for the protection of a traffic control device.

46-9.02 Selection of Island Type

A channelizing island may be a combination of flush or raised; concrete, asphalt, or earth; or triangular or elongated. Selection of an appropriate type of island should be based on traffic characteristics, cost considerations, and maintenance needs. The following offers guidance as to where a flush or raised corrugated island is appropriate.

A flush island is appropriate as follows:

1. on a high-speed rural highway to delineate separate turning lanes;
2. in a constrained location where vehicular path definition is desired, but space for a larger, raised island is not available;
3. to separate opposing traffic streams on a low-speed street; or
4. for temporary channelization either during construction or to test traffic operations prior to installation of a raised island.

A raised corrugated island is appropriate as follows:

1. where a primary function of the island is to provide a pedestrian refuge;
2. where a primary or secondary island function is the location of a traffic signal, sign, or other fixed object;
3. where the island is intended to prohibit or prevent a traffic movement;
4. on a low- to moderate-speed highway where the primary function is to separate high volumes of opposing traffic movements; or
5. at a location requiring positive delineation of vehicular path, such as at a major-route turn or an intersection with unusual geometry.

A channelizing island with curbs should not be used.

46-9.03 Minimum Size

An island should be large enough to command the driver's attention. Island shapes and sizes vary from one intersection to another. For a triangular island, the minimum size is 50 ft² (urban) or 75 ft² (rural). Its area should be at least 100 ft². An island used for pedestrian refuge should be at least 150 ft². An elongated island should not be less than 4 ft wide, and should be 20 to 26 ft long. Where space is limited, an elongated island may be reduced to a minimum width of 2 ft. A curbed divisional island introduced at an isolated intersection on a high-speed highway should be at least 100 ft in length.

46-9.04 Delineation

Delineation of a small island is effected primarily by a curb. A large curbed island may be sufficiently delineated by color and texture contrast of vegetative cover, mounded earth, shrubs, reflector posts, or a combination of these. In a rural area, an island curb should be sloping. A vertical or sloping curb may be appropriate in an urban area, depending on the conditions.

A channelizing island should be delineated based on its size, location, and function. An island with raised corrugations presents the most positive means of delineation and may be used with any design speed. For the layout of a raised corrugated island, see the *INDOT Standard Drawings*. For a flush island, it may be appropriate to complement the pavement markings with raised reflectors.

Raised pavement markings, raised reflectors, roughened pavement, or paint striping is used in advance of and around the island to warn the driver. These traffic control devices are important at the approach to a divisional curbed island for the direction of approaching traffic. Figures [46-9A](#) and [46-9B](#) illustrate the pavement markings used with a channelizing island. Section 502-2.08 provides additional information for pavement markings around an island.

46-9.05 Island Offset to Through Lanes

In an urban area on an approach roadway without shoulders, the raised corrugated island should be offset 2 ft from the travel lane. Where shoulders are present, the raised corrugated island should be offset a distance equal to the shoulder width. In a rural area or where a separate turning lane is used, the island should be offset from the turning lane by 2 ft (see Figure [46-9A](#)). If there is no turning lane, the island should be offset a distance equal to the shoulder width. If a corner island is preceded by a right-turn deceleration lane, the shoulder offset should be at least 8 ft.

The designer should also ensure that the island will not interfere with the turning movement of a truck turning from the opposite side on a 4-legged intersection. If there is a conflict, the island should be set back farther or made flush.

46-9.06 Typical Channelizing Intersection

Figure [46-9C](#) illustrates an example of an island treatment at an intersection. Each channelizing intersection must be studied individually considering turning volumes, traffic lane configurations, potential conflicts, and practical signing arrangements.

46-10.0 INTERSECTION SIGHT DISTANCE (ISD)

For an at-grade intersection to operate properly, adequate sight distance should be available. The designer should provide sufficient sight distance for a driver to perceive potential conflicts and to perform the actions needed to negotiate the intersection safely.

The additional costs and impacts of removing sight obstructions are often justified. If it is impractical to remove an obstruction blocking the sight distance, the designer should consider providing traffic-control devices or applications (e.g., warning signs, traffic signals, or turn lanes) which may not otherwise be warranted.

The height of eye for a passenger car driver should be taken as 3.5 ft. The height of eye for a single-unit or combination-truck driver should be taken as 7.6 ft. Its height of object should be taken as 3.5 ft.

The sight line is shown on the plans in the plan and profile views. The proposed profile grade line along the centerline is also shown, however, this is meaningless for intersection sight distance analysis. The proposed ground line under the sight line is the relevant line.

**** PRACTICE POINTER ****

Intersection sight distance should be analyzed for each local service road or frontage road in the same manner as a public road.

46-10.01 No Traffic Control

An intersection between a low-volume and a low-speed road or street should be either yield-controlled or stop-controlled. However, for a local-road or -street intersection with no traffic control, sufficient corner sight distance should be available to allow an approaching vehicle to see a potentially conflicting vehicle in sufficient time to stop before reaching the intersection. Figure [46-10A](#) provides the ISD criteria for an intersection with no traffic control and approach grades between -3% and +3%. For approach grades greater than 3%, multiply the sight distance value in Figure [46-10A](#) by the appropriate adjustment factor from Figure [46-10B](#). These Figures are not applicable to State highways.

If the appropriate sight distance cannot be provided, consideration should be given to installing a “Stop” sign on one or more approaches.

46-10.02 Yield Control

46-10.02(01) Intersection With Yield Control on the Minor Road

A driver approaching a Yield sign is permitted to enter or cross the major road without stopping, if there is no potentially conflicting vehicle on the major road. The sight distance needed by a driver on a yield-controlled approach exceeds that for a stop-controlled approach.

A yield-controlled approach needs greater sight distance than a stop-controlled approach, especially at a four-leg yield-controlled intersection where the sight distance needs of the crossing maneuver should be considered. If sight distance sufficient for yield control is not available, use of a “Stop” sign instead of a “Yield” sign should be considered. At a location where the recommended sight distance cannot be provided, consideration should be given to installing other traffic control devices at the intersection on the major road to reduce the speeds of approaching vehicles.

46-10.02(02) Left- or Right-Turn Maneuver

The length of the leg of the approach sight triangle along the minor road to accommodate a left or right turn without stopping should be 80 ft. This distance is based on the assumption that a driver making a left or right turn without stopping will slow to a turning speed of 10 mph.

The leg of the approach sight triangle along the major road is similar to the major-road leg of the departure sight triangle for a stop-controlled intersection. However, the time gap for a left turn, as shown in Section [46-10.03](#) should be increased by 0.5 s to the value shown in Figure [46-10C](#). The appropriate length of the sight triangle leg is shown in Figure [46-10D](#) for a passenger car. The minor-road vehicle needs 3.5 s to travel from the decision point to the intersection. This represents additional travel time that is needed at a yield-controlled intersection, but is not needed at a stop-controlled intersection. However, the acceleration time after entering the major road is 3.0 s less for a yield condition than for a stop condition because the turning vehicle accelerates from 10 mph rather than from a stop condition. The net 0.5-s increase in travel time for a vehicle turning from a yield-controlled approach is the difference between the 3.5-s increase in travel time and the 3.0-s reduction in travel time.

A departure sight triangle like that provided for a stop-controlled approach should also be provided for a yield-controlled approach to accommodate a minor-road vehicle that stops at the “Yield” sign to avoid a conflict with a major-road vehicle. However, because the approach sight triangle for a turning maneuver at a yield-controlled approach is larger than the departure sight triangle used at a stop-controlled intersection, no specific check of departure sight triangle at a yield-controlled intersection should be needed.

A yield-controlled approach needs greater sight distance than a stop-controlled approach, especially at a four-leg yield-controlled intersection where the sight distance needs of the crossing maneuver should be considered. If sight distance sufficient for yield control is not available, use of a “Stop” sign instead of a “Yield” sign should be considered. At a location where the recommended sight distance cannot be provided, consideration should be given to installing other traffic control devices at the intersection on the major road to reduce the speeds of approaching vehicles.

46-10.02(03) Turning Roadway

Yield control may also exist, for example, at a freeway ramp terminal where the ramp traffic is provided a free-flowing right turn onto the minor road. The assumptions as discussed in Section [46-10.02\(01\)](#) are also applicable to turning-roadway yield conditions, except the eye location of the entering vehicle is on the turning roadway itself (see Figure [46-10E](#)).

If insufficient intersection sight distance is available for the operational characteristics of yield control, it may be appropriate to convert the intersection to stop control.

46-10.03 Stop Control

Where traffic on the minor road of an intersection is controlled by a “Stop” sign, the driver of the vehicle on the minor road must have sufficient sight distance for a safe departure from the stopped position assuming that the approaching vehicle comes into view as the stopped vehicle begins its departure. The location of the eye should be as described in Section [46-10.03\(01\)](#).

46-10.03(01) Departure Sight Triangle and Time Gap

The departure sight triangle for an intersection with stop control on the minor road must consider the situations as follows:

1. left turn from the minor road;
2. right turn from the minor road; and
3. crossing the major road from minor-road approach.

A departure sight triangle for traffic approaching from either the right or left, like that shown in Figure [46-10E](#), Departure Sight Triangles, should be provided for a left turn from the minor road onto the major road for each stop-controlled approach.

Field observations of the gaps in major-road traffic actually accepted by drivers turning onto the major road have shown that the values shown in Figure [46-10G](#), Intersection Sight Distance for Stop-Controlled Intersection, provide sufficient time for the minor-road vehicle to accelerate from a stop and complete a left turn without unduly interfering with major-road traffic operations.

The intersection sight distance in both directions should be equal to the distance traveled at the design speed of the major road during a period of time equal to the time gap. At a minimum, ISD should be checked for both a passenger car and a single unit truck turning from the minor-road approach. Where a substantial volume of heavy vehicles enter the major road, the use of combination trucks should be considered.

No adjustment is needed for the major-road grade. However, if the minor-road design vehicle is a truck and the intersection is located near a sag vertical curve with a grade over 3%, an adjustment of the intersection sight distance should be considered.

Figure [46-10G](#) provides the criteria for intersection sight distance in both directions for a vehicle turning left.

Intersection sight distance for a left turn at a divided-highway intersection should consider multiple design vehicles and median width. If the design vehicle used to determine sight distance for a divided-highway intersection is larger than a passenger car, sight distance for a left turn will need to be checked for that selected design vehicle and for smaller design vehicles as well. If the divided-highway median is wide enough to store the design vehicle with a clearance to the through lanes of 3 ft at both ends of the vehicle, no separate analysis for the departure sight triangle for a left turn is needed on the minor-road approach for the near roadway to the left.

If the design vehicle can be stored in the median with adequate clearance to the through lanes, a departure sight triangle to the right for a left turn should be provided for that design vehicle turning left from the median roadway. Where the median is not wide enough to store the design vehicle, a departure sight triangle should be provided for that design vehicle to turn left from the minor-road approach. The median width should be considered in determining the number of lanes to be crossed. The median width should be converted to an equivalent number of lanes.

The sight triangle for a left or right turn onto the major road will also provide more than adequate sight distance for a minor-road vehicle to cross the major road. However, the intersection sight distance for a crossing maneuver must be checked for the situations as follows:

1. where left or right turns are not permitted from a particular approach and the crossing maneuver is the only legal maneuver;
2. where the crossing vehicle would cross the equivalent width of more than 6 lanes; or
3. where a substantial volume of heavy vehicles cross the highway, and steep grades that might slow such vehicles while their back portions are still in the intersection are present on the departure roadway on the far side of the intersection.

The time gap shown in Figure [46-10H\(1\)](#), Time Gap for Crossing Maneuver, may be used for the crossing-maneuver check.

Figure [46-10H](#), Intersection Sight Distance for Passenger Car to Turn Right provides the intersection sight distance for a passenger car making a right turn from a stop or a crossing maneuver.

At a divided-highway intersection, depending on the median width and the length of the design vehicle, intersection sight distance may need to be considered for crossing both roadways of a divided highway or for crossing the near lanes only and stopping in the median before proceeding.

The ISD value will establish one leg of the sight triangle which needs to be visible to the entering vehicle. The leg on the stop-controlled road or street will be determined by the assumed location of the eye. This is established as 18 ft behind the edge of the travel lane for a new or reconstruction project, or 14.5 ft for a 3R project (see Figure [46-10F](#), Departure Sight Triangle).

46-10.03(02) Measures to Improve Intersection Sight Distance

The available ISD should be checked using the parameters described above. If the line of sight falls above a bridge railing and guardrail and the ISD value from Figure [46-10G](#) is provided, no further investigation is needed. If the line of sight is restricted by the bridge railing, guardrail, or other obstruction, or the horizontal and vertical alignment of the major road and the ISD value is not available, one or more of the modifications, or a combination of them, should be evaluated to achieve the intersection sight distance as follows:

1. relocate the minor road or drive farther from the end of the bridge;
2. widen the structure on the side where the railing is restricting the line of sight;
3. flare the approach guardrail;
4. revise the grades on the major road or the minor road or drive;
5. remove the obstruction that is restricting sight distance;
6. close the minor road or drive;
7. make the minor road or drive one-way away from the major road; or
8. review other measures that may be practical at a particular location.

If intersection sight distance along the major road cannot be achieved, consideration should be given to installing advance intersection signing with advisory speed plates.

46-10.04 Left Turn From the Major Road

Each location along the major road from which a vehicle is permitted to turn left across opposing traffic, including an intersection or drive, should have sufficient sight distance to accommodate the left-turn maneuver. A left-turning driver needs sufficient sight distance to decide when it is safe to turn left across the lanes used by opposing traffic. Sight distance design should be based on a left turn by a stopped vehicle, since a vehicle that turns left without stopping would need less sight distance. The sight distance along the major road to accommodate a left turn is the distance traversed at the design speed of the major road in the travel time for the design vehicle shown in Figure [46-10I](#).

The figure also includes appropriate adjustment factors for the number of major-road lanes to be crossed by the turning vehicle. The unadjusted time gap shown in Figure [46-10I](#) for a passenger car was used to develop the sight distance shown in Figure [46-10J](#).

If stopping sight distance has been provided continuously along the major road and if sight distance for stop control or yield control has been provided for each minor-road approach, sight distance will be adequate for a left turn from the major road.

However, at a three-leg intersection located on or near a horizontal curve or crest vertical curve on the major road, the availability of adequate sight distance for a left turn from the major road should be checked. The availability of sight distance for a left turn from a divided highway should be checked because of the possibility of a sight obstruction in the median.

At a 4-leg intersection on a divided highway, an opposing vehicle turning left can block a driver's view of oncoming traffic. The designer should consider offsetting the opposing left-turn lanes and providing a left-turning driver with a better view of oncoming traffic.

46-10.05 Signal-Controlled Intersection

If a vehicle is allowed to turn right on red, or left from a one-way street onto a one-way street, after stopping, the minimum ISD requirement shown in Figure [46-10H](#) will apply to a signalized intersection. If this criterion cannot be met, consideration should be given to prohibiting right-turn-on-red at the intersection. This determination will be based on a field investigation and will be determined as required for each intersection leg. Changing right-turn-on-red regulations at an intersection will require an official action by State or local officials.

If the signal is to be placed on two-way flashing operation (i.e., flashing yellow on the major-road approaches and flashing red on the minor-road approaches) during off-peak or nighttime conditions, the appropriate departure sight triangle for stop control, both to the left and to the right, should be provided for the minor-road approaches (See Section [46-10.03](#)).

46-10.06 Effect of Skew

Where two highways intersect at an angle of less than 60 deg, some of the factors for determination of intersection sight distance may need adjustment.

Each of the clear-sight triangles described above is applicable to an oblique-angle intersection. As shown in Figure [46-10K](#), the leg of the sight triangle will lie along the intersection approach, and each sight triangle will be larger or smaller than the corresponding sight triangle would be at a right-angle intersection. The area within each sight triangle should be clear of potential sight obstructions.

At an oblique-angle intersection, the length of the travel path for some turning and crossing maneuvers will be increased. The actual path length for a turning or crossing maneuver may be computed by dividing the total of the widths of the lanes (plus the median width, where appropriate) to be crossed, by the sine of the intersection angle. If the actual path length exceeds the total of widths of the lanes to be crossed by 12 ft or more, an appropriate number of additional lanes should be considered in applying the adjustment for the number of lanes to be crossed (See Section [46-10.03](#)). For a crossing maneuver from a minor road with yield control, the w term in the equation for the major-road leg of the sight triangle to accommodate the crossing maneuver should also be divided by the sine of the intersection angle to obtain the actual path length. In the obtuse-angle quadrant of an oblique-angle intersection, the angle between the approach leg and the sight line may be so small that a driver can look across the full sight triangle with only a minor head movement. However, in the acute-angle quadrant, a driver is often required to turn his or her head considerably to see across the entire clear-sight triangle. The sight distance criteria for an intersection with no control should therefore not be applied to an oblique-angle intersection. Sight distance at least equal to that for an intersection with stop control on the minor road should be provided, where practical.

46-11.0 DRIVE DESIGN

46-11.01 General Information

46-11.01(01) Definitions of Drives and Types

The definitions of types and classes of drives are as follows:

1. **Residential.** A residential drive provides access to a single-family residence, duplex, or apartment building with not more than four dwelling units. A residential drive along a roadway with a raised curb is a class I drive. A residential drive along a roadway with a paved or unpaved shoulder and no raised curb is a class II drive.
2. **Commercial.** A commercial drive provides access to an office, retail, or institutional building, or to an apartment building with five or more dwelling units. A drive which serves an industrial plant, but with a primary function to serve an administrators' or employees' parking lot, is considered to be a commercial drive. A commercial drive along a roadway with a raised curb is a class III drive. A commercial drive along a roadway with a paved or unpaved shoulder and no raised curb is a class IV drive.

3. Industrial. An industrial drive directly serves substantial numbers of truck movements to and from loading docks of an industrial facility, warehouse, or truck terminal. A centralized retail development, such as a community or regional shopping center, may have one or more drives especially so designed, signed, and located to provide access for trucks. This is also classified as an industrial drive. An industrial drive may be designed either as a public road approach or as an industrial drive. An industrial drive along a roadway with a raised curb is a class VII drive. An industrial drive along a roadway with a paved or unpaved shoulder and no raised curb is a class VI drive.
4. Field Entrance. A field entrance provides access to an unimproved property, e.g., a farm field with no buildings. Such a drive along a roadway with a paved or unpaved shoulder is a class V drive.

46-11.01(02) Drive Spacing and Corner Clearance

Closely-spaced drives can cause operational problems, especially with a high-volume roadway or a high-volume drives. These problems can also result if a drive is too close to an at-grade intersection.

Any part of a drive, including its entrance radius, should not be placed within the radius of a public road at an intersection, including any auxiliary lanes. Preferably, there should be a 20- to 40-ft tangent section between the drive radius and the public-road radius for greater separation. If this criterion cannot be met for a property at an intersection corner, one solution may be to relocate the drive entrance from the major road to the minor road, if practical. Another possible solution is to provide a right-turn lane at the intersection. This will improve the operation of the intersection by removing the turning vehicles for the drive and intersection out of the through travel lane(s). However, a significant number of turning vehicles may impair egress from the property.

Drives for the same owner should be located across from each other (e.g., a farm) where crossing traffic is significant or where it is not desirable to permit slow or large equipment to travel along the highway or shoulder.

46-11.01(03) Drive Sight Distance

Section [46-10.0](#) discusses intersection sight distance (ISD) criteria for an intersection with a public road. These criteria will also apply to sight distance at a drive. However, for a drive with low traffic volume, it is not warranted to explore extraordinary measures to improve sight distance. Each sight obstruction, e.g., large tree, hedgerow, etc., should be checked for in the vicinity of the drive entrance which may limit sight distance. To perform the check, it is reasonable to assume an eye location of approximately 10 ft from the edge of travel lane.

If drive sight-distance criteria with the eye location described above cannot be met, informal notification should be provided to the project reviewer for a consultant-designed project or to the supervisor for an in-house project.

46-11.01(04) Auxiliary Lane

A deceleration or acceleration lane should be considered at each high-volume drive entrance, especially on a high-speed, high-volume arterial. Sections [46-4.0](#) and [46-7.0](#) further discuss the design and warrants for such an auxiliary lane, which may also apply to a high-volume drive. In addition to traffic-volume considerations, it may be warranted to provide a right-turn lane into the drive if the change in grade is abrupt at the drive entrance.

46-11.01(05) Joint Residential or Commercial Drive

If practical and agreeable to the property owners, the use of a joint drive offers one option to reduce the number of access points along the highway. The centerline of the joint drive should be located on the property line dividing the two owners. This practice will not allow either owner the opportunity to deny or restrict access to the neighbor's property and, depending on the traffic volume, may improve the traffic flow on the mainline. For a commercial drive, this may require providing a drive wide enough to handle two-way traffic.

46-11.02 Design Criteria

The INDOT *Standard Drawings* provide the Department's layout criteria for each drive class. In addition, the following should be considered.

46-11.02(01) Class Determination Considerations

1. If it is determined from the survey or at the field inspection that a field entrance serves a barn or storage shed for farm machinery, it should be designed as a class II drive with a 24-ft minimum width instead of a class V drive.
2. Where there are positive indications that a private residence is being used for commercial purposes, the drive should be designed as a commercial drive.

46-11.02(02) Radii

1. Radii for a Class II or class IV drive should start from the edge of the paved shoulder if the width of the paved shoulder is 8 ft or greater.

2. Radii for a Class II or class IV drive should start from the edge of the traveled way if the width of the paved shoulder is less than 8 ft.
3. Class VI drive tapers should start from the edge of the traveled way without regard to the shoulder's width or whether or not the shoulder is paved.

46-11.02(03) Width

1. Drive width should be measured perpendicular to the centerline of the drive.
2. For each new drive constructed where no drive currently exists, the minimum width shown on the INDOT *Standard Drawings* should be used, unless determined otherwise at the field inspection or if the Office of Real Estate recommends a wider drive.
3. The width of a reconstructed drive should be the same as the existing width but not less than the minimum width nor greater than the maximum width shown on the INDOT *Standard Drawings*.
4. Each drive that serves a barn or storage shed for farm equipment should be a minimum of 24 ft in width.

46-11.02(04) Drive Grade [Rev. Mar. 2016]

For a class I, III, VI, or VII drive, the maximum algebraic difference in drive grades should not exceed 8% for a crest vertical curve, or 12% for a sag vertical curve. For a class II, IV, or V drive, the maximum algebraic difference in drive grades should not exceed 11% for a crest vertical curve, or 14% for a sag vertical curve.

If it is known that a large emergency vehicle or other large vehicle will be using a drive, or if the algebraic differences exceed those noted above, the fit of the drive grade should be checked against the vehicle templates.

Drive grades should be shown and drive PVIs should be identified on the cross-sections sheets.

Where a drive is intersected by a sidewalk, the maximum drive grade is 2% for the width of the sidewalk. The preferred grade is 1.50% and should be used as a design practice to reduce the likelihood of the maximum being exceeded during construction. See Section 46-11.02(07) for additional information.

46-11.02(05) Grading

A drive's embankment slope within the mainline clear zone should be as shown in Figure [46-11A](#), Drive Embankment Slope Within Clear Zone. Outside the clear zone, the embankment slope should be 4:1, but should not be steeper than 3:1.

46-11.02(06) Paving

1. Each residential, commercial, or industrial drive should have either an asphalt or concrete surface as shown on the INDOT *Standard Drawings* from the edge of the mainline pavement to at least the highway right-of-way line. The drive pavement should be replaced in kind beyond the right-of-way line only if required to match grade or alignment, and not to repair the drive due to condition.
2. A field entrance typically has an unimproved soil surface within the right-of-way, except as discussed in Section [46-11.02\(01\)](#) Item 1.

46-11.02(07) Sidewalk-Driveway Crossings [Rev. Mar. 2016]

1. Where a sidewalk intersects a commercial drive that contains stop or yield control, a curb ramp should be used.
2. Where a sidewalk intersects a residential drive or commercial drive that does not contain stop or yield control, a sidewalk transition should be used.

In general, the difference between a sidewalk transition and a curb ramp is the need for a detectable warning surface. INDOT *Standard Drawings* Series E 604-SWCR and 604-SWDK contain curb ramp details and sidewalk-driveway crossing details, respectively.

46-11.03 Impacts to Project with Drive Design Complete and Right of Way Acquisition Under Way

Each Class I or III drive should have its grade designed in accordance with the INDOT *Standard Drawings*. However, if the profile-grade requirements shown on the *Standard Drawings* extend an already-designed drive outside the available right of way, such drive should have its grade detailed on the plans so that the drive remains inside the available right of way. Such drive should also be checked for accessibility by a large emergency vehicle or other large vehicle. Such drive should be identified as modified.

46-12.0 TURNING TEMPLATES

Figures [46-12A](#) through [46-12P](#) provide turning templates for the design vehicles most commonly used by INDOT. At least one turning template is included for each design vehicle listed below.

1. P Passenger car, light panel truck, or pickup truck
2. SU Single-unit truck
3. S-BUS-36 Conventional school bus (65 passengers)
4. WB-40 Intermediate semitrailer combination
5. WB-50 Intermediate semitrailer combination
6. WB-62 Interstate semitrailer combination
7. WB-65 (IDV) Indiana Design Vehicle: Interstate semitrailer combination
8. WB-109D Turnpike semitrailer combination with two trailers
9. MH/B Recreational vehicle: motor home and boat trailer

The list of the figures is as follows:

- [46-12A](#) P - Design Vehicle (1" = 20' Scale)
- [46-12B](#) P - Design Vehicle (1" = 50' Scale)
- [46-12C](#) SU - Design Vehicle (1" = 20' Scale)
- [46-12D](#) SU - Design Vehicle (1" = 50' Scale)
- [46-12D\(1\)](#) S-BUS-36 - Design Vehicle (1" = 20' Scale)
- [46-12D\(2\)](#) S-BUS-36 - Design Vehicle (1" = 50' Scale)
- [46-12E](#) WB-40 - Design Vehicle (1" = 30' Scale)
- [46-12F](#) WB-40 - Design Vehicle (1" = 50' Scale)
- [46-12G](#) WB-50 - Design Vehicle (1" = 30' Scale)
- [46-12H](#) WB-50 - Design Vehicle (1" = 50' Scale)
- [46-12I](#) WB-62 - Design Vehicle (1" = 30' Scale)
- [46-12J](#) WB-62 - Design Vehicle (1" = 50' Scale)
- [46-12K](#) WB-65 (IDV) - Design Vehicle (1" = 30' Scale)
- [46-12L](#) WB-65 (IDV) - Design Vehicle (1" = 50' Scale)
- [46-12N](#) WB-109D - Design Vehicle (1" = 50' Scale)
- [46-12O](#) MH/B - Design Vehicle (1" = 30' Scale)
- [46-12P](#) MH/B - Design Vehicle (1" = 50' Scale)

Each figure shows the turning path for an above-listed AASHTO design vehicles. The path shown is for the left-front overhang and outside-rear wheel. The left-front wheel follows the circular curve; however, its path is not shown.

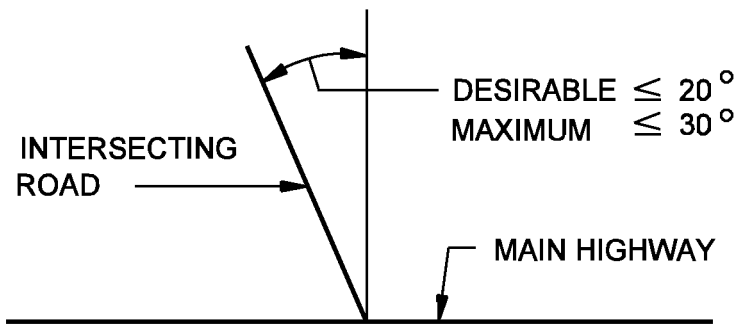

-A-

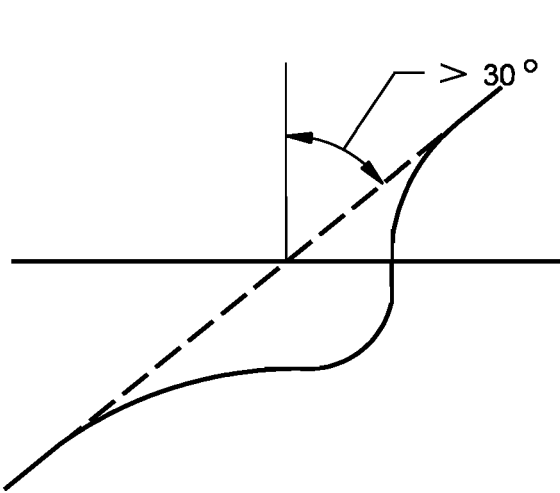

-B-

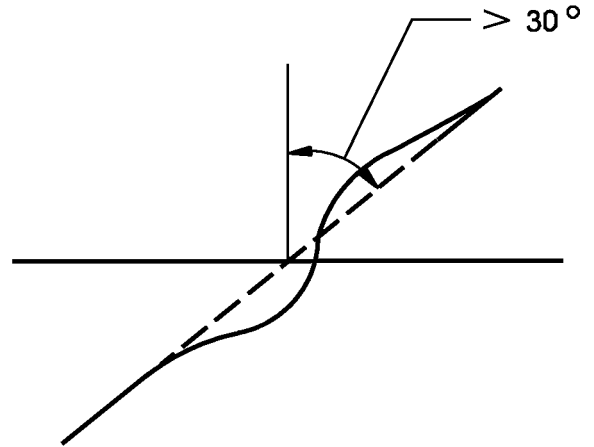

-C-

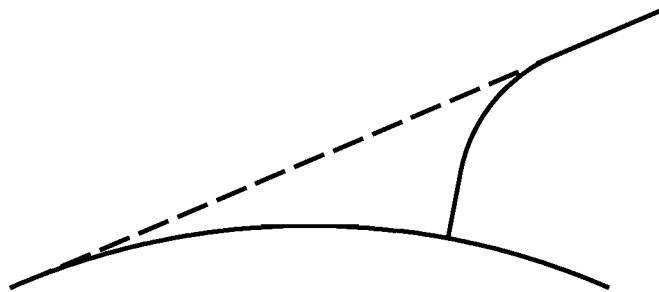

-D-

TREATMENTS FOR SKEWED INTERSECTIONS

Figure 46-1A

PROFILE AND CROSS-SECTION OF MAJOR HIGHWAY IS TYPICALLY MAINTAINED THROUGH AN INTERSECTION. IF BOTH INTERSECTING ROADS HAVE APPROXIMATELY EQUAL IMPORTANCE, BOTH ROADWAYS MAY BE TRANSITIONED.

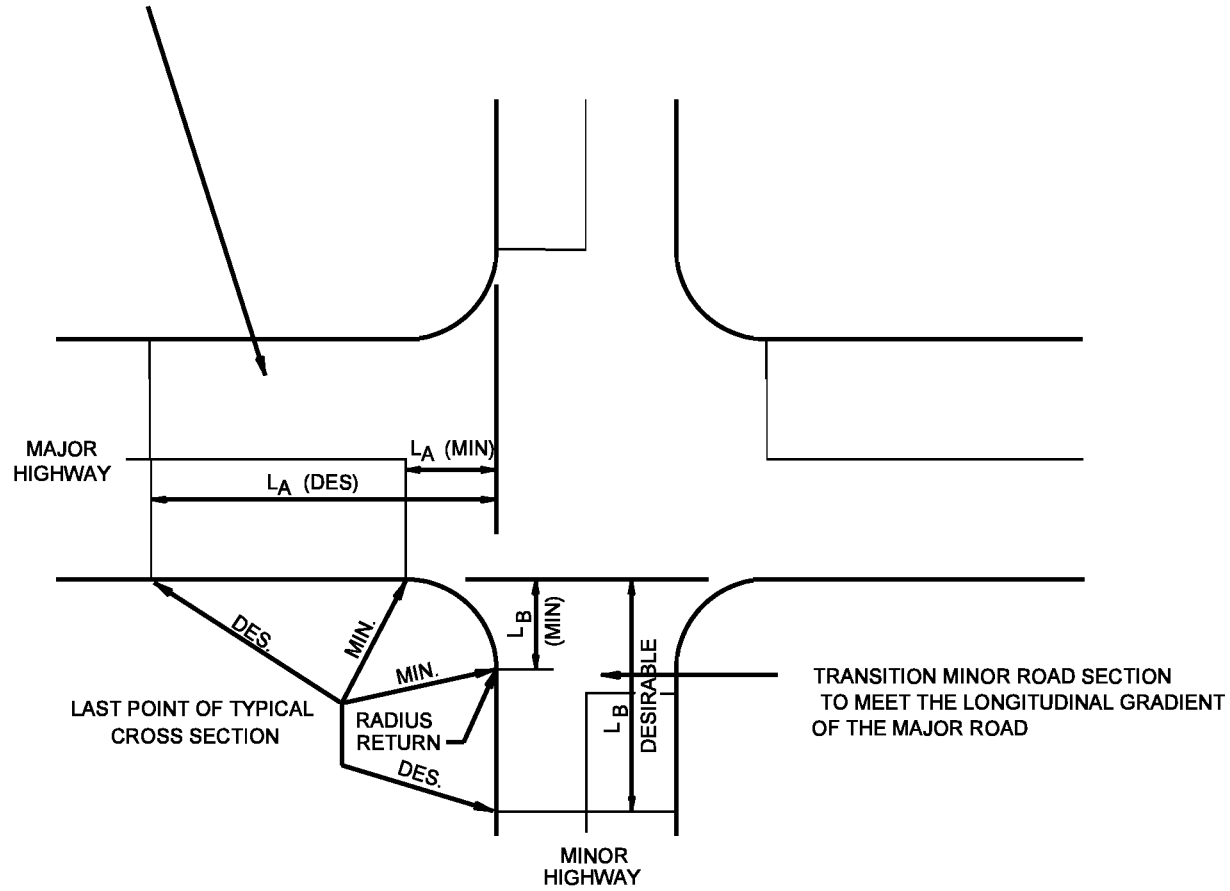

L_A = TRANSITION LENGTH FOR MAJOR HIGHWAY

L_B = TRANSITION LENGTH FOR MINOR HIGHWAY

PAVEMENT TRANSITIONS THROUGH INTERSECTIONS

Figure 46-1B

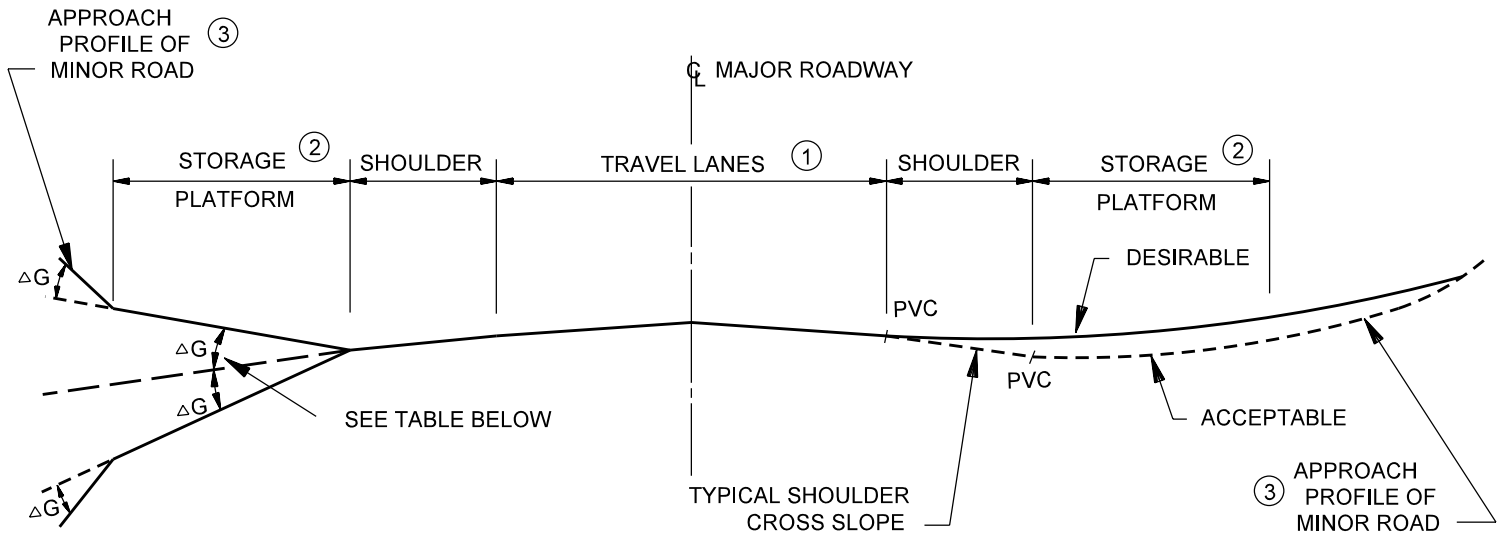

MAXIMUM CHANGE IN GRADES WITHOUT A VERTICAL CURVE		
Design Speed (mph)	Crest Vertical Curve	Sag Vertical Curve
20	$\Delta G = 7.0\%$	$\Delta G = 4.5\%$
25	$\Delta G = 5.0\%$	$\Delta G = 2.5\%$
30	$\Delta G = 3.0\%$	$\Delta G = 1.5\%$

Notes:

1. At a signalized intersection, the most desirable rotation option will be to transition all approach legs into a plane section through the intersection.
2. The grade of the approach roadway where vehicles may be stored should not be steeper than 1%. A grade steeper than 3% should be avoided.
3. The minor-road profile should tie into the major road's travel lane cross slope as shown in the diagram. However, it will be acceptable for the minor-road profile to tie into the major road's shoulder cross slope. Actual field conditions will determine the final design.

VERTICAL PROFILES OF INTERSECTING ROADS

Figure 46-1C

Public-Road Approach	Appropriate Design Vehicle
<p>Type A</p> <ul style="list-style-type: none"> ● Paved- or unpaved-shoulder width < 8 ft. ● Approach radius starts from edge of travel lane. ● Right-turn lane along mainline is not warranted. ● Serves residential, light-commercial, or light-industrial area. 	WB-50 or smaller
<p>Type B</p> <ul style="list-style-type: none"> ● Paved-shoulder width \geq 8 ft. ● Approach radius starts from edge of shoulder. ● Right-turn lane along mainline is not warranted. ● Serves residential, light-commercial, or light-industrial area. 	WB-50 or smaller
<p>Type C</p> <ul style="list-style-type: none"> ● Paved-shoulder width \geq 8 ft. ● Approach radius starts from edge of shoulder. ● Auxiliary right-turn lane along mainline is warranted. ● Serves residential, light-commercial, or light-industrial area. 	WB-50 or smaller WB-65 if adjoining traffic lanes are utilized.
<p>Type D</p> <ul style="list-style-type: none"> ● Paved-shoulder width \geq 8 ft. ● Approach radius starts from edge of shoulder. ● Auxiliary right-turn lane along mainline is warranted. ● Used at intersection of two Department-maintained routes. ● Serves commercial area, heavy-industrial area, or truck stop. 	WB-65 or smaller

Note: If one of these standard public road approach types cannot be used at a particular intersection site, the public-road approach should be designed and the intersection details should be shown on the plans.

**PUBLIC-ROAD APPROACH TYPE
AND CORRESPONDING DESIGN VEHICLE**

Figure 46-1C(1)

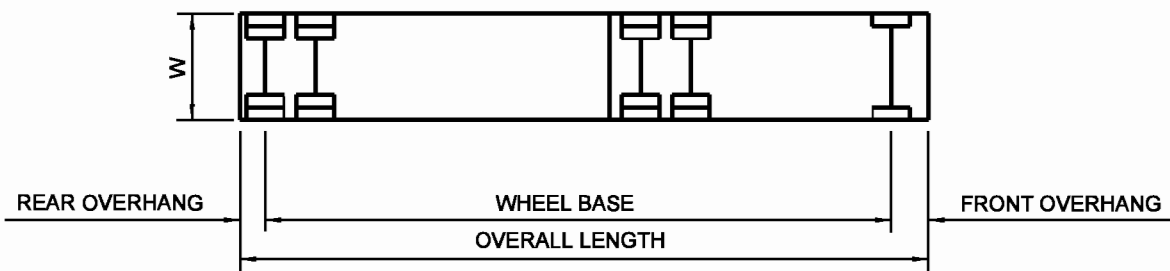
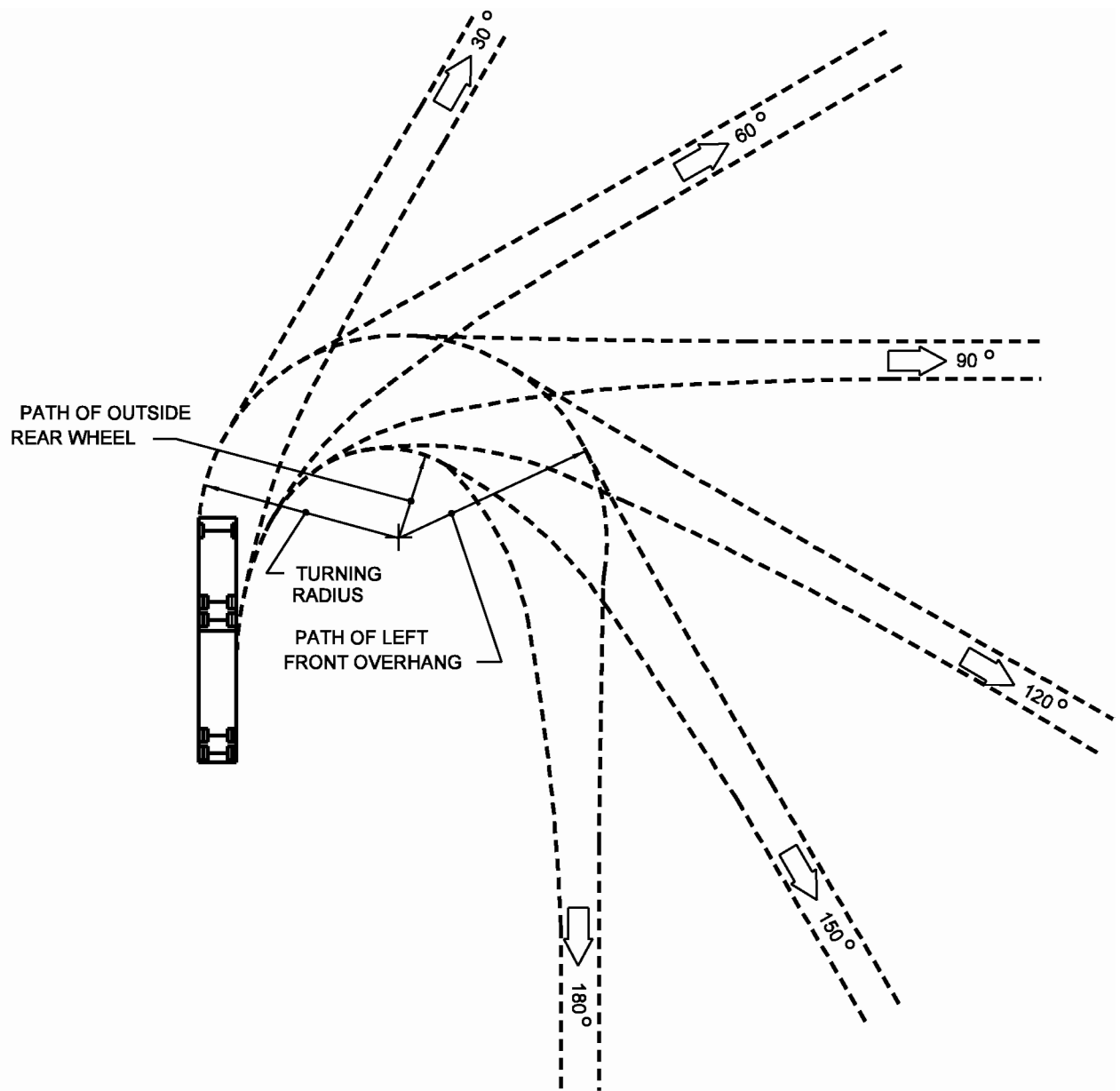

TYPICAL SEMITRAILER COMBINATION DESIGN VEHICLE

Figure 46-1D

For Turn Made From	For Turn Made Onto	Suggested Design Vehicle	
		Desirable	Minimum
Freeway Ramp	Other Facility	IDV	WB-62
Other Facility	Freeway Ramp	IDV	WB-62
Arterial	Arterial	IDV	WB-62
	Collector	IDV	WB-50
	Local	IDV	WB-50
Collector	Arterial	IDV	WB-50
	Collector	IDV	WB-50
	Local	WB-50	WB-40
Local	Arterial	IDV	WB-50
	Collector	WB-50	WB-40
	Local	SU*	SU

* WB-50 can physically make the turn.

**SUGGESTED DESIGN-VEHICLE SELECTION
(Intersection)**

Figure 46-1E

Turn Made From	Turn Made Onto	Acceptable Encroachment for Design Vehicle for Road or Street Onto Which Turn Made
Freeway Ramp	Other Facility	No encroachment into opposing lanes of travel
Arterial	Arterial Collector Local	No encroachment into opposing lanes of travel 1-ft encroachment into opposing lanes of travel 2-ft encroachment into opposing lanes of travel
Collector	Arterial Collector Local	No encroachment into opposing lanes of travel 1-ft encroachment into opposing lanes of travel 2-ft encroachment into opposing lanes of travel
Local	Arterial Collector Local	No encroachment into opposing lanes of travel 2-ft encroachment into opposing lanes of travel 2-ft encroachment into opposing lanes of travel

Notes:

1. *See Figure 46-1E for the design-vehicle selection. The encroachment criteria refer to the design vehicle.*
2. *Before the turn is made, the design vehicle is assumed to be in the outermost through travel lane or exclusive right-turn lane, whichever applies. It is assumed that the vehicle does not encroach onto adjacent lanes on the road or street from which the turn is made.*
3. *If determining the acceptable encroachment, the designer should also consider turning volume, through volume, and the type of traffic control at the intersection. The desirable encroachment will be zero into the opposing lanes of travel.*
4. *The table indicates the amount by which the turning vehicle can encroach into the opposing lanes of travel. If there are two or more lanes of traffic in the same direction on the road onto which the turn is made, the selected design vehicle can occupy both travel lanes. The turning vehicle will be able to make the turn while remaining entirely in the right through lane.*
5. *Regardless of the selected design vehicle or the criteria for encroachment, the IDV should physically be able to make a turn at an intersection without backing up and without impacting a curb, parked car, utility pole, mailbox, or other obstruction.*
6. *Each proposed design should be checked with the applicable vehicular turning template.*

**GUIDELINES FOR ENCROACHMENT FOR RIGHT TURN,
URBAN INTERSECTION**

Figure 46-2A

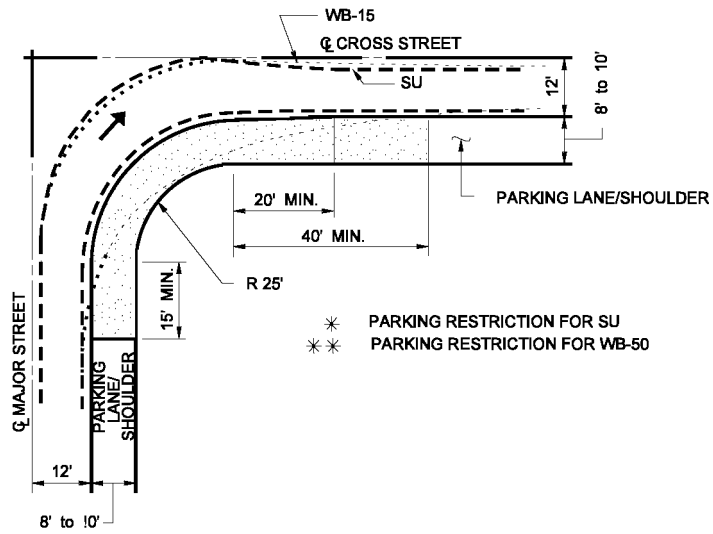
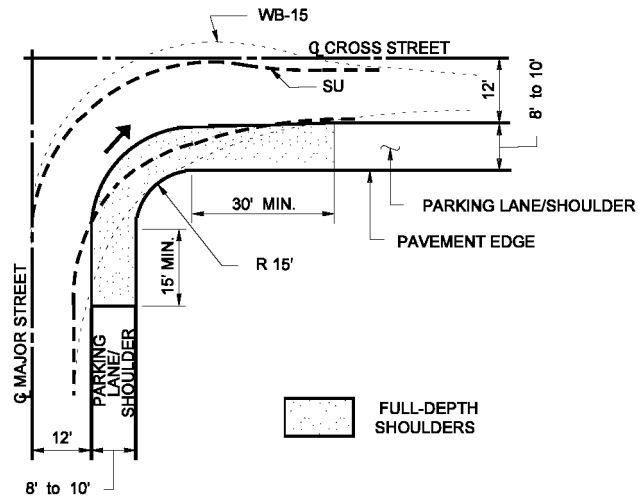

EFFECT OF CURB RADII AND PARKING ON TURNING PATHS

Figure 46-2B

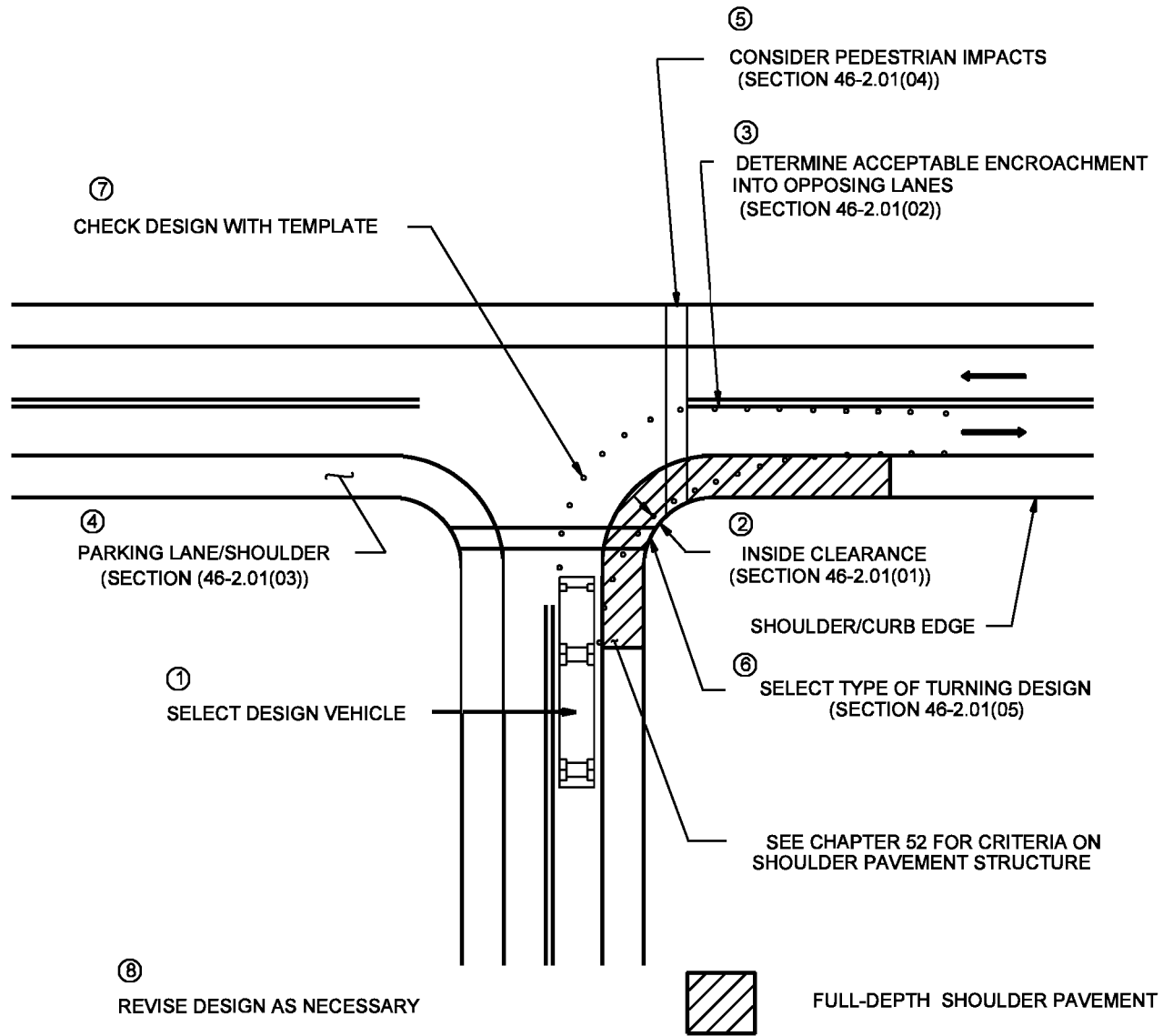

TURNING RADII DESIGN

Figure 46-2C

Angle of Turn, deg	Design Vehicle	Curve Radius, ft	Curve Radius with Taper			Angle of Turn, deg	Design Vehicle	Curve Radius, ft	Curve Radius with Taper		
			Rad., ft	Offset, ft	Taper, H:V				Rad., ft	Offset, ft	Taper, H:V
30	P	60	--	--	--	105	P	--	20	2.5	8:1
	SU	100	--	--	--		SU	--	35	3	10:1
	WB-40	150	--	--	--		WB-40	--	40	4	10:1
	WB-50	200	--	--	--		WB-50	--	55	4	15:1
	WB-62	360	220	3	15:1		WB-62	--	115	3	15:1
	WB-67	380	220	3	15:1		WB-67	--	115	3	15:1
	WB-100T	260	125	3	15:1		WB-100T	--	75	3	15:1
	WB-109D	475	250	3.5	20:1		WB-109D	--	90	9.2	20:1
45	P	50	--	--	--	120	P	--	20	2	10:1
	SU	75	--	--	--		SU	--	30	3	10:1
	WB-40	120	--	--	--		WB-40	--	35	5	8:1
	WB-50	175	120	2	15:1		WB-50	--	45	4	15:1
	WB-62	230	145	4	15:1		WB-62	--	100	5	15:1
	WB-67	250	145	4.5	15:1		WB-67	--	105	5.2	15:1
	WB-100T	200	115	2.5	15:1		WB-100T	--	65	3.5	15:1
	WB-109D	--	200	4.5	20:1		WB-109D	--	85	9.2	20:1
60	P	40	--	--	--	135	P	--	20	1.5	10:1
	SU	60	--	--	--		SU	--	30	4	10:1
	WB-40	90	--	--	--		WB-40	--	30	8	15:1
	WB-50	150	120	3	15:1		WB-50	--	40	6.0	15:1
	WB-62	170	140	4	15:1		WB-62	--	80	5	20:1
	WB-67	200	140	4.5	15:1		WB-67	--	85	5.2	20:1
	WB-100T	150	95	2.5	15:1		WB-100T	--	65	5.5	15:1
	WB-109D	--	180	4.5	20:1		WB-109D	--	85	8.5	20:1
75	P	35	25	2	10:1	150	P	--	18	2	10:1
	SU	55	45	2	10:1		SU	--	30	4	8:1
	WB-40	--	60	2	15:1		WB-40	--	30	6	8:1
	WB-50	--	65	3	15:1		WB-50	--	35	7	6:1
	WB-62	--	145	4	20:1		WB-62	--	60	10	10:1
	WB-67	--	145	4.5	20:1		WB-67	--	65	10.2	10:1
	WB-100T	--	85	3	15:1		WB-100T	--	65	7.3	10:1
	WB-109D	--	140	5.5	20:1		WB-109D	--	65	15.1	10:1
90	P	30	20	2.5	10:1	180	P	--	15	0.5	20:1
	SU	50	40	2	10:1		SU	--	30	1.5	10:1
	WB-40	--	45	4	10:1		WB-40	--	20	9.5	5:1
	WB-50	--	60	4	15:1		WB-50	--	25	9.5	5:1
	WB-62	--	120	4.5	30:1		WB-62	--	55	10	15:1
	WB-67	--	125	4.5	30:1		WB-67	--	55	13.8	10:1
	WB-100T	--	85	2.5	15:1		WB-100T	--	55	10.2	10:1
	WB-109D	--	115	2.9	15:1		WB-109D	--	55	20	10:1

EDGE-OF-TRAVELED-WAY DESIGN FOR TURN AT INTERSECTION

Figure 46-2D

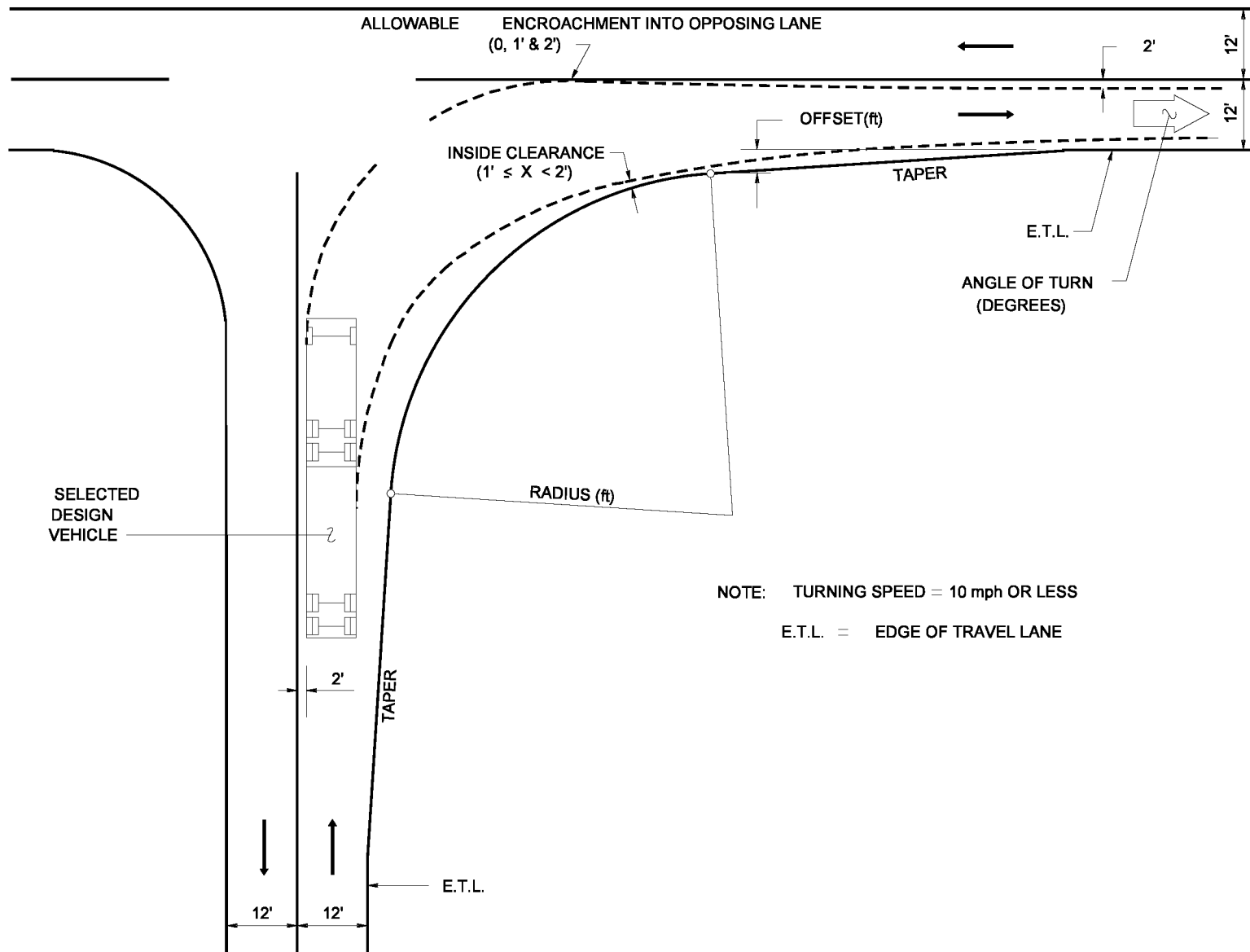

TYPICAL TURNING RADII DESIGN ASSUMPTIONS
Figure 46-2E

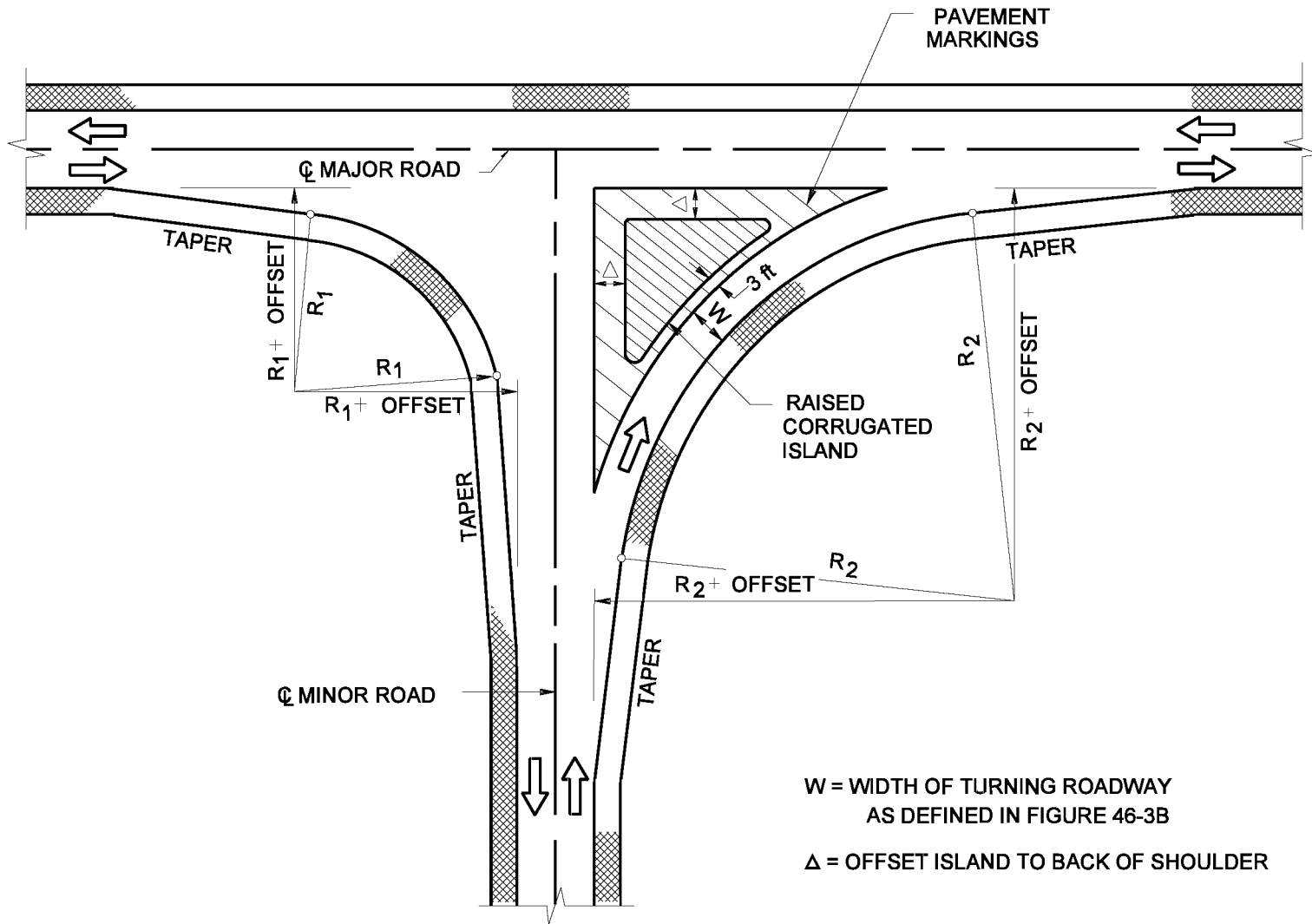

TYPICAL TURNING ROADWAY
(Stop Controlled on Minor Road)

Figure 46-3A

R	P	SU	BUS-40	BUS-45	CITY-BUS	S-BUS-36	S-BUS-40	A-BUS	WB-40	WB-50	WB-62	WB-65	WB-67D	WB-100T	WB-109D	MH	P/T	P/B	MH/B
ONE-LANE, ONE-WAY OPERATION, NO PROVISION FOR PASSING A STALLED VEHICLE																			
50	13	18	22	23	21	19	18	22	23	32	43	49	29	37	--	18	19	18	21
75	13	17	19	20	19	17	17	19	20	25	29	32	23	27	43	17	17	17	19
100	13	16	18	19	18	16	16	18	18	22	25	27	21	24	34	16	16	16	17
150	12	15	17	17	17	16	15	17	17	19	21	22	19	21	27	15	16	15	16
200	12	15	16	17	16	15	15	16	16	18	20	20	18	19	23	15	15	15	16
300	12	15	16	16	16	15	15	16	15	17	18	18	17	17	20	15	15	15	15
400	12	15	16	16	16	15	15	16	15	17	18	18	17	17	20	15	15	15	15
500	12	15	16	16	16	15	15	16	15	17	18	18	17	17	20	15	15	15	15
Tan.	12	14	15	16	15	14	14	15	14	15	15	15	16	15	15	14	14	14	14
ONE-LANE, ONE-WAY OPERATION, WITH PROVISION FOR PASSING A STALLED VEHICLE BY ANOTHER OF THE SAME TYPE																			
50	20	30	39	42	38	31	32	40	39	56	79	93	50	67	--	30	30	28	36
75	19	27	32	35	32	27	28	34	32	42	52	56	38	47	79	27	27	26	30
100	18	25	30	31	29	25	26	30	29	36	43	46	34	40	60	25	25	24	28
150	18	23	27	28	27	23	24	27	26	31	35	37	29	33	45	23	23	23	25
200	17	22	25	26	25	23	23	26	24	28	32	33	27	30	39	22	22	22	24
300	17	22	24	24	24	22	22	24	23	26	28	29	25	27	33	22	22	21	23
400	17	21	23	24	23	21	21	23	22	25	26	27	24	25	30	21	21	21	22
500	17	21	23	23	23	21	21	23	22	24	25	26	23	25	28	21	21	21	21
Tan.	17	20	21	21	21	20	20	21	20	21	21	21	21	21	21	20	20	20	20
TWO-LANE OPERATION, EITHER ONE- OR TWO-WAY, SAME TYPE VEHICLE IN BOTH LANES																			
50	26	36	45	48	44	37	38	46	45	62	85	99	56	73	--	36	36	34	42
75	25	33	38	41	38	33	34	40	38	48	58	62	45	53	85	33	33	32	36
100	24	31	36	37	35	31	32	36	35	42	49	52	40	46	66	31	31	30	34
150	24	29	33	34	33	29	30	33	32	37	41	43	35	39	51	29	29	29	31
200	23	28	31	32	31	29	29	32	30	34	38	39	33	36	45	28	28	28	30
300	23	28	30	30	30	28	28	30	29	32	34	35	31	33	39	28	28	27	29
400	23	27	29	30	29	27	27	29	28	31	32	33	30	31	36	27	27	27	28
500	23	27	29	29	29	27	27	29	28	30	31	32	29	31	34	27	27	27	27
Tan.	23	26	27	27	27	26	26	27	26	27	27	27	27	27	27	26	26	26	26

R = Radius on inner edge of pavement, ft. Tan. = Tangent.

DERIVED PAVEMENT WIDTH, ft, FOR TURNING ROADWAY FOR EACH DESIGN VEHICLE

Figure 46-3B

Radius (ft)	Range in Superelevation Rate for Turning Roadway with Design Speed (mph) of					
	15	20	25	30	35	40 & 45
50	2%-6%	—	—	—	—	—
100	2%-6%	2%-6%	—	—	—	—
150	2%-5%	2%-6%	4%-6%	—	—	—
225	2%-4%	2%-6%	3%-6%	6%	—	—
300	2%-3%	2%-4%	3%-6%	5%-6%	—	—
450	2%-3%	2%-3%	3%-5%	4%-6%	6%	—
600	2%	2%-3%	2%-4%	3%-5%	5%-6%	—
1000	2%	2%-3%	2%-3%	3%-4%	4%-5%	5%-6%
1500	2%	2%	2%	2%-3%	3%-4%	4%-5%

SUPERELEVATION RATE FOR TURNING ROADWAY

Figure 46-3C

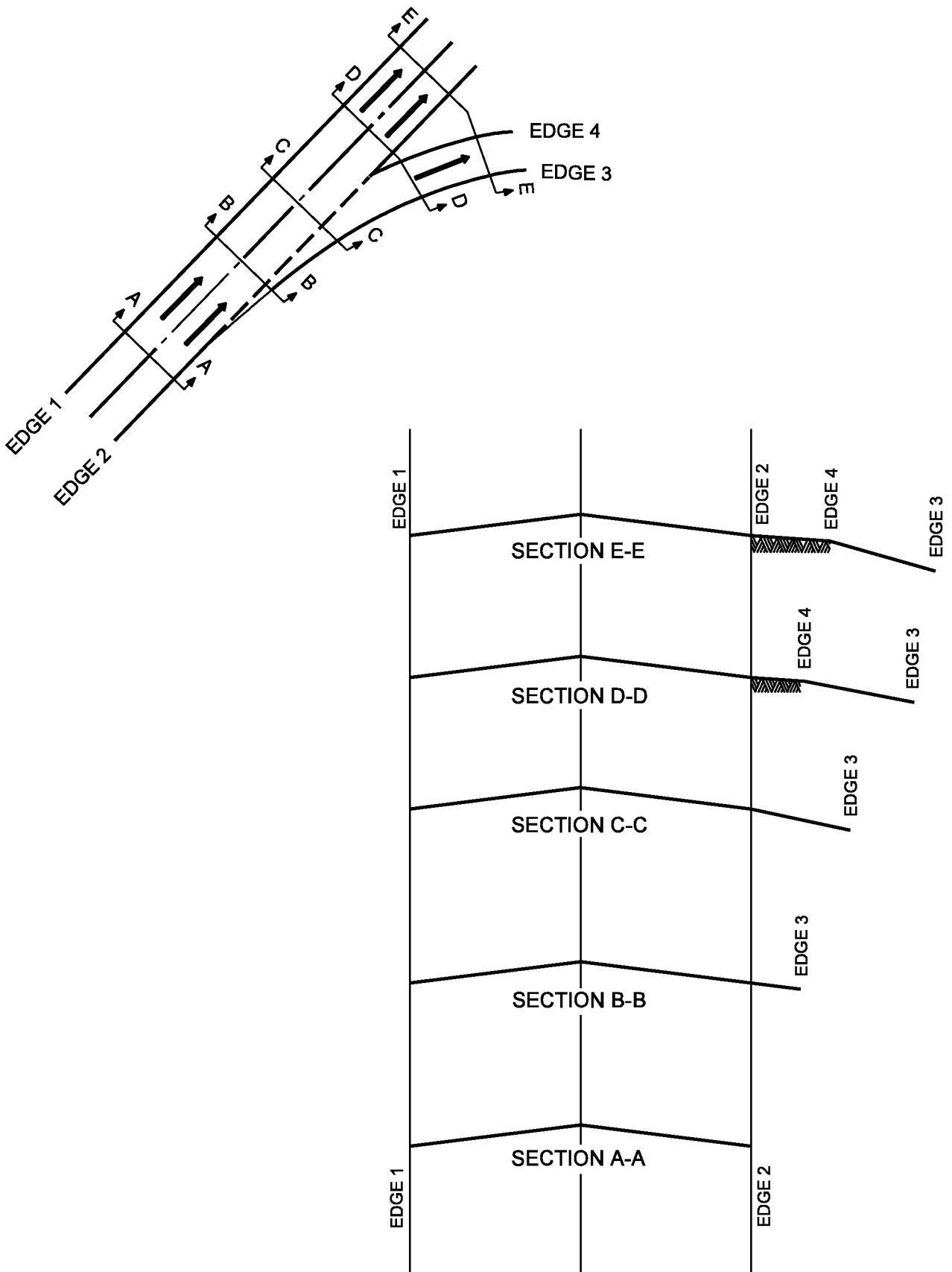

DEVELOPMENT OF SUPERELEVATION AT TURNING ROADWAY TERMINALS

Figure 46-3D

Angle of Turn, deg	Design Classification	3-Centered Compound Curve Radii, ft	3-Centered Compound Curve Offset, ft	Lane Width, ft	Approx. Island Size, ft ²
75	A	150-75-150	3.5	14	60
	B	150-75-150	5.0	18	50
	C	180-90-180	3.5	20	50
90	A	150-50-150	3.0	14	50
	B	150-50-150	5.0	18	80
	C	180-65-180	6.0	20	125
105	A	120-40-120	2.0	15	70
	B	100-35-100	5.0	22	50
	C	180-45-180	8.0	30	60
120	A	100-30-100	2.5	16	120
	B	100-30-100	5.0	24	90
	C	180-40-180	8.5	34	220
135	A	100-30-100	2.5	16	460
	B	100-30-100	5.0	26	370
	C	160-35-160	9.0	35	640
150	A	100-30-100	2.5	16	1400
	B	100-30-100	6.0	30	1170
	C	160-35-160	7.1	38	1720

1. *An asymmetric three-centered compound curve or straight tapers with a simple curve may also be used without significantly altering the roadway width or the corner-island size. Painted island delineation is recommended for an island of less than 75 ft² in area.*
2. *Design classification is defined as follows:*
 - A: Primarily P. Permits occasional design single-unit truck to turn with restricted clearances.*
 - B: Provides adequately for SU. Permits occasional WB-50 to turn with slight encroachment onto adjacent traffic lanes.*
 - C: Provides fully for WB-50.*

DESIGN FOR TURNING ROADWAY

Figure 46-3E

Design Speed (mph)	10	15	20	25	30	35	40	45
Stopping Sight Distance (ft)	50	80	115	155	200	250	305	360

STOPPING SIGHT DISTANCE FOR TURNING ROADWAY

Figure 46-3E(1)

Design Speed of Curve at Section D-D* (mph)	Maximum Algebraic Difference in Cross Slope at Crossover Line (percent)
15 to 20	5 to 8
25 to 30	5 to 6
> 30	4 to 5

* See Figure 46-3D

Note: Figure is also applicable to a turn lane or where shoulder is anticipated to be used as a turn lane.

PAVEMENT CROSS SLOPE AT TURNING-ROADWAY TERMINAL

Figure 46-3F

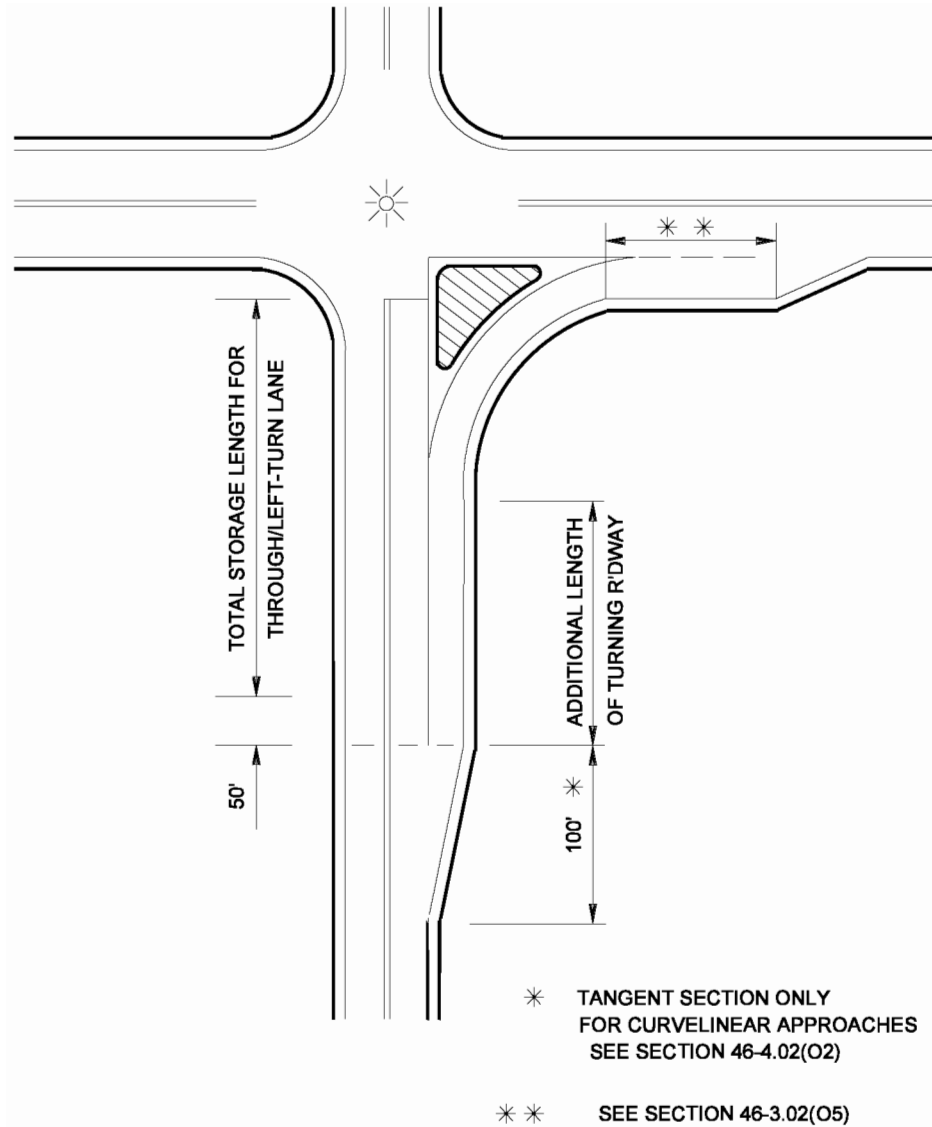

**ADDITIONAL LENGTH OF TURNING ROADWAY
(Signalized Intersection)**

Figure 46-3G

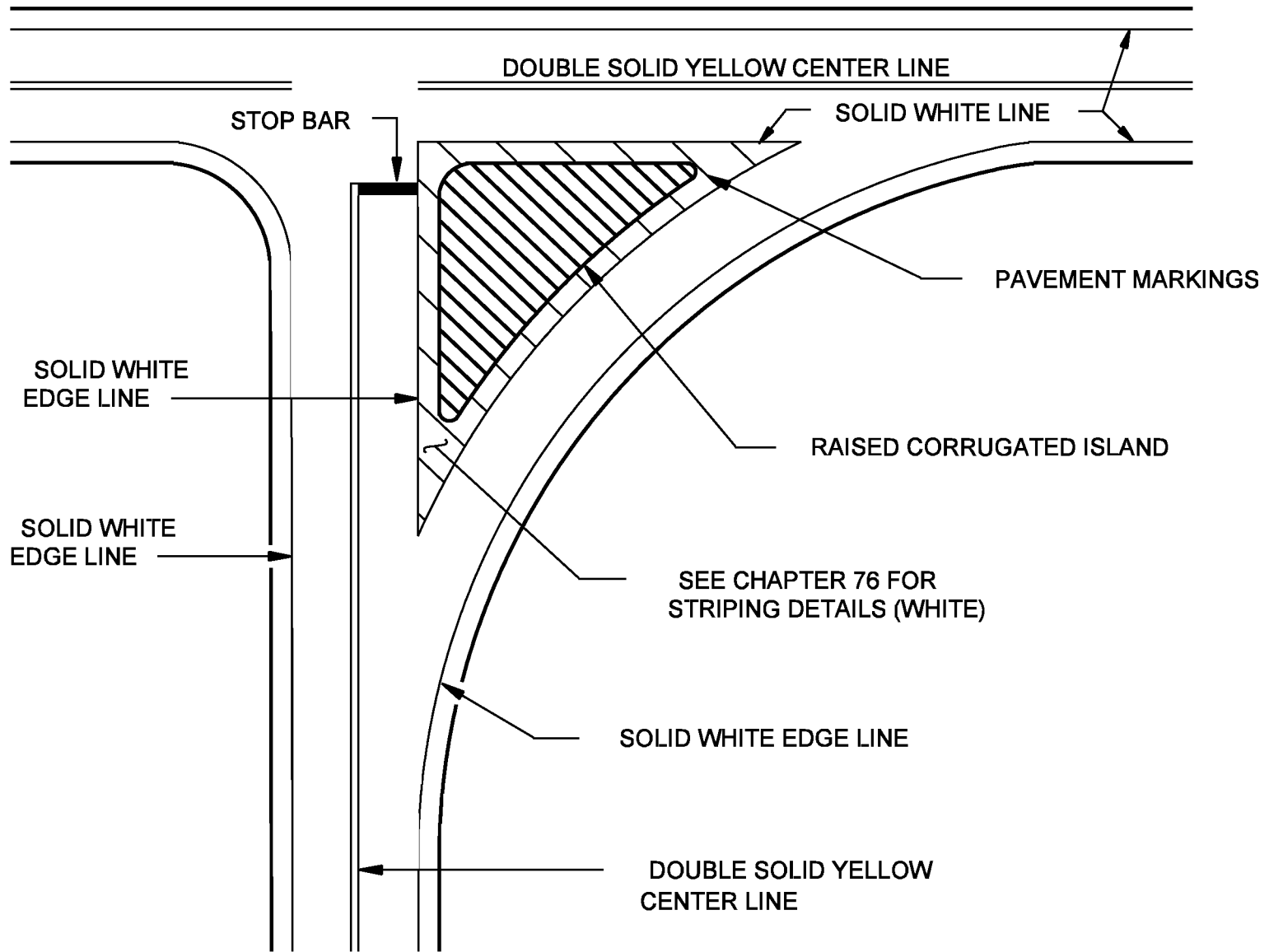

TYPICAL PAVEMENT MARKINGS FOR TURNING ROADWAYS

Figure 46-3H

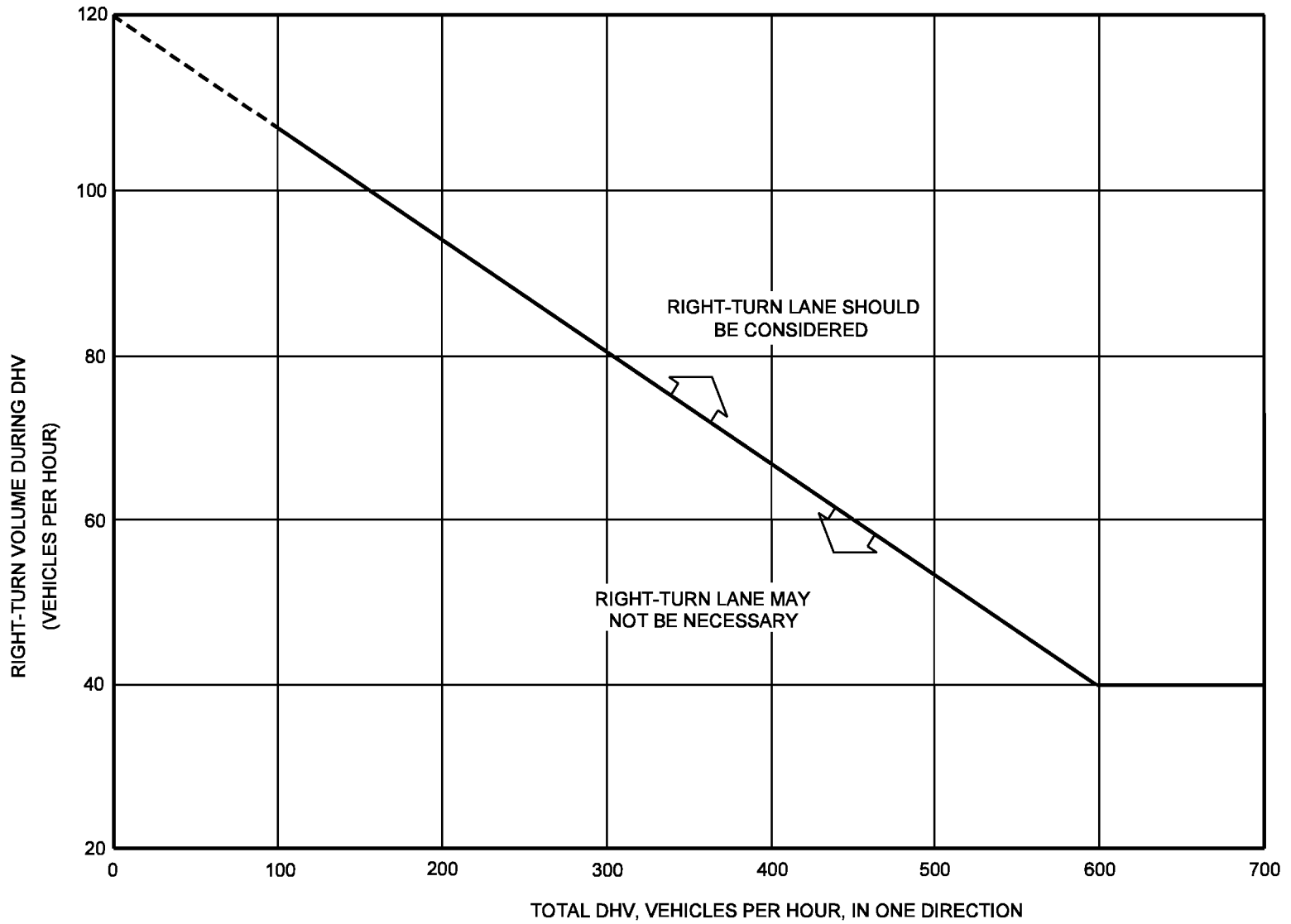

**GUIDELINES FOR RIGHT-TURN LANES AT UNSIGNALIZED INTERSECTIONS
ON 2-LANE HIGHWAYS**

Figure 46-4A

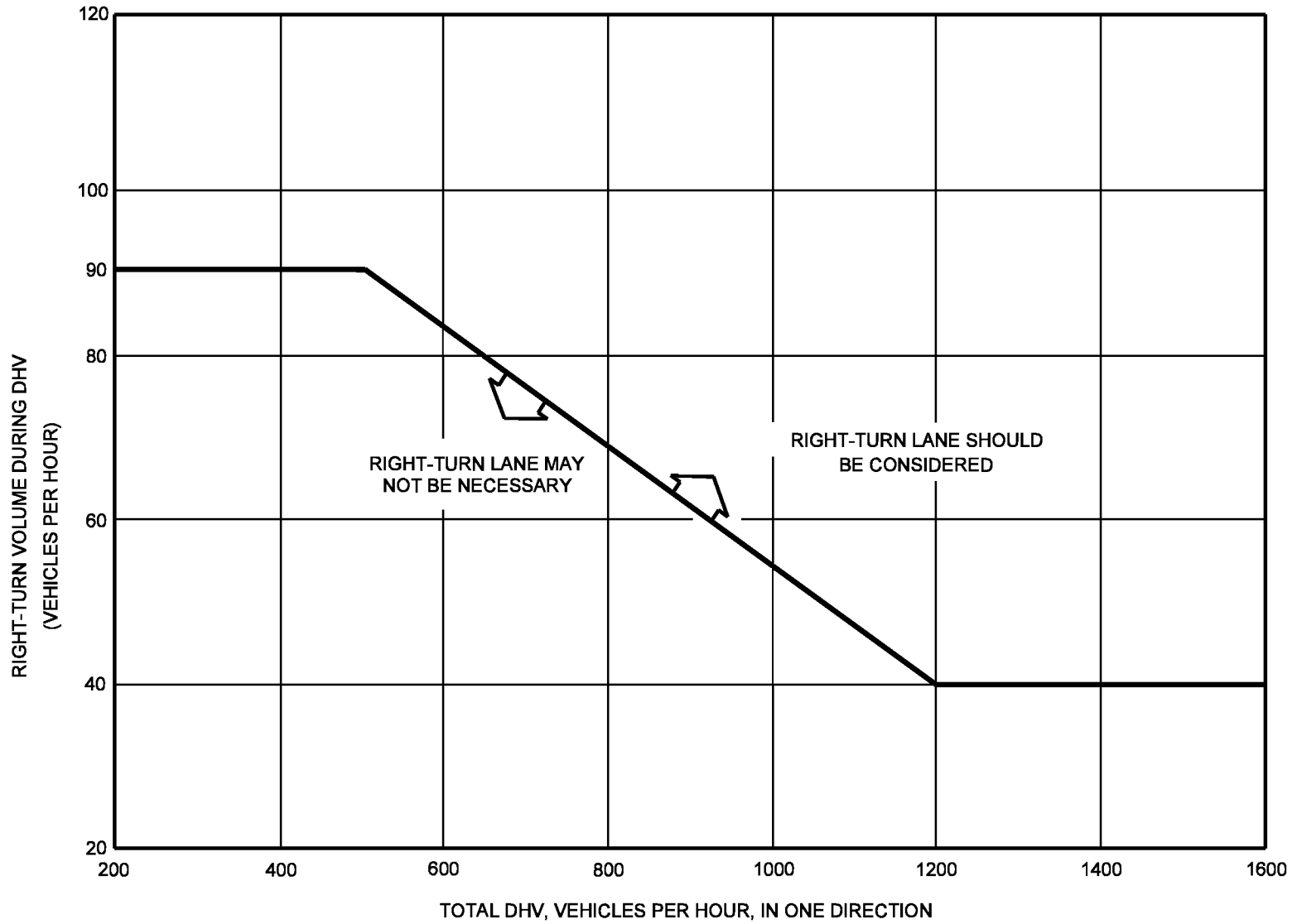

GUIDELINES FOR RIGHT-TURN LANES AT UNSIGNALIZED INTERSECTION ON 4-LANE HIGHWAYS

Figure 46-4B

Operating Speed (mph)	Opposing Volume (veh/h)	Advancing Volume (veh/h)			
		5% Left Turns	10% Left Turns	20% Left Turns	30% Left Turns
40	800	330	240	180	160
	600	410	305	225	200
	400	510	380	275	245
	200	640	470	350	305
	100	720	515	390	340
50	800	280	210	165	135
	600	350	260	195	170
	400	430	320	240	210
	200	550	400	300	270
	100	615	445	335	295
60	800	230	170	125	115
	600	290	210	160	140
	400	365	270	200	175
	200	450	330	250	215
	100	505	370	275	240

**VOLUME GUIDELINES FOR LEFT-TURN LANE
ON TWO-LANE HIGHWAY**

Figure 46-4C

Classification	Functional Length
Rural Arterial	$L_T + L_D + L_S$
Urban Arterial Other Facility Stop or T Facility	$L_T + L_D + L_S$ (Desirable) $L_T + L_S$ (Minimum)

L_T = Length of Taper (100 ft or more)

L_D = Length of Deceleration

L_S = Length of Storage

Notes:

1. See Figure 46-4 I for an illustration of the terms.
2. L_D is a consideration only at a free-flowing leg of a stop-controlled intersection or signalized intersection, or at a free-flowing turning roadway with a turn lane.

FUNCTIONAL LENGTH OF AUXILIARY TURN LANE

Figure 46-4H

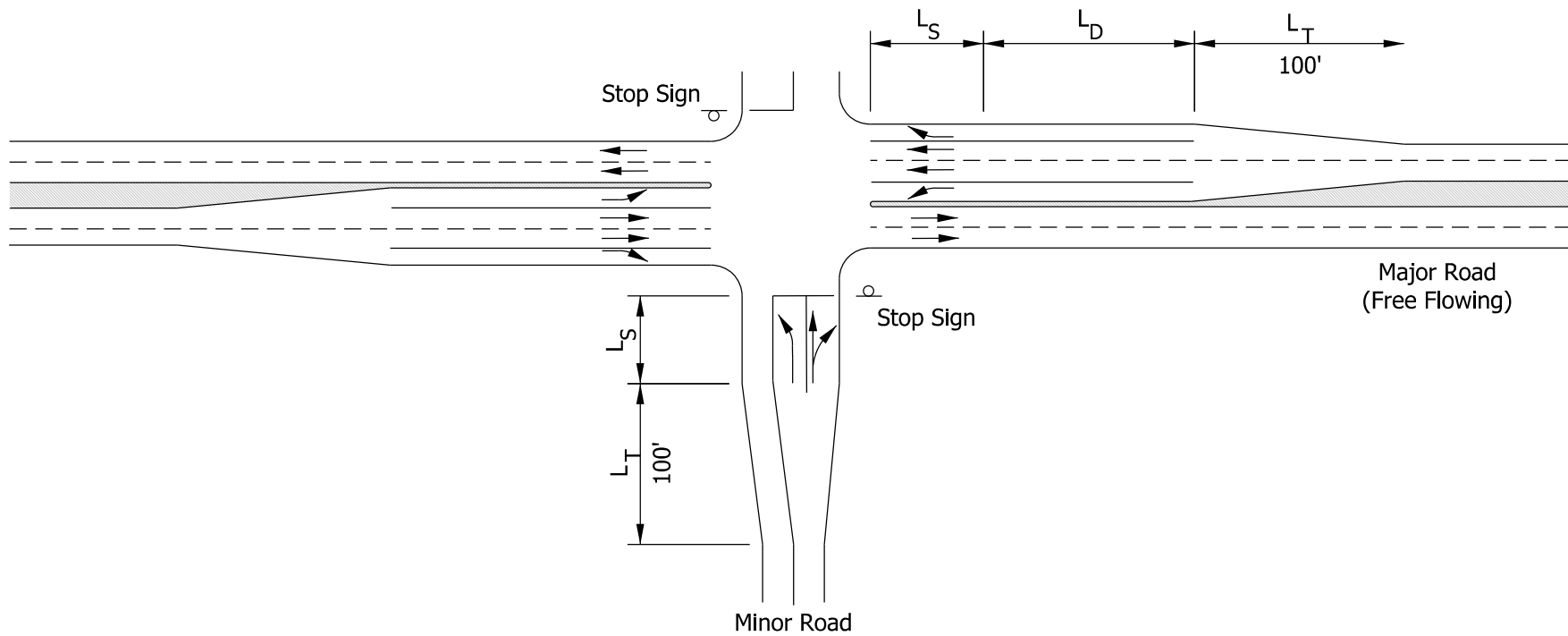

NOTE: The schematic of the major road (free flowing) also applies to all legs of a signalized intersection.

KEY: L_T = Taper Length (100' or more)

L_D = Deceleration Length

L_S = Storage Length

TYPICAL AUXILIARY LANES AT AN INTERSECTION

Figure 46-4 I

Design Speed (mph)	L_D , Full-Width Auxiliary Lane (ft)
60	530
55	480
50	435
45	385
40	320
35	280
30	235
25	200

Grade-Adjustment Factor for Downgrade, G_d				
$0 \leq G_d < 2$	$2 \leq G_d < 3$	$3 \leq G_d < 4$	$4 \leq G_d < 5$	$5 \leq G_d \leq 6$
1.00	1.10	1.20	1.28	1.35
Grade-Adjustment Factor for Upgrade, G_u				
$0 \leq G_u < 2$	$2 \leq G_u < 3$	$3 \leq G_u < 4$	$4 \leq G_u < 5$	$5 \leq G_u \leq 6$
1.00	0.95	0.90	0.85	0.80

Note: The grade-adjustment factor multiplied by the length L_D provided above will provide the deceleration-lane length adjusted for grade. The adjustment factor applies to each design speed.

DECELERATION DISTANCE FOR TURN LANE

Figure 46-4J

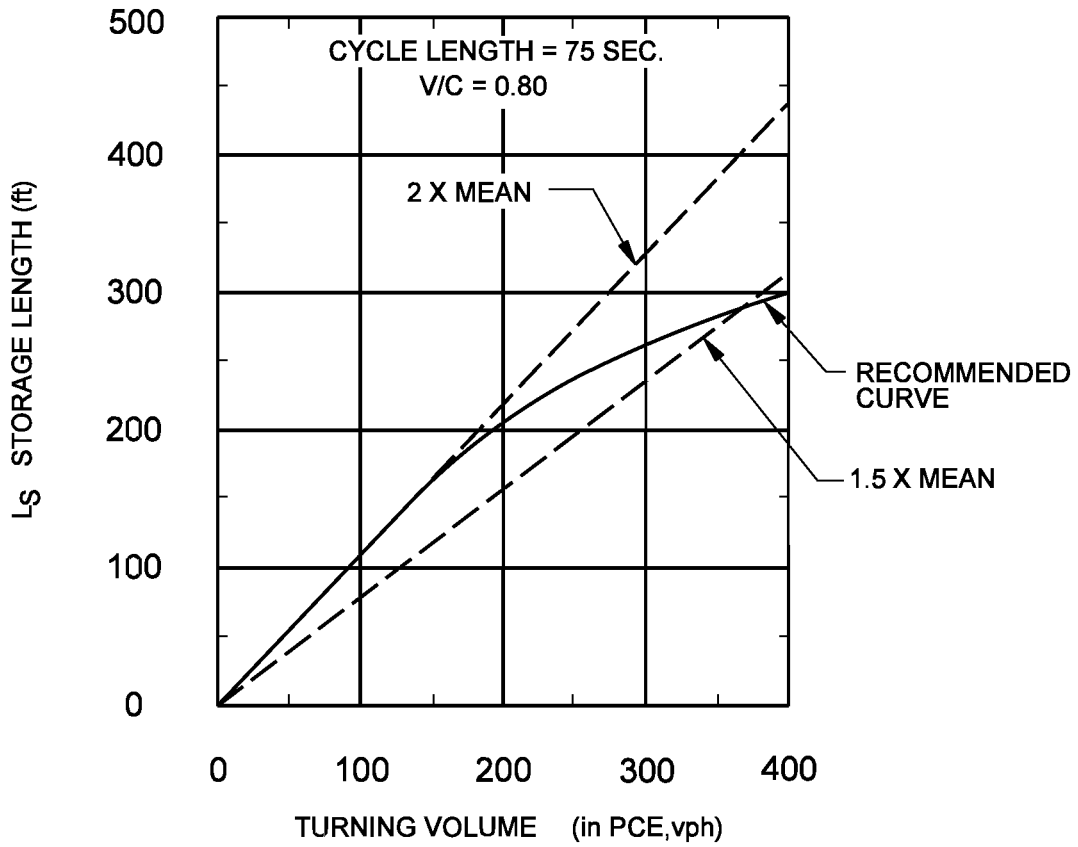

**RECOMMENDED STORAGE LENGTH FOR
SIGNALIZED INTERSECTIONS**

Figure 46-4K

v/c RATIO, X	CYCLE LENGTH, C (s)				
	60	70	80	90	100
0.50	0.70	0.76	0.84	0.89	0.94
0.55	0.71	0.77	0.85	0.90	0.95
0.60	0.73	0.79	0.87	0.92	0.97
0.65	0.75	0.81	0.89	0.94	1.00
0.70	0.77	0.84	0.92	0.98	1.03
0.75	0.82	0.88	0.98	1.03	1.09
0.80	0.88	0.95	1.05	1.11	1.17
0.85	0.99	1.06	1.18	1.24	1.31
0.90	1.17	1.26	1.40	1.48	1.56
0.95	1.61	1.74	1.92	2.03	2.14

- Notes:
1. Table applies to an exclusive left-turn lane or an exclusive right-turn lane where a turn on red is not permitted.
 2. See minimum storage length discussion in Section 46-4.02(02).
 3. To determine the v/c ratio and the passenger car equivalent (PCE) values, see the Highway Capacity Manual.

**RECOMMENDED STORAGE LENGTH FOR
SIGNALIZED INTERSECTION**

Figure 46-4K(1)

TURNING DHV (vph)	L_s (ft)
≤ 60	50 to 75
$60 < \text{DHV} \leq 120$	100
$120 < \text{DHV} \leq 180$	150
> 180	≥ 200

Note: See Section 46-4.02(02) for minimum storage-length criteria.

**RECOMMENDED STORAGE LENGTH, L_s , FOR
UNSIGNALIZED INTERSECTION**

Figure 46-4L

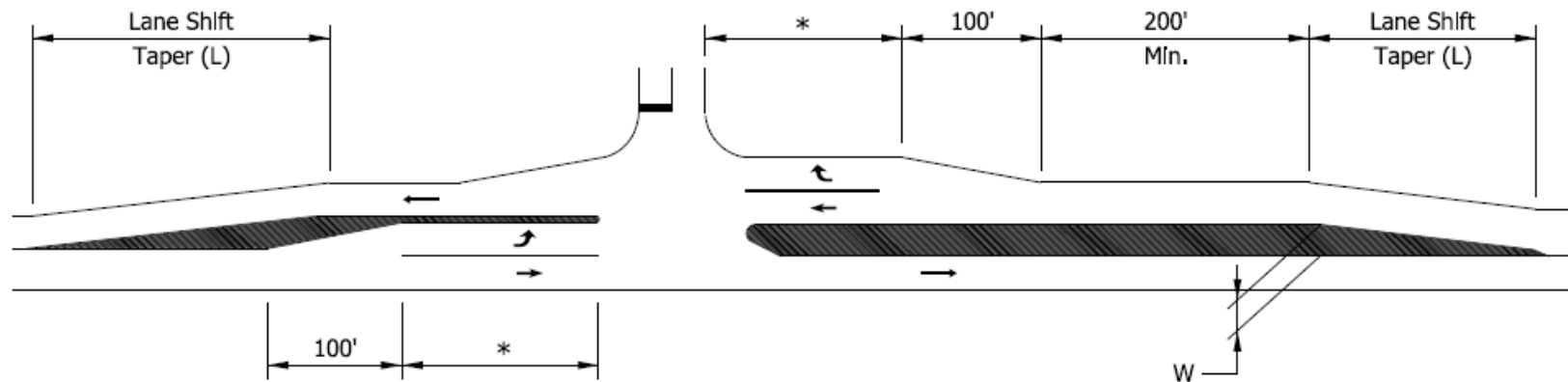

Design Speed, S (mph)	Taper Rate
20	10:1
25	10:1
30	15:1
35	20:1
40	30:1
45	45:1
50	50:1
55	55:1
60	60:1

W= Horizontal lane shift, ft

$$L = W \times S \quad (S \geq 45 \text{ mph})$$

$$L = W \times \frac{S^2}{60} \quad (S < 45 \text{ mph})$$

*See Section 46-4.02 for minimum turn-lane length.

Taper Rate = S for $S \geq 45$ mph)

Taper Rate = $\frac{S^2}{60}$ for $S < 45$ mph)

CHANNELIZED TURN LANE FOR 2-LANE HIGHWAY

Figure 46-4M

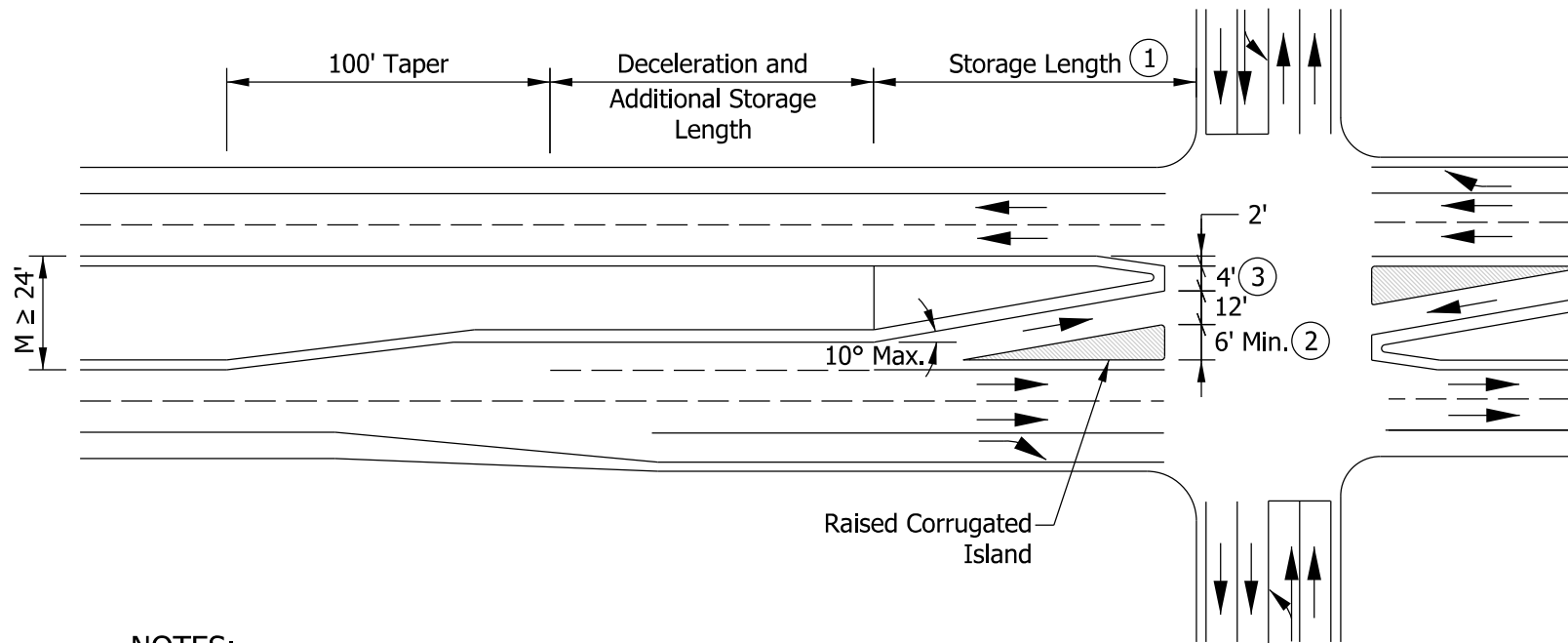

NOTES:

- ① In rural areas, a minimum length of 100' is required. In urban areas, low-speed conditions, 50' is acceptable.
- ② Minimum island width at stop line is 6'.
- ③ Where a pedestrian refuge is provided, the minimum width is 6'.
4. This figure represents the minimum conditions for slotted tapered left-turn lane construction. If minimums cannot be met, consideration should be given to other solutions, e.g., left-turn prohibition, split phasing.
5. See Section 502-2.0 for pavement markings.

TYPICAL SLOTTED TAPERED LEFT-TURN LANE (Signalized Intersection)

Figure 46-4N

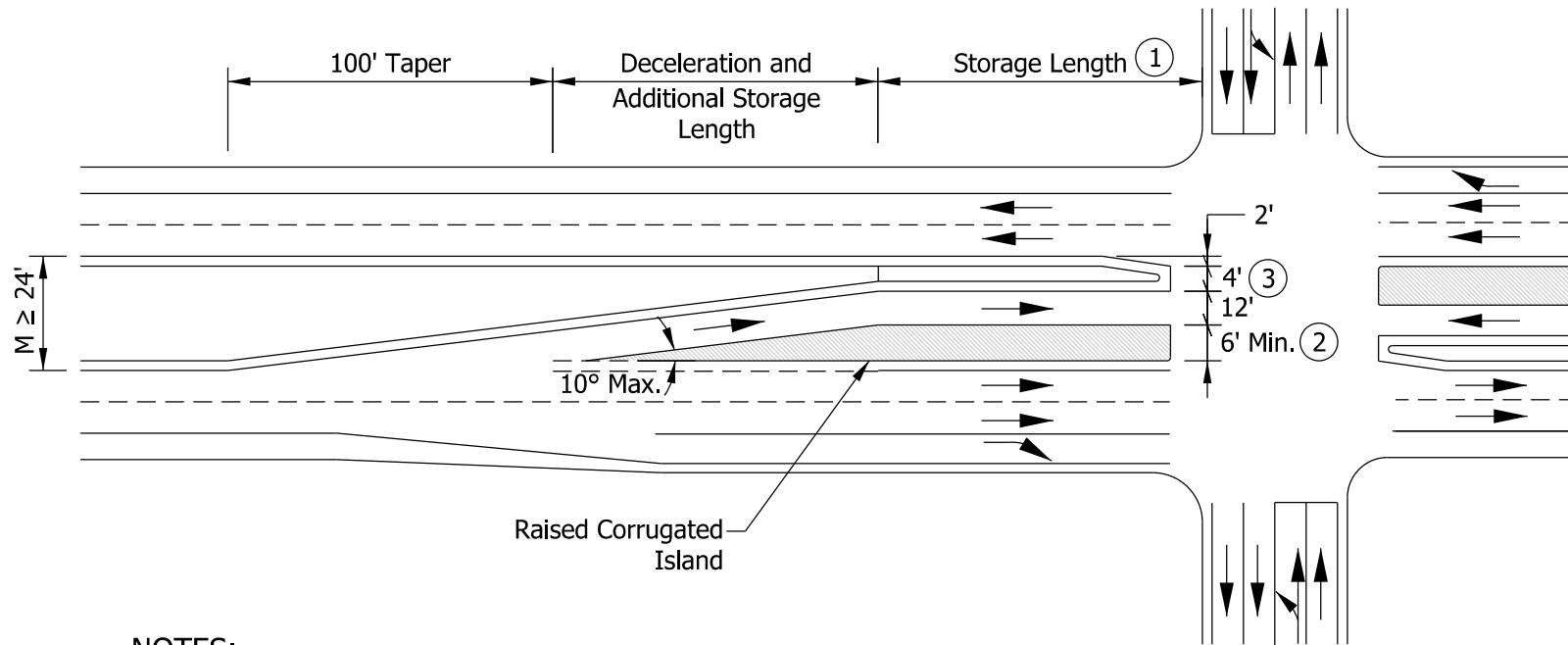

NOTES:

- ① In rural areas, a minimum length of 100' is required. In urban areas, low-speed conditions, 50' is acceptable.
- ② Minimum island width at stop line is 6'.
- ③ Where a pedestrian refuge is provided, the minimum width is 6'.
4. This figure represents the minimum conditions for slotted parallel left-turn lane construction. If minimums cannot be met, consideration should be given to other solutions, e.g., left-turn prohibition, split phasing.
5. See Section 502-2.0 for pavement markings.

TYPICAL SLOTTED PARALLEL LEFT-TURN LANE (Signalized Intersection)

Figure 46-4N(1)

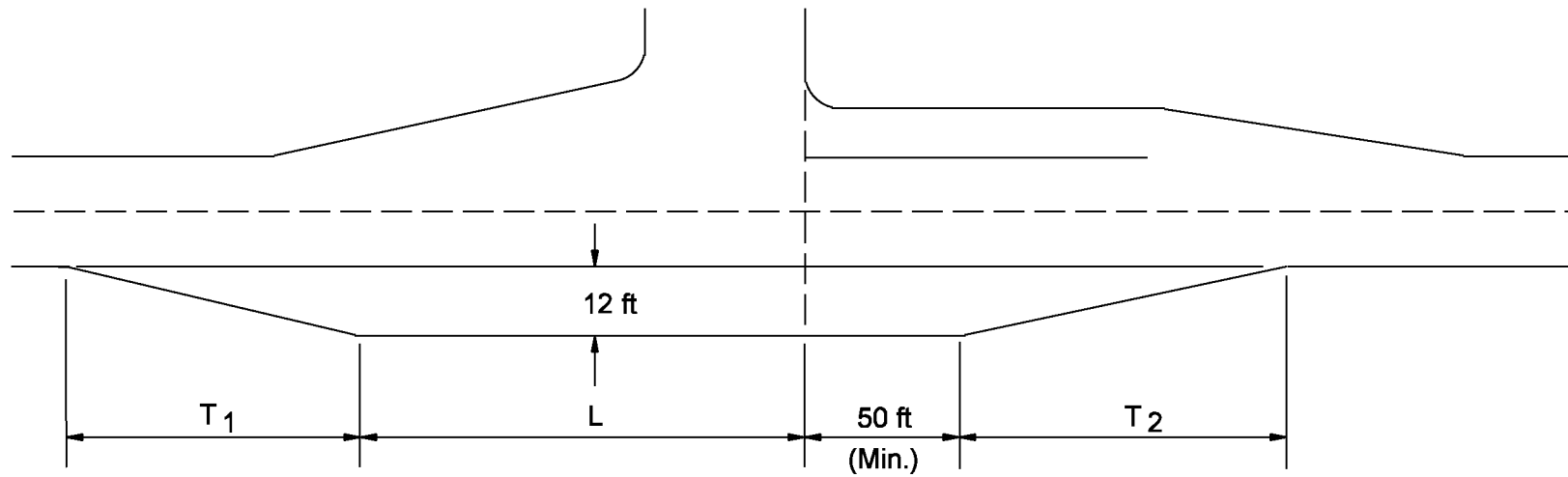

MINIMUM DIMENSIONS FOR PASSING BLISTERS			
Design Speed (mph)	T ₁ (ft)	L (ft)	T ₂ (ft)
30 or less	150	150	150
Greater than 30, but less than 50	200	150	200
50 or greater	300	200	300

Note: For shoulder widths adjacent to the passing blister, see auxiliary widths in Chapters Fifty-three and Fifty-five.

TYPICAL PASSING BLISTER FOR A 2-LANE HIGHWAY
Figure 46-40

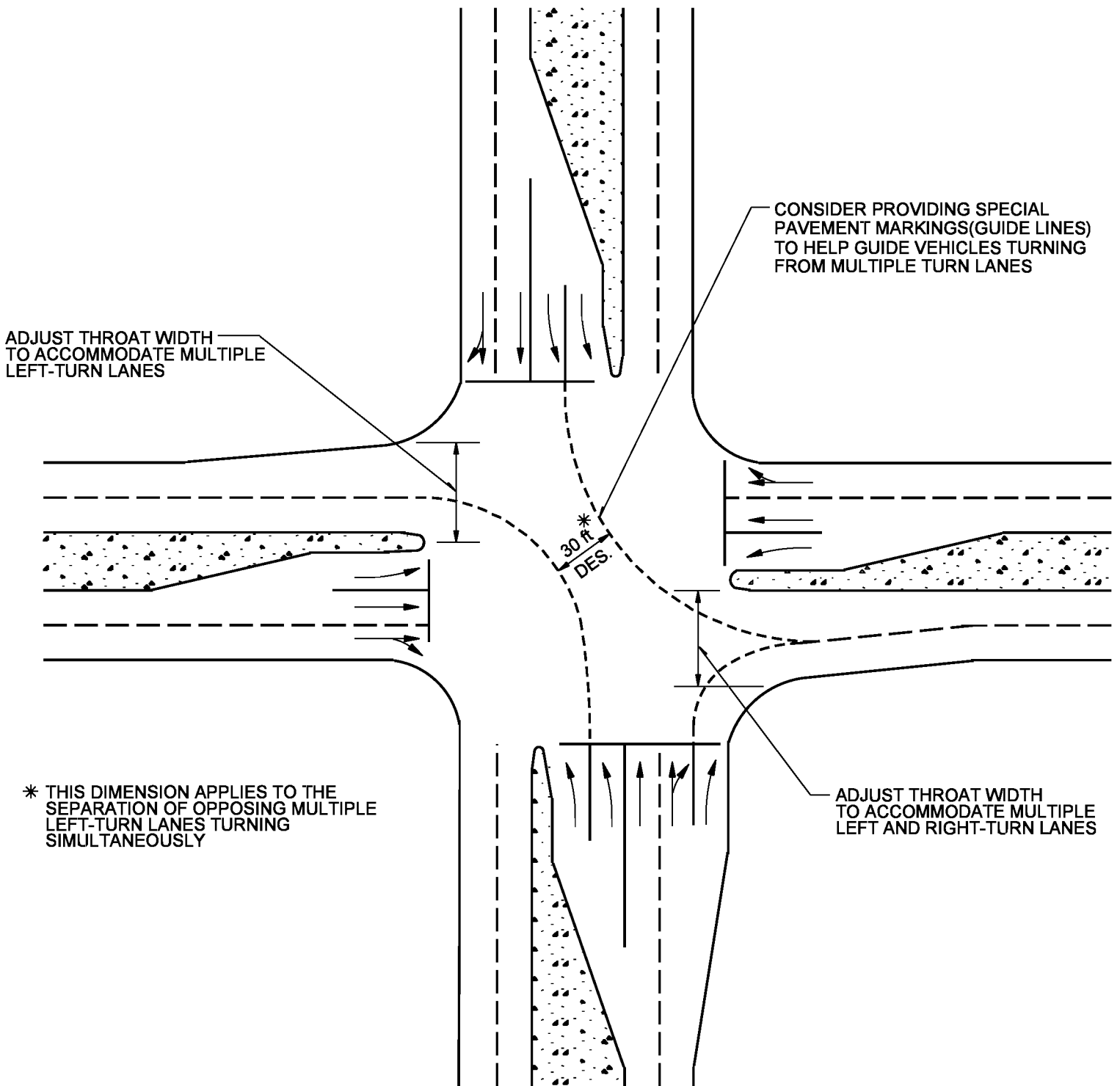

SCHEMATIC FOR MULTIPLE TURN LANES

Figure 46-4P

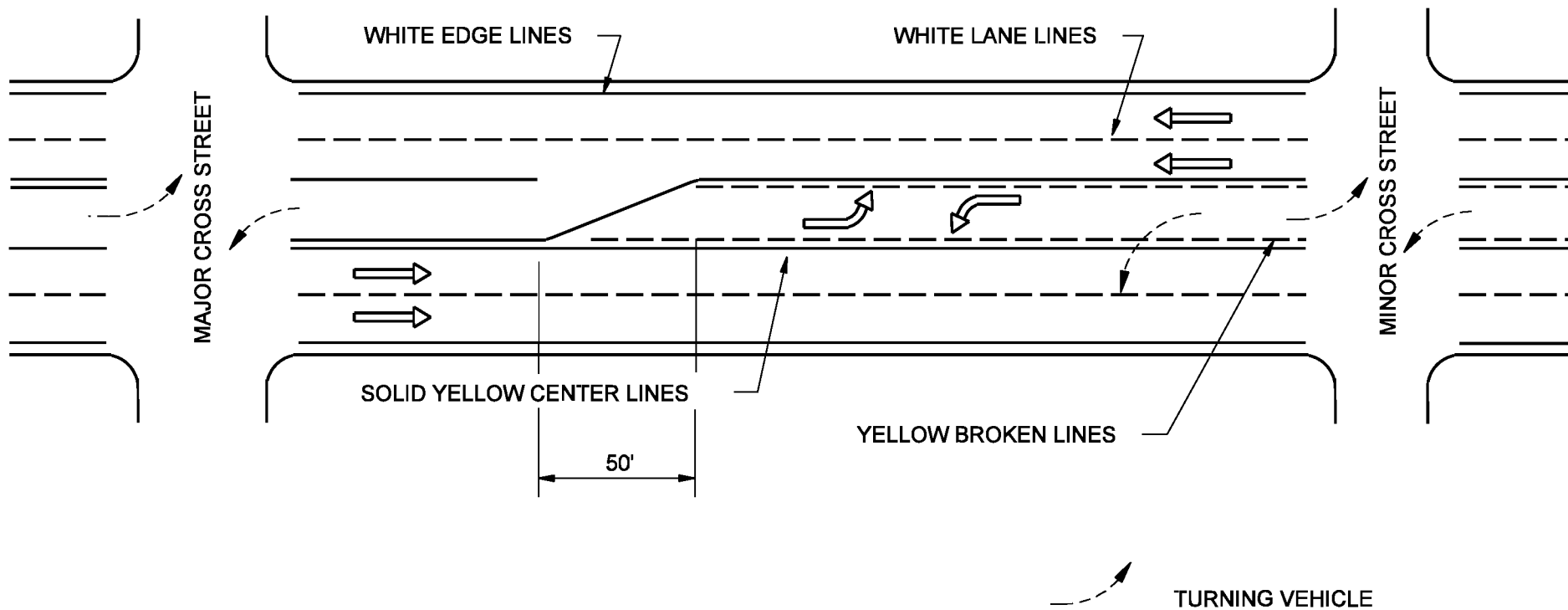

Note: See Chapter Seventy-six for additional information on pavement marking details.

TYPICAL PAVEMENT MARKINGS FOR A TWLTL

Figure 46-5A

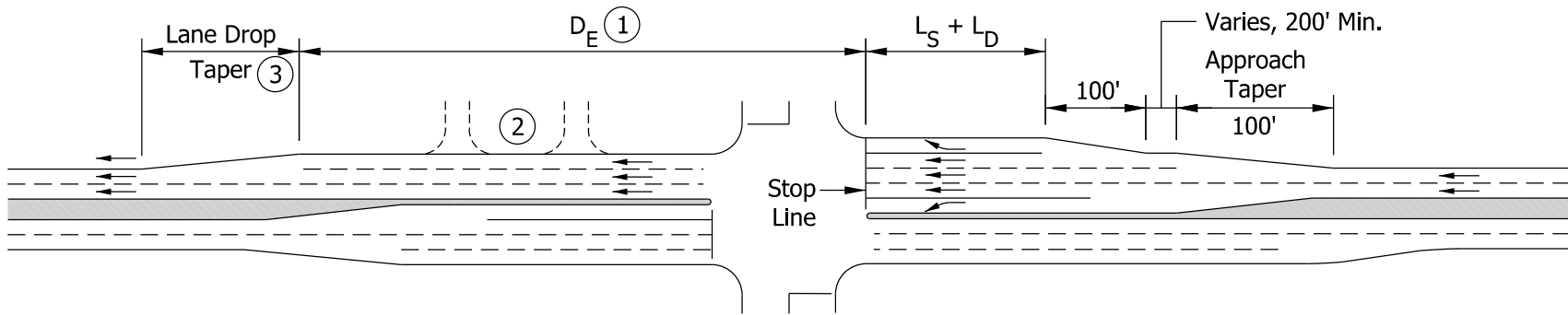

Design Speed (mph)	D_E (ft) (1) (Minimum)	Lane Drop Taper (3)
30	200	20:1
40	330	25:1
45	480	45:1
50	710	50:1
55	970	60:1
60	1450	65:1

NOTES:

- ① D_E is that distance required by the vehicle to accelerate from a stop to 6 mph below the average running speed.
- ② If driveways are present, D_E may need to be increased.
- ③ Sharper taper rates may be used in urban areas, however the taper lengths should be at least 300 ft.
4. These criteria are for preliminary design purposes. The final design will be determined on a case-by-case basis.

EXTENSION OF ADDITIONAL THROUGH LANES

Figure 46-7A

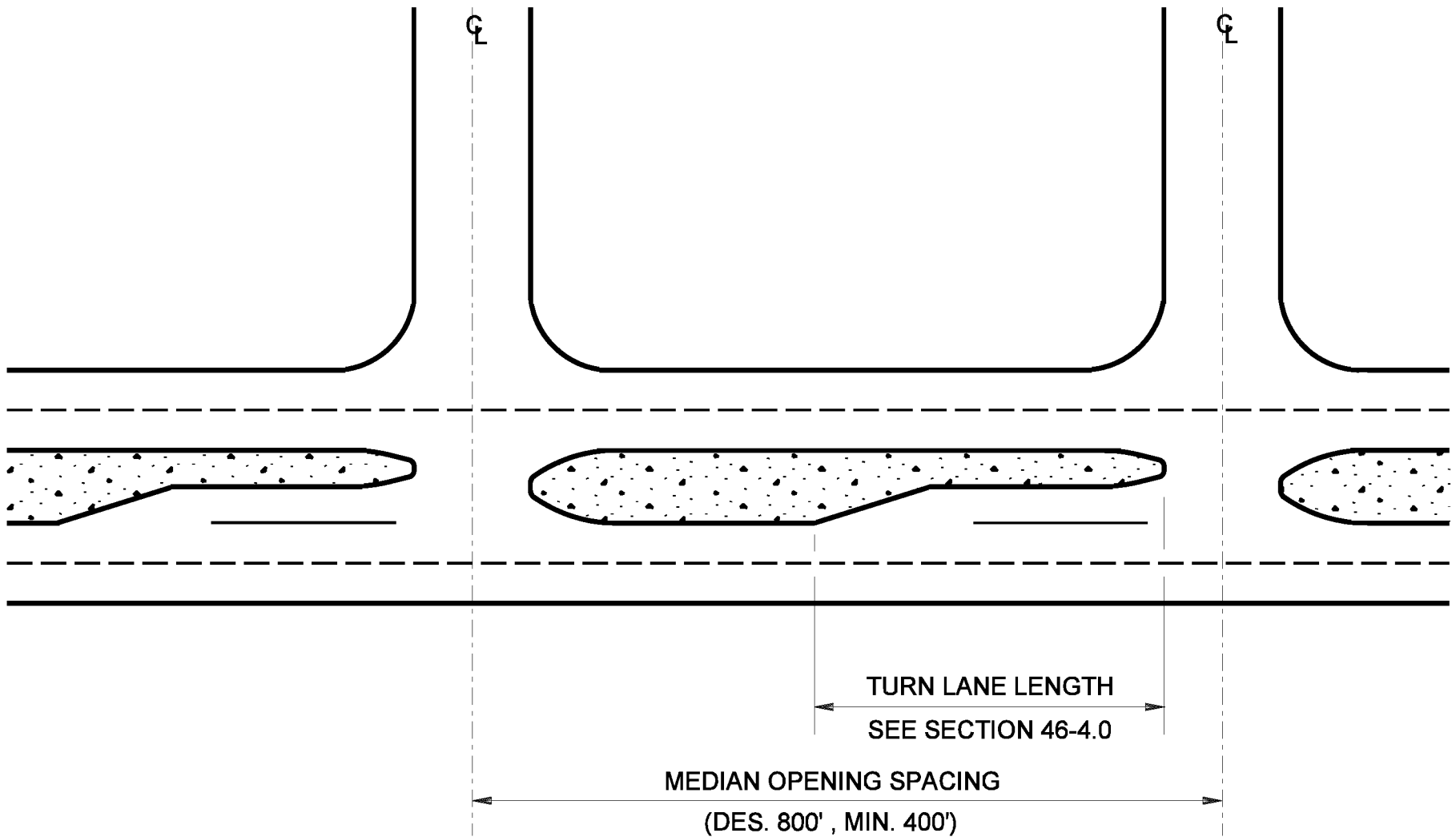

**RECOMMENDED MEDIAN OPENING SPACING
(Non-Freeway)**

Figure 46-8A

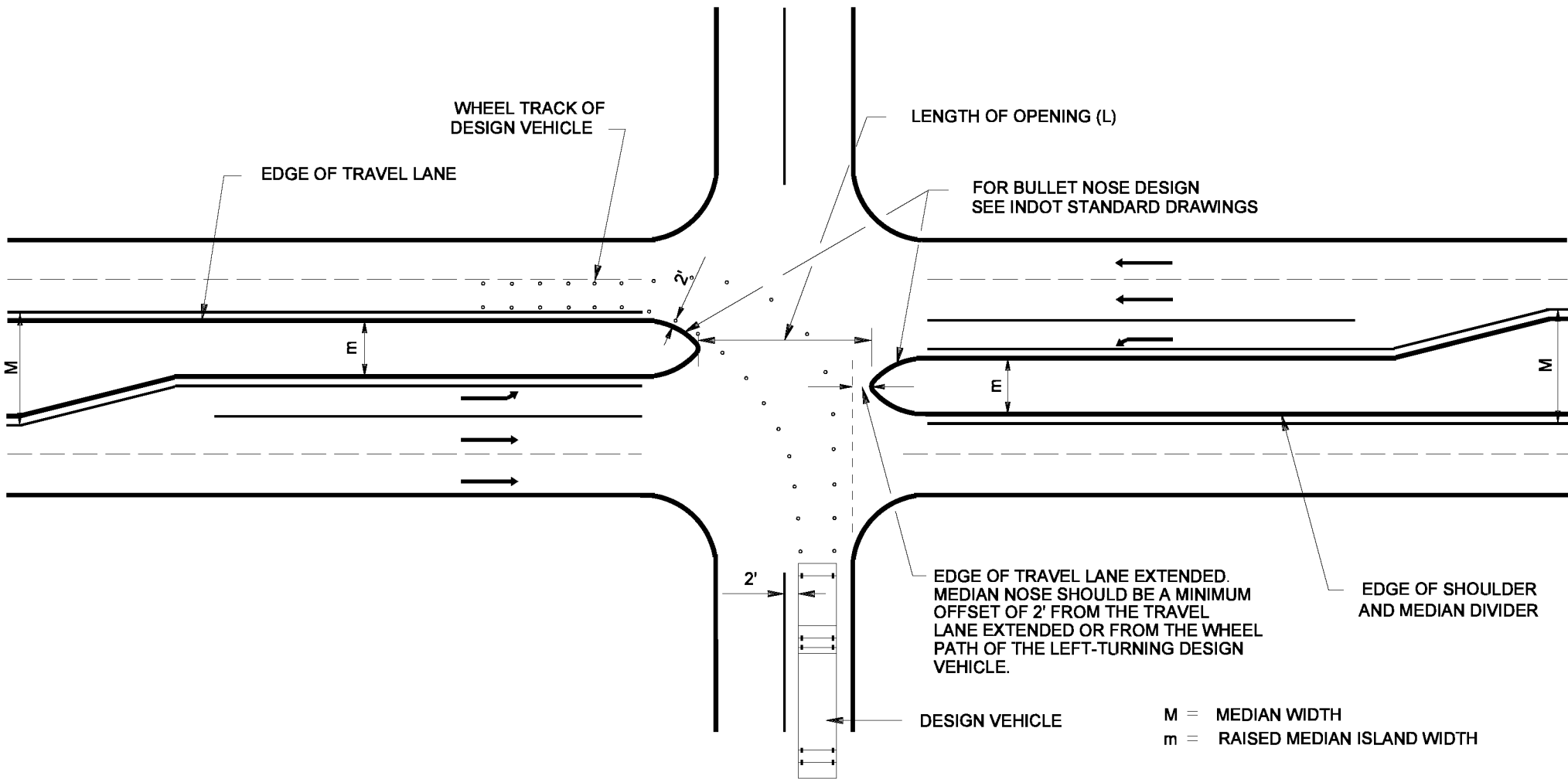

MEDIAN OPENING DESIGN

Figure 46-8B

Median Width, M (ft)	Minimum Length of Median Opening, L (ft)	
	Semicircular	Bullet Nose
4	130	115
16	120	75
20	115	70
28	105	55
36	95	45
50	85	40 Min.
60	75	40 Min.

**MINIMUM DESIGN OF MEDIAN OPENING
(Control Radius of 70 ft)**

Figure 46-8C

Median Width, M (ft)	Minimum Length of Median Opening, L (ft)	
	Semicircular	Bullet Nose
4	165	150
16	150	105
20	145	100
28	140	80
36	130	70
50	115	55
60	105	45

**MINIMUM DESIGN OF MEDIAN OPENING
(Control Radius of 85 ft)**

Figure 46-8D

Median Width, M (ft)	Minimum Length of Median Opening, L (ft)	
	Semicircular	Bullet Nose
4	195	180
16	185	135
20	180	125
28	170	105
36	160	90
50	150	75
60	140	60

**MINIMUM DESIGN OF MEDIAN OPENING
(Control Radius of 100 ft)**

Figure 46-8E

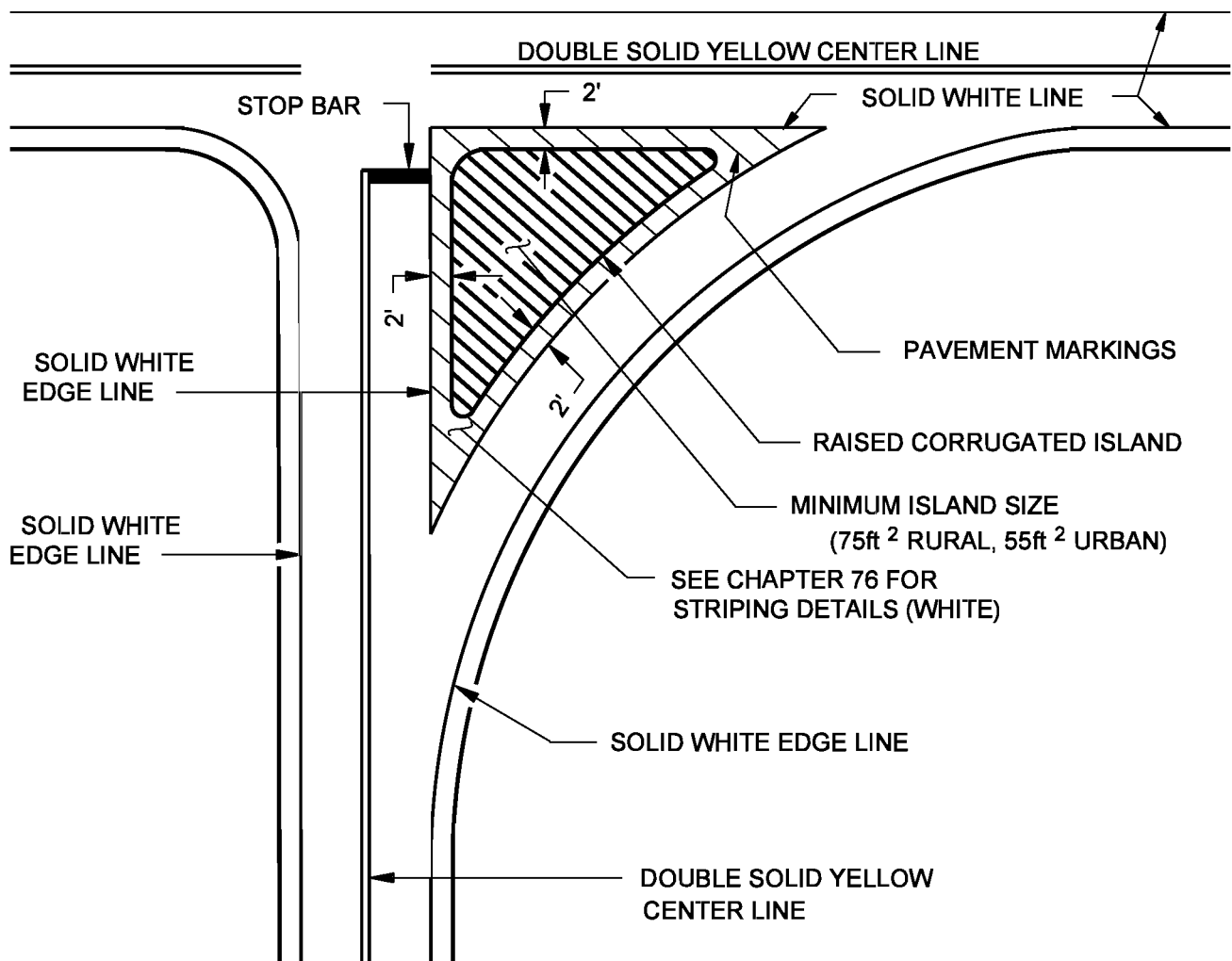

TRIANGULAR ISLAND

Figure 46-9A

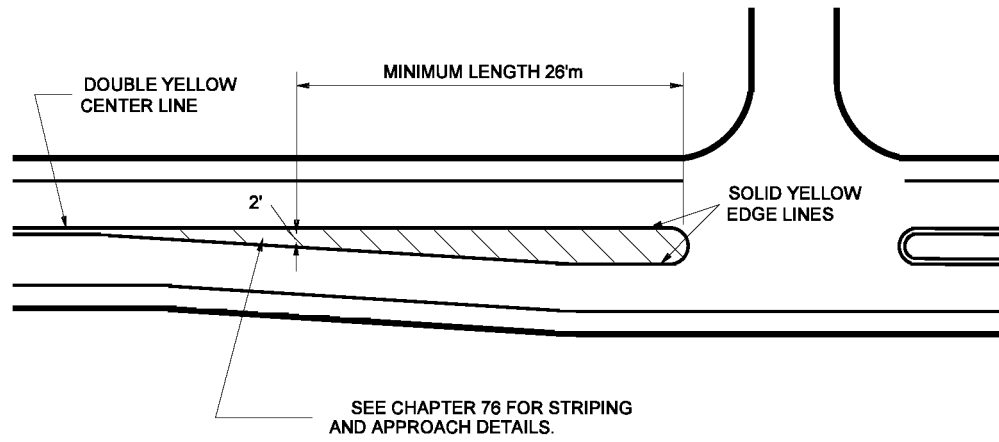

PAINTED FLUSH ISLAND

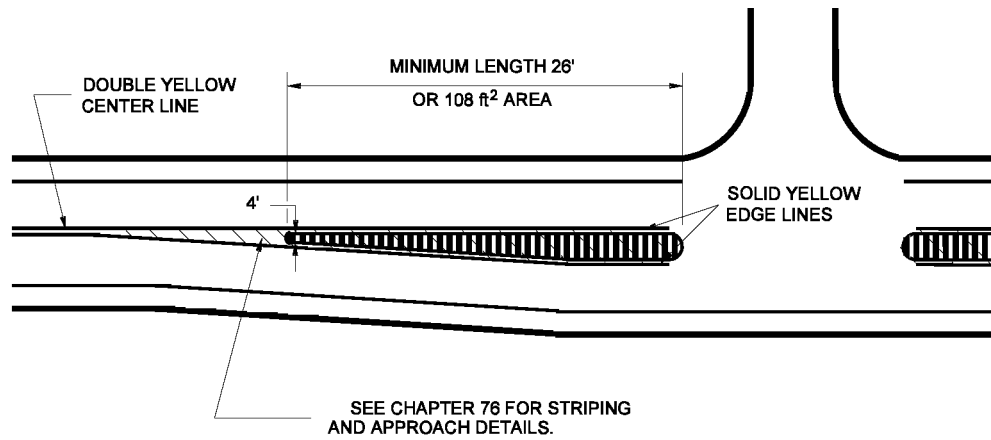

RAISED CORRUGATED ISLAND

ELONGATED ISLANDS

Figure 46-9B

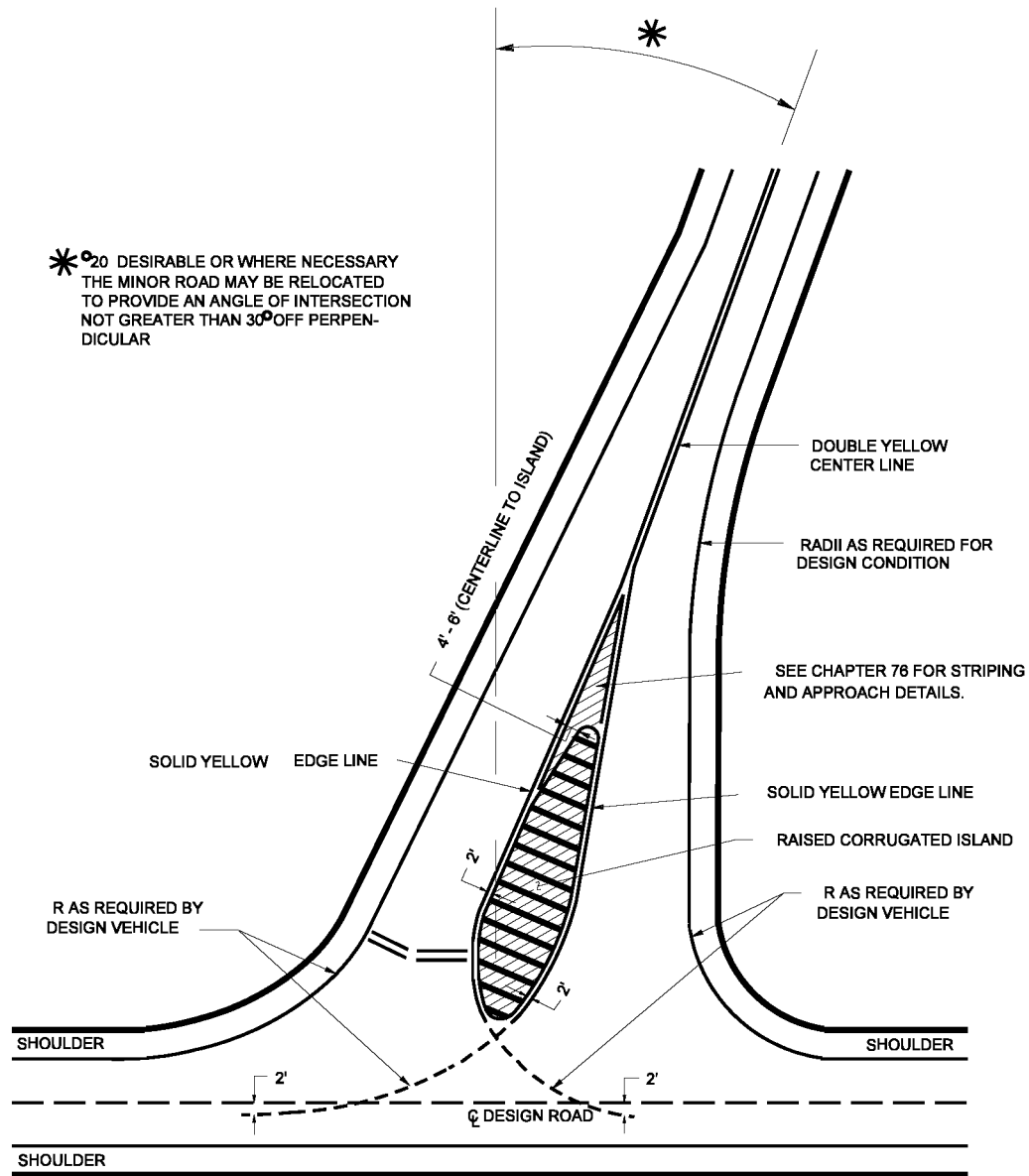

EXAMPLE OF A CHANNELIZING INTERSECTION

Figure 46-9C

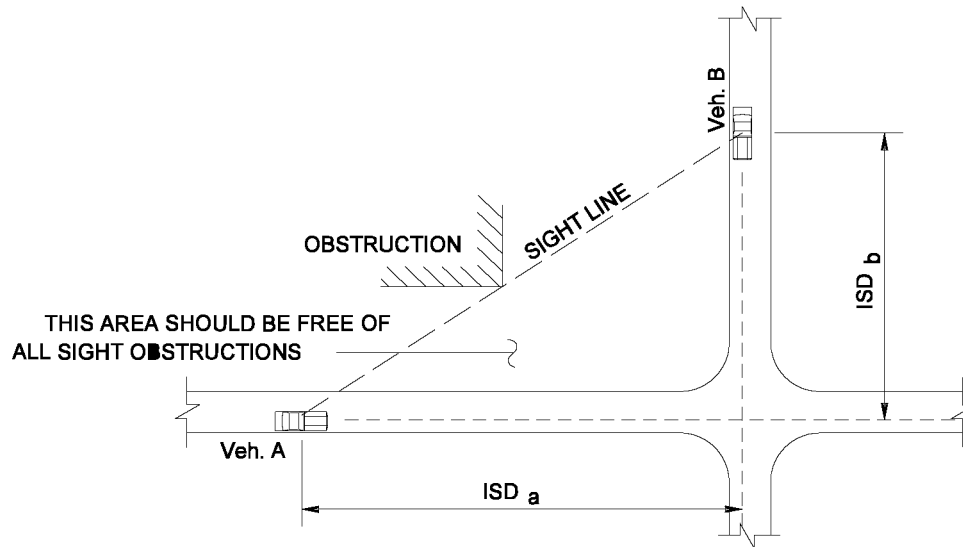

Design Speed (mph)	10	20	25	30	40	45	50	55	60
Intersection Sight Distance (ft)	65	75	110	145	180	215	250	300	350

Example

Given: No traffic control at intersection
 Design speed -- 40 mph (Highway A)
 25 km/h (Highway B)

Problem: Determine legs of sight triangle.

Solution: From above table -- ISD _a = 180 ft
 ISD _b = 110 ft

Note: This figure is not applicable for State highways.

**INTERSECTION SIGHT DISTANCE
 (No traffic control)**

Figure 46-10A

Approach Grade (%)	Design Speed (mph)											
	15	20	25	30	35	40	45	50	55	60	65	70
-6	1.1	1.1	1.1	1.1	1.1	1.1	1.1	1.2	1.2	1.2	1.2	1.2
-5	1.0	1.0	1.0	1.0	1.1	1.1	1.1	1.1	1.1	1.1	1.2	1.2
-4	1.0	1.0	1.0	1.1	1.1	1.1	1.1	1.1	1.1	1.1	1.1	1.1
-3 to +3	1.0	1.0	1.0	1.0	1.0	1.0	1.0	1.0	1.0	1.0	1.0	1.0
+4	1.0	1.0	1.0	1.0	1.0	0.9	0.9	0.9	0.9	0.9	0.9	0.9
+5	1.0	1.0	1.0	0.9	0.9	0.9	0.9	0.9	0.9	0.9	0.9	0.9
+6	1.0	1.0	0.9	0.9	0.9	0.9	0.9	0.9	0.9	0.9	0.9	0.9

Note: Factor is based on ratio of stopping sight distance on specified approach grade to stopping sight distance on level terrain.

**ADJUSTMENT FACTOR FOR SIGHT DISTANCE
WITH NO TRAFFIC CONTROL**

Figure 46-10B

Design Vehicle	Time Gap, t_g (s)
Passenger Car	8
Single-Unit Truck	10
Combination Truck	12

Note: Time gap is for a vehicle to turn right or left onto a two-lane highway with no median. The table values require adjustments for a multilane highway as follows:

- 1. For a left turn onto a two-way highway with more than two lanes, add 0.5 s for a passenger car or 0.7 s for a truck for each additional lane, from left, in excess of one, to be crossed by the turning vehicle.*
- 2. For a right turn, no adjustment is necessary.*

TIME GAP FOR LEFT OR RIGHT TURN, YIELD CONTROL

Figure 46-10C

Design Speed (mph)	Length of Leg, Passenger Car (ft)
15	180
20	240
25	295
30	355
35	415
40	475
45	530
50	590
55	650

Note: Distance shown is for passenger car making right or left turn onto two-lane road without stopping.

**DESIGN INTERSECTION SIGHT DISTANCE,
LEFT OR RIGHT TURN AT YIELD-CONTROLLED INTERSECTION**

Figure 46-10D

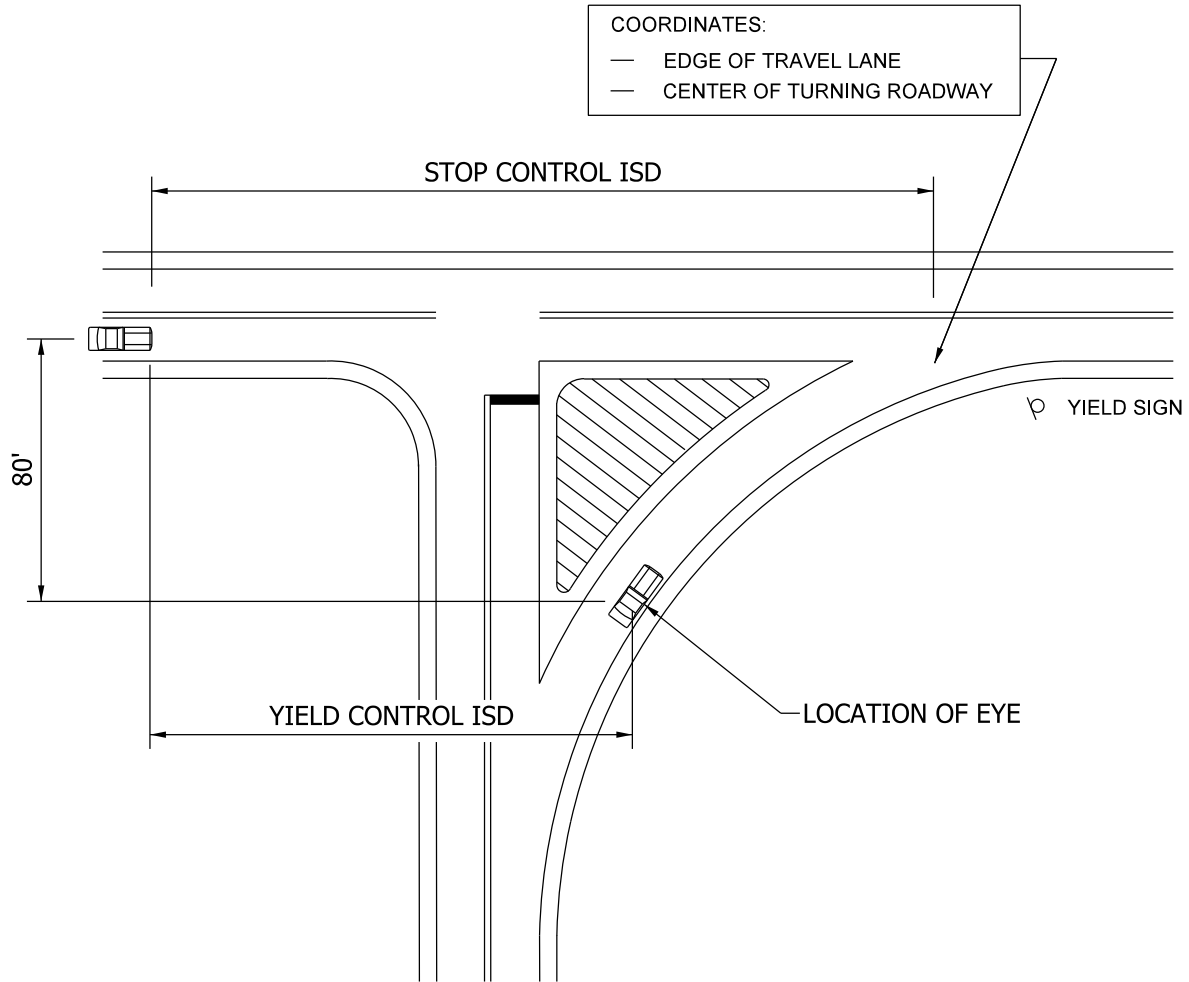

INTERSECTION SIGHT DISTANCE FOR TURNING ROADWAYS

Figure 46-10E

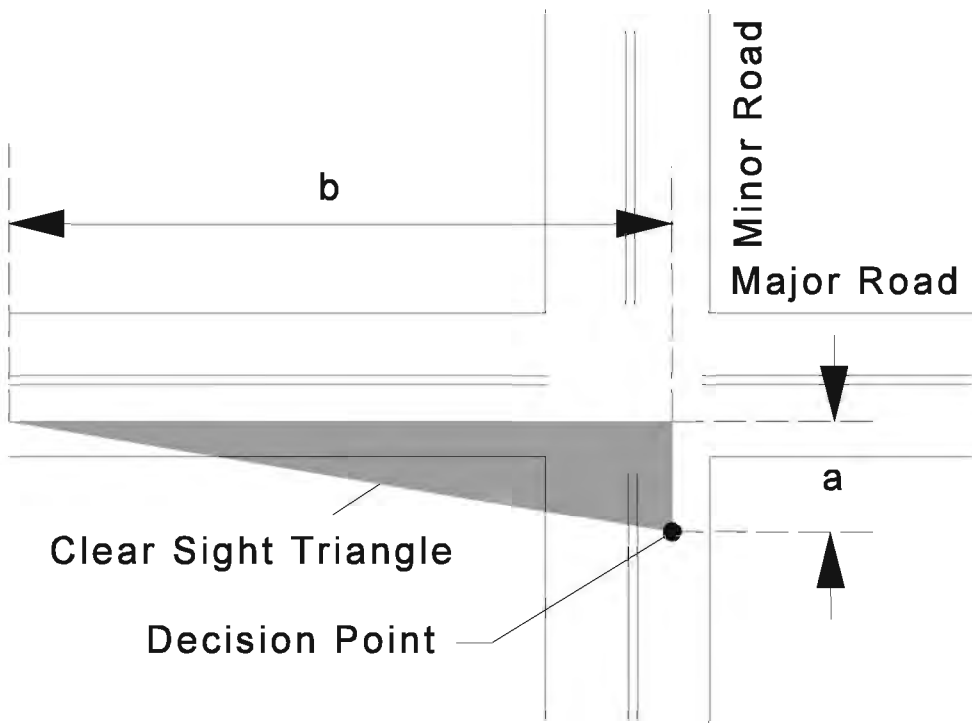

Clear Sight Triangle for Viewing
Traffic Approaching from the Left.

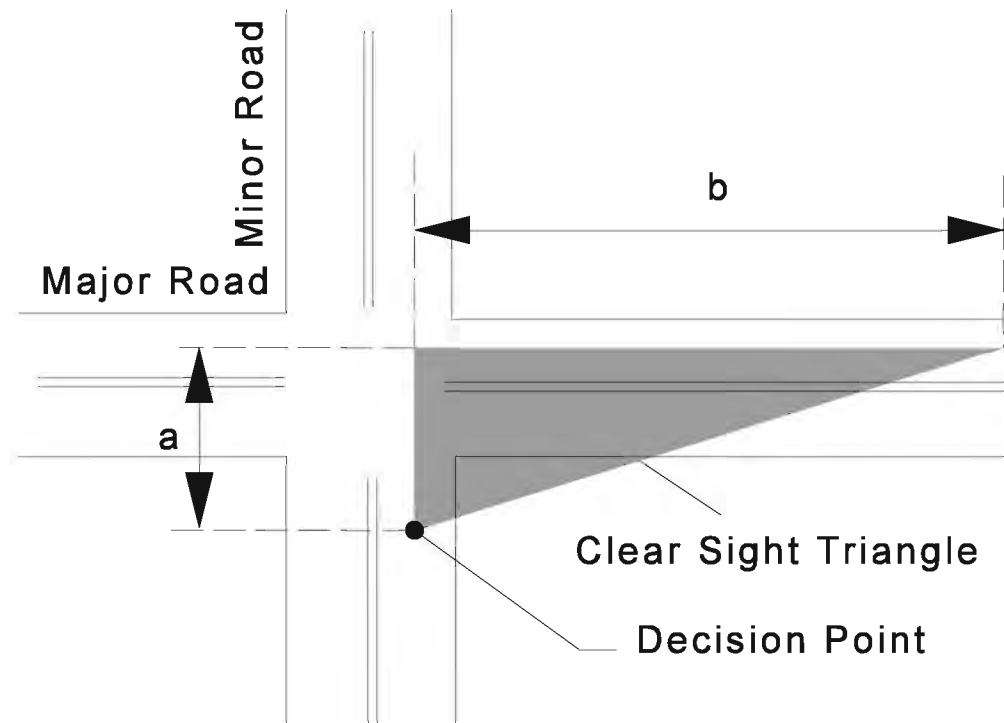

Clear Sight Triangle for Viewing
Traffic Approaching from the Right.

DEPARTURE SIGHT TRIANGLES

Figure 46-10F

V_{major} (mph)	Passenger Car				Single-Unit Truck		Combination Truck	
	Local Road		Collector or Arterial		t_g (s)	ISD (ft)	t_g (s)	ISD (ft)
	t_g (s)	ISD (ft)	t_g (s)	ISD (ft)				
15	7.5	170	7.5	170	9.5	210	11.5	260
20	7.5	220	7.5	220	9.5	280	11.5	340
25	7.5	280	7.5	280	9.5	350	11.5	430
30	7.5	330	7.5	330	9.5	420	11.5	510
35	7.5	390	7.5	390	9.5	490	11.5	600
40	7.5	440	7.5	440	9.5	560	11.5	680
45	7.5	500	7.5	500	9.5	630	11.5	760
50	7.5	550	8.5	630	10.5	780	12.5	920
55	7.5	610	9.0	730	11.0	890	13.0	1060
60	7.5	670	9.5	840	11.5	1020	13.5	1190
65	7.5	720	10.0	960	12.0	1150	14.0	1340
70	7.5	780	10.0	1030	12.0	1240	14.0	1440

V_{major} = Design speed of major road

t_g = Time gap for minor road vehicle to enter major road

ISD = Intersection sight distance (length of leg of sight triangle along major road)

ISD is shown for a stopped vehicle to turn left onto a two-lane highway with approach grades of 3% or flatter. For other conditions, the time gap should be adjusted and the required ISD recalculated using the formula $ISD = 1.47 V_{major} t_g$.

For a left turn onto a two-way highway with more than two lanes, add 0.5 s for a passenger car, or 0.7 s for a truck for each additional lane from the left in excess of one, to be crossed by a turning vehicle.

For the minor-road approach, if its grade is an upgrade that is steeper than 3%, add 0.2 s for each percent grade for a left turn. The adjustment for the minor-road approach grade is required only if the rear wheels of the design vehicle would be on an upgrade steeper than 3%.

INTERSECTION SIGHT DISTANCE FOR STOP-CONTROLLED INTERSECTION

Figure 46-10G

Design Speed (mph)	Intersection Sight Distance For Passenger Car	
	Calculated (ft)	Design (ft)
15	143.3	145
20	191.1	195
25	238.9	240
30	286.7	290
35	334.4	335
40	382.2	385
45	430.0	430
50	477.8	480
55	525.5	530
60	573.3	575
65	621.1	625
70	668.9	670

Note: Intersection sight distance shown is for a stopped passenger car to turn right onto or cross a two-lane highway with no median and grades of 3% or flatter. For other conditions, the time gap should be adjusted and the required sight distance recalculated.

**INTERSECTION SIGHT DISTANCE FOR PASSENGER CAR
TO TURN RIGHT FROM A STOP OR TO MAKE A CROSSING MANEUVER**

Figure 46-10H

Design Vehicle	Time Gap, t_g (s)*
Passenger Car	6.5
Single-Unit Truck	8.5
Combination Truck	10.5

- * For crossing a major road with more than two lanes, add 0.5 s for a passenger car, or 0.7 s for a truck, for each additional lane or narrow median to be crossed. A narrow median is one that cannot store the design vehicle.

If the minor-road approach grade is an upgrade that is steeper than 3%, add 0.1 s for each percent grade.

TIME GAP FOR CROSSING MANEUVER

Figure 46-10H(1)

Design Vehicle	Time Gap, t_g (s)*
Passenger Car	5.5
Single-unit truck	6.5
Combination truck	7.5

Divided Highway: For a left-turning vehicle crossing more than one opposing lane, add 0.5 s for a passenger car, or 0.7 s for a truck, for each additional lane to be crossed and for a narrow median that cannot store the design vehicle.

Minor Road Approach Grade: If the approach grade is an upgrade that is steeper than 3%, add 0.1 s for each percent grade.

TIME GAP FOR LEFT TURN FROM THE MAJOR ROAD

Figure 46-10 I

		Intersection Sight Distance For Passenger Car	
Design Speed (mph)	Stopping Sight Distance (ft)	Calculated (ft)	Design (ft)
15	80	121.3	125
20	115	161.7	165
25	155	202.1	205
30	200	242.6	245
35	250	283.0	285
40	305	323.4	325
45	360	363.8	365
50	425	404.3	405
55	495	444.7	445
60	570	485.1	490
65	645	525.5	530
70	730	566.0	570

Note: ISD is shown for a passenger car making a left turn from an undivided highway. For other conditions and design vehicles, the time gap should be adjusted and the required ISD recalculated.

**INTERSECTION SIGHT DISTANCE
FOR LEFT TURN FROM MAJOR ROAD**

Figure 46-10J

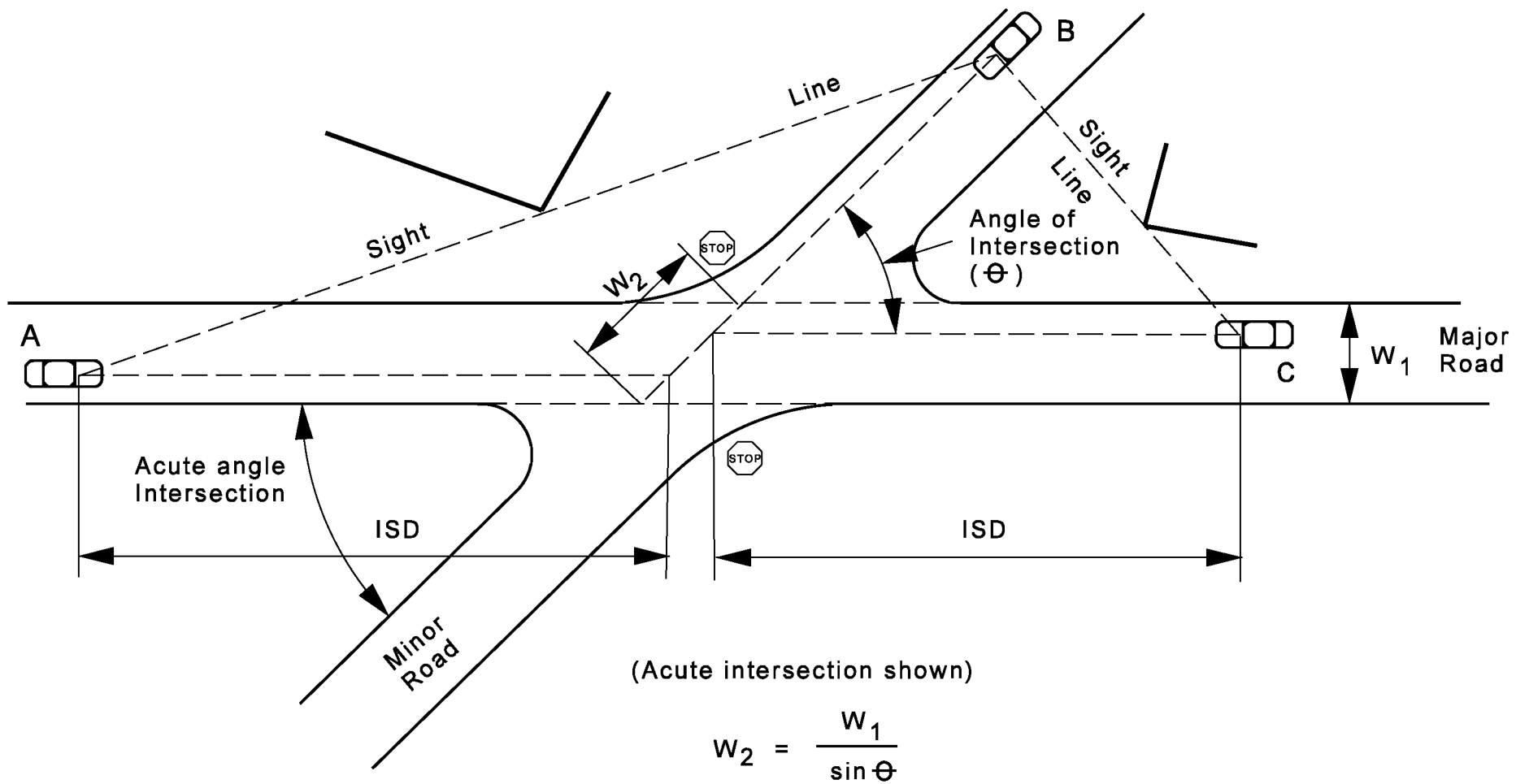

SIGHT TRIANGLES AT SKEWED INTERSECTIONS

Figure 46-10K

Slope	Divided Highway, ≥ 4 Lanes	Other Arterial	Collector	Local Road
10:1	All	All	Design Speed ≥ 50 mph	n/a
6:1	n/a	All	Design Speed ≥ 50 mph	n/a
4:1	n/a	n/a	Design Speed ≤ 45 mph	All

DRIVE EMBANKMENT SLOPES WITHIN CLEAR ZONE

Figure 46-11A

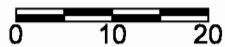
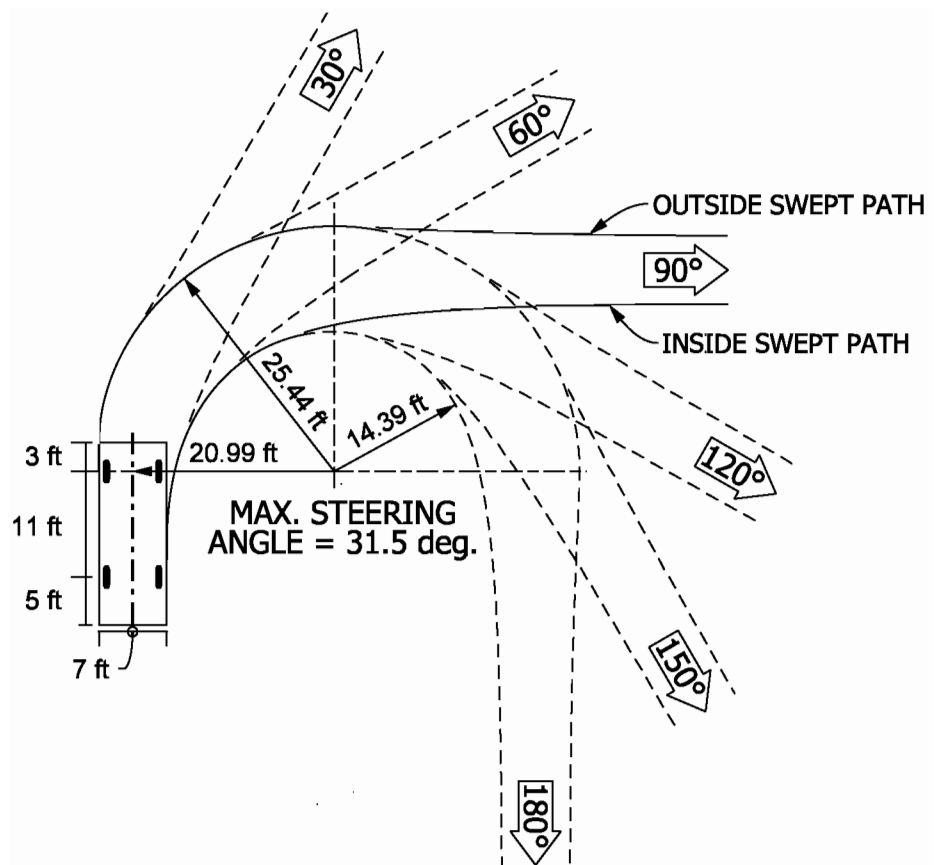

P - DESIGN VEHICLE
(1" = 20' SCALE)

Figure 46-12A

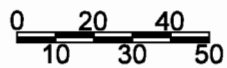
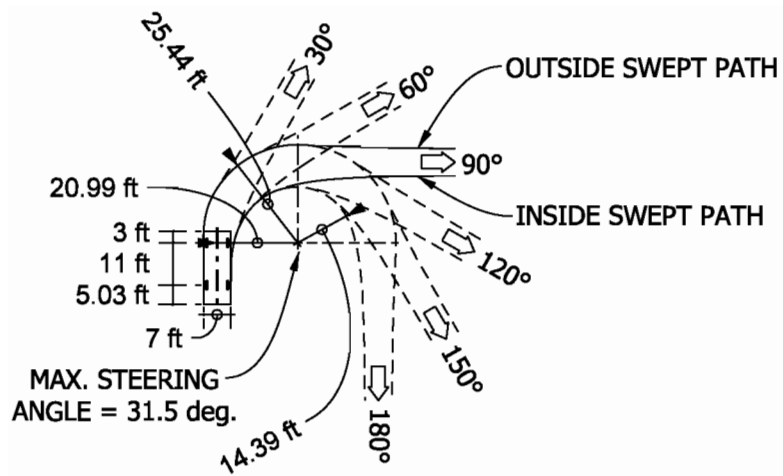

**P - DESIGN VEHICLE
(1" = 50' SCALE)**

Figure 46-12B

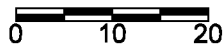
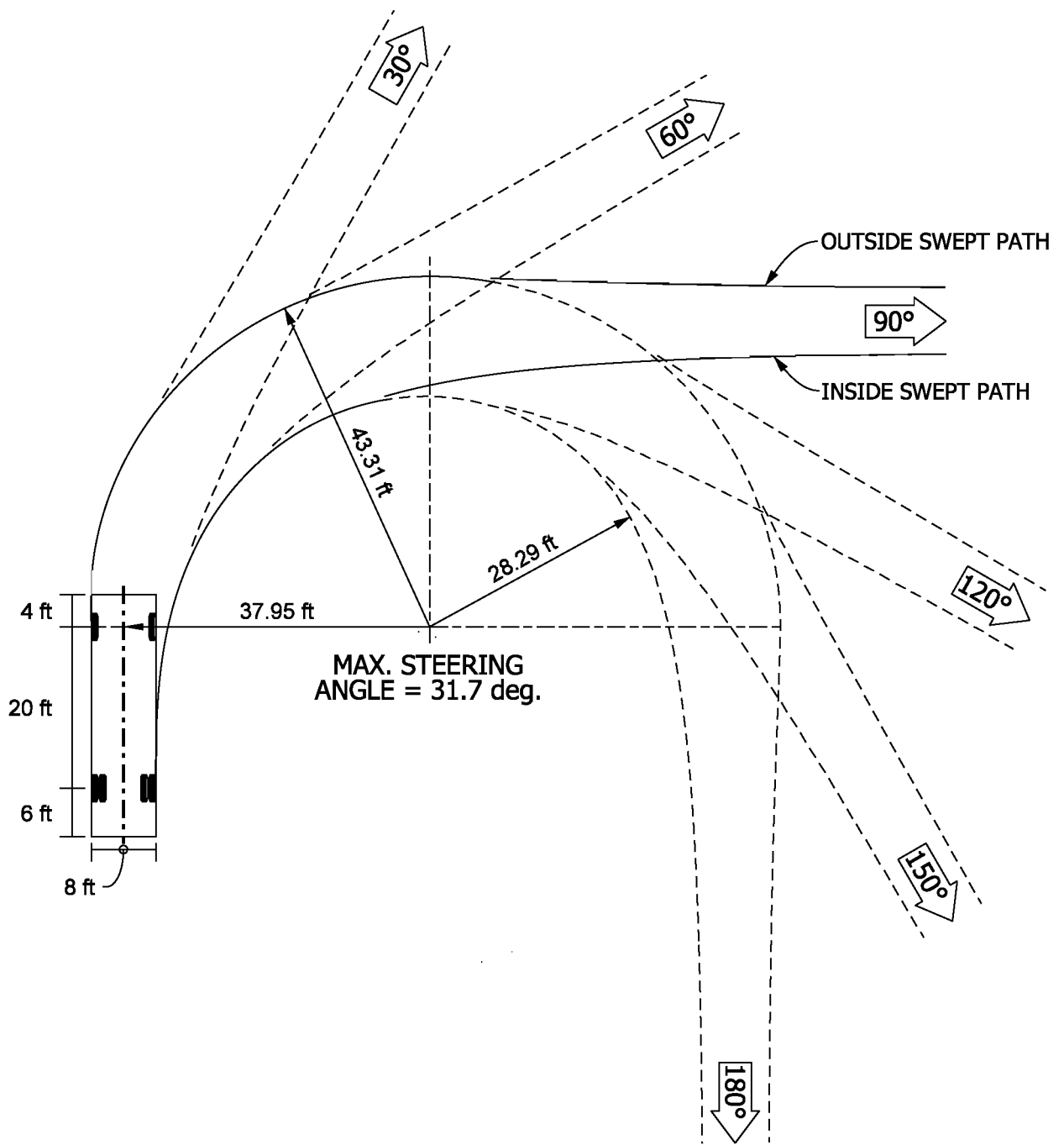

SU - DESIGN VEHICLE
(1" = 20' SCALE)

Figure 46 -12C

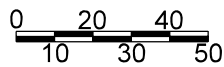
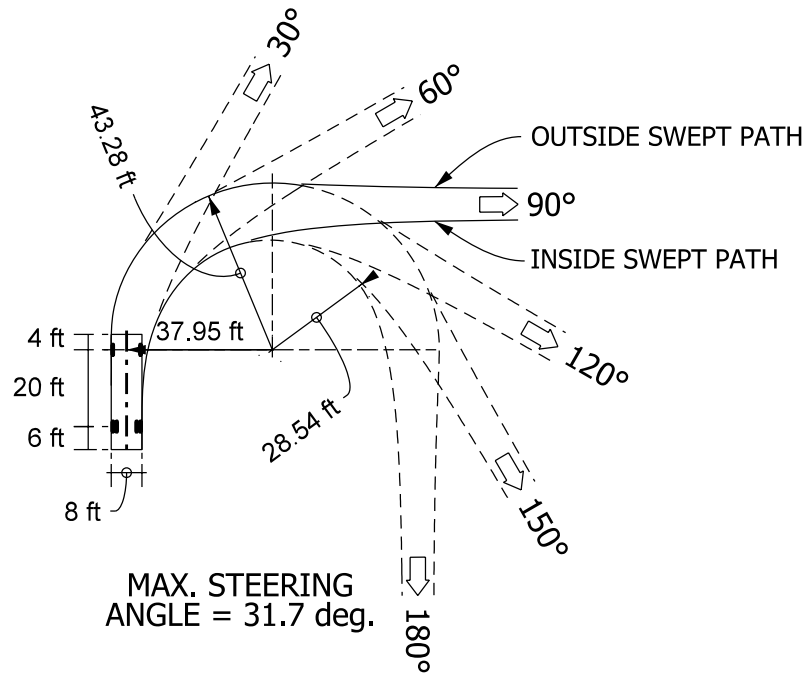

SU - DESIGN VEHICLE
(1" = 50' SCALE)

Figure 46 -12D

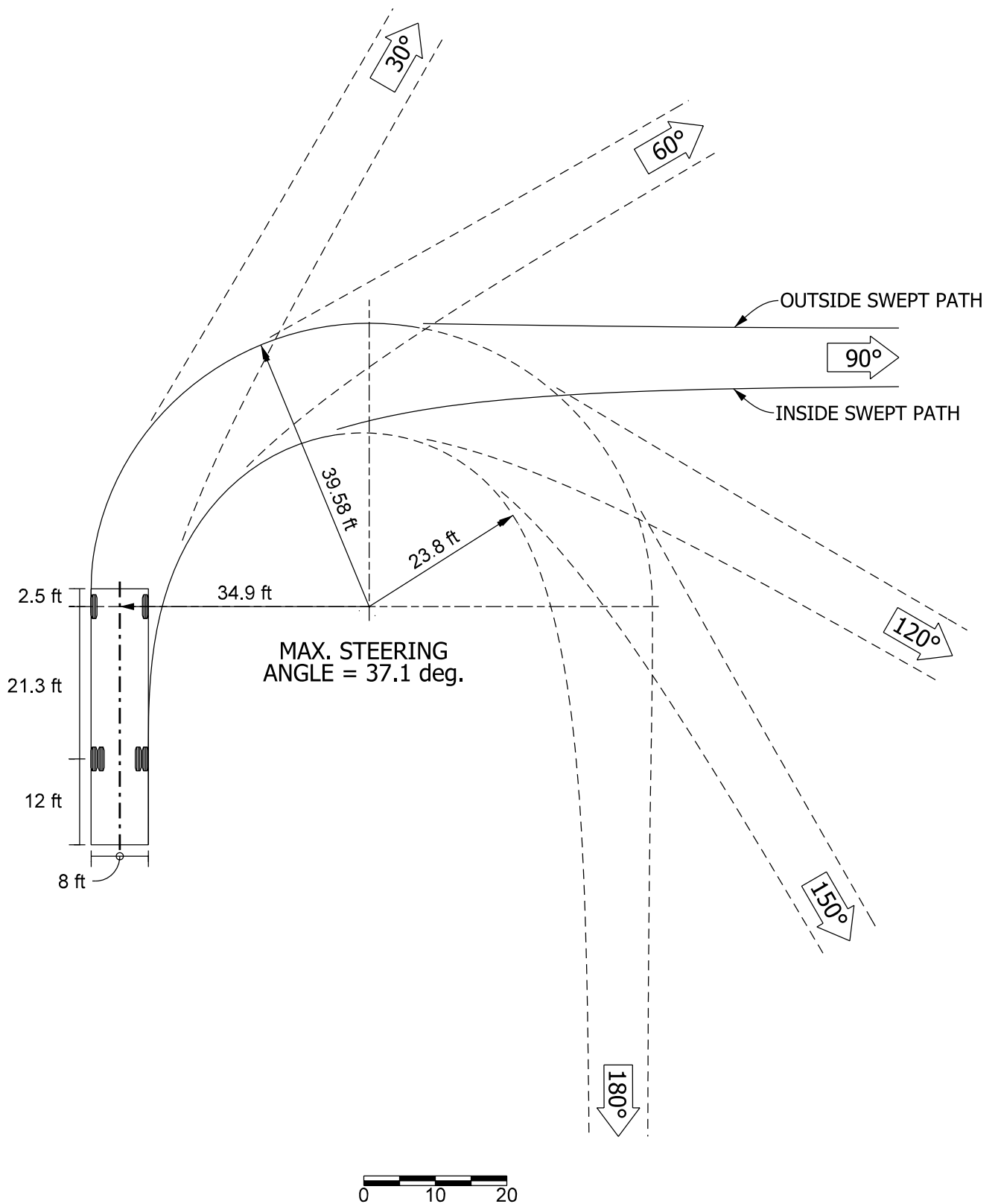

S-BUS-36 - DESIGN VEHICLE
 (1" = 20' SCALE)

Figure 46 -12D(1)

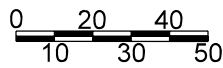
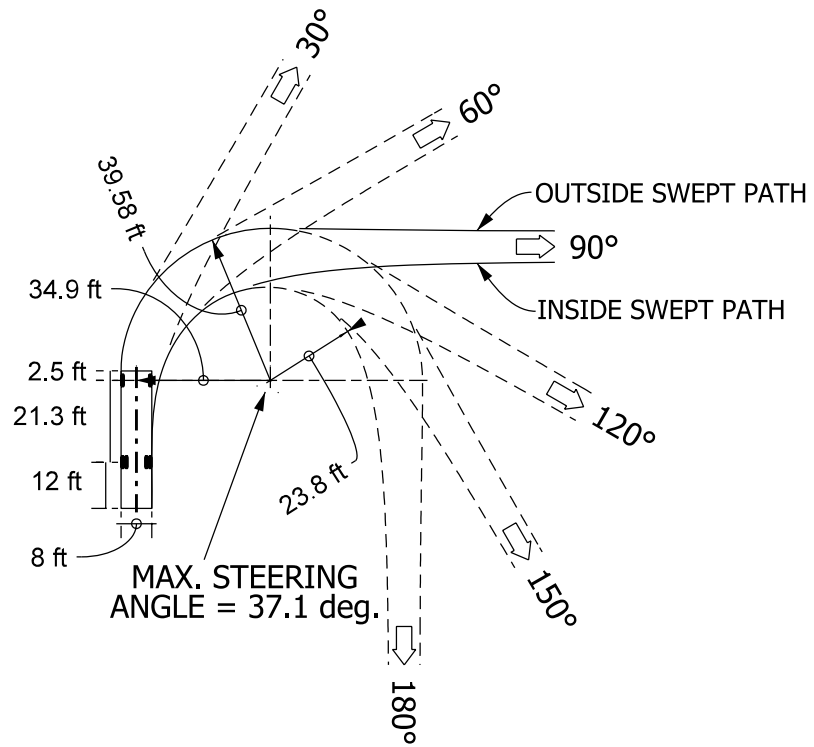

S-BUS-36 - DESIGN VEHICLE
(1" = 50' SCALE)

Figure 46 -12D(2)

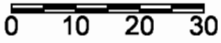
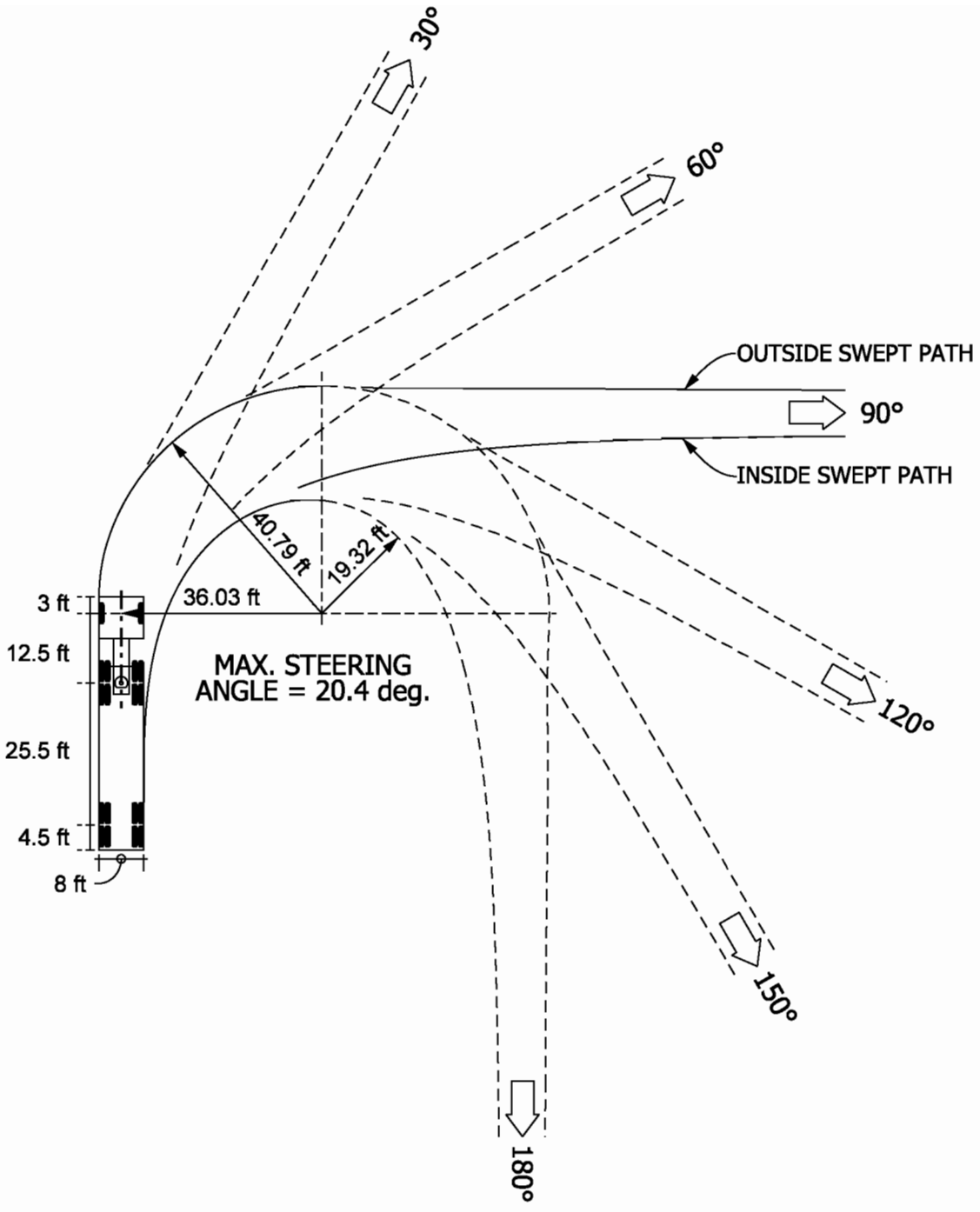

WB-40 - DESIGN VEHICLE
(1" = 30' SCALE)

Figure 46 -12E

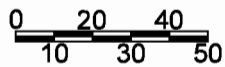
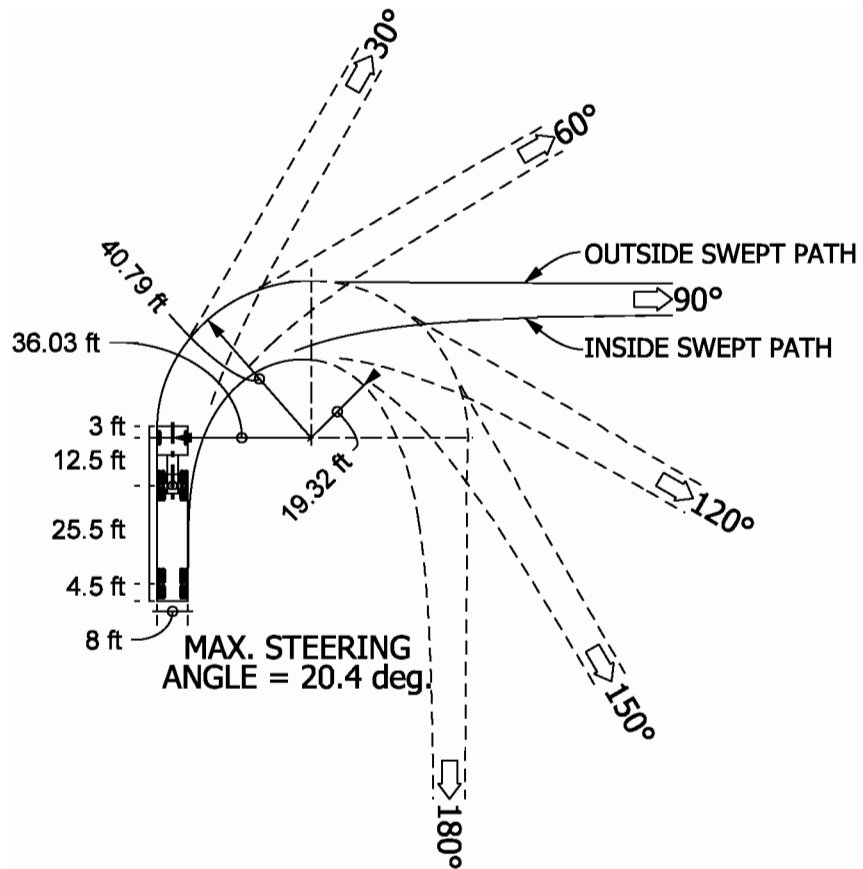

WB-40 - DESIGN VEHICLE
(1" = 50' SCALE)

Figure 46 -12F

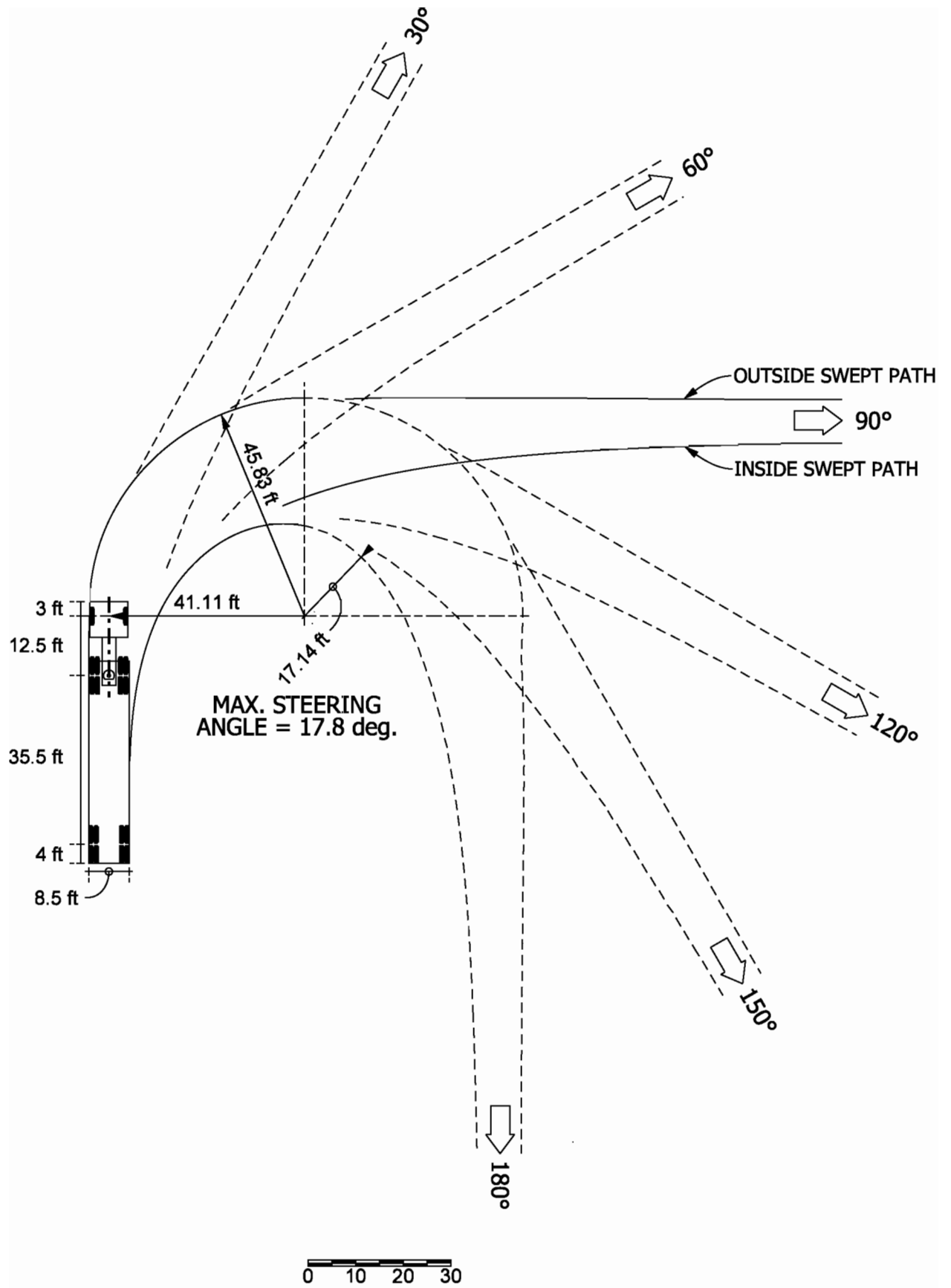

WB-50 - DESIGN VEHICLE
(1" = 30' SCALE)

Figure 46 -12G

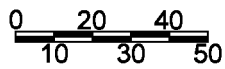
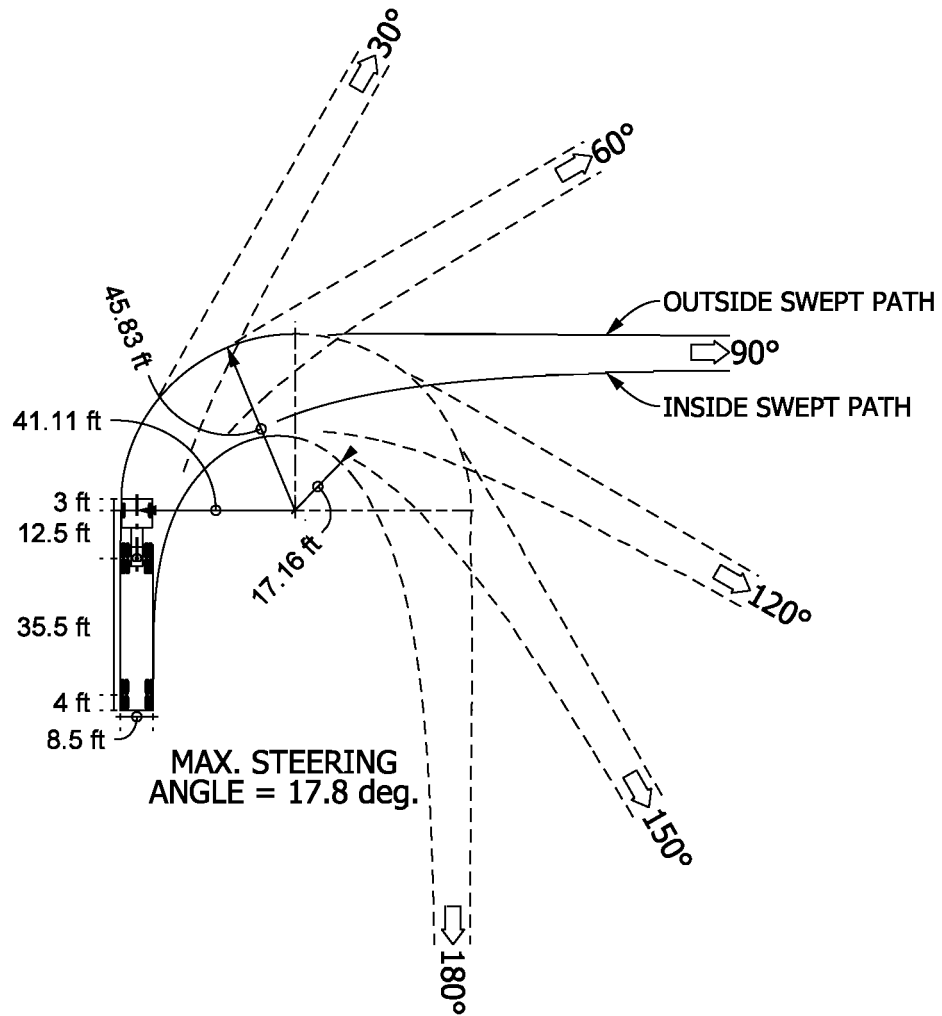

WB-50 - DESIGN VEHICLE
(1" = 50' SCALE)

Figure 46 -12H

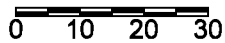
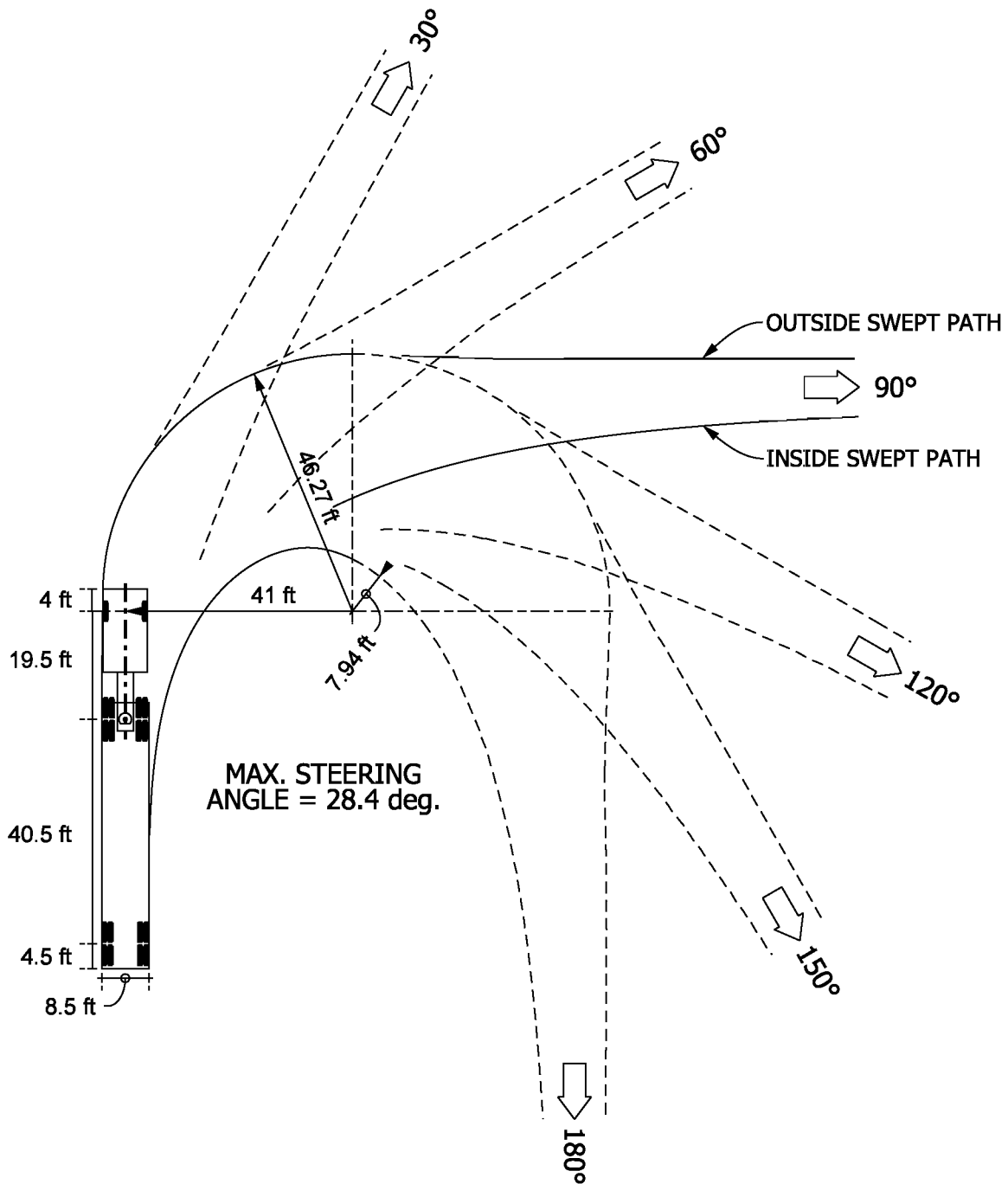

WB-62 - DESIGN VEHICLE
(1" = 30' SCALE)

Figure 46 -12 I

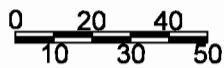
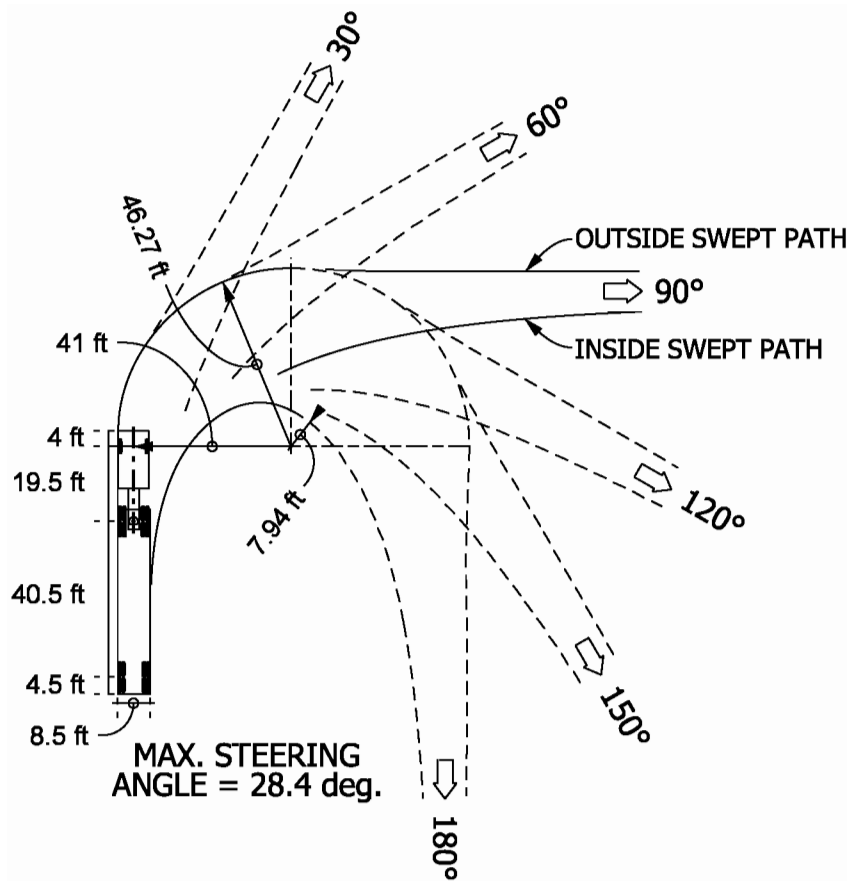

WB-62 - DESIGN VEHICLE
(1" = 50' SCALE)

Figure 46 -12J

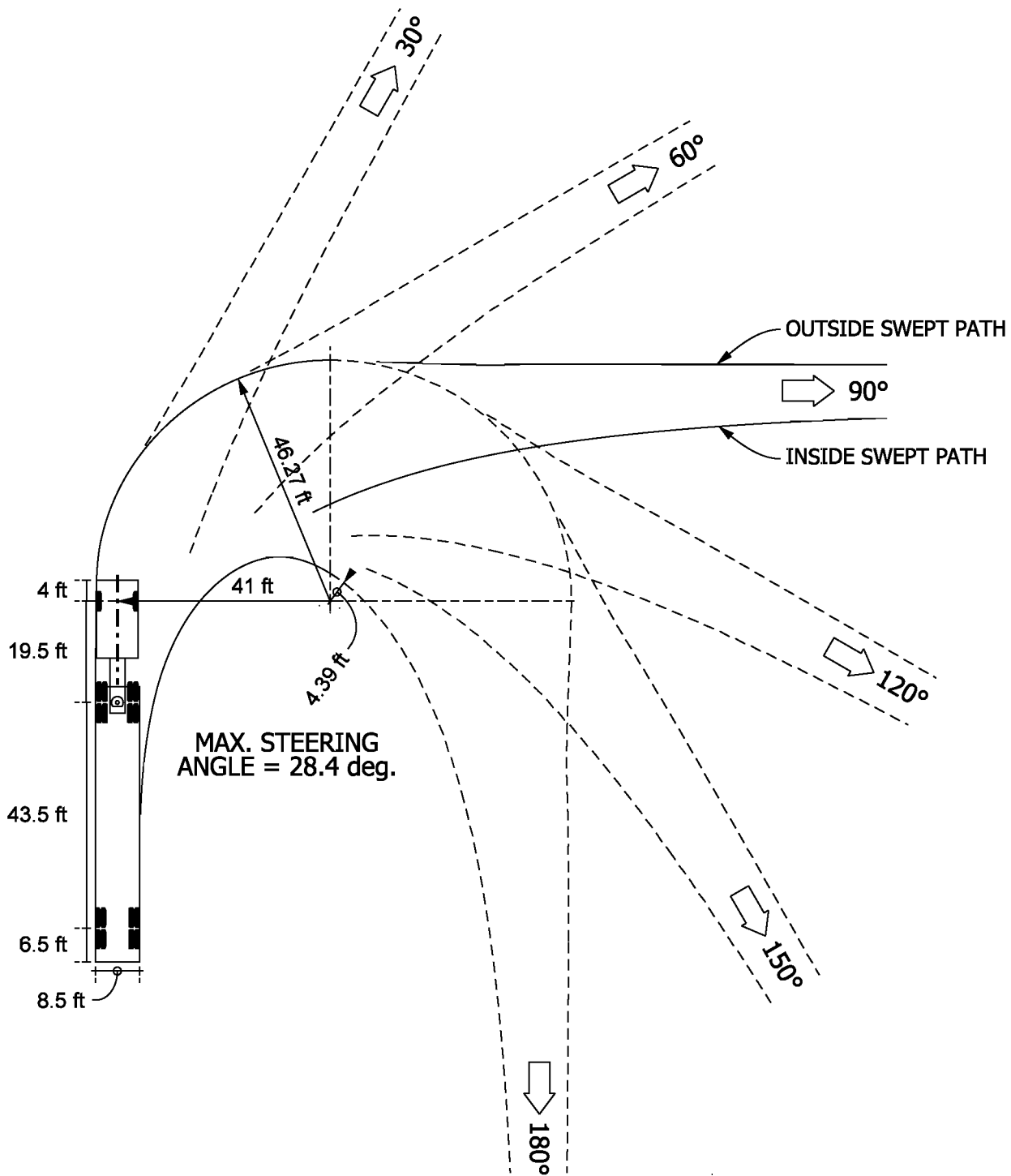

WB-65 (IDV) - DESIGN VEHICLE
(1" = 30' SCALE)

Figure 46 -12K

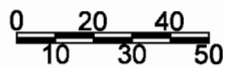
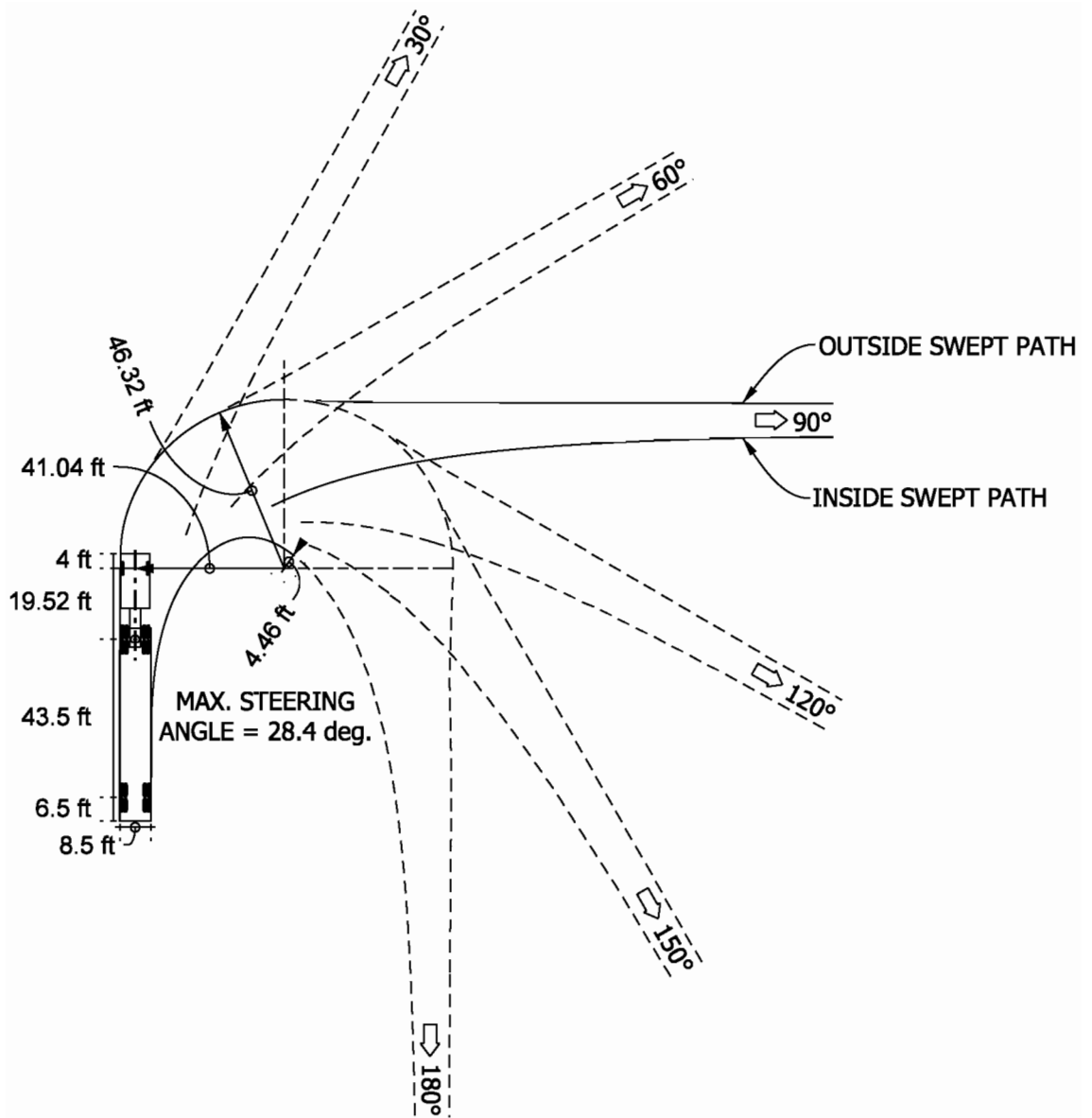

**WB-65 (IDV) - DESIGN VEHICLE
(1" = 50' SCALE)**

Figure 46-12L

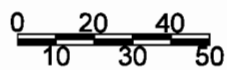
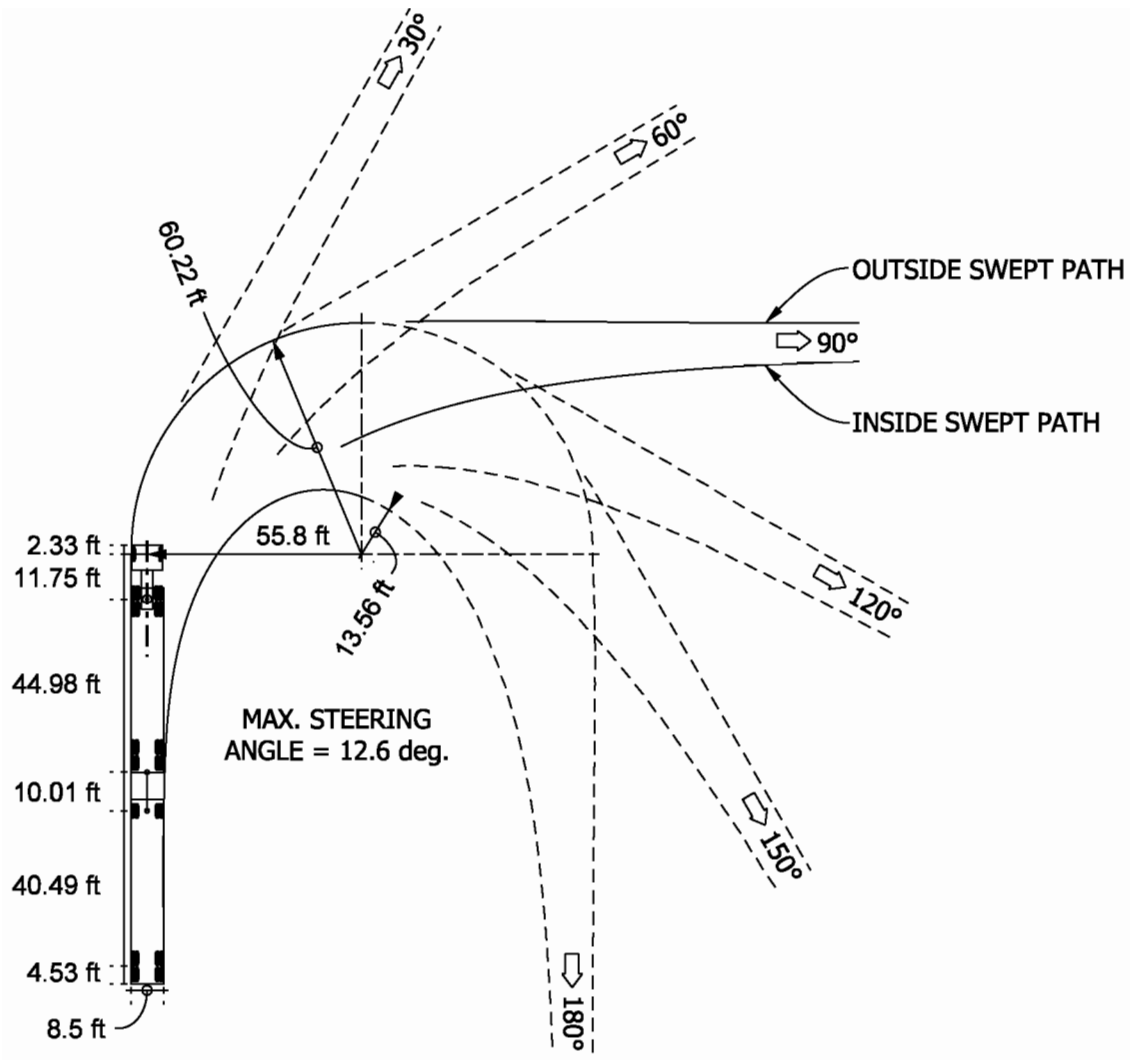

WB-109D - DESIGN VEHICLE
(1" = 50' SCALE)

Figure 46-12N

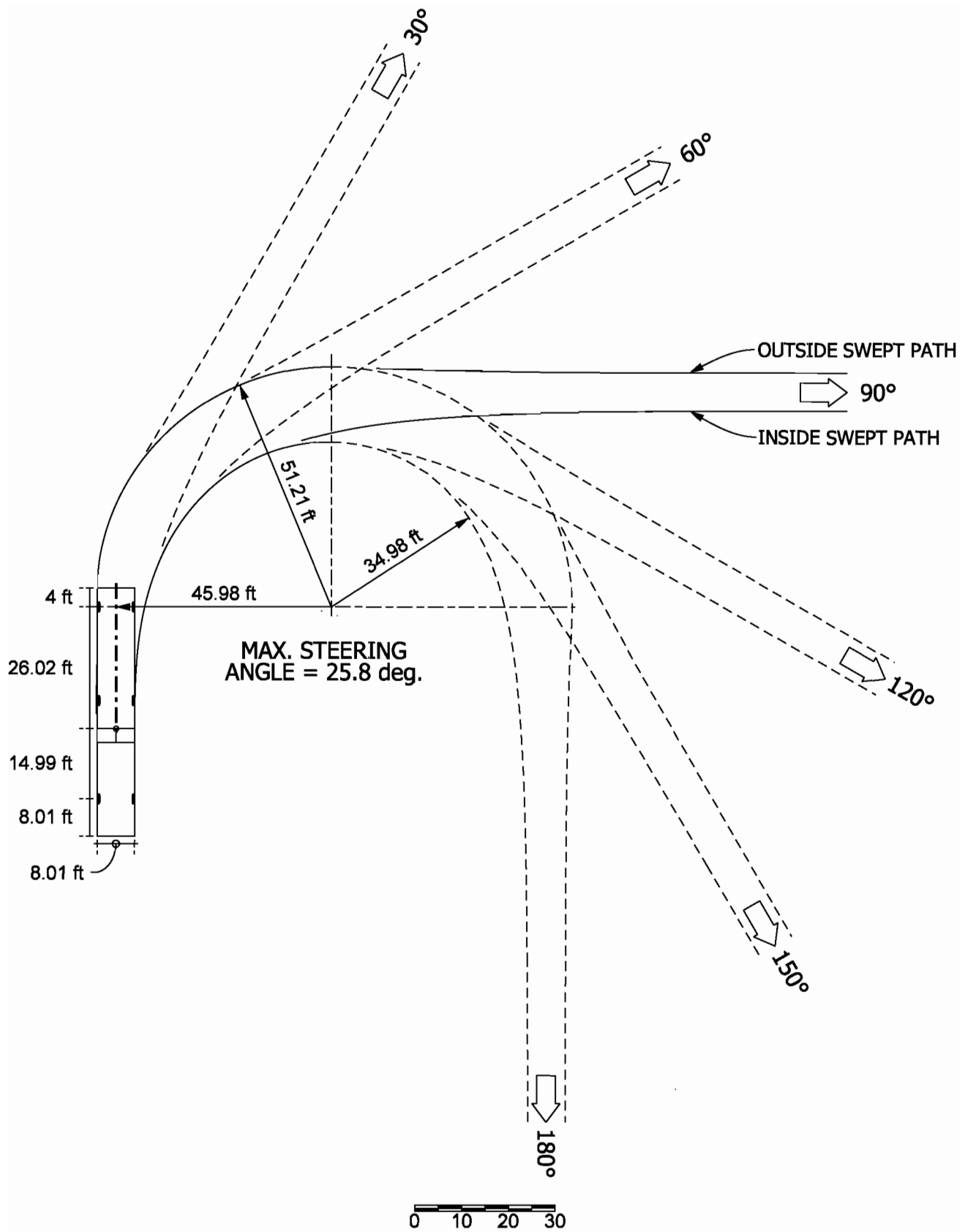

MH/B - DESIGN VEHICLE
(1" = 30' SCALE)

Figure 46 -12 O

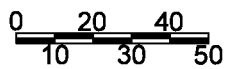
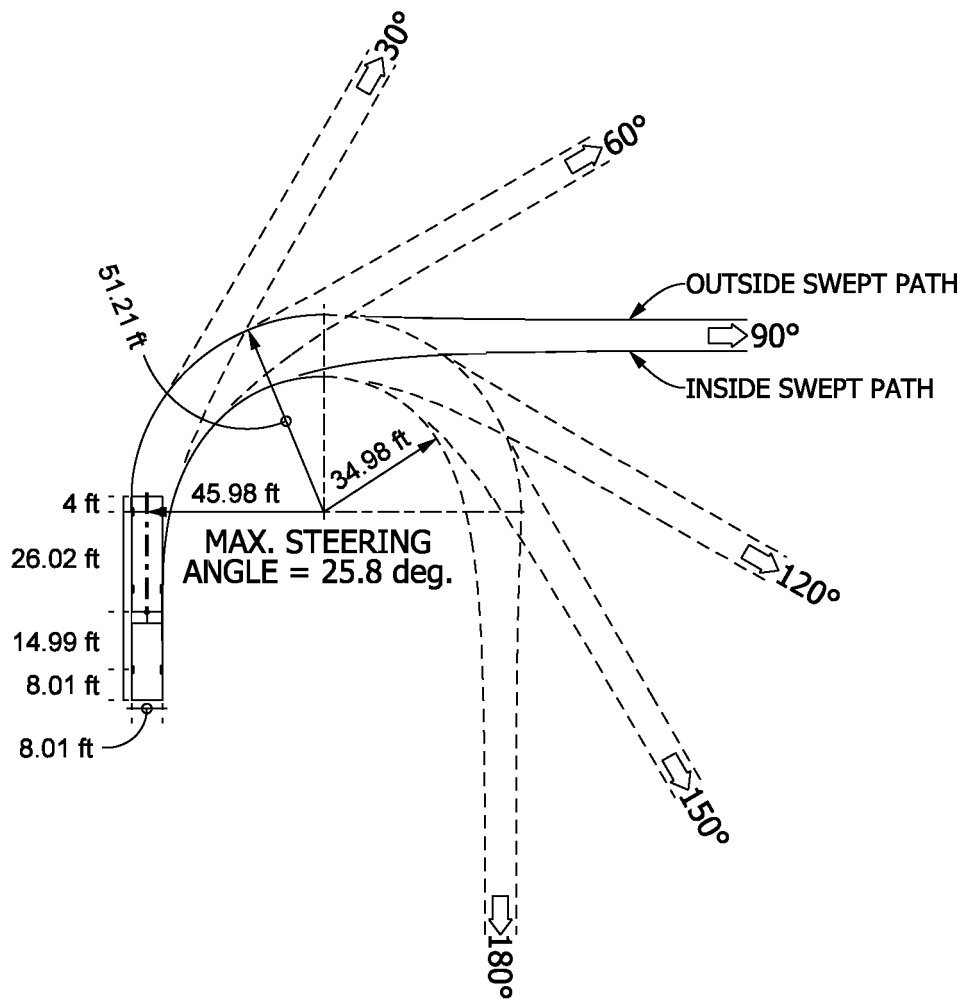

MH/B - DESIGN VEHICLE
(1" = 50' SCALE)

Figure 46 -12P