

15<sup>th</sup> Edition

# Understanding Computers

Today and Tomorrow

Comprehensive

## Chapter 7

# Computer Networks

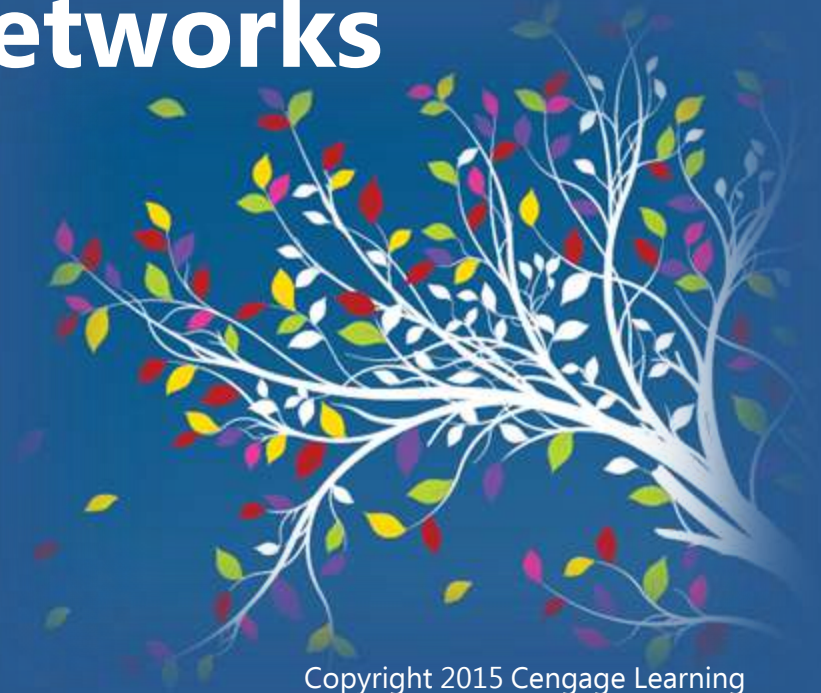

**Deborah Morley**  
**Charles S. Parker**

Copyright 2015 Cengage Learning



# Learning Objectives

1. Define a computer network and its purpose.
2. Describe several uses for networks.
3. Understand the various characteristics of a network, such as topology, architecture, and size.
4. Understand characteristics about data and how it travels over a network.



# Learning Objectives

5. Name specific types of wired and wireless networking media and explain how they transmit data.
6. Identify the most common communications protocols and networking standards used with networks today.
7. List several types of networking hardware and explain the purpose of each.



# Overview

- This chapter covers:
  - Computer network is defined
  - Common networking and communications applications
  - Networking concepts and terminology
  - Technical issues related to networks, including general characteristics of data transmission, and types of transmission media in use today
  - Explanation of the various communications protocols and networking standards
  - Various types of hardware used with a computer network



# What Is a Network?

- Network
  - A connected system of objects or people
- Computer network
  - A collection of computers and other hardware devices connected together so users can share hardware, software, and data, and electronically communicate
- Computer networks are converging with telephone and other communications networks
- Networks range from small private networks to the Internet
- In most businesses, computer networks are essential



# Inside the Industry Box

## Wireless Power

- Powers/recharges devices via wireless signals and magnetic induction
- Wireless Power Consortium supports the Qi standard
- Can use built-in or external charging receiver
- May be built into walls, homes, cars, garage floors, etc. in the future



Courtesy Toyota Motor Sales, U.S.A., Inc.

Qi wireless charging stations are available in some recent cars, such as the Toyota Avalon shown here.



# Networking Applications

- The Internet
  - Largest computer network in the world
- Telephone Service
  - POTS Network
    - One of the first networks
    - Still used today to provide telephone service to landline phones
  - Mobile Phones (wireless phones)
    - Use a wireless network for communications



# Networking Applications

- Cellular (cell) Phones
  - Must be within range of cell tower to function
- Dual-mode Phones
  - Allow users to make telephone calls using more than one communications network
  - Cellular/Wi-Fi dual-mode phones can switch seamlessly between the Wi-Fi network and a cellular network
- Satellite Phones
  - Communicate via satellite technology
  - Most often used by individuals such as soldiers, journalists, wilderness guides, and researchers



# Networking Applications



© Black Rock Digital/Shutterstock.com

## CELLULAR PHONES

Can be used wherever cellular phone coverage is available.



© DM/SU/Shutterstock.com

## SATELLITE PHONES

Can be used virtually anywhere.

**FIGURE 7-2**

Types of mobile phones.



# Networking Applications

- Television and Radio Broadcasting
  - Still used to deliver TV and radio content to the public
  - Other networks involved with television content delivery are cable TV networks, satellite TV networks, and private closed-circuit television systems
- Global Positioning System (GPS) Applications
  - Uses satellites and a receiver to determine the exact geographic location of the receiver
  - GPS receivers
    - Commonly used by individuals to determine their geographic location

# Networking Applications

- GPS receivers
  - Used on the job by surveyors, farmers, and fishermen
  - Used to guide vehicles and equipment
  - Used by the military to guide munitions and trucks, and to track military aircraft, ships, and submarines



HANDHELD GPS RECEIVERS



CAR-MOUNTED GPS RECEIVERS



GPS RECEIVERS INTEGRATED INTO SMARTPHONES

**FIGURE 7-3**  
GPS receivers. Allow people to determine their exact geographical location, usually for safety or navigational purposes.



# Networking Applications

- Monitoring Systems
  - Use networking technology to determine the current location or status of an object
    - RFID-based Systems
      - Monitor the status of objects
    - GPS-based Monitoring Systems
      - Monitor the physical location of objects
      - Vehicle and child monitoring systems
    - Electronic Medical Monitors
      - Home healthcare

# Networking Applications

- Sensors are used in some monitoring systems
  - Sensor networks
  - Home automation (smart thermostats, etc.)



**FIGURE 7-5**

**Smart thermostats.**

This thermostat (left) contains a variety of sensors and can be controlled remotely via a mobile app (right).

Courtesy Nest Labs



# Networking Applications

- Multimedia Networking
  - Distributing digital multimedia content, typically via a home network
  - Necessary networking capabilities are often built into devices being used
  - Might need to use multimedia networking device such as a digital media receiver or digital media streamer
  - Placeshifting Content
    - Allows individuals to view multimedia content at a more convenient location, i.e., Slingbox



# Networking Applications

- Videoconferencing, Collaborative Computing, and Telecommuting
  - Videoconferencing
    - Use of computers, video cameras, microphones, and networking technologies to conduct face-to-face meetings over a network
  - Telepresence Videoconferencing
    - A setup that more closely mimics a real-time meeting environment





# Networking Applications

- Collaborative Computing (workgroup computing)
  - Enables individuals to work together on documents and projects
- Telecommuting
  - Individuals work from a remote location (usually home) and communicate with their places of business and clients using networking technologies
  - Allows for employee flexibility





# Networking Applications

- Telemedicine
  - Use of networking technology to provide medical information and services
  - Remote monitoring and consultations
  - Remote diagnosis
  - Telesurgery
    - Robot assisted surgery where doctor's physical location is different from the patient's and robot's
    - Will be needed for long-term space exploration

# Networking Applications



Courtesy of Touch Health, Inc.

Courtesy of Touch Health, Inc.

**FIGURE 7-8**  
Examples of  
telemedicine  
applications.

## REMOTE CONSULTATIONS

Using remote-controlled teleconferencing robots, physicians can “virtually” consult with patients or other physicians in a different physical location; the robot (left photo) transmits video images and audio to and from the doctor (via his or her computer or mobile device, right photo) in real time.



© EMPRI, PA Wire/AP Photos

## TELESURGERY

Using voice or computer commands, surgeons can perform operations (such as inserting a catheter during the heart surgery shown here) remotely via the Internet or a private network; a robotic system uses the surgeon’s commands to physically operate on the patient.



# Network Characteristics

- Wired vs. Wireless Networks
  - Wired
    - A network in which computers and other devices are physically connected to the network with cables
    - Found in schools, businesses, and government facilities
  - Wireless
    - A network in which computers and other devices are connected to the network without physical cables
    - Data is typically sent via radio waves
    - Found in homes, schools, and businesses

# Trend Box

## Stadium Wireless Networks

- Professional sports venues are increasingly including wireless access and other technology
- Free Wi-Fi
- Seat tablet holders
- In-game apps
- HD video boards



An artist rendering of the new San Francisco 49er Levi's Stadium.



# Network Characteristics

- Network Topologies: Indicate how the devices in the network are arranged
  - Star Networks
    - All networked devices connect to a central device/server
    - If the central device fails, the network cannot work
  - Bus Network
    - Uses a central cable to which all network devices connect
  - Mesh network
    - Multiple connections among the devices on the network so that messages can take any of several possible paths



# Network Characteristics



**STAR NETWORKS**  
Use a central device to connect each device directly to the network.

© 2012 WJ



**BUS NETWORKS**  
Use a single central cable to connect each device in a linear fashion.

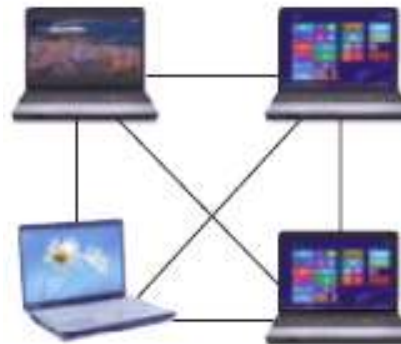

**MESH NETWORKS**  
Each computer or device is connected to multiple (sometimes all of the other) devices on the network.

**FIGURE 7-9**  
Basic network topologies.

© 2012 WJ/Shutterstock.com. © Natalie Swearing/Shutterstock.com. Courtesy D-Lite Systems, Inc. © Karelina/Shutterstock.com. Windows 8. W is a registered trademark of Microsoft Corporation. © 2012 Microsoft.



# Network Characteristics

- Network Architectures
  - Client-Server Networks
    - Client
      - Computer or other device on the network that requests and utilizes network resources
    - Server
      - Computer dedicated to processing client requests

# Network Characteristics

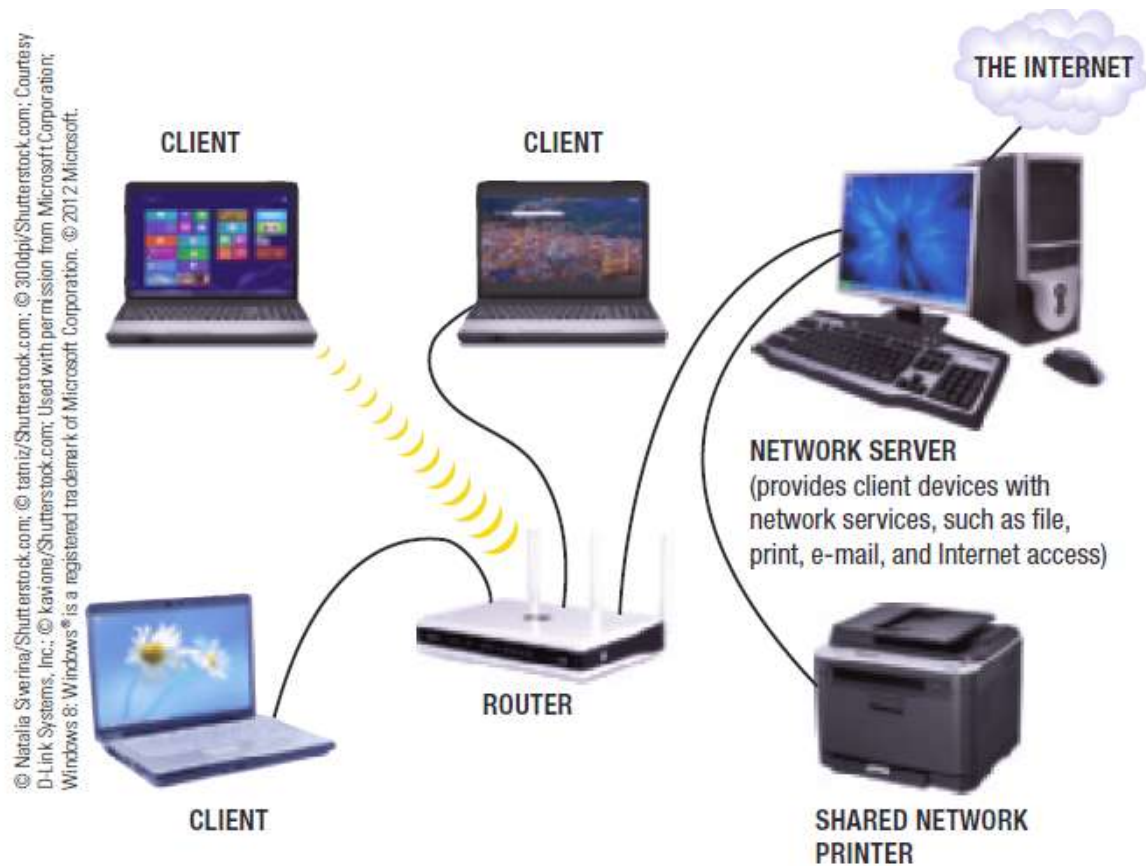

**FIGURE 7-10**  
Client-server networks.  
Client computers  
communicate through one  
or more servers.





# Network Characteristics

- Peer-to-Peer (P2P) Networks
  - Central server is not used
  - All computers on the network work at the same functional level
  - Users have direct access to the computers and devices attached to the network
  - Less complicated and less expensive to implement than client-server networks
  - Internet P2P Computing
    - Content is exchanged over the Internet directly between users



# Network Characteristics

- Network Size and Coverage Area
  - Personal Area Networks (PANs)
    - Connect an individual's personal devices
      - Devices must be physically located close together
  - Local Area Networks (LANs)
    - Connect devices located in a small geographic area
  - Metropolitan Area Networks (MANs)
    - Cover a metropolitan area such as a city or county
  - Wide Area Networks (WANs)
    - Cover a large geographic area
    - Two or more LANs connected together



# Network Characteristics

- Intranets and Extranets
  - Intranet
    - Private network designed to be used by an organizations' employees; set up like the Internet
  - Extranet
    - Company network accessible by authorized outsiders
- Virtual Private Networks (VPNs)
  - Private, secure path over the Internet that provides authorized users a secure means of accessing a private network via the Internet
  - Uses tunneling and special encryption technology



# Quick Quiz

1. Which of the following describes a group of private secure paths set up using the Internet?
  - a. VPN
  - b. WAN
  - c. WSN
2. True or False: With a bus network, all devices are connected directly to each other without the use of a central hub or cable.
3. A private network that is set up similar to the World Wide Web for use by employees of a specific organization is called a(n) \_\_\_\_\_.

*Answers:*

*1) a; 2) False; 3) intranet*

# Data Transmission Characteristics

- Bandwidth
  - The amount of data that can be transferred in a given period of time
  - Measured in bits per second (bps), Kbps (thousands), Mbps (millions), or Gbps (billions)
- Analog vs. Digital Signals
  - Data represented by two discrete states: 0s and 1s
  - Conventional telephone systems use analog signals
    - Represent data with continuous waves

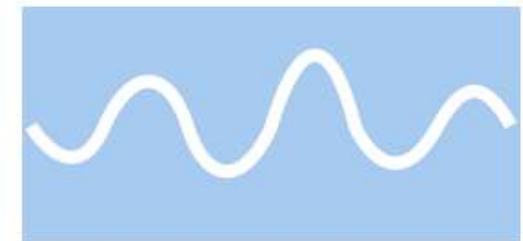

ANALOG SIGNALS

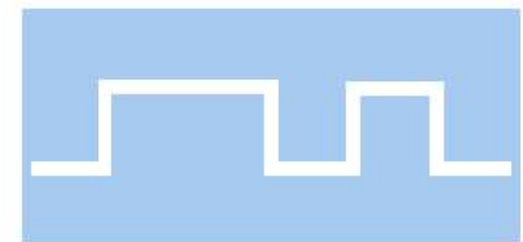

DIGITAL SIGNALS



**FIGURE 7-14**

Analog vs. digital signals.

Copyright © 2015 Cengage Learning®

# Data Transmission Characteristics

- Transmission Type and Timing
  - Serial
    - Data sent one bit at a time, one after another, along a single path
  - Parallel
    - Data sent at least one byte at time with each bit in the byte taking a different path

01000001 →

## SERIAL TRANSMISSIONS

All the bits in one byte follow one another over a single path.

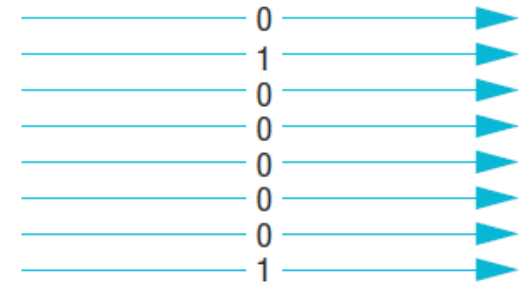

Copyright © 2015 Cengage Learning®

## PARALLEL TRANSMISSIONS

The eight bits in each byte are transmitted over separate paths at the same time.

**FIGURE 7-15**

Serial vs. parallel transmissions.



# Data Transmission Characteristics

- Synchronous Transmission
  - Blocks of data are transferred at regular, specified intervals
  - Most data transmissions within a computer and over a network are synchronous
- Asynchronous Transmission
  - Data is sent when ready without being synchronized
  - Start bits and stop bits used to identify the bits that belong in each byte
- Isochronous Transmission
  - Data sent at the same time as other, related, data

# Data Transmission Characteristics

© Natalia Siverina/Shutterstock.com; © tamiz/Shutterstock.com; Windows 8: Windows® is a registered trademark of Microsoft Corporation. © 2012 Microsoft. © 2015 Cengage Learning®

## SYNCHRONOUS TRANSMISSIONS

Data is sent in blocks and the blocks are timed so that the receiving device knows when they will arrive.

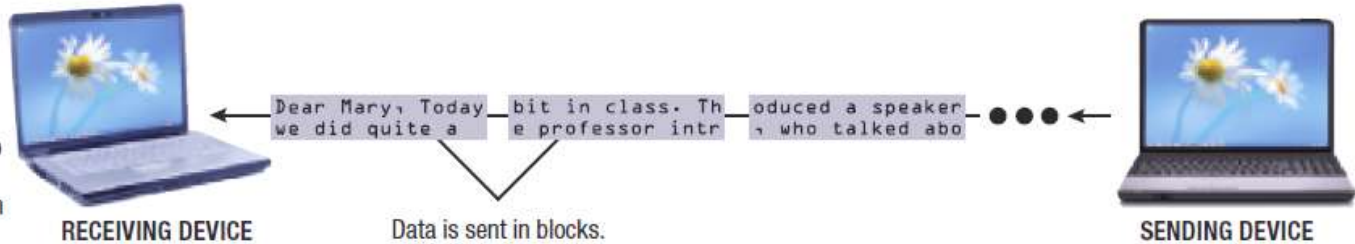

## ASYNCHRONOUS TRANSMISSIONS

Data is sent one byte at a time, along with a start bit and a stop bit.

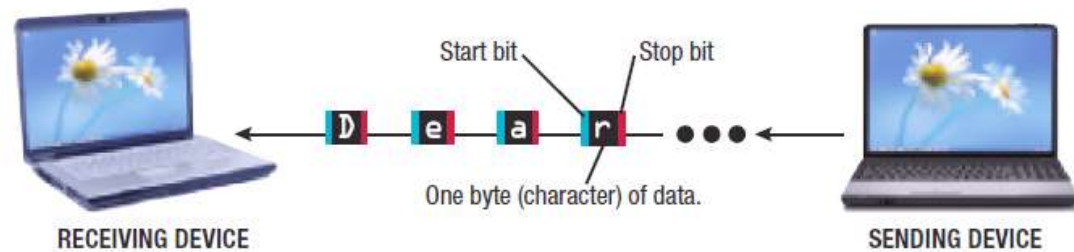

## ISOCRONOUS TRANSMISSIONS

The entire transmission is sent together after requesting and being assigned the bandwidth necessary for all the data to arrive at the correct time.

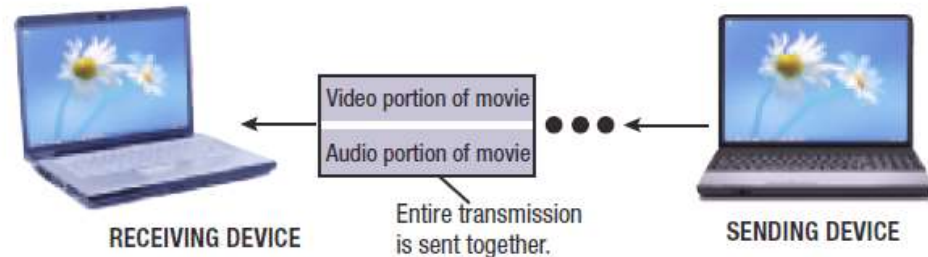

**FIGURE 7-16**

Transmission timing. Most network transmissions use synchronous transmission.





# Data Transmission Characteristics

- Simplex Transmission
  - Data travels in a single direction only
- Half-Duplex Transmission
  - Data travels in either direction but only one way at a time
- Full-Duplex Transmission
  - Data travels in both directions at the same time



# Data Transmission Characteristics

- Delivery Method
  - Circuit-Switching
    - Dedicated path over a network is established between sender and receiver; all data follows that path
  - Packet-Switching
    - Messages are separated into small units called packets and travel along the network separately; packets are reassembled once destination is reached
  - Broadcasting
    - Data is sent out to all other nodes on the network and retrieved only by the intended recipient; primarily used with LANs

# Data Transmission Characteristics

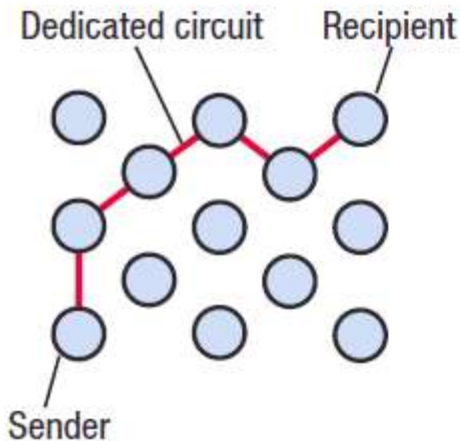

## CIRCUIT-SWITCHED NETWORKS

Data uses a dedicated path from the sender to the recipient.

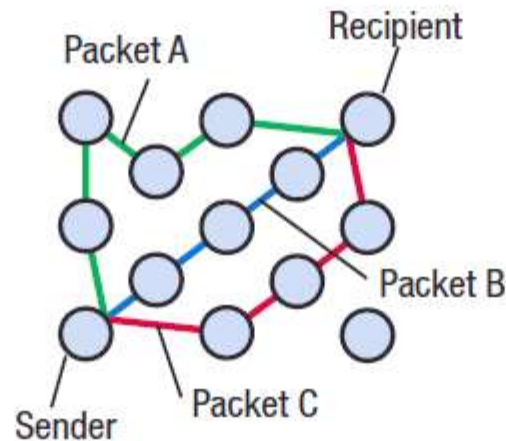

## PACKET-SWITCHED NETWORKS

Data is sent as individual packets, which are assembled at the recipient's destination.

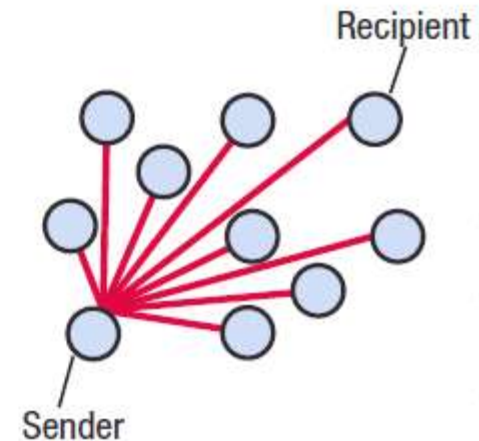

## BROADCAST NETWORKS

Data is broadcast to all nodes within range; the designated recipient retrieves the data.

**FIGURE 7-17**

Circuit-switched, packet-switched, and broadcast networks.

Copyright © 2015 Cengage Learning®



# Networking Media

- Wired Networking Media
  - Twisted-Pair Cable
    - Pairs of insulated wires twisted together
    - Used for telephone and network connections (LANs)
  - Coaxial Cable
    - Thick center wire surrounded by insulation
    - Used for computer networks and cable television delivery
  - Fiber-Optic Cable
    - Utilizes hundreds of thin transparent clear glass or plastic fibers over which lasers transmit data as light
    - Used for high-speed communications

# Networking Media

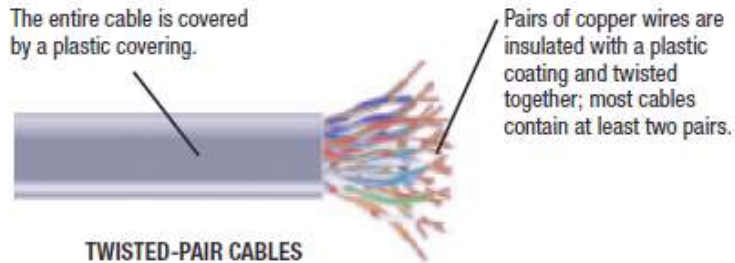

**FIGURE 7-18**  
Wired network transmission media.

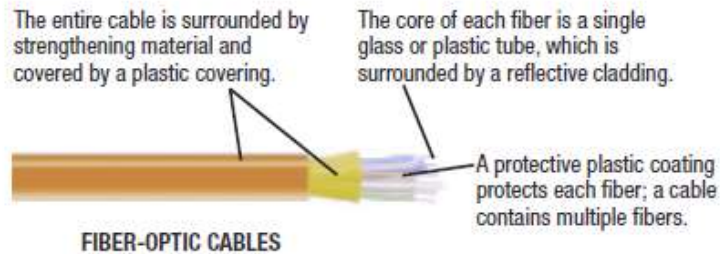
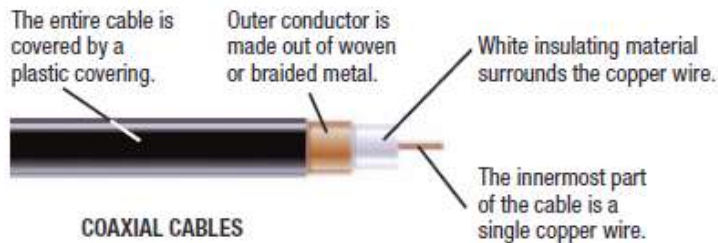

Courtesy of BlackBox Corporation; Courtesy Belkin International, Inc.



# Networking Media

- Wireless Networking Media
  - Data is sent through the airwaves using radio signals
  - The Electromagnetic and Wireless Spectrum
    - Radio frequencies are assigned by the FCC and are measured in hertz (Hz)
    - The electromagnetic spectrum is the range of common electromagnetic radiation (energy)
    - Different parts of the spectrum have different properties, which make certain frequencies more appropriate for certain applications



# Networking Media

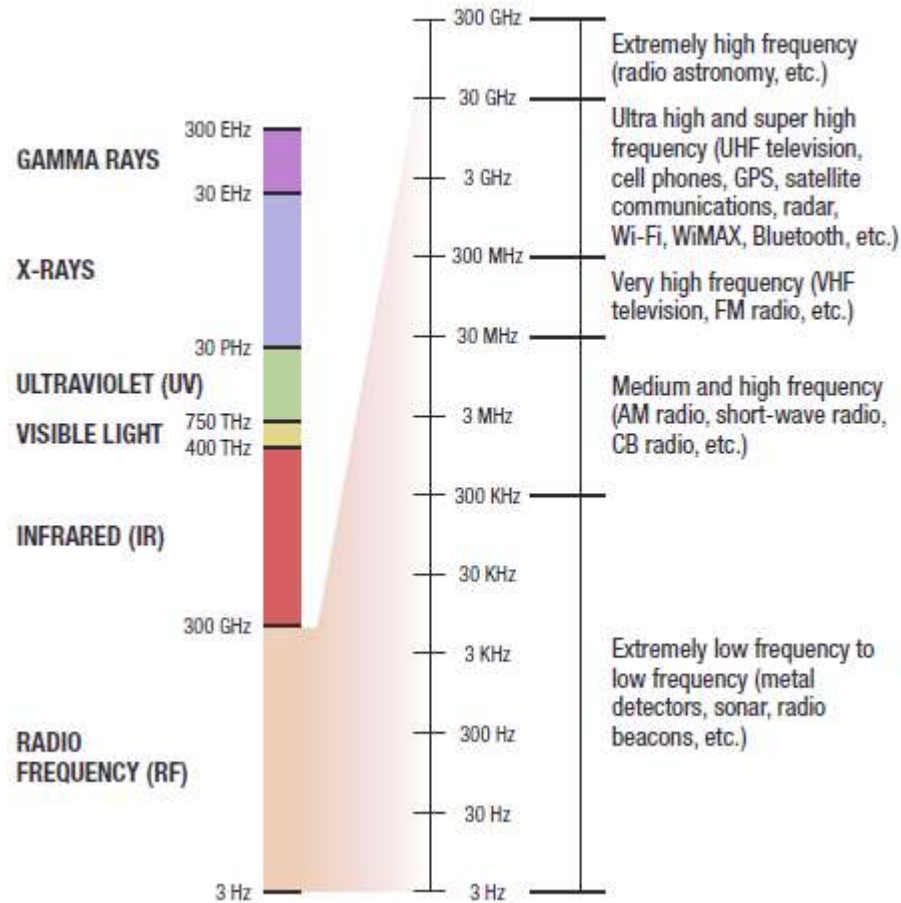

**FIGURE 7-19**

The electromagnetic spectrum. Each type of communication is assigned specific frequencies within which to operate.

Copyright © 2015 Cengage Learning®



# Networking Media

- Frequencies assigned to an application usually consist of a range of frequencies to be used as needed
- Most wireless networking applications use frequencies in the RF band at the low end of the spectrum—up to 300 GHz
  - Often called the *wireless spectrum*
- The 900 MHz, 2.4GHz, 5 GHz, and 5.8 GHz frequencies are within an unlicensed part of the spectrum and can be used by any product or individual
  - Cordless landline phones, garage door openers, Wi-Fi, WiMAX, and Bluetooth





# Networking Media

- Cellular Radio Transmissions
  - Use cellular towers within honeycomb-shaped zones called cells
  - Calls are transferred from cell tower to cell tower as the individual moves
  - Cell tower forwards call to the MTSO
  - MTSO routes call to the recipient's phone
  - Data sent via cell phones works in similar manner
  - The speed of cellular radio transmissions depends on the type of cellular standard being used

# Networking Media

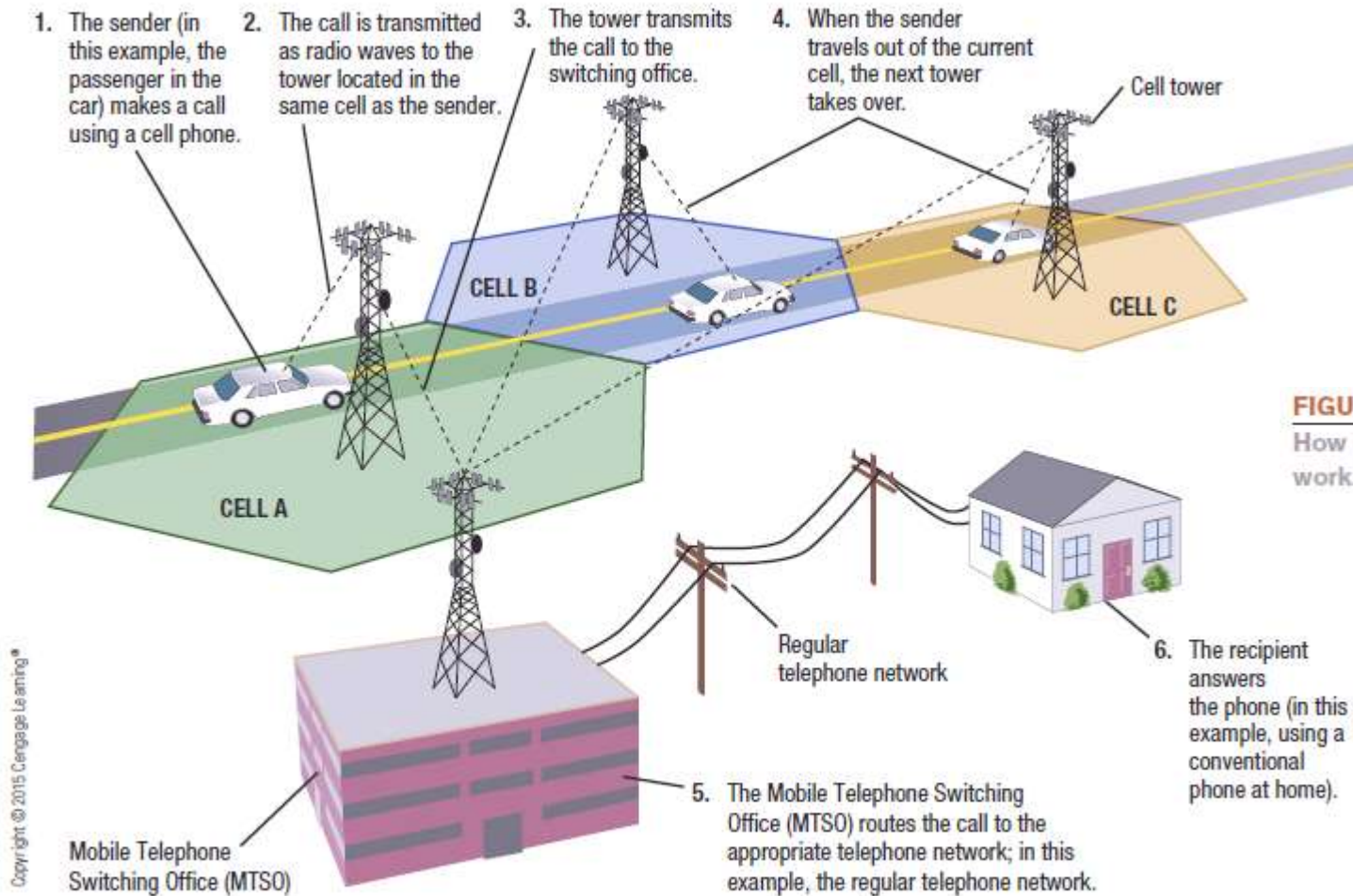

**FIGURE 7-20**  
How cellular phones work.



# Networking Media

- Microwave and Satellite Transmissions
  - Microwaves
    - High-frequency radio signals that are sent and received using microwave stations or satellites
    - Signals are line of sight, so microwave stations are usually built on tall buildings, towers, mountaintops
  - Microwave stations
    - Earth-based stations that transmit signals directly to each other within a range of 30 miles
    - Stations designed to communicate with satellites (television and internet services) are called satellite dishes



# Networking Media

- Communication satellites are launched into orbit to send and receive microwave signals from earth
  - Traditional satellites use geosynchronous orbit 22,300 miles above the earth
  - A delay of less than one half-second is common when signals travel from earth to satellite and back
  - Low earth orbit (LEO) satellites were developed to combat delay
  - Medium earth orbit (MEO) satellites are most often used for GPS systems

# Networking Media

3. An orbiting satellite receives the request and beams it down to the satellite dish at the ISP's operations center.

2. The request is sent up to a satellite from the individual's satellite dish.

1. Data, such as a Web page request, is sent from the individual's computer to the satellite dish via a satellite modem.

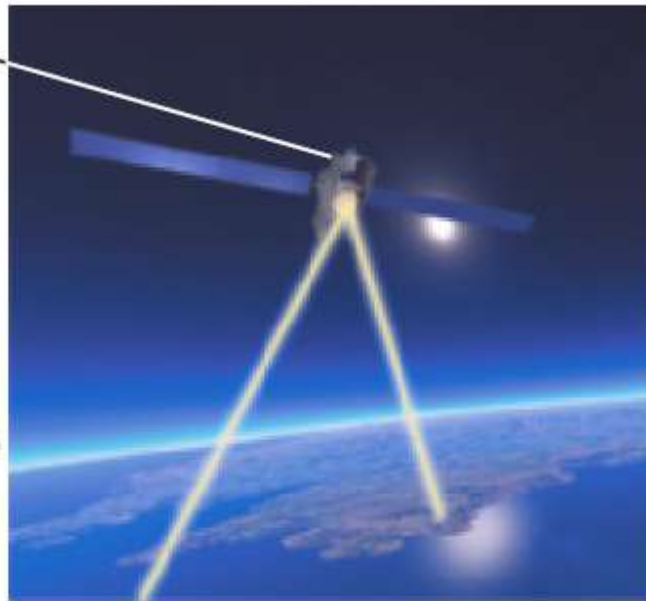

4. The ISP's operations center receives the request (via its satellite dish) and transfers it to the Internet.



THE INTERNET

5. The request travels over the Internet as usual. The requested information takes a reverse route back to the individual.

**FIGURE 7-21**

How satellite Internet works.



# Networking Media

- Infrared (IR) Transmissions
  - Sends data as infrared light rays
  - Like an infrared television remote, IR requires line of sight
  - Because of this limitation, many formerly IR devices (wireless mice, keyboards) now use RF technology
  - IR is sometimes used to beam data between some mobile devices, game consoles, and handheld gaming devices





# Quick Quiz

1. Which of the following transmission media transmits data as light pulses?
  - a. coaxial cable
  - b. fiber-optic cable
  - c. twisted-pair cable
2. True or False: Cellular radio is a form of wireless network transmission.
3. A device located in space that orbits the earth to provide communications services is called a(n) \_\_\_\_\_.

*Answers:*

*1) b; 2) True; 3) satellite*





# Communications Protocols and Networking Standards

- Protocol
  - A set of rules for a particular situation
  - Communications Protocol
    - A set of rules that determine how devices on a network communicate
- Standard
  - A set of criteria or requirements approved by a recognized standards organization
  - Address how networked computers connect/communicate
  - Needed to ensure products can work with other products



# TCP/IP and Other Communications Protocols

- TCP/IP
  - Most widely used communications protocol
  - Consists of two protocols
    - Transmission Control Protocols (TCP)
      - Responsible for delivery of data
    - Internet Protocols (IP)
      - Provides addresses and routing information
  - Uses packet switching to transmit data
  - TCP/IP support is built into almost all operating systems and IP addresses are used to identify computers and devices on networks

# TCP/IP and Other Communications Protocols

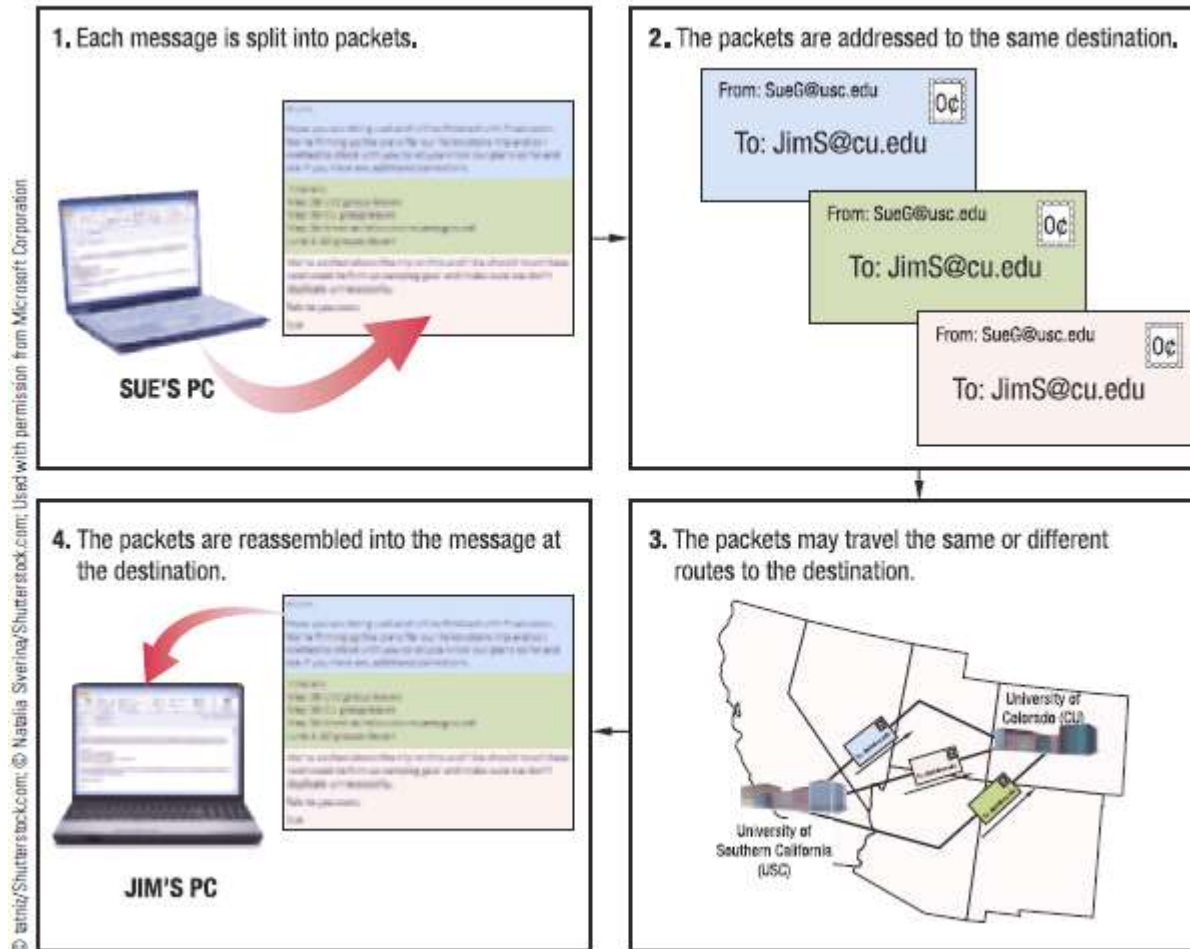

**FIGURE 7-22**  
How TCP/IP works.  
TCP/IP networks  
(like the Internet) use  
packet switching.

Copyright © 2015 Cengage Learning®



# TCP/IP and Other Communications Protocols

- Other Protocols
  - HTTP (Hypertext Transfer Protocol) and HTTPS (Secure Hypertext Transfer Protocol)
    - Used to display Web pages
  - FTP (File Transfer Protocol)
    - Used to transfer files over the Internet
  - SMTP (Simple Mail Transfer Protocol) and POP3 (Post Office Protocol)
    - Used to deliver e-mail over the Internet



# Ethernet (802.3)

- Ethernet (802.3)
  - Most widely used standard for wired networks
  - Typically used with LANs that have a star topology
  - Works with twisted-pair, coaxial, and fiber-optic cabling
  - Continually evolving
  - Most common today are Fast Ethernet, Gigabit Ethernet, and 10 Gigabit Ethernet
  - 40 Gigabit Ethernet and 100 Gigabit Ethernet standards ratified in 2010
  - Terabit Ethernet standard is currently under development



# Ethernet (802.3)

<b>STANDARD</b>	<b>MAXIMUM SPEED</b>
10BASE-T	10 Mbps
Fast Ethernet (100BASE-T or 100BASE-TX)	100 Mbps
Gigabit Ethernet (1000BASE-T)	1,000 Mbps (1 Gbps)
10 Gigabit Ethernet (10GBASE-T)	10 Gbps
40 Gigabit Ethernet	40 Gbps
100 Gigabit Ethernet	100 Gbps
400 Gigabit Ethernet*	400 Gbps
Terabit Ethernet*	1,000 Gbps (1 Tbps)
*Under consideration for development	

Copyright © 2015 Cengage Learning®

**FIGURE 7-23**  
Ethernet standards.



# Ethernet (802.3)

- Power over Ethernet (PoE)
  - Allows electrical power to be sent along the cables on an Ethernet network along with data
  - Devices are not plugged into an electrical outlet
  - Most often used in business networks with remote wired devices
  - Can also be used to place networked devices near ceilings or other locations where a nearby power outlet may not be available



# Ethernet (802.3)

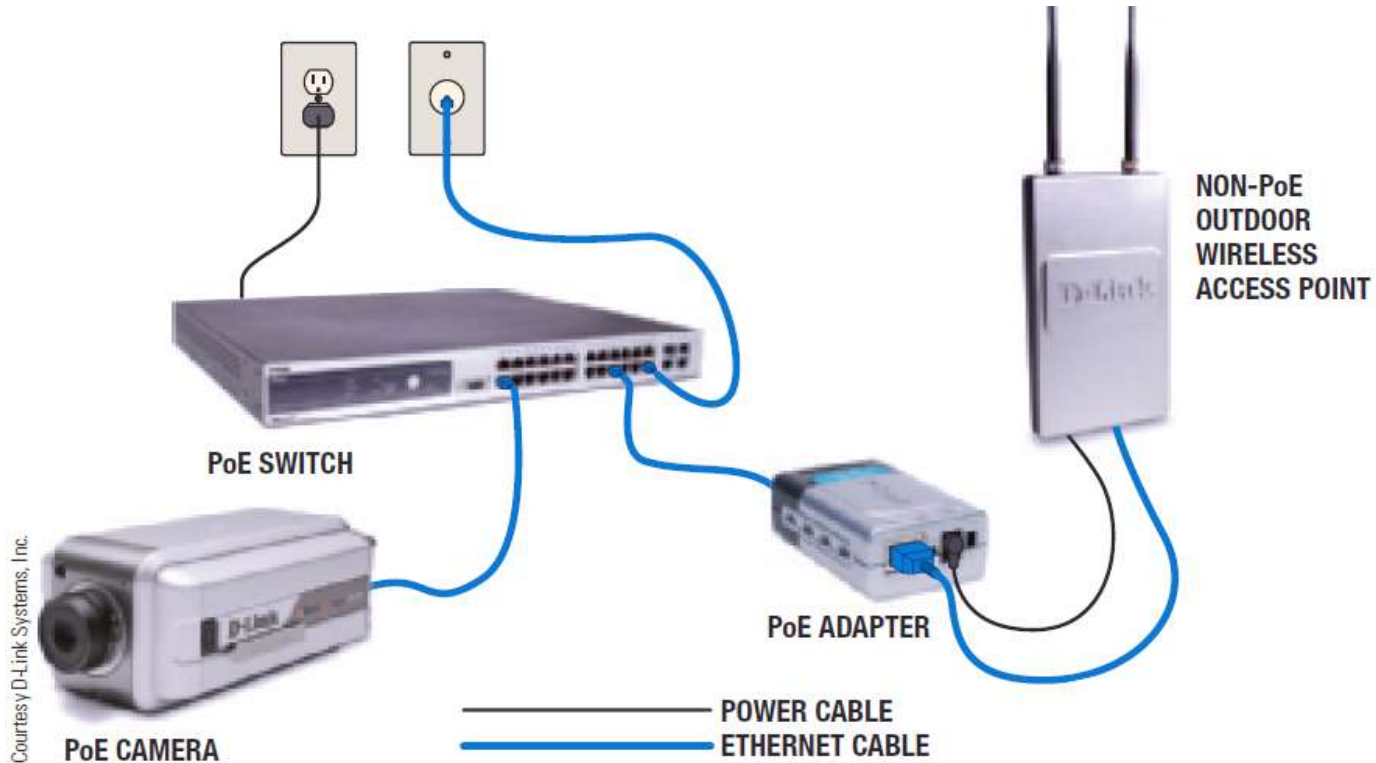

**FIGURE 7-23**  
Ethernet standards.

# Phoneline, Powerline, G.hn, and Broadband over Powerline (BPL)

- Phoneline
  - Allows networking via ordinary telephone wiring
- Powerline
  - Allows networking via ordinary electrical outlets
  - For wired home networks, Phoneline and Powerline are alternatives to Ethernet



Courtesy Belkin International, Inc.

**FIGURE 7-25**  
WeMo. Allows you to remotely control your lights with your smartphone; works over existing power lines.



# Phoneline, Powerline, G.hn, and Broadband over Powerline (BPL)

- G.hn
  - A unified world-wide standard for creating home networks over any existing home wiring—phone lines, power lines, and coaxial cable
- Broadband over Powerline (BPL)
  - Designed to deliver broadband Internet to homes via the existing outdoor power lines
  - Great potential for delivering broadband access to homes or businesses with access to electricity, but not widely available

# Wi-Fi (802.11)

- Wi-Fi (802.11)
  - A family of wireless networking standards using IEEE standard 802.11
  - Current standard for wireless networks in homes and offices (wireless Ethernet)
  - Built into many everyday objects today
  - Designed for medium-range transmission; speed and distance depends on Wi-Fi standard being used, solid objects in the way, interference, etc.

**FIGURE 7-26**

**Smart scales.**

This scale transmits readings to a smartphone via Wi-Fi .



# Technology and You Box

## Wi-Fi SD Cards

- Upload photos wirelessly and automatically from camera to computer, mobile device, or cloud photo service
- Some include location information
- Some sync photos and videos to cloud account
- Can share photos quickly with others as well as have backups





# Wi-Fi (802.11)

- Most widely used standards today are 802.11g, 802.11n, and 802.11ac
- Wi-Fi Alliance
  - Certifies that hardware from various vendors will work together
  - Developing WiGig (802.11ad) standard for very fast short-range networking
- Wi-Fi has a limited range
  - Many businesses may be physically too large for Wi-Fi to cover the entire organization





# Wi-Fi (802.11)

**FIGURE 7-27**  
Common Wi-Fi  
standards.

WI-FI STANDARD	DESCRIPTION
802.11b	An early Wi-Fi standard; supports data transfer rates of 11 Mbps.
802.11a	Supports data transfer rates of 54 Mbps, but uses a different radio frequency (5 GHz) than 802.11b/g (2.4 GHz), making the standards incompatible.
802.11g	A current Wi-Fi standard; supports data transfer rates of 54 Mbps and uses the same 2.4 GHz frequency as 802.11b, so their products are compatible.
802.11n	A current Wi-Fi standard; supports speeds up to about 300 Mbps and has twice the range of 802.11g. It can use either the 2.4 GHz or 5 GHz frequency.
802.11ac	The newest Wi-Fi standard expected to be ratified in 2014; supports speed up to about three times faster than 802.11n and uses the 5 GHz frequency (though virtually all 802.11ac routers also support 2.4 GHz devices for backward compatibility).





# WiMAX (802.16)

- WiMAX (802.16)
  - Standards for longer range wireless networking connections, typically MANs
  - Fixed WiMAX
    - Designed to provide Internet access fixed locations (hotzones)
    - Typical hotzone radius is between 2 and 6 miles
    - Possible to provide coverage to an entire city by using multiple WiMAX towers
  - Mobile WiMAX
    - Mobile version of the standard

# WiMAX (802.16)

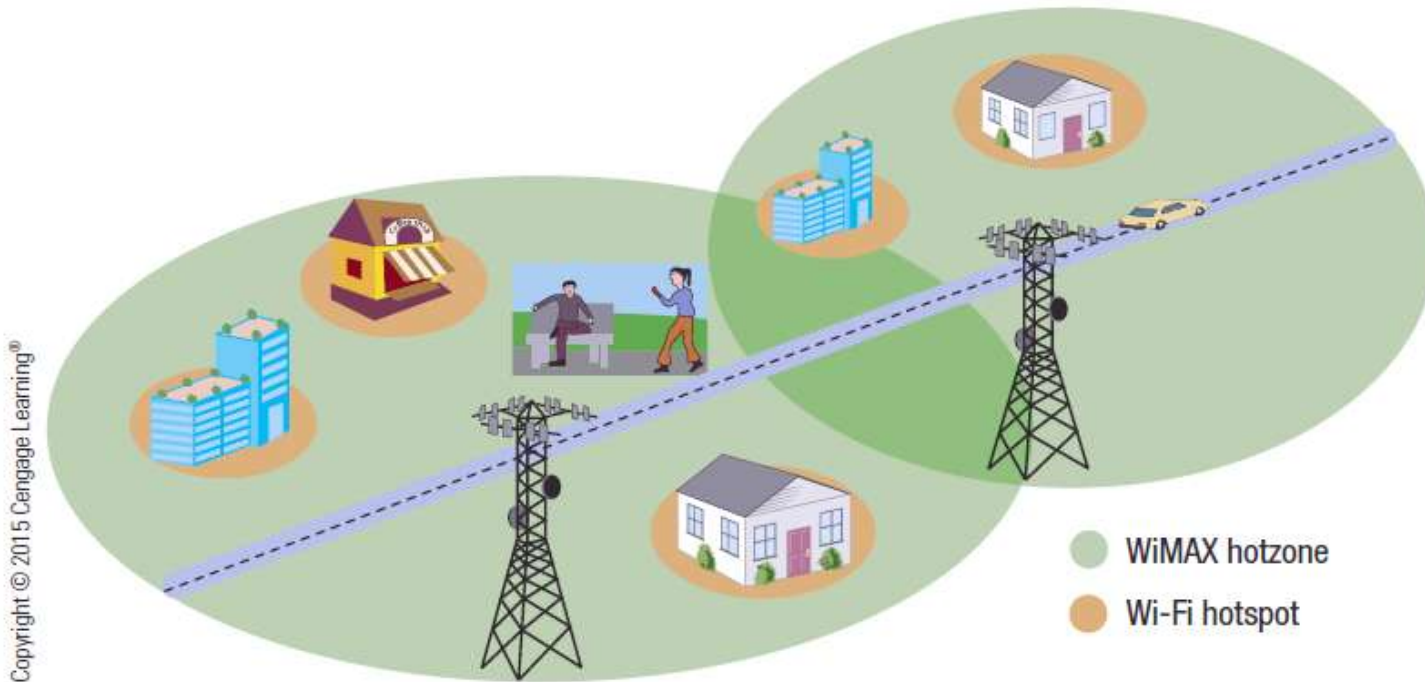

**FIGURE 7-29**

**WiMAX vs. Wi-Fi.**

A WiMAX hotzone is larger than a Wi-Fi hotspot and so has a greater range; it can provide service to anyone in the hotzone, including mobile users.



# Cellular Standards

- Cellular Standards
  - First Generation
    - Analog and voice only
  - 2G (Second Generation)
    - Digital, both voice and data, faster
  - 3G and 4G networks
    - Current standards
    - Use packet switching
    - 3G speeds are between 1 and 4 Mbps
    - 4G speeds currently range from about 3 to 15 Mbps



# Bluetooth, Ultra Wideband (UWB), and Other Short-Range Wireless Standards

- Bluetooth
  - Networking standard for very short-range wireless connections
  - Bluetooth 4.0 (Bluetooth Smart) is low energy so can run for years on small battery
- Wireless USB
  - Wireless version of USB designed to connect peripheral devices
- Wi-Fi Direct
  - Standard for connecting Wi-Fi devices directly, without using a router or an access point



# Bluetooth, Ultra Wideband (UWB), and Other Short-Range Wireless Standards

- Ultra Wideband (UWB)
  - Networking standard for very short-range wireless connections among multimedia devices
- WirelessHD (WiHD): designed for very fast transfers between home electronic devices
- TransferJet
  - Standard for very short-range wireless connections between devices
  - Devices need to touch in order to communicate



# Bluetooth, Ultra Wideband (UWB), and Other Short-Range Wireless Standards

- ZigBee
  - Designed for inexpensive and simple short-range networking, particularly sensor networks
  - Can be used for home and commercial automation systems
- Z-Wave
  - Devices can communicate with each other and be controlled via home control modules and remotely using a computer or mobile phone

# Bluetooth, Ultra Wideband (UWB), and Other Short-Range Wireless Standards

CATEGORY	EXAMPLES	INTENDED PURPOSE	APPROXIMATE RANGE
Short range	Bluetooth Wireless USB	To connect peripheral devices to a mobile phone or computer.	33 feet–200 feet
	Ultra Wideband (UWB) WirelessHD (WiHD) TransferJet WiGig	To connect and transfer multimedia content between home consumer electronic devices (computers, TVs, DVD players, etc.).	1 inch–33 feet
	ZigBee Z-Wave	To connect a variety of home, personal, and commercial automation devices.	33 feet–328 feet
Medium range	Wi-Fi (802.11)	To connect computers and other devices to a local area network.	100–300 feet indoors; 300–900 feet outdoors
	Wi-Fi Direct	To connect computers and other devices directly together.	600 feet
Long range	WiMAX Mobile WiMAX	To provide Internet access to a large geographic area for fixed and/or mobile users.	6 miles non-line of sight; 30 miles line of sight
	Cellular standards	To connect mobile phones and mobile devices to a cellular network for telephone and Internet service.	10 miles

**FIGURE 7-33**

Summary of common wireless networking standards.





# How It Works Box

## Smart Homes

- Home automation
  - Use Z-Wave, Bluetooth, Wi-Fi or other wireless standards to control lights, door locks, thermostats, etc.
- Smart door locks can be unlocked via proximity sensors and Bluetooth 4.0
  - Can send temporary keys to others
  - Can check on status of locks and keys online





# Networking Hardware

- Network Adapter
  - Used to connect a computer to a network
  - Also called network interface card (NIC) when in the form of an expansion card
- Modem
  - Device that enables a computer to communicate over analog networking media
  - Term is often used interchangeably with network adapter
  - Most computers and mobile devices today come with a built-in network adapter and/or modem

# Networking Hardware

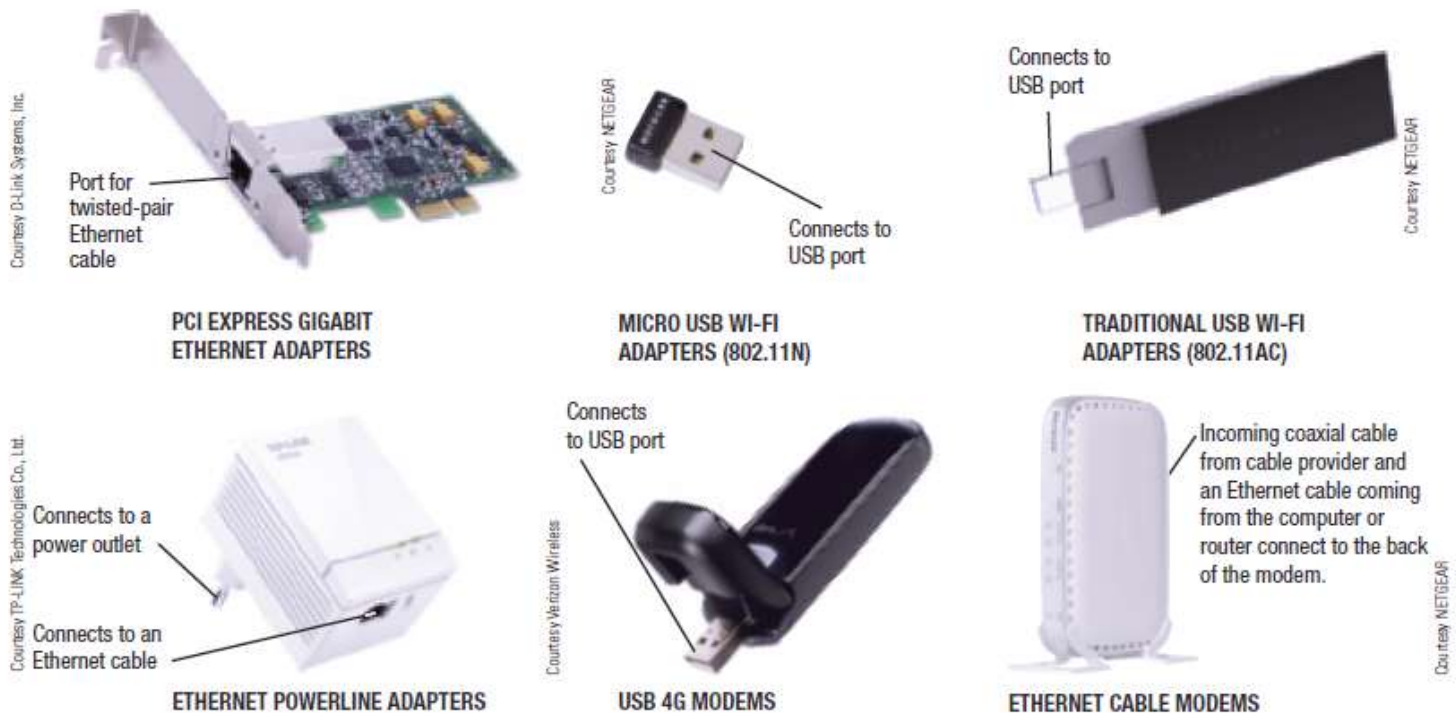

**FIGURE 7-34**

Network adapters and modems.



# Networking Hardware

- Switch
  - Central device that connects devices in a wired network but only sends data to the intended recipient
  - Hub – similar but sends data to all recipients
- Router
  - Connects multiple networks: two LANs, two WANS, LAN and the Internet
  - Passes data to intended recipient only
  - Routes traffic over the Internet
- Wireless Access Point
  - Device used to grant network access to wireless client devices



# Networking Hardware

- Wireless Router
  - Typically connects both wired and wireless devices to a network and to connect the network to the Internet
  - Often integrates a switch, router, and wireless access point
- Bridge
  - Used to connect two LANs together
  - In a home network, wirelessly connects a wired device to the network

# Networking Hardware



Wired devices can connect here

Modem providing Internet access connects here

USB devices (such as a printer or external hard drive) can connect here

**CONVENTIONAL WIRELESS ROUTERS**  
This 802.11ac router also includes a switch and wireless access point.



A wired Internet connection connects here

**TRAVEL WIRELESS ROUTERS**  
This 802.11a/b/g/n router enables multiple devices to share a single wired Internet connection.



A wired device can connect here

A USB 3G or 4G modem connects here

**MOBILE BROADBAND ROUTERS**  
This 3G/4G enables multiple devices to share a mobile broadband connection.

**FIGURE 7-35**

**Wireless routers.**

Provide wireless users access to each other and an Internet connection.



# Networking Hardware

- Repeaters
  - Amplify signals along a network
- Range Extenders
  - Repeaters for a wireless network
- Antennas
  - Devices used for receiving or sending radio signals
  - Some network adapters can use an external antenna
  - Can be directional or omnidirectional
  - Strength measured in decibels (dB)





# Networking Hardware

- Multiplexer
  - Combines transmissions from several different devices to send them as one message
- Concentrator
  - Combines messages and sends them via a single transmission medium in such a way that all of the messages are simultaneously active

# Networking Hardware

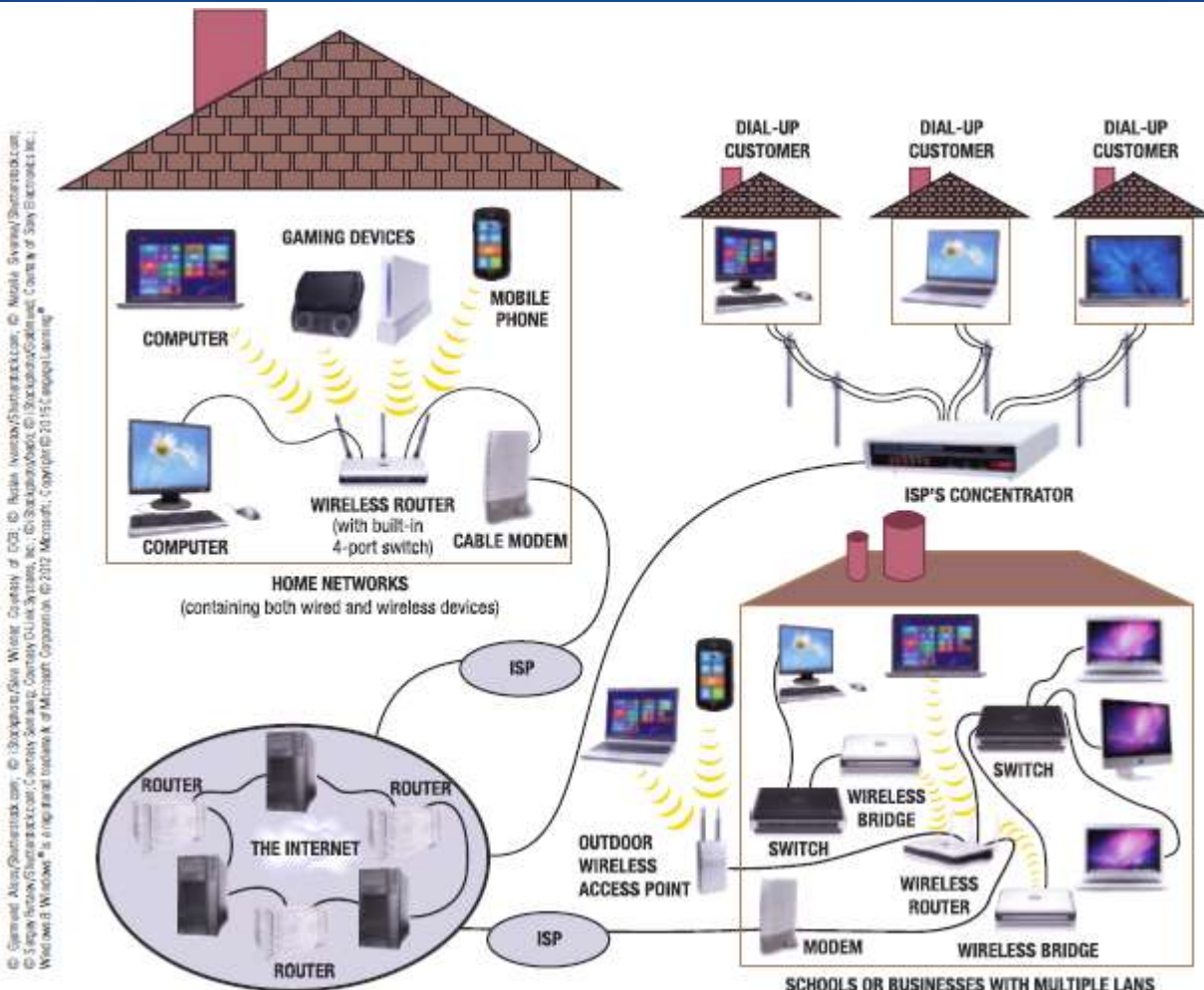

**FIGURE 7-36**  
**Networking hardware.**  
As shown in this example, many different types of hardware are used to connect networking devices.



# Quick Quiz

1. Which of the following is the protocol used to transfer data over the Internet?
  - a. Wi-Fi
  - b. Bluetooth
  - c. TCP/IP
2. True or False: An ExpressCard network adapter is most commonly used with desktop computers.
3. A device used to connect a computer to the Internet is typically referred to as a(n) \_\_\_\_\_.

*Answers:*

*1) c; 2) False; 3) modem*



# Summary

- Networking Applications
- Network Characteristics
- Data Transmission Characteristics
- Networking Media
- Communications Protocols and Networking Standards
- Networking Hardware