

CHAPTER 8 CONSTRUCTION DETAILS

The NRCA Roofing Manual: Metal Panel and SPF Roof Systems—2012

Chapter 8—Construction Details provides technical information concerning the design and installation of construction details for quality SPF roof systems. This introduction is intended to supplement the special notes on the individual construction details.

Construction details are provided for the following SPF roof system types:

- SPF roof systems with protective coatings
- SPF re-cover roof systems with protective coatings

Construction details applicable to SPF roof systems with protective coatings are denoted as “SPF-” followed by a number and possibly a letter (e.g., SPF-2, SPF-2A).

Construction details applicable to SPF re-cover roof systems with protective coatings are denoted as “SPF(R)-” followed by a number and possibly a letter (e.g., SPF(R)-1, SPF(R)-1A).

The letter designation after an SPF roof system type designation and number identifies NRCA’s order of preference for addressing a specific detail condition. For example,

Construction Detail SPF-3—Base Flashing With Counterflashing depicts NRCA’s preferred method of addressing a base flashing with counterflashing detail for SPF roof systems with protective coatings. Construction Detail SPF-3A—Base Flashing depicts an alternative detail NRCA also considers acceptable based on any limitations described on the alternative construction details.

8.1 Information Applicable to All Construction Details

The construction details in this manual provide a generic concept for each specific detail type shown. NRCA’s construction details likely will require modification to meet a project’s specific requirements. It is a designer’s responsibility to adapt the construction details to a project’s requirements.

NRCA makes these construction details available in a computer-aided design (CAD) format to allow users to customize these construction details using their own CAD software applications to suit their specific project needs.

The information contained in this manual is intended

primarily to address construction details applicable to new construction. When considering reroofing projects, the Reroofing Manual section of The NRCA Roofing Manual: Architectural Metal Flashing, Condensation Control and Reroofing should be consulted regarding the decision to re-cover or remove existing roof systems and for general information applicable to reroofing low- and steep-slope roof systems. Once this decision is made, most information contained within this chapter can also apply to reroofing.

NRCA suggests this chapter be used in the design of roof systems only after a number of criteria have been carefully considered, including:

- Climate and geographic location
- A building's intended use and design life expectancy
- Exterior and interior temperature and humidity conditions
- Code requirements
- Type of roof deck
- Slope and drainage
- A roof's configuration
- Building movement
- Fire, wind and impact resistance
- Type and amount of insulation needed
- Need for ventilation
- Maintenance, repair and reroofing
- Compatibility with adjacent components, including potential material discharge onto a roof
- Construction sequencing
- Worker safety
- Potential building additions
- Odors, noise and dust generated by certain system application methods
- Rooftop traffic
- Reflectivity or emissivity

These criteria play important roles in the success or failure of every roof assembly and must be considered by a

designer to determine the appropriate components of a roof assembly, applicable specifications and construction details to be used.

In addition, NRCA recommends designers consider the following factors for SPF roof systems.

Other Components: Components that may be provided or installed by other trades that are integrated into roof systems can be critical to the weathertight integrity of completed roof systems. These components may include:

- Metal counterflashings at curbs and other penetrations
- Lead flashings, drains and plumbing vent stacks
- Drain heads, clamps and strainers
- Sheet-metal vents
- Sheet-metal pitch pans
- Through-wall flashings
- Skylight components and flashings
- Smoke hatch components and flashings
- Expansion joints and related components
- Wood blocking and attachment
- Pipe or conduit supports
- Crickets and saddles
- Siding or cladding
- Chimney caps
- Wall cladding
- Permanent safety anchors or guardrails
- Microwave or satellite dish components
- Lightning protection arresters and cables
- Photovoltaic systems

Definition of responsibility for the above components should be determined prior to job initiation.

Roof Assembly Components—Deck, Insulation and SPF: In all the construction details, unless otherwise noted, the primary components of each construction detail are illustrated as generic components.

Wood Nailers and Blocking: Many of the construction details illustrated in this manual depict wood nailers and blocking at roof edges and other points of roof termination. Wood nailers must be adequately fastened to the substrate below to resist uplift loads. This especially is true at parapet walls and copings and roof edges where edge-metal shapes are fastened to wood blocking.

Among other advantages, the nailers provide protection for the edges of rigid board insulation and provide a substrate for anchoring flashing materials. Wood nailers should be a minimum of 2 x 6 nominal-dimension lumber.

To provide an adequate base, nailers should be securely attached to a roof deck, wall and/or structural framing. In the design of specific details for a project, a designer should describe and clearly indicate the manner in which wood nailers and/or blocking should be incorporated into construction details. A designer should specify the means of attachment, as well as the fastening schedule for all wood nailers and blocking.

Preservative-treated Wood: Preservative-treated wood available for consumer use no longer is treated with chromate copper arsenate (CCA). Some commercial uses of CCA are still available. The new treatment processes use alkaline copper quat (ACQ), copper azole (CBA), sodium borates (SBX), ammoniacal copper zinc arsenate (ACZA) or variations of these compounds. Most treatments except SBX are more corrosive than CCA and require fasteners, anchors and connectors of specific composition to resist corrosion.

NRCA suggests the following guidelines when encountering the current generation of treated wood:

- Carbon steel, aluminum and electroplated galvanized steel fasteners and connectors should not be used in contact with treated wood. Hot dipped galvanized fasteners complying with ASTM A153, “Standard Specification for Zinc Coating (Hot-Dip) on Iron and Steel Hardware,” and connectors complying with ASTM A653, “Standard Specification for Steel Sheet, Zinc-coated (Galvanized) or Zinc-Iron Alloy-Coated (Galvannealed) by the Hot-Dip Process,” Class G185, generally are acceptable. Type 304 or Type 316 stainless-steel fasteners and connectors

are recommended for maximum corrosion resistance.

- Fasteners with proprietary anti-corrosion coatings may be acceptable for use with treated wood.

When the use of such proprietary coated fasteners and connectors is being considered, fastener manufacturers should be consulted for specific information regarding the performance of their products in treated wood and any precautions or special instructions that may be applicable.

- Aluminum fasteners, flashings and accessory products should not be used in direct contact with any treated wood. ACQ-treated wood is not compatible with aluminum.
- Uncoated metal and painted metal flashings and accessories except for 300-series stainless steel should not be used in direct contact with treated wood. Metal products except stainless steel may be used if separated from treated wood by a spacer or barrier, such as a single-ply membrane or self-adhering polymer-modified bitumen membrane.
- SPF will not bond well to treated wood and may need primers or mechanical means to ensure adhesion.

NRCA is of the opinion the corrosion-related concerns regarding the use of the current generation of treated wood possibly outweigh the benefits that treated wood provides as a component in roof assemblies. In many instances, the use of nontreated, construction-grade wood is suitable for use in roof assemblies as blocking or nailers provided reasonable measures are taken to ensure the nontreated wood remains reasonably dry when in service.

Where a specific construction detail provides for a secondary means of waterproofing, NRCA now considers the use of nontreated, construction-grade wood to be an acceptable substitute for treated wood.

Job-site-fabricated Components: A majority of the construction details illustrated in this manual depict job-site-fabricated construction. Many roof system manufacturers offer prefabricated flashing components or have guidelines that permit the use of materials other than those indicated in these details. Flashing materials may

vary greatly; individual manufacturer's requirements should be examined and evaluated for construction compatibility.

Penetrations and Clearance: Roof drains, penetration pockets and vertical sides of curbs often have particular installation or attachment requirements, which follow:

- Interior roof drain bowls and under-deck clamps typically are furnished and installed by others. Clamping rings and dome strainers generally are furnished by others and installed by a roofing contractor.
- Prefabricated flashing, metal sleeves and curbs with premolded pipe flashings are preferred for sealing pipes or irregularly shaped support legs. Penetration pockets or pitch pans are acceptable as a last alternative. Pourable sealer is the recommended top fill material for penetration pockets.
- Vertical wood curb nailers may be secured to a structural member or the roof deck using additional wood blocking, metal angle supports, or a

combination of wood and metal. Curbs may consist of prefabricated (insulated where appropriate) metal curbs and, when securing flashing is necessary, should have nailers at the top edge.

The maximum amount of space should be provided between pipes, walls and curbs to facilitate proper installation of SPF and flashings. NRCA recommends a minimum of 12 inches of clearance between pipes, a minimum of 12 inches of clearance between pipes and curbs or walls, and a minimum of 24 inches of clearance between walls and curbs. SPF roof systems may have different installation methods that may require different spacings, and certain project conditions may not allow these recommended clearances. However, adequate space (i.e., clearance) is required for a mechanic to properly install the required flashings at these locations. Refer to Figure 8-1. Structural supports that penetrate vertically through the roof membrane preferably should be square or round. H-, L- and T-shaped structural supports are not preferred because they are difficult to flash properly and may be a constant maintenance problem.

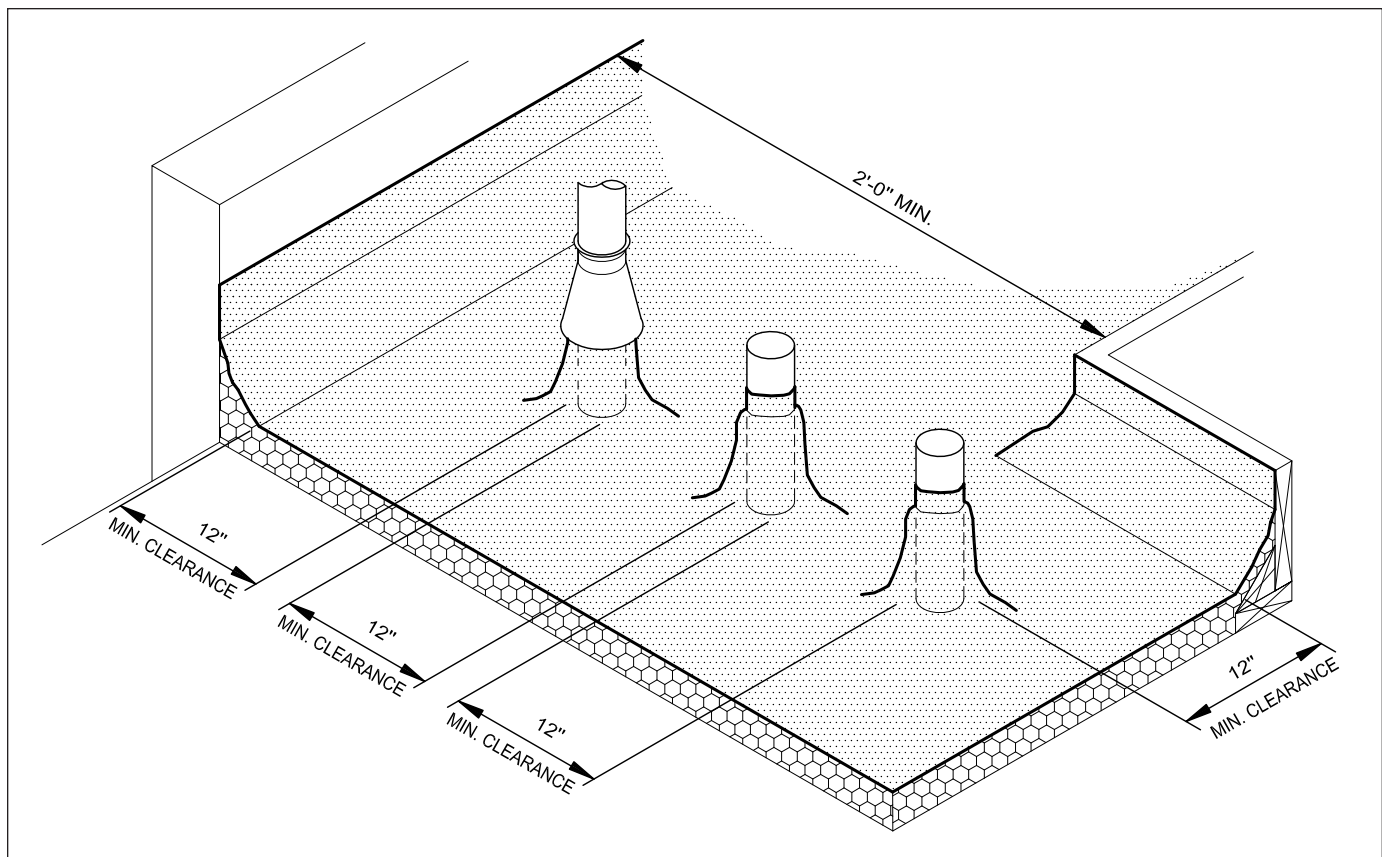

Figure 8-1: Guide for clearances between pipes, walls and curbs

Fastener Spacing: Fastener spacing for gasketed fasteners depicted in the construction details generally is between 8 inches and 24 inches. Fastener spacings provided in the details are nominal dimensions.

Metal Flashing Components: Because metals have thermal expansion and contraction characteristics that differ from most other roof covering materials, it is advisable to isolate metal flashings from the primary roof covering and flashing when possible. NRCA suggests avoiding, where possible, flashing details that require rigid metal flanges to be embedded or sandwiched into SPF coatings.

Often, SPF roof systems are terminated with perimeter edge-metal flashing that is commonly referred to as a foam stop. If the foam stop has a vertical height less than 1 inch, NRCA recommends installing a V-groove filled with elastomeric sealant. See Figure 8-2.

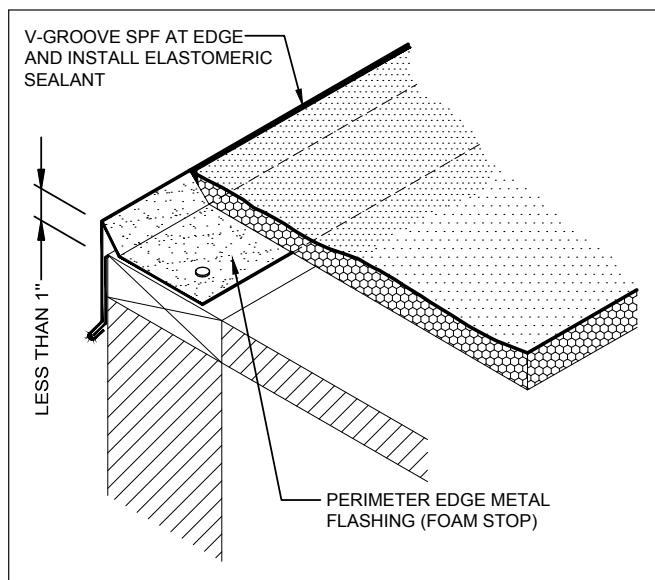

Figure 8-2: Perimeter edge-metal flashing (foam stop)

Illustrations of metal component joinery, such as concealed or cover plates, are located in the Architectural Metal Flashing section (Details SM-) of The NRCA Roofing Manual: Architectural Metal Flashing, Condensation Control and Reroofing. NRCA does not recommend caulking the joint between the bottom of the exterior vertical face of a coping cap or metal edge flashing and building exterior because it does not add to the waterproofing integrity of the assembly and may, in fact,

hinder the ability of the wall construction to dissipate moisture. Proper gauge, girth and continuous cleat fastening should minimize wind-uplift damage. The bottom of the exterior vertical face of a coping cap or metal edge flashing should be a minimum of 1 inch below the uppermost edge of the exterior wall material.

Parapet Walls and Roof Decks: Parapet walls and deck-wall intersections often require specific additional components to accommodate vertical flashings or coping caps. These items can take various forms and be made of various materials.

- Tapered, continuous, rigid shims for top of parapet walls provide positive slope for drainage and may be composed of wood, insulation, metal or other compatible material.
- Flashing substrate materials on vertical walls and backsides of parapets may include brick or concrete masonry, precast or poured-in-place concrete, wood and gypsum board.
- Through-wall flashing materials, weep holes and masonry caulking are typically furnished and installed by masonry contractors. Sheet-metal receivers may be furnished by a sheet-metal contractor and installed by masonry and wall/cladding contractors.
- Prior to installing metal caps, parapet walls need to be covered by a sheet membrane liner.
- Concrete, masonry, metal and gypsum-board walls should be primed in preparation for SPF flashings.

Rooftop Equipment and Associated Flashing:

NRCA does not recommend using a roof as a location for HVAC equipment. Weatherproofing-related problems may be encountered because of the design of an HVAC unit. There often is a lack of clearly defined responsibility for the weatherproofing of HVAC units among the parties involved, such as contractors, material suppliers and manufacturers.

Running conduits and pipes within the interior of rooftop curbs will minimize rooftop penetrations. Many weatherproofing problems related to HVAC equipment may be attributed to one or more of the following:

- Improper design of the equipment's exterior shell or housing. This may allow water to enter the building directly through the unit.
- Improper design or penetration of condensate pans or drainage lines. This may allow water to enter the building below the HVAC equipment.
- Improper design of pre-manufactured HVAC equipment curbs. There are often no means to properly terminate base flashings.
- Inadequate design of the structural framing or roof deck intended to support the weight of HVAC units. This may result in excessive roof deflection and subsequent ponding water.
- Improper flashing of the penetration(s), such as pipes, conduits and drain lines, that extend through the roof to service the HVAC equipment.
- Lack of service walkways to and around mechanical equipment for rooftop traffic.

Expansion Joints: The expansion joints depicted generally provide movement capability in longitudinal and transverse directions and must be designed to accommodate the amount of expected movement. It is the designer's responsibility to determine the amount and direction of expected movement at expansion joints. The expansion joints depicted generally will not accommodate seismic movement. Where seismic movement is expected, alternative details likely are needed.

Skylights: Skylights incorporated into SPF roof systems and structural metal panel roof assemblies should be installed on curbs so they are out of the drainage plane—that is, above the plane of roof panels. Skylight frames should overlap the curb a minimum of 3 inches to act as counterflashing, or separate counterflashing should be installed.

Skylights require fall protection. NRCA suggests permanent internal or external fall-protection devices be included at all skylights.

Drains and Drain Sumps: NRCA recommends the use of cast-iron drain bowls, clamping rings and strainers at internal drain locations. Cast iron is the only material that will meet building code requirements for drain

materials. Drain sumps are recommended at all internal drain locations.

Drain sumps reduce the potential for localized ponding at drain locations because of a buildup of materials and a drain clamping ring. Drain sumps should be round and sized equal to the drain bowl diameter plus 24 inches. For example, if a drain bowl's diameter is 12 inches, the drain sump should be approximately 36 inches in diameter. Slope for drain sumps is recommended to be 1½:12. See Figure 8-3.

To accommodate the 1½-inch-per-foot taper for each side of the drain sump, the drain bowl flange must be set at a level that is 1½ inches below the height of the insulation at the outer edge of the drain sump. The chart provides the height of the drain bowl above the roof deck based on the insulation thickness at the outer edge of the drain sump. See Figure 8-4.

Crickets and Saddles: The use of tapered insulation or SPF may not necessarily result in complete, immediate drainage of SPF surfaces. Some residual surface water may remain on the SPF surfaces at junctures, transitions and immediate drain areas following periods of rain. To help reduce the amount of residual surface water between drains, behind curbs and along roof edges between scuppers, NRCA recommends installing crickets and saddles. Figures 8-5 (page 340) and 8-6 (page 341) provide additional information regarding cricket and saddle slope and length-to-width (L:W) ratios.

Surface Protection: Prior to the application of SPF, provide masking protection to prevent the overspray of materials onto surfaces not intended to receive SPF and protective coating. In addition, mask, seal or cover HVAC and ventilation equipment and building air intakes near the work area.

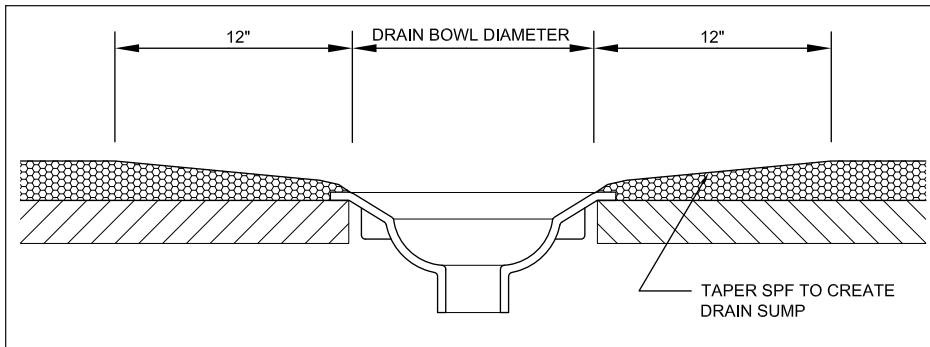

Figure 8-3: Drain sump guidelines

INSULATION THICKNESS AT OUTER EDGE OF SUMP	HEIGHT OF DRAIN BOWL RIM ABOVE DECK
1 1/2"	0"
2"	1/2"
2 1/2"	1"
3"	1 1/2"
3 1/2"	2"
4"	2 1/2"
4 1/2"	3"

NOTES:
 1. SUMP SLOPE IS 1 1/2:12
 2. SUMP SIZE IS 24" + DRAIN BOWL DIAMETER

Figure 8-4: Recommended drain bowl heights

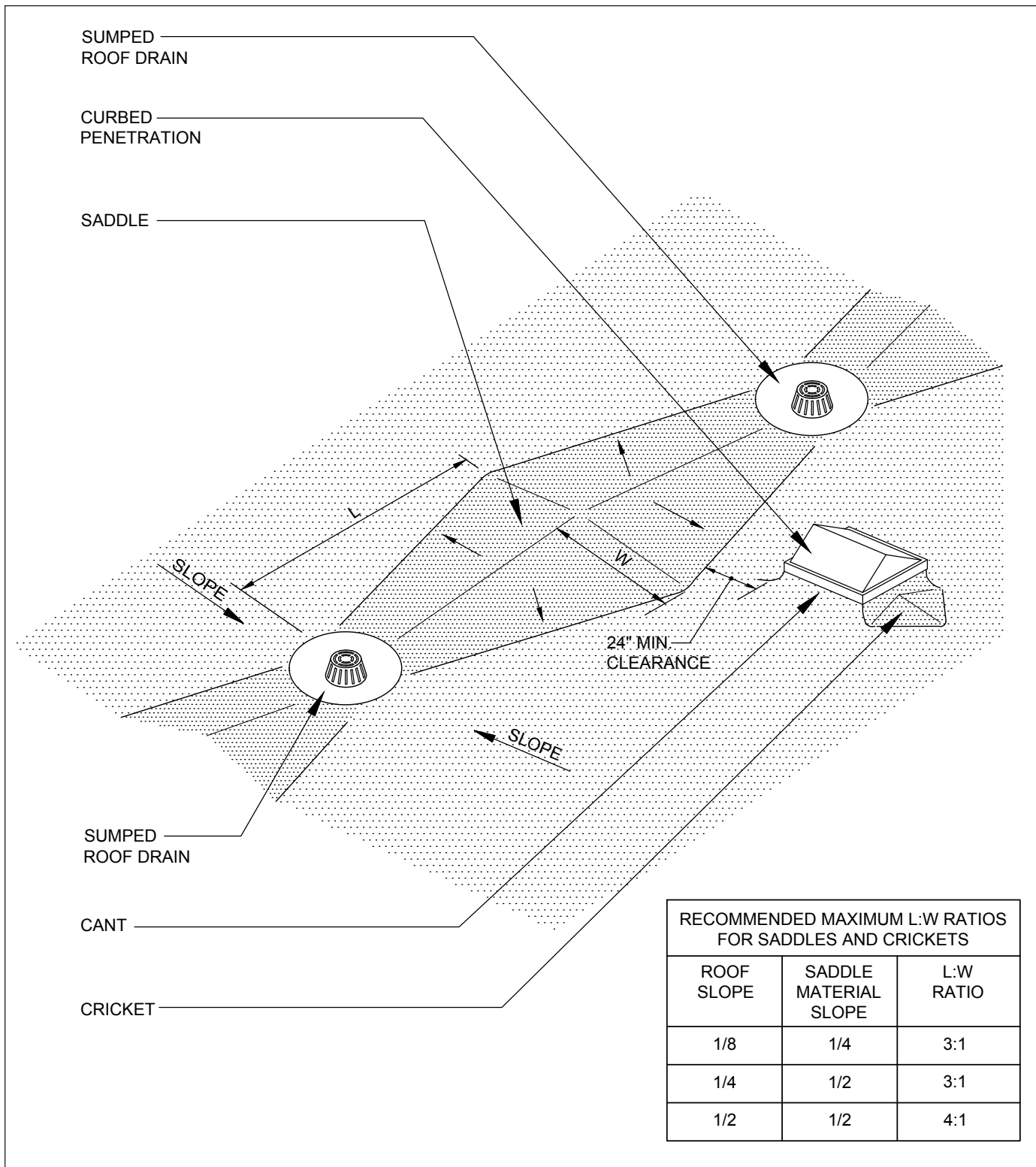

Figure 8-5: Guide for crickets and saddles

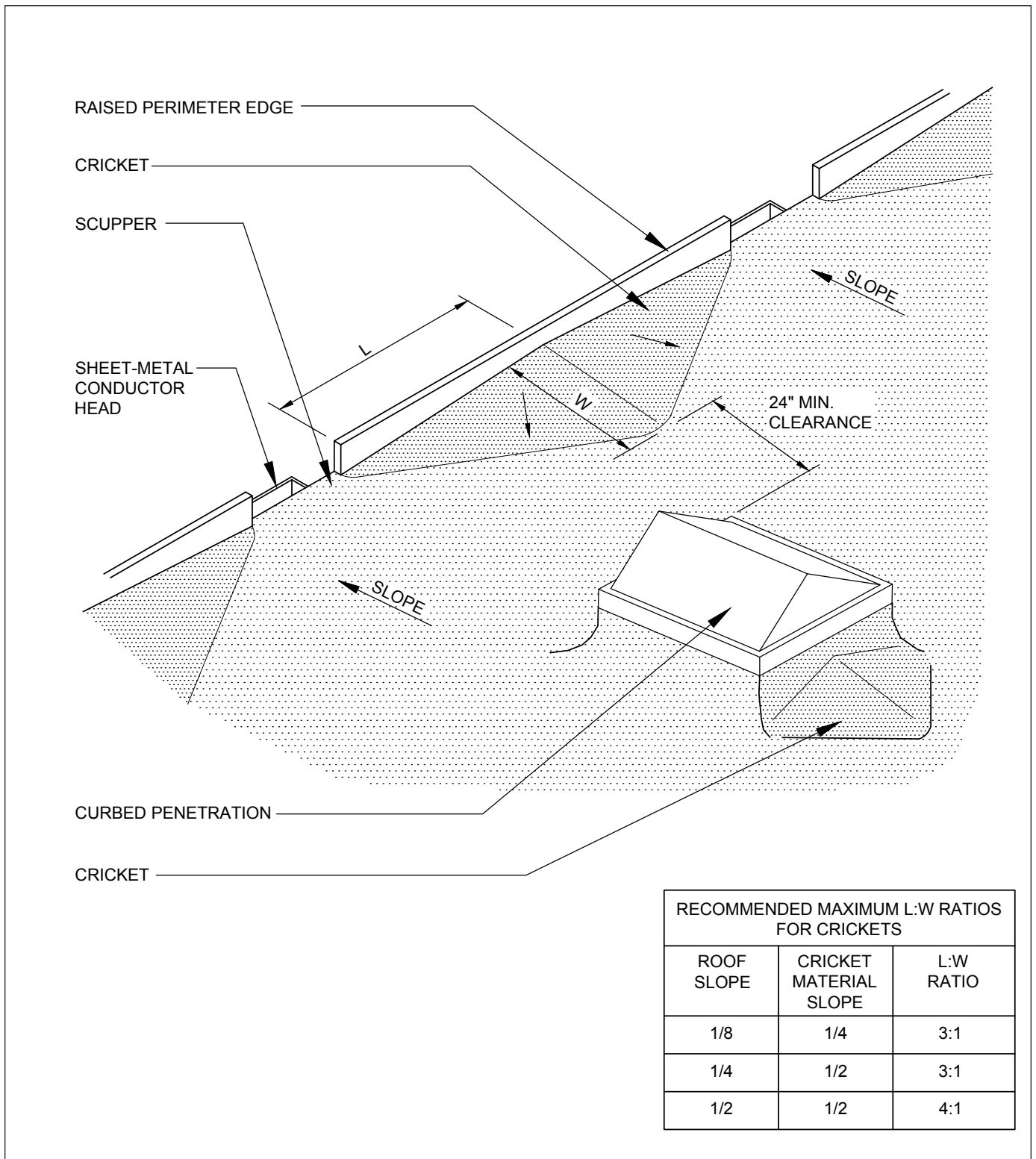

Figure 8-6: Guide for crickets

8.2 Index of Drawings

SPF Construction Details

SPF-1	Base Flashing at Parapet Wall with Metal Coping	344
SPF-2	Perimeter Edge-metal Flashing With Sealant (Foam Stop).....	345
SPF-2A	Perimeter Edge-metal Flashing (Foam Stop)	346
SPF-3	Base Flashing With Counterflashing	347
SPF-3A	Base Flashing.....	348
SPF-4	Base Flashing at Roof-to-wall Expansion Joint.....	349
SPF-5	Base Flashing at Expansion Joint With Metal Cover	350
SPF-6	Base Flashing at Roof System Divider	351
SPF-7	Base Flashing at Equipment Support Curb	352
SPF-7A	Base Flashing at Equipment Support Curb	353
SPF-8	Equipment Support Stand Leg	354
SPF-8A	Equipment Support Stand Leg	355
SPF-9	Base Flashing at Prefabricated Metal Curb.....	356
SPF-10	Base Flashing at Wood Curb	357
SPF-11	Base Flashing at Structural Member Through Roof Deck	358
SPF-11A	Base Flashing at Structural Member Through Roof Deck	359
SPF-12	Base Flashing at Sheet-metal Enclosure for Piping Through Roof Deck.....	360
SPF-13	Base Flashing at Isolated Stack Flashing.....	361
SPF-14	Base Flashing at Stack Vent [Hot or Cold].....	362
SPF-15	Pipe Penetration	363
SPF-16	Cable Penetration	364
SPF-17	Lightning Protection Terminal	365
SPF-18	Roof Drain	366
SPF-19	Through-wall Scupper.....	367
SPF-20	Overflow Scupper	368
SPF-21	Gutter With Perimeter Edge Metal	369

SPF Re-cover Construction Details

SPF(R)-1	Base Flashing at Parapet Wall With New Metal Coping for SPF Re-cover	370
SPF(R)-1A	Base Flashing at Parapet Wall With Existing Metal Coping and New Counterflashing for SPF Re-cover	371
SPF(R)-2	Perimeter Edge With Existing Embedded Edge Metal (Gravel Stop) for SPF Re-cover	372
SPF(R)-3	Base Flashing With New Counterflashing for SPF Re-cover	373
SPF(R)-3A	Base Flashing for SPF Re-cover	374
SPF(R)-4	Base Flashing at Roof-to-wall Expansion Joint for SPF Re-cover	375
SPF(R)-5	Base Flashing at Expansion Joint With New Sheet-metal Cover for SPF Re-cover	376
SPF(R)-6	Base Flashing at Equipment Support Curb With Existing Sheet-metal Cover and New Counterflashing for SPF Re-cover	377
SPF(R)-6A	Base Flashing at Equipment Support Curb for SPF Re-cover.....	378
SPF(R)-7	Base Flashing at Equipment Support Stand and Rain Collar Penetration for SPF Re-cover	379
SPF(R)-8	Base Flashing at Curb With Existing Sheet-metal Cover and New Counterflashing for SPF Re-cover	380
SPF(R)-9	Base Flashing at Isolated Stack Flashing for SPF Re-cover	381
SPF(R)-10	Plumbing Vent for SPF Re-cover.....	382
SPF(R)-11	Roof Drain for SPF Re-cover.....	383

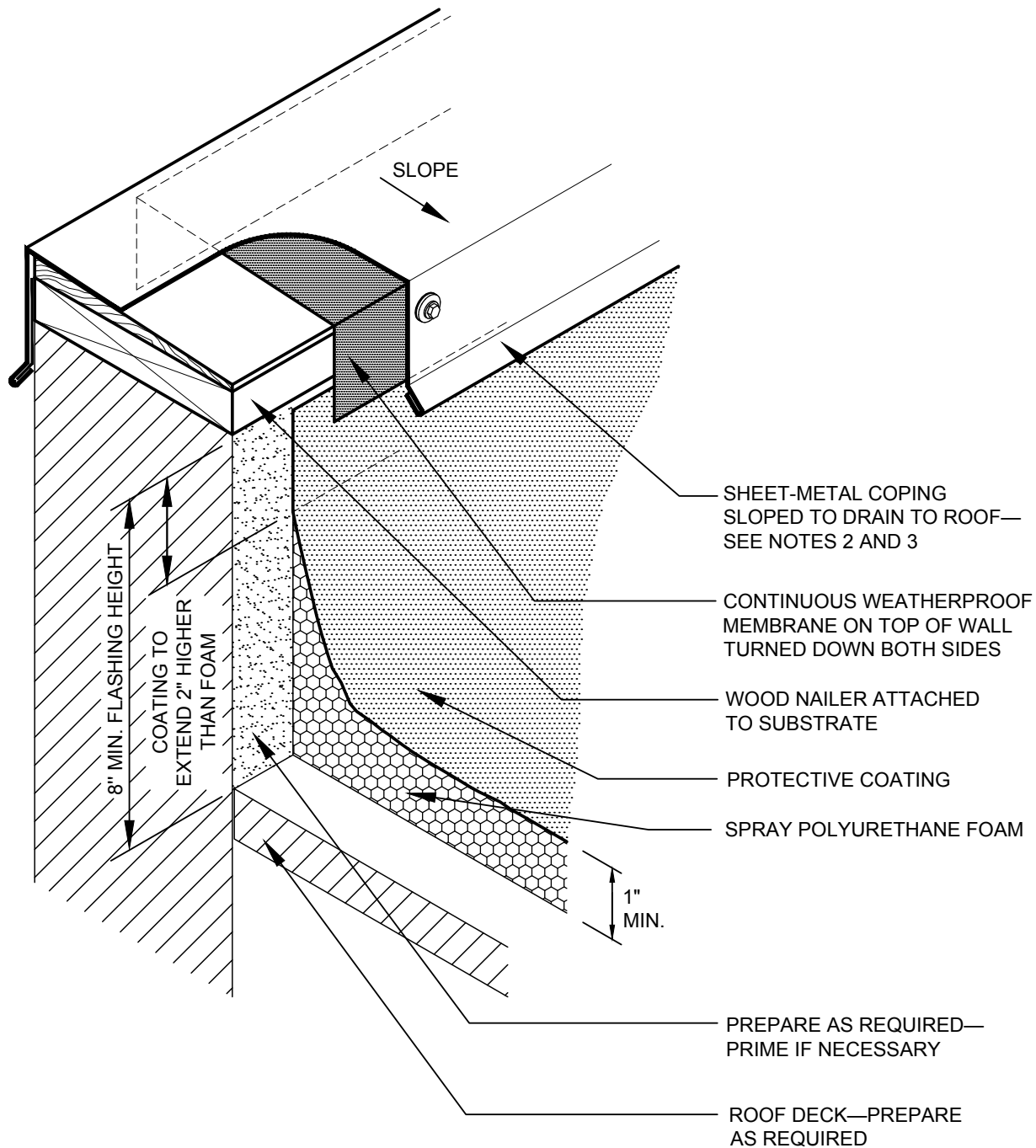

NOTES:

1. THIS DETAIL DOES NOT ALLOW FOR DIFFERENTIAL MOVEMENT BETWEEN THE DECK AND WALL. SEE DETAIL SPF-4 FOR EXPANSION JOINT AT A DECK-TO-WALL LOCATION.
2. REFER TO THE ARCHITECTURAL METAL FLASHING SECTION OF THE NRCA ROOFING MANUAL: ARCHITECTURAL METAL FLASHING, CONDENSATION CONTROL AND REROOFING FOR DESIGN, JOINERY AND SECUREMENT OPTIONS FOR COPINGS.
3. REFER TO THE INTRODUCTION IN CHAPTER 8—CONSTRUCTION DETAILS FOR ADDITIONAL INFORMATION.



BASE FLASHING AT PARAPET WALL WITH METAL COPING

2012

NOT DRAWN TO SCALE

SPF-1

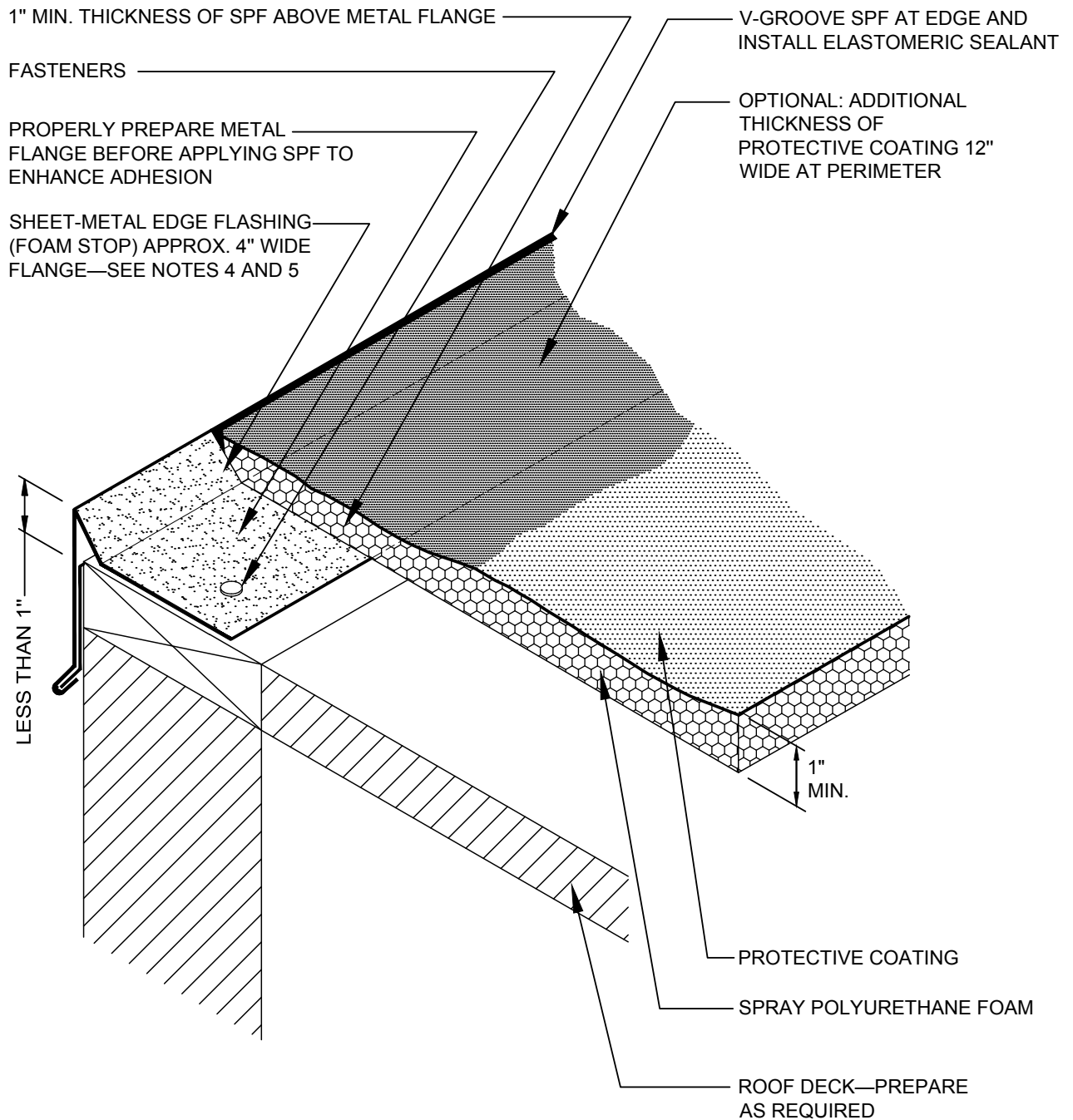

NOTES:

1. WHERE THE SPF IS TRIMMED OR GROUND FLUSH, ADDITIONAL COATING THICKNESS IS REQUIRED.
2. THIS DETAIL SHOULD BE USED ONLY WHEN THE DECK IS SUPPORTED BY THE OUTSIDE WALL.
3. ELASTOMERIC SEALANT TO BE COMPATIBLE WITH COATING.
4. REFER TO THE ARCHITECTURAL METAL FLASHING SECTION OF THE NRCA ROOFING MANUAL: ARCHITECTURAL METAL FLASHING, CONDENSATION CONTROL AND REROOFING FOR DESIGN, JOINERY AND SECUREMENT OPTIONS FOR COPINGS.
5. REFER TO THE INTRODUCTION IN CHAPTER 8—CONSTRUCTION DETAILS FOR ADDITIONAL INFORMATION.



PERIMETER EDGE-METAL FLASHING WITH SEALANT [FOAM STOP]

2012

NOT DRAWN TO SCALE

SPF-2

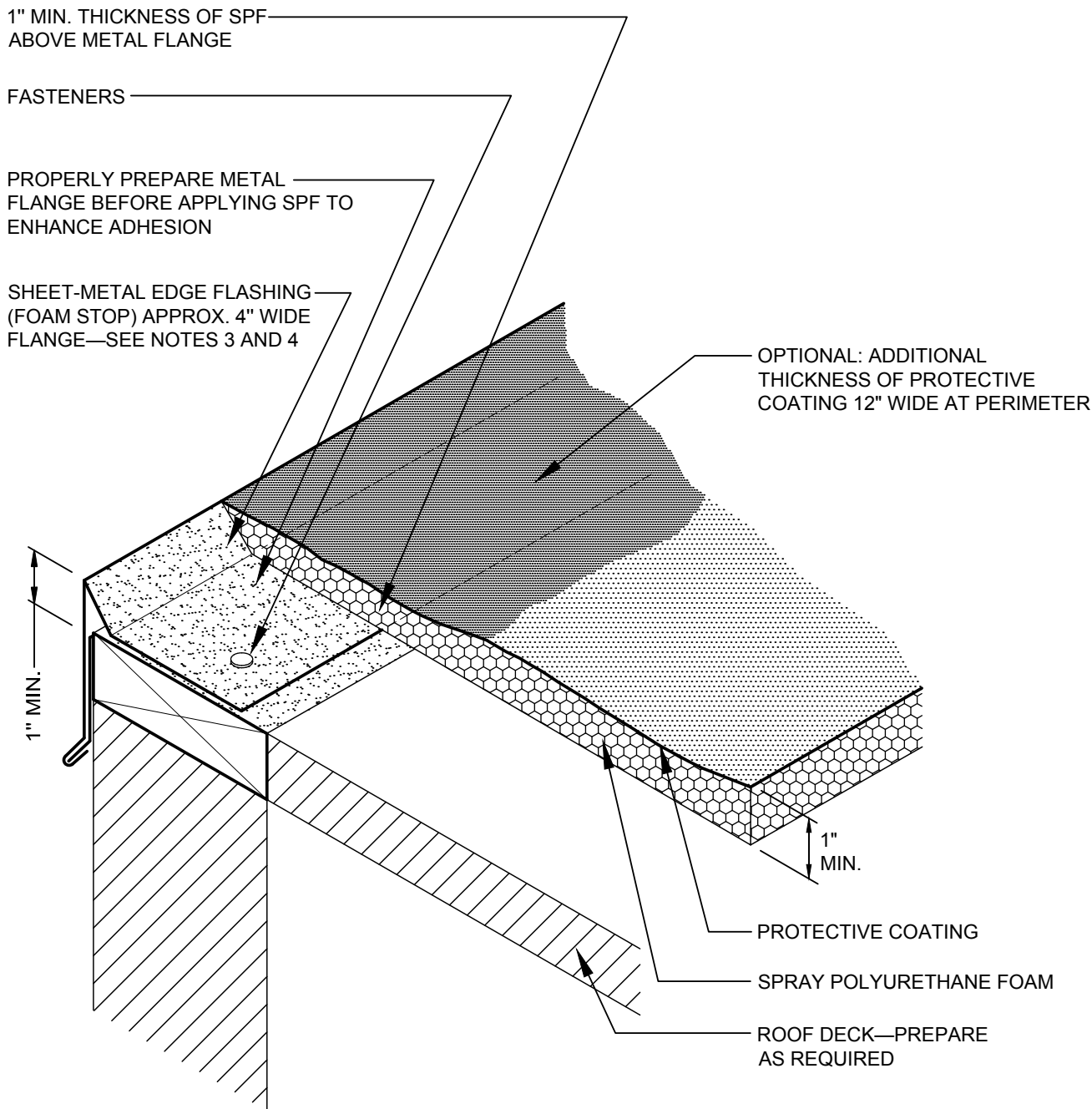

NOTES:

1. WHERE THE SPF IS TRIMMED OR GROUND FLUSH, ADDITIONAL COATING THICKNESS IS REQUIRED.
2. THIS DETAIL SHOULD BE USED ONLY WHEN THE DECK IS SUPPORTED BY THE OUTSIDE WALL.
3. REFER TO THE ARCHITECTURAL METAL FLASHING SECTION OF THE NRCA ROOFING MANUAL: ARCHITECTURAL METAL FLASHING, CONDENSATION CONTROL AND REROOFING FOR DESIGN, JOINERY AND SECUREMENT OPTIONS FOR COPINGS.
4. REFER TO THE INTRODUCTION IN CHAPTER 8—CONSTRUCTION DETAILS FOR ADDITIONAL INFORMATION.



PERIMETER EDGE-METAL FLASHING [FOAM STOP]

2012

NOT DRAWN TO SCALE

SPF-2A

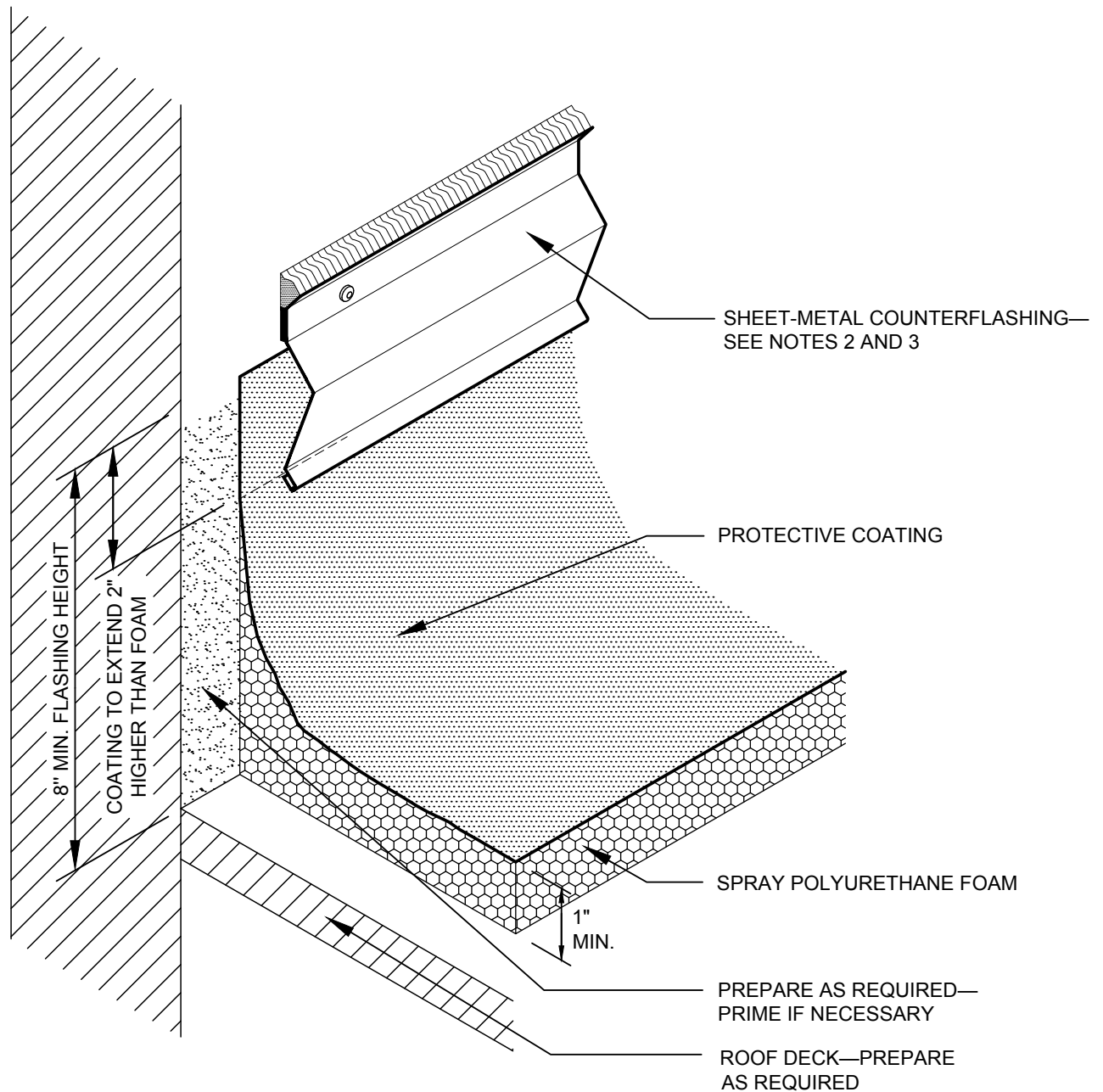

NOTES:

1. THIS DETAIL DOES NOT ALLOW FOR DIFFERENTIAL MOVEMENT BETWEEN THE DECK AND WALL. SEE DETAIL SPF-4 FOR EXPANSION JOINT AT A DECK-TO-WALL LOCATION.
2. REFER TO THE ARCHITECTURAL METAL FLASHING SECTION OF THE NRCA ROOFING MANUAL: ARCHITECTURAL METAL FLASHING, CONDENSATION CONTROL AND REROOFING FOR DESIGN, JOINERY AND SECUREMENT OPTIONS FOR COUNTERFLASHINGS.
3. REFER TO THE INTRODUCTION IN CHAPTER 8—CONSTRUCTION DETAILS FOR ADDITIONAL INFORMATION.



BASE FLASHING WITH COUNTERFLASHING

2012

NOT DRAWN TO SCALE

SPF-3

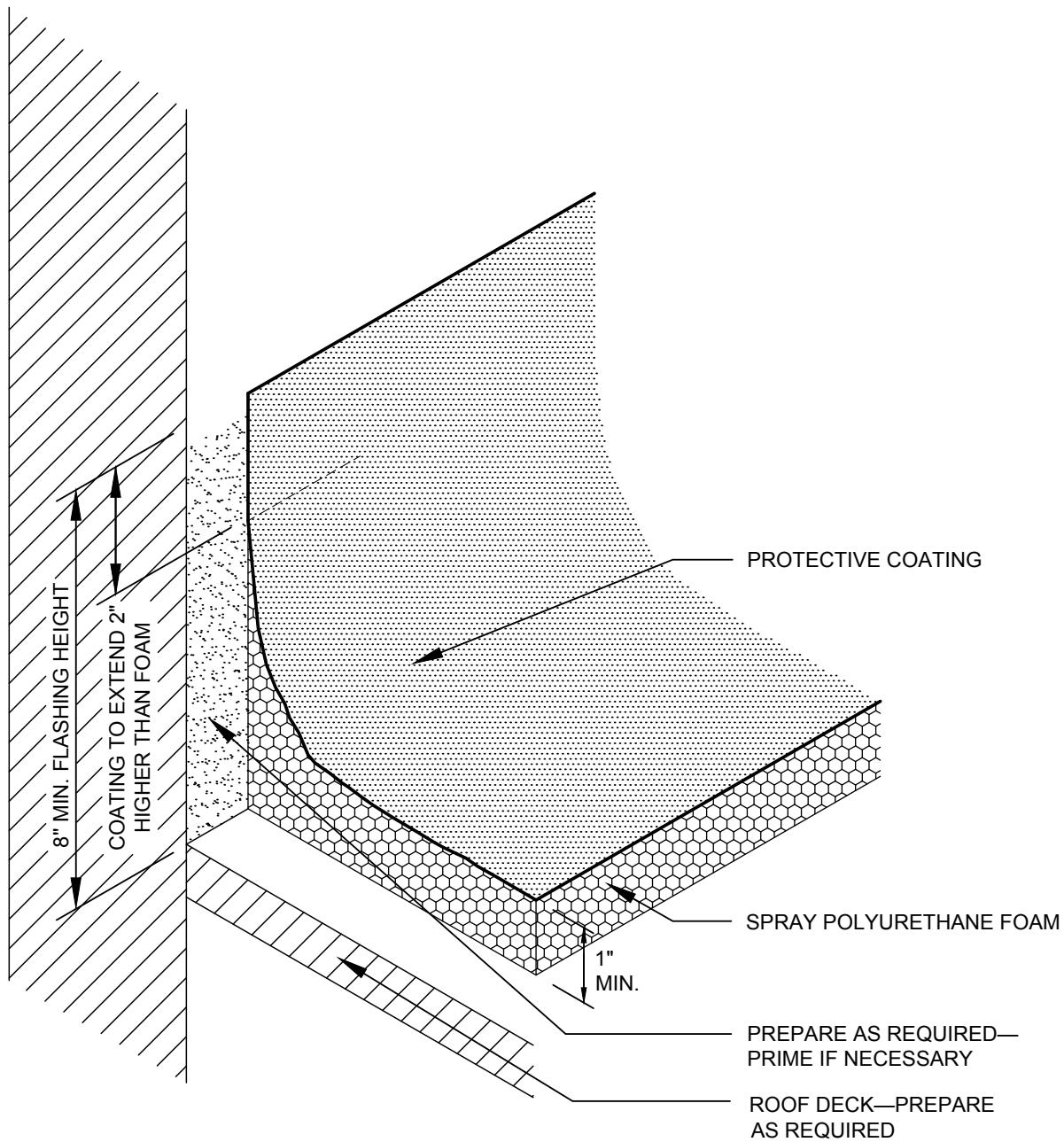

NOTES:

1. THIS DETAIL DOES NOT ALLOW FOR DIFFERENTIAL MOVEMENT BETWEEN THE DECK AND WALL. SEE DETAIL SPF-4 FOR EXPANSION JOINT AT A DECK-TO-WALL LOCATION.
2. REFER TO THE INTRODUCTION IN CHAPTER 8—CONSTRUCTION DETAILS FOR ADDITIONAL INFORMATION.



BASE FLASHING

2012

NOT DRAWN TO SCALE

SPF-3A

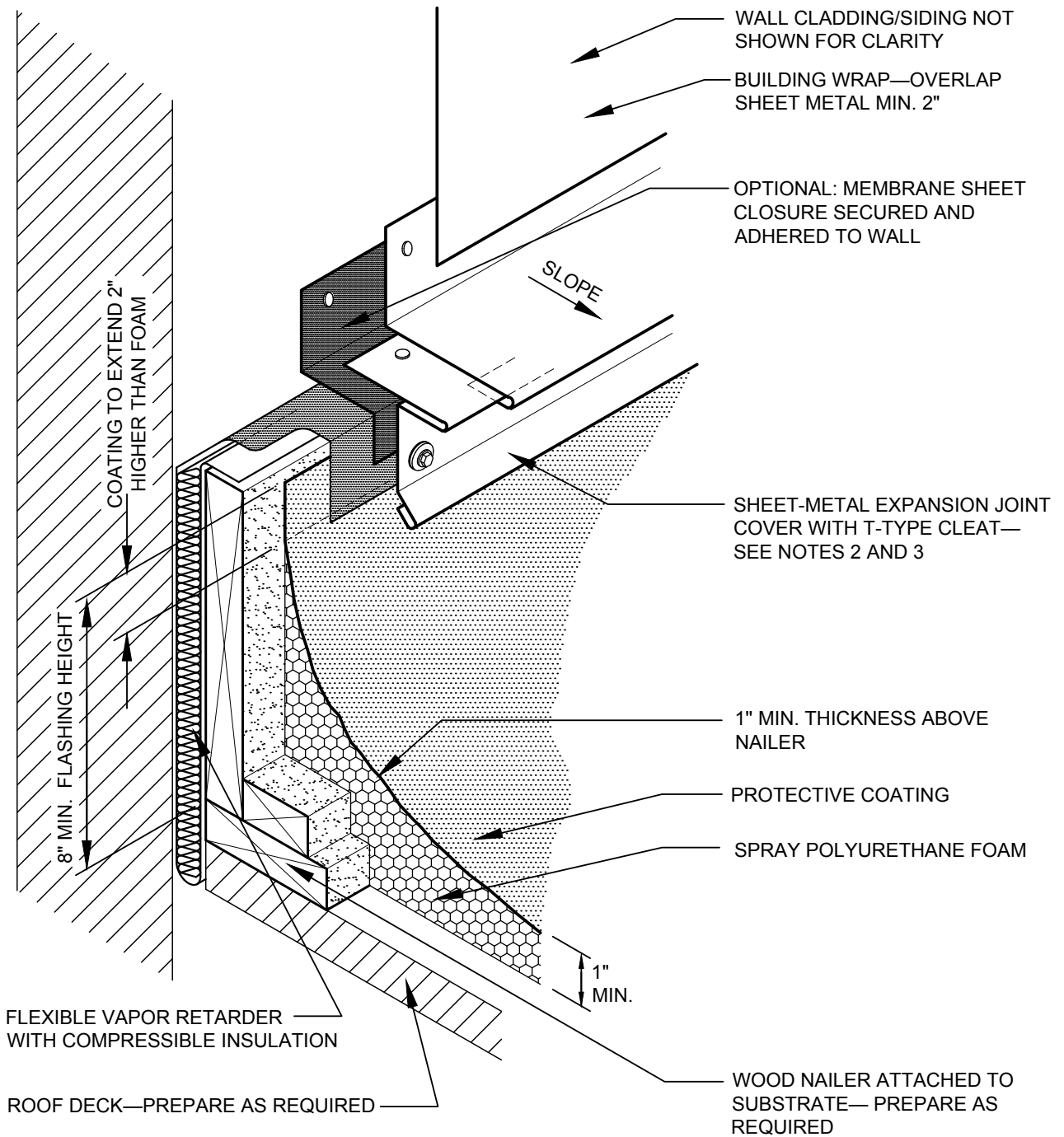

NOTES:

1. THIS DETAIL SHOULD BE USED WHEN THERE IS ANY POSSIBLE DIFFERENTIAL MOVEMENT WILL OCCUR BETWEEN THE DECK AND WALL. THE WOOD MEMBERS SHOULD NOT BE FASTENED TO THE WALL.
2. REFER TO THE ARCHITECTURAL METAL FLASHING SECTION OF THE NRCA ROOFING MANUAL: ARCHITECTURAL METAL FLASHING, CONDENSATION CONTROL AND REROOFING FOR DESIGN, JOINERY AND SECUREMENT OPTIONS FOR COUNTERFLASHINGS.
3. REFER TO THE INTRODUCTION IN CHAPTER 8—CONSTRUCTION DETAILS FOR ADDITIONAL INFORMATION.

	<p>BASE FLASHING AT ROOF-TO-WALL EXPANSION JOINT</p>	
<p>2012</p>	<p>NOT DRAWN TO SCALE</p>	<p>SPF-4</p>

SHEET-METAL EXPANSION JOINT COVER WITH T-TYPE CLEAT—SEE NOTES 3 AND 4

FLEXIBLE WATERPROOF MEMBRANE CLOSURE

COATING TO EXTEND 2" HIGHER THAN FOAM

8" MIN. FLASHING HEIGHT

SLOPE

COMPRESSIBLE INSULATION

WOOD NAILER ATTACHED TO SUBSTRATE—PREPARE AS REQUIRED

NOTES:

1. THIS DETAIL ALLOWS FOR BUILDING MOVEMENT IN MULTIPLE DIRECTIONS.
2. FLASHING REQUIREMENTS TYPICAL FOR BOTH SIDES OF EXPANSION JOINT.
3. REFER TO THE ARCHITECTURAL METAL FLASHING SECTION OF THE NRCA ROOFING MANUAL: ARCHITECTURAL METAL FLASHING, CONDENSATION CONTROL AND REROOFING FOR DESIGN, JOINERY AND SECUREMENT OPTIONS FOR COUNTERFLASHINGS.
4. REFER TO THE INTRODUCTION IN CHAPTER 8—CONSTRUCTION DETAILS FOR ADDITIONAL INFORMATION.

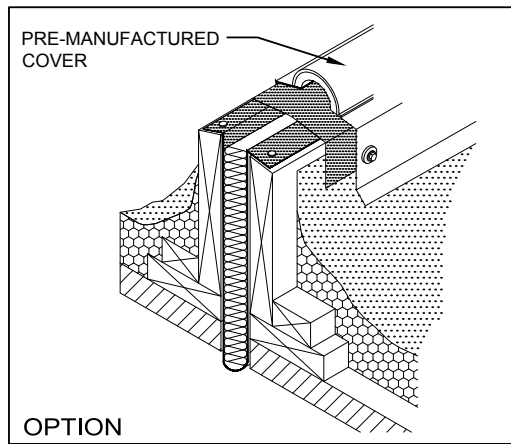

FLEXIBLE VAPOR RETARDER TO SERVE AS INSULATION RETAINER (ATTACHED TO TOP OF CURB)

TOP OF CURB TO DRAIN TO ONE SIDE

1" MIN. THICKNESS OVER NAILER

PROTECTIVE COATING

SPRAY POLYURETHANE FOAM

1" MIN.

ROOF DECK—PREPARE AS REQUIRED



BASE FLASHING AT EXPANSION JOINT WITH METAL COVER

2012

NOT DRAWN TO SCALE

SPF-5

SHEET-METAL ROOF SYSTEM
DIVIDER COVER—
SEE NOTES 3 AND 4

CONTINUOUS WEATHERPROOF
MEMBRANE ON TOP OF CURB
TURNED DOWN BOTH SIDES

TOP OF CURB TO
DRAIN TO ONE SIDE

WOOD NAILER
ATTACHED TO
SUBSTRATE—PREPARE AS
REQUIRED

SPRAY POLYURETHANE
FOAM

1" MIN. THICKNESS
OVER NAILER

PROTECTIVE COATING

FOAM STOP

PROPERLY PREPARE
METAL FLANGE
BEFORE APPLYING
SPF TO ENHANCE
ADHESION

SEE SPF-2 AND 2A FOR
ADDITIONAL INFORMATION

OPTION

COATING TO
EXTEND 2" HIGHER
THAN FOAM

8" MIN. FLASHING HEIGHT

1"
MIN.

ROOF DECK—PREPARE
AS REQUIRED

NOTES:

1. AN AREA DIVIDER SHOULD NEVER RESTRICT THE FLOW OF WATER.
2. FLASHING REQUIREMENTS TYPICAL FOR BOTH SIDES OF THE AREA DIVIDER.
3. REFER TO THE ARCHITECTURAL METAL FLASHING SECTION OF THE NRCA ROOFING MANUAL: ARCHITECTURAL METAL FLASHING, CONDENSATION CONTROL AND REROOFING FOR DESIGN, JOINERY AND SECUREMENT OPTIONS FOR COUNTERFLASHINGS.
4. REFER TO THE INTRODUCTION IN CHAPTER 8—CONSTRUCTION DETAILS FOR ADDITIONAL INFORMATION.



BASE FLASHING AT ROOF SYSTEM DIVIDER

2012

NOT DRAWN TO SCALE

SPF-6

WIDTH OF EQUIPMENT	CLEARANCE
UP TO 24"	14"
25" TO 36"	18"
37" TO 48"	24"
49" TO 60"	30"
61" AND WIDER	48"

FLEXIBLE WATERPROOF MEMBRANE CLOSURE

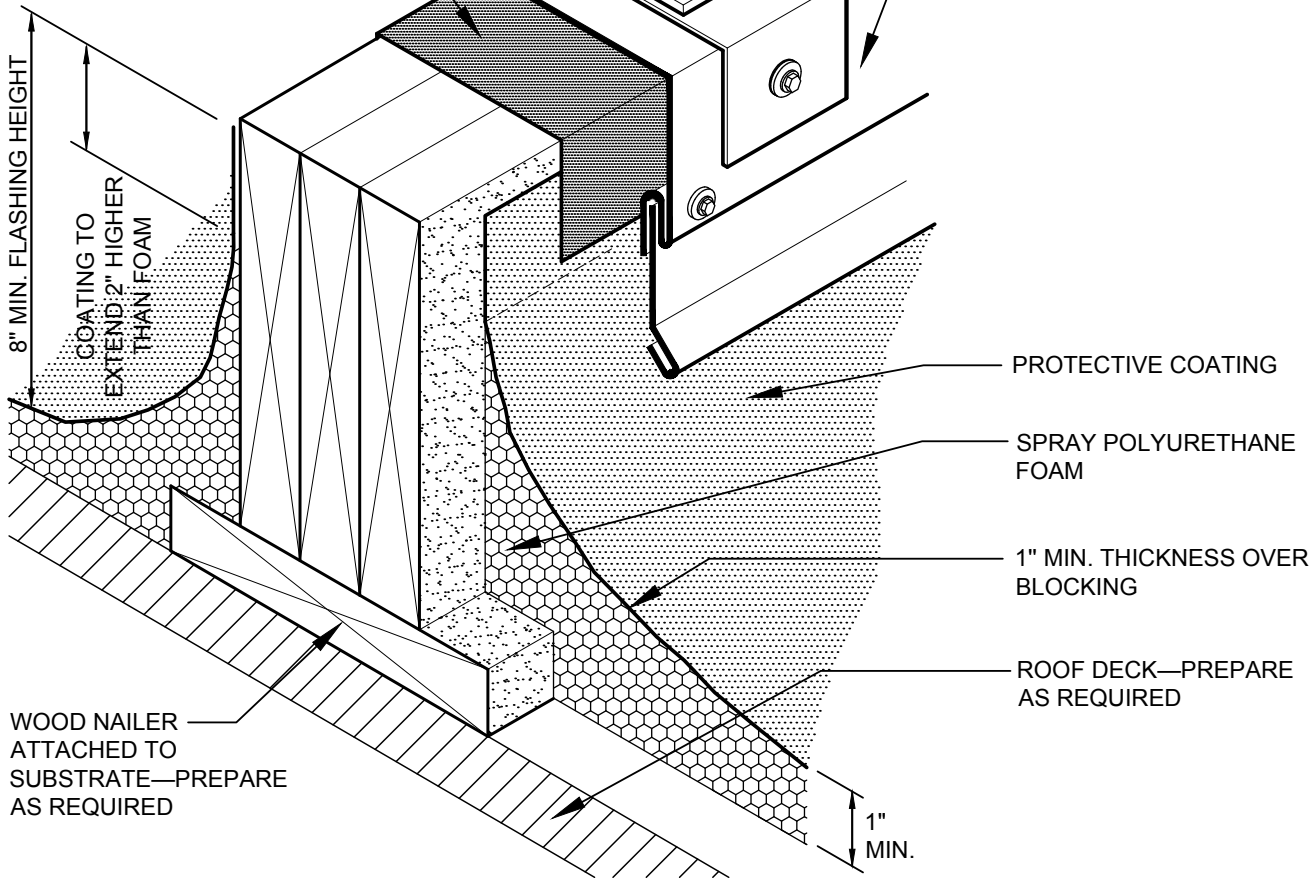

NOTES:

1. THIS DETAIL ALLOWS FOR ROOF SYSTEM MAINTENANCE AROUND THE SUPPORTED EQUIPMENT. THE CONTINUOUS SUPPORT IS PREFERRED IN LIGHTWEIGHT STRUCTURAL SYSTEMS BECAUSE THE EQUIPMENT WEIGHT CAN BE SPREAD ACROSS TWO OR MORE SUPPORTING MEMBERS. WHERE HEAVY STRUCTURAL SYSTEMS ARE USED OR WHERE THE LOAD CAN BE CONCENTRATED OVER A COLUMN, DETAIL SPF-8 MAY BE PREFERRED. A MINIMUM OF 2 FEET OF HORIZONTAL CLEARANCE MUST BE PROVIDED FOR REMOVAL AND REPLACEMENT OF ROOFING AND FLASHING BETWEEN PARALLEL SUPPORTS. REFER TO TABLE ABOVE FOR RECOMMENDATIONS ON VERTICAL CLEARANCE FROM ROOF SURFACE TO BOTTOM OF SUPPORTED EQUIPMENT.
2. FLASHING REQUIREMENTS TYPICAL FOR BOTH SIDES OF SUPPORT CURBS.
3. REFER TO THE ARCHITECTURAL METAL FLASHING SECTION OF THE NRCA ROOFING MANUAL: ARCHITECTURAL METAL FLASHING, CONDENSATION CONTROL AND REROOFING FOR DESIGN, JOINERY AND SECUREMENT OPTIONS FOR COUNTERFLASHINGS.
4. REFER TO THE INTRODUCTION IN CHAPTER 8—CONSTRUCTION DETAILS FOR ADDITIONAL INFORMATION.



BASE FLASHING AT EQUIPMENT SUPPORT CURB

2012

NOT DRAWN TO SCALE

SPF-7

WIDTH OF EQUIPMENT	CLEARANCE
UP TO 24"	14"
25" TO 36"	18"
37" TO 48"	24"
49" TO 60"	30"
61" AND WIDER	48"

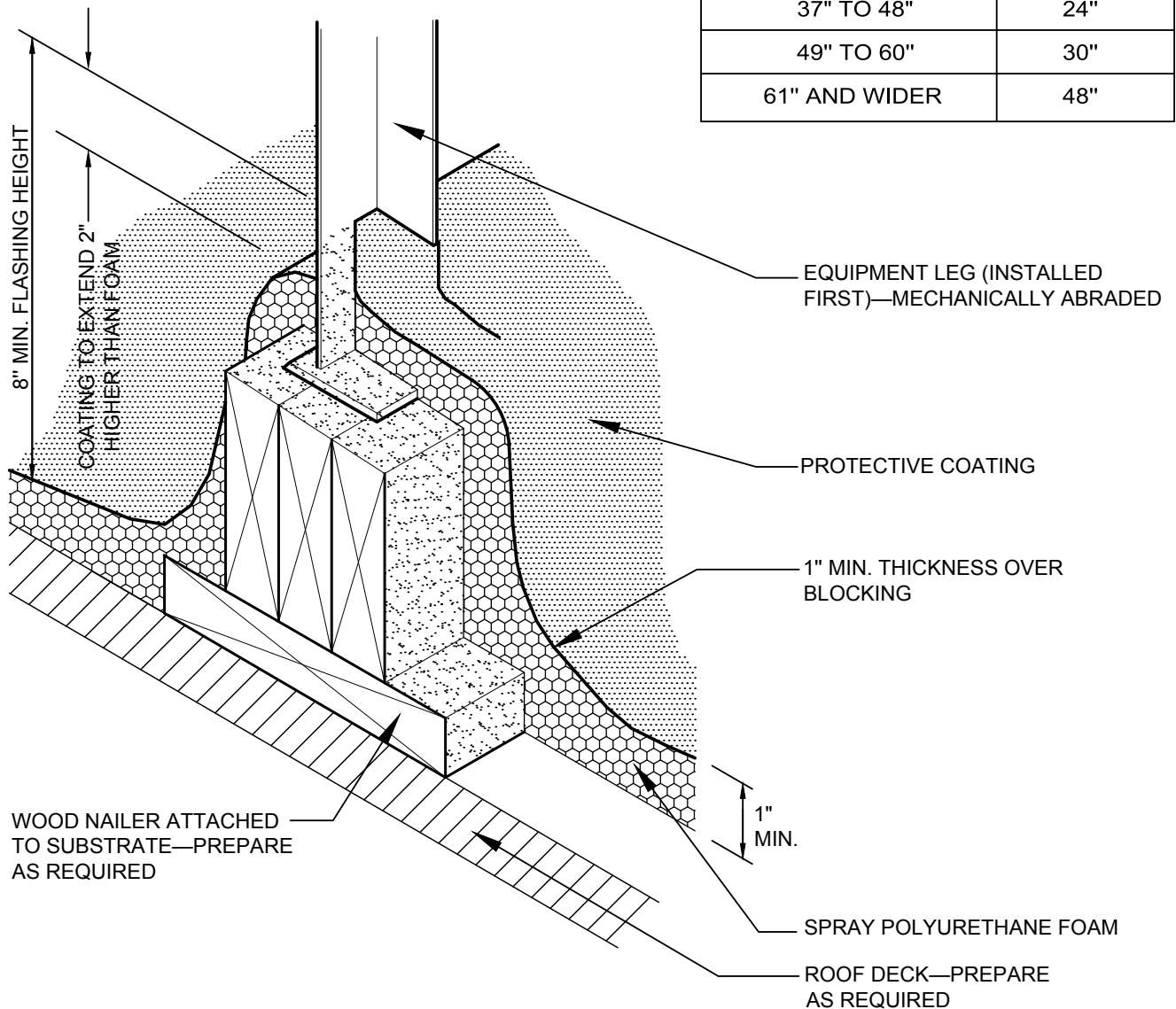

NOTES:

1. THIS DETAIL ALLOWS FOR ROOF SYSTEM MAINTENANCE AROUND THE SUPPORTED EQUIPMENT. THE CONTINUOUS SUPPORT IS PREFERRED IN LIGHTWEIGHT STRUCTURAL SYSTEMS BECAUSE THE EQUIPMENT WEIGHT CAN BE SPREAD ACROSS TWO OR MORE SUPPORTING MEMBERS. WHERE HEAVY STRUCTURAL SYSTEMS ARE USED OR WHERE THE LOAD CAN BE CONCENTRATED OVER A COLUMN, DETAIL SPF-8 MAY BE PREFERRED. A MINIMUM OF 2 FEET OF HORIZONTAL CLEARANCE MUST BE PROVIDED FOR REMOVAL AND REPLACEMENT OF ROOFING AND FLASHING BETWEEN PARALLEL SUPPORTS. REFER TO TABLE ABOVE FOR RECOMMENDATIONS ON VERTICAL CLEARANCE FROM ROOF SURFACE TO BOTTOM OF SUPPORTED EQUIPMENT.
2. FLASHING REQUIREMENTS TYPICAL FOR BOTH SIDES OF SUPPORT CURBS.
3. REFER TO THE ARCHITECTURAL METAL FLASHING SECTION OF THE NRCA ROOFING MANUAL: ARCHITECTURAL METAL FLASHING, CONDENSATION CONTROL AND REROOFING FOR DESIGN, JOINERY AND SECUREMENT OPTIONS FOR COUNTERFLASHINGS.
4. REFER TO INTRODUCTION IN CHAPTER 8—CONSTRUCTION DETAILS FOR ADDITIONAL INFORMATION.



BASE FLASHING AT EQUIPMENT SUPPORT CURB

2012

NOT DRAWN TO SCALE

SPF-7A

WIDTH OF EQUIPMENT	CLEARANCE
UP TO 24"	14"
25" TO 36"	18"
37" TO 48"	24"
49" TO 60"	30"
61" AND WIDER	48"

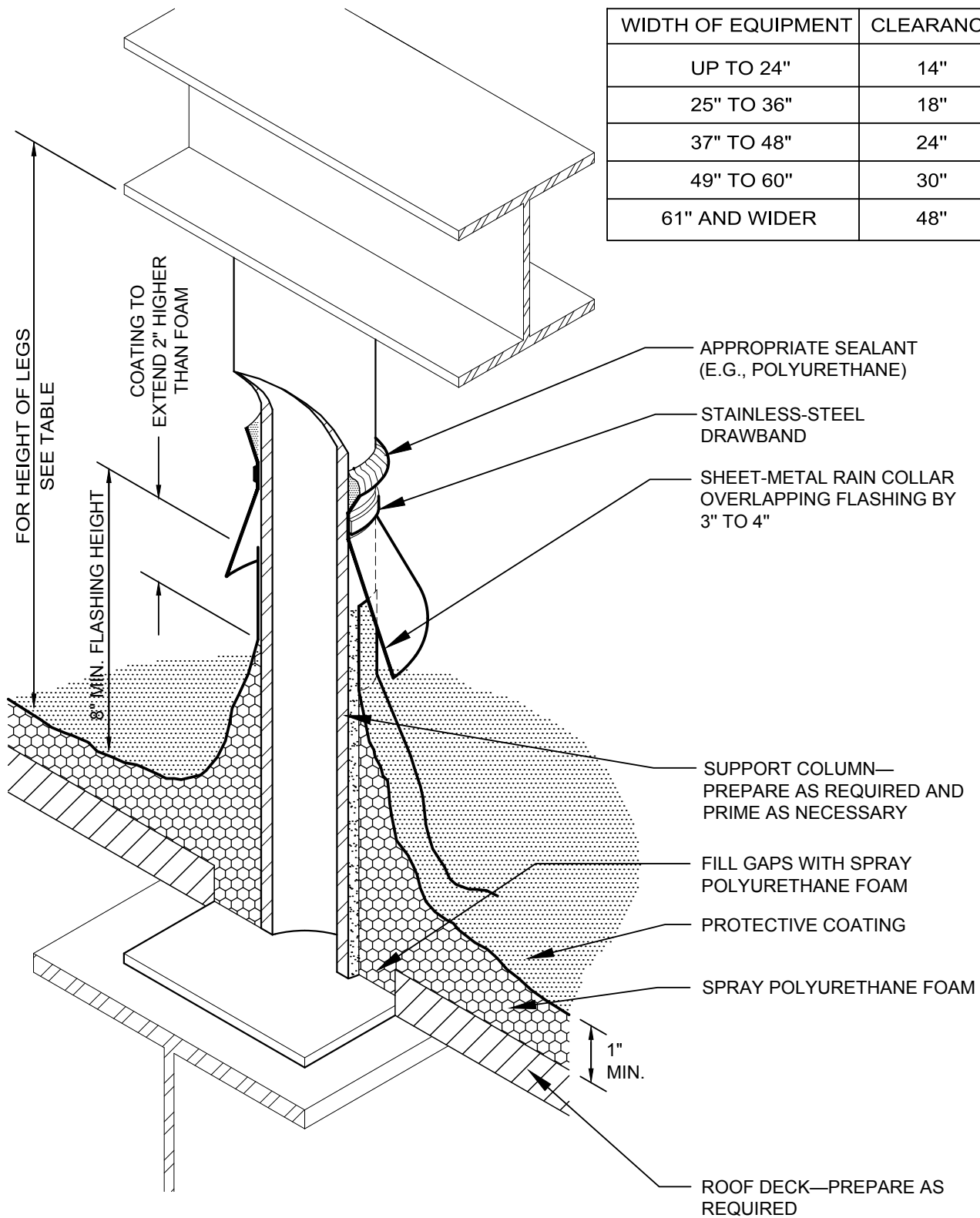

NOTES:

1. REFER TO THE INTRODUCTION IN CHAPTER 8—CONSTRUCTION DETAILS FOR ADDITIONAL INFORMATION.



EQUIPMENT SUPPORT STAND LEG

2012

NOT DRAWN TO SCALE

SPF-8

WIDTH OF EQUIPMENT	CLEARANCE
UP TO 24"	14"
25" TO 36"	18"
37" TO 48"	24"
49" TO 60"	30"
61" AND WIDER	48"

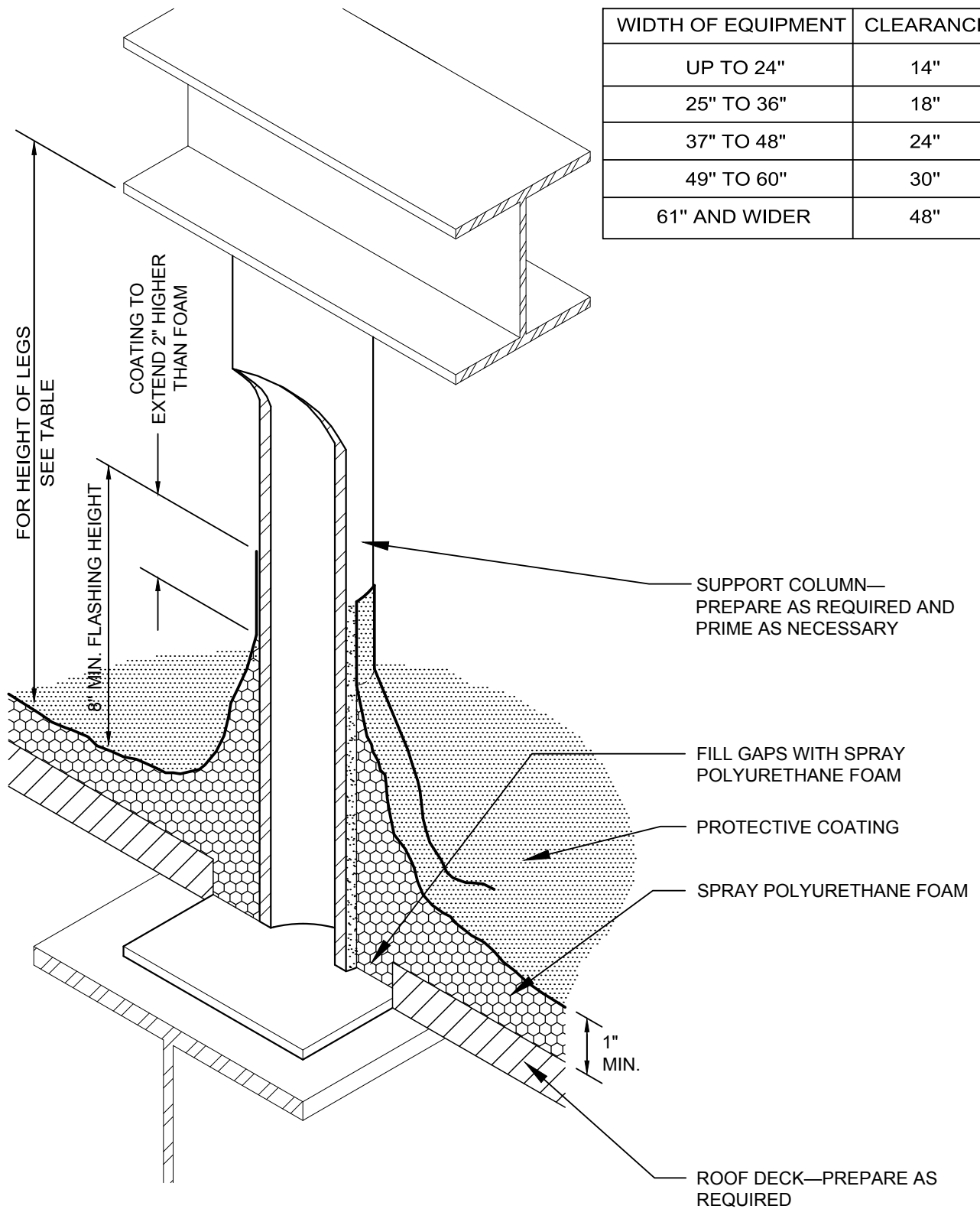

NOTES:

1. REFER TO THE INTRODUCTION IN CHAPTER 8—CONSTRUCTION DETAILS FOR ADDITIONAL INFORMATION.

	<p>EQUIPMENT SUPPORT STAND LEG</p>	<p>2012</p>	<p>NOT DRAWN TO SCALE</p>	<p>SPF-8A</p>
--	---	-------------	---------------------------	----------------------

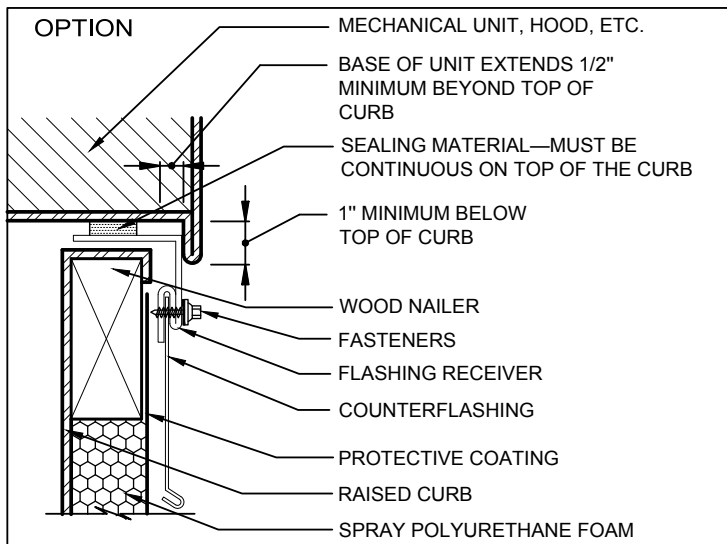
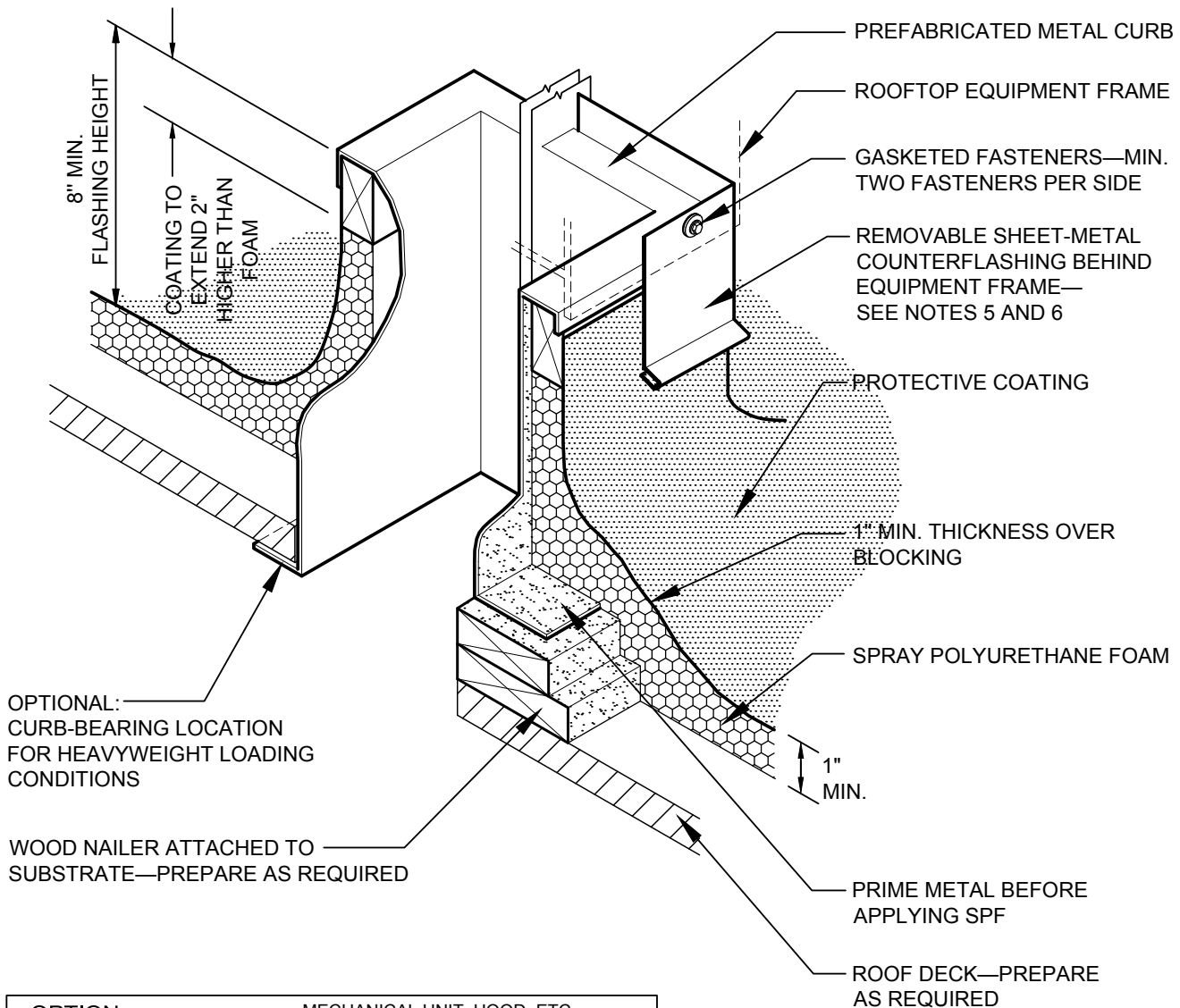

NOTES:

1. THE CURBS, TOP WOOD NAILER AND SEAL STRIP ARE TO BE SUPPLIED BY THE CURB MANUFACTURER.
2. WHEN POSSIBLE, THE MECHANICAL UNITS SHOULD NOT BE SET UNTIL THE SPF ROOF SYSTEM HAS BEEN INSTALLED.
3. WHERE THE SKYLIGHT, SCUTTLE OR SMOKE-VENT FRAMES OVERLAP THE BASE FLASHING AT LEAST 3 INCHES, THE REMOVABLE SHEET-METAL COUNTERFLASHING IS NOT REQUIRED.
4. NRCA RECOMMENDS DESIGNERS CONSIDER PERMANENT INTERNAL OR EXTERNAL FALL-PROTECTION DEVICES AT ALL SKYLIGHTS.
5. REFER TO THE ARCHITECTURAL METAL FLASHING SECTION OF THE NRCA ROOFING MANUAL: ARCHITECTURAL METAL FLASHING, CONDENSATION CONTROL AND REROOFING FOR DESIGN, JOINERY AND SECUREMENT OPTIONS FOR COUNTERFLASHINGS.
6. REFER TO THE INTRODUCTION IN CHAPTER 8—CONSTRUCTION DETAILS FOR ADDITIONAL INFORMATION.



BASE FLASHING AT PREFABRICATED METAL CURB

2012

NOT DRAWN TO SCALE

SPF-9

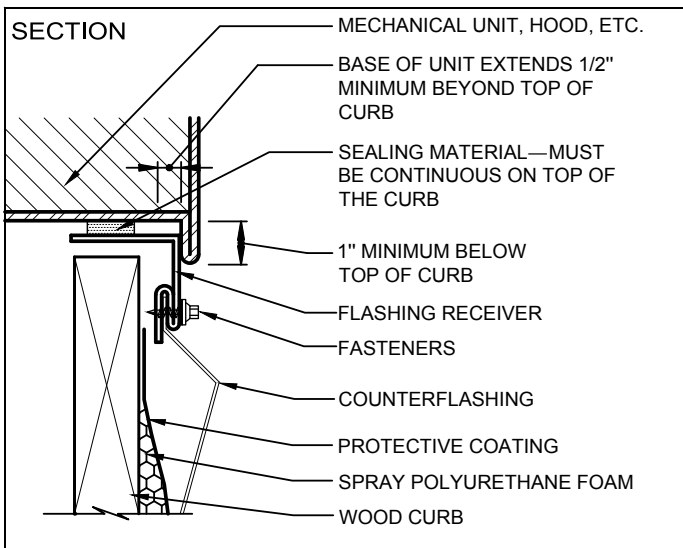
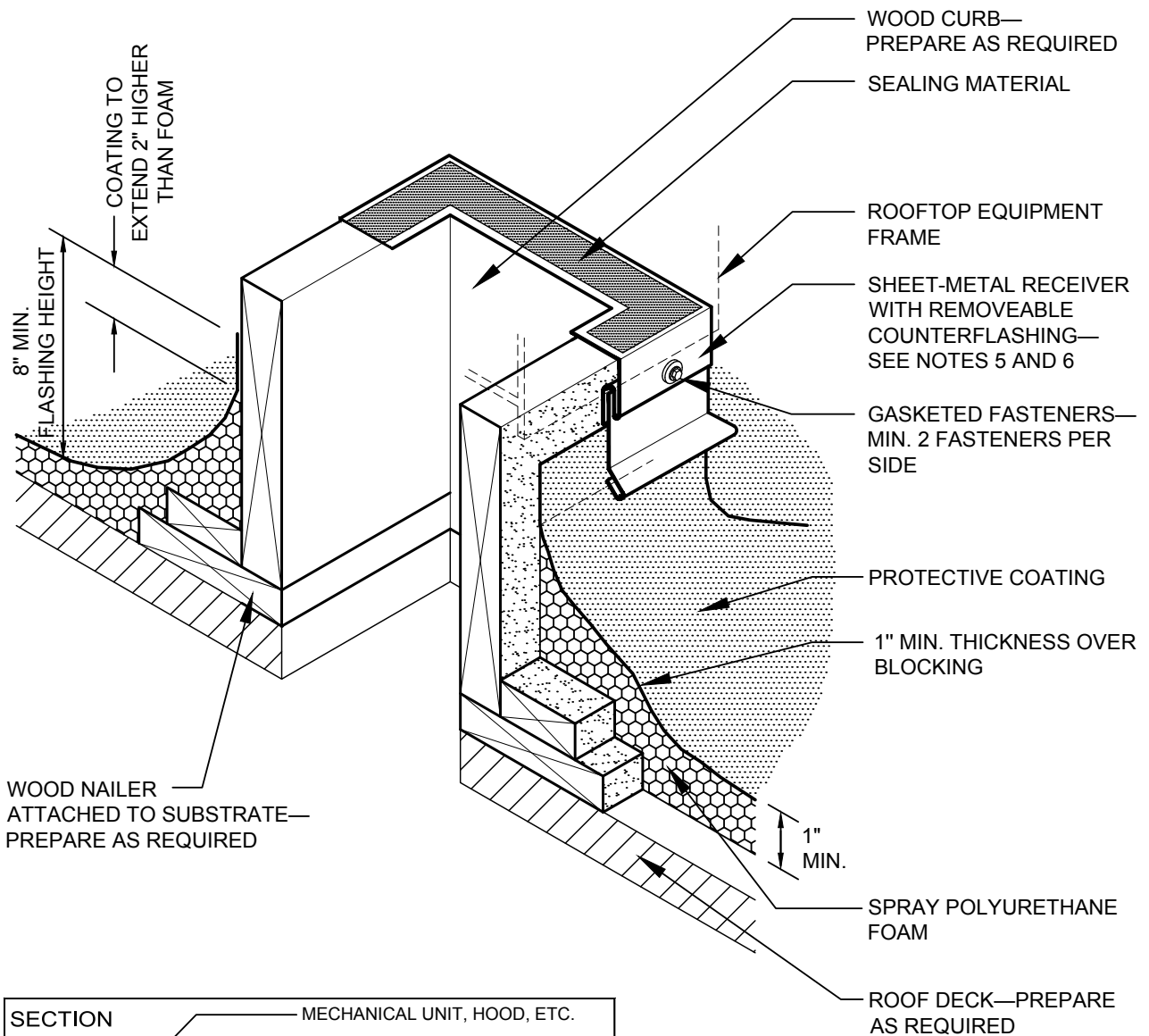

NOTES:

1. THE CURBS, TOP WOOD NAILER AND SEAL STRIP ARE TO BE SUPPLIED BY THE CURB MANUFACTURER.
2. WHEN POSSIBLE, THE MECHANICAL UNITS SHOULD NOT BE SET UNTIL THE SPF ROOF SYSTEM HAS BEEN INSTALLED.
3. WHERE THE SKYLIGHT, SCUTTLE OR SMOKE-VENT FRAMES OVERLAP THE BASE FLASHING AT LEAST 3 INCHES, THE REMOVABLE SHEET-METAL COUNTERFLASHING IS NOT REQUIRED.
4. NRCA RECOMMENDS DESIGNERS CONSIDER PERMANENT INTERNAL OR EXTERNAL FALL-PROTECTION DEVICES AT ALL SKYLIGHTS.
5. REFER TO THE ARCHITECTURAL METAL FLASHING SECTION OF THE NRCA ROOFING MANUAL: ARCHITECTURAL METAL FLASHING, CONDENSATION CONTROL AND REROOFING FOR DESIGN, JOINERY AND SECUREMENT OPTIONS FOR COUNTERFLASHINGS.
6. REFER TO THE INTRODUCTION IN CHAPTER 8—CONSTRUCTION DETAILS FOR ADDITIONAL INFORMATION.



BASE FLASHING AT WOOD CURB

2012

NOT DRAWN TO SCALE

SPF-10

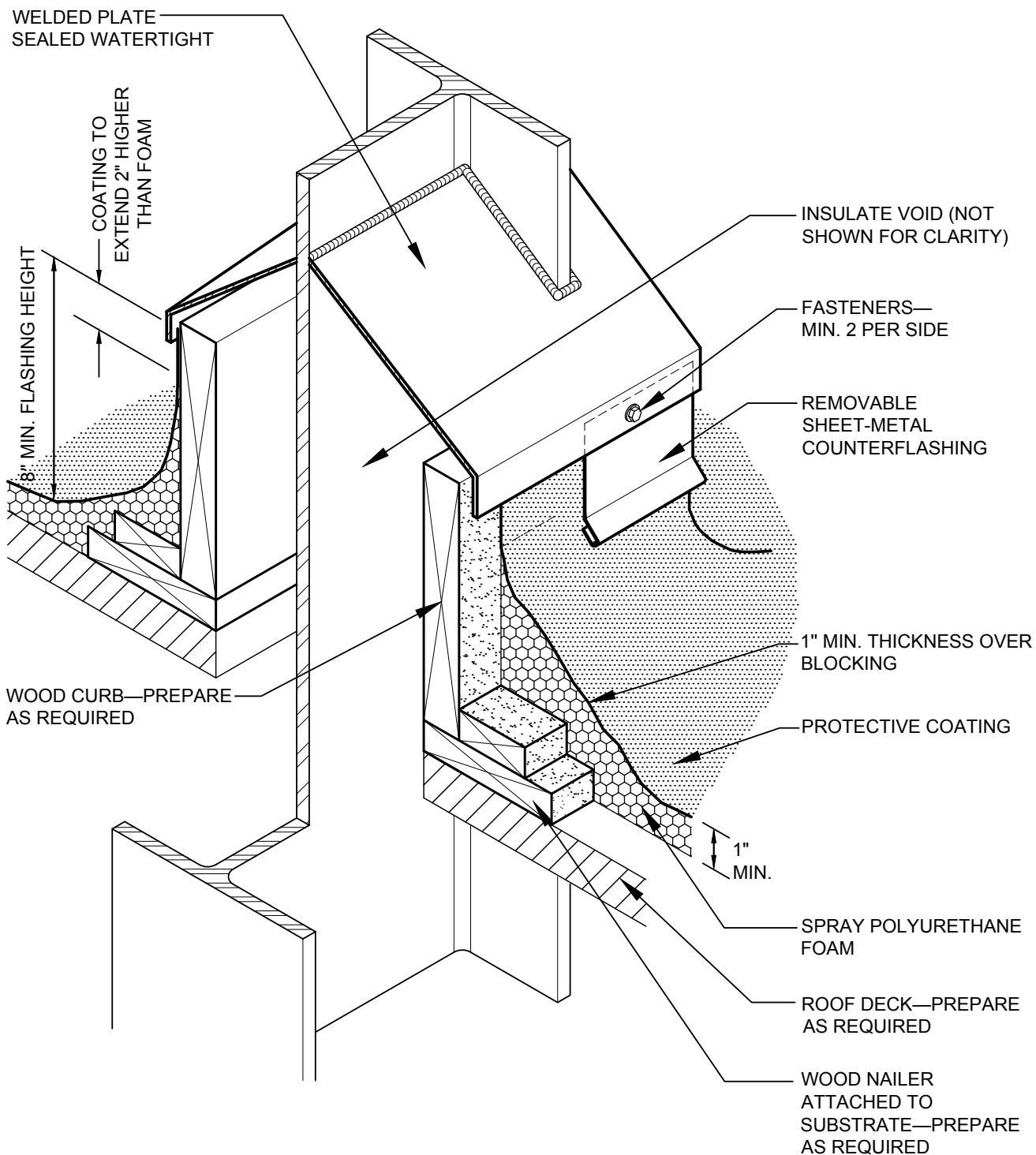

NOTES:

1. THIS DETAIL ILLUSTRATES ONE METHOD OF ELIMINATING PITCH POCKETS. THE CURB CONSTRUCTION ALLOWS FOR MOVEMENT IN THE STRUCTURAL MEMBER WITHOUT DISTURBING THE ROOF SYSTEM.
2. PENETRATIONS USING H, I AND C BEAMS/CHANNELS SHOULD BE AVOIDED. SQUARE OR ROUND TUBES ARE PREFERRED.
3. REFER TO THE ARCHITECTURAL METAL FLASHING SECTION OF THE NRCA ROOFING MANUAL: ARCHITECTURAL METAL FLASHING, CONDENSATION CONTROL AND REROOFING FOR DESIGN, JOINERY AND SECUREMENT OPTIONS FOR COPINGS.
4. REFER TO THE INTRODUCTION IN CHAPTER 8—CONSTRUCTION DETAILS FOR ADDITIONAL INFORMATION.



BASE FLASHING AT STRUCTURAL MEMBER THROUGH ROOF DECK

2012

NOT DRAWN TO SCALE

SPF-11

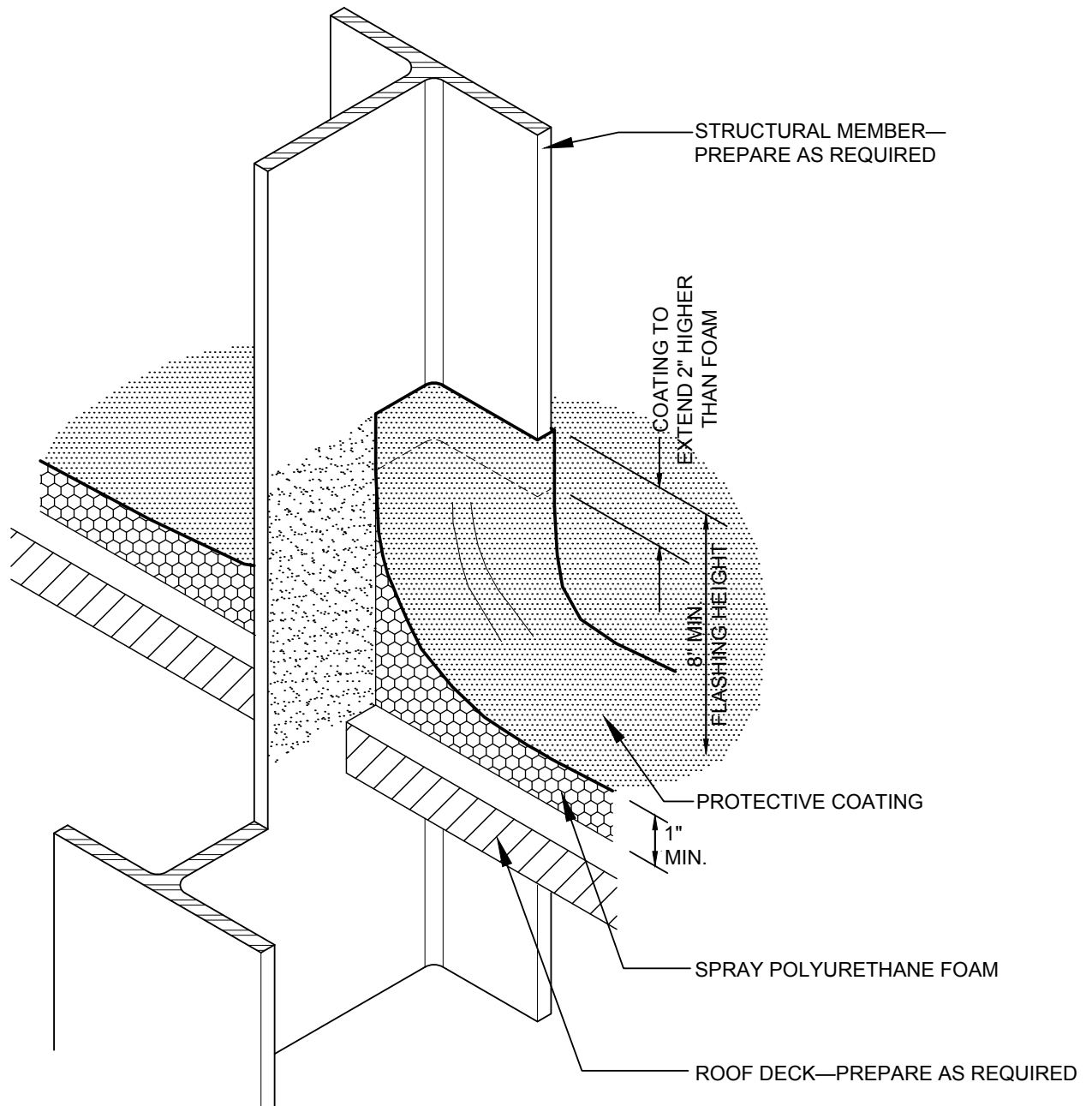

NOTES:

1. THIS DETAIL ILLUSTRATES ONE METHOD OF ELIMINATING PITCH POCKETS. THE DECK AND STRUCTURAL MEMBER MUST MOVE IN CONJUNCTION WITH EACH OTHER.
2. REFER TO THE INTRODUCTION IN CHAPTER 8—CONSTRUCTION DETAILS FOR ADDITIONAL INFORMATION.



BASE FLASHING AT STRUCTURAL MEMBER THROUGH ROOF DECK

2012

NOT DRAWN TO SCALE

SPF-11A

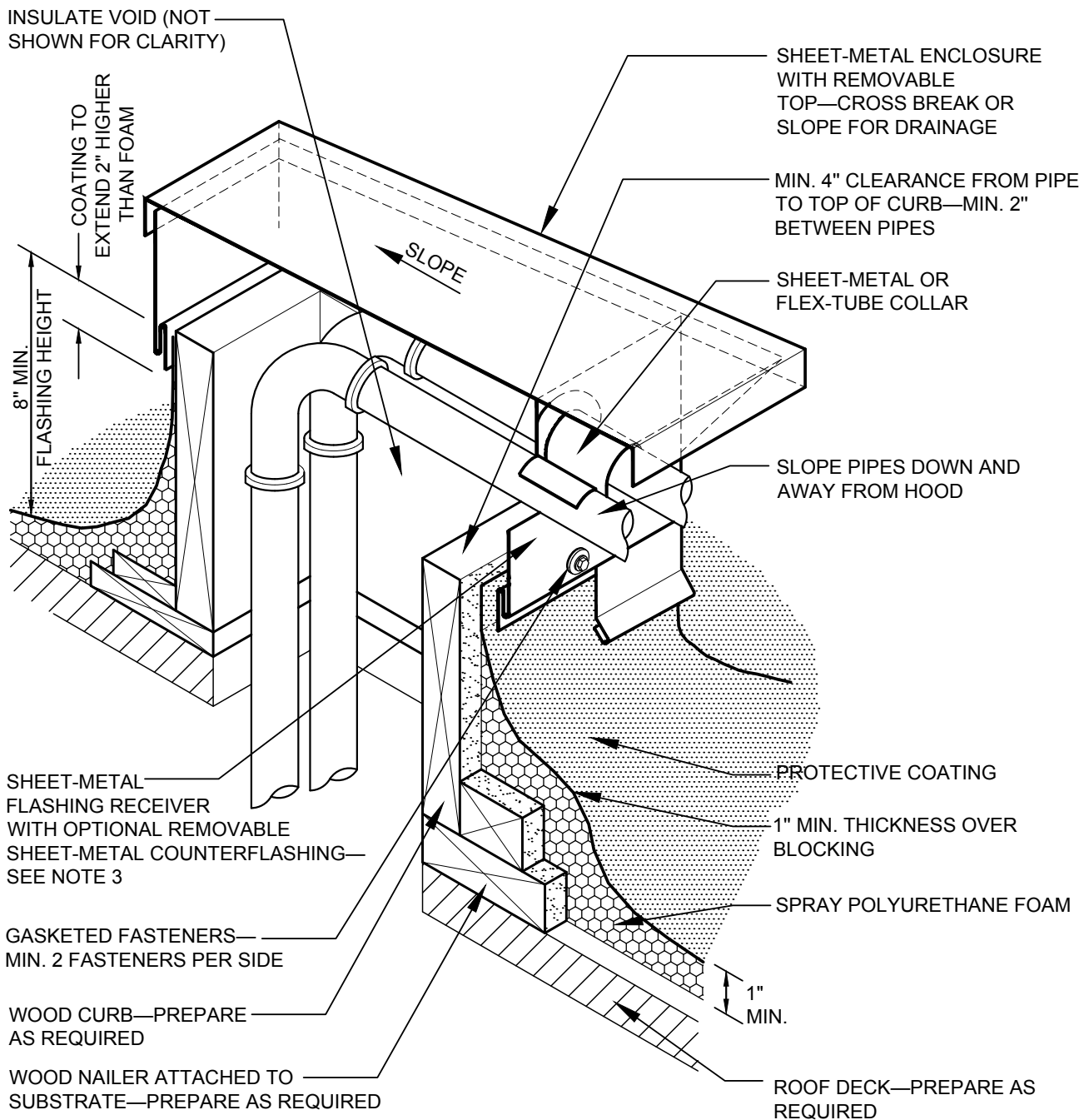

NOTES:

1. THIS DETAIL ILLUSTRATES ANOTHER METHOD OF ELIMINATING PITCH POCKETS AND GROUPING PIPING THAT MUST COME ABOVE THE ROOF SURFACE.
2. MANY MANUFACTURERS OFFER PREFABRICATED BOOTS AND OTHER MATERIALS FOR THIS PURPOSE. SPECIFICS ABOUT THESE PROPRIETARY DESIGNS VARY GREATLY, AND MANUFACTURERS' SPECIFICATIONS SHOULD BE CONSULTED FOR THEIR USE.
3. WHERE THE SHEET-METAL ENCLOSURE OVERLAPS THE BASE FLASHING AT LEAST 3 INCHES, THE REMOVABLE SHEET-METAL COUNTERFLASHING IS NOT REQUIRED.
4. REFER TO THE ARCHITECTURAL METAL FLASHING SECTION OF THE NRCA ROOFING MANUAL: ARCHITECTURAL METAL FLASHING, CONDENSATION CONTROL AND REROOFING FOR DESIGN, JOINERY AND SECUREMENT OPTIONS FOR COPINGS.
5. REFER TO THE INTRODUCTION IN CHAPTER 8—CONSTRUCTION DETAILS FOR ADDITIONAL INFORMATION.



BASE FLASHING AT SHEET-METAL ENCLOSURE FOR PIPING THROUGH ROOF DECK

2012

NOT DRAWN TO SCALE

SPF-12

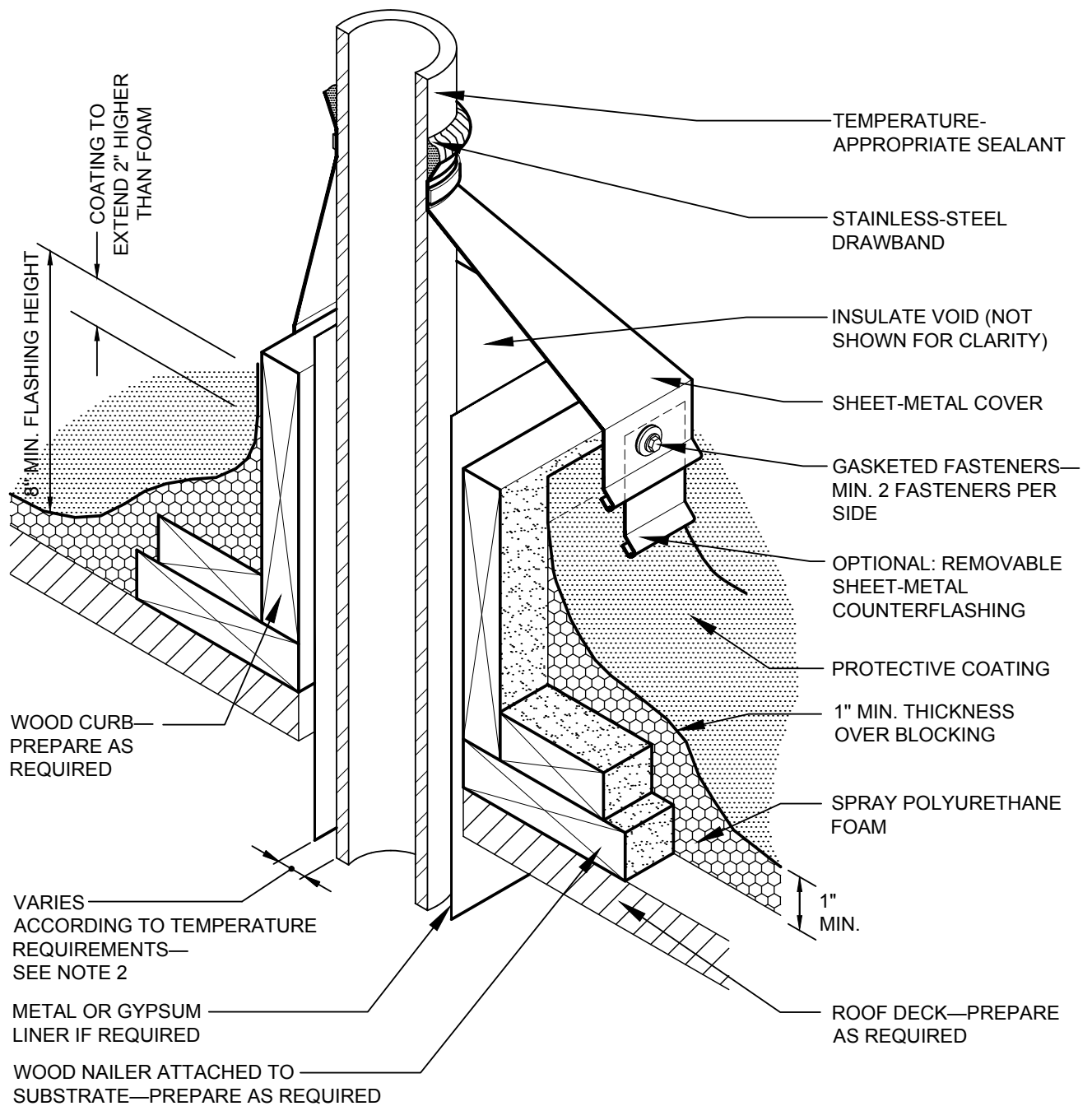

NOTES:

1. THIS DETAIL ALLOWS THE OPENING TO BE COMPLETED BEFORE THE STACK IS PLACED.
2. THE METAL LINER TYPE, THE CLEARANCE NECESSARY BETWEEN THE LINER AND STACK, AND THE NEED FOR INSULATION WILL DEPEND ON THE TEMPERATURE OF THE MATERIAL HANDLED BY THE STACK. VERIFY SUBSTRATE TEMPERATURE RANGE WITH SPF MANUFACTURER.
3. IF COVER EXTENDS OVER THE BASE FLASHING AT LEAST 3 INCHES, THE REMOVABLE SHEET-METAL COUNTERFLASHING IS NOT REQUIRED.
4. REFER TO THE ARCHITECTURAL METAL FLASHING SECTION OF THE NRCA ROOFING MANUAL: ARCHITECTURAL METAL FLASHING, CONDENSATION CONTROL AND REROOFING FOR DESIGN, JOINERY AND SECUREMENT OPTIONS FOR COPINGS.
5. REFER TO THE INTRODUCTION IN CHAPTER 8—CONSTRUCTION DETAILS FOR ADDITIONAL INFORMATION.



BASE FLASHING AT ISOLATED STACK FLASHING

2012

NOT DRAWN TO SCALE

SPF-13

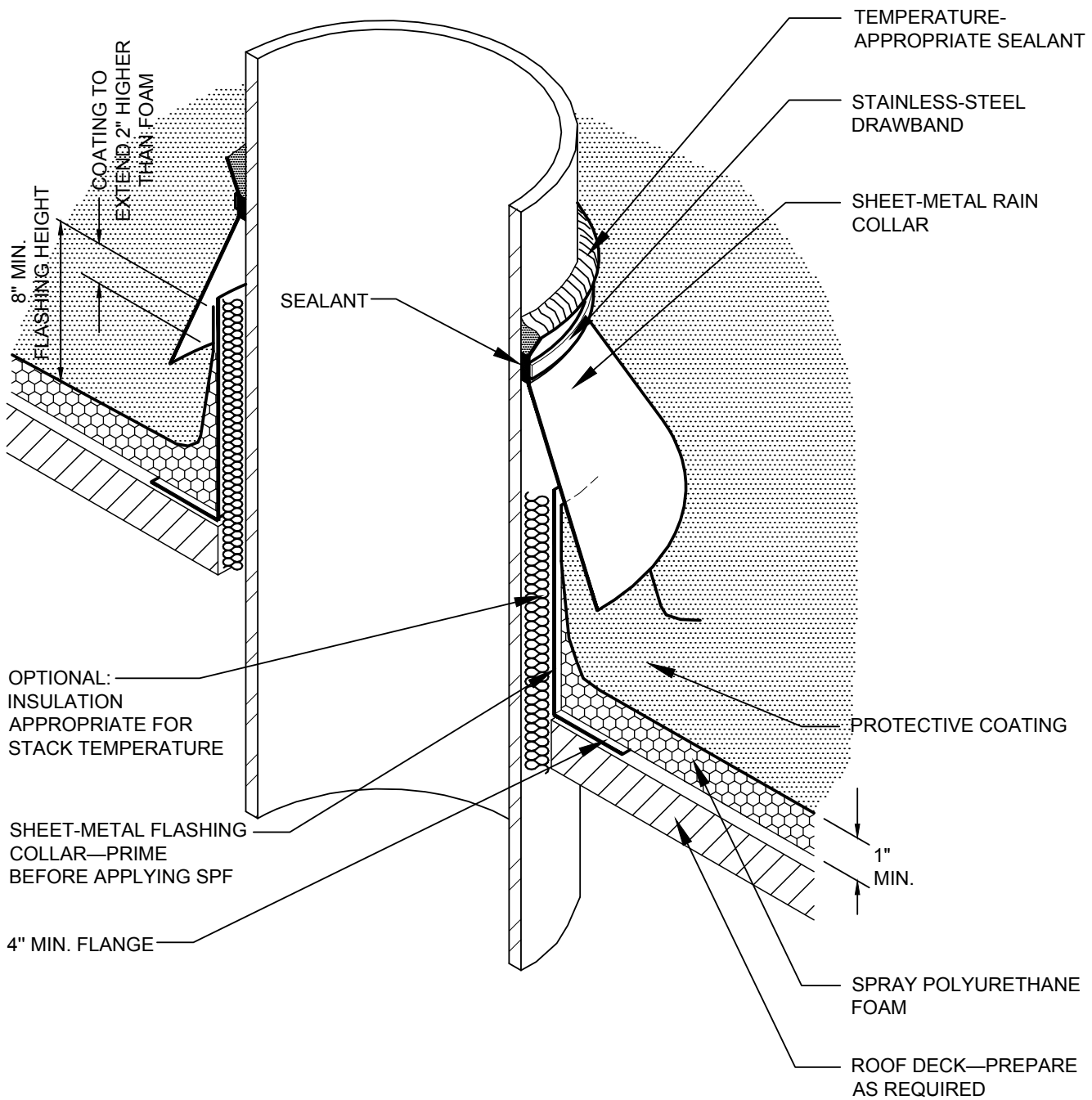

NOTES:

1. THIS DETAIL ALLOWS THE OPENING TO BE COMPLETED BEFORE THE STACK IS PLACED.
2. THE METAL LINER TYPE, CLEARANCE NECESSARY BETWEEN THE LINER AND STACK, AND NEED FOR INSULATION WILL DEPEND ON THE TEMPERATURE OF THE MATERIAL HANDLED BY THE STACK.
3. REFER TO THE INTRODUCTION IN CHAPTER 8—CONSTRUCTION DETAILS FOR ADDITIONAL INFORMATION.



SHEET-METAL STACK VENT [HOT OR COLD]

2012

NOT DRAWN TO SCALE

SPF-14

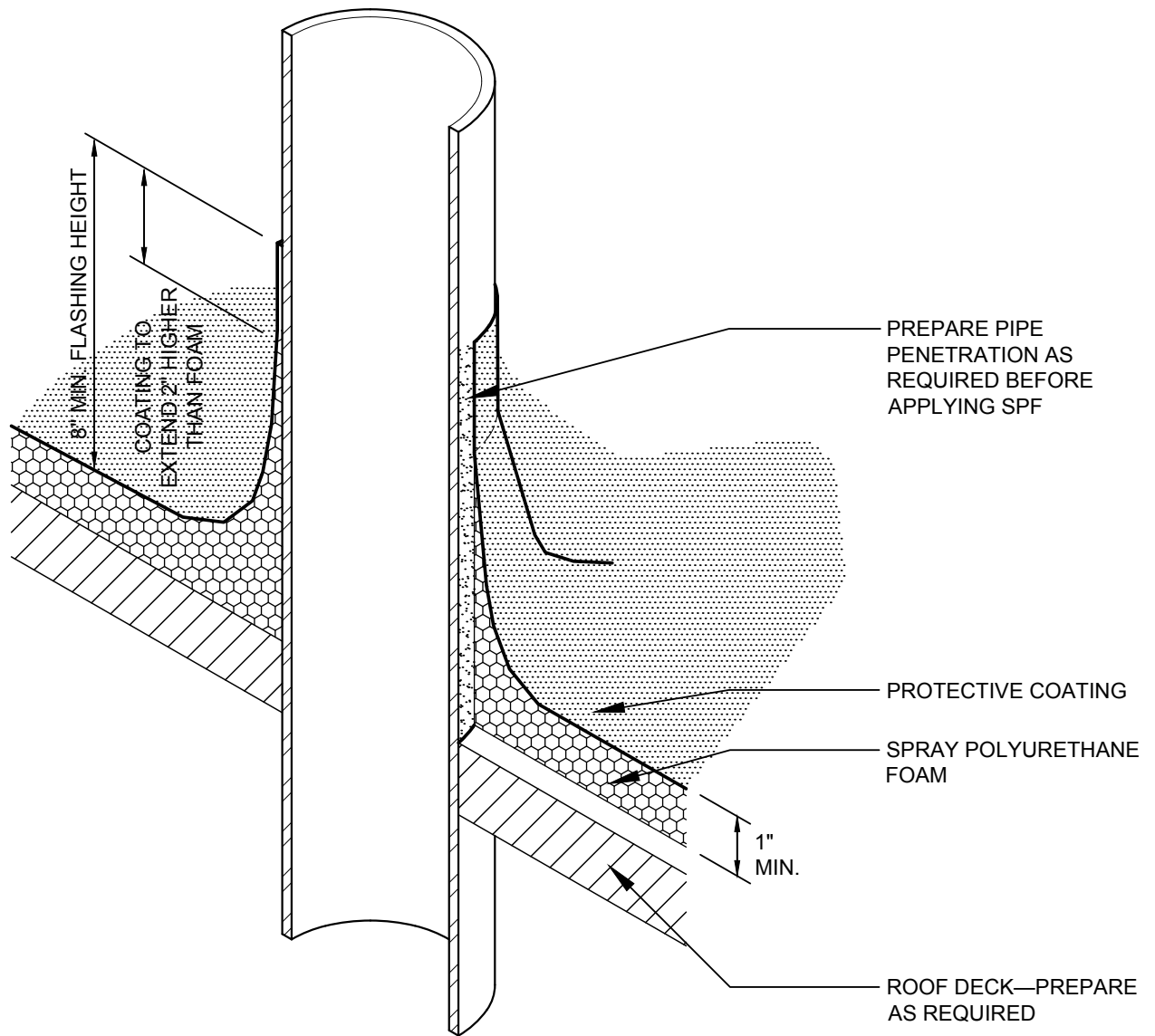

NOTES:

1. VENT STACKS AND OTHER PIPES SHOULD HAVE A MINIMUM 12 INCHES OF CLEARANCE ON ALL SIDES FROM WALLS, CURBS AND OTHER PROJECTIONS TO FACILITATE PROPER FLASHING.
2. REFER TO THE INTRODUCTION IN CHAPTER 8—CONSTRUCTION DETAILS FOR ADDITIONAL INFORMATION.



PIPE PENETRATION

2012

NOT DRAWN TO SCALE

SPF-15

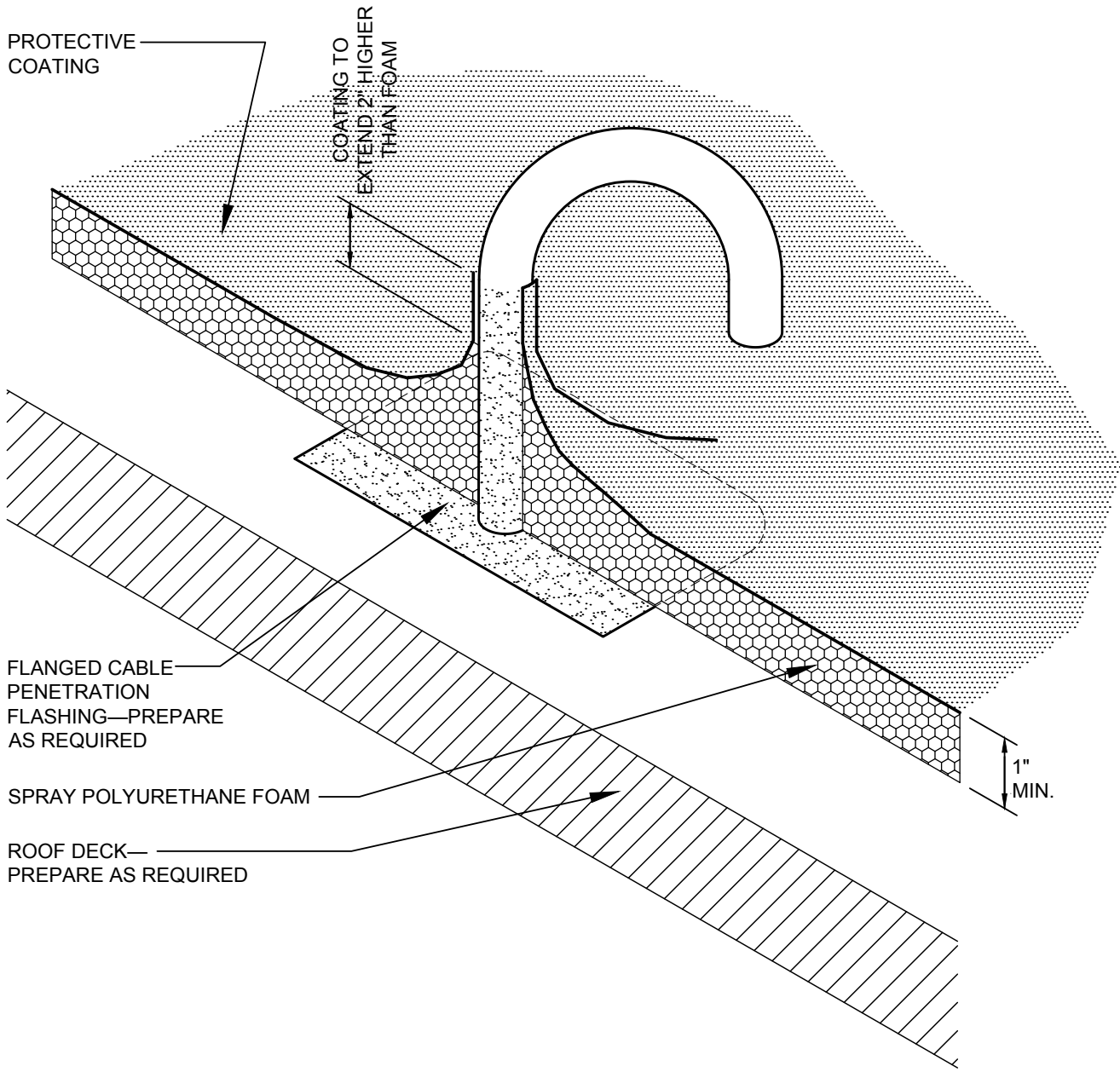

NOTES:

1. DETAIL DEPICTS THE WEATHERPROOFING PROTECTION AND DOES NOT REPRESENT LIGHTNING PROTECTION DESIGN.
2. REFER TO THE INTRODUCTION IN CHAPTER 8—CONSTRUCTION DETAILS FOR ADDITIONAL INFORMATION.

	<h2 style="margin: 0;">CABLE PENETRATION</h2>		
2012	<i>NOT DRAWN TO SCALE</i>		SPF-16

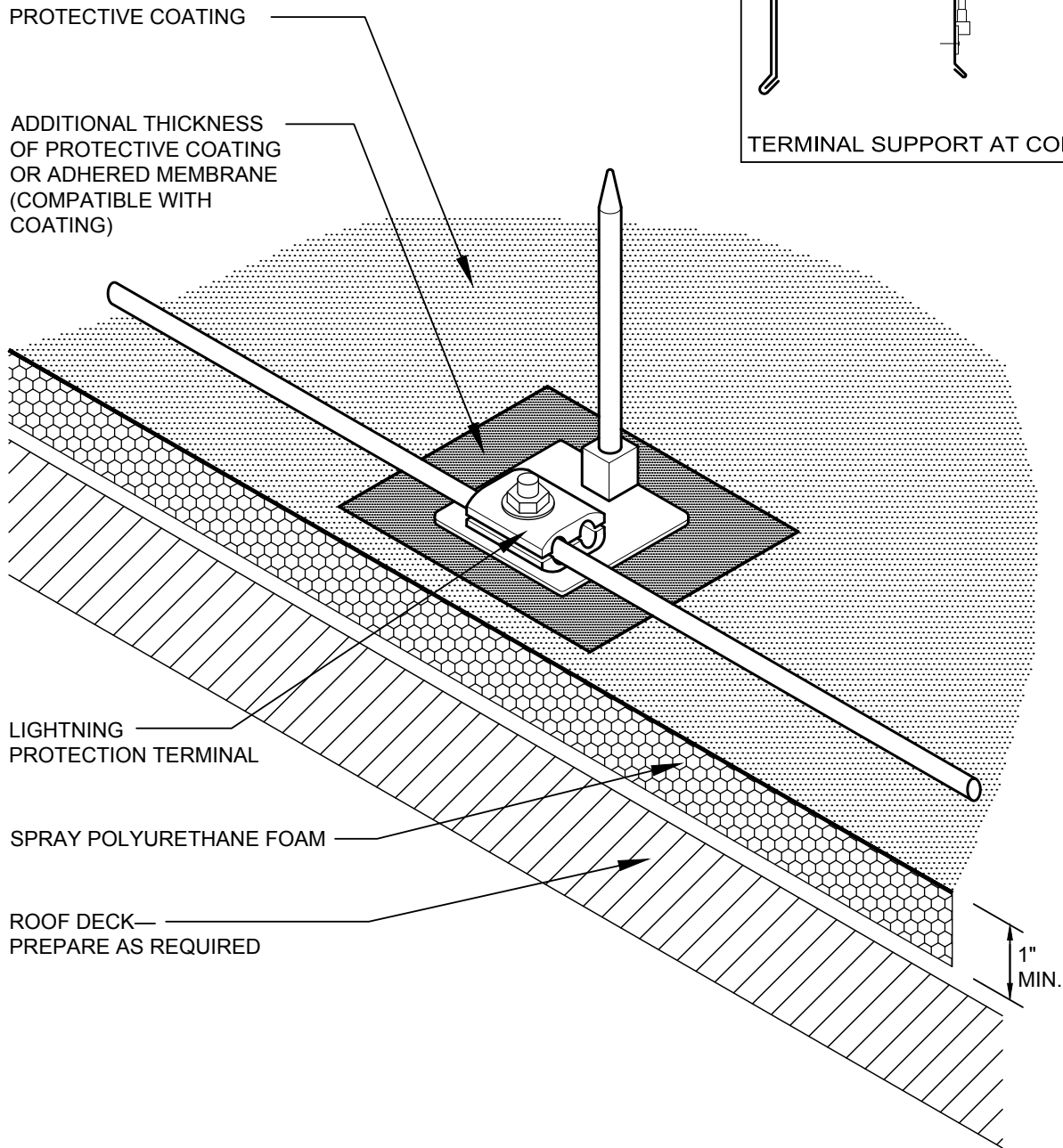

NOTES:

1. DETAIL DEPICTS THE WEATHERPROOFING PROTECTION AND DOES NOT REPRESENT LIGHTNING PROTECTION DESIGN.
2. REFER TO THE INTRODUCTION IN CHAPTER 8—CONSTRUCTION DETAILS FOR ADDITIONAL INFORMATION.



LIGHTNING PROTECTION TERMINAL

2012

NOT DRAWN TO SCALE

SPF-17

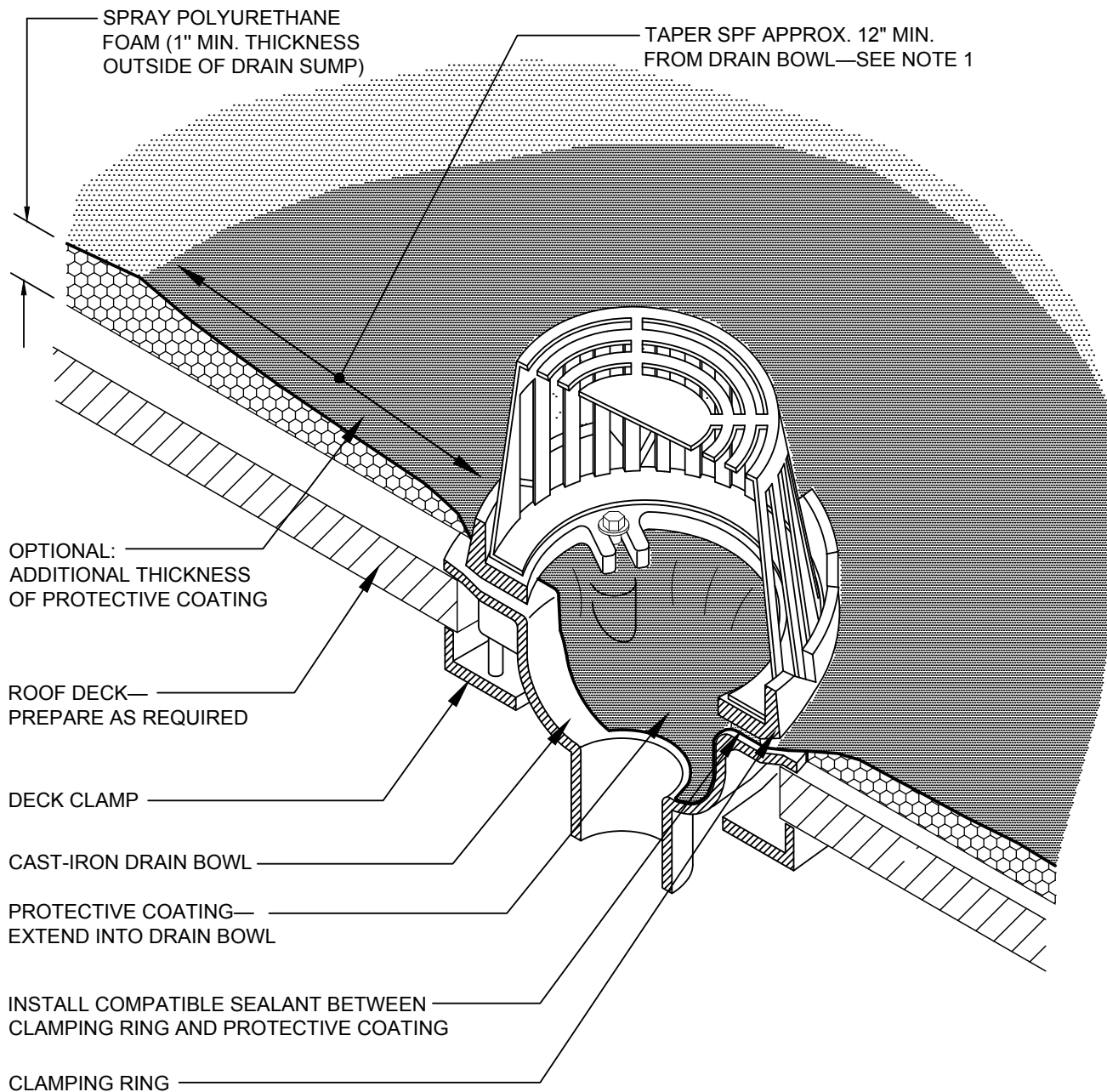

NOTES:

1. TAPER SPF TOWARD DRAIN BOWL TO PROVIDE POSITIVE DRAINAGE.
2. THE USE OF A METAL DECK SUMP PAN IS NOT RECOMMENDED. HOWEVER, DRAIN RECEIVER/BEARING PLATES ARE APPLICABLE WITH SOME PROJECTS.
3. WHERE THE SPF IS TRIMMED OR GROUND FLUSH, ADDITIONAL COATING THICKNESS IS REQUIRED.
4. THE SPF AND COATING SHOULD NOT REDUCE THE DIAMETER OF THE DRAIN PIPE.
5. REFER TO THE INTRODUCTION IN CHAPTER 8—CONSTRUCTION DETAILS FOR ADDITIONAL INFORMATION.



ROOF DRAIN

2011

NOT DRAWN TO SCALE

SPF-18

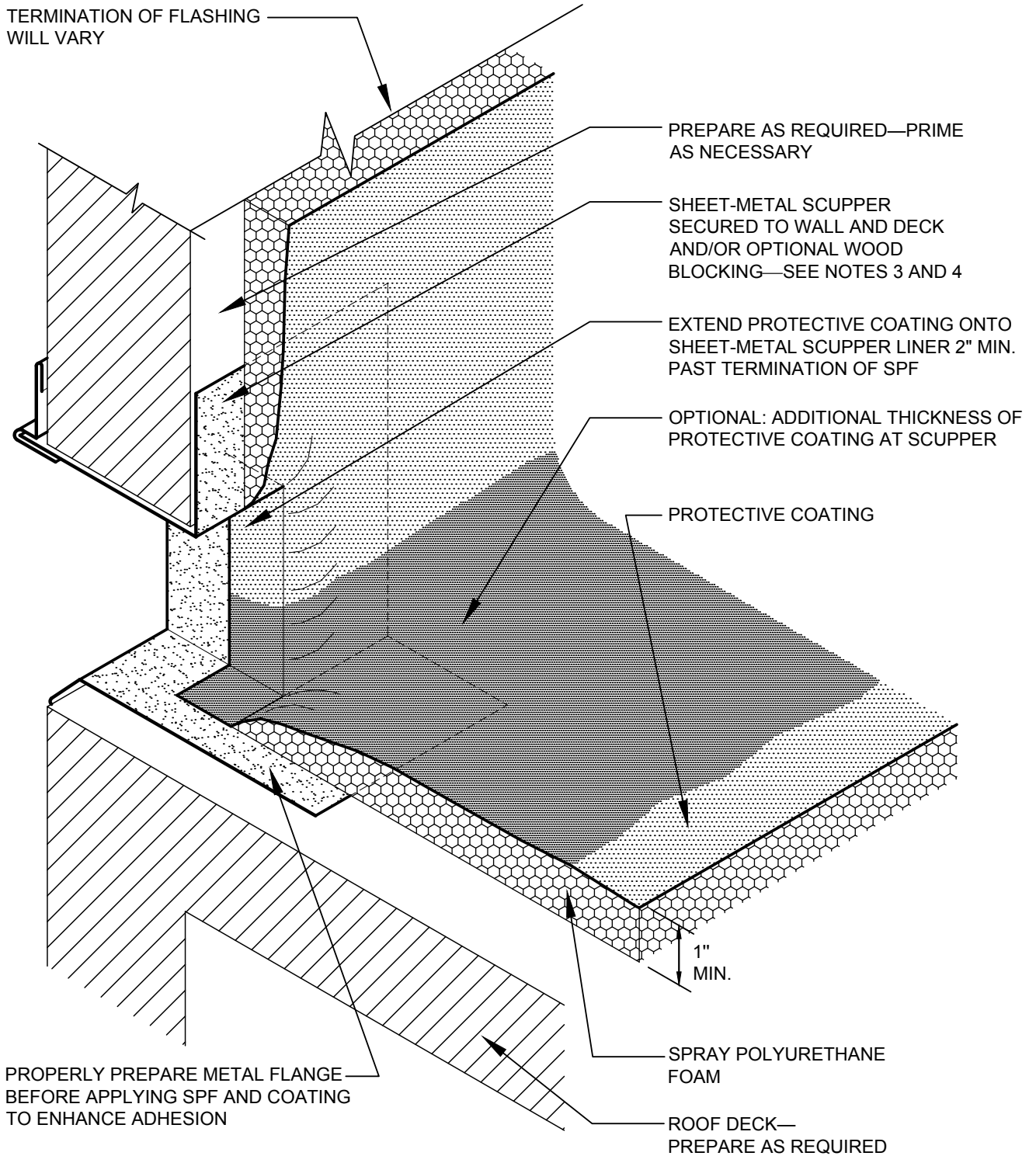

NOTES:

1. THIS DETAIL DOES NOT ALLOW FOR DIFFERENTIAL MOVEMENT BETWEEN THE DECK AND WALL.
2. CONDUCTOR HEAD TO BE 1 INCH MINIMUM BELOW BOTTOM OF THROUGH-WALL SCUPPER.
3. REFER TO THE ARCHITECTURAL METAL FLASHING SECTION OF THE NRCA ROOFING MANUAL: ARCHITECTURAL METAL FLASHING, CONDENSATION CONTROL AND REROOFING FOR DESIGN, JOINERY AND SECUREMENT OPTIONS FOR SCUPPERS.
4. REFER TO THE INTRODUCTION IN CHAPTER 8—CONSTRUCTION DETAILS FOR ADDITIONAL INFORMATION.



THROUGH-WALL SCUPPER

2012

NOT DRAWN TO SCALE

SPF-19

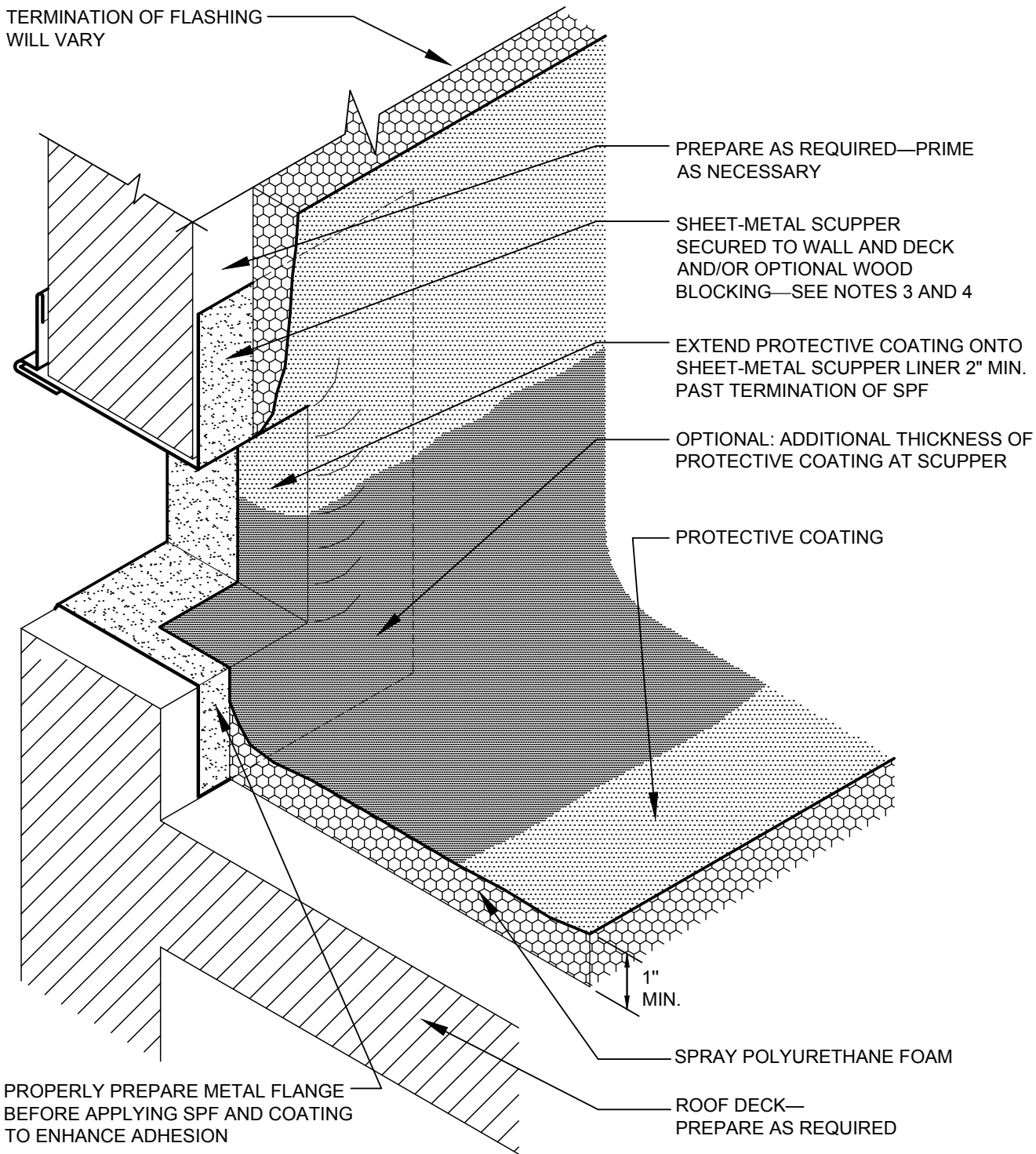

NOTES:

1. THIS DETAIL DOES NOT ALLOW FOR DIFFERENTIAL MOVEMENT BETWEEN THE DECK AND WALL.
2. ELEVATION OF SCUPPER MAY VARY.
3. REFER TO THE ARCHITECTURAL METAL FLASHING SECTION OF THE NRCA ROOFING MANUAL: ARCHITECTURAL METAL FLASHING, CONDENSATION CONTROL AND REROOFING FOR DESIGN, JOINERY AND SECUREMENT OPTIONS FOR SCUPPERS.
4. REFER TO THE INTRODUCTION IN CHAPTER 8—CONSTRUCTION DETAILS FOR ADDITIONAL INFORMATION.



OVERFLOW SCUPPER

2012

NOT DRAWN TO SCALE

SPF-20

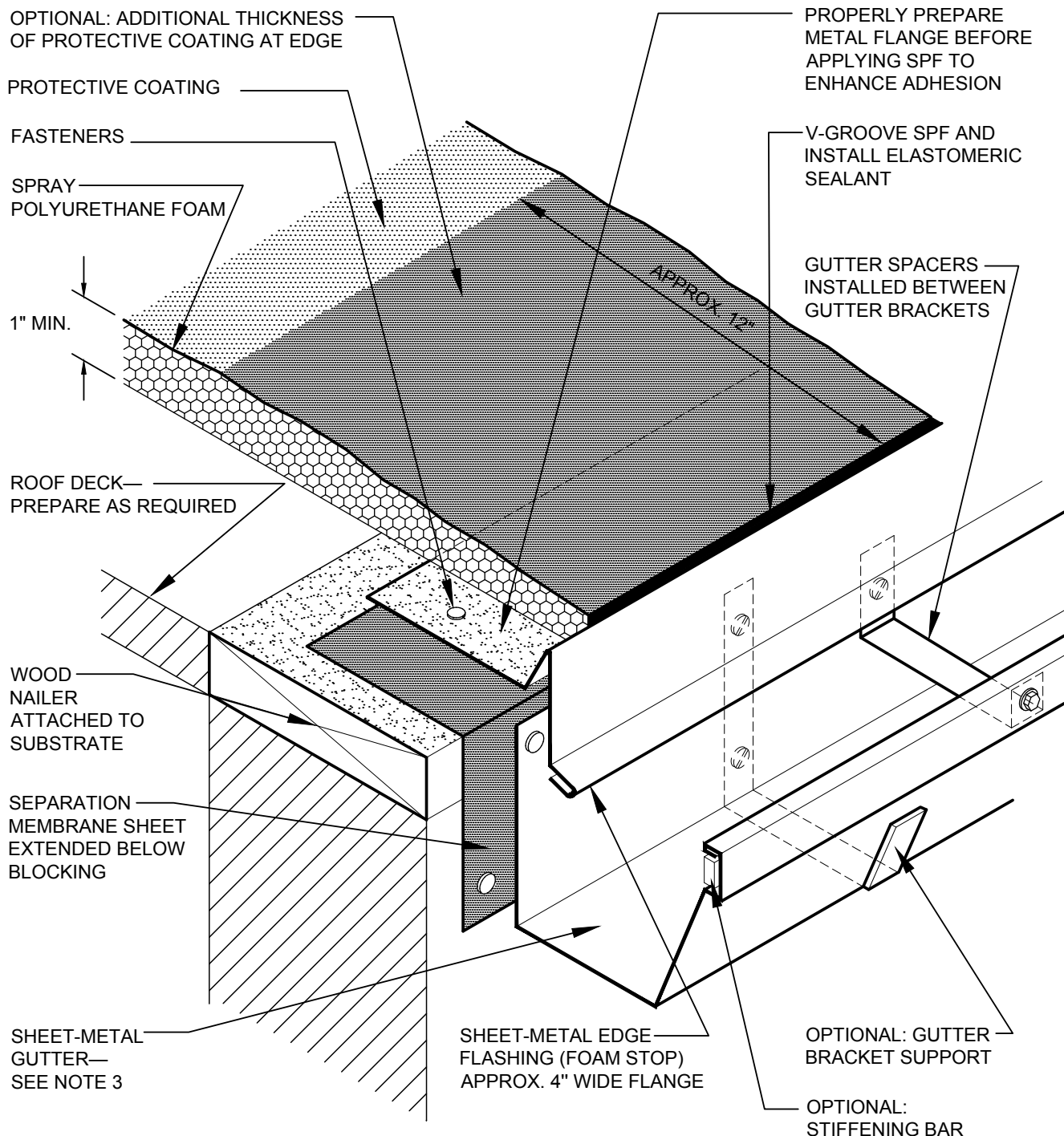

NOTES:

1. IN CLIMATES WHERE THE WINTER TEMPERATURE REMAINS BELOW FREEZING FOR EXTENDED PERIODS OF TIME, NRCA SUGGESTS USING INTERIOR DRAINS TO DRAIN THE ROOF.
2. REFER TO THE ARCHITECTURAL METAL FLASHING SECTION OF THE NRCA ROOFING MANUAL: ARCHITECTURAL METAL FLASHING, CONDENSATION CONTROL AND REROOFING FOR MORE INFORMATION ON GUTTERS.
3. REFER TO THE INTRODUCTION IN CHAPTER 8—CONSTRUCTION DETAILS FOR ADDITIONAL INFORMATION.

	<h2 style="margin: 0;">GUTTER WITH PERIMETER EDGE METAL</h2>
<p>2012</p>	<p>NOT DRAWN TO SCALE</p>
<p>SPF-21</p>	

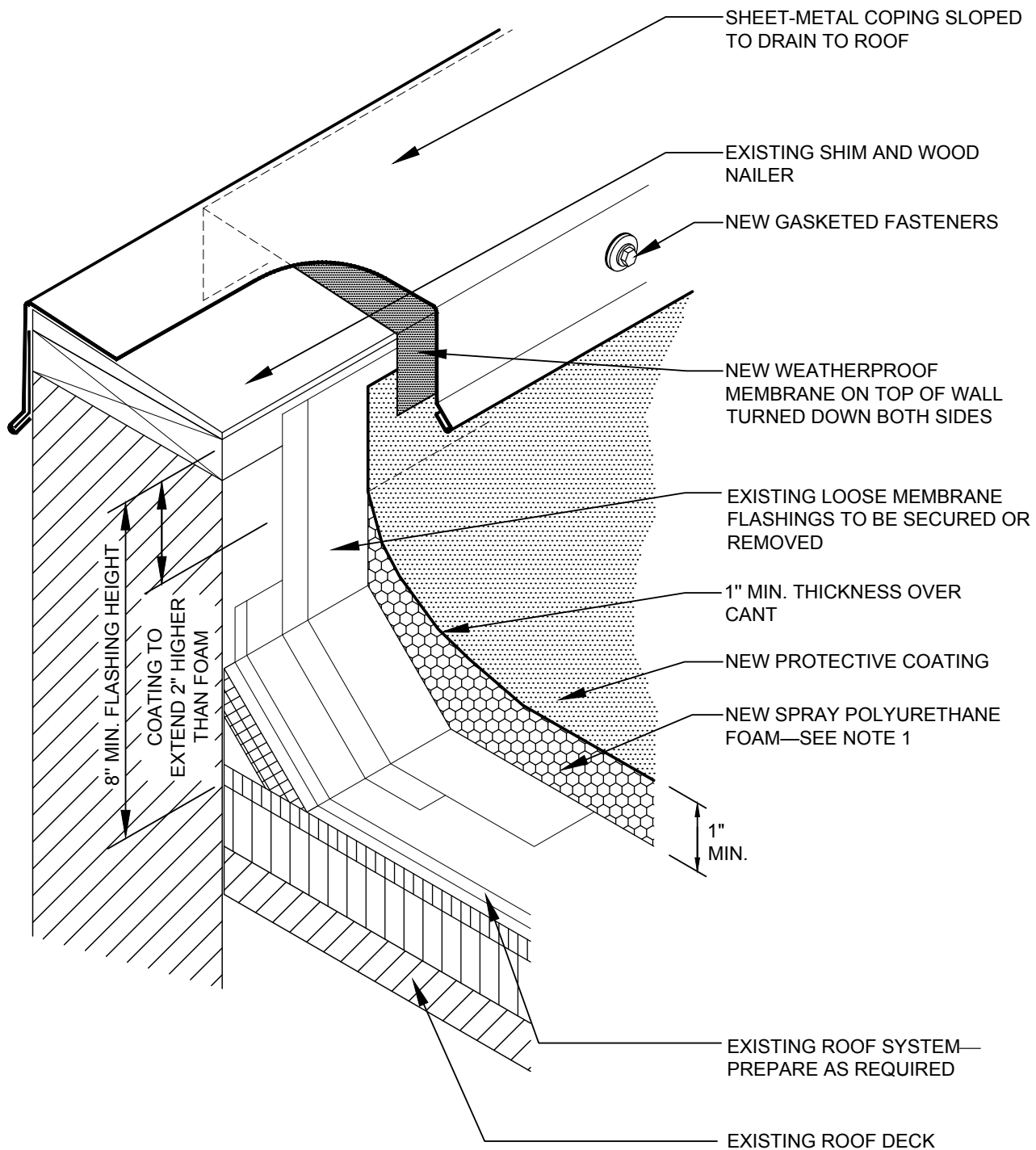

NOTES:

1. FOR PREPARED AGGREGATE-SURFACED MEMBRANES, MINIMUM THICKNESS FOR SPF IS 1 1/2 INCHES. REFER TO CHAPTER 7—ROOF RE-COVERING FOR ADDITIONAL INFORMATION.
2. REFER TO THE ARCHITECTURAL METAL FLASHING SECTION OF THE NRCA ROOFING MANUAL: ARCHITECTURAL METAL FLASHING, CONDENSATION CONTROL AND REROOFING FOR DESIGN, JOINERY AND SECUREMENT OPTIONS FOR COPINGS.
3. REFER TO THE INTRODUCTION IN CHAPTER 8—CONSTRUCTION DETAILS FOR ADDITIONAL INFORMATION.



BASE FLASHING AT PARAPET WALL WITH NEW METAL COPING FOR SPF RE-COVER

2012

NOT DRAWN TO SCALE

SPF(R)-1

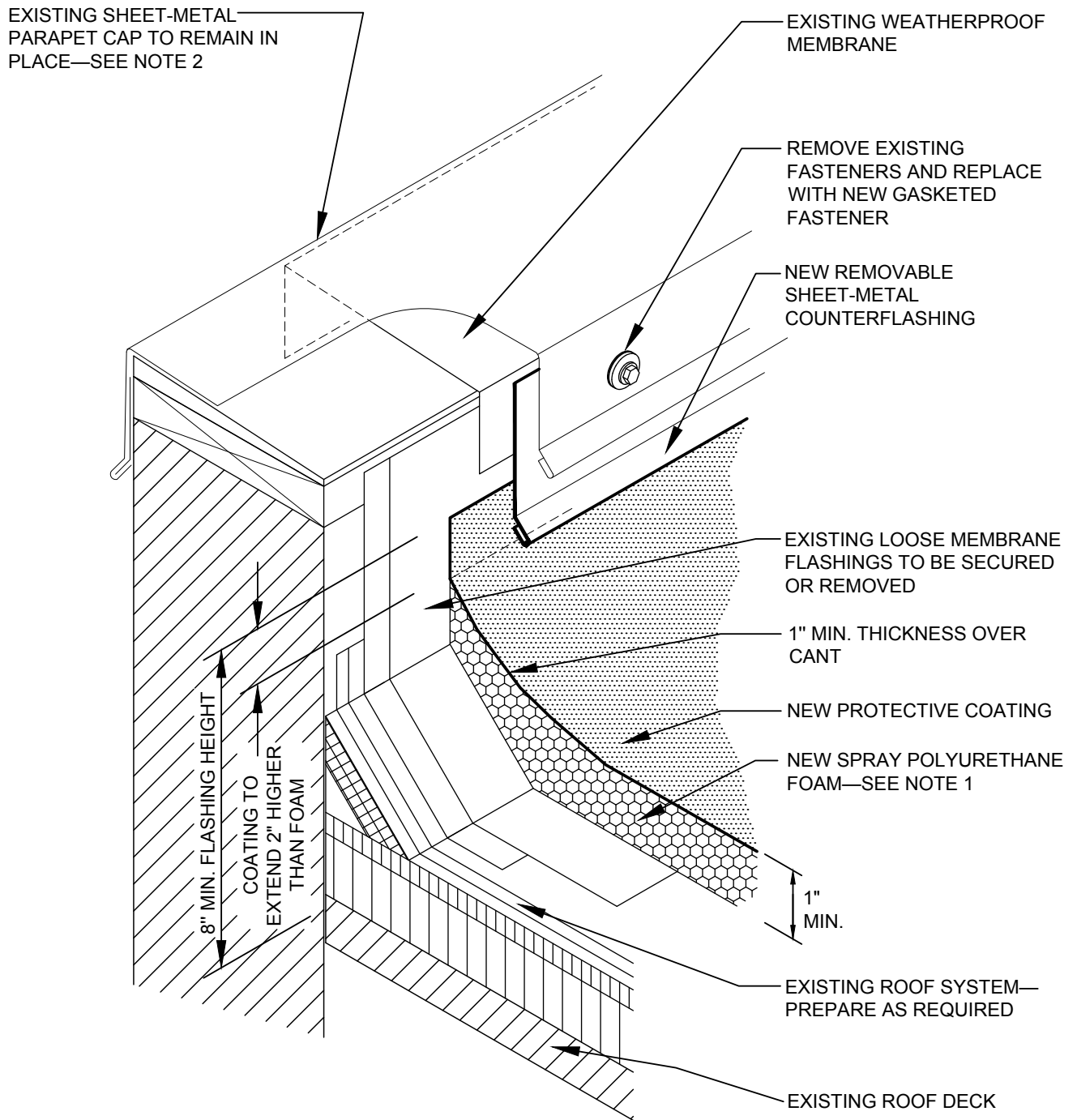

NOTES:

1. FOR PREPARED AGGREGATE-SURFACED MEMBRANES, MINIMUM THICKNESS FOR SPF IS 1 1/2 INCHES. REFER TO CHAPTER 7—ROOF RE-COVERING FOR ADDITIONAL INFORMATION.
2. SHEET-METAL COMPONENTS THAT ARE TO REMAIN IN PLACE SHOULD BE WEATHERPROOF AND HAVE THE EXPECTED SERVICE LIFE EQUAL TO THE NEW ROOF SYSTEM.
3. REFER TO THE ARCHITECTURAL METAL FLASHING SECTION OF THE NRCA ROOFING MANUAL: ARCHITECTURAL METAL FLASHING, CONDENSATION CONTROL AND REROOFING FOR DESIGN, JOINERY AND SECUREMENT OPTIONS FOR COPINGS.
4. REFER TO THE INTRODUCTION IN CHAPTER 8—CONSTRUCTION DETAILS FOR ADDITIONAL INFORMATION.



BASE FLASHING AT PARAPET WALL WITH EXISTING METAL COPING AND NEW COUNTERFLASHING FOR SPF RE-COVER

2012

NOT DRAWN TO SCALE

SPF(R)-1A

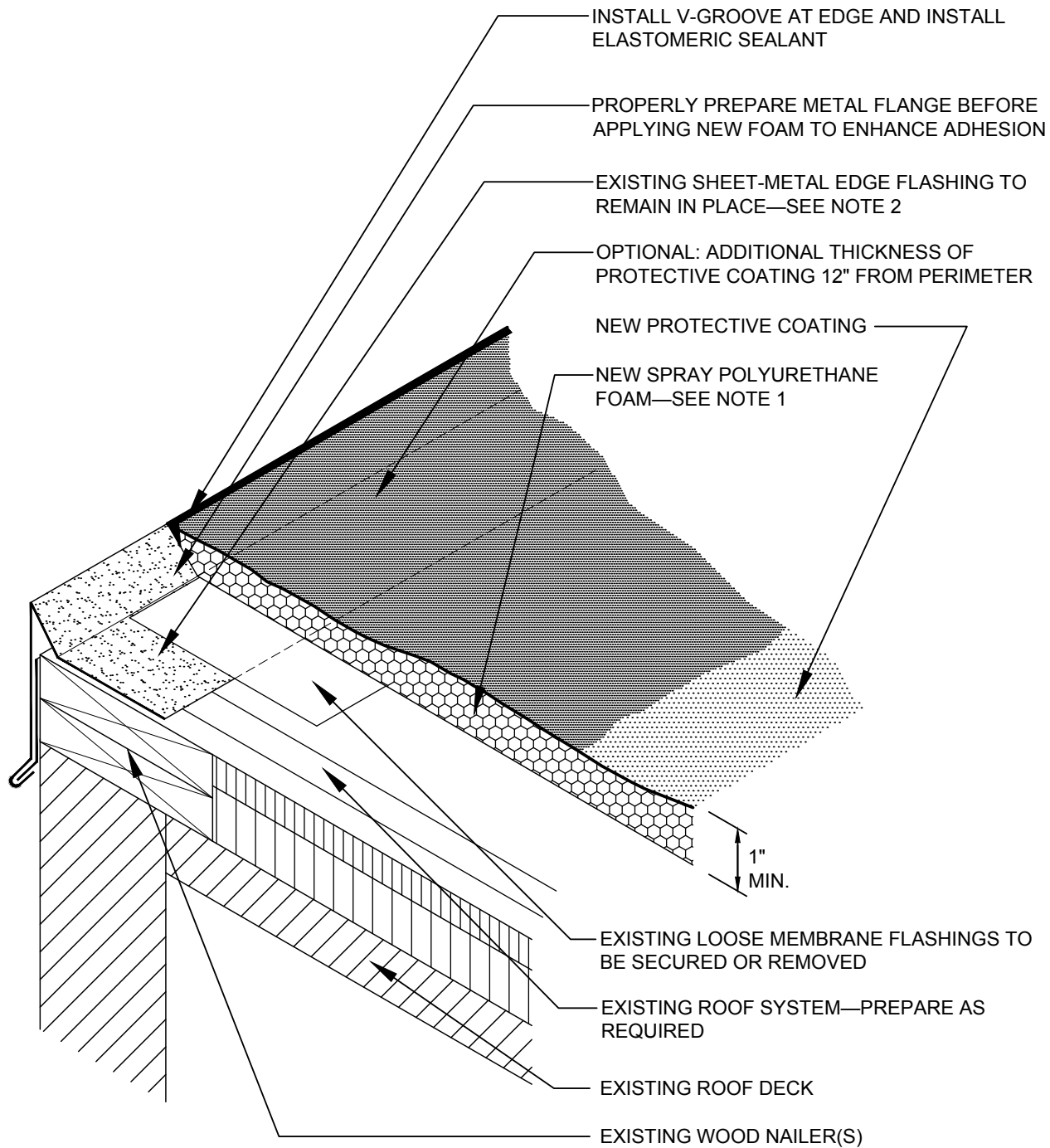

NOTES:

1. FOR PREPARED AGGREGATE-SURFACED MEMBRANES, MINIMUM THICKNESS FOR SPF IS 1 1/2 INCHES. REFER TO CHAPTER 7—ROOF RE-COVERING FOR ADDITIONAL INFORMATION.
2. SHEET-METAL COMPONENTS THAT ARE TO REMAIN IN PLACE SHOULD BE WEATHERPROOF AND HAVE THE EXPECTED SERVICE LIFE EQUAL TO THE NEW ROOF SYSTEM.
3. REFER TO THE INTRODUCTION IN CHAPTER 8—CONSTRUCTION DETAILS FOR ADDITIONAL INFORMATION.



PERIMETER EDGE WITH EXISTING EMBEDDED EDGE METAL (GRAVEL STOP) FOR SPF RE-COVER

2012

NOT DRAWN TO SCALE

SPF(R)-2

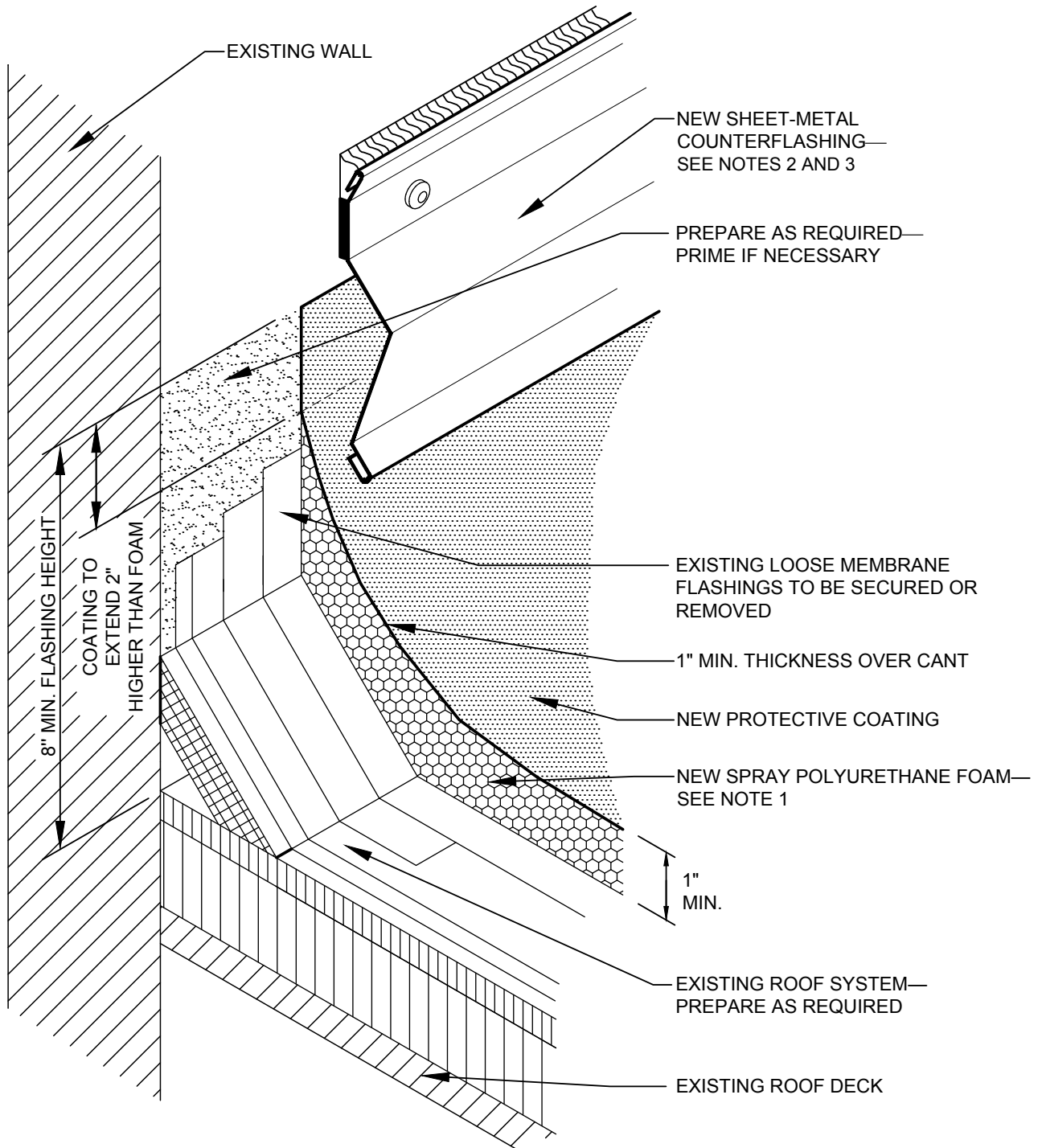

NOTES:

1. FOR PREPARED AGGREGATE-SURFACED MEMBRANES, MINIMUM THICKNESS FOR SPF IS 1 1/2 INCHES. REFER TO CHAPTER 7—ROOF RE-COVERING FOR ADDITIONAL INFORMATION.
2. REFER TO THE ARCHITECTURAL METAL FLASHING SECTION OF THE NRCA ROOFING MANUAL: ARCHITECTURAL METAL FLASHING, CONDENSATION CONTROL AND REROOFING FOR DESIGN, JOINERY AND SECUREMENT OPTIONS FOR COUNTERFLASHINGS.
3. REFER TO THE INTRODUCTION IN CHAPTER 8—CONSTRUCTION DETAILS FOR ADDITIONAL INFORMATION.

	<p>BASE FLASHING WITH NEW COUNTERFLASHING FOR SPF RE-COVER</p>	<p>SPF(R)-3</p>
<p>2012</p>	<p>NOT DRAWN TO SCALE</p>	

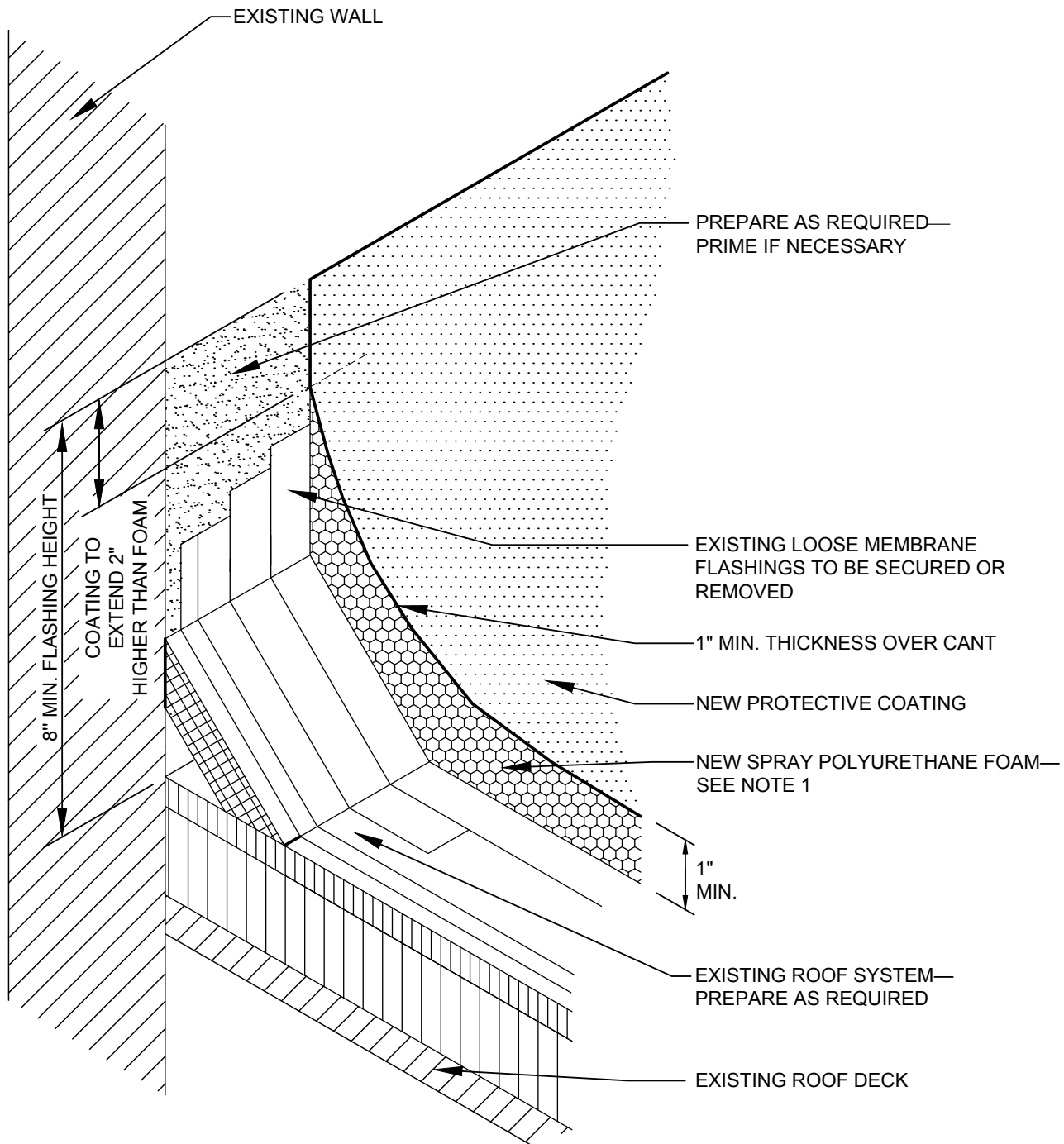

NOTES:

1. FOR PREPARED AGGREGATE-SURFACED MEMBRANES, MINIMUM THICKNESS FOR SPF IS 1 1/2 INCHES. REFER TO CHAPTER 7—ROOF RE-COVERING FOR ADDITIONAL INFORMATION.
2. REFER TO THE INTRODUCTION IN CHAPTER 8—CONSTRUCTION DETAILS FOR ADDITIONAL INFORMATION.



BASE FLASHING FOR SPF RE-COVER

2012

NOT DRAWN TO SCALE

SPF(R)-3A

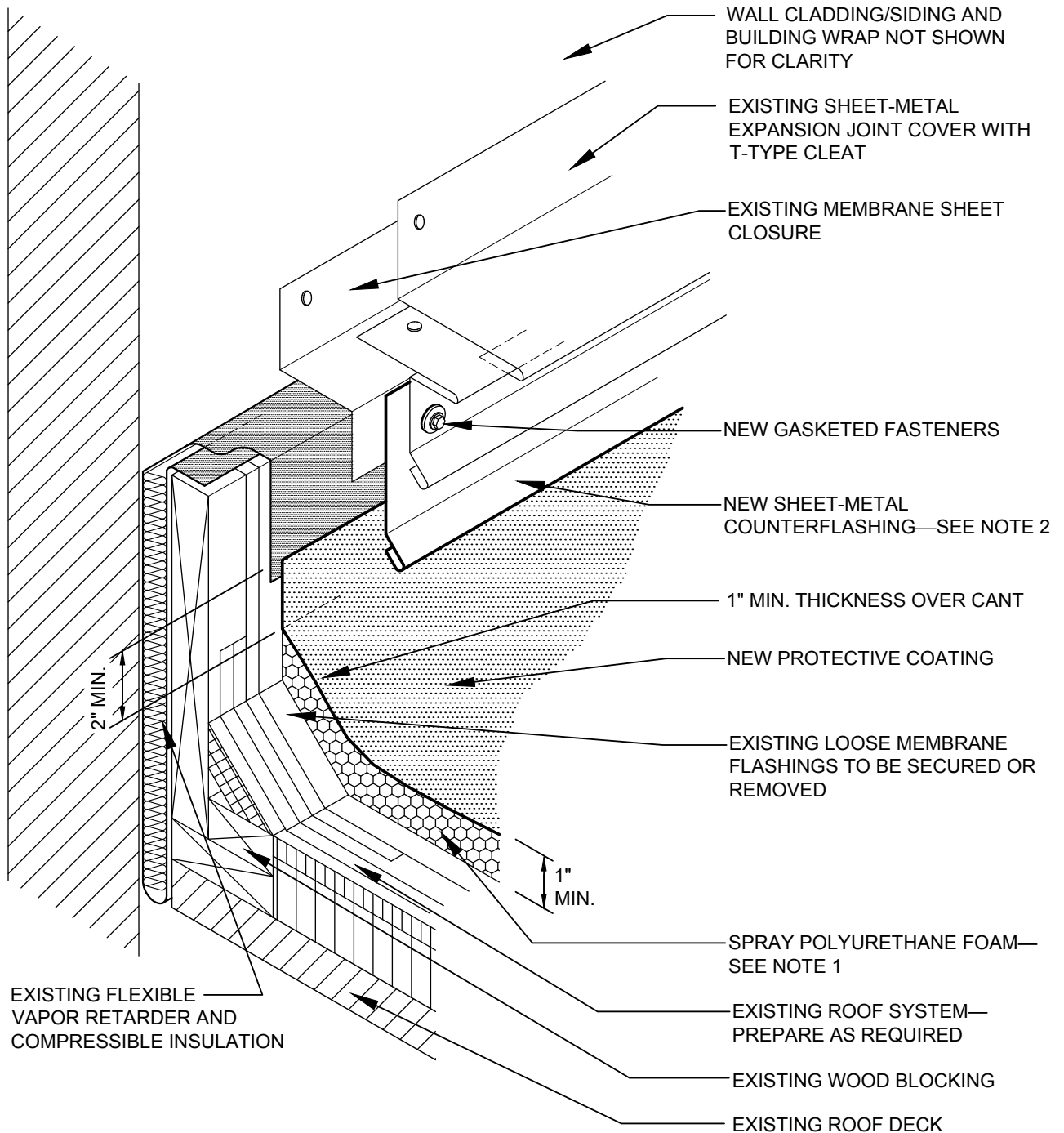

NOTES:

1. FOR PREPARED AGGREGATE-SURFACED MEMBRANES, MINIMUM THICKNESS FOR SPF IS 1 1/2 INCHES. REFER TO CHAPTER 7—ROOF RE-COVERING FOR ADDITIONAL INFORMATION.
2. REFER TO THE ARCHITECTURAL METAL FLASHING SECTION OF THE NRCA ROOFING MANUAL: ARCHITECTURAL METAL FLASHING, CONDENSATION CONTROL AND REROOFING FOR DESIGN, JOINERY AND SECUREMENT OPTIONS FOR EXPANSION JOINTS.
3. REFER TO THE INTRODUCTION IN CHAPTER 8—CONSTRUCTION DETAILS FOR ADDITIONAL INFORMATION.



BASE FLASHING AT ROOF-TO-WALL EXPANSION JOINT FOR SPF RE-COVER

2012

NOT DRAWN TO SCALE

SPF(R)-4

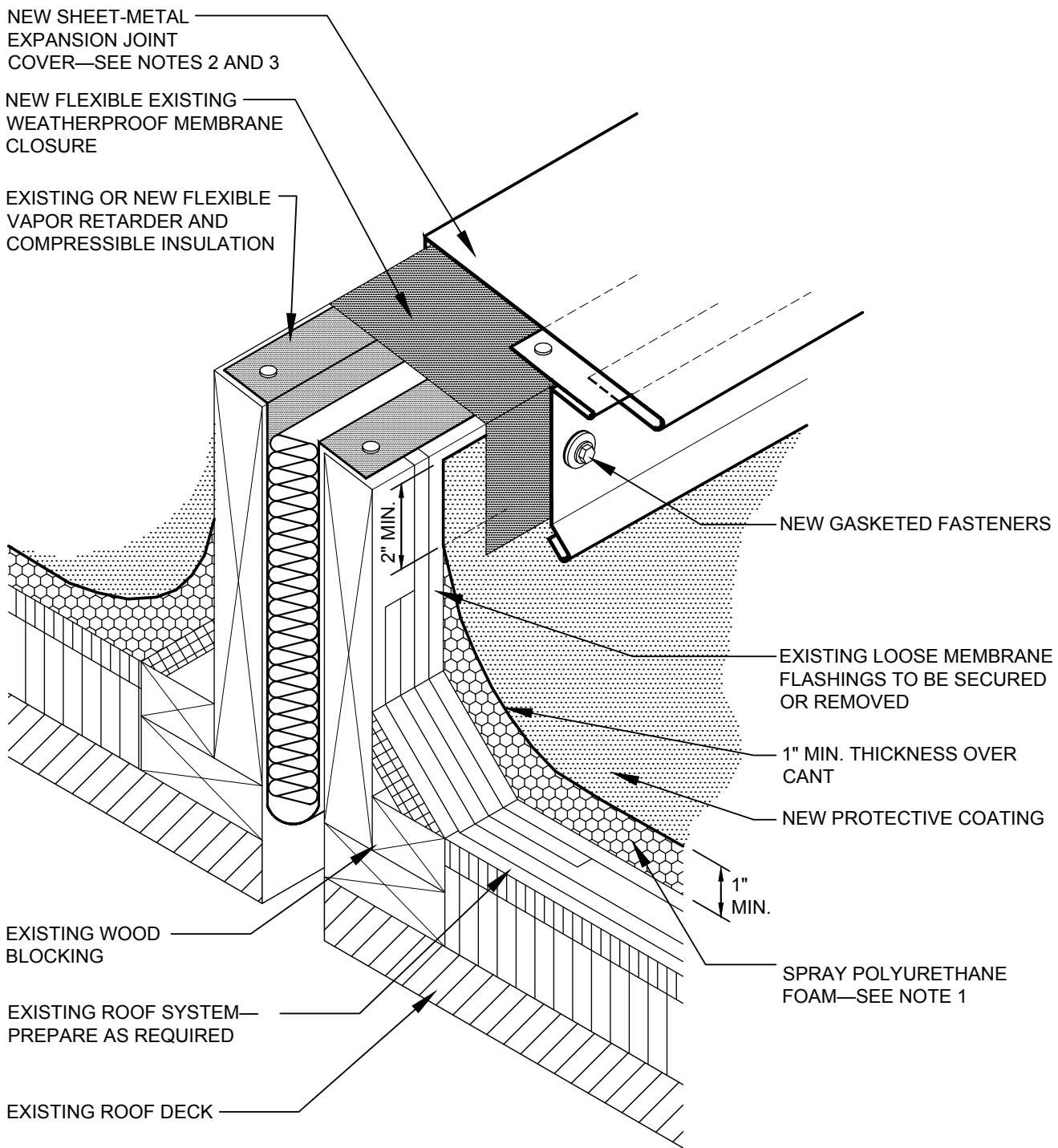

NOTES:

1. FOR PREPARED AGGREGATE-SURFACED MEMBRANES, MINIMUM THICKNESS FOR SPF IS 1 1/2 INCHES. REFER TO CHAPTER 7—ROOF RE-COVERING FOR ADDITIONAL INFORMATION.
2. REFER TO THE ARCHITECTURAL METAL FLASHING SECTION OF THE NRCA ROOFING MANUAL: ARCHITECTURAL METAL FLASHING, CONDENSATION CONTROL AND REROOFING FOR DESIGN, JOINERY AND SECUREMENT OPTIONS FOR EXPANSION JOINTS.
3. REFER TO THE INTRODUCTION IN CHAPTER 8—CONSTRUCTION DETAILS FOR ADDITIONAL INFORMATION.



BASE FLASHING AT EXPANSION JOINT WITH NEW SHEET-METAL COVER FOR SPF RE-COVER

2012

NOT DRAWN TO SCALE

SPF(R)-5

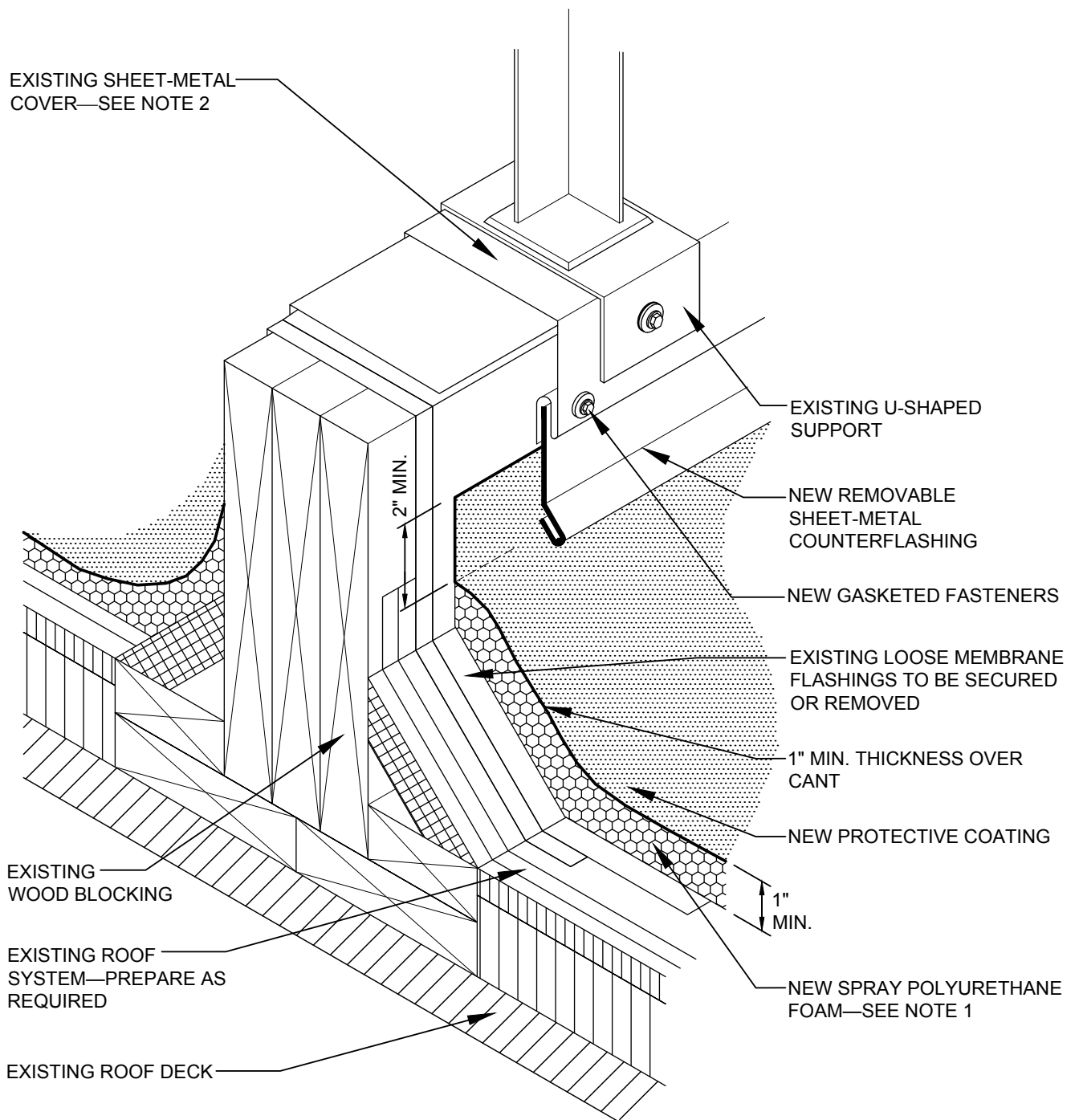

NOTES:

1. FOR PREPARED AGGREGATE-SURFACED MEMBRANES, MINIMUM THICKNESS FOR SPF IS 1 1/2 INCHES. REFER TO CHAPTER 7— ROOF RE-COVERING FOR ADDITIONAL INFORMATION.
2. SHEET-METAL COMPONENTS THAT ARE TO REMAIN IN PLACE SHOULD BE WEATHERPROOF AND HAVE THE EXPECTED SERVICE LIFE EQUAL TO THE NEW ROOF SYSTEM.
3. REFER TO THE ARCHITECTURAL METAL FLASHING SECTION OF THE NRCA ROOFING MANUAL: ARCHITECTURAL METAL FLASHING, CONDENSATION CONTROL AND REROOFING FOR DESIGN, JOINERY AND SECUREMENT OPTIONS FOR COUNTERFLASHINGS.
4. REFER TO THE INTRODUCTION IN CHAPTER 8—CONSTRUCTION DETAILS FOR ADDITIONAL INFORMATION.



**BASE FLASHING AT EQUIPMENT SUPPORT CURB WITH
EXISTING SHEET-METAL COVER AND NEW COUNTERFLASHING
FOR SPF RE-COVER**

2012

NOT DRAWN TO SCALE

SPF(R)-6

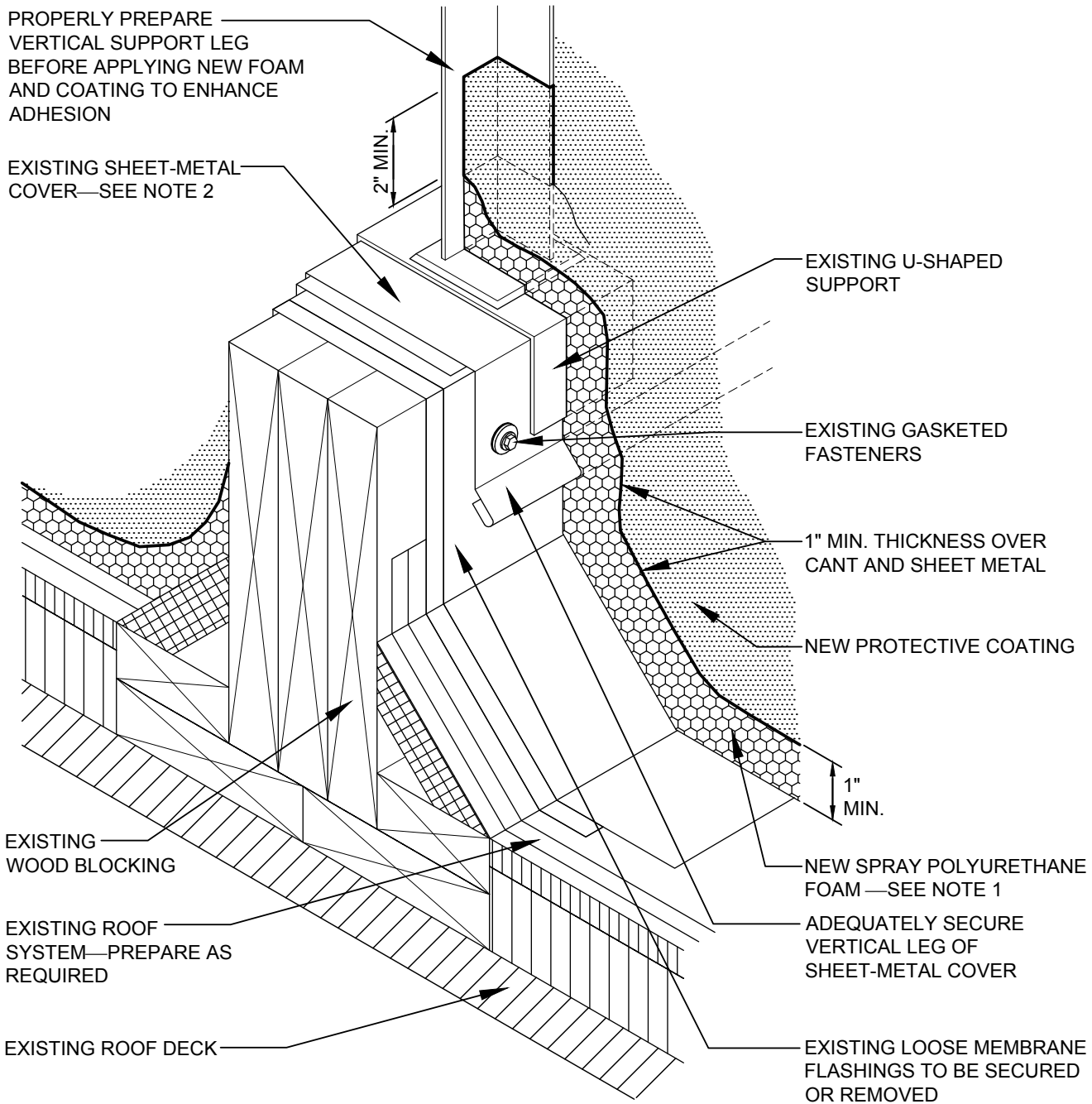

NOTES:

1. FOR PREPARED AGGREGATE-SURFACED MEMBRANES, MINIMUM THICKNESS FOR SPF IS 1 1/2 INCHES. REFER TO CHAPTER 7—ROOF RE-COVERING FOR ADDITIONAL INFORMATION.
2. SHEET-METAL COMPONENTS THAT ARE TO REMAIN IN PLACE SHOULD BE WEATHERPROOF AND HAVE THE EXPECTED SERVICE LIFE EQUAL TO THE NEW ROOF SYSTEM.
3. REFER TO THE INTRODUCTION IN CHAPTER 8—CONSTRUCTION DETAILS FOR ADDITIONAL INFORMATION.



BASE FLASHING AT EQUIPMENT SUPPORT CURB FOR SPF RE-COVER

2012

NOT DRAWN TO SCALE

SPF(R)-6A

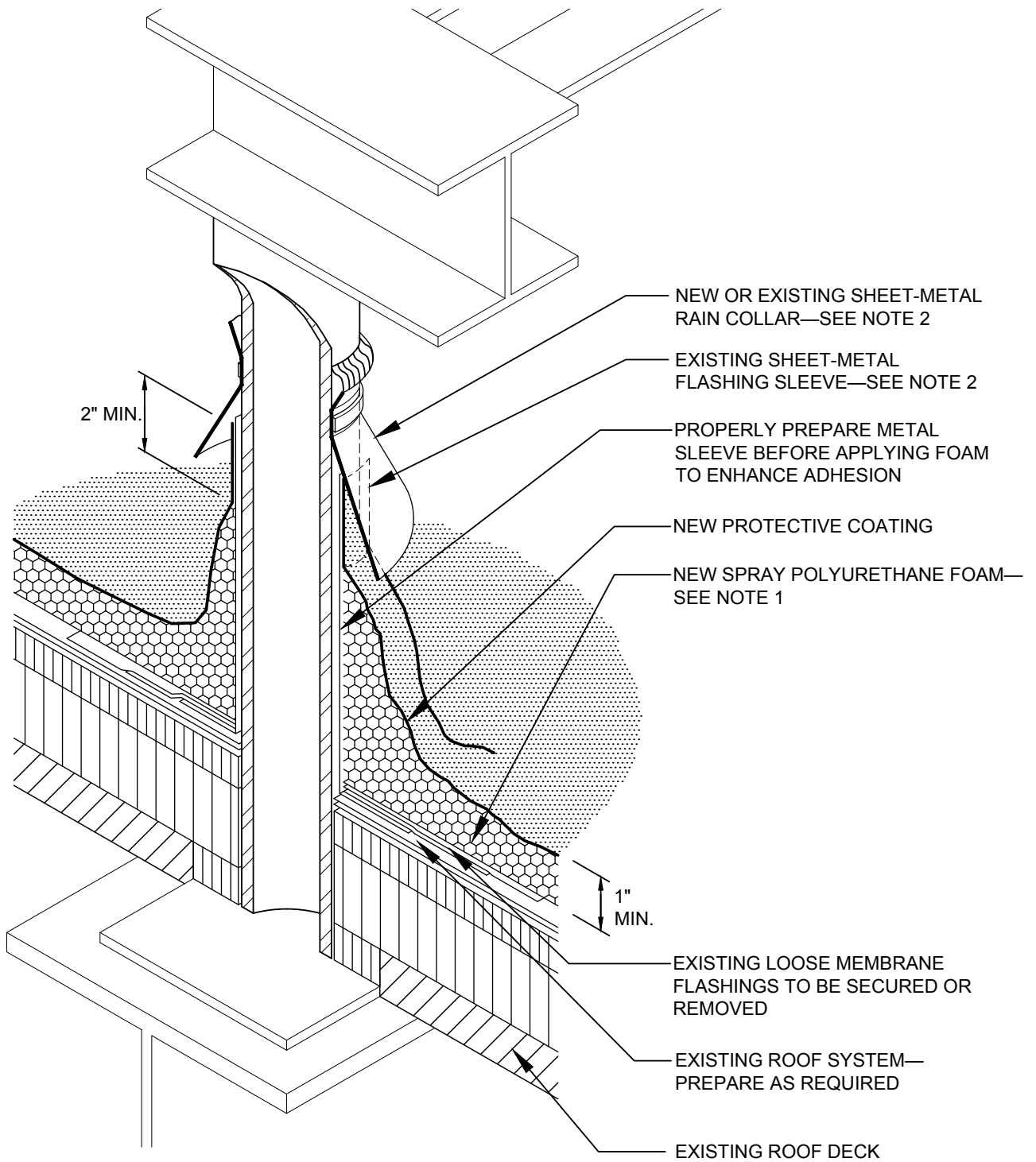

NOTES:

1. FOR PREPARED AGGREGATE-SURFACED MEMBRANES, MINIMUM THICKNESS FOR SPF IS 1 1/2 INCHES. REFER TO CHAPTER 7—ROOF RE-COVERING FOR ADDITIONAL INFORMATION.
2. SHEET-METAL COMPONENTS THAT ARE TO REMAIN IN PLACE SHOULD BE WEATHERPROOF AND HAVE THE EXPECTED SERVICE LIFE EQUAL TO THE NEW ROOF SYSTEM.
3. REFER TO THE INTRODUCTION IN CHAPTER 8—CONSTRUCTION DETAILS FOR ADDITIONAL INFORMATION.



BASE FLASHING AT EQUIPMENT SUPPORT STAND AND RAIN COLLAR PENETRATION FOR SPF RE-COVER

2012

NOT DRAWN TO SCALE

SPF(R)-7

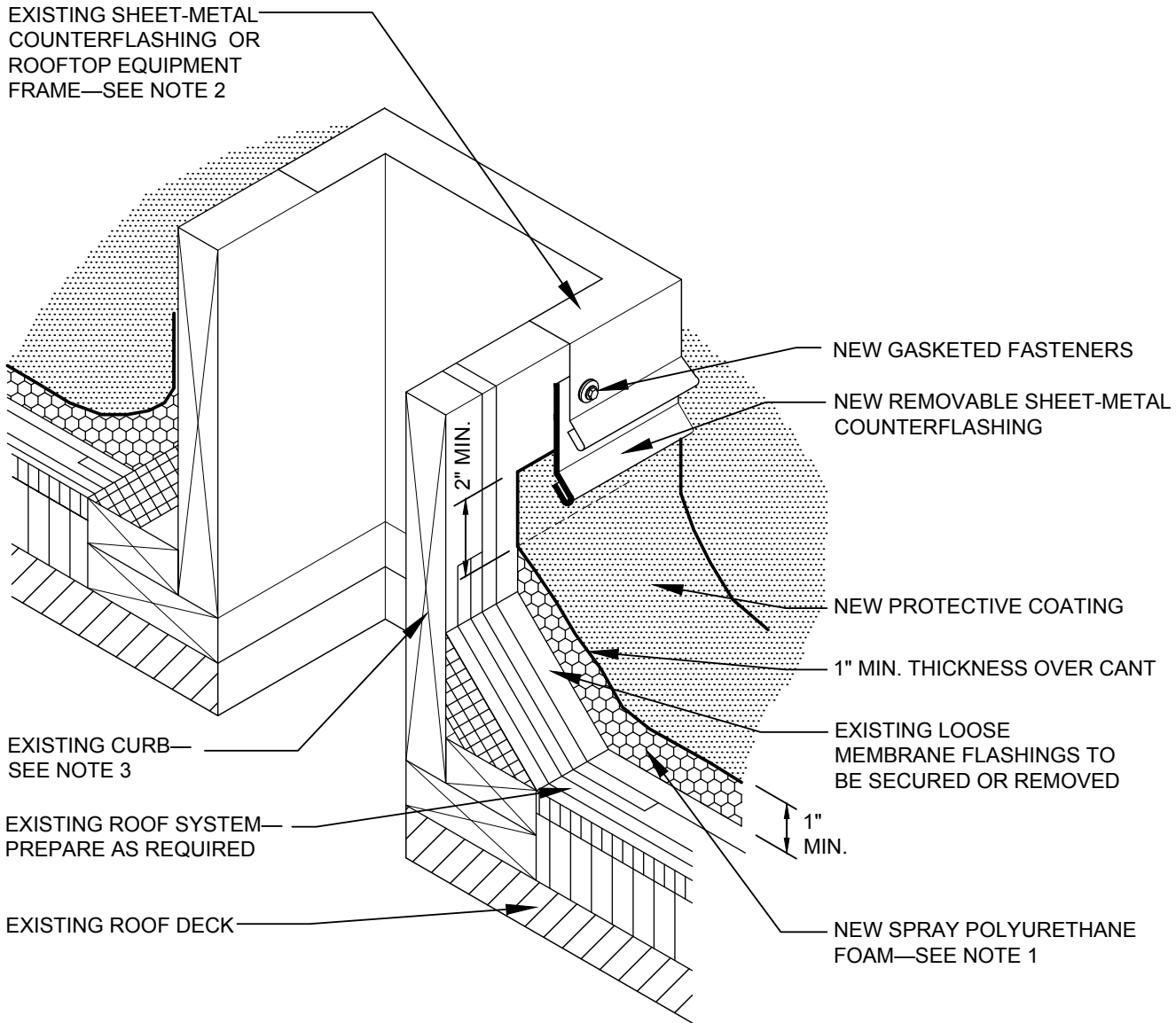

NOTES:

1. FOR PREPARED AGGREGATE-SURFACED MEMBRANES, MINIMUM THICKNESS FOR SPF IS 1 1/2 INCHES. REFER TO CHAPTER 7—ROOF RE-COVERING FOR ADDITIONAL INFORMATION.
2. SHEET-METAL COMPONENTS THAT ARE TO REMAIN IN PLACE SHOULD BE WEATHERPROOF AND HAVE THE EXPECTED SERVICE LIFE EQUAL TO THE NEW ROOF SYSTEM.
3. THIS DETAIL IS APPLICABLE TO VARIOUS TYPES OF CURBS.
4. REFER TO THE INTRODUCTION IN CHAPTER 8—CONSTRUCTION DETAILS FOR ADDITIONAL INFORMATION.



BASE FLASHING AT CURB WITH EXISTING SHEET-METAL COVER AND NEW COUNTERFLASHING FOR SPF RE-COVER

2012

NOT DRAWN TO SCALE

SPF(R)-8

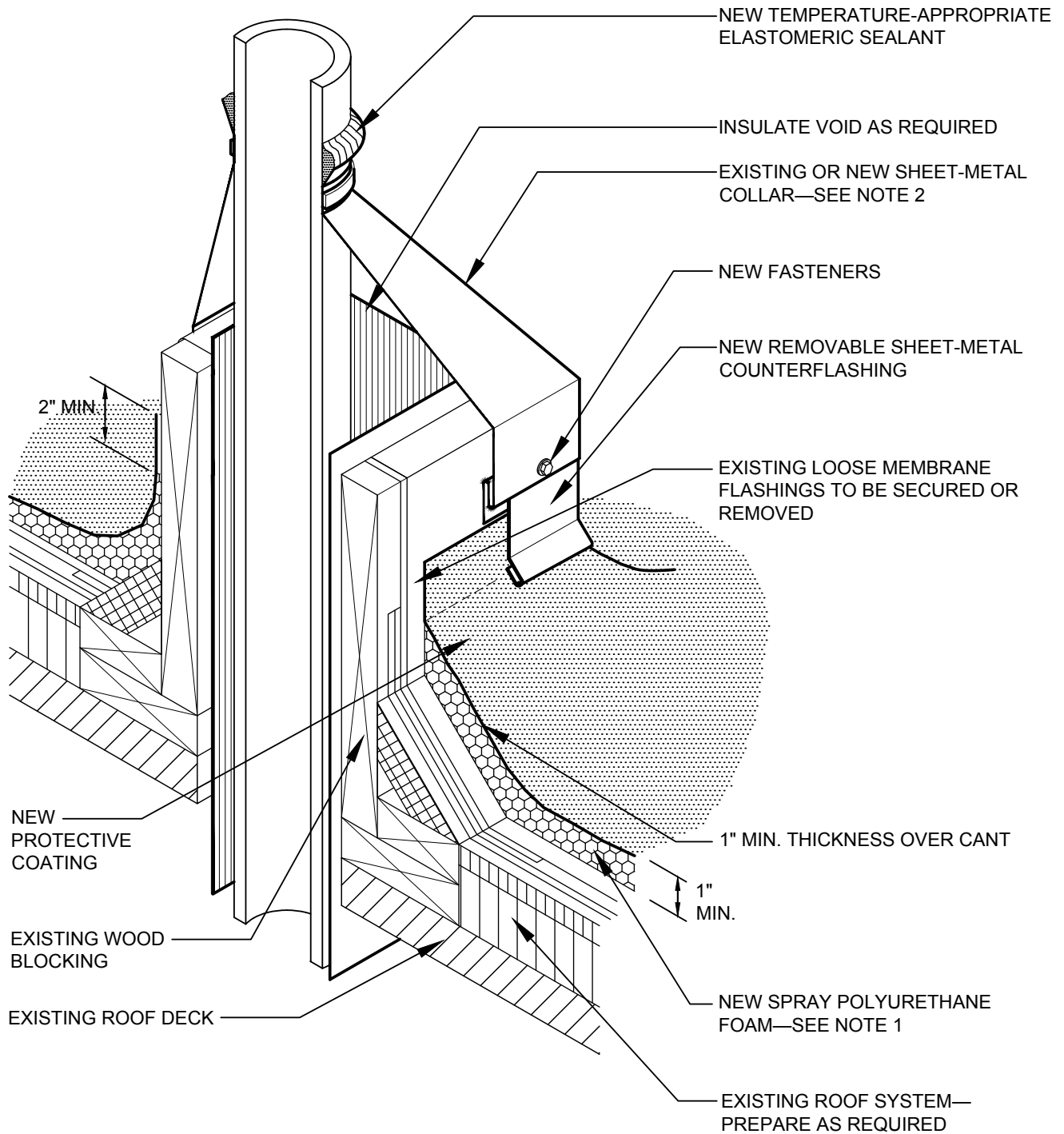

NOTES:

1. FOR PREPARED AGGREGATE-SURFACED MEMBRANES, MINIMUM THICKNESS FOR SPF IS 1 1/2 INCHES. REFER TO CHAPTER 7—ROOF RE-COVERING FOR ADDITIONAL INFORMATION.
2. SHEET-METAL COMPONENTS THAT ARE TO REMAIN IN PLACE SHOULD BE WEATHERPROOF AND HAVE THE EXPECTED SERVICE LIFE EQUAL TO THE NEW ROOF SYSTEM.
3. REFER TO THE ARCHITECTURAL METAL FLASHING SECTION OF THE NRCA ROOFING MANUAL: ARCHITECTURAL METAL FLASHING, CONDENSATION CONTROL AND REROOFING FOR DESIGN, JOINERY AND SECUREMENT OPTIONS FOR FLASHINGS.
4. REFER TO THE INTRODUCTION IN CHAPTER 8—CONSTRUCTION DETAILS FOR ADDITIONAL INFORMATION.



**BASE FLASHING AT ISOLATED STACK FLASHING
FOR SPF RE-COVER**

2012

NOT DRAWN TO SCALE

SPF(R)-9

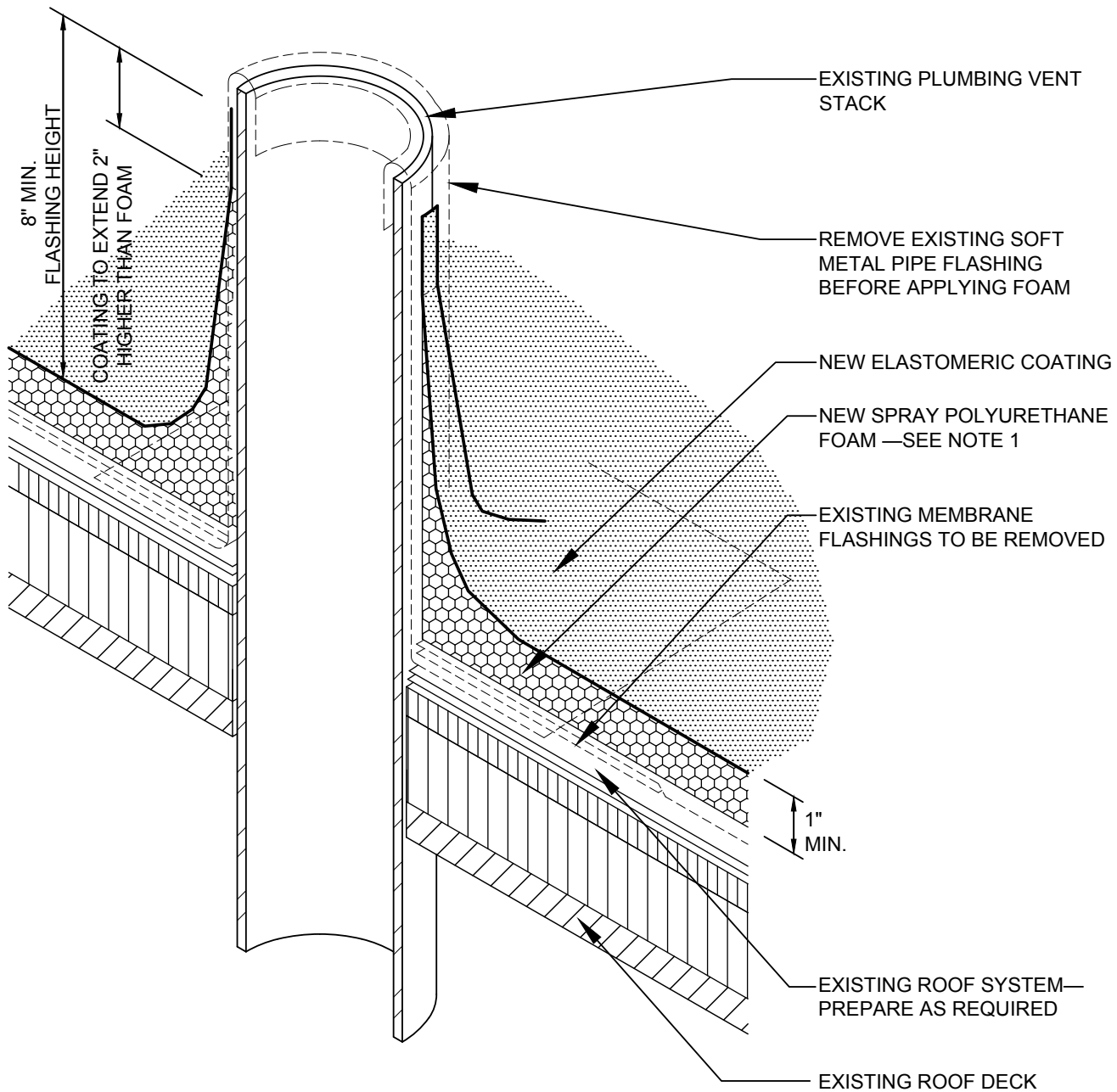

NOTES:

1. FOR PREPARED AGGREGATE-SURFACED MEMBRANES, MINIMUM THICKNESS FOR SPF IS 1 1/2 INCHES. REFER TO CHAPTER 7—ROOF RE-COVERING FOR ADDITIONAL INFORMATION. PRE-MANUFACTURED MEMBRANE FLASHING (BOOT) TO BE REMOVED PRIOR TO APPLICATION OF NEW SPF AND COATING.
2. REFER TO THE INTRODUCTION IN CHAPTER 8—CONSTRUCTION DETAILS FOR ADDITIONAL INFORMATION.



PLUMBING VENT FOR SPF RE-COVER

2012

NOT DRAWN TO SCALE

SPF(R)-10

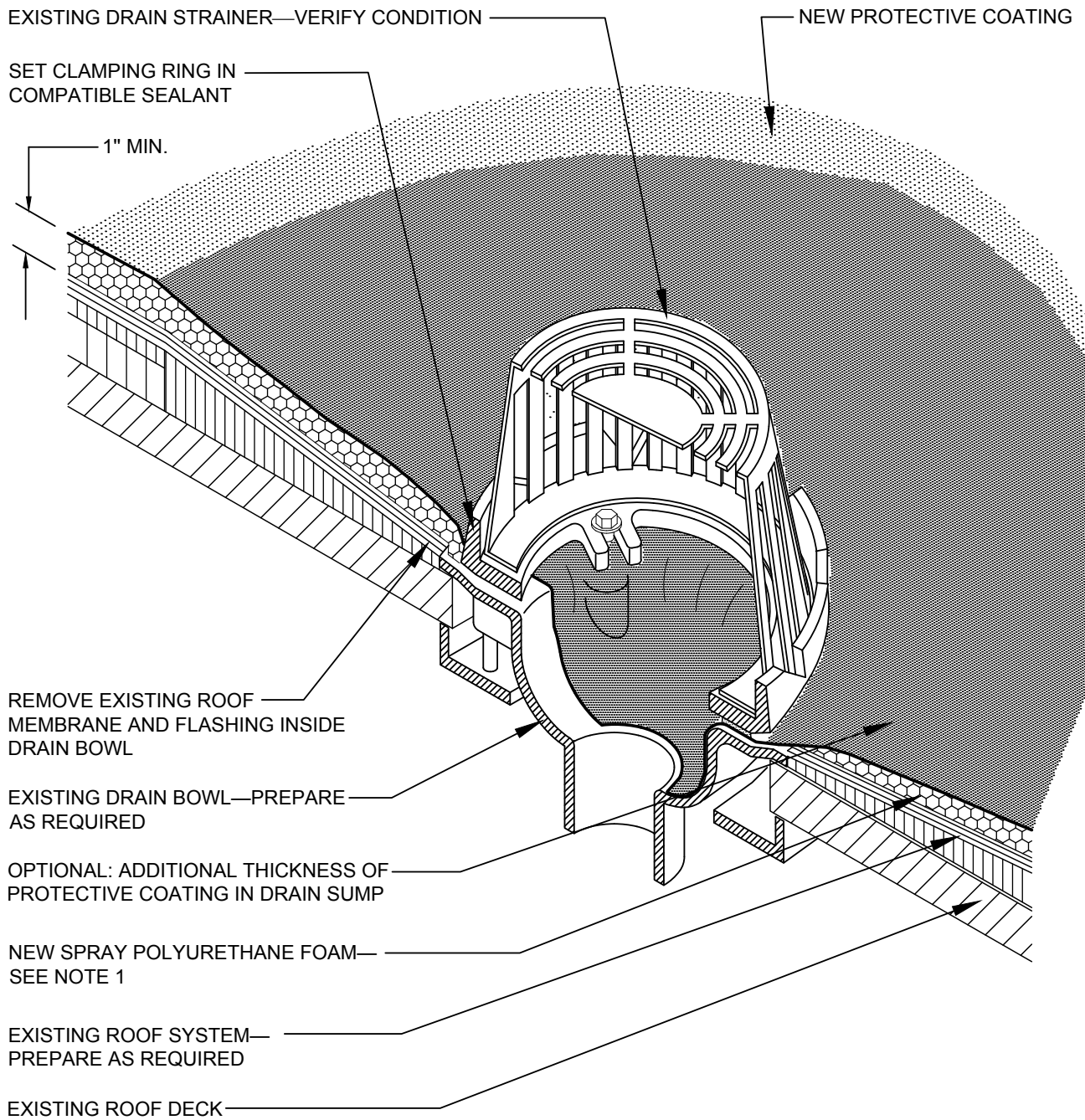

NOTES:

1. FOR PREPARED AGGREGATE-SURFACED MEMBRANES, MINIMUM THICKNESS FOR SPF IS 1 1/2 INCHES. REFER TO CHAPTER 7—ROOF RE-COVERING FOR ADDITIONAL INFORMATION.
2. TAPER SPF TOWARD DRAIN BOWL TO PROVIDE POSITIVE DRAINAGE.
3. REFER TO THE INTRODUCTION IN CHAPTER 8—CONSTRUCTION DETAILS FOR ADDITIONAL INFORMATION.



ROOF DRAIN FOR SPF RE-COVER

2011

NOT DRAWN TO SCALE

SPF(R)-11

This page is intentionally left blank.