

HUMAN HEALTH

ENVIRONMENTAL HEALTH

ChemDraw 16.0 User Guide

Table of Contents

Recent Additions	vii
Chapter 1: Introduction	1
About this Guide	1
Chapter 2: Getting Started	4
About ChemDraw Tutorials	4
ChemDraw User Interface	4
Toolbars	5
Documents	6
Chapter 3: Page Layout	12
The Drawing Area	12
The Document Type	12
Printing	14
Saving Page Setup Settings	15
35mm Slide Boundary Guides	15
Viewing Drawings	16
Tables	18
Chapter 4: Preferences and Settings	22
Setting Preferences	22
Customizing Toolbars	26
Document and Object Settings	26
Customizing Hotkeys	36
Working with Color	39
Document Settings	42
Chapter 5: Shortcuts and Hotkeys	48
Atom Keys	48
Bond Hotkeys	49
Function Hotkeys	50

Shortcuts	51
Nicknames	55
Chapter 6: Basic Drawings	57
Bonds	57
Atoms	62
Captions	63
Drawing Rings	72
Chains	75
Objects	76
Clean Up Structure	93
Checking Structures	95
Chemical Warnings	95
Chapter 7: BioDraw (Professional Level only)	98
BioDraw Templates	98
Customizable Objects	101
Chapter 8: Drawing Biopolymers	107
Biopolymer Editor	108
Protecting Groups	109
Pasting Sequences	110
Expanding Sequences	112
Contracting Labels	112
Modifying Sequence Residues	113
Merging Sidechains with Residue	114
Hybrid Biopolymers	117
IUPAC Codes	118
Disulfide Bridges	122
Lactam Bridges	123
Chapter 9: Advanced Drawing Techniques	124

Coloring Objects	124
Labels	125
Attachment Points	128
Atom Numbering	130
Structure Perspective	132
Mass Fragmentation	132
Drawing Reactions	135
Stoichiometry Grid	141
Templates	144
Defining Nicknames	146
ChemScript	149
Chapter 10: Struct=Name (Professional Level)	151
Struct>Name	151
Name>Struct	155
Adding Structures to a Dictionary	157
Dictionary of FDA Approved Drugs	157
Chapter 11: Chemistry Features	158
Structure Analysis	158
ChemFinder hotlink	159
Stereochemistry	160
Chemical Properties	164
Chemical Annotations	171
3D Viewing	175
TLC	177
ChemNMR (Professional Level)	182
Chapter 12: ChemDraw/Excel and CombiChem	190
Setting Up ChemDraw/Excel	190
Importing tables	190

Importing hit lists	191
Exporting tables	191
Synchronizing Tables	192
Adding structures	193
Searching	194
R-Group analysis	195
Working with Structures	196
ChemDraw/Excel Functions	198
Chemical Properties	212
General Preferences	220
CombiChem	222
Chapter 13:	230
Why use ChemScript?	230
How ChemScript works	230
Getting Started	231
Editing Scripts	232
Introducing the ChemScript API	233
Tutorials	234
Useful References	237
Chapter 14: Query Structures	238
Search Limitations	238
Generic Labels	238
Atom Properties	241
Bond Properties	249
Element Lists	252
Polymers	253
Alternative Groups	258
Anonymous Alternative Groups	264

Expand Generic Structures	265
Atom-to-Atom Mapping	267
Stereochemical Symbols	270
3D Properties	271
Export Compatibility	272
Chapter 15: Sharing Information	277
The Clipboard	277
Transferring Objects	280
Embedding Objects	281
Exporting	281
Importing	282
Transferring Across Platforms	286
Understanding ChemDraw Cloud	286
Chapter 16: Chemical Interpretation	300
Database Conventions	300
Chapter 17: Property Calculations	313
Chapter 18: ChemDraw Web Resources	316
Registering Online	316
User's Guide	316
Technical Support	316
Querying SciFinder® with ChemDraw (Professional Level)	318
Chapter 19: Tutorials	321
Tutorial 1: Drawing a Structure	321
Tutorial 2: Drawing rings	322
Tutorial 3: Fischer projections	324
Tutorial 4: Perspective Drawings	327
Tutorial 5: Newman projections	331
Tutorial 6: Stereochemistry	334

Tutorial 7: Templates	337
-----------------------------	-----

Recent Additions

Windows 10 (32 bit and 64 bit), Microsoft Office 365, and Mac OS X 10.10.x and 10.11.x (32 bit and 64 bit).

ChemDraw strives to be a vital and preferred tool for illustrating chemical and biological concepts. Compatibility with the latest operating systems and tools is an essential part of that. Having the ChemDraw Active-X control functional with the latest browsers on both Windows and Mac platforms is part of this process as well.

Enhanced Retrosynthesis Tool.

Using the Enhanced Retrosynthesis tool, you can now analyze how a molecule might have been constructed. For details, see ["Enhanced Retrosynthesis tool" on page 134](#).

ChemDraw Cloud.

ChemDraw is now available without any installation in ChemDraw Cloud. ChemDraw Desktop and ChemDraw Cloud can share files via upload and download. For details, see ["Understanding ChemDraw Cloud" on page 286](#)

Attach Data feature enhancement.

You can now specify a single character tag while attaching data to an object. These tags will be displayed along with objects. For details, see ["Attached Data" on page 283](#).

Stereoflag Configuration Options.

You can choose to display one general stereoflag label for the molecule (instead of stereoflag labels in individual stereo-centers) when opening MDL format files. For details see, ["Configuration options for stereoflag" on page 23](#).

You can now save the Enhanced Stereochemistry settings when saving to the SKC format. For details, see ["Configuration options for stereoflag" on page 23](#).

ChemDraw E-Notebook.

ChemDraw E-Notebook is a cloud-based tool supporting design and recording of chemistry experiments. ChemDraw E-Notebook and desktop ChemDraw can share ChemDraw documents.

 **Note:** *ChemDraw E-Notebook is not yet available at the time of ChemOffice 16.0 release but will be available soon.*

For details, see ["What is ChemDraw E-Notebook?" on page 298](#).

Introduction

Designed for scientists, students, and scientific authors, ChemDraw is a powerful, yet easy-to use, tool for producing chemical and biological drawings. You can create your own drawings or use those provided in the library of available templates.

Technical Support

The online menu link **Technical Support** opens the Technical Support Web page. Here you can find desktop support resources, including the PerkinElmer Informatics Knowledge Base, product downloads, FAQ, and documentation. To reach the PerkinElmer Informatics Technical Support Web page:

1. Navigate to **Online>Browse PerkinElmer Technical Support**. The Technical Support Web page opens.
2. Click **Desktop Support**.

About this Guide

This guide describes the features in ChemDraw. Some tasks described in this guide must be performed in conjunction with other software. For example, instructions for ChemDraw/Excel describe tasks that require Microsoft Excel. For assistance, consult the Microsoft Excel online help or user's guide.

Conventions used in this Guide

This guide uses several basic conventions to help you quickly learn ChemDraw.

Instructions

Instructions are designed to help you navigate through menus and screens. Menu items appear in **bold**. For example, to open a new drawing template:

1. Go to **File>Open Templates>Amino Acids**.

This step asks you to select the **File** menu, select **Open Templates** (in the File menu), and then select **Amino Acids** (in the Open Templates sub menu).

Notes, Tips, and Cautions

The guide uses particular icons for various types of information:

 **Note:** Notes highlight important information.

 **Tip:** Tips supply useful, specific, "nice to know", information, supplemental to the main text.

 **Caution:** Cautions indicate important information that, if ignored, may lead to data loss, or other serious problems.

Additional Information

These resources are available to help you get started with ChemDraw:

Online Help

In ChemDraw, press **<F1>** or navigate to **Help>Contents**.

Tool Tips

This is the name or a short description of a tool. To view a tool tip, point to a tool. A longer description of the tool tip is available in the status bar.

Status Bar

See the lower left corner of the ChemDraw window for useful information, as shown below.

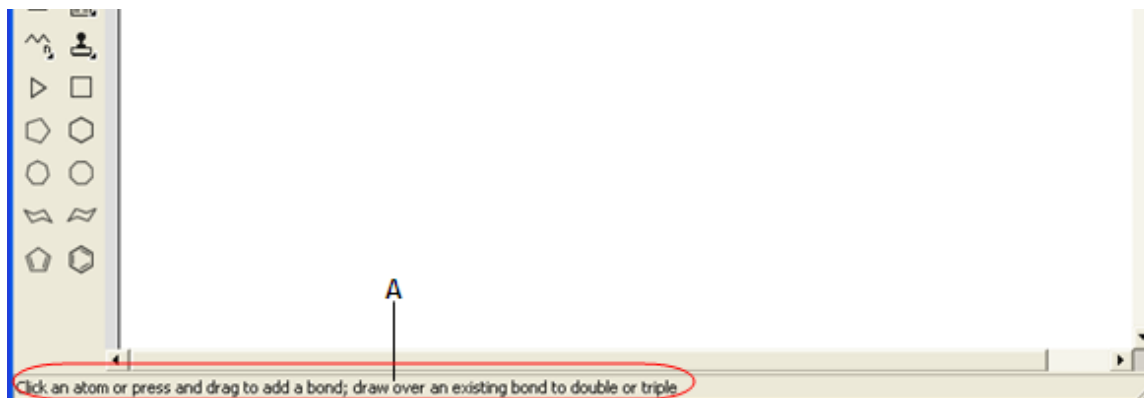

Figure 1.1: Status bar displaying information about solid bond.

Serial Number and Technical Support

For more information on obtaining serial numbers and registration codes, see the [online Services Web site](#).

Technical support is available to registered users through the Internet and our Technical Support department. When contacting Technical Support, always provide the serial number of your ChemOffice application. Our Technical Support Web pages contain answers to frequently asked questions (FAQs) and other information.

To access our Technical Support in ChemDraw, navigate to **Online>Browse PerkinElmer Technical Support**.

If you are unable to find a solution on the Web site, follow these steps before you contact Technical Support:

1. Check the system requirements for the software.
2. Read and follow suggestions outlined in "[Troubleshooting](#)" on page 3.
3. If your attempts to resolve a problem fail, contact [Technical support](#).

Before you call:

- Try to reproduce the problem before contacting us. If you can reproduce the problem, please record the exact steps.
- Record the exact wording of any error messages that appear.
- Record your attempts to correct the problem.

Additional sources of ChemOffice information are:

- ChemDraw online Help
- The [PerkinElmer Informatics Web site](#).
- [PerkinElmer Informatics Services](#).

Troubleshooting

This section describes steps you can take that affect the overall performance of CS Desktop Applications, as well as steps to follow if your computer crashes when using a CS software product.

Performance

Below are some ways you can optimize the performance of ChemOffice Desktop Applications:

- From the Performance tab in the System control panel, allocate more processor time to the application.
- Install more physical RAM. The more you have, the less ChemOffice desktop applications will have to access your hard disk to use Virtual Memory.
- Increase the Virtual Memory (VM). Virtual memory extends RAM by allowing space on your hard disk to be used as RAM. However, the time for swapping between the application and the hard disk is slower than swapping with physical RAM.

Applications and Drivers

As with most complex software applications, there may be unusual circumstances in which ChemDraw may become unresponsive. Below are some recommended steps for you to follow to try to resolve software and driver issues.

1. Restart Windows and try to reproduce the problem. If the problem recurs, continue with the following steps.
 2. The most common conflicts concern video drivers, printer drivers, screen savers, and virus protection. If you do need to contact us, be sure to determine what type and version of drivers you are using.
- **Video Driver-related issues:** If you experience problems displaying any ChemOffice Desktop Application, first try switching to the VGA video driver in the display Control Panel or System Setup, and then retest the issues. If using a different driver helps, your original driver may need to be updated—contact the maker of the driver and obtain the most up-to-date driver. If you still encounter problems, contact us with the relevant details about the original driver and the resulting problem.
 - **Printer Driver-related issues:** Try using a different printer driver. If using a different driver helps, your original driver may need to be updated—contact the maker of the driver and obtain the most up-to-date driver. If you still encounter problems, contact us with the relevant details about the original driver and the resulting problem.
3. Reinstall the software. Before you reinstall, uninstall the software, and disable all background applications, including screen savers, and virus protection. Read complete uninstall instructions on the Technical Support web page.
 4. If the problem still persists, use our online [contact form](#) to provide details to Technical Support.

Getting Started

This topics covered in this chapter will help you become familiar with the user interface:

About ChemDraw Tutorials

There are seven tutorials available in the [Tutorials](#) chapter:

- Tutorial 1: Drawing a Structure
- Tutorial 2: Using Rings
- Tutorial 3: Fischer Projections
- Tutorial 4: Perspective Drawings
- Tutorial 5: Newman Projections
- Tutorial 6: Stereochemistry
- Tutorial 7: Templates

These tutorials provide step-by-step instructions to help you work with the ChemDraw tools.

ChemDraw User Interface

By default, the user interface displays commonly-used toolbars, the main menu, and document status bar. The user interface appears below:

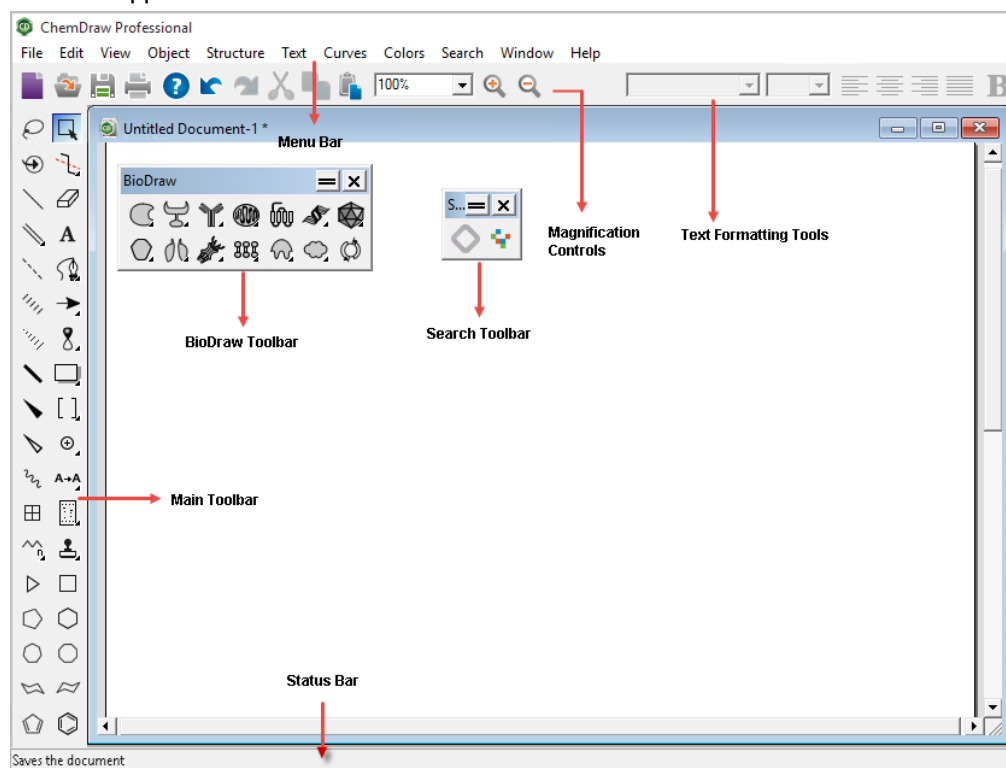

ChemDraw Professional windows user interface

Toolbars

In ChemDraw, several new toolbars are introduced, such as Search, Structure, Curves, Windows, and Biopolymer toolbars. To display or hide a toolbar, select it in the **View** menu. A check mark appears next to the toolbar name when it is visible. You can also hide the toolbar by clicking on the 'X' icon on the upper-right corner of the toolbar.

The Main Toolbar

The main toolbar includes the tools most commonly used for drawing structures. These include all selection and bond tools. You can open other toolbars from the main toolbar. Navigate to **View>Show Main Toolbar**.

Tearing off Toolbars

Some tools on the main toolbar have other toolbars associated with them. These are indicated by a small black triangle in the lower right corner. For example:

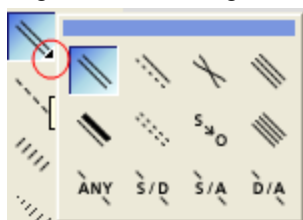

You can “tear off” these smaller toolbars and place them anywhere on your screen.

To tear off a toolbar:

- Double click on the main toolbar to show the secondary tools and then drag it to where you want it on your screen.

.Docking and Floating

You can dock or float any standard toolbar. When you dock a toolbar, it becomes attached to the drawing window.

The floating toolbars appear in front of the document window and you can move them around in the drawing window.

Double-clicking the toolbar restores it to the last, or default, or docked position.

To dock a toolbar, do one of the following:

- Click and drag the toolbar to any edge outside the drawing window.
- Right-click the toolbar and select **Dock Toolbar**.

To float a toolbar, do one of the following:

- Double-click the docked toolbar.
- Click and drag the docked toolbar into the drawing window.
- Right-click the toolbar and select **Float Toolbar**.

BioDraw Toolbar

The BioDraw toolbar contains drawing tools for adding biological and biochemical elements to your drawings. See ["BioDraw \(Professional Level only\)" on page 98](#) for more information.

Documents

A document is a workspace where you create and edit structures. A document may contain multiple pages, or a single page.

Creating Documents

You can create a new document using either the default settings, or a Style Sheet with customized settings. To create a document, navigate to **File>New Document**.

Using Styles

To create a new document using a different style sheet, or stationery:

1. Navigate to **File>Open Style Sheets**.
2. Choose a Style Sheet from the list.

ChemDraw provides pre-defined style sheets in the ChemDraw Items folder. For example, the ACS Document 1996 is configured to create documents set with the bond lengths, bond width, spacing, and fonts used in the 2-column format of ACS journals.

For a list of the settings in these documents, see ["Document Settings" on page 42](#).

Opening Documents

To open a document, do one of the following:

- Navigate to **File>Open**. From the Open dialog, select the file name and location of the file and click **Open**.
- From the File menu, choose the document from the list at the bottom.

Selecting an Open Document

The Window menu lists all open documents and templates. The document you choose from the list becomes the active window.

Annotating Documents

Annotations are useful for adding text information to help you identify documents in a database search. Annotations are categorized using keywords and an associated data value. There are several default keywords: Name, Description, Type, and Other Info. You can also add your own keywords.

To annotate a document:

1. Navigate to **File>Document Annotations**. The Annotate dialog opens.
2. Select a keyword from the keyword list, or add your own keyword.
3. To add a keyword:
 - a. Select **Add New Annotation** from the keyword list. The Add New Annotation dialog appears.
 - b. Enter a keyword in the **New Keyword** text field.
 - c. In the **New Content** text field, enter the notes to apply to the document and click **Add**.
4. Click **OK**.

Deleting a Keyword

When you delete a keyword, the annotation for that keyword is also deleted.

1. In the Annotate dialog box, select the keyword from the Keyword list.
2. Click **Delete Keyword**. Click **Yes** when prompted for confirmation.
3. Click **OK**.

Discarding Changes

To retrieve the last-saved version of a file, navigate to **File>Revert**.

Undo, Redo, and Repeat

ChemDraw tracks your actions. To undo, redo, or repeat your last action, select the appropriate option in the **Edit** menu. The number of actions tracked is limited by the amount of memory (RAM and virtual memory) available.

 **Note:** ChemDraw tracks only those actions you have performed since you last saved the document.

Saving Documents

1. Navigate to **File>Save**.
2. Choose a folder in which to store the file.
3. Type a file name in the **Save As** text field.
4. Select a file format.
5. Click **Save**.

 **Note:** ChemDraw uses the CDX file format by default. Some other formats store a picture of your drawing but may not store the chemical data associated with a structure in its entirety. For example, if you save a ChemDraw drawing in the .eps file format, you will store only a picture of the structure without storing the chemical significance of the connections between atoms and bonds.

ChemDraw lets you add comments, or descriptions, to the document you save.

To enable/disable document comments:

1. Navigate to **File>Preferences**. The Preferences dialog appears.
2. Click the **Open/Save** tab.
3. Check the **Prompt for Comment** check box.

To add document comments:

1. Click **Save**. The Set Document Comment dialog appears:

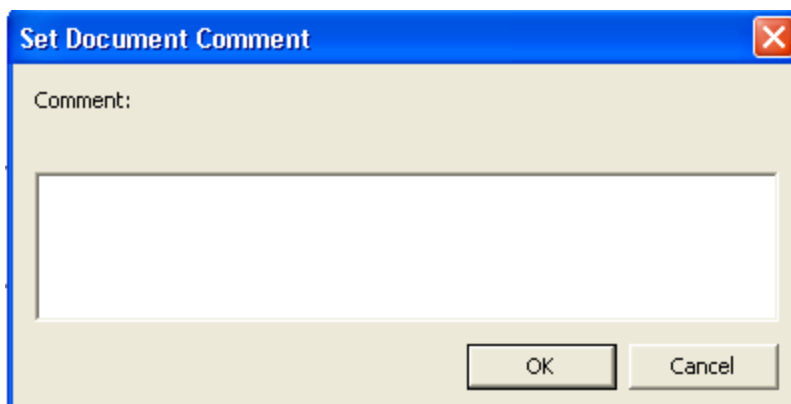

2. Enter the description and click **OK**.

Default File Format

1. Navigate to **File>Preferences**. The Preferences dialog appears.
2. Click the **Open/Save** tab.
3. Select the **Use Default File Format** check box in the **Saving Files** section and choose a format from the list.

Previewing CDX and CDXML Files

You can access a "quick look" thumbnail preview of your CDX and CDXML files.

 **Note:** *Macintosh users, when installing ChemDraw 16.0, be sure and click and drag the CDQuick-Look.qlgenerator file into the QuickLook folder.*

- In Windows, click on the CDX or CDXML file within Windows Explorer and a thumbnail image displays.
- In a Macintosh environment:
 1. Click Finder.
 2. Select **View >Show Preview**.
 3. Locate and click on the CDX or CDXML file and a thumbnail image displays.

Autosave and Autorecovery

You can configure ChemDraw to periodically save an open document. In addition, a default Enable Autorecovery checkbox saves a temp file if the program crashes. You can specify where the autosaved or autorecovery copies are stored.

1. Navigate to **File>Preferences**. The Preferences dialog appears.
2. Click the **Open/Save** tab.

 **Note:** *If using a Macintosh, navigate to ChemDrawProfessional/ChemDraw Prime > Preferences...*

3. Select the **Save Files Every** check box and enter a time frame (in minutes), for example 5 minutes.

The time starts after you make your first change to the document.

Autosave or Autorecover to a Named Destination

You can select an Autosave or Autorecovery path for your files.

In Windows:

1. Navigate to **File>Preferences**. The Preferences dialog appears.
2. Click the **Directories** tab.
3. Select the **Use Documents Location** check box to save files to the default location, or click the **Browse** button next to the **Location for AutoSave/Autorecovery Path** field and specify a location for your saved and recovered files.

Autonumbering Reaction Schemes

You can automatically number molecules, sequentially, in reaction schemes.

To set your numbering scheme:

1. Select **File>Document Settings**, and then click Reaction Display from the options on the left.
2. Choose Roman, Arabic or Alphabetic from the **Numeric Style** dropdown list. You can also select the starting number from the **Starting From:** field.
3. Click **OK**.

To use autonumbering:

1. Draw your reaction scheme.
2. Select your reaction using the **Edit>Select All** menu option or the marquee or lasso tools.
3. Select **Structure>Autonumber Reaction**. Roman numerals or Arabic numerals display beneath your molecules.

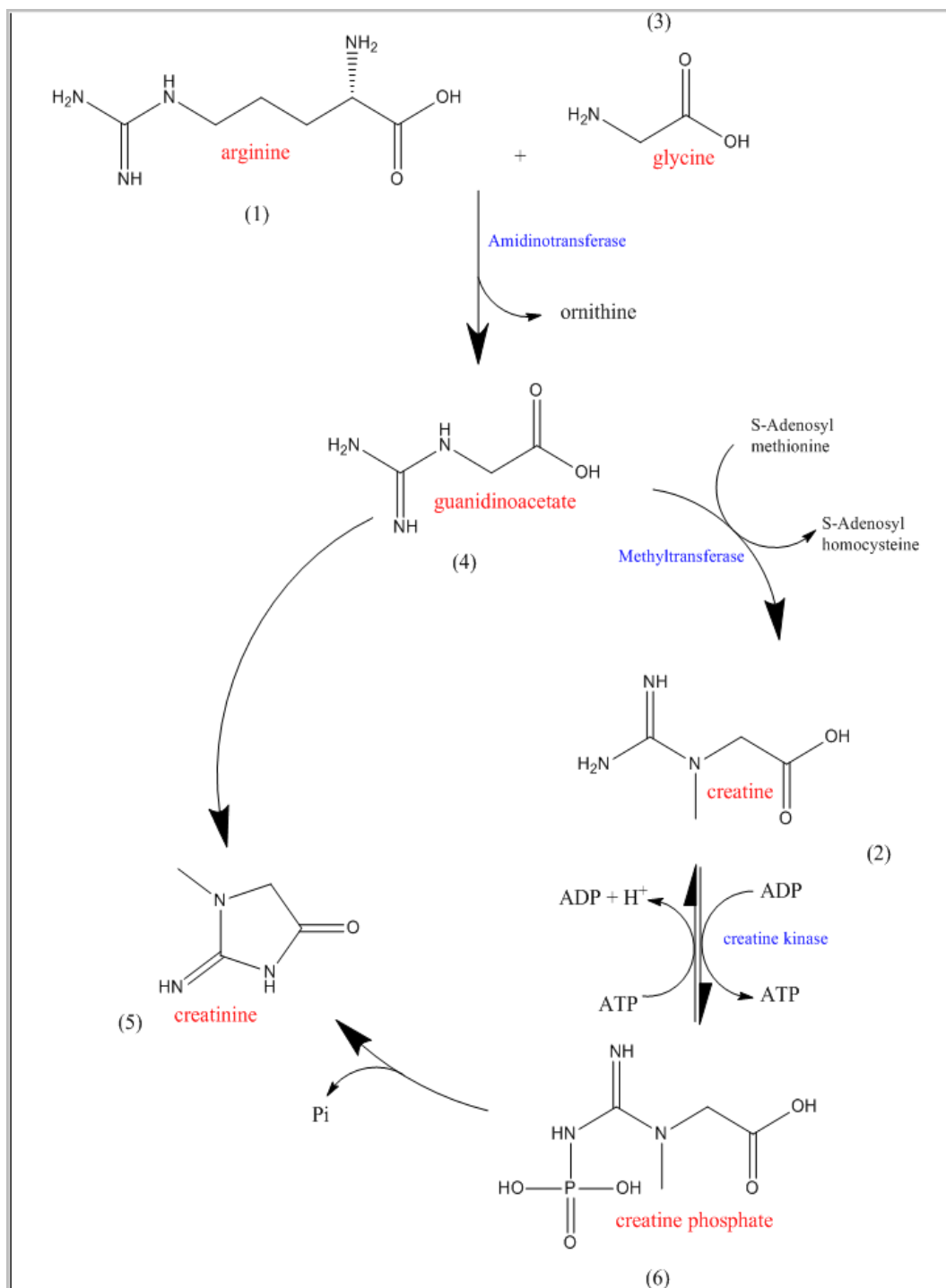

To remove auto numbering:

1. Select your reaction using the **Edit>Select All** menu option or the marquee or lasso tools.
2. Select **Edit>Undo Auto Number Reaction**. The auto numbering removes from the structure.

 **Note:** *If you make a mistake and want to redo auto numbering, select **Edit>Redo Auto number Reaction**. Auto numbering reappears in your reaction scheme.*

To clear the reaction numbers after auto numbering select your reaction using **Edit>Select All**, and then select **Structure>Clear Reaction Numbers**.

Page Layout

Object alignment, page size, orientation, and other factors affect the presentation quality of your document.

The Drawing Area

The document window may not be the same size as the drawing area of the page. A document window, may cover only a part of the drawing area.

These options let you set the drawing area on your screen:

- Document Settings and Page Setup let you modify the page, margins, headers, footers, document type, and size.
- View menu options: Actual Size, Show Document, Magnify, and Reduce.
- Magnification Controls: enlarge and reduce
- Dragging to enlarge the drawing area.

The Document Type

You can set up a document as either a page or a poster:

Pages. A single document containing one or more sheets, each of which is printed on a single piece of paper.

Posters. A single large document, comprising as many sheets of paper as necessary.

Paged Document Setup

To create a document with one or more pages:

1. Navigate to **File>Document Settings**. The Document Settings dialog appears.
2. On the **Layout** tab, select **Pages**.
3. Specify the number of pages in the Document Size section. The Page Setup settings determines the size of the pages. For more information, see "[Page Setup](#)" on page 14.
4. Type the Margin settings. You set the units of the margins in the Preferences dialog. The paper size minus the margins determines the drawing area.
5. Create Headers and Footers as described in "[Headers and Footers](#)" on page 13.
6. Click **OK**. A new document opens, using your settings.

Poster Documents Setup

You can create a poster by creating a single large drawing area, which will be printed on as many separate pages as necessary. When you set the document size and how much each page overlaps, ChemDraw calculates the number of pages needed and the margin sizes. You can set registration marks, which mark the overlap setting on each page, to use as a guide when assembling the poster from the separate pages.

To create a poster:

1. Navigate to **File>Document Settings**.
2. On the Layout tab, click **Poster**.

3. Enter the **Height, Width, and Page Overlap**.
4. Select whether to **Print Registration Marks**.
5. Create Headers and Footers.
6. Click **OK**.

Headers and Footers

For posters, only one header and footer appear for the entire document.

To create a header and footer:

1. Navigate to **File>Document Settings**.
2. Click **Header/Footer** category.
3. Enter the position from the edge of the page for the header or footer to appear.
4. Type the text to appear in the header or footer.
5. Type additional information in the Text box from the following:
 - file name &f
 - page number &p
 - date printed &d
 - time printed &t
6. Position the text horizontally by typing the appropriate characters listed below:
 - centered &c
 - right &r
 - left (default) &l

For example:

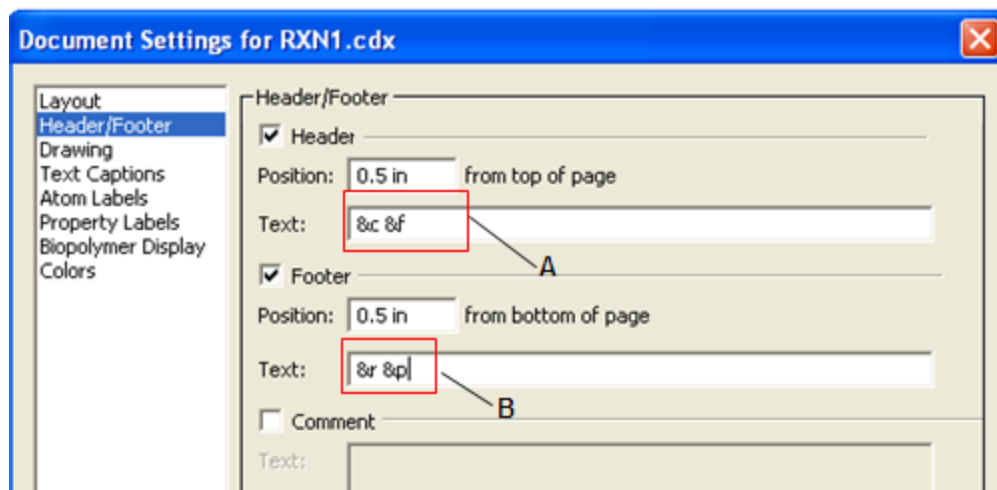

Figure 3.1: A) Variables to display file name center aligned in the header; B) Variables to display page number aligned right in the header.

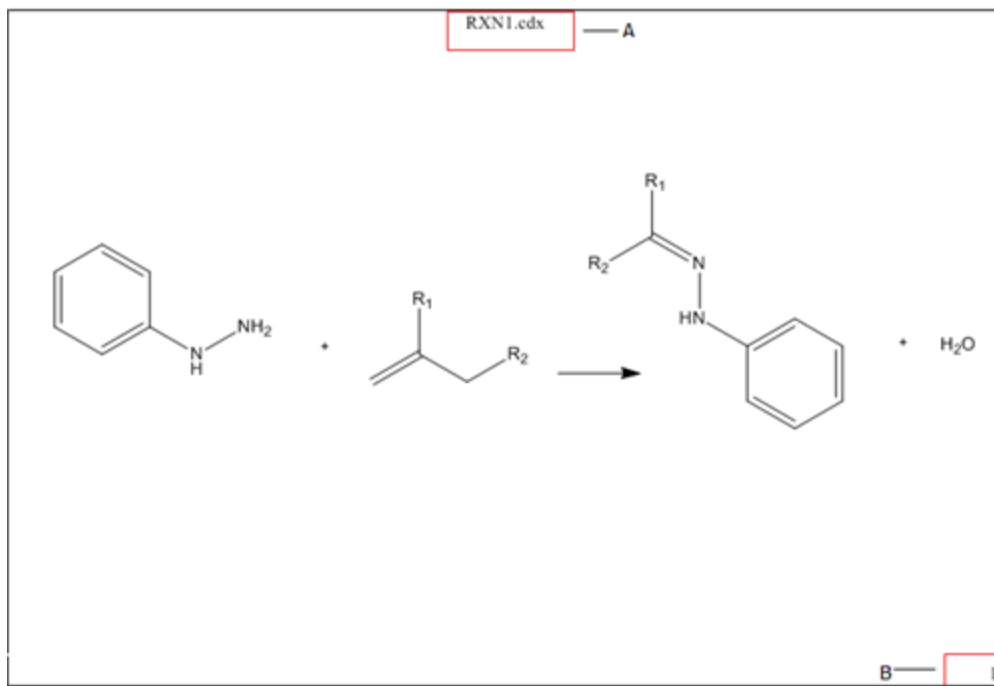

Figure 3.2: A) The filename is displayed center aligned in the header; B) The page number is displayed aligned right in the footer.

Page Setup

To setup the page, navigate to **File>Page Setup**. Page setup options are:

Paper. Choose the size of the paper on which to print the document and the printer tray.

Orientation. Select either **Portrait** or **Landscape**.

Margins. By default, margins are set to 0.5 inches.

Printer. Click to select a printer and set preferences. You can also choose the printer in the Print Options dialog.

Printing

ChemDraw uses the standard system commands to print documents. Available options depend on the printer you use. Refer to your printer's documentation for more information.

In general, to print a document:

1. Navigate to **File>Page Setup**.
2. Make all appropriate selections for your printer and click **OK**.
3. Navigate to **File>Print**.

4. Make your selections in the Print dialog and click **OK**.

To print a document from Explorer:

1. Select the document to print.
2. Navigate to **File>Print**. ChemDraw opens and the Print dialog appears.
3. Make your selections in the Print dialog and click **OK**.

Print Options

Select Printer. This window lists all printers connected to your computer. You can use the default printer or select another printer.

Print to File. The document is saved as a .pm file and includes your printer preferences. The document can then be sent later to a printer.

Find Printer. Click to map to a printer not listed in the Select Printer window.

Page Range. Select the pages to print. To print parts of your document, select the parts and choose **Selection** in the Print Options dialog.

Number of copies. By default, only one copy is printed.

Scaling

With some printers, you can reduce or enlarge your drawings by a variable percentage (25-400%). This option scales all objects and text in the document window. The size changes relative to the paper size, margins, and orientation. The enlarge or reduce option is useful for changing the size of the drawing area, while keeping the image size. If your document fills the page on one printer and you use another printer that requires larger margins, the drawing may disappear off the edge of the document window. You can reduce the drawing size with the reduce option to fit in the document window.

Saving Page Setup Settings

You can save page setup settings in a style sheet. The settings are saved with the text settings, drawing settings, and the color palette.

35mm Slide Boundary Guides

If you create 35mm slides from a hard copy of a document or from a screen shot, you can display boundary lines that appear on your screen positioned at 7 inches and 10.5 inches to match the 2:3 ratio for the 35 mm slide format. These guides are not printed. The drawing area of the page must be at least 7 x 10.5 inches for these boundary lines to be visible.

To display the 35mm slide boundary lines:

1. Navigate to **File>Preferences**.
2. Select the **Building/Display** tab.
3. Select the **Show 35mm Slide Boundary Guides** check box.

4. Click **OK**.

Two 35mm Slide Boundary Guides appear in the orientation chosen in the Page Setup dialog. These guides appear in every document.

Viewing Drawings

Magnification

Magnification changes how large or small your drawing appears without changing its dimensions. You can either select a value in the magnification drop down list or enter your own value between 1% and 999%.

Magnify

1. Select an object to keep in view as you magnify the drawing.

 **Note:** *If you do not select an object, the last object drawn is the center point of the magnification.*

2. Select an option below:

- To increase the magnification, navigate to **View>Magnify**.
- To reduce the magnification, navigate to **View>Reduce**.
- To return the document to its actual size, navigate to **View>Actual**.
- To display the whole document, navigate to **View>Show Document**.
- To set the magnification to a specific value, select or enter a percentage (enter Other between 1-999%) in the General toolbar.

Rulers

Use the rulers to position objects a measured distance from a reference point or create objects of an approximate size. To set the ruler units, go to **File>Preferences** and select the **General** tab.

Displaying Rulers

To toggle rulers on and off, navigate to **View>Show Rulers**.

As you move the pointer, guides appear on each ruler, indicating the position of the pointer.

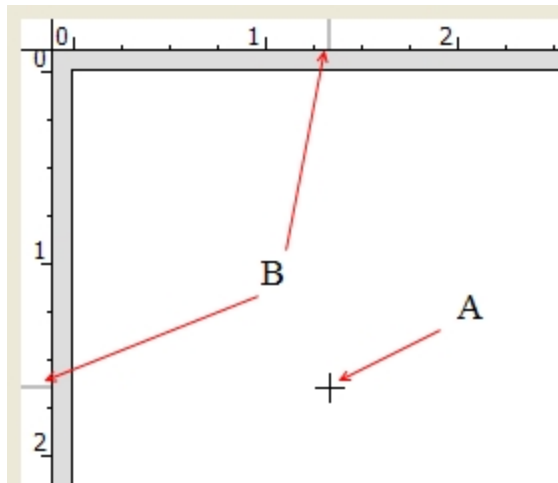



Figure 3.1: How rulers indicate position. A) The cursor; B) Ruler guides indicating vertical and horizontal location of the cursor.

When you select an object, two guides appear in each ruler. The four guides together show the height and width of the selected object.

 **Note:** The rulers adopt the same units that were selected for the document settings.

The Crosshairs

The crosshairs are helpful for positioning objects.

To toggle the crosshairs on and off, navigate to **View>Show Crosshair**.

To assist you in aligning objects, the crosshairs include grid lines that extend from the major division marks on each axis.

You can also show the rulers with the crosshairs to view the unit measurement associated with each division on the crosshair axes.

Moving the Crosshair

1. Position the cursor where the Crosshair axes intersect.

The cursor changes to an arrow near the center of the crosshair.

2. Click and drag the crosshair.

To constrain crosshair to move in the X- or Y-direction, <shift>+drag the crosshair.

Positioning Objects

To align two or more objects using the crosshairs, do the following:

1. Move the Crosshair axes and align it with the object.
2. Select an object and drag it until it is aligned with either axis of the crosshair or a grid line.
3. Select a second object.

4. Drag the second object to the crosshair axis or grid line and align it to the first.

You can also move selected objects in small increments to align them with the crosshair using the arrow keys available on some keyboards: To move 1 point, select the objects and press an arrow key. To move in 10pt increments, press <alt> while you press the arrow key.

Tables

After you create a table, you can adjust its borders and color.

Creating Tables

To create a table:

1. Select the Table tool on the Main Tools toolbar.
2. Do one of the following:
 - Click and drag in the document window to create the table. The table has two rows and two columns.
 - Click in the document window. Type the numbers of rows and columns in the Insert Table dialog, and click **OK**.

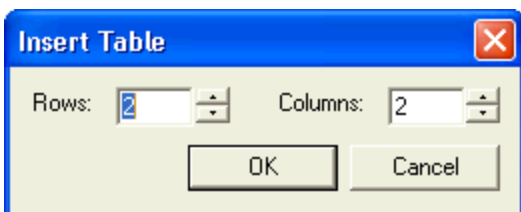

The table appears in the document window.

Resizing Tables

To resize rows or columns, click and drag a border using the table tool.

 **Note:** To proportionally resize all rows and columns in the table, click and drag the top and left border of the table.

Customizing Borders

To customize the borders of the table:

1. With the Table tool selected, right-click a border.
2. Click **Borders** on the context menu. The Table Borders dialog appears.

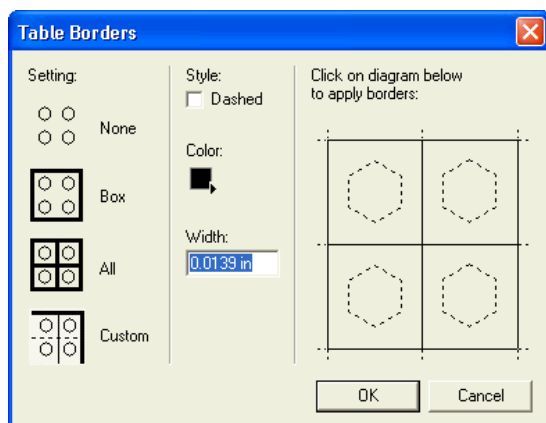

3. Under Setting, select a border setting.
4. Under Style, select the style, color and width of the border to apply.
5. For a custom border, select the desired borders in the table diagram.
6. Click **OK**.

The table tool includes commands to align cell contents; fit, add or delete cells, and clear cells. In general, to change the table, work with the right or bottom borders. To change a row or column, work with the left or top borders.

To resize a cell to fit its contents:

1. Point to a border and right-click.
2. Choose **Size To Fit Contents**. The cells resize to fit around the contents.

To add or delete rows or columns in the table:

1. Point to the top or left border where you want to add or delete the row or column. A border appears as shown below.

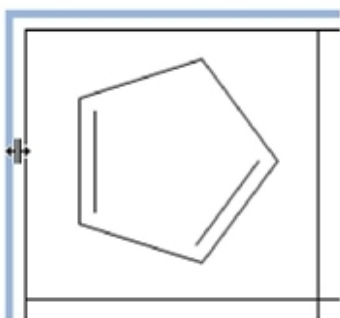

2. Right-click the border and select the appropriate option from the context menu.

To align all of the objects in a column or row, point to a top or left border using the Table tool, right-click, point to the **Align** command on the context menu, and choose the alignment you want.

The cell contents shift and stay in a fixed position relative to the cell. The default alignment is unaligned.

To align all objects in a table, point to a bottom or right border, right-click, point to Align, and choose the alignment you want.

Using the Text Tool

ChemDraw lets you create tables of text using the <tab> key with the Text tool.

Compound	Formula	Mol. Wt.
Benzene	C ₆ H ₆	78.11
Toluene	C ₇ H ₈	92.14

To create the first row and establish the columns of a table:

1. Using the Text tool, click in a document window where you want the table to start.
2. Type a caption.
3. Press <tab>. A second caption box appears.
4. Type a second caption. The second column appears 20 points to the right.
5. Press <tab> again to create a third column, and so on.

 **Note:** *The style, font, and size that you set in each column are maintained in all the rows that follow.*

To change the spacing between columns one point at a time while editing a caption:

1. Select the caption.
2. Move the caption with the arrow keys.

For more information on moving objects, see ["Moving Objects" on page 89](#).

3. To create another column with this same spacing as the previous, select the Text tool and press <tab>. A third caption text box appears.

Creating New Rows

To start a new row that is aligned with the first, press <tab> twice at the end of a row.

A caption text box appears under the first caption positioned exactly 20 points below the first caption in the first row.

To change the spacing between rows as you create the table:

1. Select all the captions in a row.
2. Move the captions using the arrow keys.

For more information on moving objects, see ["Moving Objects" on page 89](#).

Adjusting Row or Column Spacing

1. Select all the captions in the row or column with a selection tool.
2. <Shift> and drag the captions.

The movement is constrained to the X-axis or Y-axis so that you can maintain the row or column alignment.

Inserting New Rows

To insert a row:

1. Select a selection tool and select a row of captions.
2. <Shift>+drag the selected row.
3. <Shift> constrains the movement to the Y-axis to maintain the column alignment.
4. Select the first caption in the row above or below the space you created.
5. <Control>+<shift>+drag to create a copy of the caption and position it in the empty space you created.
6. The placement of this copied caption sets the position of the inserted row.

To fill in the inserted row with caption text:

1. Click the Text tool and select the first caption in the inserted row.
2. Type new text.
3. Press <tab> to move to the second caption in the inserted row, and so on.

Preferences and Settings

You can customize ChemDraw by configuring Preferences and Document Settings to match the way you work. Preferences allow you to change the default behavior of certain options that apply to every open document. The changes you specify in the document settings are applicable only within the document and is not applicable throughout the application. The changes you specify in the object settings are specific to the selected object.

For more information, see the topics found in this chapter:

- [Setting Preferences](#)
- [Customizing Toolbars](#)
- [Document Objects and Settings](#)
- [Customizing Hotkeys](#)
- [Working with Color](#)

Setting Preferences

Preferences affect how ChemDraw works, regardless of the document with which you are working.

1. To open the Preferences dialog box, navigate to **File>Preferences**.

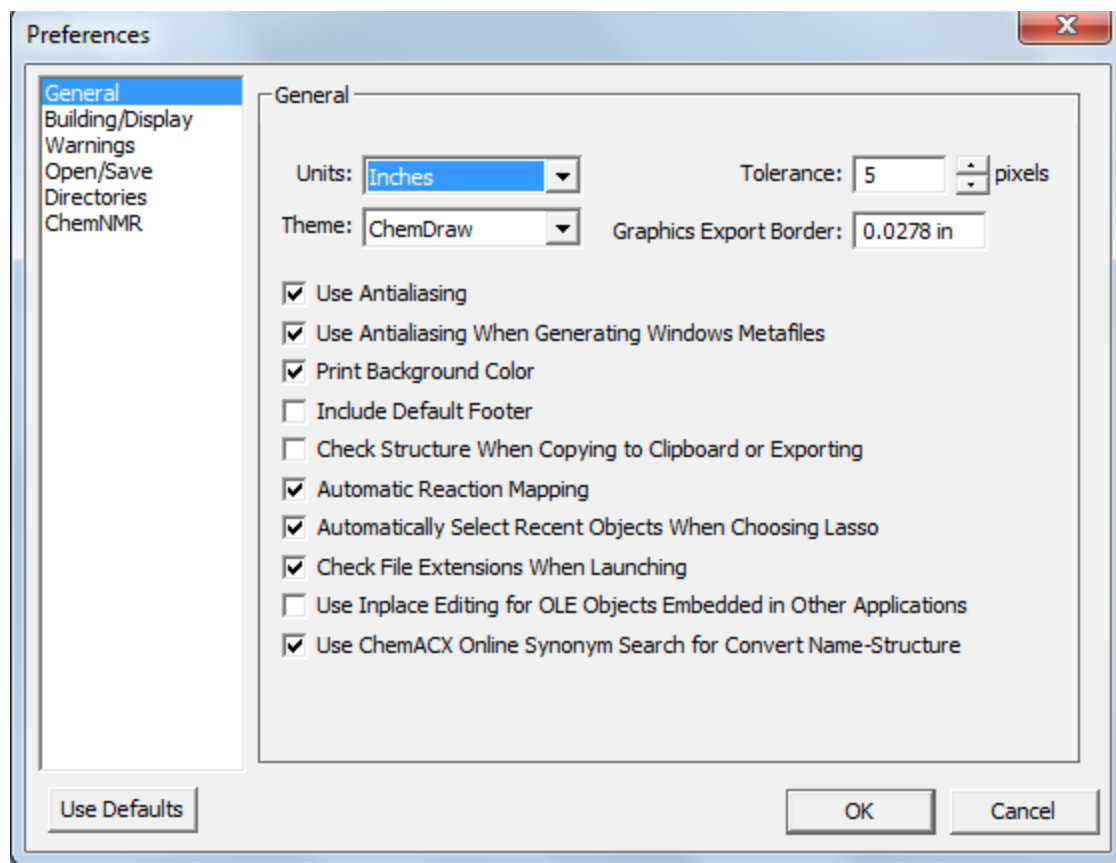

2. To restore the default settings, click **Use Defaults**.

Theme Options

The theme defines the appearance of the ChemDraw GUI but does not affect functions. By default, ChemDraw displays the ChemDraw theme. The theme ChemDraw Large has larger versions of the icons, which are more readable but will require larger screen real estate.

To change themes:

1. Navigate to **File>Preferences** and select the General tab.
2. Select a theme in the **Theme** drop-down list.
3. Click **OK**.

Default Document Location

You can set the default file directory for each time you open a file.

To set the default file directory:

1. Navigate to **File>Preferences**. The Preferences dialog appears.
2. Click the **Directories** tab.
3. Click the **Use Documents Location** check box and type in or browse to the location to use.

Default Open File Format

To set the default file format in the Open dialog box:

1. Navigate to **File>Preferences**. The Preferences dialog appears.
2. Click the **Open/Save** tab.
3. Click **Use Default File Format** in the **Opening Files** section, and choose the file format.

Configuration options for stereoflag

To display one general stereoflag label for the molecule (instead of stereoflag labels in individual stereo-centers) when opening MDL format files having absolute / relative / racemic stereochemistry setting, check the '**Show Stereoflags When Opening MDL Format Files**' option in the **Building/Display** tab of Preferences dialog.

To save the Enhanced Stereochemistry settings when saving to the SKC format, check the '**Use Enhanced Stereochemistry When Saving to SKC File Format**' option in the **Building/Display** tab of the Preferences dialog.

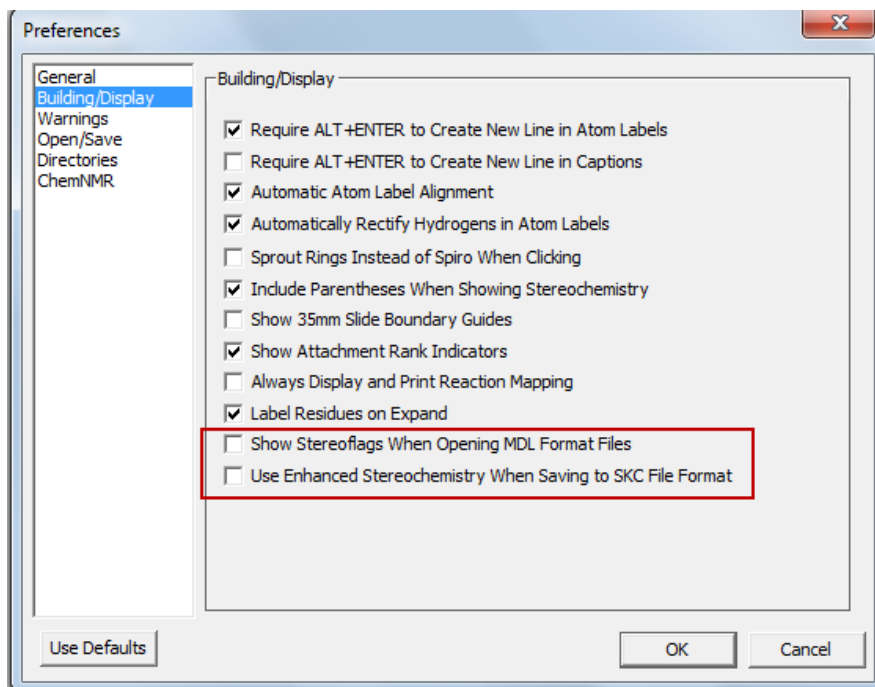

Setting the Default Tool

You can choose which tool is selected when you open documents.

1. Navigate to **File>Preferences**. The Preferences dialog appears.
2. Click the **Open/Save** tab.
3. Under **Opening Files**, select a tool.

New Lines and Closing Text Boxes

To create a new line in a caption text box press either <Enter> or <Return>. To create a new line in an atom label press <Alt>+<Enter>. To close the text box, click outside the text box or select another tool.

To change the default:

1. Navigate to **File>Preferences**.
2. Choose the appropriate option on the **Building/Display** tab, to change the default for:
 - Atom Label Text- Require <Alt>+<Enter> to create new line in Atom labels.
 - Caption Text- Require <Alt>+<Enter> to create new line in Captions.
3. Click **OK**.

Highlight Box Tolerance

Tolerance determines the size of the highlight box and how close you move the cursor to an object to activate it. The default setting for the Tolerance is 5 pixels. At this setting, the highlight box appears on bonds if the pointer is located 5 pixels or less from any point on the bond.

To set the tolerance:

1. Navigate to **File>Preferences**.
2. On the **General** tab, select or type the tolerance. This change affects all documents.

The ChemDraw Items Folder

The folder contains the preferences, hotkeys, nicknames, isotopes files, scripts, and the generic nicknames file. It also contains template documents and template Stationery Pads. You can have multiple ChemDraw Items folders. This is useful in corporate installations for maintaining personal files such as nicknames and standard templates. The location of the ChemDraw Items folder is based on your operating system. If you are using ChemOffice 2016, the folder is at:

C:\ProgramData\PerkinElmer\Informatics\ChemOffice2016\ChemDraw\ChemDraw Items

To add a path to a ChemDraw Items folder:

1. Navigate to **File>Preferences**. The Preferences dialog appears.
2. Click the **Directories** tab.
3. Click **Add New**, browse to a location, and click **OK**. A new path is added to the list.
4. To rearrange the search order, click **Move Up** and **Move Down**.
5. To delete a path, click **Remove**. To delete all added paths, click **Default Paths**.

Default Styles

ChemDraw saves default styles as a style sheet. When you launch ChemDraw, the last style sheet you use opens as the default. If you choose different one, that file becomes the default.

You can set a default that is not changed:

1. Navigate to **File>Preferences**.
2. On the Open/Save tab, browse to the default style sheet.
3. Deselect **New from Any Style Sheet Changes Default**.
4. Click **OK**.

To view the default style, click the **File** menu. The **New** menu item displays the name of the Style Sheet.

Saving Customized Styles

Every new document you create uses a style sheet file for its document settings. These files can also contain pre-defined objects. When you create a new document, you actually create an untitled copy of the style sheet. Changes you make to the copy do not affect the file.

You can create a style sheet with your own customized setting by saving it as a CDS file. If you store the CDS file in the ChemDraw Items folder, it appears in the Open Templates menu (under the File menu).

To save a document's setting as a style sheet:

1. Navigate to **File>Save As** The Save As dialog appears.

2. Name the file and change the type (in OS X: format) to CD Style Sheet (cds)
3. Click **Save**.

Customizing Toolbars

The look and arrangement of toolbars are defined by a set of XML files. If you are familiar with editing XML files, you can modify the toolbar for the way you work. You can remove, rename, and resize buttons; change button icons, or move them from one toolbar to another. You can also create or delete toolbars.

The Toolbar Schema

The Toolbars.xsd file contains the schema definitions for all the toolbars. These include definitions (but not the content) for the toolbars, the pop-up text, and the status bar text.

The Toolbar XML Files

The Toolbars directory at `C:\ProgramData\PerkinElmerInformatics\ChemOffice2016\ChemDraw\GUI\Common\XML\Toolbars`, contains the subdirectory where the toolbars xml files are stored. The files are stored according to the skins in which they are used. These are the files you will most commonly edit to customize the toolbars. The XML file when launched, validates itself against the Toolbars.xsd file stored online.

Editing the XML Files

You can edit the files using any xml or text editor. After you save the files, exit and restart ChemDraw. Your changes will take effect.

Create a backup of all XML files you intend to edit.

 **Note:** All images files you use as icons must be in .png format.

Document and Object Settings

You can apply document and object settings to the current document. The changes you specify in the document settings are applicable only within the document and are not applicable throughout the application. The changes you specify in the object settings are specific to the selected object.

Settings include:

Drawing settings. Set drawing options such as the fixed length used to draw bonds.

Caption and label text settings. Set text options such as the font used for atom labels and captions.

Color settings. Set available colors for objects and the document background.

Print/Page Setup. Set options such as the page size used and text displayed in footers.

You can apply document settings in the following ways:

- Customize settings for the entire document using the Document Settings dialog.
- Apply settings to the entire current document from an existing document.
- Apply settings to selected objects in the current document from an existing document.

Drawing Settings

Drawing settings affect how bonds and other objects are drawn. You can configure the drawing settings for an entire document or for a particular object as follows:

- For the entire document, navigate to **File>Document Settings** and select the **Drawing** category.
- For an object, use the **Object Settings** dialog box.

Changes you make to the drawing settings affect the active document window only. You can save drawing settings in style sheets.

To apply settings from other documents to your document, navigate to **File>Apply Document Settings**.

The various options available under **Drawing** category includes:

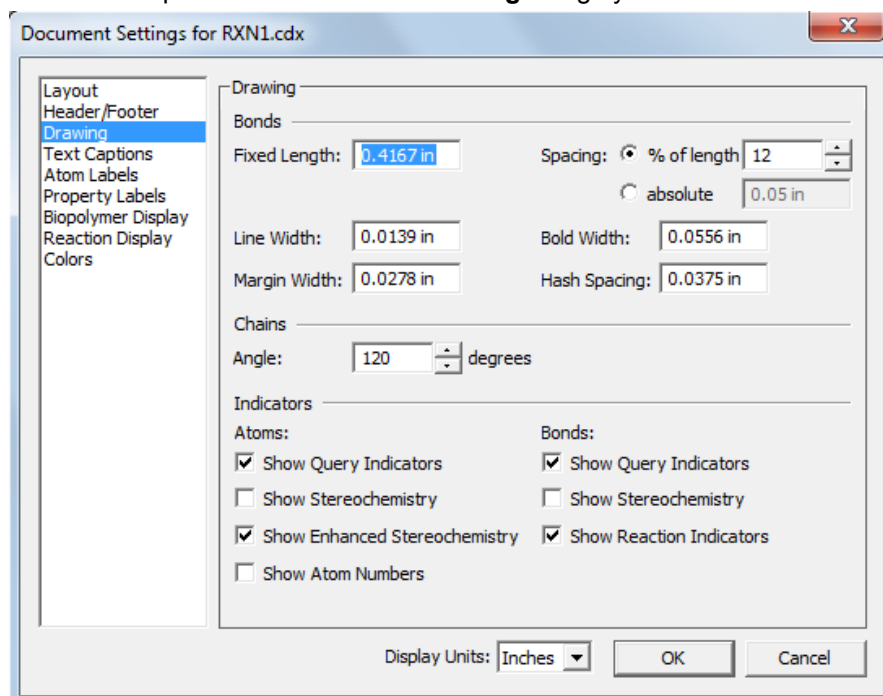

Fixed Length. Constrain the bonds drawn to the length you specify. This also adjusts the preferred bond length when you use the Clean Up Structure command. See ["Drawing Fixed Length Bonds" on page 61](#) and ["Attachment Points" on page 128](#).

Bond Spacing. Set the distance between the lines in double or triple bonds. The distance is set either as:

- The percent of the length of the bond (between 1 and 100). This allows for proportional spacing if different bond lengths are used.

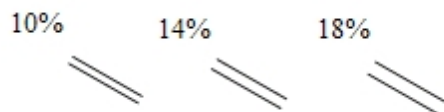

- An absolute value you choose in the units specified for your document.

Bold Width. Set the width of the line used when bold and wedge bonds are drawn. The Bold Width setting must be greater than the Line Width setting. The end of a wedge is 1.5 times the bold width.

Line Width. Set the width of all bonds, lines, and arrowheads in the drawing.

Margin Width. Change the amount of space surrounding all atom labels that will erase portions of the bonds to which they are attached. The margin width also determines the amount of white space surrounding the front bonds in a bond crossing. See ["Bond Crossing" on page 60](#).

Hash Spacing. Set the spacing between the hashed lines used when wedged hashed bonds, hashed bonds, dashed bonds, dashed arrows, or dashed curves are drawn.

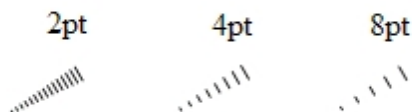

Chain Angle. Set the angle (from 1 to 179 degrees) between bonds created by the Acyclic chain tool or modified by the Clean Up Structure command. See ["Chains" on page 75](#) and ["Attachment Points" on page 128](#).

Units. Set the units used in the Object Settings dialog box to centimeters, inches, points, or picas.

Atom and Bond Indicators. Set which indicators to display. See ["Atom Numbering" on page 130](#).

Configuring Documents

1. Navigate to **File>Document Settings**.
2. Click the **Drawing** category and configure the settings.
3. Click **OK**.

Terminal Carbon Labels

By default, ChemDraw does not display terminal carbons.

To display terminal carbon labels:

1. Navigate to **File>Document Settings**.

2. Select the **Atom Labels** category.
3. Select **Show Labels On Terminal Carbons**. See figure below:

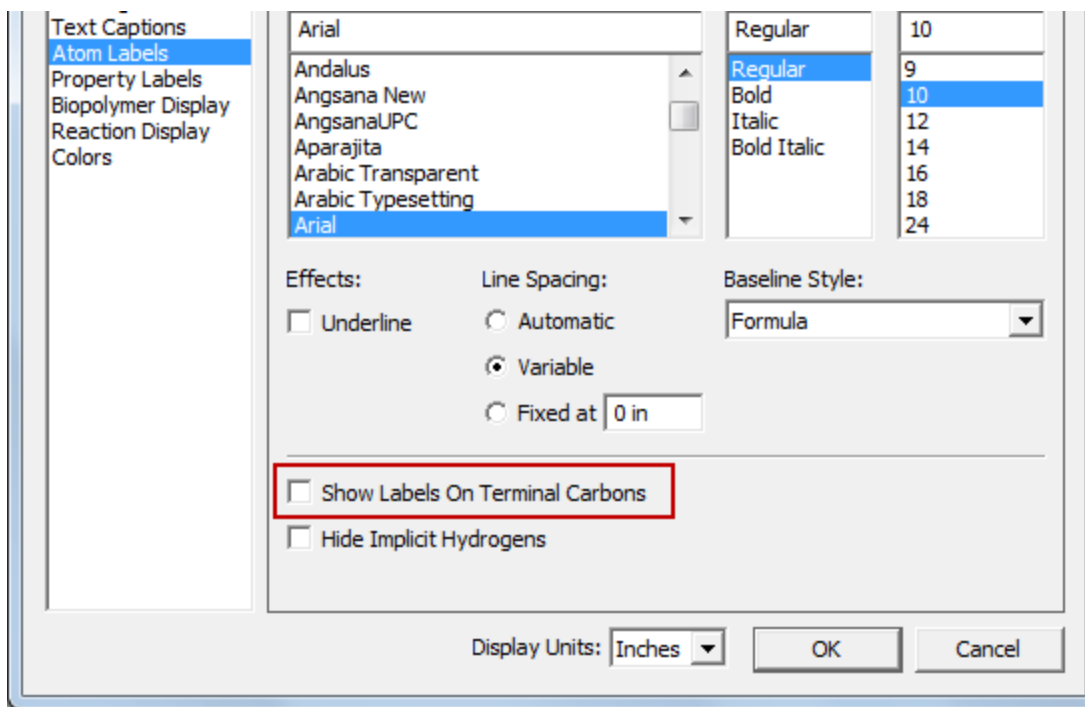

Configuring Objects

To configure the drawing settings for a selected object:

1. Select the object.
2. Navigate to **Object>Object Settings**.
3. Configure the settings and click **OK**. The settings you chose are applied only to the selected object.

Analysis and Properties

You can paste fundamental structure properties into your drawing. You can also rename these properties when desired. For instance, you may consider renaming “Molecular Weight” to “MW” to save room on the page. The changes you make apply only to the properties you paste in your drawing. The names in the Analysis and Chemical Properties dialog boxes remain unaffected.

To change the names of the properties:

1. Navigate to **File>Document Settings**.
2. Select the **Property Labels** category. See figure below:

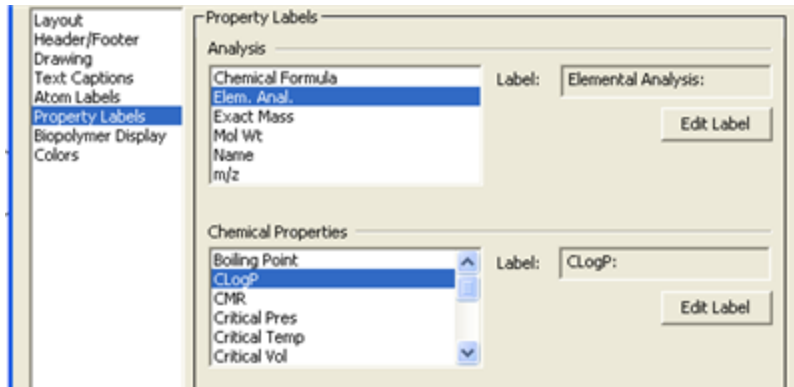

3. In the Analysis window, select the property to rename.
4. Click **Edit Label** and type a new name in the **Edit Label** text box. Click **OK**.
5. Type the new name, and click **OK**.
6. Repeat step 4 for other properties.
7. Click **OK**.

Formatting Captions

Text settings affect how captions and atom labels for the current document are drawn and formatted.

Formatting options include:

- Font (font type)
- Size (font size)
- Style (font and baseline style)
- Line spacing
- Alignment

Setting Font Parameters

Changing text formats in the Document Settings dialog affects the current document only. You can also change settings for individual objects by using the Object Settings dialog, the Text menu, or the Style toolbar.

To edit the document text settings for captions and atom labels:

1. Click **File>Document Settings**.
2. In the **Document Settings** dialog, click **Text Captions** or **Atom Labels**.
3. Change the settings as desired. The options are described in the following sections.
4. Click **OK**. The formatting is applied to the current document.

Setting the Baseline Style

You can specify these baseline styles:

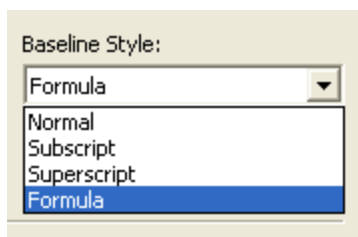

Normal. Use this for standard text.

Superscript. Reduces the text size by about 25 percent and raises its baseline.

Subscript. Reduces the text size by about 25 percent and lowers the baseline.

Formula. Formats in a way that is appropriate for most chemical formulas, that is, numbers are subscripted. You must, however, manually capitalize.

You can also apply multiple styles to different portions of a single caption.

Style Indicators

Select any text in the document window and navigate to **Text>Style** to view the styles that have been applied. A check indicates the style applies to all the selected text. A hyphen indicates the style applies to some of the selected text.

Specifying Line Spacing

You can specify these types of line spacing:

Automatic. Consistently spaced lines of text based on the height of the tallest character in the caption. This is the default line spacing.

Variable. Lines of text with different spacing based on the tallest character and the lowest descender in each line.

Fixed. Consistently spaced lines using a spacing that you specify.

Aligning Text

You can align captions and atom labels to justify text to suit your needs. The options available depend on whether you are aligning captions or atom labels. Apply settings in the Object Settings dialog.

To open the object settings dialog:

1. Select a caption or atom label.
2. Navigate to **Object>Object Settings**. The Object Settings dialog appears.

Captions

You specify the caption justification and line spacing on the Text Captions tab of the Object Settings dialog. All text in a single caption must have the same justification and line Spacing.

There are four available justifications:

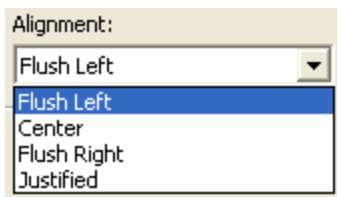

Flush Left. Creates left-justified caption text.

Centered. Creates centered caption text.

Flush Right. Creates right-justified caption text.

Justified. Creates right-left justified caption text.

Atom Labels

Use the **Centered**, **Flush Left**, **Flush Right**, **Stacked Above**, or **Automatic** justifications to create labels that identify atoms and functional groups in your chemical structure without obscuring bonds or other atom labels.

 **Note:** When using *Stacked Above* justification, enter the tokens from top to bottom using <alt>+<enter> to go to a new line. If you change the justification after the label is entered, a warning may appear.

 **Note:** In accordance with IUPAC guidelines, when using *Flush right*, for an atom label with a left pointing bond, the bond will attach to the rightmost atom of the label (for example, F_3C- will attach to the carbon, CF_3- will attach to one of the fluorines. The latter may cause a red warning box to display as the fluorine valence is now violated). An exception to this is when hydrogens are additional atoms, where CH_3- and H_3C- will both be attached to the carbon because ChemDraw treats hydrogens differently than other elements. Preferably use *Automatic Alignment* (see below) to ensure the label accurately reflects the intended chemically correct label.

Examples of the atom label justifications are shown below.

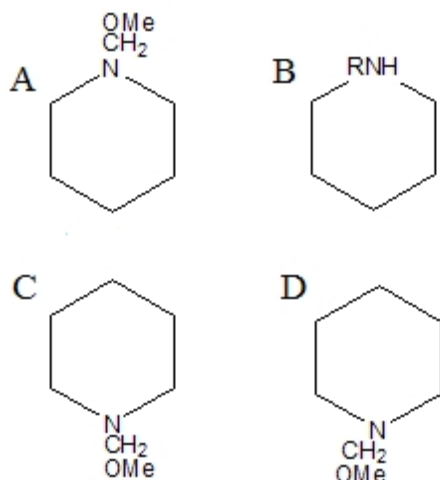

Figure 4.1: Atom label justification. A) stacked above; B) centered; C) flush left; D) flush right.

Automatic Alignment

When you justify atom labels automatically, ChemDraw breaks the label into tokens. A token consists of an uppercase letter followed by any numbers or lowercase letters. The first token is attached to the atom and the rest of the label appears without obscuring other parts of the chemical structure.

For example, to create N-methylpiperidine, label an atom in cyclohexane as NCH₃. This label has three tokens, N, C and H₃. If you label C3, the tokens are placed from left to right because there are bonds to the left of the atom.

If you label C5, the tokens appear from right to left because there are bonds to the right of the atom:

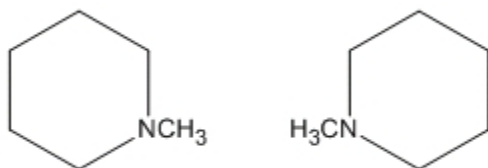

You can force an entire multi-atom label to be a token by defining it as a nickname. This prevents the label from flipping when applied to the left side of a structure.

For example, if you define the nickname CH₃, and label C5 with the combined label and nickname NCH₃, the final orientation is CH₃N instead of H₃CN. In this case, the nickname, CH₃, is a token.

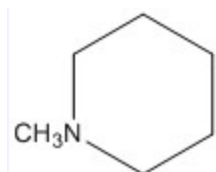

If you label C1, the second and third tokens are placed above the first token since there are bonds below the atom.

If you label C4, the second and third tokens are placed below the first token.

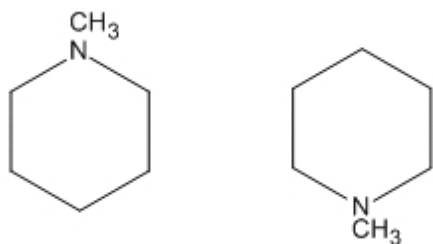

Changing Default Formats

Each new caption or atom label uses default document settings for the font, font-size, and style of captions and atom labels.

You can change the format by:

- Changing the document settings for subsequent drawings in the current document.
- Choosing a new format for an individual caption or label from the Text menu or toolbar before you type.
- Selecting text and applying a new format to an individual label after you type.

Settings for New Text

To specify the text settings for new captions and atom labels in the current document:

1. Navigate to **File>Document Settings**.
2. Click **Text Captions** or **Atom Labels** in the Document Settings dialog.
3. Select the appropriate options.
4. Click **OK**.

These settings affect all new captions or atom labels in the current document. To use these settings in new documents, save them in a style sheet

. For more information, see "[Document and Object Settings](#)" on page 26.

Formatting a Caption or Label

You can set the text format for an individual caption or atom label before you type. The format change is applied only to the current text.

To set the text format before you type:

1. Select the Text tool and click in the document window. A text box appears.
2. To set the text format do one of the following:
 - Navigate to **Text> Font, Style** or **Size**.
 - Set the format options on the Style toolbar.
3. Type the text in the text box.

The format is applied to the typed text. Subsequent text you type uses the default document settings.

Changing Text Setting

You can change the text settings for a selected caption or atom label. You can choose to have the settings applied to the selected text and to all subsequent text you type.

To change the text settings for a selected caption or atom label:

1. Select the text to change with a selection tool.
2. Set the appropriate options on the **Text** menu.

To change part of a caption, select the part you want to change using the Text tool.

To specify a font and size for selected text, do one of the following:

- Choose the font and size from the Text menu.
- Right-click and choose the font and size from the context menu.

- Select the font and font-size from the drop-down list on the Style Toolbar.

Specifying the margin width

You can adjust the white space surrounding the atom label so that some of the attached bond is hidden.

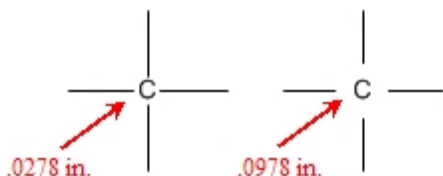

To adjust the white space:

1. Go to **File>Document Settings**. The Document Settings dialog box appears.
2. Click the **Drawing** tab.
3. Type a new **Margin Width** value.
4. Click **OK**.

The margin width is applied to all subsequent drawings in the current document.

Settings from other documents

To apply document settings to the active window that are contained in a different document, go to **File>Apply Document Settings from** and choose the document from which to apply the settings.

The settings in the active document window change to those found in the style sheet that you choose.

 **Note:** *Applied settings are for the current document only. To make them the default settings for all documents you open, go to **File>Open Style Sheets**.*

To apply the document settings from a document or style sheet not listed in the menu:

1. Go to **File>Apply Document Settings from>Other**. The select document dialog box appears.
2. Open the appropriate folder and select a document or Style Sheet.
3. Click **Open**.

Applying object settings

You can apply settings from another document to selected objects in the current document. You can apply the chosen settings to the selected objects, or to all new objects drawn in the current document.

To apply object settings:

1. Select the object.
2. Go to **Object>Apply Object Settings from** and choose the document from which to apply the settings. A dialog box appears.

3. Do one of the following:

- To selected object only, click **No**.
- To selected object and any new objects you draw, click **Yes**.

Biopolymer settings

You can specify how the sequences and residues appear in either the entire document or for a specific sequence, as follows:

- For the entire document, go to **File>Document Settings** and select the **Biopolymer Display** tab.
- For an object, use the **Object Settings** dialog box.

In the biopolymer Display tab, select from these options:

Residues per line. specify the number of residues to be displayed in each line of the sequence.

Residue per block. specify the number of residues to be displayed in each block of the sequence.

Amino-acid Termini. Set either **NH₂/COOH** or **H/OH** as the termini in the sequence.

 **Note:** *When the termini are displayed using the NH₂/COOH style, the underlying atoms are actually H and OH. The labels are intended to convey whether the N or C terminus is present. Since this can be confusing or ambiguous, this display is not recommended, and is provided only for compatibility with other products.*

Customizing Hotkeys

If you are familiar with XML, you can edit the ChemDraw Hotkeys, or create your own.

To customize Hotkeys, open the Hotkeys.xml file in a text editor. There are two paths--depending on whether this is a **default installation** or a **custom installation**. The preferred method is to edit this file from a custom installation location.

- If a **Default Installation**, the path is:

Go > Applications > Right-click on ChemDraw > Choose Show Package Contents > Contents > Resources > SpecialPurpose > ChemDraw Items > Hotkeys.xml

- If a **Custom Installation**, the path is:

Custom location folder > ChemDraw Items > Hotkeys.xml

 **Note:** *It is safest to edit the Hotkeys.xml file from a custom installation location, rather than from the default installation location. Since when editing the Hotkeys.xml from the default installation location, this can affect the whole ChemDraw package content.*

The Hotkeys within the file are organized by object type:

- "Atom": Hotkeys that modify atoms.
- "Bond": Hotkeys that modify bonds.
- "AA1": Hotkeys that sets the label for the single letter amino acids.
- "DNA": Hotkeys that sets the label for the DNA sequence.

- "RNA": Hotkeys that sets the label for the RNA sequence.
- "Generic": Hotkeys that select tools and open dialog boxes.

Each Hotkey is encoded in this format:

```
<Hotkey key="{key}" command="{command}" value="{value}" description="{description}" />
```

Key

Key is the keyboard key that invokes the command. You can assign the same key to different functions as long as the functions are defined for different object types. For example, 'b' changes an atom to Boron in the `Atom` object type, a bond to bold in the `Bond` object type, and could be assigned to the Benzene tool in the `Generic` object type. You can use any key except the hard-coded keys: function keys, ENTER, SPACE, BACKSPACE, and arrow keys.

 **Note:** Hotkeys are case sensitive. For example, you can define the hotkeys "S" and "s" to different functions within an object type.

If a key appears more than once in the file for the same object type, the one closest to the end of the file takes precedence.

Command

Command is any one of the predefined command names. All available commands are described in the `hotkeys.xml` file. The command ID's are defined based on the object types as follows:

Object Type	Command ID	Description
Atom	LABELTEXT	Sets the label for the atoms text
	SPROUT	Addition of bonds to an atom
	CHARGE	Changes the charge of an atom
	FREE_SITE	Increment/decrement free sites of an atom
	UPTO_SITE	Increment/decrement the UpTo number of substituents of an atom
	EXACT_SITE	Increment/decrement the number of substituents of an atom
	ATOMNUMBER	Show/hide the atom numbers
Bond	ATTACHMENTPOINT	Sets the value of the attachment point
	BONDORDER	Sets the bond order
	BONDDISPLAY	Sets the bond display
	BONDPOSITION	Sets the position of bonds
	BONDDOUBLEPOSITION	Sets the alignment for double bonds
Generic	FUSERING	Fuses a ring to a bond
	DIALOG	Display a dialog
AA1	TOOLMODE	Changes the current tool
	AA1	Sets the label for the single letter amino acids

Object Type	Command ID	Description
DNA	DNA	Sets the label for the DNA sequence
RNA	RNA	Sets the label for the RNA sequence

 **Note:** You cannot add to the command list.

Value

This is the parameter value associated with the command. For example, if the command is LABELTEXT, the value is the label that appears. If the command is BONDDISPLAY, the value corresponds to the bond display type.

To create a hotkey that switches to a particular tool, choose TOOLMODE for a command and use any of these command names for a value:

LASSO	TLCPLATE
MARQUEE	BENZENE
3DTRACKBALL	CYCLOPENTADIENE
MASSFRAG	CYCLOHEXANECHAIR2
ERASER	CYCLOHEXANECHAIR1
TEXT	CYCLOOCTANE
SOLIDBOND	CYCLOHEPTANE
MULTIBOND	CYCLOHEXANE
DASHEDBOND	CYCLOPENTANE
PEN	CYCLOBUTANE
HASHEDBOND	CYCLOPROPANE
ARROW	TEMPLATE
HASHEDWEDGEDBOND	SNAKINGCHAIN
ORBITAL	ACYCLICCHAIN
BOLDBOND	QUERY
DRAWINGELEMENTS	TABLE
WEDGEDBOND	ARC
BRACKET	WAVYBOND
HOLLOWWEDGEDBOND	CHEMICALSYMBOLS

 **Note:** The features that are available depends on the level of ChemDraw you have.

Description

The tool description explains what each hotkey does.

Editing the Hotkeys.xml file

 **Note:** Ensure that "Smart Quotes" are disabled while editing hotkeys.

To edit ChemDraw hotkeys:

1. Open the **hotkeys.xml** file in a text editor.

2. Navigate to the appropriate hotkey list in the `hotkeys.xml` file.
3. Either add a new hotkey entry using the appropriate format and values or edit an existing hotkey in the list.
4. Save the `hotkeys.xml` file.
5. Exit and restart ChemDraw.

 **Caution:** Exercise caution when editing `hotkeys.xml` file, since if the formatting is incorrect, it will not be read, and some functions of ChemDraw may cease to work correctly. Make a back up the original copy of the file prior to making any changes.

Working with Color

You can create full color presentations of your chemical drawings to appear on your monitor, print on a color printer, or create 35mm slides using a film printer.

Most computers can display up to 16 million colors, but the number of colors may be limited by your monitor and display card.

What You Can Color

In ChemDraw, you can change the color of the background, foreground, or individual objects and elements:

Background color. The color of the document window. By default, the background is white.

Foreground color. The color of objects that you draw. By default, the foreground is black.

Individual objects. You can assign colors to objects to help them stand out from other objects.

Individual elements. You can assign colors to specific atoms or elements in a structure.

To change the background and foreground colors:

1. Navigate to **File>Document Settings** and select the **Colors** tab.
2. Select the background and foreground colors.
3. Click **OK**.

Color by Element

You can now color atom labels using colors associated with their atomic symbols. You can assign colors to elements in the periodic table. Whenever you use a particular element in your drawing, the element appears in same color you assigned to it in the periodic table.

To assign different colors to elements in a periodic table:

1. Navigate to **View>Show Periodic Table Window**. The periodic table appears.

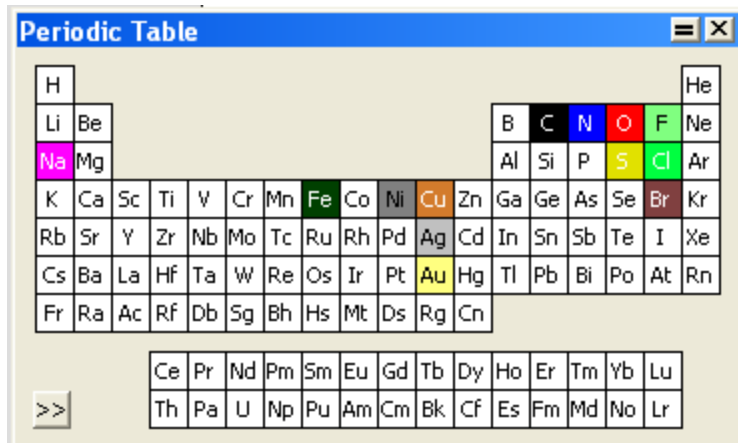

2. Double-click an element. The color palette appears.
3. Select a color and click **OK**.

 **Note:** The modified colors are saved when you exit ChemDraw.

To apply a color to a structure:

1. Select the structure.
2. Navigate to **Color>By Element**.

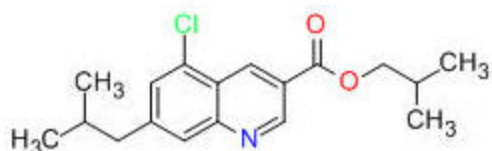

 **Note:** The atom colors are not dynamically set, hence changing the label does not reset the color.

The Color Palette

Use the color palette to specify the color of objects and text in the document in the active window. A palette is stored in every document and style sheet. You can use style sheets to create a series of documents with the same color scheme.

Customizing Colors

Changes you make to the color palette affect the current document only. You can save up to 20 colors. For more information, see "[Document and Object Settings](#)" on page 26.

 **Note:** If you select an object or group that contains multiple colors, a check mark appears next to each of the colors in the Color menu. The check mark alerts you that a change would affect more than one color.

To change the color palette in the current document:

1. Navigate to **File>Document Settings**. The Document Settings dialog appears.
2. Click the **Colors** tab.
3. Click the color to change (either background or foreground) and select **Other**. The Color dialog opens.
4. Click the new color in the **Basic Colors** or the **Custom Colors** section.
5. Click **OK**. The color changes to the new color and appears on the Color menu.

To add a customized color:

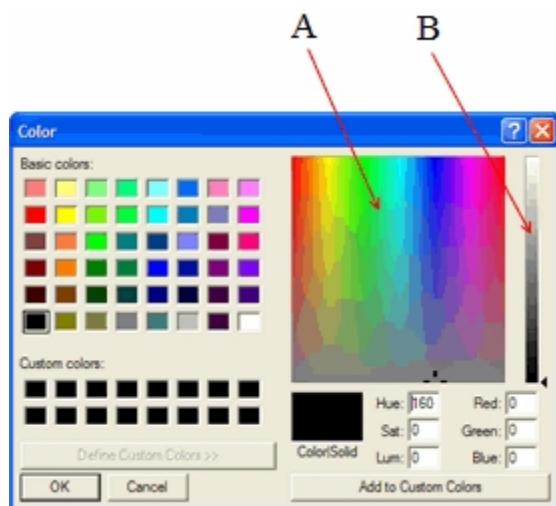

Figure 4.2: Setting custom colors. A) Color refiner box; B) Luminosity box.

6. Click a color in the Color Refiner box to set the hue and saturation.
The pointer turns into a cross hair when you click. You can drag to a different region to change the hue and saturation.
7. Click in the Luminosity box to set the color brightness.
8. If necessary, change the hue, saturation, luminosity, and RGB components by typing the values in the text boxes.
9. Click **Add to Custom Colors**.
10. Click **OK**.

Templates and Color

The background and foreground colors in a template from the template pop-up palette are not used when the template is drawn in a document window. However, other colors in the template are added to the color palette of the document if they are not already present. For more information, see ["Autoscaling" on page 280](#).

Saving Color Palette Settings

You can save the color palette in a style sheet. The color palette is saved with other document settings such as page setup settings, text settings, and drawing settings.

Printing Background Color

To change whether the background color is printed:

1. Navigate to **File>Preferences**.
2. Select or de-select **Print Background Color** on the General tab.
3. Click **OK**.

Document Settings

ChemDraw includes a library of document settings based on those found in many well-known scientific publications. For example, some journals may require submitted articles be formatted with specific margins, fonts, page size, and so on. If you plan to submit your document to a specific journal, open in ChemDraw the style sheet for that journal. You can also create style sheets of your own.

 **Note:** *The changes you make to the document settings is reflected only in the current document and is not available throughout the application.*

To create your own style sheet:

1. Create a new document.
2. Enter the settings in the Page Setup, Drawing, Text Settings, and Color palette dialog boxes.
3. Navigate to **File>Save As**.
4. In the Save As dialog box:
 - a. Select the ChemDraw style sheets file format.
 - b. Type a name for the document.
 - c. Save the template in the ChemDraw Items folder.
5. Click **OK**.

ACS Document 1996

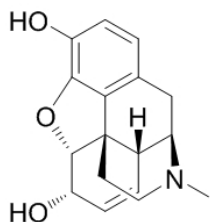

- Fixed Length: 14.4 pt
- Bold Width: 2 pt
- Line Width: 0.6 pt
- Margin Width: 1.6 pt
- Hash Spacing: 2.5 pt
- Chain Angle (degrees): 120
- Bond Spacing (% of length): 18
- Atom Label Font :
- Atom Label Size: 10 pt
- Caption Font :
- Caption Size: 10 pt
- Drawing Area (Width x Height): 540 pt x 720 pt

- Page Size: US Letter
- Reduction (%): 100

Adv. Synth Catal.

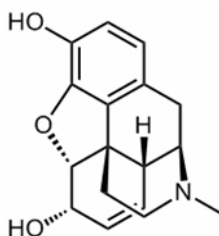

- Fixed Length: 17 pt
- Bold Width: 2 pt
- Line Width: 1 pt
- Margin Width: 1.6 pt
- Hash Spacing: 2.5 pt
- Chain Angle (degrees): 120
- Bond Spacing (% of length): 18
- Atom Label Font :
- Atom Label Size: 10 pt
- Caption Font :
- Caption Size: 12 pt
- Drawing Area (Width x Height): 540 pt x 720 pt
- Page Size: US Letter
- Reduction (%): 100

J.Chin. Chem. Soc.

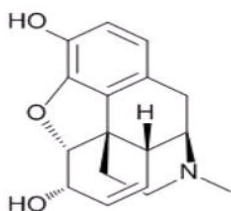

- Fixed Length: 18 pt
- Bold Width: 2.5 pt
- Line Width: 1 pt
- Margin Width: 2 pt
- Hash Spacing: 2.5 pt
- Chain Angle (degrees): 120
- Bond Spacing (% of length): 20
- Atom Label Font :
- Atom Label Size: 12 pt
- Caption Font :
- Caption Size: 12 pt
- Drawing Area (Width x Height): 693 pt x 918 pt
- Page Size: US Letter
- Reduction (%): 80

J. Mol. Mod. (1 column)

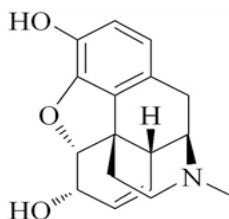

- Fixed Length: 14.4 pt
- Bold Width: 2 pt
- Line Width: 0.6 pt
- Margin Width: 1.6 pt
- Hash Spacing: 2.5 pt
- Chain Angle (degrees): 120
- Bond Spacing (% of length): 18
- Atom Label Font: Times New Roman
- Atom Label Size: 10 pt
- Caption Font: Times New Roman
- Caption Size: 10 pt
- Drawing Area (Width x Height): 8.5 cm x 25.4 cm (1 column); 17 cm x 25.4 cm (2 column)
- Page Size: US Letter
- Reduction (%): 100

New Document

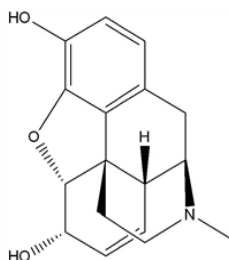

- Fixed Length: 30 pt
- Bold Width: 2 pt
- Line Width: 1 pt
- Margin Width: 2 pt
- Hash Spacing: 2.7 pt
- Chain Angle (degrees): 120
- Bond Spacing (% of length): 12
- Atom Label Font :
- Atom Label Size: 10 pt
- Caption Font :
- Caption Size: 12 pt
- Drawing Area (Width x Height): 7.5 in x 10 in
- Page Size: US Letter or A4 (as selected)
- Reduction (%): 100

New Slide

- Fixed Length: 30 pt
- Bold Width: 4 pt
- Line Width: 1.6 pt
- Margin Width: 2 pt
- Hash Spacing: 2.7 pt
- Chain Angle (degrees): 120



Phytomedicine

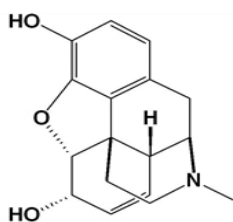

RSC

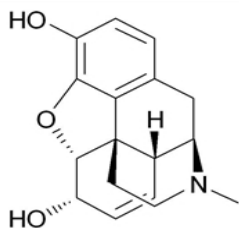

- Bond Spacing (% of length): 15
- Atom Label Font :
- Atom Label Size: 12 pt
- Caption Font :
- Caption Size: 16 pt
- Drawing Area (Width x Height): 7.5 in x 10 in
- Page Size: US Letter
- Reduction (%): 100

- Fixed Length: 20 pt
- Bold Width: 1.33 pt
- Line Width: 1pt
- Margin Width: 1.25 pt
- Hash Spacing: 3 pt
- Chain Angle (degrees): 120
- Bond Spacing (% of length): 8
- Atom Label Font :
- Atom Label Size: 12 pt
- Caption Font :
- Caption Size: 12 pt
- Drawing Area (Width x Height): 540 pt x 720 pt
- Page Size: US Letter
- Reduction (%): 100

- Fixed Length: 0.43 cm
- Bold Width: 0.056 cm
- Line Width: 0.016 cm
- Margin Width: 0.044 cm
- Hash Spacing: 0.062 cm
- Chain Angle (degrees): 120
- Bond Spacing (% of length): 20
- Atom Label Font :
- Atom Label Size: 9 pt
- Caption Font :
- Caption Size: 9 pt
- Drawing Area (Width x Height): 8.9 cm x 25.4 cm (1 column); 19 cm x 27.7 cm

- Page Size: US Letter
- Reduction (%): 100

Science of Synthesis

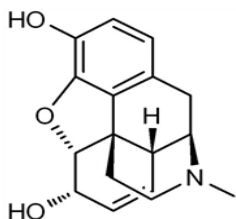

- Fixed Length: 17 pt
- Bold Width: 2 pt
- Line Width: 0.8 pt
- Margin Width: 2.25 pt
- Hash Spacing: 2.5 pt
- Chain Angle (degrees): 120
- Bond Spacing (% of length): 18
- Atom Label Font :
- Atom Label Size: 10 pt
- Caption Font :
- Caption Size: 10 pt
- Drawing Area (Width x Height): 19.79 cm x 27.15 cm
- Page Size: A4
- Reduction (%): 100

Synthesis, Synlett

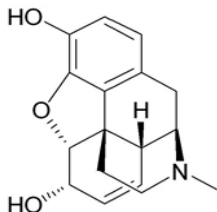

- Fixed Length: 17 pt
- Bold Width: 2 pt
- Line Width: 0.8 pt
- Margin Width: 1.3 pt
- Hash Spacing: 2.5 pt
- Chain Angle (degrees): 120
- Bond Spacing (% of length): 18
- Atom Label Font :
- Atom Label Size: 10 pt
- Caption Font :
- Caption Size: 10 pt
- Drawing Area (Width x Height): 12 cm x 26.7 cm
- Page Size: A4
- Reduction (%): 100

Verlag Helvetica Chimica Acta

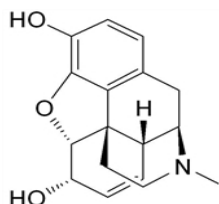

- Fixed Length: 17 pt
- Bold Width: 2.9 pt
- Line Width: 0.54 pt
- Margin Width: 2 pt
- Hash Spacing: 2 pt
- Chain Angle (degrees): 120
- Bond Spacing (% of length): 14
- Atom Label Font :
- Atom Label Size: 10 pt
- Caption Font :
- Caption Size: 12 pt
- Drawing Area (Width x Height): 368 x 720 pts
- Page Size: US Letter
- Reduction (%): 100

Wiley Document

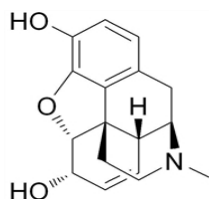

- Fixed Length: 17 pt
- Bold Width: 2.6 pt
- Line Width: 0.75 pt
- Margin Width: 2 pt
- Hash Spacing: 2.6 pt
- Chain Angle (degrees): 120
- Bond Spacing (% of length): 18
- Atom Label Font :
- Atom Label Size: 12 pt
- Caption Font :
- Caption Size: 12 pt
- Drawing Area (Width x Height): 19.79 x 27.15 cm
- Page Size: A4
- Reduction (%): 100

Shortcuts and Hotkeys

Hotkeys are organized into atom labels, bond types, and functions (such as adding a charge or displaying a bond). Shortcuts are organized by the menu on which the command is found.

 **Note:** You can modify hotkeys and nicknames. The tables in this section refer to the default values.

Atom Keys

Use atom keys to insert atoms in a drawing using your keyboard. For example, place your mouse over an atom and press <3> to add a tert-butyl group.

Atom Label	Key
A	a
F	f
Ph	P or 4
Ac	A or 5
H	h
Q*	q
Br	b
I	i
R	r
n-Bu	1
K	k
S	s
s-Bu	2
Me	m
Si	S
t-Bu	3
N	n
TMS	t

Atom Label	Key
C	c
Na	N
X	x
Cl	C or l
O	o
COOCH3	E
D	d
OTs	T
CH2OH	6
Et	e
P	p
B	B

Bond Hotkeys

To modify a bond, place your mouse over the bond and select a key listed below.

Function	Key
Change to single bond	1
Change to dashed bond	d
Change to double bond	2
Change to wavy bond	y
Change to triple bond	3
Position a double bond to the left	l
Change to quadruple bond	4
Center a double bond	c
Change to bold bond	b

Function	Key
Position a double bond to the right	r
Change to wedged bond	w
Bring bond to front	f
Change to hashed bond	H
Open a bond properties text box	/ (slash) or ?
Change to hashed-wedged bond	h
Fuse 5 membered ring	5
Fuse 6 membered ring	6
Fuse 7 membered ring	7
Fuse 8 membered ring	8
Create chair form of cyclohexane with two different orientations	9 or 0

Function Hotkeys

To apply function hotkeys, place your mouse over an atom and press the appropriate key.

Function	Key
Add an attachment point	. (period)
Add an atom number	' (single quote)
Add a negative charge	-
Add a positive charge	+
Sprout one bond	0
Sprout two bonds	9
Sprout three bonds	8
Display the Atom Properties dialog box	/ (slash) or ?
Display the Choose Nickname dialog box	= (equals)

Function	Key
log box	
Open an atom label text box	<Enter>
Remove an atom label	<Backspace>, <Delete> or <space>

Shortcuts

Below is a list of key combinations for common tasks.

File

Command	Key Combination
Create a new document	CTRL+N
Open a document	CTRL+O
Save a document	CTRL+S
Save a document as	SHIFT+CTRL+S
Print a document	CTRL+P
Page setup	SHIFT+CTRL+P
Close a document	CTRL+W
Exit ChemDraw	ALT+F4

Edit

Command	Key Combination
Cut	CTRL+X
Copy	CTRL+C
Copy as CDXML	CTRL+D
Paste	CTRL+V
Select all	CTRL+A
Undo	CTRL+Z

Command	Key Combination
Redo	SHIFT+CTRL+Z
Repeat last command	CTRL+Y
Clear	Clear
Copy as SMILES	ALT+CNTRL+C
Copy as MOL text	ALT+SHIFT+CNTRL+O
Paste as SMILES	ALT+CNTRL+P
Paste as MOL/CDXML	ALT+SHIFT +CNTRL+P

View

Command	Key Combination
Actual size	F5
Reduce	F8
Magnify	F7
Fit to window	F6
Toggle ruler	F11
Toggle crosshair	CTRL

Object

Command	Key Combination
Toggle fixed length	CTRL+L
Toggle fixed angles	CTRL+E
Select multiple objects	SHIFT+Click (with Lasso, Marquee, or Structure Perspective tools)
Group selected objects	CTRL+G
Ungroup objects	SHIFT+CTRL+G
Join selected objects	CTRL+J

Command	Key Combination
Bring to front	F2
Send to back	F3
Flip horizontal	SHIFT+CTRL+H
Flip vertical	SHIFT+CTRL+V
Rotate 180° horizontal	ALT+SHIFT+CTRL+H
Rotate 180° vertical	ALT+SHIFT+CTRL+V
Rotate... (opens Rotate Objects dialog)	CTRL+R
Scale...(opens Scale Objects dialog)	CTRL+K
Align left edges	ALT+SHIFT +CNTL+L
Align centers	ALT+SHIFT +CNTL+C
Align right edges	ALT+SHIFT +CNTL+R
Align top edges	ALT+SHIFT+CNTL+T
Align center towards top/bottom	ALT+SHIFT+CNTL+M
Align bottom edges	ALT+SHIFT+CNTL+B

Structure

Command	Key Combination
Clean up structure	SHIFT+CTRL+K
Convert name to structure	SHIFT+CTRL+N
Convert structure to name	ALT+CTRL+N

Text

Command	Key Combination
Flush left	SHIFT+CTRL+L

Command	Key Combination
Center	SHIFT+CTRL+C
Flush right	SHIFT+CTRL+R
Justified	SHIFT+CTRL+J
Automatic justification	SHIFT+CTRL+M
Plain	CTRL+T
Bold	CTRL+B
Italic	CTRL+I
Underline	CTRL+U
Formula	CTRL+F
Subscript selected character, or next character typed	F9 (in a label)
Superscript selected character, or next character typed	F10 (in a label)
Adds a degree sign (°)	ALT+248 (in a label)

Drawing

Command	Key Combination
Copy a selected object	CTRL+drag
Copy a selected object (constrained to X and Y axes)	SHIFT+CTRL+drag
Distort (limit resize to X or Y axis)	SHIFT+drag (with resize handle)
Toggle the Lasso and the previous drawing tool	CTRL+ALT+Tab
Change direction of a chain	CTRL+Drag (with alkane chain tool)
Change orientation of double bonds	SHIFT+Click (with saturated double-bond ring tools)

Command	Key Combination
Create resonance delocalized ring	CTRL+Click (with ring tools except chairs)
Remove a curve segment	ALT+SHIFT+Click (with the pen tool)

Nicknames

Ac	Bz	c-C7H13	cyclopropyl	DPIPS	i-C4H9
Ad	BOM	c-C8H15	Cys	DPTBS	i-C5H11
Ala	Bs	c-Hx	Dan	DTBMS	i-Pr
Alloc	Bt	C10H20	DEAE	DTBS	Ile
Allyl	Btm	C10H21	DEIPS	Et	Im
Am	Bu	Cbz	DMIPS	Fmoc	Leu
Arg	Bzh	cHx	DMPM	Gln	Lys
Asn	Bzl	CoA	DMPS	Glu	m-C6H4
Asp	BzOM	Cy	DMTr	Gly	m-Phenylene
Benzoyl	c-C3H5	cyclobutyl	DNP	His	m-Tolyl
Benzyl	c-C4H7	cycloheptyl	Dnp	i-Am	MDIPS
Bn	c-C5H9	cyclooctyl	Dns	i-Bu	MDPS
Boc	c-C6H11	cyclopentyl	DNS	i-C3H7	Me

MEM	n-Pr	Phenyl	s-Butyl	TBDMS	Thr
Mes	N3	Pht	s-C4H9	TBDPS	TIPDS
Met	neo-Am	Piv	s-C5H11	TBMPS	TIPS
MMTr	neo-C5H11	PMB	SEM	TBS	TMS
MOM	Np	PMBM	Ser	TDS	Tos

MPM	o-C6H4	PNB	SES	Tf	trans-Cin- namyl
Ms	o-Phenylene	Poc	t-Am	Tfa	Troc
MTM	o-Tolyl	PPI	t-BOC	TFA	Trp
n-Am	p-C6H4	Pr	t-Boc	Thexyl	Trit
n-Bu	p-Phenylene	Pro	t-Bu	THF	Ts
n-C3H7	p-Tolyl	Pv	t-Butyl	Thf	Tyr
n-C4H9	Ph	s-Am	t-C4H9	THP	Val
n-C5H11	Phe	s-Bu	t-C5H11	Thp	Xyl

Basic Drawings

ChemDraw provides a variety of tools for drawing everything from simple chemical structures to complex reactions. In this section, we introduce basic techniques to help you create your first structures. We also explain how to add features, such as arrows and shapes, to enhance structures and reactions. For more drawing features, see ["BioDraw \(Professional Level only\)" on page 98](#) and ["Advanced Drawing Techniques" on page 124](#).

Bonds

The Main toolbar and Multiple Bonds toolbar offer numerous options for drawing bonds. Some tools are for drawing specific types of bonds, while others are for drawing structures for database queries. For additional information on various bond types, see ["Bond Conventions" on page 301](#).

Drawing Bonds

To draw the first bond of your structure, select the solid bond tool in the Main toolbar and click in the document window. The bond appears in the drawing window. To draw another bond attached to the first, click either end of the first bond. The second bond appears in the drawing window, as shown below.

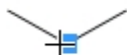

Figure 6.1: Adding a bond to an atom

You can draw a bond in any direction. Using a bond tool, click and drag from an existing atom or an empty area in the document window. The bond is drawn in the direction you drag the cursor.

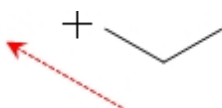

Figure 6.2: Adding a bond by dragging

Double Bonds

There are five ways to draw a double bond:

- Draw a bond using the Double bond tool.
- Draw a single bond over an existing single bond.
- Using any bond or selection tool, point to an existing bond and type '2'. See ["Shortcuts and Hotkeys" on page 48](#).
- Right-click any bond and select **Double>Plain** in the context menu.
- Use the single bond tool and click once on any single bond to make it a double bond. Subsequent clicks will reposition the two lines representing the bond.

Double Either Bonds

Double either bonds, or crossed double bonds, indicate unspecified double bond configuration, or a mixture of con-

figurations. To draw a double either bond, use the double either bond tool  from the Multiple Bonds toolbar, or:

1. Draw a bond using the Wavy Bond tool.
2. Click the center of the bond to create a double bond.
3. Click again to create a double either bond.

Triple Bonds

There are three ways to draw a triple bond:

- Draw a bond using the Triple Bond tool.
- Using the Solid, Dashed, or Bold Bond tool, drag from one end of an existing double bond to the other end.
- Using any bond, or selection tool, point to an existing bond and type '3' on your keyboard.

Quadruple Bonds

There are three ways to draw a quadruple bond:

- Draw a bond using the Quadruple Bond tool.
- Using the Solid, Dashed, or Bold Bond tool, drag from one end of an existing triple bond to the other end.
- Using any bond or selection tool, point to an existing bond and type '4' on your keyboard.

To change a quadruple bond into a single bond:

1. Select any bond tool.
2. Drag from one end of an existing quadruple bond to the other.

You can also draw multiple bonds by right-clicking a bond and selecting the bond type from the shortcut menu, using the bond properties dialog, or using Hotkeys. See ["Bond Properties" on page 249](#).

 **Note:** To reduce the bond order, select the Eraser tool and click the bond.

Dative Bonds

Dative bonds are a specific type of covalent bond in which the pair of electrons shared by the atoms in the formation of a bond is contributed by one of the atoms only. The atom contributing the pair of electrons is known as "donor" while the atom which does not contribute, but shares the pair of electrons, is referred to as "acceptor".

To draw a dative bond:

1. Select the Dative Bond tool.
2. Drag from the positive to the negative end (arrow head) of the dative bond.

Dative bonds are drawn with a fixed orientation in a document window.

To change the orientation of a dative bond:

- Click the bond using the dative bond tool.

Wedged Bonds

To draw a wedged bond:

1. Click one of the wedged bond tools.
2. Drag from the narrow end of the wedged bond to the wide end of the wedged bond.

Wedged bonds are drawn with a fixed orientation in a document window.

To change the orientation of the wedged bond:

- Click the bond using the wedged bond tool.

 **Note:** ChemDraw treats hashed wedged bonds with the narrow end in the plane of the screen and the wide end behind the plane.

Changing Bonds

You can change bonds by:

- Changing bond types
- Changing bond alignment and orientation
- Moving atoms
- Layering bonds

Changing Bond Types

Change a single bond from one type to another using one of the following methods:

- Select a bond tool and click an existing bond
- Right-click and select the new type from the context menu
- With hotkeys. See "[Shortcuts and Hotkeys](#)" on page 48.

Changing Double Bonds

To change one type of double bond to another:

1. Select the Bold, Dashed, or Solid Bond tool.
2. Click a double bond.

The double bond changes to the new bond type. One of the bonds in the double bond is always a solid or dashed bond.

 **Note:** If you click a tautomeric bond (solid/dashed) again with the dashed bond tool, you create an aromatic double bond (dashed/dashed).

Aligning Double Bonds

Double bonds can have one of three alignments relative to other bonds— above, below, and centered.

Above

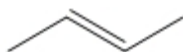

Below

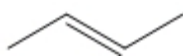

Centered



1. Click the bond tool used to create the existing double bond.
2. To change the alignment, do one of the following:
 - Click the center of the double bond.
 - Right-click, point to **Bond Position** on the context menu, and choose the alignment.

Moving Atoms

To move an atom in a structure, click and drag it using a selection tool. To move two bonded atoms in a structure, click and drag the bond between them.

To move individual atoms:

1. Click a selection tool.
2. Point to the atom you want to move. A highlight box appears over the atom.
3. <SHIFT>+drag the atom.

 **Note:** You can also move atoms using a selection tool. See ["Moving Objects" on page 89](#).

Reducing Ring Size

You can reduce the number of atoms in a ring. For example, you can convert cyclohexane to cyclopentane.

To reduce the ring size, do one of the following:

- Using the selection tool, click and drag.
- Using a bond tool, point to an atom and <SHIFT>+drag. Release when one atom is on top of the other. The bond between the atoms disappears.

Bond Crossing

When one bond crosses another, you can indicate which bond is in front. The bond which is behind has a small section cut out, so you can clearly discern which bond is front-most.

To move an object to the front position:

1. Select the object to move to the front.
2. Go to **Object>Bring to Front**. The selected object now appears in front of all other objects.

Similarly, navigate to **Object>Send to Back** to position the bond behind other objects.



 **Note:** Some file formats store 3D coordinates for atoms, while others only store 2D coordinates. For bonds with 3D coordinates, those coordinates determine the visible bond crossings. **Bring To Front** and **Send To Back** have no effect. For more details on converting bonds and structures into 3D view, see ["3D Viewing" on page 175](#)

Fixed Bonds

By default, ChemDraw draws structures with fixed bond lengths and bond angles. The values of those lengths and angles is determined by the settings for the particular type of document. For more information, see ["Document Settings" on page 42](#). However, you can modify the behavior so that you are not constrained to fixed bonds and angles.

 **Note:** To suppress fixed lengths and fixed angles, press the **ALT** key as you drag the bond.

Drawing Fixed Length Bonds

To draw bonds constrained to a fixed length:

1. Navigate to **Object>Fixed Lengths** and ensure a check mark appears next to **Fixed Lengths**.
2. Draw a bond using any bond tool.

Drawing Fixed Angle Bonds

Bond angles are generally either set to the default chain angle of 120 degrees, or are constrained to angles of 15 degree increments.

To draw fixed angle bonds:

1. Navigate to **Object>Fixed Angles** and ensure a check mark appears next to **Fixed Angles**.
2. Draw a bond using any bond tool.

The bonds in the new structure appear at standard 120° angles.

Changing Fixed Values

By default, bond lengths are .4176 inches and bond angles in a chain are 120°.

To change fixed values:

1. Navigate to **File>Document Settings** and click the Drawing category.

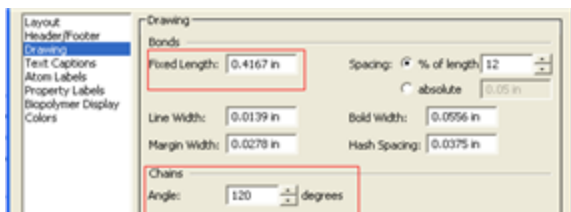

2. Enter a value in the **Fixed Length** text field. Use in, cm, pt, or picas for units.
3. Enter a value in the Chains **Angle** text field.
4. Click **OK**.

For more information on drawing settings, see ["Drawing Settings" on page 27](#).

Atoms

By default, when you draw structures with the various bond, ring, or chain tools, simple hydrocarbons are created. You can add atom labels to the atoms using the Text tool. You can also use the Text tool to add textual captions to a document. For example, you can add the atom label "OH" to a drawing of toluene to create phenol:

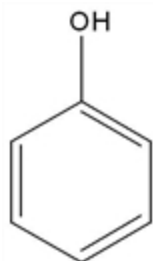

1. Draw the toluene structure.
2. Using the Text tool, click the methyl carbon. A text field appears.
3. Type OH in the text field.
4. Click outside the text field.

To edit the atom label, click in the text field with the text tool and begin typing.

You can either enter the atom label in a text field or type the hotkey while hovering over an atom. For more information about hotkeys, see ["Hotkeys"](#) on page 66 and ["Shortcuts and Hotkeys"](#) on page 48.

Periodic Table

You can use the periodic table to insert atoms into structures. Navigate to **View>Show Periodic Table Window**.

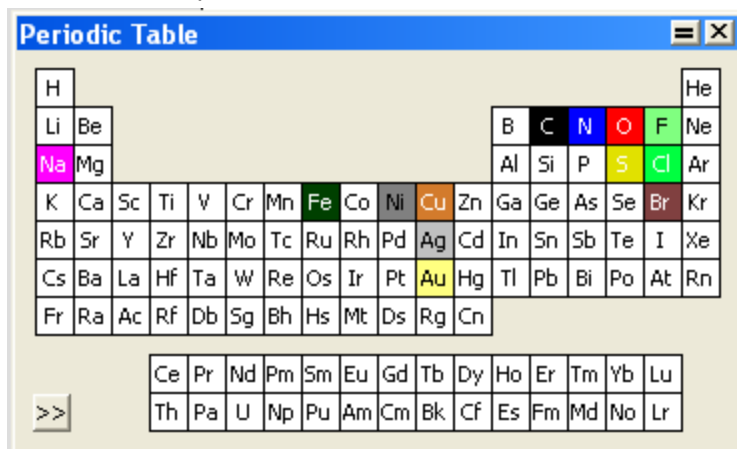

H																	He
Li	Be											B	C	N	O	F	Ne
Na	Mg											Al	Si	P	S	Cl	Ar
K	Ca	Sc	Ti	V	Cr	Mn	Fe	Co	Ni	Cu	Zn	Ga	Ge	As	Se	Br	Kr
Rb	Sr	Y	Zr	Nb	Mo	Tc	Ru	Rh	Pd	Ag	Cd	In	Sn	Sb	Te	I	Xe
Cs	Ba	La	Hf	Ta	W	Re	Os	Ir	Pt	Au	Hg	Tl	Pb	Bi	Po	At	Rn
Fr	Ra	Ac	Rf	Db	Sg	Bh	Hs	Mt	Ds	Rg	Cn						
>>																	
Ce	Pr	Nd	Pm	Sm	Eu	Gd	Tb	Dy	Ho	Er	Tm	Yb	Lu				
Th	Pa	U	Np	Pu	Am	Cm	Bk	Cf	Es	Fm	Md	No	Lr				

Click a symbol in the periodic table to highlight the atom and activate the Text tool. Move the mouse across the table to highlight each atom.

To add an atom. Select the desired element in the periodic table and click an empty space in the document. The atom appears in its chemically neutral form. For example, carbon appears as CH₄ and hydrogen appears as H₂.

To label an atom. Click an existing unlabeled atom.

To change the oxidation state. Using the symbol for the atom, click the atom in the document window.

To change to a different atom. Select the new atom in the periodic table and click the atom in the drawing you want to change.

To edit a label. You can edit an atom label using the Text tool. Highlight the text and click a symbol in the periodic table. The highlighted text is replaced.

Repeating Atom Labels

You can repeat an atom label using the text, bond, or ring tools.

1. Click the Text tool.
2. Label a single atom.
3. Do one of the following:
 - Using the Text tool, double-click another atom.
 - Using a bond, ring, or acyclic chain tool, triple-click another atom.

Deleting Labels

To delete an atom label, do one of the following:

- Select the Eraser tool and click the atom label.
- With a selection, bond, or ring tool selected, point to the atom label and press the <spacebar>, <Backspace>, or <Delete> key. Note that if an atom is labeled, pressing the <spacebar>, <Backspace>, or <Delete> key will delete the label, but not the atom. To delete the atom as well, press the <Delete> key a second time to delete the unlabeled atom.

Captions

You can add and edit captions to your structures using the Text tool. The following example adds the caption 'Phenol' to a phenol structure.

To add the caption 'Phenol' to a phenol structure:

1. Draw the phenol structure.
2. Using the Text tool, click below the drawing and type "Phenol" in the text field.
3. Click outside the text field.

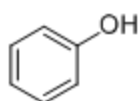

Phenol

To edit the caption, click in the text field with the Text tool and begin typing. For more information, see ["New Lines and Closing Text Boxes" on page 24](#).

Formatting

Each new caption, or atom label, uses default document settings for font, size, and style of captions and atom labels. You can change the format by:

- Changing the document settings for subsequent drawings in the current document.
- Choosing a new format for an individual caption or label from the Text menu or toolbar before you type.
- Selecting text and applying a new format to an individual label after you type.

To specify the text settings for new captions and atom labels in the current document:

1. Navigate to **File>Document Settings**. The Document Settings dialog appears.
2. Select Text Captions or Atom Labels category.
3. Select the appropriate options.
4. Click **OK**. These settings affect all new captions, or atom labels, in the current document.

You can set the text format for an individual caption, or atom label, before you begin typing.

To set the text format before you type:

1. Click the Text tool and click in the document window. A text field appears.
2. Set the text format in one of the following ways:
 - From the Text menu, choose the format options.
 - From the Style toolbar, choose the format options.
3. Type the text in the text box.

 **Note:** *The format change is applied to the current text only. Any subsequent text you type is formatted according to the default document settings for the current document.*

To specify a font, style, and size for selected text, do one of the following:

- Choose the font and size from the Text menu.
- Right-click and choose the font and size from the context menu.
- From the Style Toolbar, select the font and size from the drop-down menus.

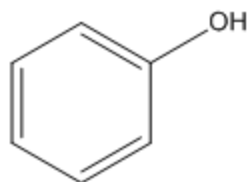

Phenol

Coloring Text

You can color captions and atom labels before or after you type them, and as a whole or in part.

To color a caption or atom label:

1. Select the Text tool.
2. Click inside the document where you want to place the text.
3. Choose a color from the Color menu.
4. Type the caption or atom label.

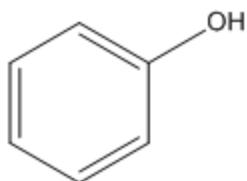

Phenol

To color individual characters:

1. Select part of an existing caption, or atom label, using the Text tool.
2. From the Color menu, choose a color.

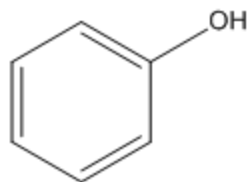

Phenol

To color several captions or atom labels at once:

1. Select the captions or labels using a selection tool.
2. Choose a color from the Color menu.

Caption Width

To edit the width of a caption:

1. Select the caption using the Text tool. A resize handle appears on the right side of the caption.
2. Drag the resize handle to change the width of the caption.

About Fonts

ChemDraw uses the fonts installed on your computer. If a ChemDraw document contains fonts that are not available on a particular computer, they are substituted with the available fonts.

Character Map

The floating character map window displays the 256 ASCII characters in any font. The default font is Symbol.

Use the character map to add symbols to your document in various font styles. To show or hide the map, navigate to **View>Show Character Map Window**. The character map is shown below.

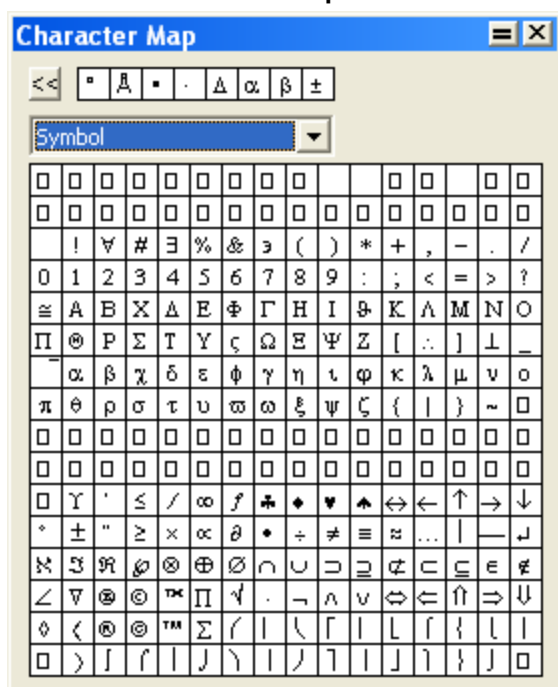

The character map is active only when a text field is open for editing. With a text box open, mouse over the character map to view a larger version of the characters in the top right corner of the window. Click any character in the table to enter it in the text field. The selected font (shown in the character map window) is applied to that character only. It does not change the active font in the text field.

The eight most-recently used characters appear at the top of the window. A character may appear more than once in this section if the versions use different fonts. Click the **Back** button to toggle among all the displayed characters.

Hotkeys

Hotkeys are keys on your keyboard that are linked to specific atom labels. Use ChemDraw hotkeys to quickly label atoms and apply atom properties. The Hotkeys.xml file in the ChemDraw Items folder contains the hotkeys provided with ChemDraw. You can add or change hotkeys by editing this file in a text editor.

Using Hotkeys

Using hotkeys, you can add functional groups to your structures with one keystroke. For example, to add tert-butyl to the end of a hydrocarbon chain:

1. Draw the chain.
2. Hover the cursor where you want the functional group.
3. Press <3> (the hotkey for tert-butyl) on the keyboard. 't-Bu' is added to the structure.
4. Select 't-Bu' in the structure and navigate to **Structure>Expand Label**.

Using the hotkeys <n> (nitrogen), <o> (oxygen), and <i> (iodine), you can turn ethylbenzene into pyridin-2-yl hypoiodite.

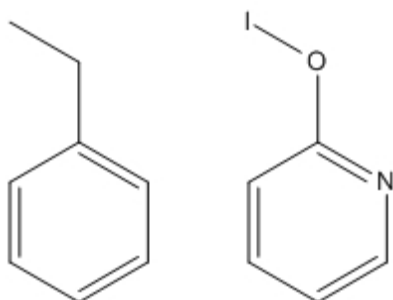

You can also label several atoms at a time. For example, you can change neopentane (figure A below) into methanetetraamine (figure B):

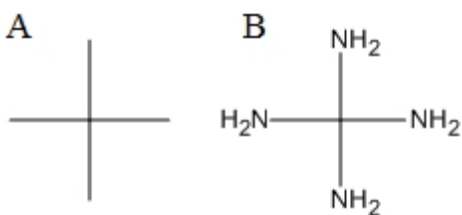

1. Create the neopentane structure.
2. Use <SHIFT>+click to select all the terminal carbon atoms and press <n> on the keyboard.

 **Note:** For a complete list of hotkeys, see ["Shortcuts and Hotkeys" on page 48](#).

Nicknames

The simplest way to add an atomic symbol to a structure is to type the symbol into a text field. However, you are not limited to entering atoms one-at-a-time. Using nicknames, you can add functional groups, chains, or any other structural feature without drawing each atom.

A nickname is an alphanumeric abbreviation that represents a substructure. Nicknames are useful for drawing large structures or structures that repeatedly use similar features.

Note that you can assign a nickname to the structural feature. You can also assign hotKeys to nicknames that you can later use as a quick way for adding the nickname to your drawing. For more information on defining nicknames, see ["Defining Nicknames" on page 146](#).

Using Nicknames

Using nicknames, you can add short names for functional groups to use as an atom label, or part of a label. When an atom is labeled with a nickname, the chemical significance of the expanded structure is retained.

Commonly used nicknames, such as Me, Et, and Ph are stored in your ChemDraw Items folder. You can edit or delete nicknames in this list.

You can assign hotkeys to nicknames. For example, the hotkey <4> labels an atom with "Ph", which represents a phenyl group.

Applying Nicknames

You can either type the nickname or select it from the nicknames list. For more information on defining nicknames, see ["Defining Nicknames" on page 146](#).

To use a nickname to label an atom:

1. In a structure, double-click an atom with a bond tool, or click an atom with the Text tool. An atom label text field appears. Do one of the following:
 - Type a nickname label, such as "Et".
 - Navigate to **File>List nicknames**. The List Nicknames dialog appears.
 - Select the required nickname and click **Paste**.
 - Click **Done**.

An example is shown below:

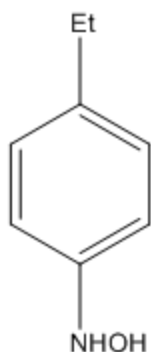

To select a nickname to apply to an atom using a hotkey:

1. Point to an atom.
2. Press the hotkey <=> (equal sign). The Choose Nickname dialog appears.

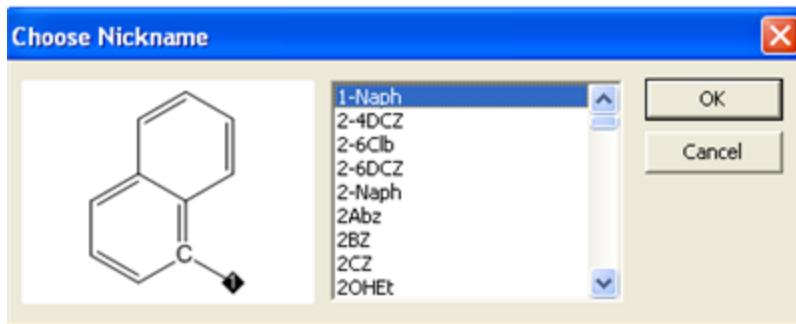

3. Select a nickname from the list.

 **Tip:** You can move within the nickname list by typing the first letter of the nickname, rather than scrolling through the list.

4. Click **OK**.

 **Note:** Nicknames are tokens and do not flip orientation when applied to the left side of a structure when using Automatic Justification. For example, in the absence of a defined nickname, the label "OTHP" appears as "PHTO". However, since the nickname "THP" is defined, the label appears as "THPO". For more information, see ["Aligning Text" on page 31](#).

Expanding Nicknames

If your structures contain defined nicknames, long atom labels, or contracted labels, ChemDraw can restore your structures to the fully expanded form. While expanding a structure containing a defined nickname, the nickname will be replaced by its expanded structure, as shown below:

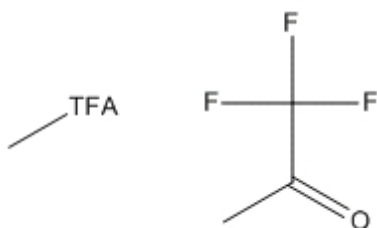

For Biopolymers, when you expand the nickname, residue label appears below the expanded amino acid. For example, assume you have a chain of three amino acids—glycine, isoleucine, and leucine:

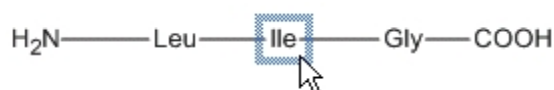

To select the amino acid, double-click the nickname, as shown:

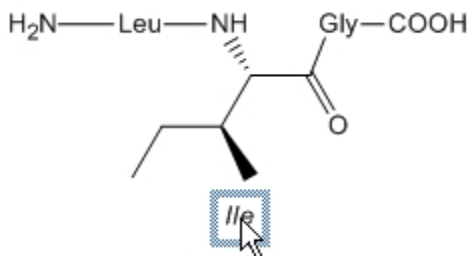

To expand atom nicknames,

1. Select the selection tool.
2. Select the label to expand, or double-click the structure to select all labels in the structure.
3. Navigate to **Structure>Expand Label**. Your structure is redrawn in its expanded form.

To contract expanded nicknames:

1. In the biopolymer structure, select the expanded part.
2. Navigate to **Structure>Contract Label**. Your structure is redrawn in its contracted form.

 **Note:** This is applicable only to biopolymers.

Annotations

Annotation is a brief description of an object, or a comment, about properties of an object. Annotations are useful in identifying features and categories of objects in searching and browsing. Annotations are categorized using keywords. There are several default keywords: Name, Description, GUID (Globally Unique Identifier) Type, and Other Info. You can also add your own keywords. Many of the objects in the template files have associated annotations to help you identify them in files.

To annotate an object:

1. Select the object.
2. Navigate to **Object>Annotate**. The Annotate dialog appears.
3. In the Keyword list, do one of the following:
 - Select a keyword.
 - Select **Add New Keyword**.
4. In the **Content** text field, enter the notes (annotation) to apply to the object or drawing.
5. Click **OK**.

Deleting a Keyword

When you delete a keyword, all notes (annotation) for that keyword are also deleted.

1. In the Annotate dialog, select the keyword from the Keyword list.
2. Click **Delete Keyword**.
3. Click **OK**.

Setting preferences

You can specify how the captions and labels appear each time you use ChemDraw. The changes you specify are available throughout the application. Navigate to **File>Preferences** and click the **Building/Display** tab. Then, choose from these options:

Automatic Atom Label Alignment. The alignment of atom labels adjusts according to the positions of any bonds attached to the atom labels. For example, 'CH₃' at the left end of a horizontal bond changes to 'H₃C'.

Automatically Rectify Hydrogens in Atom Labels. Adds or removes hydrogens from atom labels to preserve standard valences when you change your drawing. For example, if you increase the bond order in ethane to make ethylene, the 'CH₃' changes to 'CH₂'.

Setting Default Atom Label Styles

To set the default character style for atom labels, navigate to **File>Document Settings** and click **Atom Labels**. You can modify the font style, baseline style, and whether terminal carbons and implied hydrogens appear.

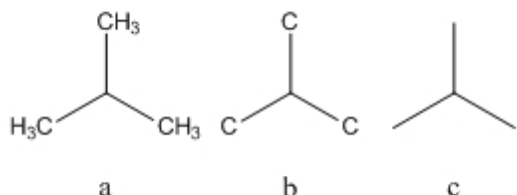

To set the default atom label style for a document:

1. Navigate to **File>Documents and Settings**.
2. From the **Atoms Labels** tab, check the **Show Labels on Terminal Carbons** check box.
3. Click **OK**.

To set the default atom label style for one or more structures:

1. Select and right-click the structure(s).
2. Click **Object Settings** in the context menu. The Object Settings dialog appears.
3. From the **Atom Labels** tab, check the **Show Labels on Terminal Carbons** check box.

To add or remove a terminal carbon label, right-click the atom and select or deselect **Show Terminal Carbon Labels**.

Chemical Significance

By default, captions are considered to be chemically significant, if possible. If you create a label, for example, "CH₃OH", you are able to attach bonds to it (and it is modified appropriately) even though you may have intended it to be a label, not a molecule. Moreover, its values are included in the Analysis window. The labels with incorrect valences are marked with a red box.

To remove the red box:

1. Select the label with the Selection tool.
2. Right-click and deselect **Interpret Chemically** in the context menu.
3. To activate chemical significance, right-click the label and select **Interpret Chemically**.

Analysis Data

You can add properties from the Analysis window to a caption and, if Auto-update is on, the values update as you modify the structure. For more information about Auto-update, see ["Auto Update" on page 155](#).

To add analysis data to a caption:

1. Right-click the structure and select **Analysis** from the context menu.
2. Choose the properties to add.

Chemical Formula: C₆H₅ClO

Molecular Weight: 128.56

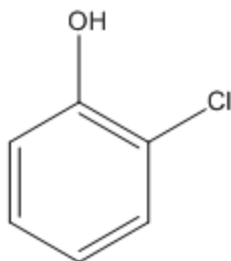

Drawing Rings

The Main Tools palette contains the following ring tools that enable you to draw ring sizes and types:

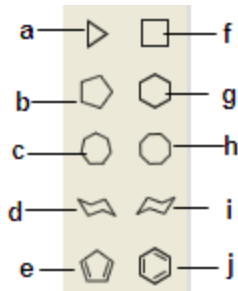

Figure 6.3: a)cyclopropane; b)cyclopentane; c)cycloheptane; d)cyclohexane chair(1); e)cyclopentadiene; f)cyclobutane; g)cyclohexane; h)cyclooctane; i) cyclohexane chair(2); j)benzene.

To draw a ring:

1. From the Main toolbar, select a ring tool.
2. Click and drag in the document to orient the ring.

If you click an atom or bond with a ring tool in an existing structure, the ring is fused to it. You can also use hotkeys to fuse rings. For more information, see ["Bond Hotkeys" on page 49](#). You can also reduce the size of the rings. For more information, see ["Reducing Ring Size" on page 60](#)

Spiro and Sprout Rings

By default, clicking an atom in a ring using a ring tool forms a spiro link. However, if you click an atom while pressing the <Alt> key on your keyboard, it will sprout the ring.

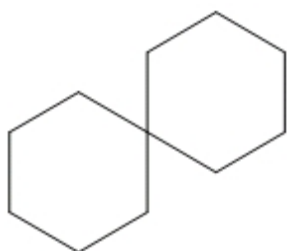

You can change this behavior so that a sprout bond appears instead of a spiro ring:

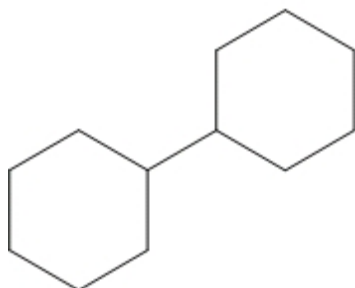

1. Navigate to **File>Preferences**.
2. From the **Building/Display** tab, check the **Sprout Rings Instead of Spiro When Clicking** check box.

Cyclohexane Chair Rings

You can draw cyclohexane chair rings in two orientations: horizontal and vertical. When you draw a cyclohexane chair by clicking, the chair is drawn in a horizontal orientation.

To orient a cyclohexane chair ring to a vertical orientation:

1. Click one of the Cyclohexane Chair Ring tools.
2. Click+drag in the structure to the orientation you want.

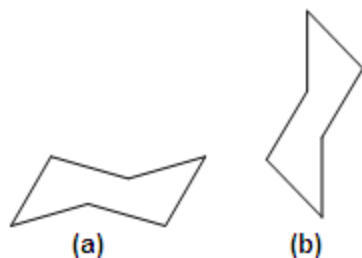

Figure 6.4: a)Horizontal orientation; b)Vertical orientation.

Aromatic Structures

Delocalized Rings

You can draw a resonance delocalized ring using any ring tool except for the cyclohexane chairs.

1. Click a ring tool.
2. Press the **CTRL** key and drag or click in the document window.



Resonance Structures

You can draw cyclopentadiene or benzene in multiple versions:



The double bonds in the cyclopentadiene or benzene ring tools can be drawn in either of two forms. Normally, the first bond drawn is a double bond. This is the orientation indicated on the cyclopentadiene and benzene Ring tool pointers. To draw, click in the document window with either the cyclopentadiene or benzene drawing tool.

To shift the orientation so the first bond drawn is a single bond, do one of the following:

- <Shift>+drag from the beginning of the first single bond to the end of the single bond.
- <Shift>+click in a document window to draw the bond with a fixed length.

Chains

You can draw hydrocarbon chains using either the Acyclic chain tool or Snaking chain tool. Use the Acyclic chain tool to draw straight hydrocarbon chains.

1. Select the Acyclic chain tool.
2. Click and drag in the document window in the direction you want the chain to grow. The number at the end of the chain indicates how many atoms you have drawn.

Changing Chain Direction

To change the direction as you draw, use the Snaking chain tool, or press the <Control> key with Acyclic tool selected, while drawing in the direction you want.

 **Note:** Release the mouse button before you release the <Control> key.

Applying Fixed Lengths

Applying fixed lengths and fixed angles enables you to create structures with consistent bond lengths and angles. The fixed length dimension is set in the Drawing Settings dialog. The fixed angle dimension increments angles by 15 degrees.

Fixed length is used to constrain the length of the bonds drawn to the length you specify when the **Fixed Lengths** command in the Object menu is enabled (with a check mark). This also adjusts the preferred bond length for structures modified by the **Clean Up Structure** command.

When **Fixed Lengths** is enabled, the pointer on the Acyclic chain can be dragged to make any angle relative to the X-axis. At a constant chain length, the positions of the first bond and all subsequent odd-numbered atoms depend on the direction you drag. Before releasing the mouse button, change this position by dragging in the opposite direction.

If **Fixed Lengths** is disabled, hold down the <Control>+<ALT> keys to reverse chain direction. **Fixed Angles** must be enabled to reverse direction.

Fixed Angles

When Fixed Angles is enabled, the angle the Acyclic chain makes relative to the X-axis is constrained to 15-degree increments.

Adding Chains to Structures

To add an Acyclic chain to an existing structure, click an atom in the structure. Click and drag in the direction you want to draw the chain.

Specifying Chain Length

To specify the exact length of a chain before you draw it:

1. Select the Acyclic chain tool.
2. Click an existing atom or an empty area in a document window. The Add Chain dialog appears.
3. Type the number of carbon atoms in the chain.
4. Click **Add**.

To add another chain of the same length anywhere in a document window, <ALT>+click where you want the chain to begin.

Objects

Use the tools on the main toolbar to add shapes to your documents. You can tear off the palettes and place them where you want within your drawing window. You can rotate an object using its rotation handle and scale or distort an object by using the resize or distortion handles.

Arrows

You can use arrows to show the conversion of reactants to products and to indicate electron flow. You can customize arrows not only for length and angle, but for arrowhead width and shape. You can also drag an arrow from its middle to create an arc of any length. When you create an arc, the angle of the arrow is modified.

When you mouse-over an arrow with the Lasso, Marquee, or an Arrow tool selected, the adjustment handles appear, for example:

Drag the adjustment handles to change the arrow length, angle, or shape. When changing the angle of an arrow, you are restricted to multiples of 15° if **Fixed Angles** is enabled. Hold down the <Alt> key to drag to any angle. You can also create an arrow by drawing an arbitrary spline using the pen tools, and adding an arrow head.

Arrow Heads

There are three arrow head shapes: solid, hollow, and angled. To change the shape, right-click an arrow and choose the shape from the context menu.

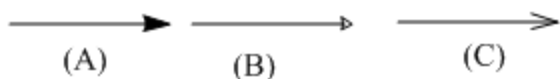

Arrow heads shapes are: A) Solid arrow head; B) Hollow head; and C) Angled head.

Arrow Types

ChemDraw offers a variety of arc types and arrow types, such as, crossed (no-go) arrows, equilibrium arrows of unequal lengths, and elliptical arcs.

Arc Arrows

There are two ways to create an arc arrow:

1. Click and drag the arc adjustment handle of a straight arrow.

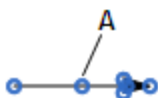
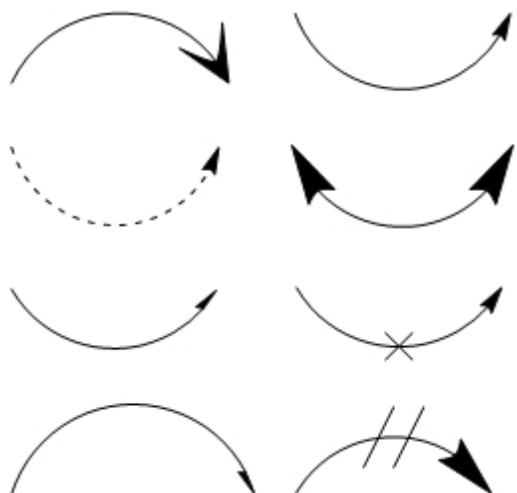

Figure 6.5: A) Arc adjustment handle

2. Select an arc arrow from the Arrows palette.

You can customize arc arrows as easily as straight arrows. Some examples are:



- a. To undo all changes made to an arrow except for the change in length, click the arrow with the same arrow tool.
- b. Click an unmodified arrow, or one that has had only its length changed, to reverse its direction.

Hollow Arrows

You can rotate hollow arrows and change their length and width. You can also modify the angle and create hollow arc arrows, just as with regular arrows.

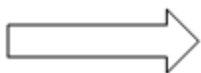

You can modify arrows with a context menu command. Some of these commands are also found on the Curves menu. Use the context menu to create arrows for which there are no tools, such as bold-dashed or dipole.

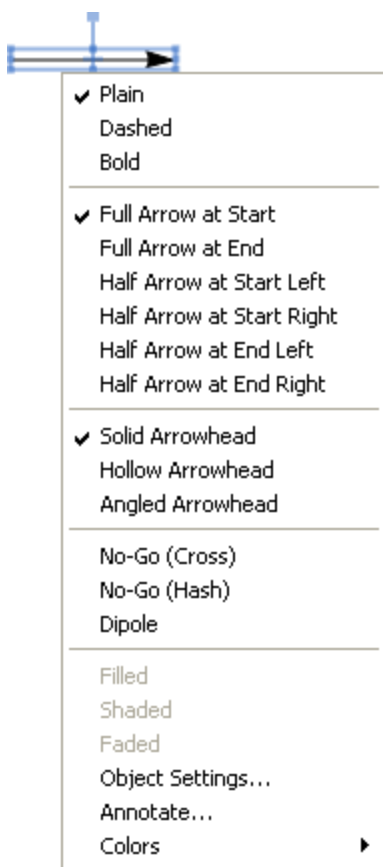

Connecting Arrows

You can connect a new arrow to an existing arrow at either end or at the midpoint.

 **Note:** The terms “left” and “right” in the context menu are relative, and refer to the direction the arrowhead is pointing.

For example, to draw a new arrow starting at the midpoint of an existing arrow:

1. Select from the Arrows palette an arrow type for the new arrow.
2. Place your cursor over the midpoint of the existing arrow and hold down the <shift> key. The adjustment handle changes to a small highlighted rectangle and the cursor changes to the '+' symbol.
3. While pressing the <shift> key, draw the new arrow starting from the existing arrow's midpoint.

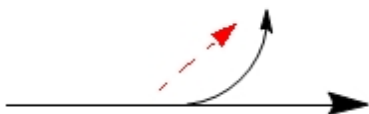

You can also drag existing arrows and connect them. *Here are a few examples:*

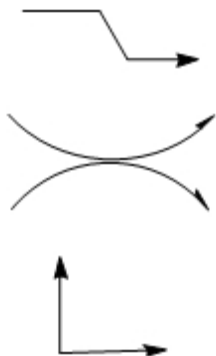

Finally, arrows can be rotated using the Structure Perspective tool, as well as the Lasso, or Marquee. For more information on using the Structure Perspective tool, see ["Structure Perspective" on page 132](#). Combining these methods lets you draw an unlimited number of arrows.

Equilibrium Arrows

With equilibrium arrows, changing the length changes both arrows proportionately; changing the shape of the arrowhead changes both arrowheads identically.



To change the length of one arrow, hold down the <Alt> key. Two new adjustment handles appear. When adjusting one arrow of an equilibrium arrow, the arrow cannot be extended beyond its original length.



Curved Arrows

You can curve most arrows found on the Arrows toolbar. After you paste an arrow in your drawing, click and drag the selection point in the middle of the arrow.

As you drag the selection point, the angle of the arc appears, measured in degrees.

Colored Arrows

To color an arrow:

1. In the drawing window, select the arrow to color.
2. Select a color from the Color menu.

Coloring Block Arrows

For block arrows (those that are not made of simple lines), you can apply colored effects using the filled, faded, and shaded options.

To apply color effects on block arrows:

1. Select a block arrow from the Arrows palette and right-click the block arrow.
2. Select a color from the Color menu.
3. From the context menu, choose either **Filled**, **Faded**, or **Shaded**.

Drawing Elements

Drawing elements are simple shapes, such as, circles and rectangles.

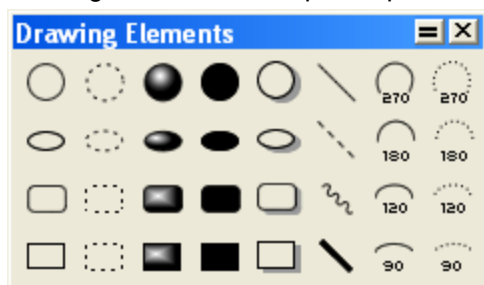

1. To group drawing elements with a structure, navigate to **Object>Group**. See "[Grouping Objects](#)" on page 91.
2. To move an object, select it, and click and drag it with a Selection tool. See "[Moving Objects](#)" on page 89.

Circles and Ovals

To draw a circle or an oval:

1. Select one of the Circle or Oval tools.
2. Point where you want the center of the circle or oval.
3. Drag outward from the center.

Resizing and Rotating

You can resize and reshape ovals and rectangles for both length and width. Circles have only a radius adjustment. Rectangles also have corner handles that proportionately adjust length and width.

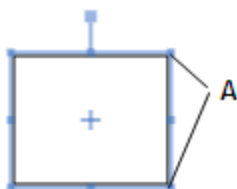

Figure 6.6: A) rectangle corner handles

1. Point to a shape with its drawing tool, or a selection tool, to display adjustment handles.
2. Click and drag to modify the shape.

Lines

Lines look similar to bonds, but behave differently:

- Lines are not included in chemical interpretation.
- Lines that cross appear solid, bonds do not.

To draw a line:

1. In the Drawing Elements toolbar, select a line tool.
2. Click and drag in the drawing window where you want the line.

Arcs

You can draw solid or dashed arcs of different angles: 90°, 120°, 180°, and 270°.

To draw an arc:

1. Do one of the following:
 - In ChemDraw Standard, point to an Arc tool and drag in the palette to select the angle.
 - In other ChemDraw applications, point to the Drawing Elements tool and drag in the tool palette to select the angle.
2. Drag from left to right (for a convex arc), or from right to left (for a concave arc).

Editing Arcs

To resize or rotate an arc:

1. Position the Arc tool over the arc. Drag points appear on the ends and in the middle.
2. Drag either end of the arc to change its length.
3. Drag the center point to change the curvature.
4. Use a selection tool to change its size or orientation.

Navigate to **View>Show Info Window** to display the info window. The Info window indicates the distance between the ends of the arc and the angle the clockwise end makes with the X-axis.

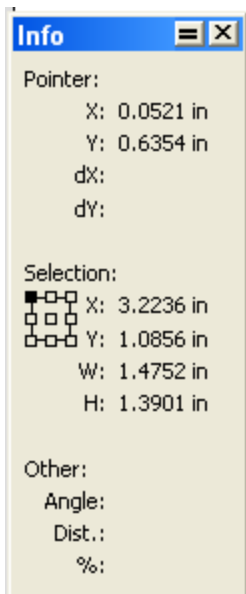

When you drag the resize handle, the Info window indicates the percentage as enlarged or reduced. When you drag the Rotation handle, the Info window indicates the degree rotated. For more information about Info window, see ["The Info Window" on page 89](#).

Brackets

Brackets includes braces {}, brackets [], and parentheses (). Brackets are commonly used to illustrate polymers. For more information on polymers, see "Polymers" on page 253.

Single brackets

You can draw a single bracket in any orientation. Select a single bracket tool from the Brackets palette.

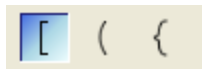

1. Point where you want the bracket to start.
2. Drag from one end of the bracket to the other end.

Paired Brackets

Paired brackets can be placed only in a vertical orientation. However, once you draw paired brackets, you can then select them and rotate to a horizontal position or any orientation desired. A rectangle or box defines their position.

To draw paired brackets:

1. Select a paired bracket tool from the Brackets palette.
2. Point where you want a corner of the bracket.
3. Drag diagonally from one corner of the box to the opposite corner.

Daggers

To draw a dagger:

1. Select a dagger tool from the Brackets palette.
2. Click in the drawing window.

 **Note:** To resize a dagger, select the dagger and click and drag one of its resize handles.

Framing Objects

You can enclose your drawings or group structures with a rectangle, brackets, parentheses, or braces.

To enclose your object:

1. Select the drawing to enclose.
2. Navigate to **Object>Add Frame and select a frame type**.

Pen Tools

The pen tools are useful for drawing freehand curves and shapes.

To draw a curve, do one of the following:

- Select the Draw Curve tool from the Pen Tools palette on the Main toolbar and click and drag your cursor across the drawing window.
- Navigate to **View>Other Toolbars>Pen Tools**. Select the Draw Curve tool, and click and drag your cursor across the drawing window.

Editing Curves

You can edit a curve by selecting it and manipulating it with Edit Curve tool.

To select an existing curve for editing:

1. Select the Edit Curve tool from the Pen Tools palette on the Main toolbar.
2. Point at the curve. The cursor will change from a "+" to an arrow when you are positioned correctly.
3. Click to select the curve. The curve is selected and adjustment handles appear along the curve, as shown below:



The cursor appears as a hand with a "+" sign inside . However, when the cursor is positioned exactly over the points on the curve, the '+' symbol disappears and the cursor appears as a hand.

Changing the Shape of a Curve. Use the square handles at the end of the curve to increase or decrease the length of the curve. Use the endpoints of the direction lines to change the direction of the curve.

To change the shape of a curve:

- Drag the direction lines to create the shape you want.

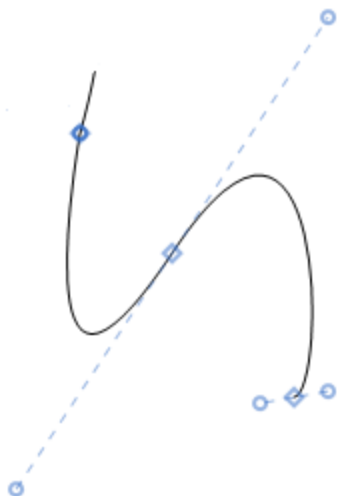

Adding a Segment. You can add a segment to an existing curve by selecting the curve with Edit Curve tool, and clicking in the document window with the Edit Curve tool selected. A segment is added to the end of the curve.

Freehand Shapes

To create a closed freehand shape, draw a curve and navigate to **Curves>Closed**. To add curve properties, select **Filled**, **Faded**, or **Shaded** under the Curve menu or in the Curve toolbar. Curves can also have arrowheads, which lets you create arbitrarily-shaped arrows. To add color, select a color in the Color menu.

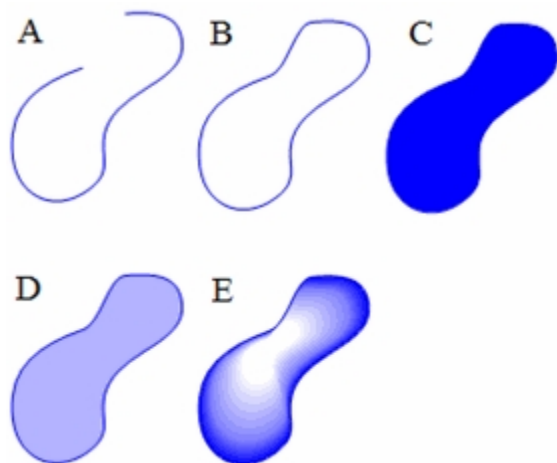

Figure 6.7: A freehand curve with different properties; A) A simple curve; B) enclosed; C) filled; D) faded; and E) shaded.

Selecting Objects

Use the Lasso for freehand selections and the Marquee to select rectangular regions.



When you select a structure or object, the selection displays with a colored frame around it. The frame includes handles for rotating, distorting, and resizing your selection.

The Lasso Tool

Use the Lasso tool to make a freehand selection of irregular areas.

To select objects using the Lasso tool:

1. Select the Lasso tool.
2. Press the mouse button while the pointer is not over any object.
3. Drag around part of a structure or other object.

As you drag, a line appears that defines the selection area. Bonds, structures, or other objects are selected only if they are entirely within this area.

The Marquee Tool

Use the Marquee tool to select objects and structures within a rectangular area.

1. Select the Marquee tool.
2. Click and drag diagonally over the structures or other object.

As you drag, a rectangle appears that defines the selection area. Non-molecular objects are selected only if their center or at least a major portion of the object is within the selection triangle.

To set one selection tool to behave like the other, click either one of the tools while pressing <Alt> .

To toggle a selection tool and the last drawing tool used, press <Control>+<Alt>+<Tab> .

Selecting Entire Structures

To select an entire chemical structure, double-click a bond or atom in the structure using a selection tool.

If the chemical structure or other object is part of a group, the group is selected.

Selecting Objects by Clicking

1. Select the Lasso or Marquee tool.
2. Point to an object in a document window.
A highlight box appears over the pointed object.
3. Click the object.

The selected objects appear within the selection rectangle and the cursor changes to a hand.

 **Note:** You can also select the individual objects in a group. See ["Grouping Objects" on page 91](#).

Selecting Multiple Objects

When you select multiple objects, each object displays a selection box.

To add more objects to the selection, press <shift> and select the other objects.

To select all objects, navigate to **Edit>Select All** or press <Control>+A.

Deselecting All Objects

To deselect all objects, do one of the following:

- Click an empty area outside the selection rectangle.
- Press <esc>.
- Select a different tool.
- Select another object without holding down the <shift> key.

Deselecting One Object

To deselect one of several selected objects, hold down the <shift> key and click the object with a selection tool.

 **Note:** As shown in the figure below, objects may appear within the borders of the selection rectangle, but not be selected. Note that the central ring in the example below is not selected.

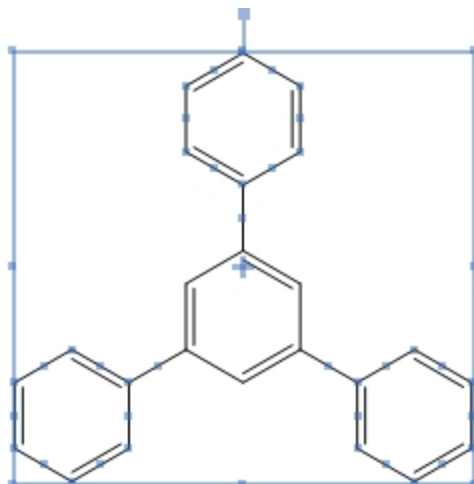

Resizing Objects

You can resize objects by dragging the resize handles of a selected object or by scaling.

To resize a selected object proportionately:

1. Select the objects to resize. Resize handles are located in each corner of a selection rectangle.
2. Point to a Resize handle. The cursor becomes a double-headed arrow.

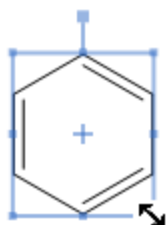

3. Drag the resize handle until the object is the size you want.

In most cases, when you resize an object, the aspect ratio of the object (the ratio of the height to width) does not change. However, it is possible to distort certain objects including chemical structures, circles, boxes, and ovals. To distort an object in the horizontal or vertical direction:

1. Select the object
2. Do one of the following:
 - Drag the handle on the desired side

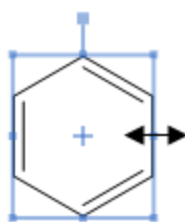

- <Shift>+drag the Resize handle in the desired direction. The <shift> key modifies the resize operation so that you can distort objects along the X-axis or Y-axis.

Rotating Objects

1. Select an object to rotate. For objects that can be rotated, the rotation handle appears at the top of the selection rectangle.
2. Drag the rotation handle clockwise or counterclockwise.
3. To rotate an atom label with a structure, press the <control> key while dragging the structure.

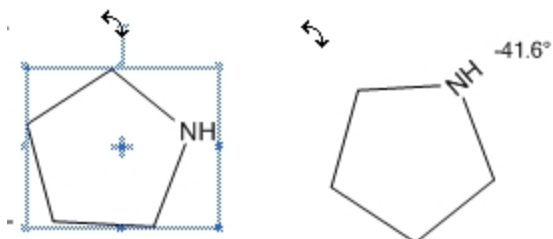

 **Note:** If a single atom is unselected when a structure is rotated, the structure rotates around the unselected atom, as shown in the example below:

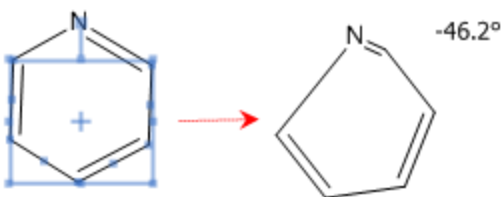

To rotate a selected object by a specified angle:

- Do one of the following:
 - Navigate to **Object>Rotate**.
 - Double-click the rotation handle. The Rotate Objects dialog appears.
- Enter a number and click either **degrees CW** for a clockwise rotation or **degrees CCW** for counterclockwise rotation.
- To rotate the atom label text, select **Rotate Atom Labels**.
- Click **Rotate**. Objects are rotated around the center of the selection rectangle.

To repeat the same rotation on any object in the document window:

- Immediately after rotating an object, select the other objects to rotate.
- Navigate to **Edit>Repeat Rotate**.

Moving the Center of Rotation

By default, an object turns around its center when you rotate it. However, you can move the center of rotation so that the object rotates around an atom or some other location on the page.

To move the center of rotation:

- Select the object. A center of rotation indicator ('+') appears in the center of the object, as shown in the figure:

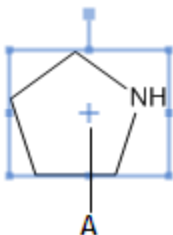

Figure 6.8: A) Center of rotation

- While pressing the <alt> key, click and drag the indicator to another location. See the example below:



Figure 6.9: B)center of rotation moved

3. To rotate the object, click and drag the rotation handle.

To reset the center of rotation to its default position, deselect the object.

 **Note:** If you drag close to an atom, the center of rotation will snap to the atom position.

Moving Objects

1. Select an object to move using a selection tool.

2. Click and drag the object to a new location.

To constrain the movement to the horizontal or vertical direction, <shift>+drag the selected objects.

Small incremental movements are often useful for aligning objects.

To move an object a incrementally:

1. Select the object.

2. Press an arrow key. The selected object moves 1 point in the direction of the arrow.

 **Note:** To move in a larger increment, hold down the <alt> key while pressing an arrow key. The selected objects moves 10 points in the direction of the arrow.

Copying Objects

1. Select one or more objects.

2. <Control>+drag the object(s) to create a copy and position it.

To constrain the copy to move only vertically or horizontally while positioning it, hold down the <shift>+<control> keys.

The Info Window

This window displays the size and position of the pointer and of anything you have selected. To show, or hide, the window, navigate to **View>Show Info Window**.

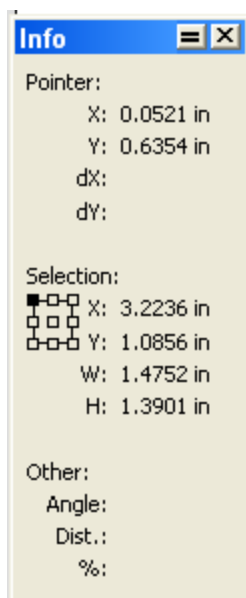

Pointer

X and *Y* display the current mouse coordinates. *dX* and *dY* indicate the change in *X* and *Y* of a moved selection.

Selection

X and *Y* display the position of a selection. *W* and *H* are the width and height.

Other

Angle is the angle of a bond or rotation of a selection. *Dist* is the bond length or the distance a selection has moved. When resizing an object, *%* indicates the current percentage of the original size.

Mirror Images

You can reflect structures through planes perpendicular to the X-axis or Y-axis. By copying a structure, you can create its mirror image to create stereoisomers.

To create a mirror image:

1. Draw a structure with defined stereochemistry, for example, wedged bonds.
2. <control>+drag the structure to copy it.
3. With the copy still selected, navigate to **Object>Flip Horizontal** or **Flip Vertical**. You can also use the Flip Horizontally or Flip Vertically tools on the Object toolbar.

Deleting Objects

To delete selected objects, do one of the following:

- Press the <delete> key.
- Navigate to **Edit>Clear**.

- Use the Eraser tool.

Joining Structures

To join two structures so that they share a bond:

1. Select a bond in the first structure.
2. <Shift>+click to select the bond in the second structure.
3. Navigate to **Object>Join**.

To join two structures so that they share an atom:

1. Position the two chemical structures so that the atoms you want to fuse are near each other.
2. Select the two atoms to be joined.
3. Navigate to **Object>Join**.

 **Note:** When you join two differently colored bonds or atom labels, the color of the front object becomes the color of the resulting joined object. When you join two atoms that are labeled, the front atom label becomes the atom label of the resulting atom. For more information about front to back ordering of objects, see ["Page Layout" on page 12](#).

Grouping Objects

A group is a collection of objects that act as a single object. You can select all grouped objects by double-clicking on any of the contained objects with a selection tool.

When you group objects so that the individual objects in the group cannot be selected, you create an *integral group*.

When you select any object in an integral group, the entire group is selected. Objects within a non-integral group can be selected individually and manipulated while still remaining part of the group.

You can change the position or orientation of grouped objects. Individual objects within the group maintain their relative positions when the grouped objects are rotated, aligned, or distributed.

Atoms and bonds making up a single chemical structure are always grouped. If you group part of a structure with other objects, the resulting group contains the entire structure. If you add atoms or bonds to a grouped structure, the new atoms and bonds are part of the group.

To group objects:

1. Select the objects using a selection tool.
 2. Navigate to **Object>Group**.
- To select an individual object within a group, move the selection tool over the object until it is highlighted, and click once.
 - To select grouped objects, move the selection tool over an object in the group until it is highlighted, and double-click it.

To create a group so that individual objects cannot be selected (integral group):

1. Select the objects.
2. Navigate to **Object>Group**.

3. Right-click the group and select **Group>Integral**.

To restore an integral group to a regular group:

1. Select the integral group.
2. Right-click the group and deselect **Group>Integral**.

Ungrouping Objects

 **Note:** Many of the shapes and drawings within the template documents are integral groups. However, they can be ungrouped and edited.

To ungroup objects:

1. Select a group.
2. Navigate to **Object>Ungroup**, or right-click the group and select **Group>Ungroup**.

Scaling objects

To scale one or more objects to a different size:

1. Select the object(s).
2. Do one of the following:
 - Go to **Object>Scale**.
 - Double-click a resize handle. The Scale Objects dialog appears.

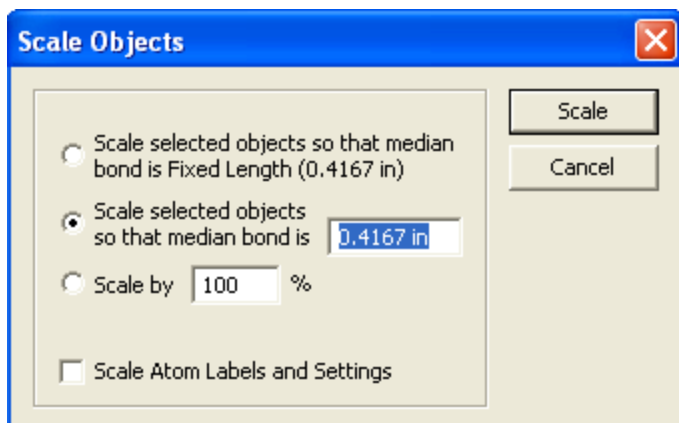

3. Do one of the following:
 - To scale bonds so that the Fixed Length becomes the new median bond length, select **Scale selected objects so that median bond is Fixed Length(0.4167 in)**.
 - To scale the bonds to a new fixed length that you specify, select **Scale selected objects so that median bond is**, and type the new median bond length in the text field.
 - To scale the object to a percentage of the current size, select **Scale by**, and specify the percentage in the text field. A value greater than 100% enlarges it; a value less than 100% reduces it.
4. Click **Scale**.

Centering Objects

To center an object (or group of objects) on the page:

1. Select the object.
2. Navigate to **Object>Center on Page**.

The selected object moves so that the center of the selection rectangle is at the center of the page.

Aligning Objects

You can align objects vertically and horizontally along their centers or edges.

 **Note:** Objects are aligned with the selected object that appears highest on the page.

To align two or more objects:

1. Select the objects.
2. Navigate to **Object>Align**.

 **Note:** If you select only part of a structure or group with a selection tool, only that part is used for the alignment, but the entire structure or group moves.

Distributing Objects

Use the distribute command to distribute objects horizontally or vertically and at an equal distance apart.

To distribute three or more objects:

1. Select the objects to distribute.
2. Navigate to **Object>Distribute**, and choose **Vertically** or **Horizontally**.

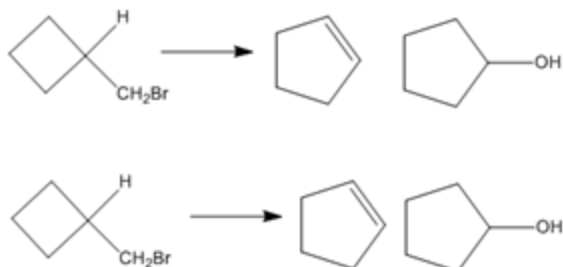

Figure 6.10: Distributing objects

The space between the objects is equalized. The upper, lower, right, and left positions of objects in your selection remain unchanged.

Clean Up Structure

The **Clean Up Structure** command is used to neaten the appearance of molecules by standardizing bond lengths and angles. Graphic objects, such as arrows and aromatic circles, are not affected. You can use this command to redraw

structures that you may have drawn freehand, or to neaten structures that you may have imported from another application.

For certain compounds, the **Clean Up Structure** command produces a structure that extends beyond the bounds of the page. To view the entire structure, scale the structure or increase the size of the printed page. See ["Scaling objects" on page 92](#) and ["Page Setup" on page 14](#).

The **Clean Up Structure** feature follows these rules:

- Bonds are set to the target Fixed Length specified in the document settings. For more information, see ["Document Settings" on page 42](#).
- A ring is redrawn only if all of its bonds are selected.
- Multi-attached atom labels, variable attachment points, and multi-center bonds cannot be cleaned.
- Structures are rotated so that as many bonds as possible are directed at a multiple of 15 degrees.
- Clean Up Structure preserves stereochemical meaning rather than the precise identity of wedged, or hashed bonds, as shown below.

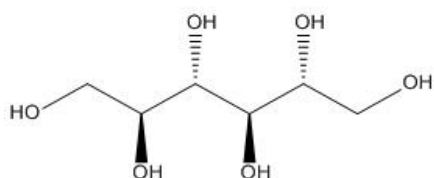
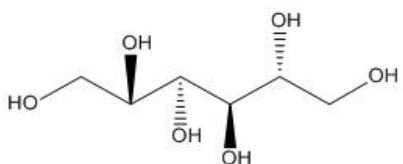

To use Clean Up Structure:

1. Select the structure, or part of the structure, to clean up.
2. Navigate to **Structure>Clean Up Structure**, or type <Shift>+<Control>+<K> .

 **Note:** The Clean Up Structure command redraws your structure in iterations. Therefore, you may need to select the command more than once.

You can also clean up a reaction, or a biopolymer. For more information, see ["Clean Up Reactions" on page 138](#) and ["Clean Up Biopolymers" on page 112](#)

Checking Structures

You can check the chemistry of a selected structure, part of a structure, or caption (in Formula style) with the **Check Structure** command. The structure is checked using normal valences and elements, and defined nicknames.

To check the valences of all selected atoms in a structure:

1. Select a structure, part of a structure, or caption.
2. Navigate to **Structure>Check Structure**.

If a structure is incorrect, a message window appears, for example:

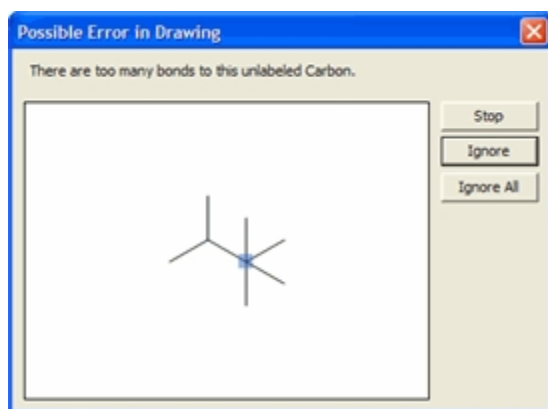

3. To continue checking the structure, click **Ignore**.
4. To ignore all subsequent errors, click **Ignore All**.
5. To stop checking for errors, click **Stop**.

Checking Copied Structures

To automatically perform a check structure analysis each time you copy a structure from the clipboard:

1. Navigate to **File>Preferences**.
2. From the General tab, click **Check Structure When Copying to Clipboard or Exporting**.

This change affects all documents.

Chemical Warnings

ChemDraw checks chemical syntax as you draw. If it finds an error in your structure, a wavy red box appears around the object. The box displays on the screen only and does not print.

Disabling Chemical Warnings

Warnings display by default. To disable chemical warnings, navigate to **View>Show Chemical Warnings**.

To disable error checking on a specific object, right-click the object and deselect **Display Warnings** on the context menu.

When Display Warnings is disabled for an object:

- A red box does not appear around the object.
- Problems are reported by the Check Structure command (Navigate to **Structure>Check Structure**).

To view a description of the problem, perform one of the following:

- Point at the warning with the mouse to display a tool tip that describes the error.
- Right-click the warning and select **Explain This Warning**.
- Select the structure and navigate to **Structure>Check Structure**.

Warning Preferences

To select which types of chemical warnings to display:

1. Navigate to **File>Preferences**.
2. Click the **Warnings** tab.
3. Select the types of warnings and click **OK**.

The types of warnings are listed below:

Warning	Description
Valence and Charge Errors	An Object drawn has an improper valence or charge. For example, when positive and negative charges have been assigned to the same element, charges have been assigned in more than one way, or a charge has been assigned to a nickname, generic nickname, or alternative group name.
Unbalanced Parentheses	Parentheses are not matched into nested open-close pairs.
Invalid Isotopes	Generated for invalid isotopes. For example, this warning is generated for every label that has a numeric superscript immediately preceding an atomic symbol, where the superscripted number does not correspond to a recognized isotope. For example, $^{24}\text{CH}_3$.
Isolated Bonds	An unlabeled single bond is not attached to other bonds.
Atoms Near Other Bonds	An atom is close to a bond but not attached to it.
Unspecified Stereochemistry	An asymmetric center is without attached wedged, hashed, dashed, or bold bonds.
Ambiguous Stereochemistry	A stereocenter where the absolute stereochemistry cannot be determined from the structure as drawn. For example, this warning would be generated for a carbon atom attached by bold bonds to four different ligands.
Stereobond between Chiral Atoms	A stereobond connects two stereocenters.

Warning	Description
Linear Atom	An unlabeled atom is attached to exactly two identical bonds that create a 180 degree angle.

BioDraw (Professional Level only)

ChemDraw includes a variety of tools for drawing metabolic pathways, such as enzymes and receptors. To display the BioDraw toolbars, navigate to **View>Show BioDraw Toolbar**.

You can also include standard shapes, such as, circles, ellipses, and arrows, using the Drawing Elements tool palette or the Arrows tool palette. You can also create custom shapes using the Curve tool.

You can change the color of an object, change its line and fill properties, and rotate it.

To create a BioDraw object, either click or drag on the page where you want it to appear. Clicking gives you the default size and shape, dragging lets you not only scale the object, but also distort it by dragging on the X and Y axes. Linear objects elongate in the direction they are dragged. The membrane and protein tools (DNA and helix) add more subunits as they are dragged and display the subunit count. You can also ungroup an object and move, or remove, unwanted parts and retain only those parts of the object that you require.

To ungroup an object:

1. From the context menu, navigate to **Group>Integral**.
2. Select **Group>Ungroup**. The object is ungrouped and you can move each object independently.

BioDraw Templates

ChemDraw Professional includes a variety of templates for illustrating biological systems in full color for publication.

1. To open a template:
2. Navigate to **View>Templates**.

Select the template toolbar you want. Some of the available BioDraw templates are shown below.

Advanced BioDraw

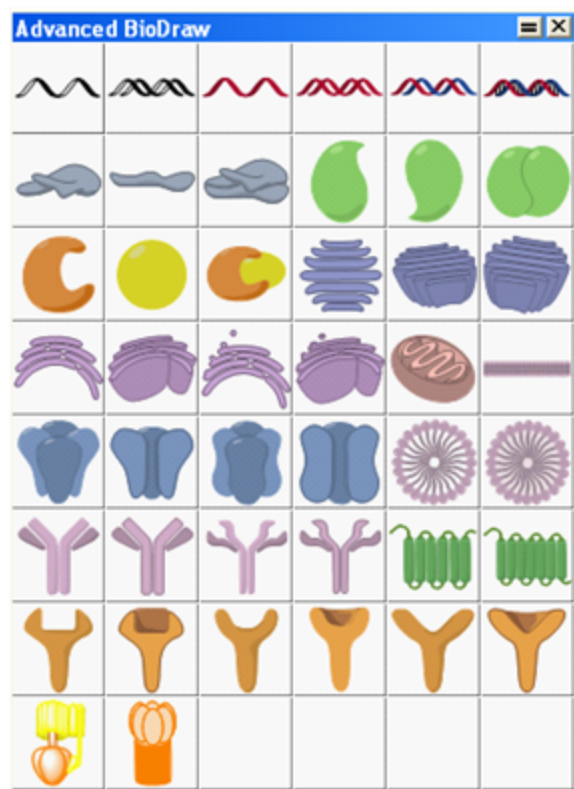

Anatomy Templates

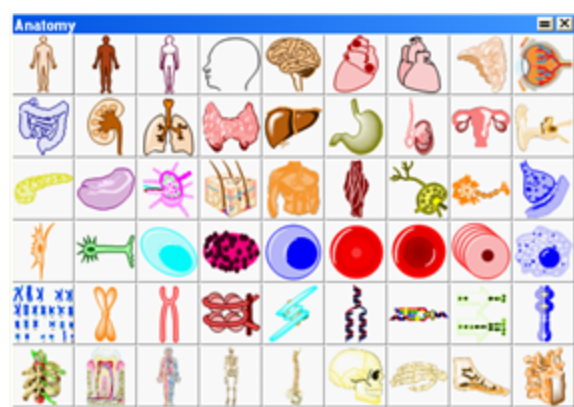

Animals



Bio Instruments



Microorganisms



Organelles

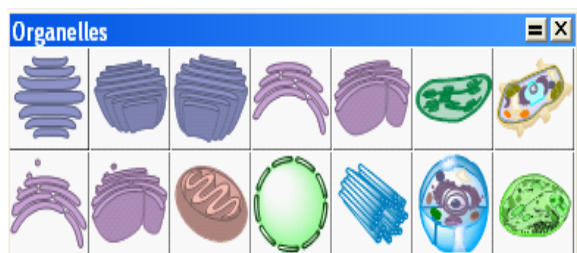

For more information, see ["Templates" on page 144](#).

Customizable Objects

The table below describes the BioDraw objects in the BioDraw toolbar, which can be customized. When customizing a BioDraw object, you must use a selection tool, or the same tool used to create it.

Tool	Customization Options
Receptor	width
G-protein, gamma subunit	shape
Helix Protein	height, width of the strands, width of the cylinders, spacing
DNA	height, width of the strands, offset of the second strand, spacing
Membrane (line)	size of subunit (The overall length remains constant, and the number of subunits changes in inverse proportion to the size.)
Membrane (arc)	length, arc, size of subunit
Membrane (ellipse)	size of subunit
Micelle	size of subunit
Plasmid map	add/adjust markers and regions
Ribosomes	resize, color
tRNA	resize, color

These tools in the BioDraw toolbar cannot be customized:

Ion channel	G-protein, alpha subunit
Ion channel	G-protein, beta subunit
Immunoglobulin	Golgi body
Endoplasmic reticulum	Mitochondrion
Cloud	resize, color

Membrane Line

1. Select the membrane line tool from the BioDraw toolbar.
2. Click and drag to draw a membrane line of the size you want or click for the default size.

When orienting the membrane, note that you are constrained to 15 degree increments when fixed angles are applied (navigate to **Object>Fixed Angles**). To override the constraint, press **<shift>** key as you drag.

To resize the membrane units, click and drag the adjustment handle at the membrane center.

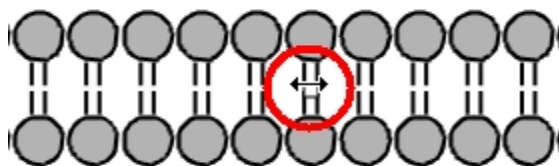

 **Tip:** To change the length, select the membrane and drag the left or right handle of the selection box. You can deselect it and readjust the subunit size.

Membrane Arc

To create a membrane arc, click and drag in a curve using the Membrane Arc tool in the BioDraw toolbar.

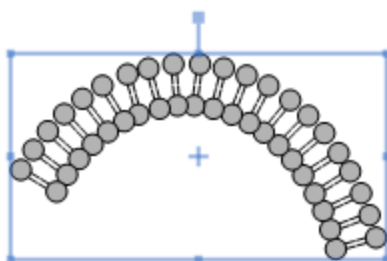

The tool has three adjustment handles:

- The handle at the starting point controls the length.
- The center handle controls the subunit size.
- The handle at the leading edge controls the arc.

Helix Proteins

To create a helix protein:

1. Select the Helix Protein tool from the BioDraw toolbar.
2. Drag in the document window, or click to draw the default size.

When orienting the protein, note that you are constrained to 15 degree increments when fixed angles are applied (navigate to **Object>Fixed Angles**). To override the constraint, press **<shift>** key as you drag.

The helix protein has four adjustment handles: height, width of the strands, width of the cylinders, and spacing.

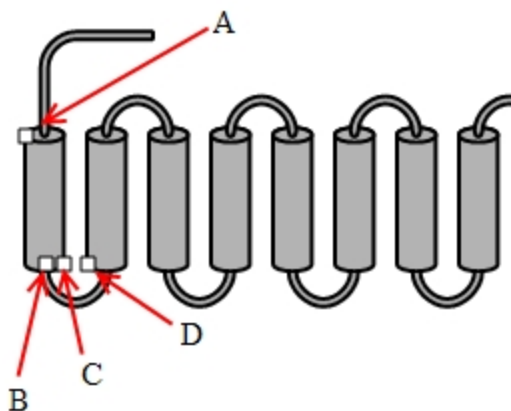

Figure 7.1: Adjustment handles on a helix protein. A) height adjustment; B) width of strands; C) width of cylinder; and D) spacing between cylinders.

DNA Molecules

To create a DNA molecule:

1. Select the DNA tool from the BioDraw toolbar.
2. Drag in the work space, or click to draw the default size.

When orienting the DNA, note that if the **Fixed Angles** option on the **Object** menu is selected, you are constrained to 15 degree increments. You can override the default by pressing **<alt>** key as you drag.

DNA has four adjustment handles: height, width of the strands, offset of the second strand, and spacing.

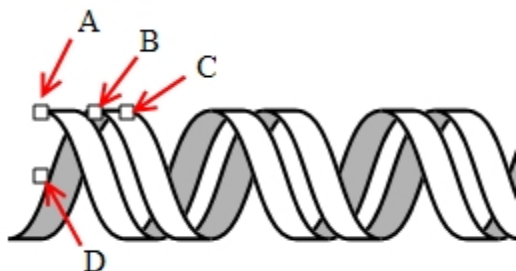

Figure 7.2: DNA adjustment handles. A) height adjustment; B) spacing; C) width; and D) offset.

Coloring Residues

After you draw a protein or DNA strand, you can color each residue using any of the coloring tools—shading, fading, or filled.

1. Using the Marquee or Lasso tool, select a residue to color.
2. Select the desired color from the Color menu.
3. On the **Curves** menu, select either **Filled**, **Shaded**, or **Faded**.

tRNA

To create a tRNA molecule:

1. Select the tRNA tool from the BioDraw toolbar.
2. Click and drag in the workspace until the tRNA object is the desired size.

Once you draw the tRNA molecule, you can modify it accordingly.

Ribosomes

To draw a Ribosome:

1. On either the Ribosome or BioDraw toolbar, select a Ribosome tool.
2. Click and drag in the workspace until the Ribosome object is the desired size.

Once you draw the object, you can modify its appearance.

Plasmid Maps

To draw a plasmid map, you first enter the number of base pairs you want your map to represent, and then add markers. A simple pBI plasmid map is shown below.

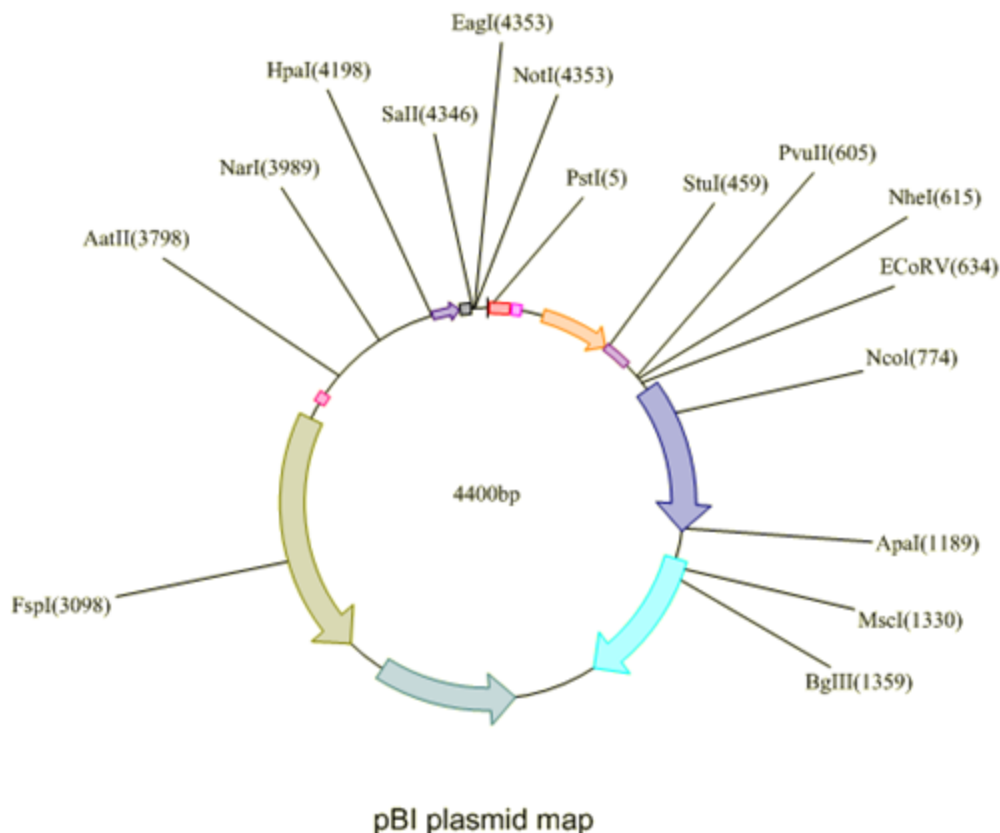

Creating a Plasmid Map

1. From the BioDraw Toolbar, select the Plasmid Map tool.
2. Click in the drawing window where you want the plasmid map. The Insert Plasmid Map dialog appears.
3. In the Insert Plasmid Map dialog, enter the number of base pairs in the map, and click **OK**. The plasmid map is drawn.

Adding Regions

Regions represent the fragments in the plasmid. You can add as many regions you want to your map.

To add regions:

1. Right-click the plasmid map and select **Regions** in the context menu.
2. In the Regions dialog, enter the base pairs numbers for the start and end of the fragment into their respective fields. For example, if a fragment includes all base pairs from 1 to 1000, type 1 and 1000 in the text fields.
3. For the **Start** and **End** base pair numbers for the fragment to appear in the drawing, select **Add Markers At Region Ends**.
4. Click **Add**.

- To add additional regions, repeat steps 2-4.
- Click **OK**.

Adding Markers

Markers let you annotate base pairs in the plasmid map. For example, to label a base pair or fragment, add a marker to it.

To add a marker:

- Right-click the plasmid map and select **Markers** in the context menu.
- In the Markers dialog box, enter the number of the base pair for which you want to add a marker in the **Position** box.
- In the **Label** text box, enter the text to identify the marker.
- Click **Add**.
- Click **OK**.

Moving Markers

To move a marker label, click and drag the label. You can also edit the value in the label.

Resizing Regions

You can resize region arrows to indicate different base pairs, or extend them outward to emphasize them.

- Hover over the end of the region's arrow using a selection tool. The arrow's resize handles appear and the cursor changes to a double-arrow (↔).
- Click and drag a resize handle to adjust the size of the arrow.

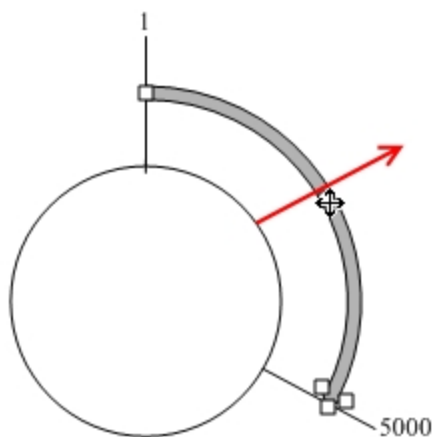

To extend an arrow, click and drag its center handle as indicated by the cursor (↔) in the figure above.

Enhancing the Drawing

A plasmid map is like any other drawing. You can add color and add shade to it, change line widths, or modify its text.

Drawing Biopolymers

Biopolymers are complex molecular assemblies that adopt precise and defined shapes and structures. Their defined shape and structure are in fact keys to their role. Biopolymers are chain-like molecules made up of repeating chemical blocks and can be very long in length. Biopolymers are classified in three groups, depending on the nature of the repeating unit they are made of:

- Polysaccharides are made of sugars
- Proteins of amino acids
- Nucleic acids of nucleotides

ChemDraw provides a friendly interface allowing users to draw biopolymers and create sequences easily. Using the Biopolymer editor, users can draw polypeptides and nucleotide sequences using pre-defined labels assigned to nucleic and amino acids. You can expand, contract, or remove labels to complete the drawing.

To display the Biopolymer toolbar, navigate to **View>Show Biopolymer Toolbar**. The Biopolymers toolbar appears:

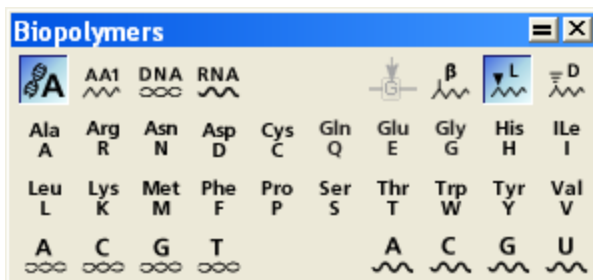

The Biopolymers toolbar includes the following options:

- **Biopolymer Editor:** Enables all the nucleic and amino acids
- **Single Letter Amino Acid:** Enables all the amino acids
- **Beta Amino Acids, L-Amino Acids, D-amino Acids:** Enables addition of Beta, L-, and D- amino acids
- **DNA Sequence:** Enables the deoxyribonucleotides that can be used to create a DNA molecule
- **RNA Sequence:** Enables the ribonucleotides that can be used to create a RNA molecule

To draw a sequence:

1. Select one of these tools from the Biopolymer toolbar:

AA1 tool (Single-letter amino acid tool). Create a polypeptide chain using a one-letter label to represent each amino acid.

You can create the sequences by typing the IUPAC code for the standard amino acids, or by pressing the icons on the toolbar. By default, L amino-acids are created. Single-letter sequences are drawn with a fixed separation, so that residues align with residues in adjacent rows. You can create D-amino acids using the D amino acid stereochemistry option.

Single-letter D-amino acids are displayed in lower case. Three-letter D amino acids have the prefix "D-".

 **Note:** The <SHIFT> key acts as a toggle. Hence, to enter D-amino acids, press <SHIFT> while entering a single-letter sequence while in L mode. Alternatively, to enter L-amino acids while in D mode, press <SHIFT> while entering a single-letter sequence.

 **Note:** You can enter three-letter amino acids using the "Biopolymer Editor" on page 108, and you can use either the keyboard or toolbar to enter residues.

DNA tool. Create a DNA chain using labels that represent each of the nucleic acids.

RNA tool. Create an RNA chain using nucleic acid labels.

2. Click where you want to start the sequence. A text box appears.

3. In the text box, enter the single-letter label for the residue.

 **Note:** For a list of residue labels, see "IUPAC Codes" on page 118.

4. Repeat step 2 for each residue.

5. When your chain is complete, press <ENTER>, or <Esc>.

By default, when creating a sequence, new residues are inserted after the current active residue. The insertion point is indicated by an orange chevron. You can overwrite or replace a sequence atom using the residue replacement button. You can also replace a sequence atom by hovering over a residue and pressing a hotkey, when no active residue is present.

Biopolymer Editor

The Biopolymers toolbar contains a tool called Biopolymer Editor.

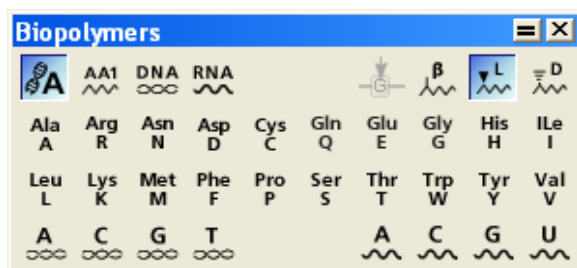

Using the biopolymer editor, you can create a sequence by explicitly specifying the residue name instead of the IUPAC code. When you enter a letter, the auto-completion feature suggests a match with a known residue in the library. For example, when you enter 'a', the residue 'Ala' is suggested. To accept the suggestion, press <SPACE> or <ENTER> key. Press TAB to move the caret to the end of the selected label.

To enter β amino acids, type a nickname such as bAla. The 'b' is converted to the β symbol. You can also create β amino acids using the β -amino acid button in the biopolymer editor. β -amino acids always display using three-letter codes. Glycine does not have a beta carbon, and so there is no beta version.

To enter D-amino acids, specify "d-" before the residue name. Glycine is also achiral and so does not have a D version.

 **Note:** Use the D- amino acid and β - amino acid buttons simultaneously to produce D- β amino acids.

You can also overwrite and replace the sequence atoms using the residue replacement button in the biopolymer editor. For more information, see ["Replacing Residues" on page 115](#).

Toggle Amino Acids

Toggle Amino Acid Style AA1<->AA3 option lets you change the amino acid representation from single letter to triple letter and vice versa. For example,

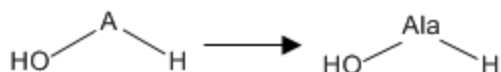

1. Select the sequence.
2. Right-click and select **Toggle from Amino Acid Style AA1<->AA3**.

You can also change the amino acid representation of expanded, substituted, and protected amino acids. For example,

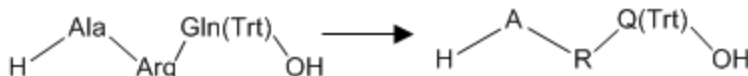

The **Toggle Amino Acid Stereo L<->D** option lets you change the stereochemistry of the amino acid from L to D and vice versa.

To toggle amino acids:

1. Select the sequence.
2. Right-click and select **Toggle Amino Acid Stereo L<->D**.

Protecting Groups

You can add protecting groups such as Trt and Fmoc to amino acids containing additional NH_2 or OH groups (Arg, Aad). Protected groups are specified within brackets '()'.

To add a protecting group:

1. In a sequence, enter '(' after a completed residue name as shown below:

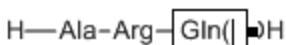

2. Enter the name of the protecting group and enter ')' at the end of the name.



The name of the protecting group determines if it will protect the NH_2 or OH group. If prefixed by O, then it protects the OH group.

You can expand and contract protected residues just like any other residue.

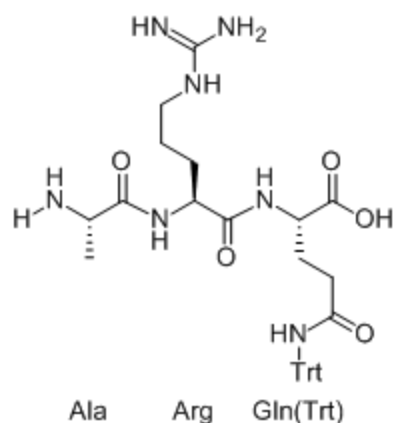

If no leaving group is found, after you enter ')', a dialog prompts you to specify the attachment point.

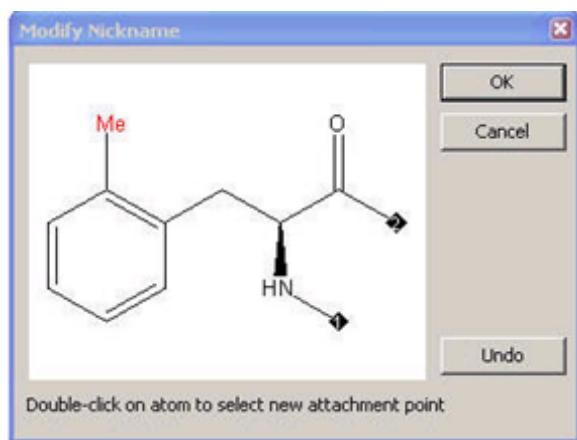

You can expand and contract protected residues just as any other residues.

Pasting Sequences

You can paste sequences in FASTA format. Since only single-letter IUPAC codes are present in the FASTA format, you must indicate whether this corresponds to a peptide, DNA, or RNA biopolymer sequence. You can paste ALL IUPAC symbols for residues, with the exception of those characters indicating spaces or omissions.

To paste a sequence:

1. Right-click and navigate to the **Paste Special** sub menu.

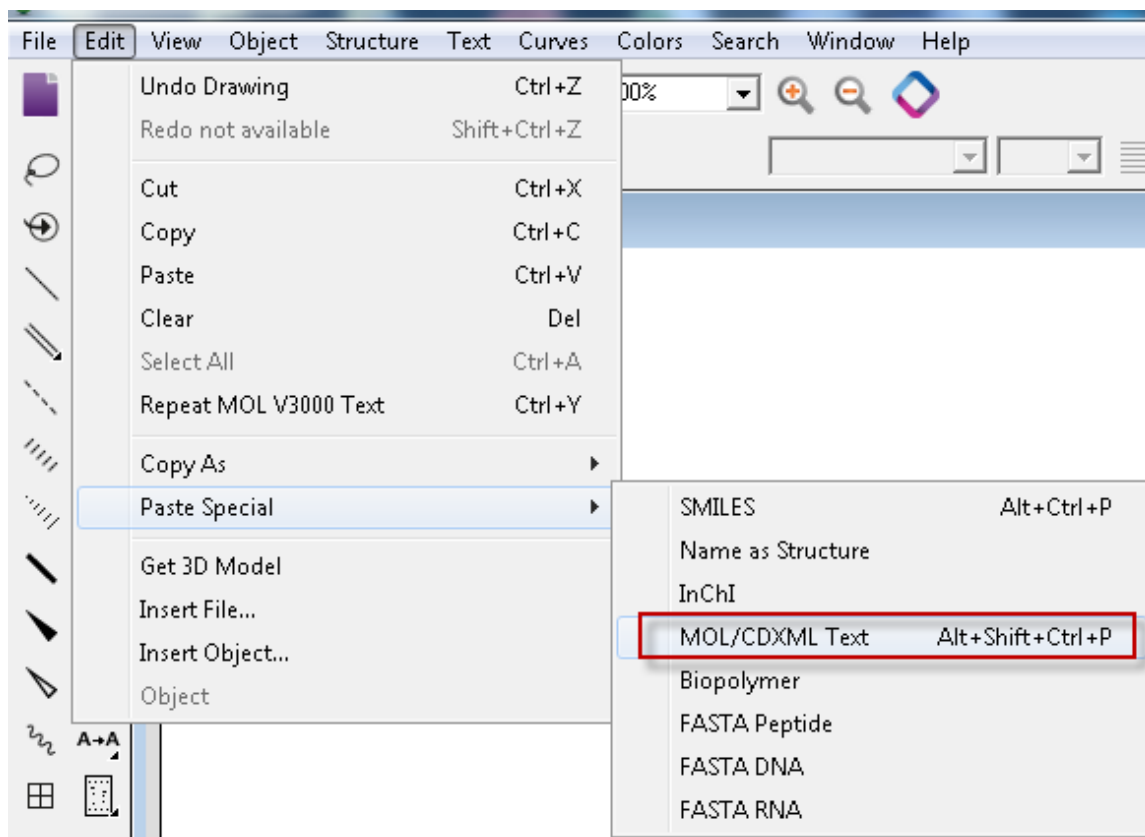

2. Select one of three options to paste:

- FASTA Peptide
- FASTA RNA
- FASTA DNA

```
>gi|5524211|gb|AAD44166.1| cytochrome b [Elephas maximus maximus]
LCLYTHIGRNIYYGSYLYSETWNTGIMLLITMATAFMGYVLPWGQMSFWGATVITNLFSAIPYIGTNLV
EWIWGGFSVDKATLNRFFAFHFILPFTMVALAGVHLTFLHETGSNNPLGLTSDSDKIPFHPYYTIKDFLG
LLILLLLLLLLALLSPDMLGDPDNHMPADPLNTPLHIKPEWYFLFAYAILRSVPNKLGGVVALFLSIVIL
GLMPFLHTSKHRSMMLRPLSQALFWTLTMDLLTLTWIGSQPVEYPYTIIGQMASILYFSIILAFPLIAGX
IENY
```

When you hover your mouse over the residue, a description of the residue and sequence data appears.

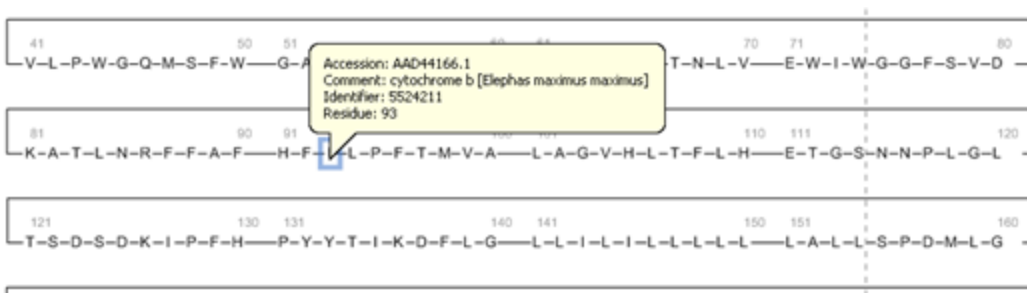

Paste Text Strings

You can also paste text strings with valid separators. Space, tab, and dash are considered as valid separators. The text string you copy can be generated within or outside of ChemDraw. The text strings must contain valid residue names/nicknames, optionally including termini. If no termini are explicitly defined, then default termini is assigned. To paste a text string:

1. Copy the text string (for example, "H-Ala-Gly-Pro-NH₂") and right-click in an empty space.
2. From the context menu, select **Paste Special>Biopolymer**. The text string is pasted as a sequence.

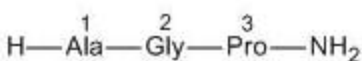

 **Note:** The labels in the text string must correspond to explicit nicknames.

Expanding Sequences

After creating a sequence, you can expand the whole sequence, or just specific labels.

To expand a sequence:

1. Select one or more labels in the sequence using lasso tool or marquee tool. (Hold down the <SHIFT> key to select more than one.)
2. Navigate to **Structure>Expand Label**.

When you expand a residue into its structure, the label appears below the structure.

 **Note:** Brackets are now supported within biopolymer sequences. Biopolymers with repeated units will be chemically interpreted. Expansion and contraction of biopolymers will also consider brackets. On expansion, the brackets (and chemistry) are preserved and the structure is not explicitly expanded.

Contracting Labels

To collapse the structure back to its label (in the sequence):

1. Double-click the label to select the structure.
2. Navigate to **Structure>Contract Label**.

If you edit the label prior to contracting the structure, the new label text is incorporated into the contracted structure. For example, if you modify a residue, and change its name from Ala to Ala', on contraction, the sequence contains the string Ala'.

Clean Up Biopolymers

After you contract the labels, you can use the **Clean Up Biopolymer** command to clean the sequence. This command re-arranges the sequence so that the residues are aligned, and wrapped. To specify the number of residues per

line' and the number of 'residues per block' in a biopolymer, select the biopolymer and navigate to **Object > Object Settings > Biopolymer Display** tab.

Modifying Sequence Residues

 **Note:** When you modify a residue structure in your drawing, you must define a new nickname to ensure that the contracted label includes your changes.

To modify a sequence residue.

1. If the residue in the sequence is contracted, right-click the residue and select **Expand Label**.
2. Modify the residue.
3. Using the Text tool, rename the residue label to reflect a new structure. In the example below, the "Ser" label has been renamed as "hSer" (for homoserine).

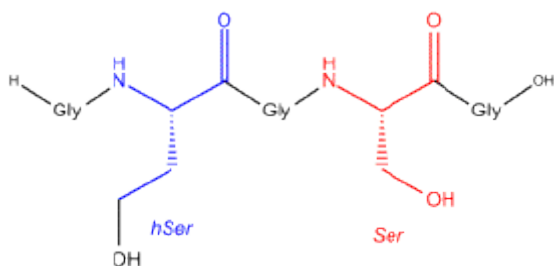

Figure 8.1: Two expanded serine residues. The residue on the left has been modified to create homoserine.

To contract a label:

1. Using a selection tool, right-click the residue label and select **Select Linked Objects**, or double-click on the label for the expanded residue, and the associated structure is selected.
2. Navigate to **Structure>Contract Label**.

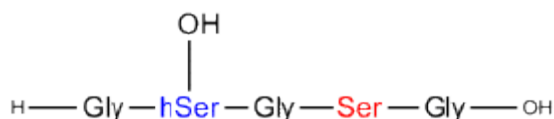

Figure 8.2: The contracted label.

You must define a new nickname to ensure that the contracted label includes your changes. For example, you can define a new nickname 'hSer', which includes the hydroxyl group in the residue definition itself.

Merging Sidechains with Residue

The **Merge Sidechains With Residue** feature lets you edit an expanded residue and then integrate those changes into the residue definition.

To merge a side chain:

1. Double-click the residue label to select the residue.
2. Right-click and select **Biopolymer>Merge Sidechains With Residue** from the context menu. The entire side-chain is merged with the residue.

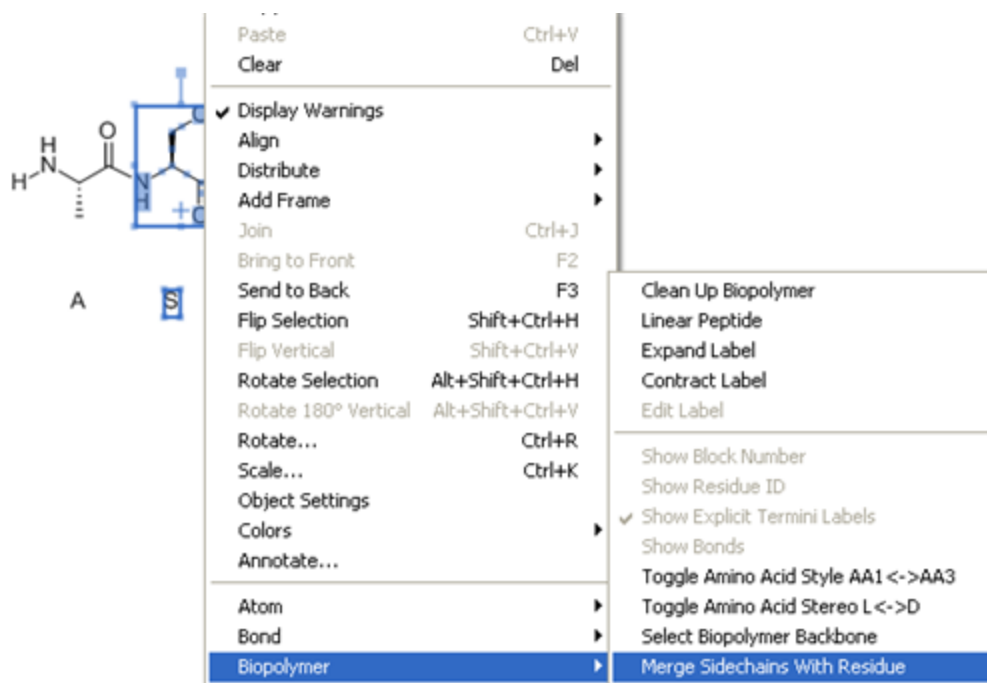

The residue is selected and you can edit the residue label.

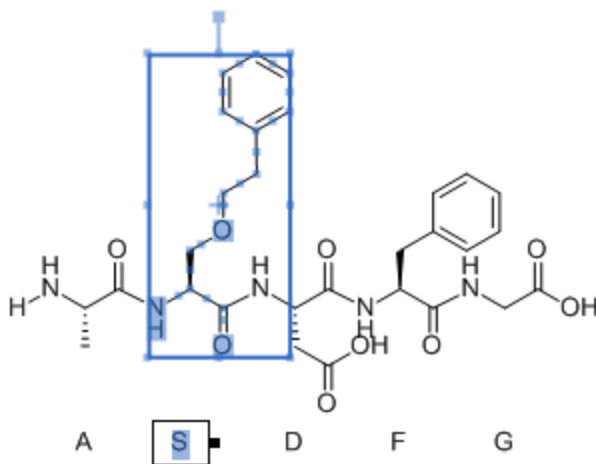

Removing Residues

When you remove a residue, the bonds are automatically re-created between the adjacent labels, and any gaps closed.

To remove a residue:

1. If the label is expanded, contract the structure back to its label.
2. Select the label, or hover over it.
3. Press the <DELETE> key.

Replacing Residues

The Biopolymer toolbar has two distinct modes of data entry: Insertion mode and Replacement mode. Insertion mode is the default mode. In the Insertion mode, an orange chevron indicates the position in which the next residue will be inserted. For example, the orange chevron in the sequence below indicates that the next residue will be inserted after the 4th Gly residue.

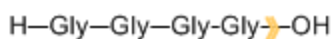

You can replace a residue in a sequence using the Replace current residue button in the biopolymer toolbar. In the replacement mode, an orange rectangle indicates which residue is replaced. For example, the orange rectangle in the sequence shown below indicates that the 3rd 'G' residue will be replaced.



The method of replacing residues is demonstrated for tetraglycine sequence below:

1. Draw a tetraglycine sequence.



2. Select Biopolymer Editor in the Biopolymer toolbar.
3. In the tetraglycine sequence, click on the 4th "Gly" residue. An orange chevron indicates the position where the next residue will be inserted:

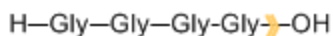

4. Select "Replace current residue" mode in the biopolymer toolbar. The "Gly" text is selected.
5. Type "Ala" or click the "Ala" button to replace "Gly".



To change the form of a residue:

- Use the sequencing tool to select the residue you want at the end of the first line (such as 'His' in the example above).
- Press <ALT>+<ENTER> on your keyboard.

Hybrid Biopolymers

You can create mixed or hybrid biopolymers using the Biopolymer toolbar by combining the various Biopolymer tools. Hence, you can insert nucleic acid into amino acid sequences and vice-versa, and RNA and DNA can be used together.

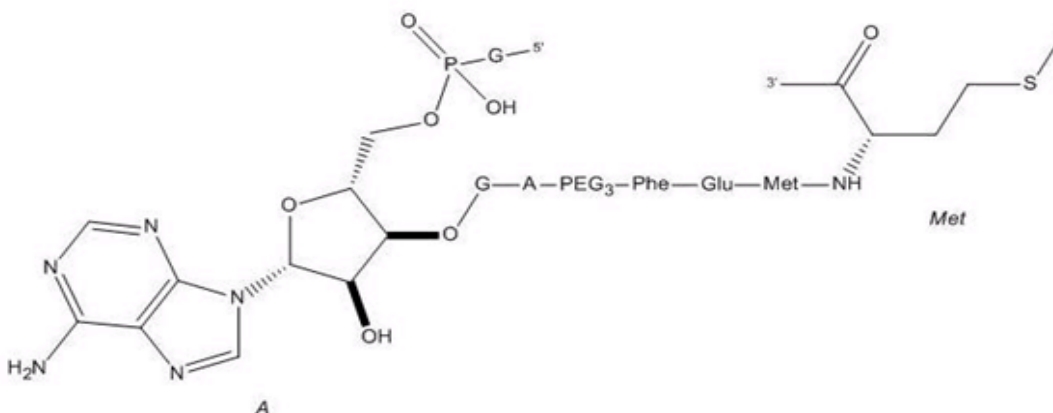

Branched Biopolymers

Residue labels typically have two attachment points. However, you can add attachment points so that the sequence branches. For example:

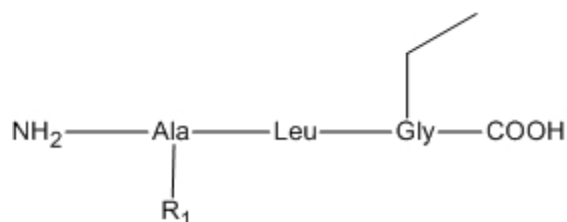

When you add an attachment point, you specify the atom in the expanded label to which the bond will attach.

To bond from a sequence:

- Draw a bond starting at the label from which to create a branch. The Modify Nickname dialog appears, displaying the sequence structure you selected.
- In the Modify Nickname dialog, double-click the atom in the structure on which you want to add the attachment point. A new attachment point appears.
- Click **OK**.

IUPAC Codes

Use these codes to enter nucleotides or amino acids in your sequence:

IUPAC Nucleotide Code	Base	IUPAC Amino Acid Code	Three Letter Code	Amino Acid
A	Adenine	A	Ala	Alanine
C	Cytosine	C	Cys	Cysteine
G	Guanine	D	Asp	Aspartic Acid
T (or U)	Thymine (or Uracil)	E	Glu	Glutamic Acid
R	A or G [Either puRine]	F	Phe	Phenylalanine
Y	C or T [Either pYrimidine]	G	Gly	Glycine
S	G or C [Three hydrogen bond (Strong)]	H	His	Histidine
W	A or T [Two hydrogen bonds (Weak)]	I	Ile	Isoleucine
K	G or T [Keto group in base]	K	Lys	Lysine
M	A or C [AMine group in base]	L	Leu	Leucine
B	C or G or T [Not A (B is letter after A)]	M	Met	Methionine
D	A or G or T [Not C]	N	Asn	Asparagine
H	A or C or T [Not G]	P	Pro	Proline
V	A or C or G [Not U in RNA context; not T in DNA context]	Q	Gln	Glutamine
N	any base [A/U/G/C in RNA context;	R	Arg	Arginine

A/T/G/C in DNA con-
text]

S	Ser	Serine
T	Thr	Threonine
V	Val	Valine
W	Trp	Tryptophan
Y	Tyr	Tyrosine

The tables below list the three letter codes for non-specific and non-proteinogenic amino acids.

IUPAC Amino Acid Code	Three Letter Code	Non-specific Amino Acid
B	Asx	asparagine or aspartic acid
Z	Glx	glutamic acid or glutamine
J	Xle	leucine or isoleucine
X	Xaa	Any amino acid (no nickname)

IUPAC Amino Acid Code	Three Letter Code	Non-proteinogenic Amino Acid
O	Pyl	Pyrrolysine
U	Sec	Selenocysteine
	Aib	α -Aminoisobutyric acid
	Abz	2-Aminobenzoic acid
	Nle	Norleucine

Cyclic, Crosslinked, and Branched Peptides

You can create cyclic peptides by bonding together the terminal residues in a peptide sequence. A looped bond indicates the peptide is cyclic. An example of cyclic peptide is shown below:

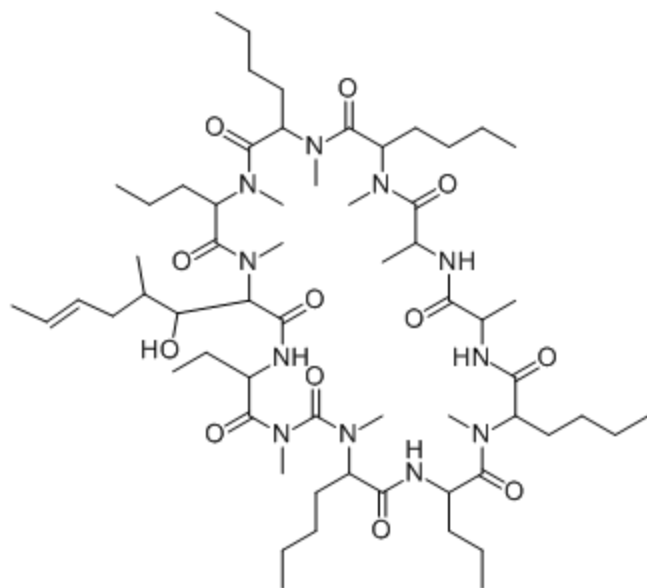

You can create a crosslinked peptide such as insulin, using the biopolymer tool and bond tool.

Branched Peptides

A branched peptide is formed where a residue has multiple possible leaving groups. For example, Arg has two amino groups and Asp has two carboxyl groups. A polymerization reaction could potentially take place at either of these groups, or at both. Hence protecting groups are often employed during the polymerization reactions to selectively allow polymerization at only a single site.

Consider the following example in which the peptide is branched at the Asp residue:

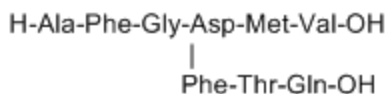

In the following example, the residue is branched at the Arg residue:

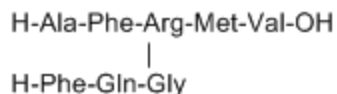

You can create a branched peptide using the solid bond tool to connect the branching residue in the first chain to the branching residue in the second chain. If the residues have leaving groups that can be automatically found, then it branches at those points. Otherwise, the Modify nickname dialog appears and you need to manually define the third attachment point. Consider the following example for creating branched peptide:

1. Draw two biopolymer chains as shown below:



- Using the solid-bond tool, drag from the lower chain's Gly-3 to the upper chain's Arg-3. The terminal hydrogen on the lower chain is removed and the branched peptide appears as:

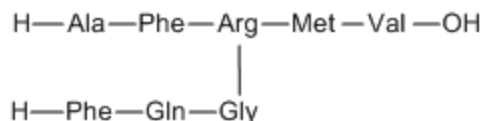

If the residues does not have leaving groups that can be automatically found, the Modify nickname dialog appears and you need to manually define the third attachment point. Consider the following example,

- Draw two biopolymer chains as shown below:

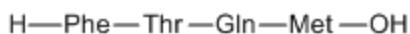

- Using the solid-bond tool, drag from the lower chain's Met-4 to the upper chain's Met-5. Since neither of these residues have defined leaving groups, the Modify Nickname dialog appears twice, once for each residue.

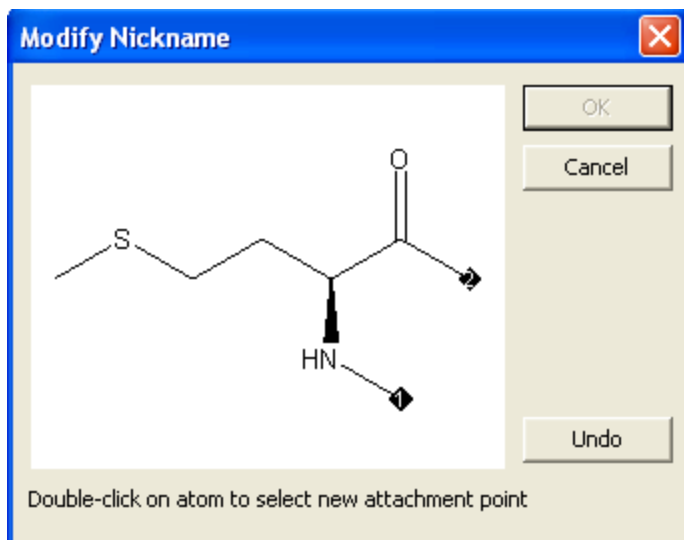

- Define new attachment points. The resulting structure is:

Lactam Bridges

You can draw lactam bridges between Lys-Asp and Lys-Glu residues. The residues connect via amide bonds between side chains. You can also mix disulfide and lactam bridges.

To draw a lactam bridge:

1. Draw a sequence that contains Lys and either Asp or Glu.
2. Using solid bond tool, draw a bond from Lys to the other residue. An example is shown below:

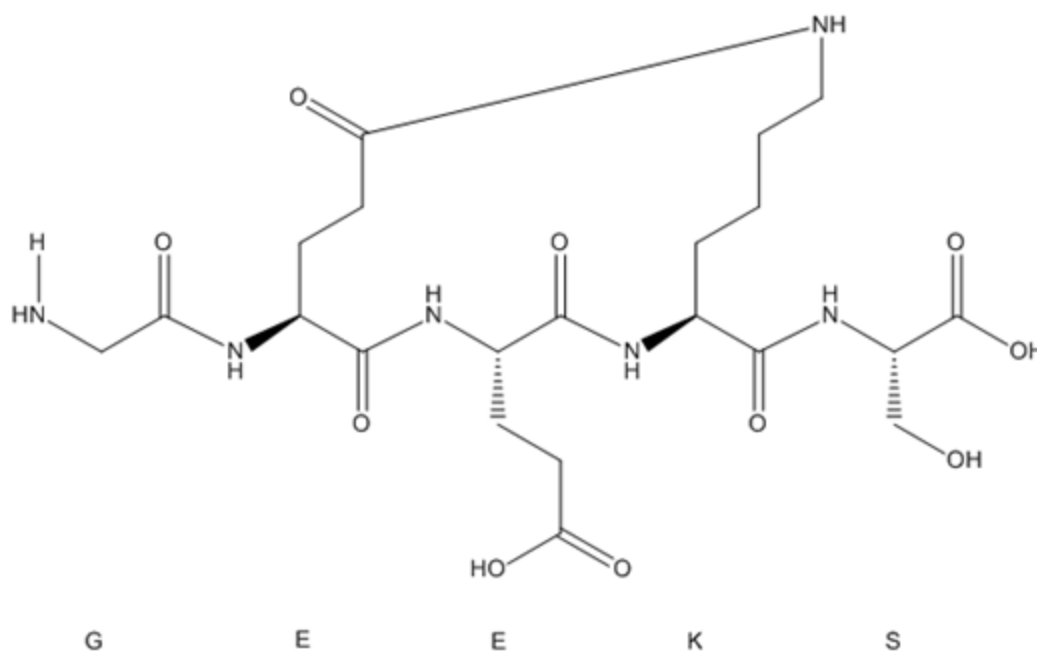
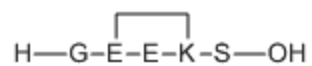

Advanced Drawing Techniques

The advanced features help you save time or perform functions that cannot be accomplished using the basic tools. For example, you can view your drawing as 3D models or create stereoisomers at the click of the mouse. Using other features, you can:

- [Add bonds to characters in atom labels](#)
- [Create bonds whose attachment is not explicitly defined](#)
- [Add atom numbers](#)
- Contract and expand sections of structures
- [View structure perspective](#)
- [Create mass fragmentation, retrosynthesis, and synthesis drawings](#)
- [Draw with templates](#)
- Create and edit templates
- Label functional groups with nicknames.

Coloring Objects

You can select and color objects, part or all of a chemical structure, boxes, curves, arrows, orbitals, and reaction mechanism symbols.

To color an object:

1. Select the object.
2. Do one of the following:
 - Click the Color button on the Style toolbar, and select the color from the menu that appears.
 - Choose a color from the **Color** menu.
 - Right-click and select the color from the context menu.
 - Navigate to **Object>Object Settings** and select the color in the Drawing tab. Click **OK** when finished.

Coloring Groups

ChemDraw colors groups differently from integral groups. When you color an integral group, its objects acquire the new color but retain the original shading. When you color a normal group, the new color is applied and the original shading is ignored.

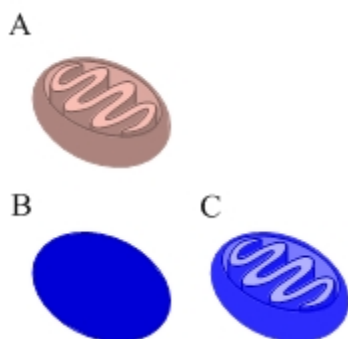

Figure 9.1: A) The mitochondrion structure in its default color; B) The structure colored blue as a group; C) The structure colored blue as an integral group.

The new color applies to all structures in the group, even if the original colors of the objects in the group are not the same. See example below:

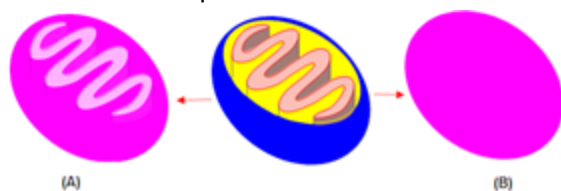

Figure 9.2: A) The structure colored pink as an integral group; B) The structure colored pink as a group.

Labels

In addition to representing atoms, labels can represent regions of a structure that you define. For example, you can assign a label to an unimportant region of a molecule and then contract that region to reduce the size of your drawing. You can then expand the label, to see the whole molecule.

Creating Labels

To create a contracted label:

1. Select the area of the structure to contract.

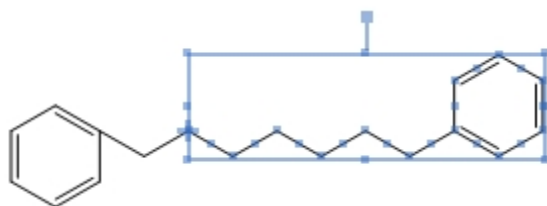

2. Navigate to **Structure>Contract Label**. The Contract Label dialog appears.
3. Type a label for the contracted structure.

4. Click **OK**.

The label replaces the selected portion of the structure.



 **Note:** If the area of the structure you contract contains errors, an error dialog appears. Click **Ignore** to view other errors. Click **Ignore All** to ignore all errors or **Stop** to end the contract process.

Expanding Labels

If your structures contain defined nicknames, long atom labels, or contracted labels, ChemDraw can restore your structures to the fully-expanded form.

To expand atom labels:

1. Select a selection tool.
2. Select the label to expand, or double-click the structure to select all labels in the structure.
3. Navigate to **Structure>Expand Label**. You can also use the **Expand Label** tool in the Structure toolbar. Your structure is redrawn in its expanded form. Below is an example of expanding labels:

Contracted:

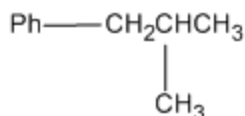

Expanded:

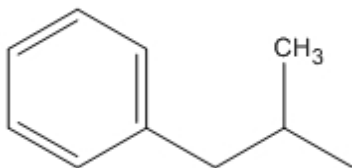

When you expand a label that contains a divalent nickname, for example **H-A1a-OH**, the attachment order depends on the order in which the bonds are created.

Multiple Atoms

Labels can comprise a group of atoms. When you expand the label, it expands to create the structure.

Contracted:

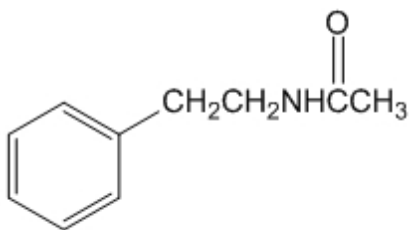

Expanded:

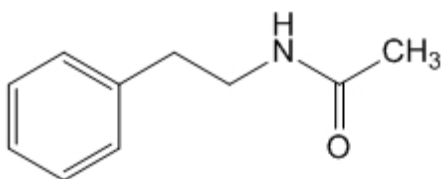

Adding a Label of Multiple Atoms

1. Using the text tool, click an atom in the structure where you need to place the label.
2. Type the formula (such as "CH₂NHCH₃").
3. Using a selection tool, select the formula.
4. Right-click the formula and select **Expand Label**, or navigate to **Structure>Expand Label**. You can also use the **Expand Label** tool in the Structure toolbar.

Adding Bonds to an Atom Label

To add bonds to an atom labels:

1. Draw the structure and attach any necessary atom label.
2. Select a Bond tool.
3. Position the cursor where you want to attach additional bonds. The selected part of the atom label is highlighted.
4. Click and drag from the atom label to draw your bonds.

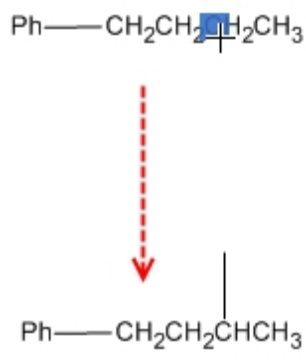

Figure 9.3: Adding bonds to a label

You can determine the orientation of the resulting bond by dragging. If you click to add a bond, there are several preferential orientations for the resulting bond as outlined below.

- Adding from the end of an atom label creates bonds that are preferentially horizontal.
- Adding from the middle of an atom label creates bonds that are preferentially vertical.
- Adding from the start of an atom label creates bonds that try to attain the chain angle setting in the Drawing Settings dialog. If that angle cannot be attained, the next best angle is used.

Attachment Points

You can draw polyhapto structures such as ferrocene ((Cp)₂Fe), or abbreviated notations for different positional isomers of a compound, using attachment points. The procedure is similar, and in both cases, the structure retains chemical significance. You can generate all possible structures from an abbreviated combinatorial structure by using Expand Generic Structure feature. For more information, see ["Expand Generic Structures" on page 265](#).

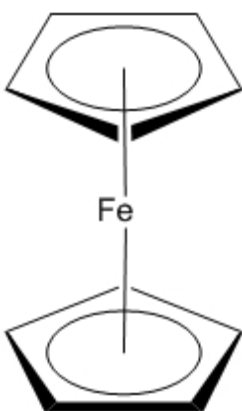

Figure 9.4: Drawing a polyhapto structure

Multi-Center Attachments

To add a multi-center attachment point to a structure:

1. Select all or part of the structure.
2. Navigate to **Structure>Add Multi-Center Attachment**. An asterisk indicates a multi-center node.

To draw a bond to a multi-center attachment point:

1. Click the bond tool.
2. Point to the asterisk and either click or drag to create a bond.

The asterisk is not visible once a bond is drawn to it. However, you can view the attachment point using a bond or selection tool.

 **Tip:** If fixed lengths is enabled, press <ALT> as you drag the bond.

Variable Attachment Points

You can use the **Add Variable Attachment** command to draw different positional isomers of a compound using an abbreviated notation that retains chemical significance.

For example, you can explicitly draw the three isomers of dibromobenzene, as shown below. Alternately, you can express all three isomers as a single parent structure by using a variable attachment as shown below.

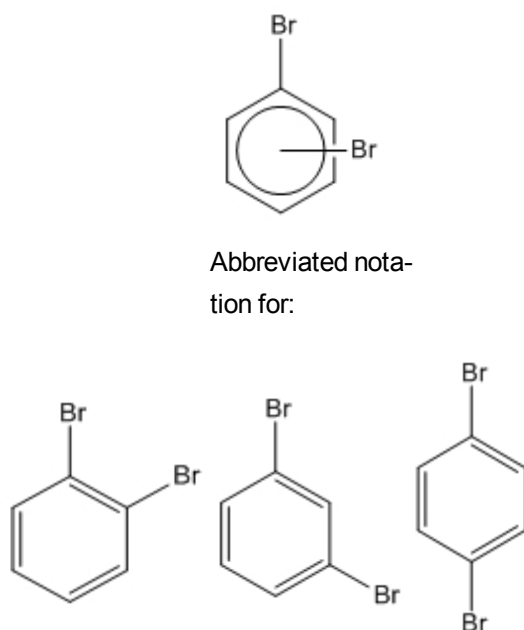





Figure 9.5: Isomers of dibromobenzene

To add a variable attachment point to a structure:

1. Select all or part of the structure.
2. Navigate to **Structure>Add Variable Attachment**.
3. Point to the asterisk in the structure and drag to draw a bond.

 **Note:** Either disable or toggle *Fixed Lengths* to draw the bond so that it extends from the ring.

 **Note:** To draw the structure below you should only select the 5 rings atom that do not already have a bromine atom bound to them. Selecting the entire molecule would cause a valence problem with the topmost carbon.

 **Tip:** If *fixed lengths* is enabled, press <ALT> as you drag the bond.

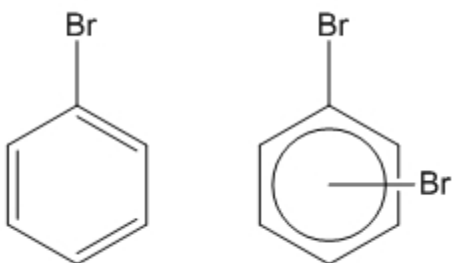

 **Note:** After you draw a bond from an attachment point, the asterisk disappears. To view an attachment point, position the cursor over it with either a bond tool or a selection tool.

Atom Numbering

You can add sequential numbers or letters to the atoms in your structure. You can add:

- Numbers (1, 2, 3, and so on)
- Text ending with a number (atom1)
- Greek letters for alpha, beta, and so on
- Letters (a, b, c, and so on)

The default indicator is numbers.

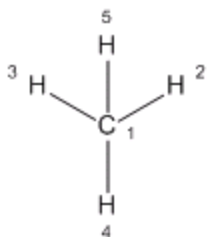

 **Tip:** To use text instead of numbers, number an atom, and then edit the number. See "Formatting Atom Numbers" below.

Showing Atom Numbers

1. Select one or more atoms to number.
2. While pointing to the selected atoms or structure, do one of the following:
 - Right-click and select **Atom>Show Atom number** in the context menu.
 - Type the hotkey ' (single quote).

To hide atom numbers:

1. Select the atoms or structure.
2. Right-click, point to **Atom**, and deselect **Show Atom Number**.

 **Note:** To remove an atom number indicator, click the indicator with the Eraser tool.

Formatting Atom Numbers

To edit the atom number text and style:

1. Select the Text tool.
2. Select the atom number and type the new text.

 **Note:** When you type a new indicator, the counter resets to the new style and you can continue numbering in that style with the standard means. For example, if you type α in a text box, then point to another atom, and use the context menu or hotkey, the atom is labeled β . Switching to another structure resets the counter.

3. To edit the atom number style, select the atom number with the Text tool and use the Text menu, or Text formatting toolbar, to change the style.

Positioning Atom Numbers

You can position each atom number anywhere around its corresponding atom and its distance from the atom.

To reposition an atom number:

1. Right-click the indicator to move and click the **Position** command on the context menu. The Position Indicators dialog appears.
2. Click the appropriate position option, and enter a value.

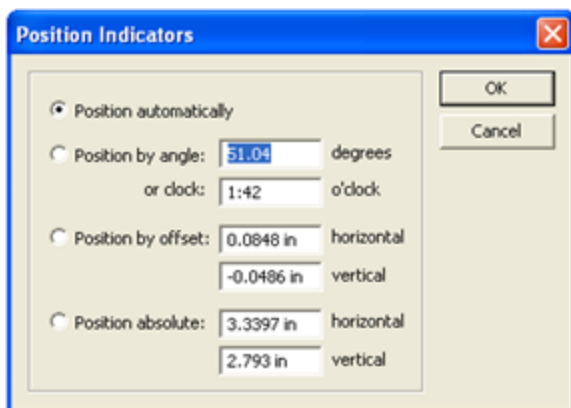
**To position****Type a Value for Position**

From the atom or bond center to the indicator center

By angle or by clock

From the atom or bond center to bottom left of indicator baseline

By offset—horizontal and vertical

At specified coordinates

Absolute—horizontal and vertical

Structure Perspective

You can tilt molecules or portions of molecules through three dimensions with the Structure Perspective tool.

To tilt a structure:

1. Select the structure with either a selection tool or the Structure Perspective tool.
2. With the Structure Perspective tool, click and drag the selected structure. Place the cursor inside the marked rectangle and drag in any direction.

 **Tip:** Use <SHIFT>+drag to limit the rotation to the X or Y axes only.

You can also select part of a complex molecule and rotate it around a particular bond.

 **Note:** You cannot apply structure perspective to orbitals.

To remove the Structure Perspective Tool effect:

1. Select the structure with the Marquee or Lasso Tool.
2. Navigate to **Object>Flatten**.

 **Note:** Flattening the structure removes its z-coordinate information but does not change its appearance.

Mass Fragmentation

Mass fragmentation mimics the molecular fragmentation in a mass spectrometer. When you apply the mass fragmentation tool to a structure, you cut through the structure, severing its bonds, and creating fragments from the

original structure. This is not a predictive tool, you must specify what bonds are to be broken.

To fragment a structure, use the Mass Fragmentation Tool to drag the cursor across one or more bonds. When you release the mouse button, bonds that you cross are broken.

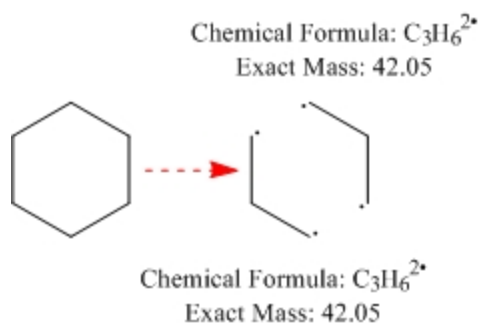

By default, the line you draw disappears when you release the mouse button.

 **Note:** To draw a curved line, or to keep the line visible, hold down the <ALT> key while drawing.

When the line crosses a bond, the formula and exact mass for the fragments on either side of the bond appear as if the bond were homolytically broken. That is, a single bond turns into a monoradical on each fragment; a double bond turns into a pair of diradicals. If more than one bond is crossed, all fragments on each side of the line are considered together. If the only bond crossed is a ring bond, a single formula/mass pair displays.

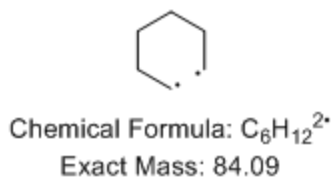

You can reposition the formula and mass displays, or delete them.

Synthesis and Retrosynthesis

ChemDraw includes two tools to help you draw synthesis reactions. The Synthesis tool draws a synthesis reaction based on a product structure that you specify. Alternatively, the Retrosynthesis tool draws the reaction with the product on the left and an arrow pointing to the reactants. These tools are in the fragmentation tools palette of the main tools palette.

To demonstrate these features, we use the Beyer Method for quinolines, starting with the structure below.

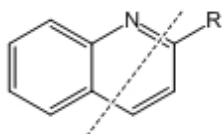

You can create either type of reaction using the appropriate tool and dragging through bonds indicated by the dotted line. For example, use the Retrosynthesis tool to create this reaction:

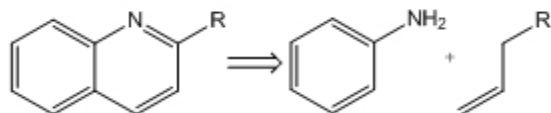
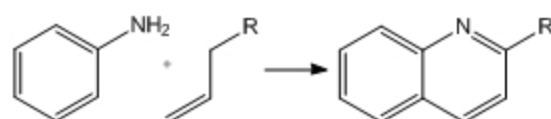

Figure 9.6: Quinoline Retrosynthesis



Quinoline synthesis

Enhanced Retrosynthesis tool

Enhanced Retrosynthesis tool is an intuitive reaction prediction tool. It enables you to analyze the synthesis of molecules by providing a list of reactions that could potentially create the selected bond. When you select an atom, the Enhanced Retrosynthesis tool will provide you with information of all the bonds going into the atom and how they are formed.

When you click on the required atom or bond, it searches a chemical database of about 300 standard organic reactions for the expressed reaction query and the hits are displayed in the Enhanced Retrosynthesis Results dialog. See example below:

Enhanced Retrosynthesis Results

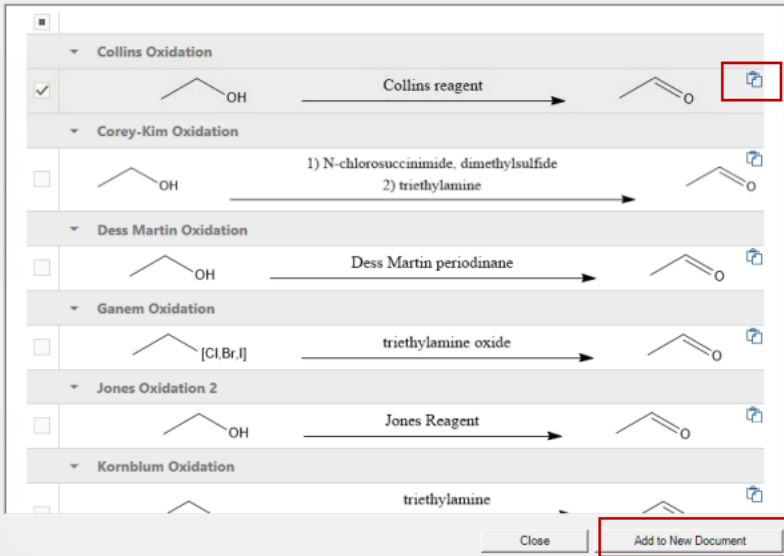

To copy any reaction in the hitlist, do one of the following:

- Click '**Copy to Clipboard**' corresponding to the desired reaction to copy it to the clipboard.
- select one or more reactions and click '**Add to New Document**' to copy it to a new Chemdraw document.

 **Note:** The Enhanced Retrosynthesis tool is available only in ChemDraw Professional.

Drawing Reactions

To demonstrate how to draw reactions, we will use this example:

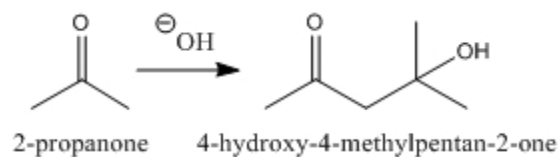

Drawing an Arrow

Starting with 2-propanone (see ["Tutorial 1: Drawing a Structure" on page 321](#)), draw the reaction arrow:

1. On the Arrows toolbar, click the third arrow from the left in the top row, as shown below:

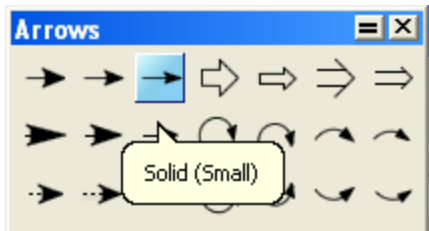

- In the document window, click and drag the mouse horizontally to the right of the 2-propanone structure. The arrow appears.
- Select the Text tool.
- Click above the arrow. A text box appears.
- Type **OH** and press <ESC>. Re-align the text box as necessary using a selection tool.

 **Note:** If **Show Chemical Warnings** is turned on (the default), a red box will appear around the **OH** label when you change tools or open another text box indicating an error. Ignore this for now.

Add a charge symbol using the Chemical Symbols tool palette:

- In the Main Tool toolbar, click the Chemical Symbol tool.
- Holding the mouse button down, select the circled **Circle Minus** symbol.
- Point to the center of the **OH** label. Move the cursor slightly right or left to select the **O**.
- With the oxygen atom selected, drag the charge symbol around the atom to the desired position.



Objects that you add from the Chemical Symbols palette are associated chemically with the structure they are near. Note that the red valence error warning disappears when you add the minus charge.

Drawing the Product

We now create 4-hydroxy-4-methyl-2-pentanone using a copy of the 2-propanone structure. You can create the product from scratch, or you can copy an existing structure.

To copy a structure:

- Select the 2-propanone structure and its caption.
- Press and hold the <CTRL> key.

The hand pointer with a plus sign indicates that you are in the duplication mode of a selection tool.

- Drag the selection rectangle to the right and release the mouse button.

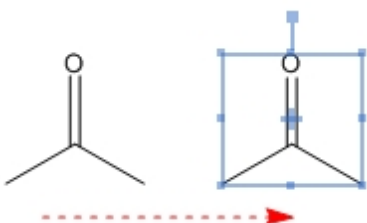

 **Note:** To keep the copy aligned with the original, press the <SHIFT> key while dragging.

Modify the duplicate structure:

1. Select the Solid Bond tool.
2. Click the far right bond of the copied structure (Figure below).
3. Point to a terminal carbon.
4. Click the carbon atom until three bonds appear, allowing a pause between each click.

 **Note:** If you click too fast, the click is interpreted either as a double-click, which opens a text box or a triple-click, which duplicates your last atom label.

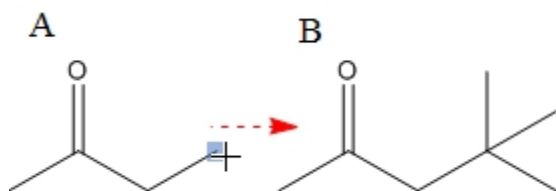

5. Point to a terminal carbon atom.
6. Type OH.

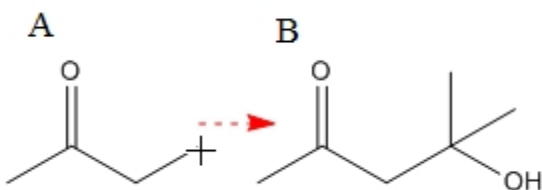

Replace the product caption:

1. Select the caption with the Text tool and type 4-hydroxy-4-methyl-2-pentanone, press the <ENTER> key and type 1 mole.
2. Using the Text tool, add 2 Mole to the caption for the reactant.

Clean Up Reactions

After you draw a reaction, you can clean the reaction using the **Clean Up Reaction** command under the **Structure** menu. When you apply the **Clean Up Reaction** command, the spacing between the reaction components is modified, the components are evenly distributed, plus signs are inserted wherever necessary, and the length of the arrow is adjusted.

To clean up a reaction:

1. Select the reaction.
2. Navigate to **Structure>Clean Up Reaction**.

If the reaction is too wide for the document, the reaction is wrapped to fill multiple lines, as shown in the example below:

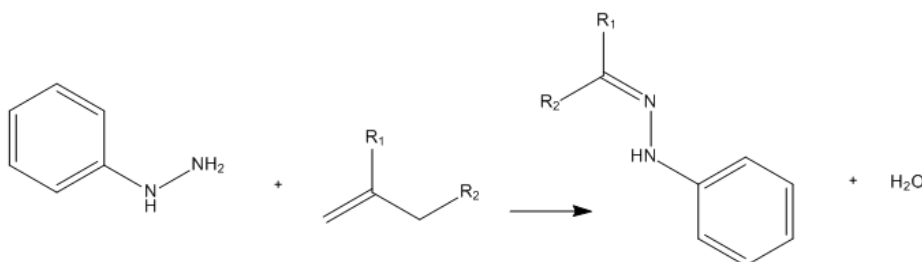

Figure 9.7: The reaction before applying the Clean Up Reaction command

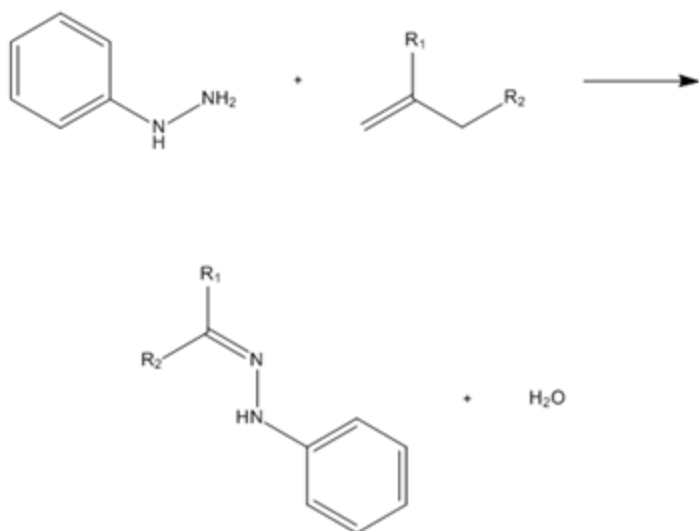



Figure 9.8: The reaction after applying the Clean Up Reaction command

 **Note:** The **Clean Up Reaction** is available only for single-step reactions.

 **Note:** The **Clean Up Reaction** command is available only for reactions with straight arrows. In case of arrows with curvatures the **Clean Up Reaction** command is disabled.

The Reaction Interpreter

The Reaction Interpreter parses reactions as drawn, and breaks the reaction into the following distinct components:

- Reaction Scheme
- Reaction Step
- Reactants
- Products
- Conditions

You can save the interpretation to disk by saving the file as CDXML. This stored data is often important if reactions are to be stored in databases.

The reaction interpreter color-codes the reactants, products, catalysts, and annotations in a reaction when you hover over them with **Show Reaction Interpretation** selected. This helps in determining whether the reaction is being correctly perceived, and lets you adjust the reaction to correct the interpretation.

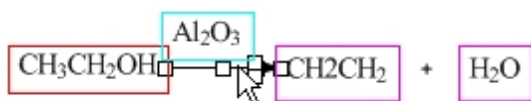

To interpret the reaction:

1. Navigate to **View>Show Reaction Interpretation**.
2. Hover your cursor over the reaction arrow.

For a reaction to be interpreted:

- Each reactant and product must contain at least one atom.
- Each reactant and product must be described using a single label.
- Multiple reactants and products should be linked by a “+” sign.
- Reaction conditions must reside completely within the left and right boundaries of the reaction arrow.
- The reaction cannot include a curved arrow.

The reaction is colored as follows:

- Reactions are red.
- Products are magenta.
- Everything above the reaction arrow is cyan.

- Everything below the reaction arrow is blue.

Electron and Radical Pushing

A common practice when illustrating organic reaction mechanisms is to use electron pushing arrows to display the transfer of electrons. ChemDraw provides the Electron Pushing and Radical Pushing tools for illustrating electron transfer. Electron transfers can be drawn between atoms, bonds, and orbitals.

To display the transfer of an electron pair:



- Select the **Electron Pushing** Tool from the Chemical Symbols toolbar.
- Click and drag the mouse from the source object to the target object and release the mouse. A full-head arrow appears signifying the electron pair transfer, such as:

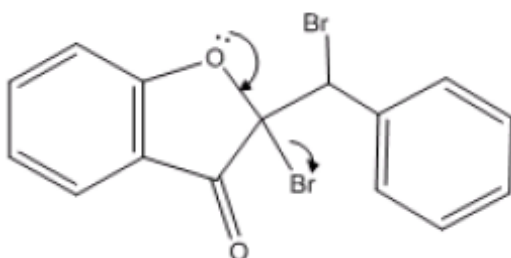

Figure 9.9: Example of electron pushing

To display the transfer of one electron:

- Select the **Radical Pushing** Tool from the Chemical Symbols toolbar.
- Click and drag the mouse from the source object to the target object and release the mouse. A half-head arrow signifying only one electron transfer appears, such as:

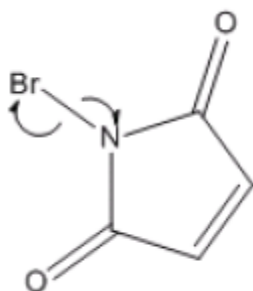

Figure 9.10: Example of radical pushing

You can delete the electron transfer arrow by either selecting or hovering over the arrow and pressing the <DELETE> key. You can modify the electron transfer arrow shape by using either the Arrow tool, or the Electron Pushing Tool. When you hover over the electron or radical pushing arrows, the associated objects are highlighted in addition to the arrows.

Stoichiometry Grid

Use the Stoichiometry Grid to calculate stoichiometric data for a reaction. The grid fills in as you modify a reaction drawing, and all calculations are done automatically.

To create a stoichiometry grid:

1. Draw a reaction, or open a file containing a reaction.
2. Navigate to **View>Show Reaction Interpretation**. Turning on **Show Reaction Interpretation** ensures the reaction is properly interpreted by ChemDraw. When you hover over the reaction, for example:



- Reactants in red
 - Products in magenta
 - Anything above and below the reaction arrow in cyan and blue
3. Select the reaction and navigate to **Structure>Analyze Stoichiometry**. The grid, with several data fields filled with default values, appears under the reaction.

<i>Reactants</i>				<i>Products</i>		
Formula	C₆H₆	CH₃Cl	AlCl₃	Formula	C₇H₈⁺	ClH
MW	78.11	50.48	133.33	MW	92.14	36.46
Limiting?	Yes	No	No	Equivalents		
Equivalents				%Completion		
Sample Mass				Expected Mass		
%Weight				Expected Moles		
Molarity				Measured Mass		
Density				Purity		
Volume				Product Mass		
Reactant Moles	0.05mol			Product Moles		
Reactant Mass				%Yield		

 **Note:** If a catalyst or condition label is above the reaction arrow, right-click the label and deselect **Interpret Chemically** in the context menu before creating the grid.

To enter data in the grid:

1. Set the limiting compound. If the default setting is incorrect, right-click the word **No** in the limiting row, and select **Set Limiting** from the context menu.

<i>Reactants</i>				<i>Products</i>		
Formula	C₆H₆	CH₃Cl	AlCl₃	Formula	C₇H₈⁺	ClH
MW	78.11	50.48	133.33	MW	92.14	36.46
Limiting?	Yes	No	No	Equivalents		
Equivalents				%Completion		
Sample Mass				Expected Mass		
%Weight				Expected Moles		
Molarity				Measured Mass		
Density				Purity		
Volume	0.05mL			Product Mass		
Reactant Moles				Product Moles		
Reactant Mass				%Yield		

2. Select the Text tool, and click where to enter the data. Enter values for all reactants, as applicable. If you are using units other than the defaults, type in the units along with the values (no space required).

Value	Comments
-------	----------

Limiting?	Indicates the limiting reactant. Only one reactant may be specified as limiting.
-----------	--

Sample Mass	Mass of reactant. Default units: g.
-------------	-------------------------------------

%Weight	Reactant purity. Defaults to 100%.
---------	------------------------------------

Volume	Default units: ml. Requires either a molarity or a density to be entered.
--------	---

Molarity	Default units: M
----------	------------------

Density	Default units: g/ml
---------	---------------------

After you enter the minimum amount of information the values are calculated.

The values are automatically recalculated when you enter a new value, edit input, or modify the reaction. To edit input, click the input and enter the new value. For example, consider the following table:

<i>Reactants</i>				<i>Products</i>		
Formula	C₆H₆	CH₃Cl	AlCl₃	Formula	C₇H₈⁺	ClH
MW	78.11	50.48	133.33	MW	92.14	36.46
Limiting?	Yes	No	No	Equivalents		
Equivalents				%Completion		
Sample Mass		2.52g	6.67g	Expected Mass	4.61g	1.82g
%Weight				Expected Moles	50.00mmol	50.00mmol
Molarity				Measured Mass		
Density				Purity		
Volume				Product Mass		
Reactant Moles	50.00mmol	50.00mmol	50.00mmol	Product Moles		
Reactant Mass	3.91g	2.52g	6.67g	%Yield		

If you edit the value in the Reactant Moles field for the reactant in the table to 30.00 mol, the rest of the table is updated.

<i>Reactants</i>				<i>Products</i>		
Formula	C₆H₆	CH₃Cl	AlCl₃	Formula	C₇H₈⁺	ClH
MW	78.11	50.48	133.33	MW	92.14	36.46
Limiting?	Yes	No	No	Equivalents		
Equivalents				%Completion		
Sample Mass		1.51kg	4.00kg	Expected Mass	2.76kg	1.09kg
%Weight				Expected Moles	30.00mol	30.00mol
Molarity				Measured Mass		
Density				Purity		
Volume				Product Mass		
Reactant Moles	30.00mol	30.00mol	30.00mol	Product Moles		
Reactant Mass	2.34kg	1.51kg	4.00kg	%Yield		

 **Note:** Entered values are in bold-face; calculated values are in normal font.

You can show or hide rows or columns in the grid. To hide a row, right-click the row and select **Hide Row** from the context menu.

<i>Reactants</i>				<i>Products</i>		
Formula	C₆H₆	CH₃Cl	AlCl₃	Formula	C₇H₈⁺	ClH
MW	78.11	50.48	133.33	MW	92.14	36.46
Limiting?			No	Equivalents		
Equivalents				%Completion		
Sample Mass			4.00kg	Expected Mass	2.76kg	1.09kg
%Weight				Expected Moles	30.00mol	30.00mol
Molarity				Measured Mass		
Density				Purity		
Volume				Product Mass		
Reactant Moles	0.00mol	0.00mol	30.00mol	Product Moles		
Reactant Mass	2.34kg	1.51kg	4.00kg	%Yield		

To hide a column, right-click the column and select **Hide Column** from the context menu.

To display hidden rows or columns, select **Show All** from the context menu. To change the color of the text, select **Color** from the context menu.

Templates

ChemDraw includes a library of templates. You can use a template as a starting point for a new drawing or to add to an existing drawing. A palette is a set of templates.

The templates you define are not limited to atoms and bonds. Templates can also contain captions, colors, boxes, arcs, orbitals, arrows, reaction mechanism symbols, and curves. You can paste pictures from other applications into a template pane. You can download templates from the PerkinElmer Informatics web site and use them. For more information on available templates and user download-able templates, see [ChemDraw template files](#), and [BioDraw templates](#).

To open a template, do one of the following:

- Select a template toolbar from the Main toolbar.
- Navigate to **View>Templates** and select a template toolbar from the list.

To add to a drawing using a template:

1. Select the required template from the template toolbar.
2. In the document window, click and drag the mouse until the template is oriented the way you need.

 **Tip:** To modify the template size, press the <ALT> key while drawing it.

You can also use the templates to add structural features to existing drawings.

To add structural features to existing drawings:

1. Select the required template from the template toolbar.
2. Click an atom or bond in the existing drawing to add the template structure.

Customizing Templates

You can modify a template palette to create your own palette. When you create a palette, a set of empty template panes appear above the document window. After you save your palette, it contains the templates you have drawn. You can then select your palette from the palette list in the Templates tool. You can also store templates as groups, or even integral groups, so that they are treated as an individual entity within the documents into which they are dropped. To create a template palette:

1. Navigate to **File>Open Templates>New Templates**.
2. Click a template pane.
3. In the document window, draw a new structure.
4. Click another template pane and draw another structure as desired.
5. After you draw all the templates you want, go to **File>Save**.

 **Note:** Save your palette in the ChemDraw Items folder to ensure it appears in the Main toolbar.

6. In any drawing, select the Template tool on the Main toolbar to use you palette.

Modifying a Template

1. Navigate to **File>Open Templates** and choose a palette.
2. In the palette, click a template pane. The template appears in the document window.
3. In the document window, edit the template.
4. Save the template.

To add or delete a palette row or column in a palette:

1. In the palette, click a cell in the row or column.
2. Select the appropriate option in the **Edit** menu.

Adding a Template

To add a template, click in an empty template pane and draw the template in the document window. Navigate to **File>Save**.

Annotating a Template

1. Navigate to **File>Open Templates** and choose a palette.
2. Right-click on an empty space in a template pane, and select **Annotate**. The Annotate dialog appears.

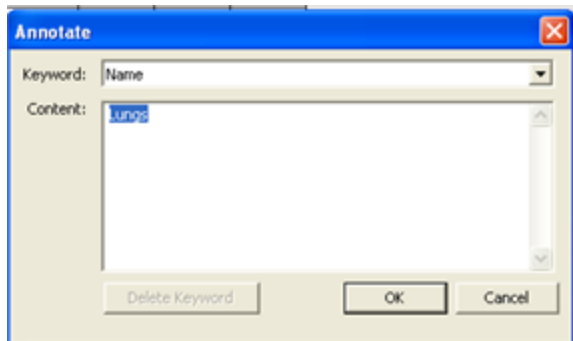

3. Specify a new name for the template in the **Content** text box.
4. Click **OK**.
5. Click **Save**. The annotation appears as a tooltip, when you point to the annotated template.

Deleting a Template

1. Select the template pane for the template to delete.
2. In the document window, select the entire drawing.
3. Navigate to **Edit>Clear**.
4. Navigate to **File>Save**.

Orienting Templates

To make templates you create simple to use, orient the template structure so that you can modify the bonds you use most often.

Resizing Template Panes

To resize the Template panes in the Template panel, drag the lower right corner of the Template panel. If necessary, first click and drag the resize handle.

Defining Nicknames

A nickname is an alphanumeric abbreviation that represents a substructure¹. Nicknames are useful for drawing large structures, or structures that repeatedly use similar features. Contracted labels are similar to nicknames, but they are for one-time use only, in the current document.

ChemDraw includes a library of nicknames of common functional groups and monomers. For example, if you typically draw protein structures, you may consider using amino acid nicknames in your drawings rather than drawing each amino acid.

The substructure that a nickname represents connects to the rest of the structure using one or more attachment points. Attachment points must be single bonds. For substructures with two or more attachment points, the attachment point numbering sequence determines the order in which other parts of the structure are attached. For example,

¹A substructure can be any part of a drawn structure.

if you expand the structure H-Leu-OH, the hydrogen is bonded to the first attachment point in leucine and the hydroxyl group to the second.

For more information, see ["Using Nicknames" on page 68](#).

To define a new nickname:

(In the example below, a b-alanine structure is used.)

1. Draw the b-alanine structure.

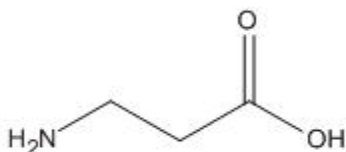

2. Draw a bond to the NH2 group.
3. Delete the label on the OH group.

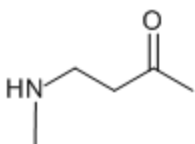

4. Using the Attachment Point tool, add an attachment to the N-terminus.
5. Add an attachment to the C-terminus.

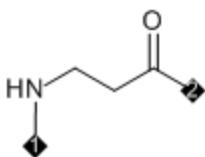

6. Select the structure, and navigate to **Structure>Define Nickname**.
7. Type a short name for the nickname.

 **Tip:** To avoid possible conflicts with elements, specify names with more than two characters.

8. Click **OK**.

 **Note:** The attachment point order is determined by the order in which you add the attachment points to the structure.

You can also define nicknames from a structure containing a single radical. Attachment points are added at the site of the radical.

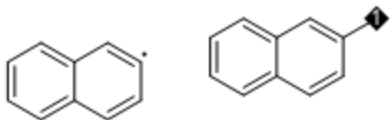

Nicknames can also be defined by carving a substructure out of a structure.

Nicknames and Atom Labels

If you use a nickname that is the same as an element name, a message indicates that the element is replaced with the nickname. For example, using **Ac** for an acetyl group replaces the element Actinium. The Check Structure command recognizes the label as an acetyl group rather than Actinium.

The nicknames list provides these Nickname/Element conflicts:

Symbol	Nickname	Element
Ac	Acetyl	Actinium
Am	Amyl	Americium
Np	<i>para</i> -Nitrophenyl	Neptunium
Pr	Propyl	Praeseodymium

 **Note:** If you use the Periodic Table dialog to insert atoms into structures, the elements will preferentially be deposited. Selecting **Ac** from the Periodic Table and clicking on an atom will place Actinium rather than Acetyl.

To remove the overriding nicknames, navigate to **File>List Nicknames** and delete the overriding nickname definition.

Deleting Nicknames

To delete a nickname from the nickname library:

1. Navigate to **File>List Nicknames**.
2. Select the nickname and click **Delete**.

Troubleshooting Nicknames

If the Define Nicknames command is disabled, check for the following:

- A connection point that is not present
- More than two connection points that are defined
- A connection point that is not a single bond

In Figure *a* below, the entire functional group was selected. Because there is no atom that indicates a connection point, you cannot define a nickname. When a sulfonamide group is attached to an unselected bond, you can define a nickname.

In Figure *b*, there is more than one attachment point on a single atom in a nickname.

Incorrect

Correct

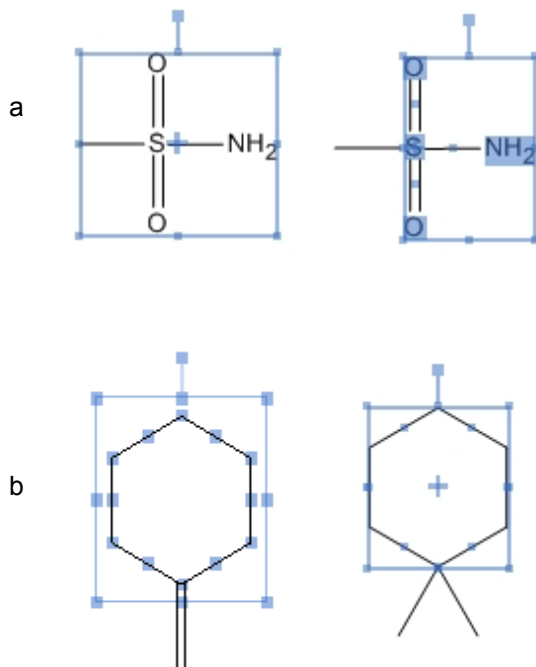

ChemScript

ChemScript is the cheminformatics Software Development Kit (SDK). It contains the programming algorithms common throughout PerkinElmer Informatics products. With enough knowledge writing software code, you can apply ChemScript to create your own scripts to use with ChemOffice applications.

ChemDraw Professional also includes a library of sample scripts for you to use. Navigate to **File>ChemScripts** and select an option.

To run a script on the current drawing:

1. Navigate to **File>Run ChemScript**.
2. In the Open dialog, select the script and click **Open**.
3. (Optional) To run the script again, navigate to **File>Re-run Previously Selected ChemScript**.

ChemScript Integration

 **Note:** ChemScript is an advanced feature intended for users with some programming experience.

ChemScript lets you add custom functions to ChemDraw. Custom scripts can be launched from the application, and the results of the script are returned to a new ChemDraw document. Scripts must be written using either PYTHON or .NET. You use custom scripts to:

- Apply custom drawing rules using ChemScript
- Launch external applications from ChemDraw
- Automate workflow from ChemDraw

The input data for the script consists of CDXML data from the currently active document in ChemDraw. If you select a portion of the document, only the selected part of the document is used as input to the script.

You can apply scripts to chemical structures and reactions.

You can place scripts in the Scripts directory for easy usage. The Scripts directory is in the same directory as the ChemDraw items directory.

To launch a script, do one of the following:

- Navigate to **File>ChemScripts**, and select a script from the Scripts directory.
- Navigate to **File>Run ChemScript**, and select a script from a directory other than the Scripts directory.

You can also use the sample scripts available in ChemDraw under **File>ChemScripts**. One example is given below:

1. Draw a minimum of three structures in the document window.
2. Navigate to **File>ChemScripts>Layout Molecules in a Circle**. A new document window appears with the structures arranged in a circle.

Struct=Name (Professional Level)

ChemDraw includes two features for generating structures and chemical names—*Name>Struct* and *Struct>Name*. Collectively, these features are called *Struct=Name*.

Struct>Name generates the names of chemical structures using the Cahn-Ingold-Prelog rules for stereochemistry. Using this option, you can generate the name of structures you have drawn.

Name>Struct lets you convert chemical names into their corresponding chemical structures. It is designed to interpret chemical names as they are used by chemists. In other words, it recognizes the shorthand and slang of everyday usage, in addition to recognizing most of the official IUPAC, IUBMB, and CAS rules and recommendations.

Struct>Name

Struct>Name can interpret a variety of chemical structures. This means that you can draw a structure and *Struct>Name* will provide its name. It also updates the name when you modify the structure.

Using Struct>Name

To generate the name of your structure:

1. Select the structure.
2. Navigate to **Structure>Convert Structure to Name**. The name appears under the structure.

Supported Structures

However, *Struct>Name* will interpret:

- Stereochemistry

Principal Group in Rings and Chains

Carboxylic Acids	S, Se, and Te Acids
Peroxy acids	S, Se, and Te Esters
Amide derivatives of acids	S, Se, and Te Acid Halides
Carbonic acids	S, Se, and Te Amides
Nitric acids	Sulfides and chalcogen analogs
Acid Halides	Sulfoxides and chalcogen analogs
Carboxylic Esters	Heteroatomic acids (P, B, As)
Salts	Heteroatomic esters
Anhydrides	Heteroatomic acid halides
Hydrazides	Aldehydes and chalcogen analogs
Imides	Ketones and chalcogen analogs
Amides	Alcohols and chalcogen analogs
Hydrazines	Hydroperoxides
Nitriles	Peroxides
Amines and Imines	

Non-Ringed Structures

- Isolating and naming the functional groups
- Identifying the base chain of the molecule
- Identifying and building substituents
- Nomenclature of groups cited only by prefixes
- Heterocyclic compounds
- Naming of substituent groups
- Locants
- Name generation (alphabetization, punctuation, etc.)

Ringed Structures

Struct>Name supports the these types of ringed structures:

- Carbomonocyclic structures
- Heteromonocyclic structures
- Fused polycyclic structures:
 - Fused polycyclic trivially-named structures
 - Ring fusions of multiple rings
 - Ring fusions of two multiple ring systems
 - Ring fusions of more than two ring systems
- Bridged monocyclic structures
- Spiro ring systems

Some of these ring structures are defined below.

Ring Assemblies

A ring assembly has two or more identical cyclic systems joined together by single or double bonds. All the cyclic systems are either a single ring, fused system, alicyclic von Baeyer system, spiro system, phane system, or fullerene.

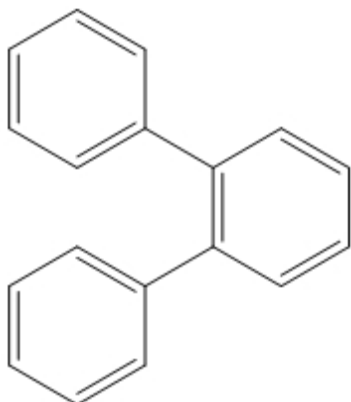

Figure 10.1: An example of a ring assembly structure: 1,1':2',1''-terphenyl.

Fused Ring Systems

Struct>Name supports fused ring systems of two or more rings, such as the structure below.

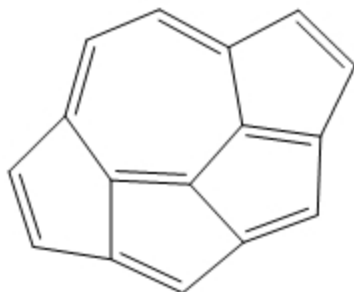

Figure 10.2: cyclopenta[ij]pentaleno[2,1,6-cde]azulene is a fused ring system.

Bridged Fused Ring Systems

ChemDraw supports bipodal (both bivalent and polyvalent) simple acyclic (chained) homogeneous (atoms of only one element) independent bridged fused ring systems. For example:

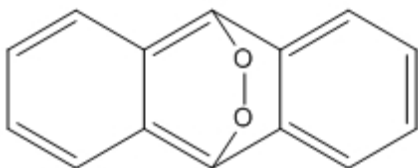

Figure 10.3: The bridged fused ring system 9,10-epidioxyanthracene.

Polymers

Polymer structures cannot be expressed by SMILES. However, Struct>Name supports many homopolymers, copolymers, and alternating polymers. For example:

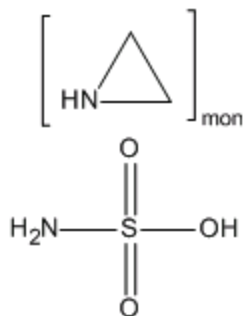

Figure 10.4: polyaziridine compound with sulfamic acid (1:1)

Other Compounds

- Phosphorous and Arsenic compounds
- Si, Ge, Sn, and Pb compounds
- Boron compounds
- Organometallic compounds

Struct>Name generates names with proper CIP stereochemistry descriptors.

Struct>Name provides direct support for stoichiometry specified as bracket properties, including fractional stoichiometry. Also, the manner in which the stoichiometry of 0.5 ("hemi") and 1.5 ("sesqui") is handled is improved. For example:

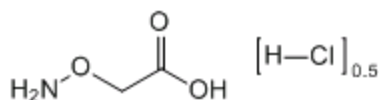

Figure 10.5: 2-(aminoxy)acetic acid hemihydrochloride

Struct>Name follows IUPAC rules as closely as possible when generating chemical names. However, while handling indicated hydrogens, it conforms to CAS nomenclature recommendations. For example, the carbon atom between two oxygen atoms in 1,3-dioxole can never form double bonds as its two neighbors (oxygen atoms) have no free valences. While preferred IUPAC (PIN) name for that structure is 2H-1,3-dioxole, Struct>Name generates the name 1,3-dioxole. The name produced by Struct>Name conforms to CAS nomenclature recommendations in this regard.

Unsupported Structures

This feature has a few limitations for interpreting some structures such as:

- Sulfones and chalcogen analogs
- Isotopically modified compounds
- Radicals, ions, and radical ions

Auto Update

If you paste the name of the structure generated by ChemDraw onto the worksheet, it will dynamically update if you change the structure. The name will never mismatch what has been drawn, but it is possible that changes to the structure will create a chemical for which **Struct>Name** will be unable to provide a name. In addition, you can include chemical properties, including the chemical name and analysis, in a caption, and the caption content will update automatically when you modify the structure. For more information on adding chemical properties to captions, see ["Analysis Data" on page 72](#).

To toggle the auto-update feature:

1. Point to the caption.
2. Right-click and select **Auto-update**. A check mark appears next to the command when it is selected. Successive clicks toggle the command on and off.

When auto-update is on (default) the label updates each time you modify the structure.

 **Note:** For large structures, the new label may not appear for a few seconds. You do not have to wait for the new label to appear before continuing to modify your structure.

Name>Struct

You can type a chemical name and Name>Struct will draw the structure.

Although some trade names are supported, Name>Struct is not intended to interpret trade or common names. A chemical database, such as ChemFinder.com, is more appropriate for obtaining these structures.

 **Note:** Use the words 'alpha' and 'beta' when entering forms of amino acids. For example, 'alpha alanine' and 'beta alanine' are valid name>struct chemical names.

 **Note:** Name>Struct can also interpret many German names.

Converting Names to Structures

To enter the name and convert it to its structure:

1. Navigate to **Structure>Convert Name to Structure**.

The Insert Structure dialog box appears.

2. Type the name (example: 2-bromobenzoic acid) or paste the copied name from the clipboard.

 **Tip:** You can paste the name using keyboard commands: <CTRL>+<V> .

3. To place the name below the structure, select **Paste name below structure**.
4. Click **OK**.

Converting Clipboard Names

To paste a name on the clipboard as a structure:

1. Click in the document window.
2. Navigate to **Edit>Paste Special>Name as Structure**. The structure appears in your document.

Converting Captions

You can convert a caption to a structure.

1. Select the caption.
2. Navigate to **Structure>Convert Name to Structure**.

Supported Structures

Struct>Name can name compounds in classes of structures:

Principal Groups in Rings and Chains

- Acid Halides
- Alcohols and chalcogen analogs
- Aldehydes and chalcogen analogs
- Amides
- Amines and Imines
- Carboxylic Acids
- Carboxylic Esters
- Heteroatomic acid halides
- Heteroatomic acids (P, B, As)
- Heteroatomic esters
- Hydrazides
- Hydrazines
- Hydroperoxides
- Ketones and chalcogen analogs
- Nitriles
- Amide derivatives of acids
- Anhydrides
- Carbonic acids
- Imides
- Nitric acids
- Peroxy acids
- Salts
- Sulfides and chalcogen analogs
- Sulfoxides and chalcogen analogs
- Peroxides
- S, Se and Te Amides
- S, Se, and Te Acid Halides
- S, Se, and Te Acids
- S, Se, and Te Esters

Ringed Structures

- Bridged monocyclic structures
- Carbomonocyclic structures
- Fused polycyclic trivially-named structures
- Heteromonocyclic structures
- Ring fusions of only two rings
- Ring fusions of two multiple ring systems

Other Compounds

- Boron compounds
- Organometallic compounds
- Si, Ge, Sn, and Pb compounds
- Phosphorous and Arsenic compounds

Name>Struct recognizes most organic and inorganic nomenclature. However, some types are not supported:

- Coordination complexes
- Polyboranes
- Polymers
- Some highly-bridged ring systems, including fullerenes and porphyrins/porphines

- Some stereochemistry designators: +, -, +/-, +-, *D*, *l*, *dl*, *endo*, *exo*, *syn*, *anti*, *r*, *t*, *c*

Adding Structures to a Dictionary

You can create your own personal library of structures or compounds that you frequently use. You enter a short name or acronym that represents the structure so you can easily insert it in future chemical drawings. When you invoke the new structure name, ChemDraw draws the structure in your drawing area.

For example, you might create a structure to add to the dictionary for a new, not yet approved drug you are working on. Once you create the structure, the dictionary keeps the structure name and its SMILES string.

To add a new structure to the dictionary:

1. Draw the "xyz" structure, where "xyz" is your new frequently used structure.
2. Select the structure and navigate to **Structure>Add Structure to Dictionary**.
3. Enter a short name or acronym for your structure, and then click **Save**.

When you select **Structure>Convert Name to Structure** and enter your new structure short name, the structure displays in the drawing area with the new structure name as a caption.

Dictionary of FDA Approved Drugs

ChemDraw contains a dictionary of FDA approved drugs and their structures for the years 2009 to 2015. The dictionary will be updated on an annual basis. When you search for structures using **Structure>Convert Name to Structure**, ChemDraw will first attempt to use its internal name to structure capability to create the structure. If unsuccessful it will check the FDA dictionary and again, if unsuccessful the user defined dictionary. This process is very rapid and will be invisible to the user. If the search is still unsuccessful and the user has an internet connection, it will search the online ChemACX database's synonym table to try to match the input name. If still unsuccessful, or if more than one ChemACX entry matched the name provided, a message displays with the results of the search.

Chemistry Features

Structure Analysis

You can display the chemical formula, exact mass, molecular weight, m/z, and elemental analysis for the entire document, a structure, or a part of a structure using the Analysis window.

Values for selected objects in the document window are shown. If no structure is selected in your document, values for the entire document are shown.

You can have this window open as you draw in the document. It shows the current values as you draw, see example below:

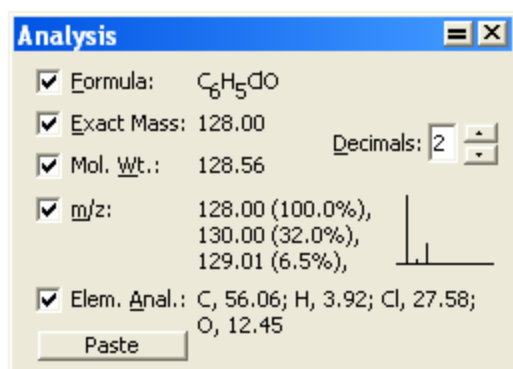

The Decimals setting applies to Exact Mass, Molecular Weight, and m/z only. The values displayed in the Analysis window includes:

Formula. The molecular formula showing the exact number of atoms of each element in the molecule and charges, radicals, and isotopes.

Exact Mass. The exact molecular mass of the structure, where atomic masses of each atom are based on the most common isotope for the element.

Molecular Weight. The average molecular mass of the structure, where atomic masses are based on the natural abundance of all isotopes of the element.

m/z. Mass/charge. The weights of the most common isotopes and a graphical representation of the isotopic abundance is shown.

The molecular weight accounts for the isotopes for each atom and their natural abundance. Where there is more than one abundant isotope, this feature computes multiple molecular weights. Low abundance combinations (whether because the isotope is in low abundance or because it includes many moderate-abundance contributions) are not taken into account.

Elemental Analysis. The percent by weight of each element in the structure.

To open the analysis window:

1. Select the entire structure, or part of the structure. If nothing is selected, the analysis window displays value for the entire structure.

- Navigate to **View>Show Analysis Window**. The analysis windows displays values for the parts of the drawing you select, or the entire drawing if nothing is selected.
- (Optional) Select **Paste** to add the analysis information to your drawing. The information appears as a caption that you can edit.

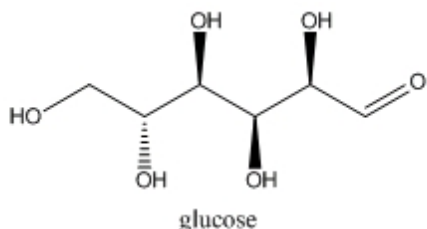

Chemical Formula: C₆H₁₂O₆
 Exact Mass: 180.06
 Molecular Weight: 180.16
 m/z: 180.06 (100.0%), 181.07 (6.9%), 182.07 (1.4%)
 Elemental Analysis: C, 40.00; H, 6.71; O, 53.29

Figure 11.1: Structural analysis

The information updates as you edit the structure. You can show or hide the information:

- Using any tool, right-click the caption.
- Point to **Analysis**, and select or deselect the item to show/hide.

ChemFinder hotlink

PerkinElmer Informatics maintains a vast database of compounds and their properties. ChemDraw provides a live Internet connection to a database, that includes:

- Links to available data resources such as the PerkinElmer Informatics ChemIndex.
- Links to ChemSpider database.
- Names and synonyms.
- Chemical identifiers such as CAS Registry Numbers and ChemACX IDs.

The HotLink information and the data itself are continually updated.

The HotLink displays information for the structure in the document window.

To open the ChemFinder HotLink:

- Select a structure.
- Go to **View>Show ChemFinder HotLink Window**.

 **Note:** To access ChemSpider database, click on the value of either InchiKey or Std InchiKey in the Properties table in the ChemFinder Hotlink window.

Stereochemistry

ChemDraw calculates the absolute stereochemistry according to the Cahn-Ingold-Prelog (CIP) priority rules. For more information, see ["Cahn-Ingold-Prelog" on page 308](#).

Only tetrahedral and double-bond stereochemistry are supported, and only non-racemic stereochemistry is interpreted. Stereochemical indicators for aromatic bonds are not displayed.

ChemDraw uses this notation:

(R), (S)

Standard tetrahedral stereochemistry

(r), (s)

Tetrahedral stereochemistry determined by other stereochemical centers. For example: *cis*-decalin and *myo*-inositol

(E), (Z)

Standard double-bond stereochemistry

Stereochemistry Indicators

ChemDraw updates stereochemistry indicators as you change your drawing.

To include stereochemistry indicators in your drawing:

1. Select the structure.
2. Right-click and select **Object Settings** from the context menu.
3. From the Drawing tab, under Atom Indicators and Bond Indicators, select **Show Stereochemistry**.

The stereo-centers are marked, as shown in this example:

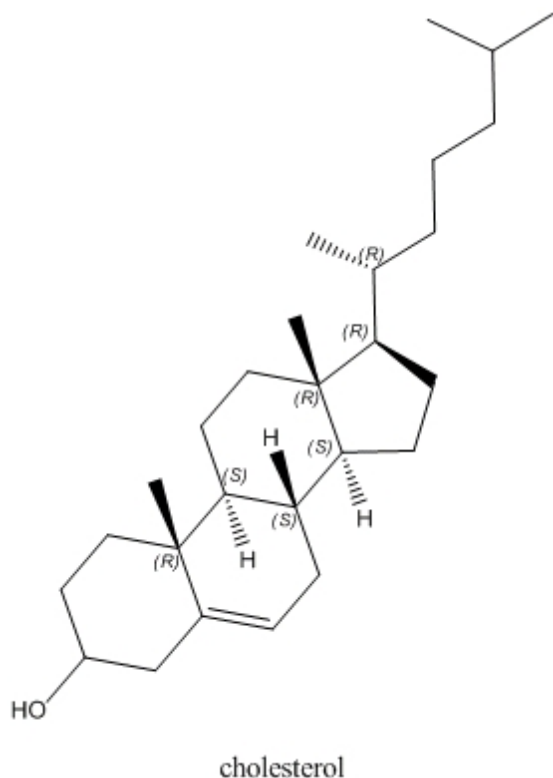

Hiding Indicators

1. Select the indicator you want to hide.
2. Right-click and select **Hide Indicator** from the context menu.

Formatting Indicators

To change the font style:

1. Select the indicator you want to manipulate.
2. Right-click and select the **Style** from the context menu.

Applying Parenthesis

To apply parentheses to stereochemistry indicators:

1. Navigate to **File>Preferences**.
2. From the Preferences dialog, under the Building/Display tab, select **Include Parentheses When Showing Stereochemistry**.

Removing Indicators

To remove an indicator, click on it using the Eraser tool.

Positioning Indicators

You can position a query indicator by either dragging it or entering a numeric value for the new location.

To indicate an exact location:

1. Select the indicator you want to re-position.
2. Right-click and choose **Position** from the context menu. The Position Indicator dialog appears.
3. Click the appropriate option, and type a value, as described in the table below:

To Position	Type a Value for the Position by
From the atom or bond center to indicator center	Angle, in degrees or Clock, in clock time
From the atom or bond center to bottom left of indicator baseline	Offset, horizontal, and vertical
At specified coordinates	Absolute, horizontal, and vertical

Relative stereochemistry

You can specify relationships between groups of stereocenters within a molecule.

This notation enables you to describe stereochemical properties and individual stereocenters rather than the entire molecule. As a result, you can illustrate properties of several enantiomers using only a few (or just one) structures.

The notation is illustrated below:

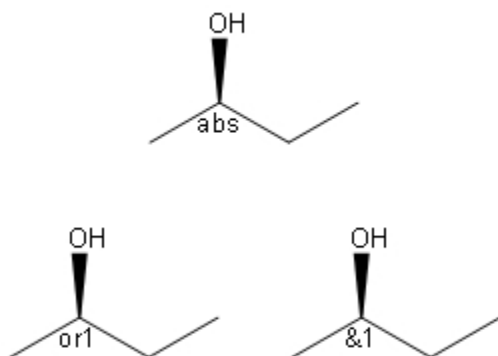

To add stereochemical notation to a structure, go to **Structure>Enhanced Stereochemistry**.

The power of this notation becomes clear when you draw complex enantiomers. For example, beta-cypermethrin is a mixture of four distinct stereoisomers consisting of two enantiomeric pairs. However, drawing this requires only one structure:

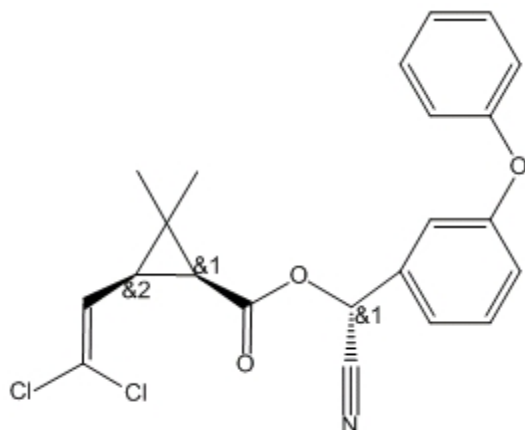

Figure 11.2: beta-Cypermethrin

Two stereo-centers have the &1 designation because of their fixed relative configuration: when one is (R) the other must be (S). As a result, they form a group. The third stereocenter varies independently and is designated &2. Group numbers are incremented automatically. To see all the beta-cypermethrin stereoisomers, go to **File>Open Samples>b-Cypermethrin**.

To indicate stereochemistry for a group:

1. Select all atoms in the group using SHIFT+click.
2. Go to **Structure>Enhanced Stereochemistry** and select a stereochemistry marker.

See "[Relative stereochemistry](#)" on page 162 for information on showing and hiding indicators.

You can save enhanced stereochemistry notation in any of these formats: CDX, CDXML, MOL V3000, RXN V3000, SKC, TGF.

When saving to SKC or TGF format, the indicators are converted into corresponding Data SGroups. Whenever you open SKC or TGF files containing such Data SGroups, they are converted into true Enhanced Stereochemistry values.

To save the Enhanced Stereochemistry settings when saving to the SKC format, check the '**Use Enhanced Stereochemistry When Saving to SKC File Format**' option in the Building/Display tab of the Preferences dialog.

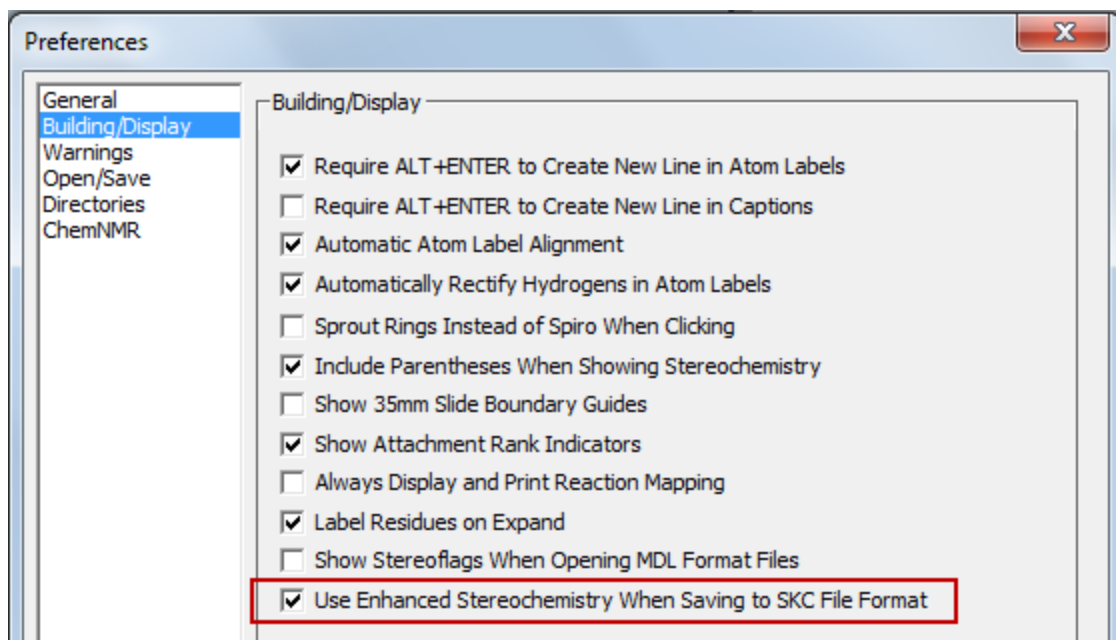

 **Note:** To display one general stereoflag label for the molecule (instead of stereoflag labels in individual stereo-centers) when opening MDL format files having absolute / relative / racemic stereochemistry setting, check the **'Show Stereoflags When Opening MDL Format Files'** option in the **Building/Display** tab of Preferences dialog.

Chemical Properties

Chemical Property Prediction is a feature supported by ChemOffice. It enables you to calculate values for a wide range of methodologies; for example, topological descriptors such as the Weiner index and Balaban index, thermodynamic descriptors such as solubility, melting and boiling points, and partition coefficients such as CLogP, properties related to the three-dimensional shape and volume of a chemical such as the Connolly surface area and volume. In total, you can calculate more than 100 chemical properties for a given structure.

For a list of properties available in a specific application, click the respective link below, or visit the [PerkinElmer Informatics website](#).

- ["Property Predictions in ChemDraw" on page 164](#)
- ["Property Predictions in Chem3D" on page 169](#)
- ["Property Predictions in ChemDraw/Excel" on page 168](#)
- ["ChemFinder Properties" on page 170](#)

Property Predictions in ChemDraw

You can enter predicted values for the physical and thermodynamic properties of a chemical structure of up to 100 atoms.

The properties are calculated using the most reliable methods for the given structure. Log P, and CMR values based on literature values rather than a calculation are included in the report file. The report is produced as a text file and the information in it can be cut and pasted to other documents like a word document.

A list of all the properties calculated is as follows:

B	H	P
Boiling Point	Heat of Formation	pKa
C	Henry's Law Constant	T
Critical Pressure	L	tPSA
Critical Temperature	LogP	
Critical Volume	LogS	
CLogP/CMR	M	
G	Melting point	
Gibbs Free Energy	MR	

About Molecular Networks

*MOSES.pKa, MOSES.logS and MOSES.logP for predicting acid dissociation constants, aqueous solubility and octanol/water distribution coefficients of chemical compounds are computational calculator modules based on Molecular Networks' cheminformatics platform MOSES. MOSES is developed, maintained and owned by Molecular Networks GmbH, Erlangen, Germany. For further information please visit www.molecular-networks.com/moses. All rights reserved. Molecular Networks GmbH, Erlangen, Germany (www.molecular-networks.com).

Limitations

Only the following atom types and hybridization states are parameterized:

C _{sp³}	C _{sp²}	C _{aromatic}	C _{sp}
N _{sp³}	N _{sp²}	N _{amide}	N _{aromatic}
N _{sp}	O _{sp³}	O _{sp²}	P _{sp³}
S _{sp³}	S _{sp²}	S _{sulfoxide}	S _{sulfone}
F	Cl	Br	I

Boiling Point

The boiling point is reported in Kelvin.

A solution boils at a slightly higher temperature than the pure solvent. The change in boiling point is calculated using the formula:

$$\Delta T_b = K_b m$$

Where K_b is the molal boiling point constant, m is the concentration of the solute expressed as molality, and ΔT_b is the change in temperature.

Critical Pressure

Reported in bars, this is the least applied pressure required at the critical temperature to liquefy a gas.

Critical Temperature

Reported in Kelvin, this is the temperature above which a gas cannot be liquefied, regardless of the pressure applied.

Critical Volume

Reported in cm^3/mol , this is the volume occupied by one mole of a substance at the critical temperature and pressure.

CLogP/CMR

Use CLogP to calculate *n*-octanol/water partition coefficient ($\log P_{ow}$). LogP values based on literature rather than calculations are included in the report file.

Use CMR to calculate Molar Refractivity. MR values based on literature rather than calculations are included in the report file.

 **Note:** CLogP and CMR values appear only in ChemDraw Professional.

Gibbs Free Energy

Gibbs free energy is defined as:

$$G(p, T) = U + pV - TS$$

Which is same as:

$$G(p, T) = H - TS$$

Where:

- U is the internal energy (SI unit: Joule)
- p is pressure (SI unit: Pascal)
- V is volume (SI unit: m³)
- T is the temperature (SI unit: Kelvin)
- S is the entropy (SI unit: joule per Kelvin)
- H is the enthalpy (SI unit: Joule)

 **Note:** *H and S are thermodynamic values found at standard temperature and pressure.*

Heat of Formation

Reported in KJ/mole, the heat of formation is the increase in enthalpy resulting from the formation of one mole of a substance from its constituent elements at constant pressure.

Henry's Law Constant

A unitless value, Henry's Law Constant can be expressed as:

$$k_{H,pc} = \frac{p}{c}$$

Where 'p' is the partial pressure of the solute in the gas above the solution, 'c' is the concentration of the solute and 'k_{H,pc}' is a constant with the dimensions of pressure divided by concentration. The constant, known as the Henry's law constant, depends on the solute, solvent, and temperature.

LogP

The partition coefficient is a ratio of concentrations of un-ionized compound between two solutions. To measure the partition coefficient of ionizable solutes, the pH of the aqueous phase is adjusted so that the predominant form of the compound is un-ionized. The logarithm of the ratio of the concentrations of the un-ionized solute in the solvents is called LogP.

Normally, one of the solvents chosen is water; the second is hydrophobic, such as octanol.

The formula to calculate LogP is:

$$\log P_{oct/wat} = \log \left(\frac{[solute]_{octanol}}{[solute]_{un-ionizedwater}} \right)$$

LogS

LogS determines the solubility of a substance, measured in mol/liter.

The aqueous solubility of a compound is known to significantly affect absorption and distribution characteristics of that compound.

 **Note:** LogS calculations are available only in Microsoft Windows version of ChemDraw.

Melting point

Is the temperature at which a solid becomes a liquid at standard atmospheric pressure. At the melting point, the solid and liquid phase exist in equilibrium. The formula to calculate melting point is:

$$T = \frac{\Delta H}{\Delta S}$$

Where 'T' is the temperature at the melting point, 'ΔS' is the change in entropy of melting, and 'ΔH' is the change in enthalpy of melting.

MR

The Molar Refractivity is estimated by Crippen's fragmentation and Viswanadhan's fragmentation method. Additional empirical LogP data appears for selected substances in the report file.

pKa

pKa is the negative log of the acid dissociation constant K_a . It describes the tendency of compounds or ions to dissociate in solution. It is calculated using the formula:

$$pK_a = -\log_{10} K_a$$

Empirical pKa data appears for selected substances in the report file.

 **Note:** pKa calculations are available only in Microsoft Windows version of ChemDraw.

tPSA

Calculation of polar surface area based on fragment contributions.

Property Predictions in ChemDraw/Excel

The Properties feature in ChemDraw/Excel lets you view the values of different properties for a given structure. Each property is calculated using the "best available" method. A list of properties available in ChemDraw/Excel is listed in the table below. For more information on these properties, see ChemDraw/Excel online help, or visit the [PerkinElmer Informatics website](#).

The properties available include:

B	F	Melting Point	Shape Attribute
Balaban Index	Formal Charge	Molar Refractivity	Shape Coefficient
Boiling Point	Freezing Point	Molecular Formula	Sum Of Degrees

C	G	Molecular Weight	Sum of Valence Degrees
Cluster Count	Gibbs Free Energy	N	T
Critical Pressure	H	Number of Rotatable Bonds	Total Connectivity
Critical Temperature	Heat of Formation	O	Topological Diameter
Critical Volume	Henry's Law Constant	Ovality	Topological Index
Connolly Accessible Area	I	P	Total Valence Connectivity
Connolly Molecular Surface Area	Ideal Gas Thermal Capacity	Principal Moments of Inertia (X, Y, Z)	V
Connolly Solvent Accessible Surface Area	L	Polar Surface Area	Vapor Pressure
Connolly Solvent-Excluded Volume	LogP	R	W
E	M	Radius	Water Solubility
Exact Mass	Mass	S	Wiener Index

Property Predictions in Chem3D

Chem3D lets you build, analyze, and compute properties very easily. In addition to analyzing structures to calculate mass and formula, predicting numerous physical properties, you can also perform calculations for molecular topology. A list of properties available in Chem3D is listed in the table below. For more information on these properties, see Chem3D online help or visit the [PerkinElmer Informatics website](#).

B	G	Mol Weight	Spin Density
Balaban Index	Gibbs Free Energy	Molecular Mass	Sum Of Degrees
Boiling Point	H	Molecular Surfaces	Sum of Valence Degrees
C	Harmonic Zero Point Energy	Molecular Topological Index	T
C_p	Heat Capacity	Molecular Volume	Thermodynamic Energy
C_v	Heat of Formation	Mulliken Charges	Topological Diameter
Cluster Count	Henry's Law Constant	Mulliken Populations	Total Connectivity
Connolly Accessible Area	Hyper Polarizability	m/z	Total Energy

Connolly Molecular Area	Hyperfine Coupling Constants	N	Total Valence Connectivity
Connolly Solvent Excluded Volume			
	I	Num Rotatable Bonds	V
Critical Pressure	Ideal Gas Thermal Capacity	O	Vapor Pressure
Critical Temperature	Internal Energy		W
Critical Volume	Ionization Potential	P	Water Solubility
D	K	Partition Coefficient	Wiener Index
Dipole	Kinetic Energy	pKa	Z
E	L	Polar Surface Area	Zero-Point Energy
Electron Density	LogP	Polarizability	
Electrostatic Potential	LogS	Potential Energy	
Elemental Analysis	Lowdin Charges	Principal Moment	
Enthalpy	Lowdin Populations	R	
Entropy	M	Radius	
Exact Mass	Mass	RMS Force	
F	Melting Point	S	
Formal Charge	Mol Formula	SCF Energy	
Frequencies	Mol Formula HTML	Shape Attribute	
	Mol Refractivity	Shape Coefficient	

ChemFinder Properties

The properties listed below can be calculated in ChemFinder Professional for ChemOffice. For more information on these properties and how to calculate them, see the ChemFinder online help.

B	H	P
Balaban Index	Heat of Formation	Partition Coefficient
Boiling Point	Henry's Law Constant	pKa
C	I	Polar Surface Area
Chemical Name	Ideal Gas Thermal Capacity	Principal Moment
Cluster Count	L	R
Critical Pressure	LogP	Radius
Critical Temperature	LogS	S
Critical Volume	M	Shape Attribute

Connolly Accessible Area	Mass	Shape Coefficient
Connolly Molecular Area	Melting Point	Sum of Degrees
Connolly Solvent Excluded Volume	Mol Formula	Sum of Valence Degrees
E	Mol Formula HTML	T
Elemental Analysis	Mol Refractivity	Topological Diameter
Exact Mass	Mol Weight	Total Connectivity
F	Molecular Topological Index	Total Valence Connectivity
Formal Charge	m/z	V
G	N	Vapor Pressure
Gibbs Free Energy	Num Rotatable Bonds	W
	O	Water Solubility
	Ovality	Wiener Index

Viewing Chemical Properties

To view chemical properties:

1. Select the structure whose properties you want to view.
2. Navigate to **View>Show Chemical Properties Window**. The Chemical Properties window appears.
3. To paste the basic properties into your document, click **Paste**.
4. To create a report and view results for other fragmentation methods, click **Report**.

Chemical Annotations

ChemDraw provides the following tools and tool palettes that enable you to add chemical annotations to your documents:

Orbital tools palette. Draw orbitals

Chemical Symbol Tools palette. Draw charges, radicals, and other symbols

Orbitals

You draw orbitals so that the node appears first. Then you can change the background color, shading, and solid color using the **Color** menu.

Display the Info window to view the orbital's length and angle relative to the X-axis while you draw it. To constrain the length and angle of an orbital, navigate to **Object>Fixed Lengths** or **Fixed Angles**.

 **Note:** Orbitals are not normally a part of the structure they are drawn near and are not selected when you double-click a bond, atom, or atom label with a selection tool. To group the orbitals with the structure, navigate to **Object>Group**. See "[Grouping Objects](#)" on page 91.

S-orbitals

The s-orbital is shown below:



To draw an s orbital:

1. Hold down the mouse button over the Orbital tool and drag to select the **s-orbital** tool from the palette.
2. Click an atom in the drawing where the orbital will be centered.

Sigma Orbitals

The sigma-orbital is shown below:



To draw a σ -orbital:

1. Hold down the mouse button over the Orbital tool and drag to select the σ -orbital tool from the palette.
2. Click an atom in the drawing where the orbital will be centered.

Single Lobe Orbitals

To draw a single lobe orbital:

1. Hold down the mouse button over the Orbital tool and drag to select the **single lobe orbital** tool from the palette.
2. Click an atom where the narrow end of the orbital will be attached.

P-orbitals

The p-orbital is shown below:



To draw a p orbital:

1. Hold down the mouse button over the Orbital tool and drag to select the **p-orbital** tool from the palette.
2. Click an atom where the node of the orbital will be attached.

Hybrid Orbitals

The hybrid orbital is shown below:



To draw a hybrid orbital ('sp³):

1. Hold down the mouse button over the Orbital tool and drag to select the **hybrid-orbital** tool from the palette.
2. click an atom where the node of the orbital will be attached.

D-orbitals

The d-orbital is shown below:



To draw a d orbital('dxy'):

1. Hold down the mouse button over the Orbital tool and drag to select the **d-orbital** tool from the palette.
2. Click an atom where the node of the orbital will be attached.

To draw a d_z^2 orbital:

1. Hold down the mouse button over the Orbital tool and drag to select the d_z^2 -orbital tool from the palette.
2. Click an atom where the node of the orbital will be attached.

Chemical Symbols

You can move any attached chemical symbol (other than H-dot and H-dash) any distance from its related atom. The available chemical symbols are:

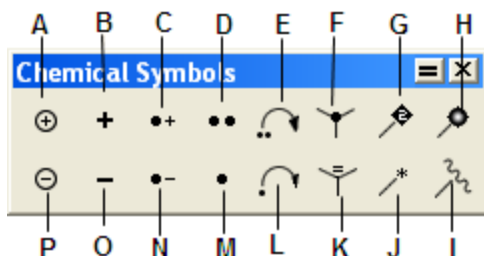

Figure 11.3: **Chemical Symbols:** A) Circle Plus; B) Plus; C) Radical cation; D) Lone pair; E) Electron Pushing; F) H-dot; G) Attachment point; H) Polymer bead attachment point; I) Attachment point; J) Attachment point; K) H-dash; L) Radical Pushing; M) Radical; N) Radical anion; O) Minus; P) Circle minus.

You can place unattached symbols anywhere within your document and resize them.

H-dot and H-dash

- To represent a hydrogen atom that is coming out of the plane toward you along the Z axis, use the H-dot symbol.
- To represent a hydrogen atom that is directed backwards into the plane away from you along the Z axis, use the H-dash symbol. To insert H-dots and H-dashes, click an atom.

Lone Pair/Diradical

Use the lone pair symbol to indicate a lone pair of electrons common in Lewis structures.

To use the lone pair symbol:

1. Hold down the mouse button over the Chemical Symbols tool and drag to select the **lone pair** from the palette.
2. Click and drag the atom to where you want the lone pair. The lone pair is offset from the atom at a fixed position.

 **Note:** With the lone pair tool selected, if you ALT + click on an atom, it will place a lone pair bar symbol instead of a lone pair double dot symbol.

Electron and Radical Pushing

ChemDraw provides the Electron Pushing and Radical Pushing tools for illustrating electron transfer. Electron transfers can be drawn between atoms, bonds, and orbitals. For more information, see "[Electron and Radical Pushing](#)" on

[page 140](#).

Radical

Use the radical symbol to indicate a single non-bonded electron.

To use the radical symbol:

1. Hold down the mouse button over the Chemical Symbols tool and drag to select the **radical** from the palette.
2. Click and drag the atom to where you want the radical symbol.

 **Note:** *The lone pair symbol is interpreted as a diradical when it is placed next to an unlabeled carbon atom.*

Radical Cation and Radical Anion

Use the charge radical symbols to represent radicals that are charged.

To use the charge radical symbols:

1. Hold down the mouse button over the Chemical Symbols tool and drag to select the symbol from the palette.
2. Click and drag the atom to where you want the symbol.
3. Click an atom to add a radical cation or radical anion symbol in a horizontal orientation.

Charge Symbols

To draw a charge and associate it with a structure:

1. Hold down the mouse button over the Chemical Symbols tool and drag to select the **charge symbol** from the palette.
2. Click and drag the atom to which you want the charge to correspond.

The number of hydrogen atoms increases or decreases as appropriate for the addition of the charge.

Attachment Points

Indicating an attachment point is useful in polymer-bound combinatorial synthesis, protein chemistry, and other situations. The Chemical Symbols toolbar includes attachment point drawing tools that indicate a point of attachment while maintaining chemical meaning.

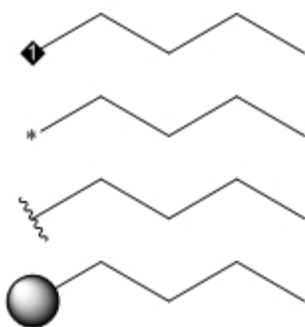

The bead tools are intended to indicate attachment to a resin. Any of these tools may be used for variable attachments in queries (see "[Attachment Points](#)" on [page 128](#)); but, only the diamond tool shows rank numbers. This means that, as you add diamond symbols to a structure, the points will have sequential numbers.

 **Note:** You can resize a polymer bead by selecting it with a marquee tool, and dragging the resize drag handles.

Rotating a Symbol

You can rotate the radical anion, cation, and lone pair symbols around the same end from which they were originally drawn. For example, the radical cation symbol is rotated and resized from the charge. The Info window shows the angle that one of the ends of a symbol makes with the X-axis as you rotate.

To rotate a chemical symbol:

1. Select the **chemical** symbol.
2. Drag the rotation handle on the chemical symbol. See "[Rotating Objects](#)" on page 87.

3D Viewing

As you create your drawing, you can view it in three-dimensions. Two features in ChemDraw let you view structures in three dimensions.

 **Note:** Chem3D must be installed on your computer to preview structures in three dimensions.

3D Model

Use a 3D model to paste a 3D version of the structure into your drawing.

1. Select the structure.
2. Navigate to **Edit>Get 3D Model**. The 3D structure appears in the document window.

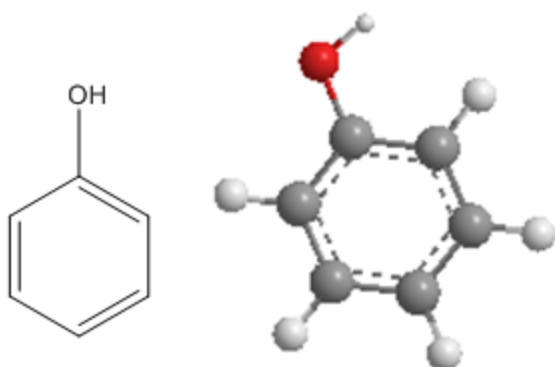

To view the model in Chem3D, double-click on it.

 **Note:** 3D objects inserted in this way cannot be transferred between platforms. For more information, see "[File Formats](#)" on page 284.

 **Note:** You can copy a model using "Copy as CDX" from Chem3D and paste into ChemDraw. The result is a ChemDraw structure with 3D coordinates, and it is possible to rotate this structure in 3D using the structure perspective tool.

Chem3D Preview Options

The preview window displays structures you select in 3D and displays all structures if none are selected. Chem3D Preview works only for chemical structures.

 **Note:** The Chem3D Hotlink Window option is available only with ChemOffice Professional.

To view, navigate to **View>Show Chem3D Hotlink Window**. For example:

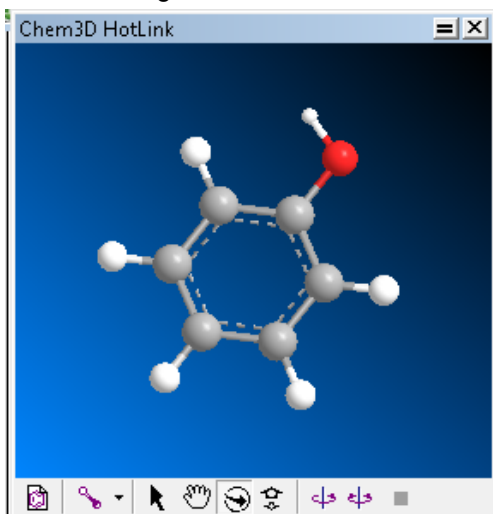

With the preview window open, you can change the structure's appearance, in either the document window, or the preview window.

In the Document Window

With the preview window open, you can still change your drawing in the document window. The preview window updates to reflect the changes.

In Chem3D Preview

The preview window offers several options to view structures.

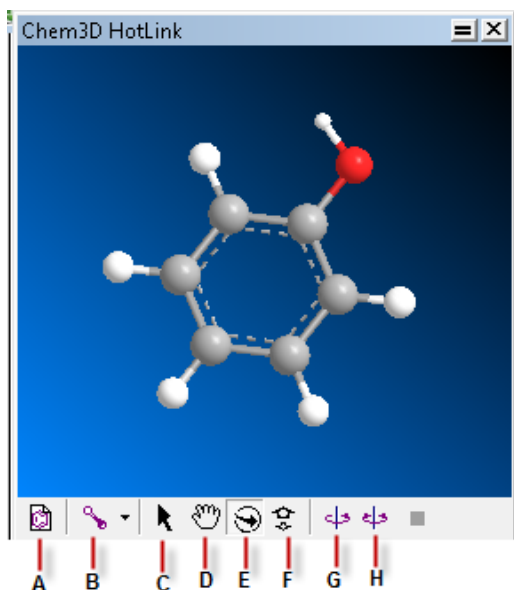

Figure 11.4: A)Launch Chem3D; B)Display mode; C)Select; D)Translate; E)Rotate; F)Zoom; G)Spin; H)Rock.

Launch Chem 3D. The structure will appear in Chem3D as a model that you can edit.

Display Mode. Choose display options for the model: wire frame, stick, ball & stick, cylindrical bonds, and space filling.

Select. Select the structure or parts of it.

Translate. Move the structure.

Rotate. Rotate the structure in three dimensions (the image rotates only in the Chem3D Preview).

Zoom. Enlarge or reduce the apparent size of the structure.

Spin. Rotate the structure horizontally in one direction.

Rock. Rotate the structure horizontally back and forth.

Returning to the Document Window

To exit the Chem3D Preview, close the preview window.

To edit the 3D model:

1. Double-click the 3D structure. Chem3D opens.
2. Edit the structure and close Chem3D.

The edited structure appears in the ChemDraw document window.

TLC

The TLC (Thin Layer Chromatography) Tool lets you depict thin layer chromatography plates. The tool creates a rectangular plate with an origin line, solvent front, and one or more lanes. The lanes can be populated with spots of different R_f , size, shape, or color.

To create a TLC plate:

1. Select the **TLC** tool from the Chromatography toolbar.
2. Drag in any direction from the point of origin. The width of the plate determines the number of lanes.

You can modify the plate as follows:

If you want to	Then
Change the height or width of the plate.	Drag a border or corner.
Move the origin or solvent front.	Click and drag the origin or solvent front line.
Show or hide the origin, solvent front, borders, or side ticks.	<p>Right-click in the plate and select the appropriate action.</p> <p>Use the Transparent option to overlay the TLC plate on a scanned plate.</p>
Change the order of lanes.	Drag the origin tick to the new location.
Add, delete, or duplicate a lane.	<ol style="list-style-type: none"> 1. Position the cursor on the lane to delete or duplicate (or between lanes to add). 2. Right-click in the plate. 3. Select the appropriate action. 4. (Optional) To delete a lane, click on it with the Eraser tool.
Move a spot.	Drag the spot. The R_f displays as you drag.
Duplicate a spot.	<CTRL>+drag the spot to a different lane.
Delete a spot.	Click the spot with the Eraser tool. If you erase all spots in a lane, the lane is deleted.
Display or set the R_f for a spot; add a custom spot..	<ol style="list-style-type: none"> 1. Right-click on a spot. 2. Point to TLC Spots, and take the appropriate action. 3. To display R_f for all spots, right-click in the plate and select Show R_f from the TLC Spots submenu.
Change the style or color of a spot.	<ol style="list-style-type: none"> 1. Right-click a spot.. 2. Choose the style or color. <p>Note: Keeping all styles unchecked creates a hollow spot.</p> <ol style="list-style-type: none"> 3. To change the style for all spots, right-click in the plate and choose the style from the TLC Spots sub-

If you want to**Then**

Enlarge or “smear” a spot.

<Shift>+drag the spot. When you position the cursor on a spot and press <Shift>, the cursor assumes one of three shapes, depending on how it is positioned:

- Cross arrows, used to enlarge a spot
- Horizontal arrow, used to widen a spot
- Vertical arrow, used to elongate a spot or create a crescent

Rf Display

Right-click a spot and select **Show Rf** to indicate the spot’s retention value. By default, the value of R_f is set to two decimal places.

Moving the Tag

Either click and drag the tag using a selection tool or **Right-click** the tag and choose **Position**. Edit the values in the **Position Indicators box**.

Editing the Rf Value

Select the tag with the **Text** tool and edit the value.

- If you change the R_f the spot will move to the new position indicated.
- If you edit the R_f to have different precision, that precision will be preserved.

Resizing Spots

You can resize spots by holding down the <Shift> key while pointing at an edge of the spot. Drag the left or right sides of the spot to adjust the width only. Drag from the top to adjust the height. Drag from the bottom to adjust the tail. Drag from any of the other four corners to scale all three values.

Customizing Spots

The TLC tool can create the most common spot shapes. Other types of spots, such as smears, can be reproduced as custom spots. The **Set Custom Spot** command lets you insert a graphic file for a spot. Typically, these files would be produced by scanning a TLC plate and saving the spots in a library of spot shapes.

Gel Electrophoresis Tool

Gel Electrophoresis tool is available in the Chromatography toolbar and functions much like the TLC tool. It consists of a plate containing several lanes with one or more bands. The bands can be resized and moved along the lane. For example, consider the figure below:

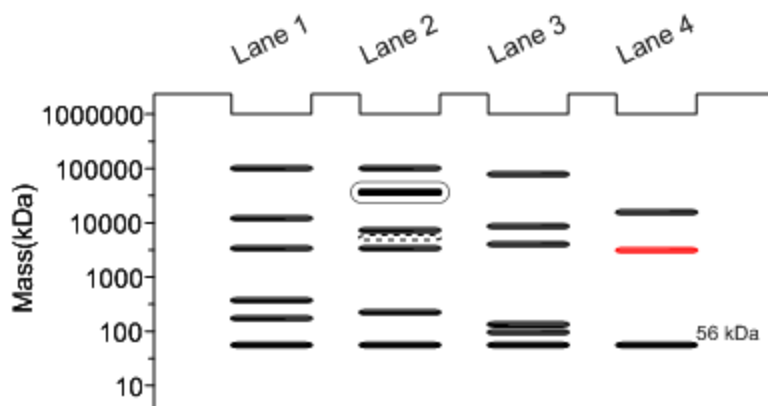

You can perform the following action on a plate:

Option	Action
Show scale.	A scale bar appears on the right of the plate. By default, the unit is displayed in kDa. However you can change it to Log(Mass), Mass, or distance from the “Units” submenu. For Log(Mass) and Mass the highest value is on the top. For distance the highest value '1' is at the bottom.
Show Lane Labels.	A label appears for every lane. You can rename and rotate it to any desired angle. When one of the labels is rotated, all the other labels are also rotated by the same angle.

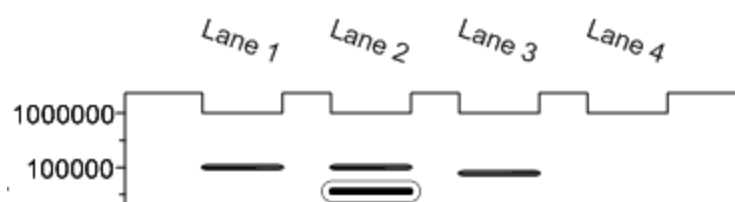

Set Range...	A dialog box prompting for the new range appears. The expected values entered in this dialog are always “kDa”. The default value for range is 10 to 10,00,000 (Mass), 1 to 6(Log), and 0 to 1 (Distance). When you change the range, the bands that fall out of range are hidden.
Add Bands...	A dialog box prompting for the mass of the new bands to be created in the selected lane appears. Space is used as a separator. Only numbers are allowed. You can also add bands by hovering over the plate lane with the ALT key pressed. The cursor

Option	Action
	changes to '+', and clicking on the plate will deposit a new band.
Add Lane	Adds a new lane.
Duplicate Lane	Adds a duplicate lane. CTRL+dragging a selected lane also duplicates a lane.
Delete Lane	Deletes a lane.

All of the items in a particular lane can be modified simultaneously, by hovering over the lane and selecting the required context menu option. For example, you can display all the items in a lane in a specific color, or have them display specific styles.

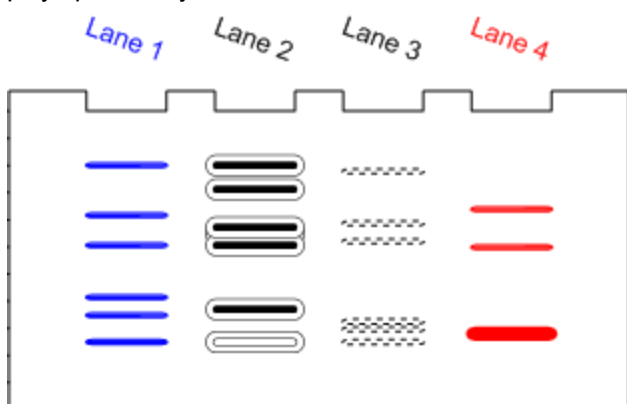

You can perform the following action on a band:

Option	Action
Show size.	The current value of the band appears above it. The value is always shown on top of the band, and is always bound to it. If you drag it to another position, a tether appears between the band and the text.

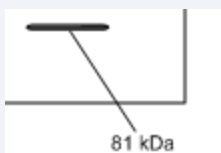

You can move the marker label by pressing the ALT key.

Set Size.	A dialog box prompting for the new mass(size) of the band appears. The band will be automatically moved according to its new value. You can locate the bands that fall out of range
-----------	---

Option**Action**

and are hidden.

Style

Specify the style for the selected band. There are four possible style options available- Filled, Not filled, dashed-bold, and doubled-filled bands. The styles can also be combined.

**Set Custom Band**

A dialog box prompting you to select a graphic file to be displayed as the selected band appears.

**Duplicate Band**

To duplicate a band, select a band and CTRL+drag .

Remove Custom Band

The custom band setting is removed for the selected band and the band appears in its default style.

Delete Band

Deletes a band from the lane. You can also delete the bands in a lane by hovering over them and pressing Delete.

 **Note:** You can have empty lanes.

ChemNMR (Professional Level)

Using ChemNMR, you can estimate and display proton and Carbon-13 chemical shifts for a selected molecule. As with ChemDraw, you can also use Chem3D to predict NMR. Chem3D includes several interfaces to computational chemistry packages which predict NMR. Some packages predict IR spectra and other spectra as well. For more information on Chem3D packages, which have NMR predictions, and their available parameters, see the *Chem3D User Guide*.

Setting Parameters Values in ChemNMR

Use the ChemNMR option in Preferences dialog to set the parameter values in ChemNMR. See the example below:

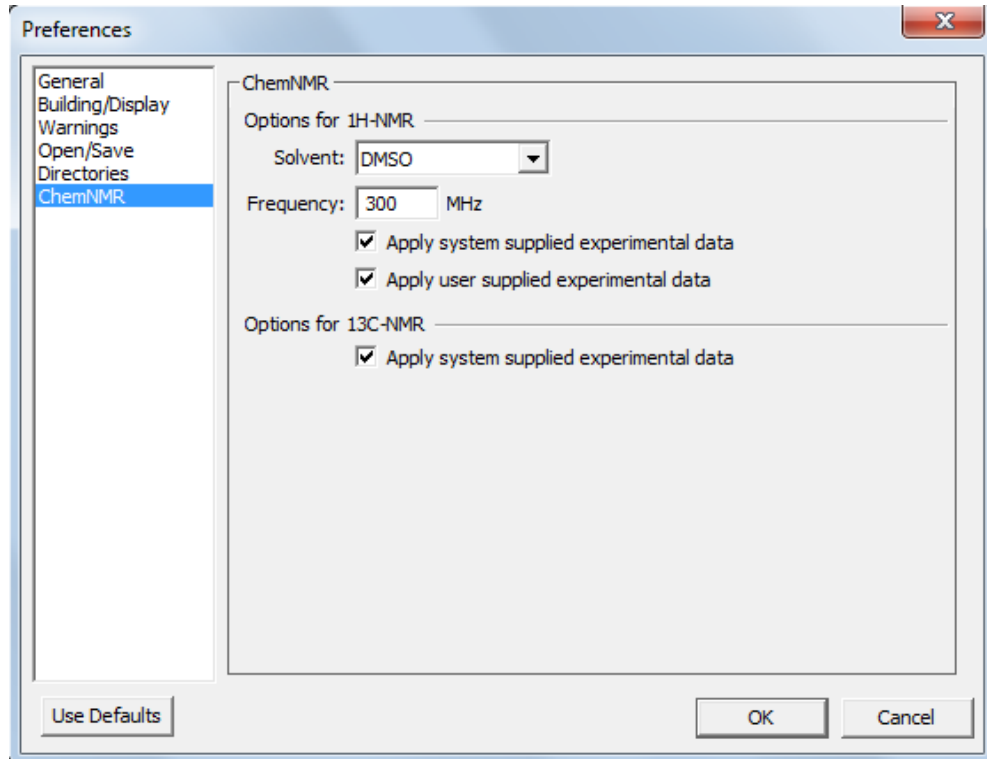

Solvent

The solvent is not user-definable in ChemNMR, except by adding new custom shift correction data. Most spectra in the default ChemNMR database are run in deuterated chloroform, but the database is intended to be solvent-free. In ChemDraw, you can set either deuterated chloroform, or deuterated dimethyl sulfoxide as solvent from the Preferences dialog. Spectral shifts which depend on the solvent are generally indicated as "rough" predictions.

Spectrometer Frequency

ChemNMR's default for estimating proton NMR is a spectrometer frequency of 300 MHz. To change the default frequency, either set the new frequency using the Preferences dialog, or hold the <Alt> key while selecting **Predict 1H-NMR Shifts**, and enter a frequency in MHz and run the spectrum. The new frequency will apply until you reset it, including after closing ChemDraw. The spectrometer frequency parameter only applies to proton NMR.

For further information, see:

- ["NMR Shifts" on page 184](#) (How to run NMR predictions in ChemDraw)
- ["Assigning Structures to Spectra" on page 185](#) (Re-linking atoms to peaks)
- ["Viewing Spectral Assignments" on page 185](#) (Peaks associated with atoms)
- ["Removing Spectral Assignments" on page 186](#) (Dissociating peaks from atoms)
- ["Custom Shift Correction Data" on page 186](#) (Adding new spectrum information)
- ["ChemNMR Limitations" on page 189](#) (Elements and standard deviations)
- ["NMR References" on page 189](#) (Source citations)

NMR Shifts

ChemNMR estimates chemical shifts for all hydrogen or carbon atoms for which additivity rules are available. Following a hierarchical list, it first identifies key substructures of a molecule. A substructure provides the base value for the estimated shift. For example, benzene would be the key substructure of trinitrotoluene.

When a substructure is a ring system not available in the data, ChemNMR approximates its base shift using embedded rings and, if necessary, will disassemble the ring into acyclic substructures.

ChemNMR views remaining parts of the molecule as substituents of a substructure. Each substituent adds to, or subtracts from, the base shift of the substructure to which it is attached. Additivity rules determine the increment of each contribution. If an increment for a substituent cannot be determined, ChemNMR uses embedded substituents—smaller structural units with the same neighboring atoms. Or, it will use increments of identical, or embedded substituents, of a corresponding substructure by assuming that the effects of the substituents are of the same magnitude.

ChemNMR provides a detailed protocol of the estimation process applied. It gives substructures as names, compound classes in most cases, substituents in the form of a linear code, respectively.

It also implements models for ethylenes (cis/trans) and cyclohexanes (equatorial/axial)

To view ^1H or ^{13}C NMR information:

1. Select a structure.
2. Navigate to **Structure>Predict 1H-NMR Shifts** or **Predict 13C-NMR Shifts**.

ChemNMR redraws the molecule with the estimated shifts and displays the information and line spectrum in a new window.

Modifying NMR Frequency

You can change the default NMR frequency of 300 Mhz in ChemDraw Proton NMR predictions.

To change the frequency:

1. Navigate to **File>Preferences**. The Preferences dialog appears.
2. Select **ChemNMR** option.

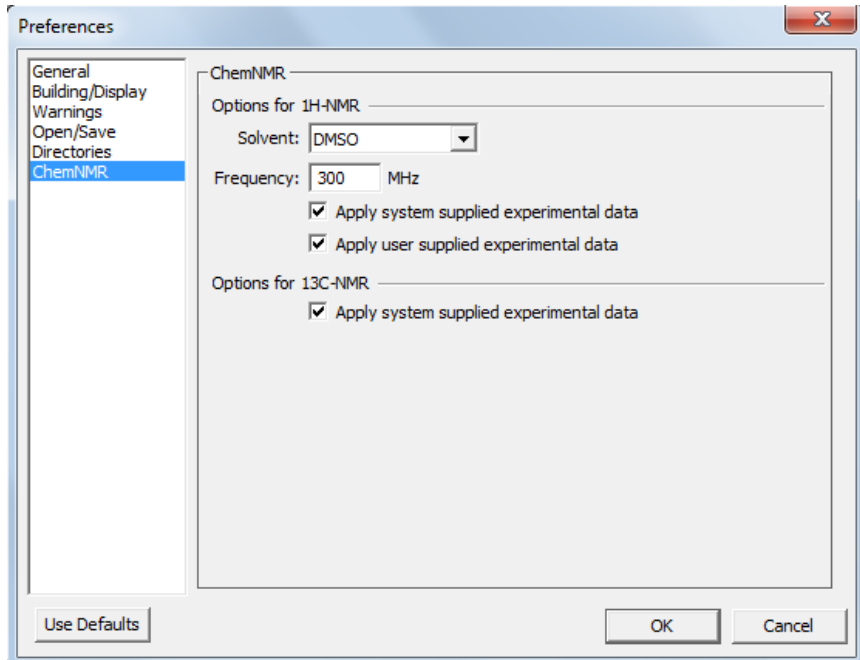

3. Specify the new frequency in the Frequency text box.
4. Click **OK**.
5. Navigate to **Structure>Predict 1H-NMR Shifts**. The predicted NMR spectrum appears.

Assigning Structures to Spectra

ChemDraw Professional lets you assign structures to spectra. You can then display the structure associated with a specific peak by placing the pointer on that peak.

To assign structures to spectra:

1. Open a spectral file.
2. Draw the structure (or structures) to assign to the spectrum.
3. Select specific atoms and bonds in the structure.
4. <Shift>+click the peak, or peaks, to which you want the structure assigned.

The selection rectangle surrounds the selected objects.

5. Navigate to **Structure>Make Spectrum-Structure Assignment**.

The selected atoms and bonds in the structure are associated with the selected spectral peaks.

Viewing Spectral Assignments

To view spectral assignments:

1. Click the Lasso or Marquee tool.
2. Place the pointer over a peak. The assigned atoms or bonds are highlighted.

Removing Spectral Assignments

To remove spectrum to structure assignments:

1. Click the Lasso or Marquee tool.
2. Select the objects from which to remove the assignment.
3. Navigate to **Structure>Clear Spectrum-Structure**.

Custom Shift Correction Data

You can add your own shift correction data for proton prediction to supplement the existing data that the ChemNMR algorithm uses. You provide your data in an SDfile and use the file to update the ChemDraw ChemNMR database. Using a third-party tool, such as ACD Labs software or Mnova Lite, you can enhance your prediction results, thereby supporting your analysis process. With Mnova Lite, you can assign your spectra in Mnova NMR and save those assignments to an SD file. Add them to ChemNMR database. With enough added data, the prediction results improve. (Consult your application's User Guide for instructions).

NMR Data Format

The correction data that you add to your SDF file must be in this format:

```
> <SHIFT>  
<atom_id>,<shift_value>,<ignored>
```

For example:

```
> <SHIFT1>  
2,9.61,0.0  
> <SHIFT2>  
3,8.92,0.0
```

The correction data for each molecule must appear after the molecule's structural data. For example, if your SDF file includes benzene, the NMR data must immediately follow the benzene structural data.

Updating the ChemNMR Database

Once you have an SDF file that contains the supplementary data, follow these steps to update the ChemNMR database:

1. Exit ChemDraw.
2. Locate the ChemDraw ChemNMR directory.
3. Open a DOS prompt:
 - In Windows 8, navigate to **Start>Run** and enter `cmd` in the Run window. Click **OK**.
 - In Windows 7, go to **Start** and enter `cmd` in the search field. Press the <Enter> key.
4. At the DOS prompt, navigate to the ChemNMR directory in step 2.
5. Enter the command:

```
MakeChemNMRUserDB.exe <input file> <resource directory> <output directory>  
where
```

- *<input file>* is the full path and filename of the SDF file that contains the correction data.
- *<resource directory>* and *<output directory>* are the full path to the ChemNMR directory.

6. Restart ChemDraw.

Restoring Default NMR Data

To stop using your own data and restore ChemDraw to its original settings:

1. Exit ChemDraw.
2. Locate the ChemNMR directory.
3. Delete the files Ushiftdb5H1.txt and Usimilvecx.h1.
4. Restart ChemDraw.

Example Supplementary Data

The example below represents an SDF file that includes supplementary NMR data for two structures. The supplementary data follows the structure data and is shaded gray for clarity.

```
ACD/Labs07190711112D

14 14 0 0 0 0 0 0 0 0 15 V2000
5.7578 -1.9992 0.0000 C 0 0 0 0 0 0 0 0 0 0 0 0
5.7578 -3.3267 0.0000 C 0 0 0 0 0 0 0 0 0 0 0 0
4.6062 -1.3275 0.0000 C 0 0 0 0 0 0 0 0 0 0 0 0
4.6062 -3.9825 0.0000 N 0 0 0 0 0 0 0 0 0 0 0 0
3.4547 -1.9992 0.0000 C 0 0 0 0 0 0 0 0 0 0 0 0
3.4547 -3.3267 0.0000 C 0 0 0 0 0 0 0 0 0 0 0 0
6.9094 -1.3275 0.0000 N 0 3 0 0 0 0 0 0 0 0 0 0
8.0609 -1.9992 0.0000 O 0 5 0 0 0 0 0 0 0 0 0 0
6.9094 -0.0000 0.0000 O 0 0 0 0 0 0 0 0 0 0 0 0
2.3031 -1.3275 0.0000 C 0 0 0 0 0 0 0 0 0 0 0 0
2.3031 -0.0000 0.0000 C 0 0 0 0 0 0 0 0 0 0 0 0
1.1516 -1.9992 0.0000 C 0 0 0 0 0 0 0 0 0 0 0 0
1.1516 -3.3267 0.0000 O 0 0 0 0 0 0 0 0 0 0 0 0
0.0000 -1.3275 0.0000 O 0 0 0 0 0 0 0 0 0 0 0 0
1 2 1 0 0 0
1 3 2 0 0 0
1 7 1 0 0 0
2 4 2 0 0 0
3 5 1 0 0 0
4 6 1 0 0 0
5 6 2 0 0 0
5 10 1 0 0 0
```

```

7 8 1 0 0 0 0
7 9 2 0 0 0 0
10 11 1 0 0 0 0
10 12 1 0 0 0 0
12 13 2 0 0 0 0
12 14 1 0 0 0 0
M ZC 1 5
M ZC 2 6
M ZC 3 4
M ZC 4 1
M ZC 5 3
M ZC 6 2
M CHG 2 7 1 8 -1
M ZC 7 9
M ZC 8 13
M ZC 9 10
M ZC 10 7
M ZC 11 8
M ZC 12 11
M ZC 13 12
M END
> <ID>
1
> <solvent>d6-DMSO> <SHIFT1>2,9.61,0.0> <SHIFT2>3,8.92,0.0>
<SHIFT3>6,9.01,0.0> <SHIFT4>10,3.11,0.0> <SHIFT5>11,1.16,0.0>
<SHIFTS>5$$$$ TH> <solvent>d6-DMSO> <SHIFT1>2,9.6,0.0>
<SHIFT2>3,8.91,0.0> <SHIFT3>6,9.11,0.0> <SHIFT4>10,2.75,0.0>
<SHIFT5>11,1.17,0.0> <SHIFT6>12,2.41,0.0> <SHIFTS>6$$$$
ACD/Labs07190711112D 15 15 0 0 0 0 0 0 0 0 16 V2000 7.1683 -1.9521 0.0000 C 0 0 0 0
0 0 0 0 0 0 0 7.1683 -3.2484 0.0000 C 0 0 0 0 0 0 0 0 0 0 0 0 0 0 0 0 6.0438 -1.2962 0.0000 C
0 0 0 0 0 0 0 0 0 0 0 0 0 0 0 0 6.0438 -3.8887 0.0000 N 0 0 0 0 0 0 0 0 0 0 0 0 0 0 0 0 4.9194 -1.9521
0.0000 C 0 0 0 0 0 0 0 0 0 0 0 0 0 0 0 0 4.9194 -3.2484 0.0000 C 0 0 0 0 0 0 0 0 0 0 0 0 0 0 0 0 8.2927 -
1.2962 0.0000 N 0 3 0 0 0 0 0 0 0 0 0 0 0 0 0 0 9.4171 -1.9521 0.0000 O 0 5 0 0 0 0 0 0 0 0 0 0
8.2927 -0.0000 0.0000 O 0 0 0 0 0 0 0 0 0 0 0 0 0 0 0 0 3.7950 -1.2962 0.0000 C 0 0 0 0 0 0 0 0
0 0 0 0 3.7950 -0.0000 0.0000 C 0 0 0 0 0 0 0 0 0 0 0 0 0 0 0 0 2.2489 -2.1708 0.0000 C 0 0 0 0
0 0 0 0 0 0 0 0 1.1401 -1.5149 0.0000 C 0 0 0 0 0 0 0 0 0 0 0 0 0 0 0 0 0.0000 -2.1552 0.0000 O
0 0 0 0 0 0 0 0 0 0 0 0 0 0 0 0 1.1401 -0.2186 0.0000 O 0 0 0 0 0 0 0 0 0 0 0 0 0 0 0 0 1 2 1 0 0 0 0 1 3 2
0 0 0 0 1 7 1 0 0 0 0 2 4 2 0 0 0 0 3 5 1 0 0 0 0 4 6 1 0 0 0 0 5 6 2 0 0 0 0 5 10 1 0 0 0 0 7
8 1 0 0 0 0 7 9 2 0 0 0 0 10 11 1 0 0 0 0 10 12 1 0 0 0 0 12 13 1 0 0 0 0 13 14 2 0 0 0 0 13

```

```

15 1 0 0 0 0M ZCC 1 5M ZCC 2 6M ZCC 3 4M ZCC 4 1M ZCC 5 3M ZCC 6 2M CHG 2 7 1 8 -
1M ZCC 7 9M ZCC 8 14M ZCC 9 10M ZCC 10 7M ZCC 11 8M ZCC 12 11M ZCC 13 12M ZCC
14 13M END> <ID>2
> <solvent>d6-DMSO> <SHIFT1>2,9.6,0.0> <SHIFT2>3,8.91,0.0>
<SHIFT3>6,9.11,0.0> <SHIFT4>10,2.75,0.0> <SHIFT5>11,1.17,0.0>
<SHIFT6>12,2.41,0.0> <SHIFTS>6$$$$
  
```

ChemNMR Limitations

- The program handles the following elements and isotopes:
H, D, He, Li, Be, B, C, N, O, F, Ne, Na, Mg, Al, Si, P, S, Cl, Ar, K, Ca, Sc, Ti, V, Cr, Mn, Fe, Co, Ni, Cu, Zn, Ga, Ge, As, Se, Br, Kr, Rb, Sr, Y, Zr, Nb, Mo, Tc, Ru, Rh, Pd, Ag, Cd, In, Sn, Sb, Te, I, Xe, Cs, Ba, La, Ce, Pr, Nd, Pm, Sm, Eu, Gd, Tb, Dy, Ho, Er, Tm, Yb, Lu, Hf, Ta, W, Re, Os, Ir, Pt, Au, Hg, Tl, Pb, Bi, Po, At, Rn, Fr, Ra, Ac, Th, Pa, U, Np, Pu, Am, Cm, Bk, Cf, Es, Fm, Md, No, Lr.
- Functional groups are expanded automatically.
- In the case of ^1H NMR, it estimates shifts of about 90% of all CH_x -groups with a standard deviation of 0.2-0.3 ppm. The use of polar solvents may strongly increase these deviations. It does not estimate shifts of hydrogen atoms bonded to heteroatoms because they are significantly affected by solvents, concentration, impurities, and steric effects.
- In case of ^{13}C NMR, it estimates over 95% of the shifts with a mean deviation of -0.29 ppm and standard deviation of 2.8 ppm.

NMR References

Sources for ChemDraw NMR data include the following publications:

- Fürst, A.; Pretsch, E. *Anal. Chim. Acta* 1990, 229, 17.
 Pretsch, E.; Fürst, A.; Badertscher M.; Bürgin, R.; Munk, M. E. *J. Chem. Inf. Comp. Sci.* 1992, 32, 291-295.
 Bürgin Schaller, R.; Pretsch, E. *Anal. Chim. Acta* 1994, 290, 295.
 Bürgin Schaller, R.; Arnold, C.; Pretsch, E. *Anal. Chim. Acta* 1995, 312, 95-105.
 Bürgin Schaller, R.; Munk, M. E.; Pretsch, E. *J. Chem. Inf. Comput. Sci.* 1996, 36, 239-243.

ChemDraw/Excel and CombiChem

ChemDraw/Excel is an add-in for Microsoft Excel for Windows. You can add chemical structures and other data from ChemDraw or a ChemFinder database to an Excel worksheet. Afterward, you can calculate any of a vast array of structural properties or examine search results from an SDfile. It has the same search features as ChemFinder. When you install the add-in, a ChemOffice menu is added to the Excel menu and a toolbar appears.

Setting Up ChemDraw/Excel

When you install ChemDraw, ChemDraw/Excel is also installed. The ChemDraw/Excel add-in adds a new tab to Excel 2016, Excel 2010, Excel 2013 ribbon interface.

If the ChemDraw/Excel add-in is disabled, to enable it:

1. Go to **File>Options>Add-ins**.
2. Select ChemDraw for Excel and click **Go**.
3. From Add-Ins window make sure **ChemDraw for Excel 16** and **ChemDrawExcel 16** functions are checked.
4. Click **OK**.

ChemDraw/Excel add-in may also be disabled by some other third-party product by programmatically changing registry values. In this case, you can enable it by resetting the value of "LoadBehavior" at: HKEY_LOCAL_MACHINE\SOFTWARE\Microsoft\Office\Excel\Addins\ChemDrawExcelAddIn16.ExcelAddIn and HKEY_LOCAL_MACHINE\SOFTWARE\Wow6432Node\Microsoft\Office\Excel\Addins\ChemDrawExcelAddIn16.ExcelAddIn (for 64-bit system running 32-bit Microsoft Office). Reset the value of 'LoadBehavior' to 3 from 0 and re-launch Excel.

To use ChemDraw/Excel, open a ChemOffice worksheet. Go to **ChemOffice16>New ChemOffice Worksheet**. When a worksheet is active, ChemDraw/Excel appears in the title bar.

To convert a normal Excel worksheet into a ChemDraw/Excel worksheet, go to **ChemOffice16 >Convert Worksheet**. "ChemDraw for Excel" appears in the Excel title bar.

Older ChemDraw/Excel workbooks may be incompatible with the latest add-in. Therefore, you may need to upgrade them. To upgrade, go to **ChemOffice16>Upgrade Workbook**.

Importing tables

ChemDraw/Excel lets you import from:

- MDL SDFiles Imports all records in the file. By default, the name of the structure is its chemical formula. However, you can change the name by using **Name Molecule** command.
- ChemFinder Databases(CFW, CFX) Imports all fields stored in the main form.

 **Note:** To import CFW files into Excel, save them with the “allow CAL/OLE Automation access” security setting checked. See “Setting Security Options” in the ChemFinder user guide for details.

 **Note:** Structures saved as ChemFinder XML files can be imported into Excel using the add-in.

When you import a table, structure data are transformed into structure drawings in the first column, and all other fields are imported in separate columns.

To import a table:

1. In Excel, select the cell where you want the import to start. The upper-left corner of the import is at this cell. Data is filled down and to the right.
2. Go to **ChemOffice16>Import/Export>Import Table**. The Import Table dialog box appears.
3. Type or select the file name to import and click **Open**. All records are added to your worksheet.

 **Note:** A progress dialog displays the import progress. You can cancel the import process at any time by clicking **Cancel**. On clicking **Cancel**, you will be prompted either keep the records which were imported, or cancel the import process or continue with importing.

 **Note:** You can only import a table into a new ChemOffice worksheet.

Importing hit lists

You can search records in ChemFinder and import the hit list structures with data into Excel using the Import ChemFinder List command.

To import a hit list:

1. Go to **ChemOffice16>Import/Export>Import ChemFinder List**.
2. If you are prompted to start ChemFinder, click **Yes**.
3. In the message box, click **Yes** to import the hit list. The records are imported into Excel.

Exporting tables

ChemDraw/Excel lets you export tables to MDL SDF files format. The first column of the area you select to export must have the word “Structure” in its top cell. Structures outside the first column are discarded.

To export data:

1. Select the cells to export, including the cell that contains the word “Structure”.

 **Note:** You can export selected rows and columns from a structure table. Ensure that the cell selection is continuous. See examples below.

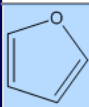
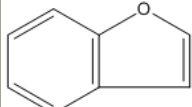
A1 Structure						
	A	B	C	D	E	F
1	Structure	Formula	MolWeight	Mol_ID	Molname	
						
2	C ₄ H ₄ O	C ₄ H ₄ O	68.074	3	Furan	
						
3	C ₉ H ₆ O	C ₉ H ₆ O	118.133	23	Benzofuran	

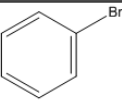
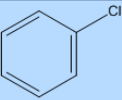
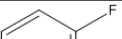
A3 C6H5Br						
	A	B	C	D	E	F
1	Structure	MOLREGNO	MOLNAME	CORP_ID	DATE	ACTIVITY
						
2	C ₆ H ₆	2	Benzene	MUSE00000002	1/1/91	
						
3	C ₆ H ₅ Br	3	Bromobenzene	MUSE00000003	1/1/91	
						
4	C ₆ H ₅ Cl	4	Chlorobenzene	MUSE00000004	1/1/91	
						

- Go to **ChemOffice16>Import/Export>Export Table**.
- In the **Save Table To** dialog box, type the file name and click **Save**. The status bar displays the progress.

Synchronizing Tables

You can synchronize a table in your worksheet with a ChemFinder database, for example, a .CFX file. On synchronizing a ChemDraw/table with a ChemFinder table, fields (and their data) in the ChemFinder table that are not in the MS Excel table are added to the MS Excel table.

 **Note:** Changes you make in MS Excel do not affect the table in ChemFinder.

To synchronize a table:

- Select the table.
- Go to **ChemOffice16>Sync Table with ChemFinder DB**.
- Select the ChemFinder table and click **Open**.
- Select the fields to be used for matching a worksheet row with the database record and click **OK**.
- Select the fields to be updated. To select multiple fields, press <Ctrl> + click each field. Selecting fields marked 'New' will add a column to your worksheet.

6. Click **OK**.

Adding structures

You can add chemical structures to a worksheet from any file format that ChemDraw supports. ChemDraw/Excel assigns the chemical formula as structure name which can be changed by using the **Name Molecule** command. The simplest way to insert a new structure in a cell is by double-clicking a cell.

1. Create a ChemOffice worksheet.
2. Double-click in a cell. ChemDraw/Excel displays a dialog asking you if you want to add a structure to the cell.
3. Click **Yes**. ChemDraw opens.
4. Draw a structure and go to **File>Close** or press <Ctrl>+<W> to return to ChemDraw/Excel. Structure appears on the worksheet.

 **Note:** Double-clicking a structure (or cell containing a structure) on a worksheet will start structure editing in ChemDraw.

Adding a structure from a file

1. In Excel, select the cell into which you want to add the structure.
2. Go to **ChemOffice16>Molecule>Load**. The **Choose Molecule To Load** dialog box appears.
3. Type or select the file name of the structure and click **Open**.

The following formats are supported:

ChemDraw (*.cdx)	MDL Rxn (*.rxn)
ChemDraw XML (*.cdxml)	MDL Graphic (*.tgf)
ChemDraw 3.5 (*.chm)	Connection Table (*.ct)
Chem3D XML (*.c3xml)	MSI Molfile (*.msm)
MDL Molfile (*.mol)	SMD 4.2 (*.smd)
MDL Sketch (*.skc)	

SMILES strings

You can insert SMILES strings into cells and convert them to structures.

1. Type or paste the SMILES strings into one or more cells.
2. Select the cells to convert.
3. Go to **ChemOffice16>Convert>SMILES to Molecule**. Alternatively, you can use the context menu command to convert SMILES to molecule. If the cell does not contain a valid SMILES string, a warning indicating that the number of SMILES strings that cannot be converted appears.

Inchi strings

You can insert Inchi strings into cells and convert them to structures.

1. Type or paste the Inchi strings into one or more cells.

2. Select the cells to convert.
3. Go to **ChemOffice16>Convert>Inchi to Molecule**. If the cell does not contain a valid Inchi string, an error message appears.

Adding structures by name

You can type or paste chemical names into cells and convert the names to structures.

1. Enter the names into cells.
2. Select the cells to convert.

 **Tip:** You can also convert names generated from Excel formulas.

3. Select **ChemOffice16>Convert>Name To Molecule**. If the cell contains a name that Name=Struct supports, the structure appears with the given name as the name of the cell.

Saving structures

You can save a chemical structure to a separate file.

1. In the worksheet, select the cell containing the structure.
2. Go to **ChemOffice16>Molecule>Save**. The Save to File dialog box appears.
3. Select an existing file or enter a new file name and click **Save**.

The following formats are supported:

ChemDraw (*.cdx)	Connection Table (*.ct)
ChemDraw XML (*.cdxml)	MSI Molfile (*.msm)
ChemDraw 3.5 (*.chm)	SMD 4.2 (*.smd)
Chem3D XML (*.c3xml)	Metafile (*.wmf)
MDL Molfile (*.mol)	GIF (*.gif)
MDL Sketch (*.skc)	TIFF (*.tif)
MDL Rxn (*.rxn)	PNG (*.png)
MDL Graphic (*.tgf)	Bitmap (*.bmp)
PostScript (*.eps)	

Searching

You can search for structures based on the criteria and search function you use. ChemDraw/Excel offers three basic search functions:

- Normal search
- Similarity search
- R-Group analysis

Opening a database

Before searching, you must open a structure database.

1. In Excel, go to **ChemOffice16>New ChemOffice Worksheet**.
2. Go to **ChemOffice16>Import/Export>Import Table** or **Import ChemFinder list** and select the file to import.

Normal searches

Use a normal search to find full structures and substructures that match the one you define in the search dialog box.

1. Select a cell containing the label **Structure**.
2. Go to **ChemOffice16>Search>Normal**. The **ChemDraw for Excel** dialog box appears.
3. Select the **Search** Tab.
4. Click in the empty window and draw the structure for which you want to search.
5. Select the **Normal** tab at the bottom of the dialog box.
6. For Search Type, select either **Full Structure** or **SubStructure**.
7. For Filter Type, select to either include or exclude hits.
8. Enter a formula query.
9. Click **Search**. The hit list is displayed in a column named Match. Items matching the search criteria are labeled as **TRUE**.

Similarity searches

Perform a similarity search to find structures with features corresponding to a structure of your choosing. For more information about similarity searching, see the *ChemFinder User's Guide*.

To search for similarity:

1. Select a cell containing the label **Structure**.
2. Go to **ChemOffice16>Search>Similarity**. The **ChemDraw for Excel** dialog box appears.
3. Select the **Search** Tab.
4. Click in the empty window and draw the structure for which you want to search.
5. Select the **Similarity** tab.
6. For Search Type, select either **Full Structure** or **SubStructure**.
7. Select the **Sort Results** order.
8. Select the **Similarity Percent** value.
9. Click **Search**. The hit list is displayed in a column named Similarity. Items matching the search criteria are labeled as **TRUE**.

R-Group analysis

An R-group analysis returns all molecules in the query database that include a template structure that you provide. For example, assume you want to find all molecules that include toluene in its structure, such as p-cresol or o-xylene

(assuming your database includes these molecules). Simply draw toluene as your template and the analysis will return all molecules that contain at least one toluene structure.

To illustrate, assume that you have a small database comprising of four molecules: o-, m-, and p-cresol, and bromobenzene. Further assume you want to run an R-group analysis on this database to find all molecules that contain toluene in its structure. You will find that the results include three main parts:

- The list of molecules that contain the toluene template. In this example, the results include o-, m-, and p-cresol. Bromobenzene is not included because it does not contain the template.
- The toluene template with all variations of R-group attachments that were found in the database. In this example, the attachments are represented by functional groups. These are the locations of the R-groups found in the analysis results; the hydroxyl groups for o-, m-, and p-cresol.

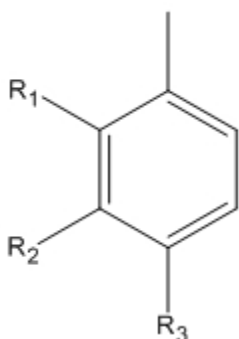

- The functional group found at each Rn position for each search result. For a given returned molecule, look across its row to view the functional group at each R-group position. In this example, the search results consist of a hydrogen and hydroxyl group for R1, R2, and R3.

Working with Structures

ChemDraw/Excel lets you rename structures and use the clipboard to cut, copy, and paste structures.

Renaming Structures

Excel recognizes certain characters as formulas. To prevent the system from interpreting a chemical structure name as an Excel formula, you can rename the structure.

To rename a structure:

1. Select the structure.
2. Go to **ChemOffice16>Molecule>Name**. If multiple cells are selected, go to **ChemOffice16>Molecule>Name All Selected**. The **Name Molecule** dialog box appears.

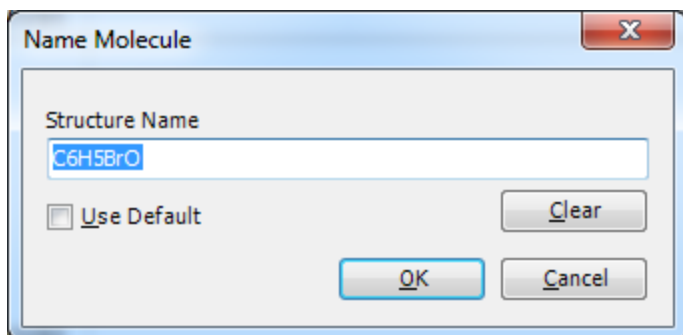

 **Note:** You can remove a structure name by clicking **Clear**. If you select **Use Default**, the name of the structure will be replaced by the default name i.e. Chemical Formula.

3. Type the name and click **OK**.

Using the Clipboard

You can cut, copy, and paste structures using the clipboard. The **Copy As** command in ChemDraw/Excel lets you copy a structure as InChI, InChIkey, or SMILES string.

To cut a structure from a cell:

1. Select the structure.
2. Go to **ChemOffice16>Molecule>Cut**. The structure is placed on the clipboard. When you select Paste, the structure will be removed from the cell and pasted in the specified cell.

To copy a structure from a cell:

1. Select the structure.
2. Go to **ChemOffice16>Molecule>Copy**.

The structure remains in the cell and a copy is placed on the clipboard.

To copy a structure as InChI, InChIkey, or SMILES:

1. Select the structure.
2. Go to **ChemOffice16>Molecule>Copy As** and select from these options:
 - InChI
 - InChIKey
 - SMILES

The structure remains in the cell and a copy in the desired string format is placed on the clipboard.

To paste a structure in a cell:

1. Select the cell where you want to paste the structure.
2. Go to **ChemOffice16>Molecule>Paste**. The structure is pasted from the clipboard.

Displaying Structures

You can display or hide structures in your spreadsheet. You can also adjust the size of cells to display their entire contents.

To show or hide structures:

1. Select the structures.
2. Select **ChemOffice16>Structure>Show** or **Hide**.

Aligning Structures

A structure may be too big for its cell or be improperly positioned.

To align structures, select the cell that contains the structure and go to **ChemOffice16>Structure>Align**. The cells adjust to display their contents.

Resizing Structures

1. Select the cell(s) whose structure(s) you want to resize.
2. Go to **ChemOffice16>Structure>Resize**. Resize handles appear on the selected structures.
3. Click-drag the resize handles to resize a structure. Any changes you make to a picture is proportionately reflected in the other structures.
4. To end resizing, click a cell and the structures are deselected.

By default, the structure's resize property is set to **'Move and Resize with cells'** to avoid bunched up structures.

ChemDraw/Excel Functions

ChemDraw/Excel supplies a library of functions that return chemical properties of structures in a ChemDraw/Excel worksheet.

To insert a ChemDraw/Excel function into your worksheet:

1. Select the target cell.
2. Go to **ChemOffice16>ChemDraw Functions (Options>ChemDraw Functions** in Excel 2010). The ChemDraw for Excel dialog box appears.
3. Double-click the function you want to insert from the list available in the Functions tab. A Functions Argument dialog box appears.
4. Select the structure.
5. Click **OK**.

Each property is calculated using the "best available" method. If the cell reference argument does not point to a valid structure cell, #N/A appears in the cell.

All ChemDraw/Excel functions are described below.

Chemical name

Displays systematic names for chemical structures with support for the Cahn-Ingold-Prelog rules for stereochemistry.

Function

CFW_CHEMICAL_NAME(cell ref)

Example

In cell: =CFW_CHEMICAL_NAME (A2)

Result: 1-(2,3-dihydro-1H-inden-2-yl)propan-2-one



Note: Some PerkinElmer Informatics product packages and levels allow unlimited structure-to-name conversions, while others impose a daily limit.

Chemical composition

When this function is called with just a cell reference, it displays the elemental percent by weight for all elements in the structure. When this function is called with a cell reference and an atomic symbol, it displays the fraction by weight of the given element in the structure.

Functions

CHEM_COMPOSITION (cell ref)

CHEM_COMPOSITION (cell ref, atomic symbol)

Examples

In cell: =CHEM_COMPOSITION (A2)

Result: C,82.72;H,8.10;O,9.18

In cell: =CHEM_COMPOSITION (A2, "C")

Result: 0.827188133

Chemical formula

Displays the chemical formula for the structure(s) in the cell.

Functions

CHEM_FORMULA (cell ref)

CHEMPROPSTD_MOL_FORMULA (cell ref)

Examples

In cell: =CHEM_FORMULA (A2)

Result: C12H14O

In cell: =CHEMPROPSTD_MOL_FORMULA (A2)

Result: C12H14O

Molecular weight

Displays the average molecular mass of the structure, where atomic masses are based on the weighted average of all isotope masses for the element.

Units

atomic mass units

Functions

CHEM_MOLWEIGHT (cell ref)

CHEMPROPSTD_MOL_WEIGHT (cell ref)

CHEMPROPSTD_MASS (cell ref)

Examples

In cell: =CHEM_MOLWEIGHT (A2)

Result: 174.23896

In cell: =CHEMPROPSTD_MOL_WEIGHT (A2)

Result: 174.238960

In cell: =CHEMPROPSTD_MASS (A2)

Result: 174.238960

Exact mass

Displays the exact molecular mass of the molecule, where atomic masses of each atom are based on the most common isotope for the element.

Units

g/mole

Function

CHEMPROPSTD_EXACT_MASS (cell ref)

Example

In cell: =CHEMPROPSTD_EXACT_MASS (A2)

Result: 174.104465

Number of atoms

When this function is called with just a cell reference, it displays the total number of atoms in the structure. When this function is called with a cell reference and an atomic symbol, it displays the number of atoms of the given element in the structure.

Functions

CHEM_NUM_ATOMS (cell ref)

CHEM_NUM_ATOMS (cell ref, atomic symbol)

Examples

In cell: =CHEM_NUM_ATOMS (A2)

Result: 27

In cell: =CHEM_NUM_ATOMS (A2, "C")

Result: 12

Number of hydrogen-bond acceptors

Displays the number of hydrogen-bond acceptors based on topology.

Function

CHEM_NUM_HBACCEPTORS (cell ref)

Example

In cell: =CHEM_NUM_HBACCEPTORS (A2)

Result: 1

Number of hydrogen-bond donors

Displays the number of hydrogen-bond donors based on topology.

Function

CHEM_NUM_HBDONORS (cell ref)

Example

In cell: =CHEM_NUM_HBDONORS (A2)

Result: 0

SMILES string

Displays the SMILES string for the structure.

Function

CHEM_SMILES (cell ref)

Example

In cell: =CHEM_SMILES (A2)

Result: O=C(C)CC(C1)Cc2c1cccc2

Formal charge

Displays the net charge on the molecule.

Function

CHEMPROPSTD_FORMAL_CHARGE (cell ref)

Example

In cell: =CHEMPROPSTD_FORMAL_CHARGE (A2)

Result: -1

Does cell have a structure drawing?

Returns TRUE if the cell has a ChemOffice/Excel structure drawing or reaction drawings, returns FALSE otherwise.

Function

ISSTRUCTURE (cell ref)

Example

In cell: =ISSTRUCTURE (A2)

Result: False

Does cell have reaction drawing?

Returns TRUE if the cell contains a drawing of a reaction.

Function

ISREACTION (cell ref)

Example

In cell: =ISREACTION (A2)

Result: True

Boiling point

The boiling point for the molecule at 1 atm.

Units

Kelvin

Function

CHEMPROPPRO_BOILING_POINT (cell ref)

Example

In cell: =CHEMPROPPRO_BOILING_POINT (A2)

Result: 540.059

Melting/freezing point

The melting/freezing point for the structure at 1 atm.

Units

Kelvin

Function

CHEMPROPPRO_MELTING_POINT (cell ref)

Example

In cell: =CHEMPROPPRO_MELTING_POINT (A2)

Result: 331.31

Vapor pressure

The vapor pressure for the structure at 25° C.

Units

P_a

Function

CHEMPROPPRO_VAPOR_PRESSURE (cell ref)

Example

In cell: =CHEMPROPPRO_VAPOR_PRESSURE (A2)

Result: 47.57999897

Critical pressure

The minimum pressure that must be applied to liquefy the structure at the critical temperature.

Units

bar

Function

CHEMPROPPRO_CRITICAL_PRESSURE (cell ref)

Example

In cell: =CHEMPROPPRO_CRITICAL_PRESSURE (A2)

Result: 49.804

Critical temperature

The temperature above which the gas form of the structure cannot be liquefied, no matter the applied pressure.

Units

Kelvin

Function

CHEMPROPPRO_CRITICAL_TEMPERATURE (cell ref)

Examples

In cell: =CHEMPROPPRO_CRITICAL_TEMPERATURE (A2)

Result: 615.351

Critical volume

The volume occupied at the compound's critical temperature and pressure.

Units

cm³/mole

Function

CHEMPROPPRO_CRITICAL_VOLUME (cell ref)

Example

In cell: =CHEMPROPPRO_CRITICAL_VOLUME (A2)

Result: 562.5

Gibbs free energy

The Gibbs free energy for the structure at 298.15 K and 1 atm.

Units

kJ/mole

Function

CHEMPROPPRO_GIBBS_FREE_ENERGY (cell ref)

Example

In cell: =CHEMPROPPRO_GIBBS_FREE_ENERGY (A2)

Result: 84.77

Heat of formation

The heat of formation for the structure at 298.15 K and 1 atm.

Units

kcal/mole

Function

CHEMPROPPRO_HEAT_OF_FORMATION (cell ref)

Examples

In cell: =CHEMPROPPRO_HEAT_OF_FORMATION (A2)

Result: -105.73

Ideal gas thermal capacity

The constant pressure (1 atm) molar heat capacity at 298.15 K for an ideal gas compound.

Units

J/[mole K]

Function

CHEMPROPPRO_IDEAL_GAS_THERMAL_CAPACITY (cell ref)

Example

In cell: =CHEMPROPPRO_IDEAL_GAS_THERMAL_CAPACITY (A2)

Result: 201.036

LogP

The logarithm of the partition coefficient for n-octanol/water.

Functions

CHEMPROPPRO_LOGP (cell ref)

CLOGP_DRIVER_PARTITION_COEFFICIENT (cell ref)

Examples

In cell: =CHEMPROPPRO_LOGP (A2)

Result: 2.233

In cell: =CLOGP_DRIVER_PARTITION_COEFFICIENT (A2)

Result: 2.243

Molar refractivity

The molar refraction index.

Units

cm³/mole

Functions

CHEMPROPPRO_MOL_REFRACTIVITY (cell ref)

CLOGP_DRIVER_MOL_REFRACTIVITY (cell ref)

Examples

In cell: =CHEMPROPPRO_MOL_REFRACTIVITY (A2)

Result: 53.305

In cell: =CLOGP_DRIVER_MOL_REFRACTIVITY (A2)

Result: 5.3297

Water solubility

Prediction of the water solubility of the structure at 25° C.

Units

mg/L

Function

CHEMPROPPRO_WATER_SOLUBILITY (cell ref)

Example

In cell: =CHEMPROPPRO_WATER_SOLUBILITY (A2)

Result: 0

Connolly solvent accessible surface area

The locus of the center of a spherical probe (representing the solvent) as it is rolled over the molecular model.

Units

Angstroms²

Function

CHEMPROPSTD_CONNOLLY_ACCESSIBLE_AREA (cell ref)

Example

In cell: =CHEMPROPSTD_CONNOLLY_ACCESSIBLE_AREA (A2)

Result: 428.557



Note: The default probe radius used in the calculations is 1.4 angstroms.

Connolly molecular surface area

The contact surface created when a spherical probe (representing the solvent) is rolled over the molecular model.

Units

Angstroms²

Function

CHEMPROPSTD_CONNOLLY_MOLECULAR_AREA (cell ref)

Example

In cell: =CHEMPROPSTD_CONNOLLY_MOLECULAR_AREA (A2)

Result: 212.294

 **Note:** The default probe radius used in the calculations is 1.4 angstroms.

 **Note:** The surface area calculation is performed with Michael Connolly's program for computing molecular surface areas and volume (M.L. Connolly. *The Molecular Surface Package*. *J. Mol. Graphics* **1993**, 11).

Connolly solvent-excluded volume

The volume contained within the contact molecular surface.

Units

Angstroms³

Function

CHEMPROPSTD_CONNOLLY_SOLVENT_EXCLUDED_VOLUME (cell ref)

Example

In cell: =CHEMPROPSTD_CONNOLLY_SOLVENT_EXCLUDED_VOLUME (A2)

Result: 170.277

 **Note:** The volume calculation is performed with Michael Connolly's program for computing molecular surface areas and volume (M.L. Connolly. *The Molecular Surface Package*. *J. Mol. Graphics* **1993**, 11).

Ovality

The ratio of the molecular surface area to the minimum surface area. The minimum surface area is the surface area of a sphere having a value equal to the solvent-excluded volume of the molecule. Computed from the Connolly Molecular Surface Area and Solvent-Excluded Volume properties.

Function

CHEMPROPSTD_OVALITY (cell ref)

Example

In cell: =CHEMPROPSTD_OVALITY (A2)

Result: 1.428947

Principal moments of Inertia (X, Y, Z)

The moments of inertia when the Cartesian coordinate axes are the principal axes of the molecule.

Units

grams/mole angstroms²

Function

CHEMPROPSTD_PRINCIPAL_MOMENT (cell ref)

Example

In cell: =CHEMPROPSTD_PRINCIPAL_MOMENT (A2)

Result: 249.546 1409.279 1658.824

Balaban index

Function

MOLECULAR_TOPOLOGY_BALABAN_INDEX (cell ref)

Example

In cell: =MOLECULAR_TOPOLOGY_BALABAN_INDEX (A2)

Result: 29909

Cluster count

Function

MOLECULAR_TOPOLOGY_CLUSTER_COUNT (cell ref)

Example

In cell: =MOLECULAR_TOPOLOGY_CLUSTER_COUNT (A2)

Result: 13

Topological index

Function

MOLECULAR_TOPOLOGY_MOLECULAR_TOPOLOGICAL_INDEX (cell ref)

Example

In cell: =MOLECULAR_TOPOLOGY_MOLECULAR_TOPOLOGICAL_INDEX (A2)

Result: 1998

Number of rotatable bonds

Function

MOLECULAR_TOPOLOGY_NUM_ROTATABLE_BONDS (cell ref)

Example

In cell: =MOLECULAR_TOPOLOGY_NUM_ROTATABLE_BONDS (A2)

Result: 2

Polar surface area

Function

MOLECULAR_TOPOLOGY_POLAR_SURFACE_AREA (cell ref)

Example

In cell: =MOLECULAR_TOPOLOGY_POLAR_SURFACE_AREA (A2)

Result: 17.07

Radius

Function

MOLECULAR_TOPOLOGY_RADIUS (cell ref)

Example

In cell: =MOLECULAR_TOPOLOGY_RADIUS (A2)

Result: 4

Shape attribute

Function

MOLECULAR_TOPOLOGY_SHAPE_ATTRIBUTE (cell ref)

Example

In cell: =MOLECULAR_TOPOLOGY_SHAPE_ATTRIBUTE (A2)

Result: 11.076923

Shape coefficient

Function

MOLECULAR_TOPOLOGY_SHAPE_COEFFICIENT (cell ref)

Example

In cell: =MOLECULAR_TOPOLOGY_SHAPE_COEFFICIENT (A2)

Result: 0

Sum of degrees

Function

MOLECULAR_TOPOLOGY_SUM_OF_DEGREES (cell ref)

Example

In cell: =MOLECULAR_TOPOLOGY_SUM_OF_DEGREES (A2)

Result: 28

Sum of valence degrees

Function

MOLECULAR_TOPOLOGY_SUM_OF_VALENCE_DEGREES (cell ref)

Example

In cell: =MOLECULAR_TOPOLOGY_SUM_OF_VALENCE_DEGREES (A2)

Result: 40

Topological diameter

Function

MOLECULAR_TOPOLOGY_TOPOLOGICAL_DIAMETER (cell ref)

Example

In cell: =MOLECULAR_TOPOLOGY_TOPOLOGICAL_DIAMETER (A2)

Result: 7

Total connectivity

Function

MOLECULAR_TOPOLOGY_TOTAL_CONNECTIVITY (cell ref)

Example

In cell: =MOLECULAR_TOPOLOGY_TOTAL_CONNECTIVITY (A2)

Result: 0.009821

Total valence connectivity

Function

MOLECULAR_TOPOLOGY_TOTAL_VALENCE_CONNECTIVITY (cell ref)

Example

In cell: =MOLECULAR_TOPOLOGY_TOTAL_VALENCE_CONNECTIVITY (A2)

Result: 0.001157

Wiener index

Function

MOLECULAR_TOPOLOGY_WIENER_INDEX (cell ref)

Example

In cell: =MOLECULAR_TOPOLOGY_WIENER_INDEX (A2)

Result: 249

MOLECULAR_NETWORKS_LOGP

The partition coefficient is a ratio of concentrations of un-ionized compound between two solutions. The logarithm of the ratio of the concentrations of the un-ionized solute in the solvents is called LogP.

Function

MOLECULAR_NETWORKS_LOGP (cell ref)

Example

In cell: =MOLECULAR_NETWORKS_LOGP (A4)

Result: 3.019

MOLECULAR_NETWORKS_LOGS

MOLECULAR_NETWORKS_LogS determines the solubility of a substance, measured in mol/liter.

Function

MOLECULAR_NETWORKS_LOGS (cell ref)

Example

In cell: =MOLECULAR_NETWORKS_LOGS (A4)

Result:-2.029

MOLECULAR_NETWORKS_PKa

MOLECULAR_NETWORKS_PKa is the negative log of the acid dissociation constant Ka. It describes the tendency of compounds or ions to dissociate in solution.

Function

MOLECULAR_NETWORKS_PKa (cell ref)

Example

In cell: =MOLECULAR_NETWORKS_PKa (A4)

Result: 14.834000

Predicting druglikeness

Using ChemDraw/Excel functions, you can create calculators to determine the druglikeness of a structure. You can calculate values for:

1. The Lipinski rule of five
2. The Ghose modifications
3. The Congreve Rule-of-Three

Lipinski rule of five

The Lipinski rule uses five criteria to determine whether a substance is druglike. The substance must have:

- Five or fewer H-bond donors.

- Ten or fewer H-bond acceptors.
- A molecular weight under 500 daltons.
- LogP lower than 5.
- Fewer than two violations of the above four rules.

To determine whether the substance meets the Lipinski rule requirement:

1. Calculate the value of each of these functions:
 - CHEM.NUM.HBDONORS()
 - CHEM.NUM.HBACCEPTORS()
 - CHEM.MOLWEIGHT()
 - CHEMPROPPRO.LOGP()
2. Verify that the value returned by the functions meets the lipinski rule criteria. For example, if the CHEM.MOLWEIGHT() returns a value <500, it satisfies lipinsky's third criteria.
3. Calculate the number of criteria satisfied. If the number of violations is less than two, the Lipinsky rule is satisfied.

Ghose modifications

The Ghose modifications use these criterias:

- Atom count between 20 and 70.
- Molar refractivity between 40 and 130.
- A molecular weight between 160 and 480 daltons.
- LogP in the range -0.4 to +5.6.
- Fewer than two violations of the above four rules.

To determine whether the substance meets the Ghose modification requirement:

1. Calculate the value of each of these functions:
 - CHEM.NUM.ATOMS()
 - CHEMPROPPRO.MOL.REFRACTIVITY()
 - CHEM.MOLWEIGHT()
 - CHEMPROPPRO.LOGP()
2. Verify that the value returned by the functions meets the Ghose modification criteria. For example, if the value returned by the function CHEMPROPPRO.LOGP() for that structure is within the range -0.4 to +5.6, it satisfies Ghose modification's fourth criteria.
3. Calculate the number of criteria satisfied. If the number of violations is less than two, then the Ghose modifications requirement is satisfied.

Congreve rule of three

The "Congreve Rule of Three" uses these criterias:

- Three or fewer H-bond donors.
- Three or fewer H-bond acceptors.

- A molecular weight under 300 daltons.
- LogP lower than 3.
- Fewer than two violations of the above four rules.

To determine if the substance meets the Congreve Rule-of-Three requirement:

1. Calculate the value of each of these functions:
 - CHEM.NUM.HBDONORS()
 - CHEM.NUM.HBACCEPTORS()
 - CHEM.MOLWEIGHT()
 - CHEMPROPPRO.LOGP()
2. Verify that the value returned by the functions meets the Congreve Rule-of-Three criteria. For example, if the if the function CHEMPROPPRO.LOGP() returns a value for the structure that is <3, it satisfies Congreve Rule-of-Three's fourth criteria.
3. Calculate the number of criteria satisfied. If the number of violations is less than two, then the Congreve Rule-of-Three is satisfied.

Chemical Properties

Chemical property prediction is an important feature that ChemOffice applications support. It enables you to calculate values for a wide range of methodologies; for example, topological descriptors such as the Weiner index and Balaban index, thermodynamic descriptors such as solubility, melting and boiling points, and partition coefficients such as CLogP, properties related to the three-dimensional shape and volume of a chemical such as the Connolly surface area and volume. In total you can calculate more than 100 chemical properties for a given structure.

For a list of properties available in any specific applications, click the respective link below. For more information on the properties available in any specific applications, see the respective online help available or visit the [PerkinElmer Informatics Web site](#).

- ["Property predictions in ChemDraw/Excel" on page 212.](#)
- ["Property Predictions in ChemDraw" on page 164.](#)
- ["Property Predictions in Chem3D" on page 169.](#)

Property predictions in ChemDraw/Excel

ChemDraw/Excel includes a variety of functions for reporting properties for a given structure. Each property is calculated using the "best available" method.

To view the properties for a given structure:

1. Select the structure cell.
2. Right-click the cell and select **Structure>Properties** from the context-menu. The Properties dialog box displaying various properties and its values appears.

The properties include:

B	F	MOLECULAR_NETWORKS_LOGP	S
Balaban index	Formal charge	MOLECULAR_NETWORKS_LOGS	Shape attribute
Boiling point	Freezing point	MOLECULAR_NETWORKS_PKa	Shape coefficient
C	G	Molecular formula	Sum Of degrees
Cluster count	Gibbs free energy	Molecular weight	Sum of valence degrees
Connolly accessible area	H	N	T
Connolly molecular surface area	Heat of formation	Num rotatable bonds	Topological diameter
Connolly solvent accessible surface area	Henry's Law constant	O	Total connectivity
Connolly solvent excluded volume	I	Ovality	Total Valence Connectivity
Critical pressure	Ideal gas thermal capacity	P	V
Critical temperature	M	Polar surface area	Vapor pressure
Critical volume	Mass	Principal moment Of inertia	W
E	Melting point	R	Water solubility
Exact mass	Molar refractivity	Radius	Wiener index

About molecular networks

*MOSES.pKa, MOSES.logS and MOSES.logP for predicting acid dissociation constants, aqueous solubility and octanol/water distribution coefficients of chemical compounds are computational calculator modules based on Molecular Networks' cheminformatics platform MOSES. MOSES is developed, maintained and owned by Molecular Networks GmbH, Erlangen, Germany. For further information please visit www.molecular-networks.com/moses. All rights reserved. Molecular Networks GmbH, Erlangen, Germany (www.molecular-networks.com).

Balaban index

$$J = \frac{q}{\mu + 1} \sum_{edges\ ij} (S_i S_j)^{-1/2}$$

Where:

- q is the number of edges in the molecular graph.
- $\mu = (q - n + 1)$ is the cyclomatic number of molecular graph.
- n is the number of atoms in the molecular graph.

- S_i is the sum of all entries in the i^{th} row (or column) of the topological distance matrix of the molecule. The distance matrix stores the shortest path between all pairs of atoms.

Boiling point

The boiling point is report in Kelvin.

A solution boils at a slightly higher temperature than the pure solvent. The change in boiling point is calculated using the formula:

$$\Delta T_b = K_b m$$

Where K_b is the molal boiling point constant, m is the concentration of the solute expressed as molality, and ΔT_b is the change in temperature.

Cluster count

Is the number of paths of a given length in the distance matrix.

Connolly accessible area

This is the locus of the center of a spherical probe (representing the solvent) as it is rolled over the molecular model.

Connolly molecular surface area

The contact surface created when a spherical probe (representing the solvent) is rolled over the molecular model. Units Angstroms².

Connolly solvent accessible surface area

The locus of the center of a spherical probe (representing the solvent) as it is rolled over the molecular model. Units Angstroms².

Connolly solvent excluded volume

This is the volume of space bounded by the solvent accessible molecular surface.

Critical pressure

Reported in bars, this is the least applied pressure required at the critical temperature to liquefy a gas.

Critical temperature

Reported in Kelvin, this is the temperature above which a gas cannot be liquefied, regardless of the pressure applied.

Critical volume

Reported in cm³/mol, this is the volume occupied by one mole of a substance at the critical temperature and pressure.

Exact mass

This is the sum of the masses of the individual isotopes in the molecule. For example, the exact mass of water containing two hydrogen-1 (1H) and one oxygen-16 (16O) is $1.0078 + 1.0078 + 15.9994 = 18.0106$. The exact mass of heavy water, containing two hydrogen-2 (deuterium or 2H) and one oxygen-16 (16O) is $2.014 + 2.014 + 15.9994 = 20.027$.

Formal charge

This is the charge assigned to an atom in a molecule, assuming that electrons in a chemical bond are shared equally between atoms, regardless of relative electronegativity.

The formal charge of any atom in a molecule can be calculated using the formula:

$$FC = V - N - B/2$$

Where 'V' is the number of valence electrons of the atom in isolation (atom in ground state); 'N' is the number of non-bonding electrons on this atom in the molecule; and 'B' is the total number of electrons shared in covalent bonds with other atoms in the molecule.

Freezing point

The freezing point for the structure at 1 atm. Units Kelvin.

Gibbs free energy

Reported in KJ/mole, Gibbs free energy is defined as:

$$G(p, T) = U + pV - TS$$

which is same as:

$$G(p, T) = H - TS$$

Where:

- U is the internal energy (SI unit: Joule)
- p is pressure (SI unit: Pascal)
- V is volume (SI unit: m³)
- T is the temperature (SI unit: Kelvin)
- S is the entropy (SI unit: joule per Kelvin)
- H is the enthalpy (SI unit: Joule)

 **Note:** H and S are thermodynamic values found at standard temperature and pressure..

Heat of formation

Reported in KJ/mole, the heat of formation is the increase in enthalpy resulting from the formation of one mole of a substance from its constituent elements at constant pressure.

Henry's Law constant

A unitless value, Henry's Law Constant can be expressed as:

$$k_{H,pc} = \frac{p}{c}$$

Where 'p' is the partial pressure of the solute in the gas above the solution, 'c' is the concentration of the solute and 'k_{H,pc}' is a constant with the dimensions of pressure divided by concentration. The constant, known as the Henry's law constant, depends on the solute, solvent, and temperature.

Ideal gas thermal capacity

The thermal capacity at constant volume of an ideal gas is:

$$C_V = \left(\frac{\delta U}{\delta T} \right)_V = \hat{c}_V N k_B = \hat{c}_V n R$$

Where:

- c_V is a constant dependent on temperature
- U is the internal energy
- T is the absolute temperature
- V is the volume
- n is the amount of substance of the gas
- R is the gas constant (8.314 J·K⁻¹mol⁻¹ in SI units)
- N is the number of gas particles
- k_B is the Boltzmann constant (1.381×10⁻²³J·K⁻¹ in SI units)

The thermal capacity at constant pressure of an ideal gas is:

$$C_P = \left(\frac{\delta H}{\delta T} \right)_P = (\hat{c}_V + 1) N k$$

Where 'H' is the enthalpy of the gas, calculated as: H = U + pV.

MOLECULAR_NETWORKS_LOGP

The partition coefficient is a ratio of concentrations of un-ionized compound between two solutions. To measure the partition coefficient of ionizable solutes, the pH of the aqueous phase is adjusted so that the predominant form of the compound is un-ionized. The logarithm of the ratio of the concentrations of the un-ionized solute in the solvents is called LogP.

Normally, one of the solvents chosen is water; the second is hydrophobic, such as octanol.

MOLECULAR_NETWORKS_LOGS

MOLECULAR_NETWORKS_LogS determines the solubility of a substance, measured in mol/liter. The aqueous solubility of a compound is known to significantly affect absorption and distribution characteristics of that compound.

MOLECULAR_NETWORKS_PKa

MOLECULAR_NETWORKS_PKa is the negative log of the acid dissociation constant Ka. It describes the tendency of compounds or ions to dissociate in solution.

Mass

This is the mass of one molecule of a substance, relative to the unified atomic mass unit u (equal to 1/12 the mass of one atom of 12C). Also called molecular mass.

Melting point

Is the temperature at which a solid becomes a liquid at standard atmospheric pressure. At the melting point, the solid and liquid phase exist in equilibrium. The formula to calculate melting point is:

$$T = \frac{\Delta H}{\Delta S}$$

Where 'T' is the temperature at the melting point, 'ΔS' is the change in entropy of melting, and 'ΔH' is the change in enthalpy of melting.

Molar refractivity

Is a measure of the total polarizability of one mole of a substance. It is dependent on the temperature, index of refraction, and pressure.

The molar refractivity, 'A' is expressed as:

$$A = \frac{4\pi}{3} N_A \alpha$$

Where 'N_A' is the Avogadro constant and α is the mean polarizability.

Molecular formula

This is the molecular formula of the compound.

Molecular weight

This is the sum of the atomic weights of all atoms in a molecule.

Num rotatable bonds

Is the number of rotatable bonds in a molecule. A rotatable bond is defined as an acyclic bond drawn as a single bond (amide C-N bonds, O=C-N, are rotatable) where the atom on each end has at least one other non-hydrogen substituent. This topological parameter is a measure of molecular flexibility. Unsaturated bonds, and single bonds connected to hydrogens or terminal atoms, single bonds of amides, sulphonamides, and those connecting two hindered aromatic rings (having at least three ortho substituents) are considered non-rotatable.

Ovality

This refers to a measure of how the shape of a molecule approaches a sphere (at one extreme) or a cigar shape (at the other). Ovality is described by a ratio of volume to area:

$$O = A / (4 \times \pi \times ((3 \times V) / 4 \times \pi)^{2/3})$$

Where 'A' is area, 'V' is Volume, and 'O' is Ovality.

The ovality of a helium atom is 1.0 and HC₂₄H (12 triple bonds) is ~1.7 (equivalent to 1.7).

Polar surface area

The Polar Surface Area (PSA) is defined as the surface sum over all polar atoms

Principal moment Of inertia

This refers to the principal moments of inertia about the principal axes of a molecule. The moments of inertia are computed for a series of straight lines through the center of mass using the formula:

$$I = \sum_i m_i d_i^2$$

- Distances are established along each line proportional to the reciprocal of the square root of I on either side of the center of mass. The locus of these distances forms an ellipsoidal surface. The principal moments are associated with the principal axes of the ellipsoid.

- If all three moments are equal, the molecule is considered to be a symmetrical top. If no moments are equal, the molecule is considered to be an asymmetrical top.

Radius

The eccentricity of an atom is the largest value in its row (or column) of the distance matrix, and represents how far away from the molecular center it resides.

The diameter (D) is the maximum such value for all atoms, and is held by the most outlying atom(s). Examples: Diameter of methane = 0; ethane = 1; propane = 2; n-butane = 3.

The radius R is the minimum such value, and is held by the most central atom(s). Examples: Radius of methane = 0; ethane = 1; propane = 1; n-butane = 2.

Shape attribute

The shape attribute (κ) measures the branching of a molecule, and is scaled so as to fall between the minimum and maximum values possible for the given order. The first-order shape attribute counts the number of one-bond paths. The second-order attribute counts the number of two-bond paths, and so on. The first three orders (1..3) are available.

Shape coefficient

The shape coefficient, I is given by:

$$I = (D - R) / R$$

Where the diameter (D) is the maximum such value for all atoms, and is held by the most outlying atom(s). The radius (R) is the minimum such value, and is held by the most central atom(s).

Examples values for D: methane = 0; ethane = 1; propane = 2; n-butane = 3.

Example values for R: Radius: methane = 0; ethane = 1; propane = 1; n-butane = 2.

Sum Of degrees

Is the sum of degrees of every atom. An atom's degree is the number of nonhydrogen atoms to which it is bonded.

Sum of valence degrees

Is the sum of degrees of every atom. An atom's valence degree is equal to the sum of its adjacent bonds' orders, including hydrogens.

Topological diameter

Is the longest dimension of a molecule.

Total connectivity

Is the connectivity considered over all the heteroatoms.

Total Valence Connectivity

Is the valence connectivity considered over all the heteroatoms.

Vapor pressure

Is the pressure exerted by a vapor in equilibrium with its solid or liquid phase. Vapor pressure measures the concentration of solvent molecules in the gas phase.

Vapor pressure can be calculated using Raoult's law. The formula to calculate vapor pressure is:

$$P_{tot} = \sum_i p_i X_i$$

Where 'p' is vapor pressure, 'i' is a component index, and 'χ' is a mole fraction.

Water solubility

Is the maximum amount of a substance that can be dissolved in water at equilibrium at a given temperature and pressure. Water solubility is measured in mg/L.

Wiener index

Provides measure of branching defined as:

$$W = \frac{1}{2} \sum D_{ij}$$

Where D_{ij} are the off-diagonal elements of the distance matrix.

General Preferences

From the General Preferences dialog, you can customize ChemDraw for Excel for your specific work needs.

To customize ChemDraw for Excel:

1. Navigate to **ChemOffice > Options > Preference**. The General Preferences dialog appears.

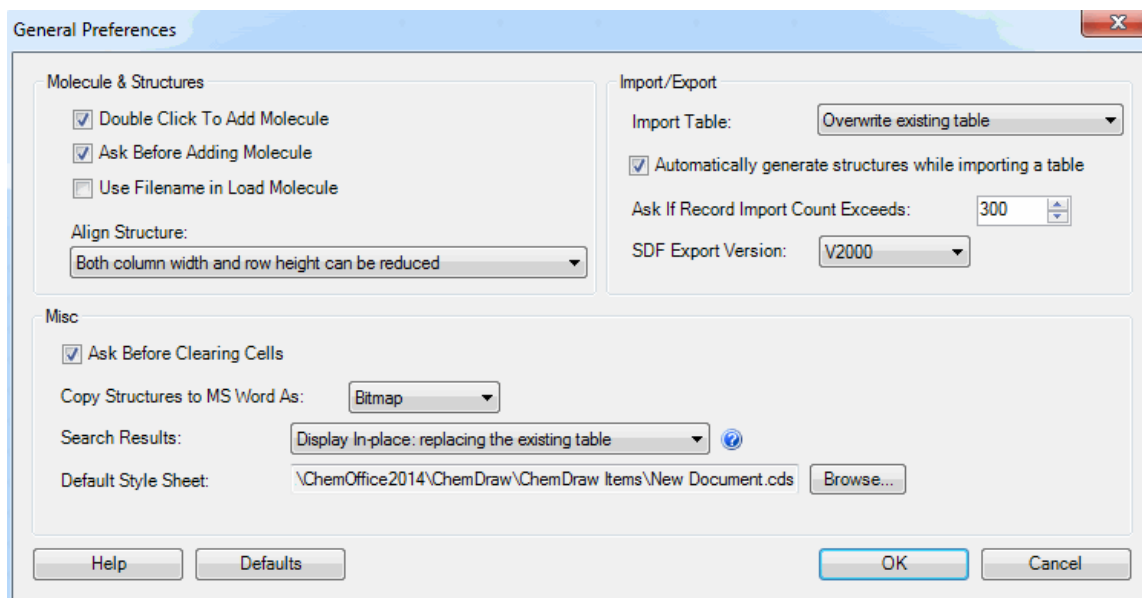

2. Customize the options found in the General Preferences dialog based on your work needs. The options display under three categories: Molecules & Structures, Import/Export, and Misc:

Molecules & Structures:

- **Double Click To Add Molecule:** Launches ChemDraw when you double-click a cell.
- **Ask Before Adding Molecule:** Prompts a message when you double-click a cell to add a molecule.
- **Use Filename in Load Molecule:** Displays file name instead of chemical formula below the molecule after loading the molecule.
- **Align Structure:** Specifies how the structure is aligned in a cell. You can choose to reduce the column width, row height, or both.

Import/Export:

- **Import Table:** Specifies whether to overwrite the table or to append records to the existing table.
- **Automatically generate structures while importing a table:** Generates structure pictures for each record while importing a table using the Import Table command. Disabling this option can speed up the import process. Only structure and table data are imported and no pictures are generated. Select the structure cells and use Show Picture to display the pictures.
- **Ask If Record Import Count Exceeds:** Prompts a message when the table being imported contains more records than the count number specified.
- **SDF Export Version:** Specifies the Structure Data File (SDF) version exported by ChemDraw for Excel. SDF Files can either be V2000 or V3000. The default value is V2000, which limits the number of atoms and bonds in a molecule: V2000 files allow up to 1000 of each. V3000 is a superset of V2000, and offers an enhanced stereochemistry specification. Unlike V2000, the V3000 format does not limit the number of atoms and bonds in a molecule.

Misc:

- **Ask Before Clearing Cells:** Prompts a message when you attempt to delete the cell content in a ChemOffice worksheet by either pressing <Delete> or <Backspace> keys.
- **Copy Structure to MS Word As:** Lets you select the format that you want to use to copy your structure to an MS Word document, for example, Bitmap or OLE Object.
- **Search Results:** By default, the search result appears in the same worksheet on which the search is performed. The Display in a new worksheet option creates a new worksheet with the name "SearchResults X" (where X is 1,2,3...) and displays the search results in this new worksheet, without changing anything in the original worksheet.
- **Default Style Sheet:** Specifies the style sheet always applied to the structures when structures are added using Import Table, Load Molecule, or by Add Molecule commands. To apply a style to particular molecules, navigate to **ChemOffice > Molecule > Style**. The default style sheet is New Document.cds.

CombiChem

Using CombiChem, you can build virtual combinatorial libraries of structurally related molecules. You can then screen your libraries for various properties to determine which compounds you want to synthesize.

CombiChem is a plugin for Microsoft Excel and is included with ChemDraw/Excel. If you are familiar with MS Excel, you will find CombiChem simple to use. However, if you need assistance, see the Help documentation for MS Excel.

Getting Started

When you install ChemFinder or ChemOffice, the CombiChem add-in is also installed. CombiChem requires Microsoft Excel 2010 or later.

Assistance with CombiChem

CombiChem provides Help in the Excel worksheets. Go to **ChemOffice16>CombiChem>Help**.

By default, each worksheet you create also includes brief instructions to help guide you. If you do not see the instructions:

1. Go to **ChemOffice16>CombiChem>Preferences**.
2. Select **Add Instructions to Every Sheet**.
3. Click **OK**.

The instructions appear on new worksheets that you create.

Creating combinatorial libraries

To create a combinatorial library, you first need a generic reaction. This reaction resembles the real reaction you will use in the lab to synthesize compounds. The generic reaction contains one or more query structures that represent the reactants and products in the real reaction. An example of a generic reaction is shown below:

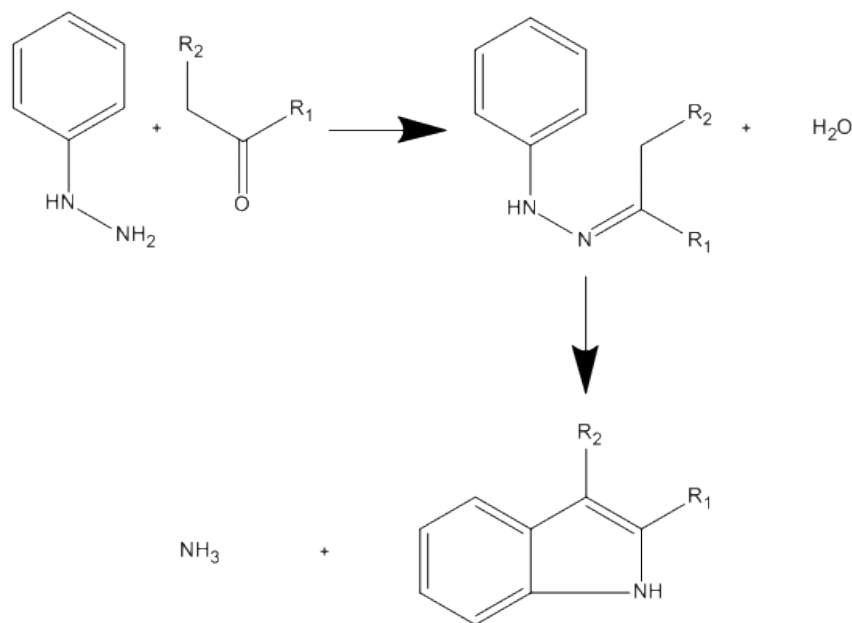

You use the generic reaction to search your chemical database for compounds that match the reactant query structures. Once all the matching compounds are found, CombiChem generates a list of reactions from the compounds that were found in the query.

The generic reaction you create must meet these criteria:

- All generic atoms in the reactant(s) must be represented by R-groups.
- Solvents, catalysts, and other “real-world” elements must *not* be included in the generic reaction.
- Multi-step generic reactions are supported.

Entering a generic reaction

To enter the generic reaction, you must first create a reaction worksheet:

- Go to **ChemOffice16>CombiChem>New Reaction**. A new worksheet, named “Reactions” appears in your workbook.

You then add the generic reaction to the reaction worksheet by either importing it or drawing it in ChemDraw.

To import the reaction:

1. Place your cursor in the cell that contains the text “Reaction - Double-click to edit.”
2. Either click the **Load Molecule** icon on the ChemOffice toolbar or go to **ChemOffice16>Molecule>Load**.
3. Browse to the file that contains the generic reaction and click **Open**. The reaction appears in the Reactions worksheet.

To draw the reaction in ChemDraw:

1. Double-click the cell that contains the text “Reaction - Double-click to edit.”.
2. When asked whether to add a new molecule, click **Yes**. ChemDraw launches.

3. In ChemDraw, draw the generic reaction.
4. In ChemDraw, go to **File>Exit**. You will be returned to Excel and the reaction will appear in the worksheet.

 **Tip:** To display or hide the reaction, click the Show Picture or Hide Picture icon.

 **Note:** Do not add more than one reaction to a reaction template.

Creating reactant worksheets

The generic reaction contains at least one generic reactant (a reactant that has one or more R-group attachments). After you enter the generic reaction in Excel, you create a worksheet for each generic reactant. CombiChem uses the reactant worksheet(s) to search your database for structures that may be used in synthesis. In multi-step reactions, CombiChem searches for reactants in the first step; but ignores intermediate reactants.

To create reactant worksheets:

1. Select the Reactions worksheet tab.
2. Go to **ChemOffice16>CombiChem>Reactants>Make Reactant Worksheets**. A new worksheet is added for each generic reactant.

CombiChem creates a worksheet for each generic reactant (typically, either one or two reactant worksheets for the reaction you entered).

Searching for reactants

Reactant worksheets are empty when CombiChem creates them. To populate each worksheet with structures from your database, you must either import the database as an SD file or use ChemFinder to search for records.

To search for reactants in an SD file:

1. Select a Reactant worksheet tab.
2. Go to **ChemOffice16>CombiChem>Reactants>Search for Reactants**. A dialog box appears.
3. Select **Search Directly** to import an SD file to search.

 **Note:** SDfiles have the extension *.sdf*.

4. Enter the file path in the **Database** field or click **Browse** to locate the file.
5. Click **OK**. Records in the file that match the generic reaction are returned.

To search for reactants using ChemFinder:

1. Go to **ChemOffice16>CombiChem>Reactants>Search for Reactants**.
2. In the dialog box, select **Search in ChemFinder**.
3. In the **Database** field, enter the path to the ChemFinder form to be used to search the ChemFinder database.

 **Note:** ChemFinder form files have the extension *.cfx* or *.cfw*.

4. Click **OK**. ChemFinder launches.

After launching, ChemFinder uses the form you entered to search its corresponding database for records that match the generic reactant. You can browse the search results in ChemFinder before importing them into the Excel reactant worksheet.

 **Tip:** To omit a record from the search results, navigate to the record in ChemFinder and go to **Record>Omit from List** in the ChemFinder main menu.

5. In Excel, go to **ChemOffice16>CombiChem>Reactants>Import ChemFinder Hitlist**.

Alternatively, you can copy and paste the query structure into ChemFinder to perform a search.

1. In Excel, select the cell that contains the generic reactant.
2. Click the Copy Molecule icon on the ChemOffice toolbar.
3. In ChemFinder, open the database to search.
4. Paste the generic reactant structure into a query form and run the search.
5. In the reactant worksheet in Excel, go to **ChemOffice16>CombiChem>Reactants>Import ChemFinder Hitlist** to import the search results. The search results appear in the reactant worksheet(s).

 **Tip:** Use the Show Picture/Hide Picture commands to toggle the display.

Recreating reactant worksheets

You can edit the generic reaction at any time. However, you must then delete and recreate each reactant worksheet.

To recreate a reactant worksheet:

1. Right-click the reactant worksheet tab and select **Delete**.
2. When prompted, confirm that you want to delete the worksheet.
3. Go to **ChemOffice16>CombiChem>Reactants>Make Reactant Worksheets**.
4. Go to **ChemOffice16>CombiChem>Reactants>Search for Reactants**. (For more information, see "[Searching for reactants](#)" on page 224.)

If you try to create new reactant worksheets in a workbook that already contains reactant worksheets, you will be asked whether you want to delete the existing worksheets. When prompted, choose one of these options:

- Click **Yes** to replace the existing worksheet(s). The existing worksheet is permanently deleted.
- Click **No**. No new worksheet is created and the current worksheet(s) are kept.

To preserve the existing worksheets go to **File>Save As** and save the workbook. Then, follow the steps above to recreate the reactant worksheet(s). When prompted to delete each existing worksheet, click **Yes**. New reactant worksheets will be created and the previous workbook will be available as a saved file.

Creating an experiment

An experiment is a library of product structures that is created when the reactant search results are applied to the generic reaction. You can create or enumerate multiple experiments per workbook.

For example, you can take all the reactants you imported and enumerate an experiment containing all possible combinations of reactants. After calculating properties on these products, you might decide that 10% of these products are worth synthesizing in the lab. You could then create an experiment with just those products that the calculations show to be promising.

The 'Use (Y/N)' column in a reactant list determines whether the associated reactant in the list will be used ('Y') in the experiment or not ('N'). By default, Y, appears.

 **Note:** Only the Structure and Use (Y/N) columns are necessary. Other columns may also be included but CombiChem ignores them. You can delete them if you want.

To create a new experiment:

1. In each reactant list, select the reactants to use by typing **Y** in their "Use(Y/N)" column. Type **N** for those reactants you do not wish to use.

 **Note:** Cells without "n" or "N" default to "Y".

2. Go to **ChemOffice16>CombiChem>Experiments> New** or use the floating experiments form (**Combi Options>Experiment>New**). A dialog box appears asking whether you want to create the experiment with the selected number of reactants.

 **Note:** Enumeration of a product library may take a long time, especially if there are many reactants or you are using a slower processor.

CombiChem/Excel saves your enumeration to a ChemFinder database file.

3. When prompted, save the experiments file.

 **Note:** When the enumeration is done, CombiChem/Excel imports your data to a worksheet.

Experiment worksheets

After you create the experiment, several sheets are added to your workbook:

Experiment Reactant sheets. Contain lists of the reactants used in the experiment. There is one Experiment Reactant sheet for each reactant. These sheets are named `Experiment n -Reactant m` where n is the designates a specific experiment (in case you create more than one) and m is the reactant for the experiment.

Experiment Product sheet. Contains the generic reaction and the enumerated products in the experiment based on the reactants you marked 'Y' in the reactant worksheet(s). By default, only the products are listed. To list the complete enumerated reactions:

1. Go to **ChemOffice16>CombiChem>Preferences**.
2. In the Combi Preferences dialog box, select **Show Full Reaction for each product**.
3. Select a reactant worksheet.
4. Go to **ChemOffice16>CombiChem>Experiments>New**. A new experiment is added with the full reactions appearing in the product worksheet.

 **Note:** Whenever you create a new experiment, existing experiment worksheets are retained. If you want to delete them, right-click each experiment tab and select **Delete** or use the experiments floating form (**Combi Options>Experiment>Delete**).

Go to **Combi Options>Experiment>Toggle** to hide/unhide all the experiment worksheets in the workbook.

Configuring plates

After you create an experiment, you can assign your products to product wells and your experiment reactants to reactant block plates. This is useful if you are going to use a robotic synthesizer. You can configure plates of up to 50 rows and 50 columns.

To set up assignments:

1. Open either an Experiment Reactant or Experiment Product worksheet.
2. Go to **ChemOffice16>CombiChem>Plates>Configure Plates**.
The Configure Plates dialog box appears.
3. In the **Configuration of:** drop-down list, select either **Product Plates** or **Reactant Block Plates**.
4. Enter the number of rows and columns to assign to the plate.
The numbered buttons represent wells in the plate you chose.

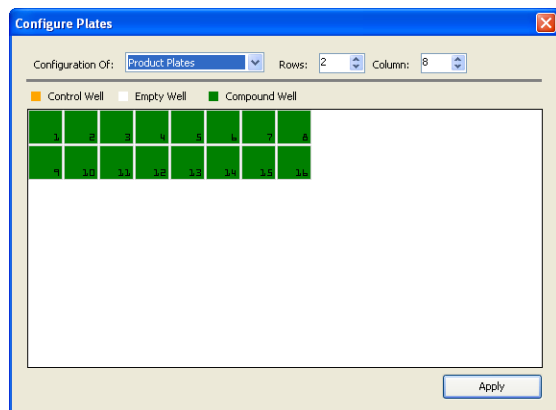

5. Designate which wells you want to use as controls, synthesized compounds, and left empty. Click a well to change its designation.
6. When you are finished, click **Apply**.

Assigning plates

The next step is to assign plates to each reactant and product.

To assign the reactants or products to plates:

1. Select an Experiment-Reactant worksheet.
2. Go to **ChemOffice16>CombiChem>Plates>Assign to Wells**.
3. Select a product worksheet.

4. Go to **ChemOffice16>CombiChem>Plates>Assign to Wells**.

Three columns are added to the reactant or product worksheet: Well Plate, Well Row, and Well Column.

Well Plate	Well Row	Well Column
1	1	1
1	1	2
1	1	3
1	1	4

To change specific plate assignments, edit the values on the worksheet.

To remove all plate well assignments:

1. Select the worksheet where you want to remove assignments.
2. Go to **ChemOffice16>CombiChem>Plates> Remove well assignments**.

Browsing plates

After assigning reactants or products to wells, you can view which one has been assigned to each well.

1. Select either a reactant or product worksheet.
2. Go to **ChemOffice16>CombiChem> Plates>Browse Plates**. The Plate Browser dialog box appears.
3. In the **Plate** scroll list, select or enter the plate number to view.
4. In the dialog box, select the well to view. The worksheet scrolls to the reactant or product assigned to the well you select.

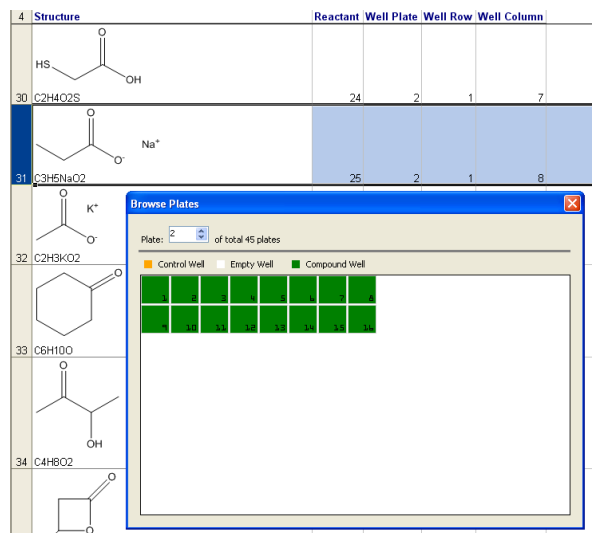

The screenshot shows a worksheet with columns for Structure, Reactant, Well Plate, Well Row, and Well Column. The following table represents the data visible in the worksheet:

Structure	Reactant	Well Plate	Well Row	Well Column
<chem>HS-CH2-COOH</chem>				
<chem>C2H4O2S</chem>		24	2	1
<chem>C3H5NaO2</chem>		25	2	1
<chem>C2H3KO2</chem>				
<chem>C6H10O</chem>				
<chem>C4H8O2</chem>				

The 'Browse Plates' dialog box is open, showing 'Plate: 2 of total 45 plates'. It includes a legend for Control Well (orange), Empty Well (white), and Compound Well (green). A 4x4 grid of wells is displayed, with the top-left well (A1) highlighted in green, indicating it contains a compound.

Viewing related structures

After enumerating an experiment, you may view which reactants went into a product or which products arose from a given reactant.

To view the related structures:

1. Select a row on an Experiment Reactant or Experiment Product sheet.
2. Go to **ChemOffice16>CombiChem>Highlight Related Records**.

The related records on the Experiment Reactant and Experiment Product sheet are displayed in color.

3. (Optional) To remove the highlighting from all rows, go to **ChemOffice16>CombiChem>Highlight>Unhighlight All**.

Setting preferences

CombiChem provides several options for you to choose how and whether certain information appears on each worksheet. Go to **ChemOffice16>CombiChem>Preferences** and select from these options:

Add Instructions to Every Sheet. By default, row 1 of each CombiChem worksheet contains instructions.

Select/deselect this option to display or remove them from each new sheet you create.

Show Full Reaction for each product. By default, the reaction arrow and products appear on each Experiment worksheet. Select this option to display the full reaction on each new Experiment sheet.

Discard duplicate reactions in experiment. Select this option to discard all duplicate reactions in an experiment and save only unique ones.

Assign Compounds From. Assign rows and columns in plates. Choose **Left to Right** to assign well numbers by row (1-1, 1-2, 1-3, etc.). Choose **Top to Bottom** to assign well numbers by column (1-1, 2-1, 3-1, etc.).

Plate Column Label. Assign numeric or alphabetic labels to plate columns.

Plate Row Label. Assign numeric or alphabetic labels to plate rows.

ChemScript is the cheminformatics Software Development Kit (SDK). It contains the programming algorithms that are common throughout PerkinElmer products. As a software developer, you can apply ChemScript to create your own scripts to use with ChemOffice applications.

All example script files in the ChemScript library are available in Python and C#.NET. If you are familiar with either of these languages, you will find these scripts easy to understand. However, if you are new to either Python or C#.NET, we suggest that you refer to the Web sites and books listed at the end of this chapter.

Although ChemScript is available in Python and C#.NET, we will use Python in this guide to explain ChemScript. Python is a non-proprietary and widely used programming language.

Why use ChemScript?

ChemScript adds considerable versatility to how you manage your chemical data. Using ChemScript, you can modify, view, and transfer your data from one place to another using your own custom rules.¹

Here are just a few common uses:

Salt splitting and stripping

Identify and remove salt fragments from a drawn structure and register the pure compound.

Canonical codes

Generate canonical codes for a set of structures and use the codes to find duplicates in your data.

File format conversion

Convert structure or reaction files from one format to another.

Generate properties

Execute Struct=Name or generate physical property features found in ChemDraw.

Common scaffold orientation

Enforce standard orientations of structures based on the established orientation of a common substructure.

2D Structure Diagram Generation (SDG) and Cleanup

Generate new 2D structures from connection tables without coordinates and clean up existing 2D structure using the ChemDraw algorithms.

How ChemScript works

The most fundamental use for ChemScript is to read data from one source, modify the data using a script, and write the modified data to another location. You can retrieve data from or write to almost any database, file(s), or

¹ChemScript lets you convert up to 10,000 data records per day. For greater capacity, you will need ChemScript Ultra. For information, contact PerkinElmer.

application.

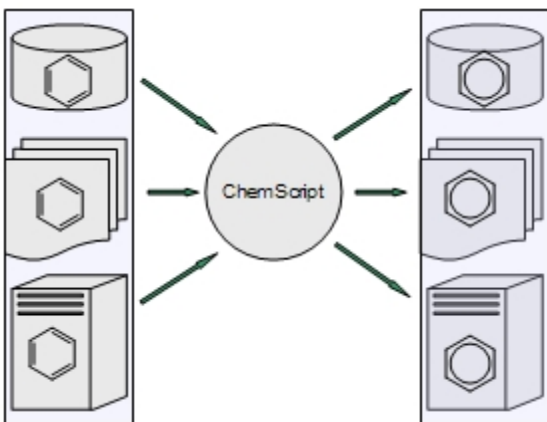

Figure 13.1: A ChemScript script can retrieve data from one source, modify the data, and write it to another location.

How the data is modified is determined entirely by the script. The script can delete data, calculate or add new data, or edit existing data. The data can be either text, structures, or both.

Since ChemScript scripts are like any other Python scripts or .NET program, you can execute the scripts using either the Windows command line or any development environment.

Getting Started

By default, ChemScript and Python 3.2 are installed on your local computer when you install ChemOffice. After the installation, we suggest that you follow the simple exercises in this section to familiarize yourself with ChemScript. For editing ChemScript files, we recommend that you use one of the many programming tools that are available. One of these tools, IDLE, is included with the Python installation. To learn more about IDLE, see the online Help in the IDLE main menu.

Starting IDLE

From the Start menu, go to **All Programs>Python 3.2>IDLE (Python GUI)**. After Python starts, a Python shell opens in IDLE and the header indicates a version of Python (Ex. 3.2), and a version of IDLE (Ex. 1.2). A prompt will also appear: ">>>"

Loading the ChemScript Library

At the command prompt, type the line below and press <Enter>:

```
import ChemScript16
```

 **Note:** The command is case-sensitive.

A "Welcome to CS ChemScript" message appears, followed by a command prompt.

ChemScript Help

You can read a description of any ChemScript class within IDLE. For example, enter the line below to return Help for the ChemScript `Atom` class.

```
help (Atom)
```

The help will begin with a message such as:

```
"Help on class Atom in module ChemScript16:"
```

Enter SMILES Data

You can also test to verify that ChemScript is working correctly. One common use for ChemScript is to apply functions to SMILES strings. For example, you can assign a SMILES string to a variable. Type the following line and press <Enter>:

```
myMol = Mol.LoadData('C1CCCC1C')
```

This message appears:

```
Open molecule successfully: chemical/x-smiles
```

Reporting a Chemical Name

You can now use the variable to report the chemical name. For example, at the command prompt type the line below and press <Enter>:

```
myMol.chemicalName()
```

The line `methylcyclohexane` is returned.

Counting Atoms

To count the atoms in the string, type the following line and press <Enter>:

```
myMol.CountAtoms()
```

The command returns the atom count for the structure defined with the chemical/x-smiles format for 'C1CCCC1C', which is 7.

Exiting IDLE

To exit, type this line and press <Enter>:

```
exit()
```

Confirm any prompts to complete the exit command. Python IDLE exits.

Getting Started Guide

ChemScript includes a Getting Started guide to help you begin developing and using your own scripts. To open the guide, go to **Start>All Programs>ChemOffice2016 >ChemScript 16.0>Getting Started**.

The document includes notes on the ChemScript objects and functionality, Python, and an overview of examples installed.

Editing Scripts

Using IDLE or another development environment, you can either edit the scripts provided with ChemOffice or create your own. Regardless of how you develop a script, it must include these commands:

```
from sys import *
from os import *
from os.path import *
from ChemScript16 import *
```

The first command imports the python system. The second and third commands import the operating system modules. The last command imports all the ChemScript functions. After you include these command lines, how you develop the rest of your script is entirely up to you.

Introducing the ChemScript API

ChemScript includes a ChemScript API reference guide. You can find the guide at **Start>All Programs>ChemOffice 2016>ChemScript 16.0>API Reference**. It provides links and information for the ChemScript classes. The ChemScript object model comprises two fundamental levels of functionality, described below.

ChemScript Classes

At the top level, the API consists of four classes:

Atom

Chemical element, charge, bonds to neighboring atoms, drawing coordinates, 3D coordinates (if available), stereochemistry, etc.

Bond

Bonded atoms, bond order, etc.

Molecule (Mol)

A chemical connection table, which can represent one or more molecular fragments. This class also includes file I/O capabilities and other advanced chemistry functionality such as stereochemistry.

Reaction (Rxn)

A chemical reaction with one or more steps.

Functions and Algorithms

The secondary level consists of the core set of high-level features that you can modify to meet your specific business needs. Some examples are described below.

Template Based Normalization

Enforce standard representations of functional group structures in chemical data.

Template Based Product Generation

Automatic generation of products from a set of reactants and a generically defined reaction. For example, reactions like those between amines and carboxylates.

Substructure Identification and Mapping

Atom-by-atom comparison of a molecule with a substructure. Positive matching provides an atom-by-atom map of the substructure atoms to those in the molecule.

Salt Stripping

Remove salts from a reaction based on a pre-defined list of salt fragments.

Structure Orientation

Enforce standard orientation of structures based on the established orientation of a common scaffold.

2D Structure Generation and Cleanup

Use ChemDraw-based algorithms to generate structure from scratch or after modifying chemical data using a program.

Canonical Codes

Generate unique identifying codes from a chemical structure.

File Format Conversion

Read and write file data using all PerkinElmer supported file formats (CDX, CDXML, MOL, CHM, SKC, SMILES, etc.).

Chemical Name and Structure Conversion¹

Use the ChemStruct=Name feature to generate structures from chemical names and names from their structures.

Molecular Mechanics

Optimize molecular structures using the MM2 force-field.

The ChemScript API online

PerkinElmer also provides the documentation of the API online. You can find the API at sdk.cambridgesoft.com.

Tutorials

We provide several sample scripts to illustrate how you can develop your own custom code to meet your business needs. Many of the scripts we use are in the ChemScript samples directory. By default, this directory is where ChemOffice 2016 auxiliary files are installed:

On Windows 7 and 8:

C:\ProgramData\PerkinElmerInformatics\ChemOffice2016\ChemScript\Examples\

For the sake of brevity, we won't repeat the scripts in this manual or try to teach Python. However, we briefly describe what you can do with the code examples so that you can modify and expand upon them for your own use. As you read the tutorials, you are encouraged to view the code in IDLE and edit it as desired to see how each example works. For more on IDLE, see ["Getting Started" on page 231](#).

Example 1: Automated Structure Clean up

This sample script cleans up the structures in multiple ChemDraw files all at the same time. It uses the same cleanup function that is in ChemDraw. The script is in the directory `Example.001/script.py`. The script reads the CDX

¹Premium functionality that may be licensed from PerkinElmer.

structure files from a source directory, applies the cleanup feature to each structure, and write the modified files to an output directory. The original files remain unchanged.

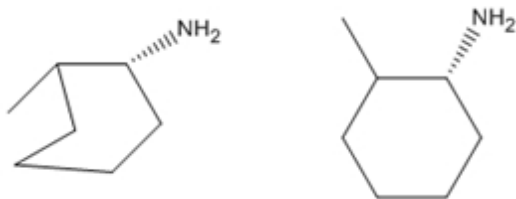

Figure 13.1: The structure cleanup script reads a structure file (left) and creates a new, cleaned up structure file (right).

This example uses the CDXML format. Other formats, such as MDL MOL, may also be applied. You can also force ChemScript to use specific file formats for reading and writing data.

Example 2: Create an SD file

This example illustrates how you can create an SD file from existing CDXML files. You can find the script at `Example.002/script.py`. We begin with a list of CDXML files that each contain a chemical structure. The list of files is hard-coded into the ChemScript script. When executed, the script uses the `SDFFileWriter` method to create an SD file that includes all the structures.

Example 3: Create a list of CDXML files

This example illustrates how to read an SD file and write a list of CDXML files. You can find the source file at `Example.003/script.py`.

Example 4: Filter an SD file

This example uses the `atomByAtomSearch` method to demonstrate a simple application of the "atom-by-atom" substructure search in ChemScript. The program reads an SD file and filters structures into one of two output SD files, structures that contain a phenyl group and structures that don't. It also illustrates how you can read chemical data formatted as a SMILES string. See `Example.004/script.py`.

Example 5: Computing Canonical Codes

This example script checks whether any structures appear in both of two SD files based on the structures' canonical codes. The output is a new SD file with the duplicate structures excluded. See `Example.005/script.py`.

This example first computes the canonical code for each structure. Since the canonical code does not vary with different representations of the same chemical structure, you can use it to determine whether two structures are chemically equivalent.

This example also introduces the Python Dictionary, which is an associative array. The dictionary maps a key to a value. The dictionary is used to determine whether a canonical code has been previously encountered.

This example uses an alternate looping construct to read an SD file.

Canonical codes should never be permanently stored because their representation can change among different versions of ChemScript.

Example 6: Structure Overlay

This script introduces the ChemScript structure overlay feature. It uses a scaffold structure file to superimpose two chemically similar structures. The script first examines the structures in an SD file that contain a common scaffold substructure. It then aligns these structures so that they have the same orientation with respect to the scaffold. See `Example.006/script.py`.

 **Note:** The overlay functionality can also be used to align three dimensional structures.

Example 7: Reaction Transformation

This example demonstrates reaction transformation. This means that you can draw a reaction that defines a transformation of a molecule and then apply that transformation to a set of structure files.

All the files necessary for this tutorial are in the `Example.007` directory. The `transform1.cdxml` file provides the reaction that defines the transformation. The `input.sdf` file contains all the structures that will be transformed.



Figure 13.2: The transform file defines how the transformation is applied to the source structures.

The script searches the input file for structures that contain a nitro group, shown as a reactant in the transformation file. If a structure is found, the script transforms the nitro group to the form shown in the product and copies the entire structure to a new file. The figure below shows one example.

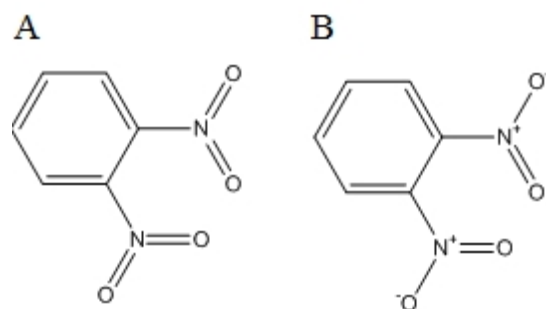



Figure 13.3: A) before the transformation is applied; B) after transformation.

Structures that don't meet the search criteria are ignored.

Example 8: Simple salt stripping

The program reads an SD File, identifies and removes salt components (if any are present), and outputs two SD files. The output structure file contains the original structures without the salt component, and the output salt file contains the salt components that were stripped, along with a reference to the original structure. See `Example.008/script.py`.

 **Note:** This example uses a default set of salts that PerkinElmer provides. However, you can also define a customized salt table that enables you to designate which chemicals are considered salts.

Useful References

There are numerous resources available for learning Python and C#.NET. Just a few of the many books and Web sites are listed below.

Books

Python

- *Beginning Python: From Novice to Professional* by Magnus Lie Hetland.
- *Dive into Python* by Mark Pilgrim.
- *Learning Python* by Mark Lutz & David Ascher. This is a beginner/intermediate learning manual and reference.
- *Python in a Nutshell* by Alex Martelli. This book is a brief introduction and good reference to Python.

C#.NET

- *C# in a Nutshell* by Peter Drayton, Ben Albahari, and Ted Neward.
- *Pro C# with .NET 3.0* by Andrew Troelsen.
- *C# Essentials* by Ben Albahari, Peter Drayton, and Brad Merrill.
- *C# 3.0 Cookbook* by Jay Hilyard and Stephen Teilhet.

Web Sites

Python

You can find more information on Python at: <http://www.python.org>. This is the official Python programming language site.

.NET

For information on .NET, see <http://msdn.microsoft.com>

Query Structures

A query is a search for information that is stored in a database. If you have ever searched the Internet using a Web browser, then you have performed a simple query.

A query structure is a parameter you use to search a chemical database (the database must include structures for the query to be useful). The query structure can include bond and atom properties that you specify to narrow or broaden the list of search results. Below are two query structure examples:

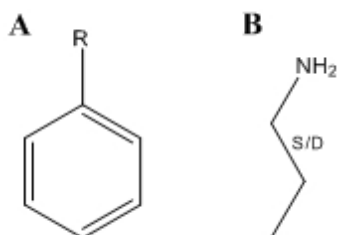

Figure 14.1: Two example structure queries. A) The results include any connected atom at the location specified by 'R'; B) The results include either a single or double bond at the location specified by 'S/D'.

To perform a query, you first draw the query structure in ChemDraw. You then enter the structure in a database application such as ChemFinder. The application searches one or more databases that you specify and returns the query results.

Search Limitations

Several factors determine the search results that are returned. To get the results you expect, you must first ensure that the structure you draw accurately represents the query you want to perform. For example, if your query structure requires that no carbon atoms in an aromatic structure can be part of any ring, you are likely to return no results or an error, depending on the query system used.

The search application you use can also affect your query. If the application does not accurately interpret your query structure, or the structures in the database, you could receive inaccurate results.

Generic Labels

A generic label represents a nonspecific attachment. It can be either an unspecified atom, functional group, or structural feature. When you perform a query, the query looks for structures based on the type of generic label you use and where it is in the query structure. Records that match the query structure are returned in the search results.

For example, the query structure below uses the letter 'Q' to indicate that a nonhydrogen, noncarbon atom must appear at the specified location.

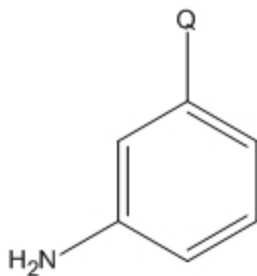

You can use other generic labels to indicate other types of query criteria. The generic labels that ChemOffice supports are listed below (all are recognized as chemically significant).

- **A:** Represents any non hydrogen.
- **M:** Represents a metal.
- **Q:** Represents an atom that is neither hydrogen nor carbon.
- **X:** Represents any halide.
- **R:** Unrestricted; represents one or more connected atoms of any kind.

To add a generic label to a structure, do one of the following:

- Double-click the atom to open a text box, and type in the nickname.
- Right-click the atom, point to **Insert Generic Label** on the context menu, and click the label you wish to insert on the sub-menu.

Generic Nickname Hotkeys

You can assign hotkeys to generic nicknames, just like other nicknames. For information on assigning a hotkey to a nickname, see ["Customizing Hotkeys" on page 36](#).

Defining Generic Nicknames

The generic nicknames recognized as chemically meaningful are listed in the Generic Nicknames file in the ChemDraw Items folder.

To edit the generic nickname files, open the Generic Nicknames file in a text editor and make your changes. Follow examples in the file for the correct format.

 **Note:** *If you check a structure that has a generic nickname, a message displays because the structure contains variable substituents. If you ignore this message, the generic nicknames are ignored, and the chemical formula, mass, etc., are reported as if the atom label containing the generic nickname were not selected.*

Reaxys

Reaxys is a web-based chemical search engine designed for synthetic and medical chemists. The Reaxys database includes chemical properties, structures, reactions and experimental data. Using ChemDraw for Reaxys® with ChemDraw, you can draw query structures to search the Reaxys database.

 **Note:** For the Windows version, you need both the Reaxys Structure Editor plug-in and either the ChemDraw application or plugin installed on your system.

In addition to A, M, Q, X, and R, Reaxys recognizes several other generic atoms.

To add a Reaxys generic label to a structure:

- Right-click an atom, point to **Insert Generic Label** on the context menu, point to **Reaxys** and click the label in the sub-menu you wish to insert.

The table below lists the labels and their meaning.

Labels	Meaning
AH	Any or H
MH	Metal or H
QH	Any, except Carbon or H
XH	Halogen or H
G	Unspecified
GH	Unspecified or H
G*	Unspecified, ring closure allowed
GH*	Unspecified, ring closure allowed or H
ACY	Acyclic
ACH	Acyclic or H
ABC	Carbacyclic
ABH	Carbacyclic or H
AYL	Alkynyl
AYH	Alkynyl or H
ALK	Alkyl
ALH	Alkyl or H
AEL	Alkenyl
AEH	Alkenyl or H
AHC	Hetero acyclic
AHH	Hetero acyclic or H
AOX	Alkoxy
AOH	Alkoxy or H

Labels	Meaning
CYC	Cyclic
CYH	Cyclic or H
CBC	Carbocyclic
CBH	Carbocyclic or H
ARY	Aryl
ARH	Aryl or H
CAL	Cycloalkyl
CAH	Cycloalkyl or H
CEL	Cycloalkenyl
CEH	Cycloalkenyl or H
CHC	Heterocyclic
CHH	Heterocyclic or H
HAR	Hetero aryl
HAH	Hetero aryl or H
CXX	No carbon
CXH	No carbon or H

Atom Properties

Atom properties determine the structural features allowed at the site of an atom. For example, you can specify that a carbon atom must be part of a ring, have at least two attachments, have no attachments, or perhaps be a specific isotope.

Assigning Atom Properties

To assign properties to selected atoms in a structure:

1. Select one or more atoms.
2. To open the Atom Properties dialog, do one of the following:
 - Right-click, select **Atom Properties**.
 - Navigate to **Structure>Atom Properties**.
 - Press the hotkey "I".
3. In the Atom Properties dialog, select the properties to associate with the selected atom(s).
4. Click **OK**.

Query Indicators

Query indicators display the atom properties you assign to a structure, as shown below. If more than one property is assigned, an indicator for each property appears adjacent to the atom.

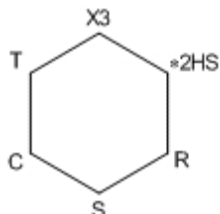

Figure 14.2: This structure illustrates several possible atom properties that can be assigned.

The list below describes each indicator:

- *— Substituents: Free Sites (Followed by the number of free sites)
- U— Substituents: Up to (Followed by the maximum number of substituents)
- X— Substituents: Exactly (Followed by the number of substituents)
- H— Implicit Hydrogens. See ["Implicit Hydrogens "](#) on page 245.
- R— Ring Bond Count
- S— Unsaturation
- C— Reaction Change
- T— Reaction Stereo
- L— Translation
- (none)—Abnormal Valence

Viewing Indicators for an Atom or Bond

Except for the substituents query properties, the characters indicate that a given property is applied, but not the value of that property.

To find the value of a query property setting:

1. Select the atom.
2. Do one of the following:
 - Right-click, point to an atom, and then point to the appropriate property.
 - Navigate to **Structure>Properties** and view the settings on the **Atom Properties** tab.

To display query indicators for an atom or bond:

1. Right-click the atom or bond.
2. Choose **Show Query Indicator** on the context menu.

Displaying Indicators for a Structure

To display query indicators for a structure:

1. Select the structure.
2. Right-click and navigate to **Atom**> or **Bond**>**Show Query Indicator** on the context menu.

Positioning Query Indicators

You can position a query indicator by either dragging it or entering a numeric value for the new location.

1. Right-click the indicator and choose **Position**. The Position Indicator dialog appears.
2. Click the appropriate Position option, and type a value:

To Position	Type a value for
From the atom or bond center to indicator center	Angle, degrees or clock, o'clock
From the atom or bond center to bottom left of indicator baseline	Offset, horizontal, and vertical
At specified coordinates	Absolute, horizontal, and vertical

Hiding a Query Indicators

To hide an indicator:

1. Right-click the indicator.
2. Choose **Hide Indicator** on the context menu.

Removing Atom Properties

To remove all properties from an atom:

1. Select the atom.
2. Navigate to **Structure**>**Atom Properties**.
3. Click **Use Defaults**.

To remove specific properties from an atom, do one of the following:

- Right-click the atom. In the context menu, select **Atom Properties** and choose the properties to remove.
- Navigate to **Structure**>**Atom Properties** and click the atom properties to remove.
- With query indicators shown, click the query indicators using the Eraser tool.

Atom Property Options

The properties you can assign to atoms are described below.

Substituents

A substituent is defined as a non-hydrogen atom connected by a bond of any order. The substituents properties specify the number of substituents that may be bonded to the selected atoms.

For example, in the figure below, the carbonyl carbon (B) has a substituents count of two, the alpha carbon (A) and the aldehyde oxygen. (hydrogen atoms are not counted). The aldehyde oxygen has only one substituent.

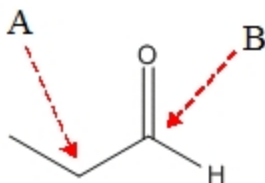

The substituent count atom property lets you specify the number of bonds to an atom in the target structure. This includes bonds already drawn in the query structure.

The substituent options are:

Unspecified. Default. The target base determines the search. Some databases find compounds with any substitution at this atom; other databases (including DARC) find only compounds with substitution exactly as drawn.

Free Sites. Finds compounds in which the selected atoms may contain a range of substituents up to the number specified plus the number of bonds as drawn. A value of zero finds a substituent count as drawn. You can also use the Free Sites symbol in the Query toolbar to apply free sites. In both the free site, or inexact substitution, you define the maximum number of substituents an atom can have. The number you use in the inexact count must include the substitution(s) shown in the query structure, whereas, the free site count does not.

Up to. Finds compounds in which the selected atoms may contain a range of substituents up to the number specified.

Exactly. Finds compounds in which the selected atoms contain the exact number of substituents as specified, up to 15 substituents.

 **Note:** You can specify a substituent count of up to '4' using the '**Substituents**' option from the context menu. To specify a substituent count of up to '15', select '**Atom Properties**' option from the context menu. Clicking with the free site tool selected increments the substituent count upto '9' whereas <Alt>+click decrements the count.

For example:

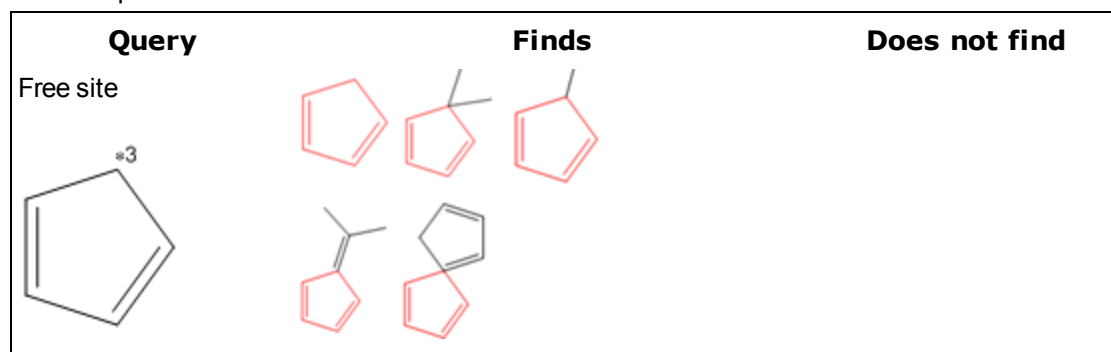

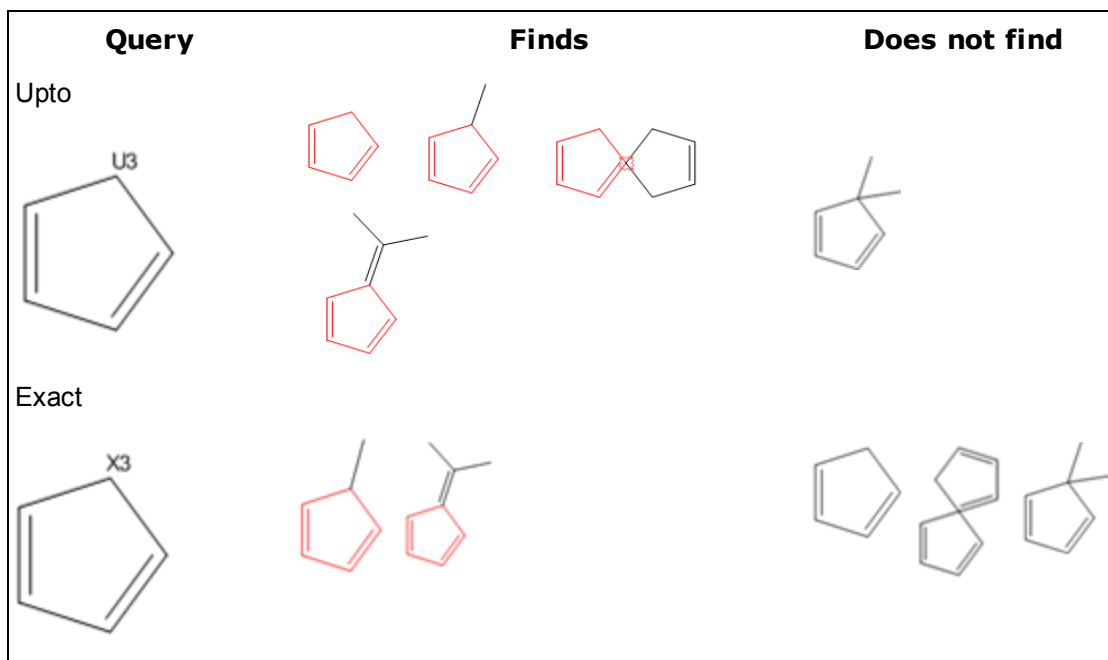

Implicit Hydrogens

An implicit hydrogen is a hydrogen atom in which it, or its bond, is implied, but is not visible. An explicit hydrogen and its bond are visible.

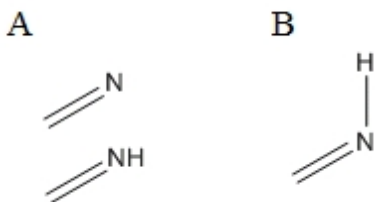

Figure 14.3: A) Examples of implicit hydrogens; B) An explicit hydrogen.

The implicit hydrogens property specifies whether additional, implicit hydrogen atoms may be attached to the selected atoms. If implicit hydrogen atoms are not allowed, all valences to that atom must be filled by bonds to non-hydrogen atoms.

Allowed. Default. Finds compounds regardless of whether hydrogen atoms are attached to the selected atoms.

Not allowed. Finds compounds with no additional hydrogen atoms attached to the selected atoms.

Ring Bond Count

The Ring Bond Count specifies the number of bonds attached to an atom that are part of rings of any size. For simple cases, this also specifies the maximum number of rings in which an atom can reside.

Any. Default. Finds compounds in which the selected atoms can be a member of any type of ring, or a member of no ring at all.

No ring bonds. Finds compounds in which the selected atoms are acyclic.

As drawn. Finds compounds in which the selected atoms reside in the same type and number of rings as drawn.

Simple ring. Finds compounds in which the selected atoms is a member of only one ring (the atom has two ring bonds).

Fusion. Finds compounds in which the selected atoms lies at ring fusions (the atom has three ring bonds).

Spiro or higher. Finds compounds in which the selected atoms is a member of a spiro or higher linkage (the atom has four or more ring bonds).

Unsaturation

The Unsaturation property specifies whether a multiple bond is attached to the selected atoms.

Unspecified. *Default.* Finds compounds regardless of whether a multiple bond is attached to the atom.

Must be absent. Finds compounds that do not have a multiple bond attached to the selected atoms.

Must be present. Finds compounds that have at least one multiple bond (double, triple or aromatic) attached to the selected atoms.

Reaction Change

The Reaction Change property specifies whether a change occurs at selected atoms after a reaction. This property is meaningful only when searching a database that contains chemical reactions. In ChemFinder, only the product atom is checked. The stereo designation is ignored on reactants.

May be anything. *Default.* Finds all reactions regardless of any change to selected atoms after a reaction.

Must be as specified. Finds all reactions that are changed at the selected atoms exactly as specified by the reaction center property in the Atom Properties dialog.

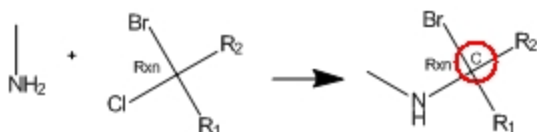

Reaction Stereo

The Reaction Stereo property specifies that the selected atoms are stereocenters in a reaction. This property is meaningful when only searching a database containing chemical reactions.

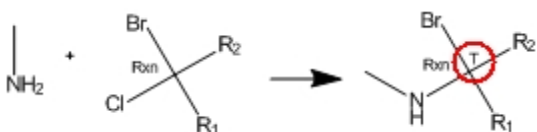

Figure 14.4: The reaction stereo indicator (circled).

Any.Default. Finds all compounds regardless of the stereochemistry at the selected atoms.

Inversion. Finds compounds in which the selected atoms have an inverted stereo configuration after a reaction.

Retention. Finds compounds whose selected atoms have an unchanged stereo configuration after a reaction.

Free Sites

Using free sites, you can specify the maximum number of substituents a result can have. However, it also requires that the bonds in the results appear exactly as they appear in the query structure. ChemDraw uses the following notations for free-sites:

- *0 (Zero free sites)
- *1 (One free sites)
- *2 (Two free sites)
- *3-*15 (Three through fifteen free sites)

For example, assume you want to use the query structure below to search for as many as two substitutions on the vinyl carbon atom while maintaining the bond pattern. Your query structure would look something like this:

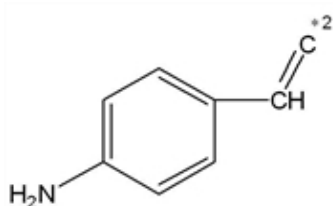

Some of the results can include:

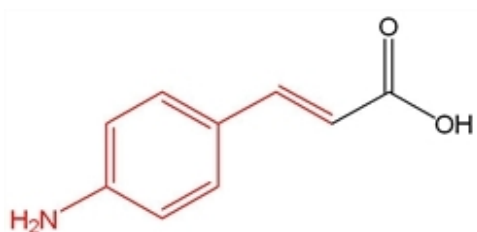

Figure 14.1: (E)-3-(4-aminophenyl)acrylic acid

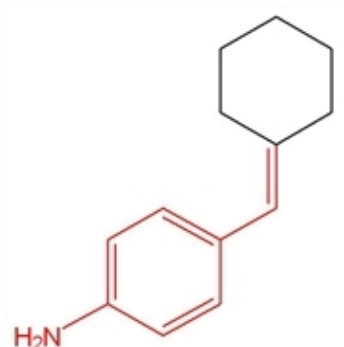

Figure 14.2: 4-(cyclohexylidene)methylaniline

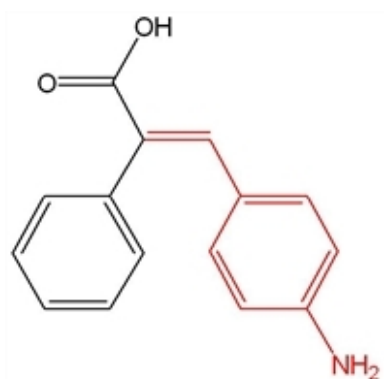

Figure 14.3: (E)-3-(4-aminophenyl)-2-phenylacrylic acid

To increase the number of free sites:

1. To display the query tools, navigate to **View>Other Toolbars>Query Tools** or click the Query Tools icon on the Main Tool palette.
2. Click the Free Site tool on the Query tools palette.
3. Click the atom to which you want to apply free sites.
4. Continue to click the atom to increase the free site number.

To reduce the number of free sites, press <Alt> key while clicking the atom.

You can also change the free sites using the Atom Properties dialog or the shortcut menu. See ["Atom Properties" on page 241](#).

Translation

The Translation property specifies what is required to match in the structure query and possible database hits in a Markush DARC query.

Equal. *Default.* Matches specific to specific or generic to generic terms.

Broad. Translates specific query atoms to corresponding superatoms in the database.

Narrow. Translates query superatoms to corresponding specific atoms or groups in the database.

Any. Translates generic or specific terms to any term.

For more information, see the *Markush DARC User Manual*.

Isotopic Abundance

The Isotopic Abundance property lets you distinguish different isotopic compounds—for example between mono- and hexa-deuterobenzene—by specifying a nuclide at any location.

Unspecified. *Default*

Any. For ChemFinder, the same as default. Included for compatibility with other systems where the default may be different.

Natural. Indicates an isotopically unmodified nuclide.

Enriched. Indicates a mixture of isotopically substituted and isotopically unmodified nuclides.

Deficient. Indicates a depleted label, that is, the nuclide is present in less than the natural ratio.

Nonnatural. Indicates an isotopically substituted nuclide, that is, essentially all the molecules of the compound have only the indicated nuclide.

Abnormal Valence

The Abnormal Valence property specifies whether selected atoms can have a valence other than normal. “Normal” valences for each element are defined in the Isotopes Table file in the ChemDraw Items folder.

 **Note:** *The Abnormal Valence atom property does not provide a visual indicator.*

Not allowed. *Default.* Finds compounds where the selected atoms have only normal valences. If the Check Structure When Copying to Clipboard or Exporting preference is turned on, an error message warns of abnormal valences.

Allowed. Finds compounds with the specific valence drawn.

 **Note:** *If Abnormal Valence is allowed, any Invalid Valence messages for those atoms are ignored by the Check Structure command.*

Bond Properties

An indicator appears next to a bond for each property you assign.

Assigning Bond Properties

To define bond properties:

1. Select one or more bonds in a structure.
2. Do one of the following:
 - Right-click to open a context menu, point to **Bond**, point to the property you want, and choose the desired options.
 - Navigate to **Structure>Bond Properties**. On the **Bond Properties** tab, select the properties from the drop-down list and click **OK**.
 - Point to bond and press the hotkey “/”. The Bond Properties dialog appears.

3. In the Bond Properties dialog, select the properties to associate with the selected atoms. Click **OK**.

For more information, see ["Query Indicators" on page 242](#).

The indicators are:

Indicator	Bond Query Property
Any	"Bond Types" on page 251 : Any
S/D	"Bond Types" on page 251 : Single or Double
D/A	"Bond Types" on page 251 : Double or Aromatic
S/A	"Bond Types" on page 251 : Single or Aromatic
Rng	"Topology" on page 251 : The bond must be part of a ring.
Chn	"Topology" on page 251 : The bond must be part of a chain and not part of a ring.
R/C	"Topology" on page 251 : The bond may be part of a ring or chain.
Rxn	"Reaction Center" on page 251 : The bond must be part of a reaction center.

Viewing Bond Properties

The descriptor for the Reaction Center query property indicates the property is applied, but not the value of the property.

To find the value of a query bond property setting:

1. Select the bond.
2. Do one of the following:
 - Right-click to open a context menu, point to **Bond Properties**, and select to a property.
 - Navigate to **Structure>Bond Properties**.

Removing Bond Properties

To remove all query properties from one or more bonds:

1. Select the bonds.
2. Navigate to **Structure>Bond Properties**.
3. Click **Use Defaults**.

To remove specific bond properties:

1. Select the bond.
2. Do one of the following:
 - Right-click to open a context menu, point to the appropriate property, and click the property to remove.
 - Navigate to **Structure>Bond Properties** and click the bond property to remove.

Bond Property Options

The properties you can assign to bonds are described below.

Bond Types

This property specifies the bond type of the selected bonds.

The *Default* bond type corresponds to the current type of the bond (single, double, and so on.) as drawn.

Single (all) and Dative. Finds compounds with the bond type you select for the selected bonds.

Double or Double Bold. Finds compounds whose selected bonds are double.

Double Either. Finds compounds whose selected bonds are double bonds and have either *cis/trans* stereochemical configuration.

Aromatic. Finds compounds whose selected bonds are aromatic.

Tautomeric. Finds compounds whose selected bonds are tautomeric.

Triple. Finds compounds whose selected bonds are triple.

Quadruple. Finds compounds whose selected bonds are quadruple.

Any. Finds any compound, regardless of the bond type of the selected bonds.

S/D. Finds compounds whose selected bonds are single or double.

D/A. Finds compounds whose selected bonds are double or aromatic.

S/A. Finds compounds whose selected bonds are single or aromatic.

 **Note:** *Not all bond types are supported in all file formats. When an unsupported bond type is saved to a given file format, it is converted to the closest equivalent that is supported.*

Topology

The Topology property specifies the ring environment of the selected bonds.

Unspecified. Default. Finds compounds regardless of topology.

Ring. Finds compounds where the selected bonds are part of a ring.

Chain. Finds compounds where the selected bonds are part of a chain (but not part of a ring).

Ring or Chain. Finds compounds where the selected bonds are part of either a ring or a chain.

Reaction Center

The Reaction Center property specifies how the selected bonds are affected in a reaction. This property is meaningful only when searching a database containing chemical reactions.

Unspecified. Default. Finds compounds regardless of whether the selected bonds are affected by the reaction.

Center. Finds compounds where the selected bonds are affected by a reaction, but the type of change is unspecified.

Make/Break. Finds compounds where the selected bonds are either broken or created in a reaction.

Change. Finds compounds where the bond order of the selected bonds changes in a reaction.

Make & Change. Finds compounds where the selected bonds are formed, broken, or undergo a change in bond order.

Not Center. Finds compounds where the selected bonds are not part of the reaction center.

Not Modified. Finds compounds where the selected bond's orders do not change, but may (or may not) be part of the reaction center.

Unmapped. Finds all compounds.

Element Lists

An element list is a list of atoms allowed at a specified location. For example, the query structure below allows bromobenzene, iodobenzene, or chlorobenzene to be returned. An example of an element list is:

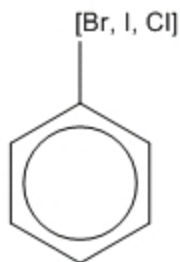

Figure 14.4: An element list as an atom label

The elements in the list must be separated by commas. A space after each comma and brackets are optional.

 **Note:** An element list may contain only atomic symbols, plus D (deuterium) and T (tritium).

To create an element list:

1. Open an atom label text box.
2. Type an open bracket ("[" followed by a list of elements separated by commas ("Cl, Br, I"), followed by a close bracket ("]"), for example: [Cl, Br, I].
3. Close the text box.

The figure below shows a query structure created to find compounds matching the following criteria:

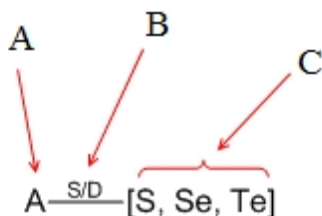

- (A) indicates that the atom must match any atom except hydrogen.
- The Indicator (B) near the bond indicates that the bond must be single or double, S/D.
- The element list (C) specifies that one of these elements must match in the target structures.

Element NOT Lists

The element not-list specifies that the elements in the list are not allowed in the search results. Commas must separate the elements in the element not-list. A space after each comma and brackets are optional.

The word NOT must be in all-caps and must be followed by a space. Alternatively, you can replace the word NOT with a minus sign.

For example:



Figure 14.5: Element NOT lists

 **Note:** An element not-list may contain only atomic elements, plus D (deuterium) and T (tritium).

To create an element NOT list:

1. Open an atom label text box.
2. Type an open bracket "[", the word **NOT**, and a space, for example: **[NOT** , followed by a list of elements separated by commas ("Cl, Br, I"), followed by a close bracket, "]", for example: **[NOT Cl, Br, I]**.

Polymers

You can indicate polymers using either brackets, parentheses, or braces that enclose repeating structures, or structural fragments. The bracket properties lets you specify the context and orientation of the repeating units.

For example:

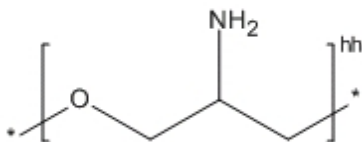

To enclose structures with brackets:

1. To display the Bracket toolbar, navigate to **View>Other Toolbars>Bracket**.
2. On the Bracket toolbar, select one of the double bracket tools.
3. To draw the brackets, click and drag across the structure to enclose.

This gives default value for component order, multiple group repeat count, or single repeating unit label.

Setting Bracket Properties

To set the Bracket Properties:

1. Select a bracket.
2. Navigate to **Structure>Bracket Properties**. The Bracket Properties dialog appears.

The Flip Type option appears only for ladder polymers. See ["Flip Type" on page 258](#).

You can customize the text that appears to the bottom right of the bracket for these bracket types:

- Component (c#)—the component order must be a non-negative integer, and is displayed as the letter “c” followed by an integer (or “c” alone if an order of zero is specified).
- Multiple Group (#)—the repeat count must be a positive integer.
- SRU (n)—the SRU label can be any text.

You can also edit the text for these bracket usage types in the document using the Text tool. You cannot edit the text displayed for other bracket usage types.

Bracket Usage

Polymer Representations are either structure-based or source-based. The type of bracket you use depends on the type of representation.

Structure-based Polymers

Structure-based representations enclose only part of a structure within brackets. One or more bonds cross each of the enclosing brackets. The crossing bonds “match up”, making the polymer structure more explicit.

You represent a structure-based polymer by enclosing a portion of a structure in brackets with a bracket type of SRU (n). IUPAC recommends the subscript “n” to denote structure-based representations of unknown size, but you can edit the text using the text tool.

A structure-based representation of poly(vinyl chloride) is shown below:

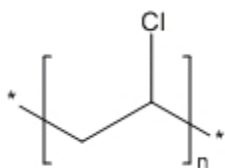

You can also use the bracket usage types “Crosslink (xl)”, “Graft (grf)”, and “Modification (mod)” to represent types of repeating units in a structure-based representation.

Source-based Polymers

Source-based polymer representations enclose a discrete chemical substance in brackets. The mode of polymerization may be obvious from context or be unknown. Source-based representations are useful when describing processes where the starting materials are known, but the exact structure of the reaction product is not.

You can create a source-based representation by enclosing a structure in “Monomer (mon)” brackets. A source-based representation of poly(vinyl chloride) is shown below:

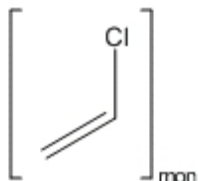

You can use “Mer (mer)” brackets for components of a copolymer where those individual components are known not to repeat themselves or they alternate with other components. For example:

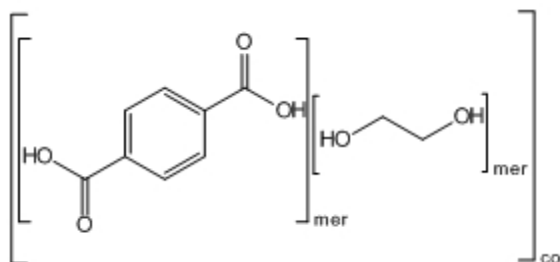

Copolymers represent substances with more than one repeating unit. In general, you can use bracket type “Component (co)”. You can also use “Copolymer, alternating (alt)”, “Copolymer, random (ran)”, and “Copolymer, block (blk)” to represent different copolymer types in a source-based representation.

The bracket type, “Mixture, unordered (mix)” may be used to represent a collection of substances that may all be present, but not necessarily in known amounts. Bracket type “Component (c)” indicates each mixture element, as shown below:

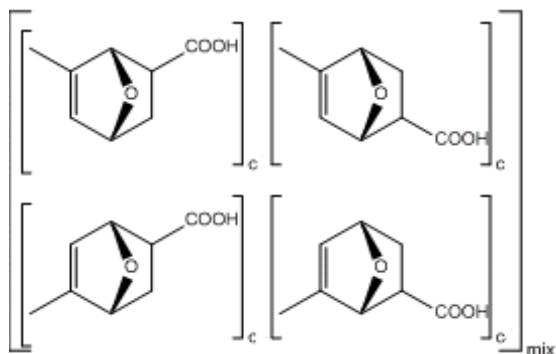

Figure 14.6: Brackets used to indicate mixtures

Bracket type "Mixture, ordered (f)" is primarily used to describe manufacturing processes, where component order is critical. As with unordered mixtures, individual elements of an ordered mixture should be surrounded by brackets with a bracket usage of "Component (c)". However, components of ordered mixtures must be numbered to show their order. You can do this by editing the "c" label with the text tool to include a number ("c1", "c2", and so on.)

Multiple Groups

You use the bracket type, "Multiple Group (#)" to indicate that the enclosed items are repeated a known number of times. Multiple group brackets may enclose entire structures, or part of the structures. Some examples are:

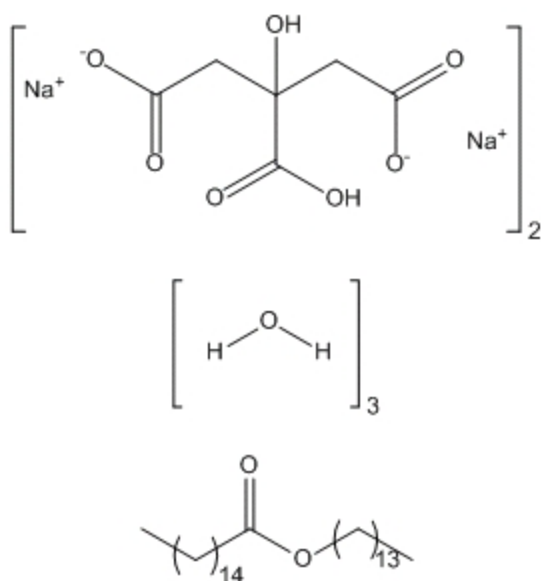

Figure 14.7: Brackets to indicate multiple groups

Because multiple group brackets represent a specific repeat count, you can display the molecular weights (and related data) for the enclosed structures in the Analysis window.

Repeat Pattern

For simple linear polymers, the repeating units may connect head-to-tail or head-to-head (or their repeat pattern might be a mixture or unknown). You can also assign this property to brackets.

The head-to-tail type is the default repeat pattern, as shown below:

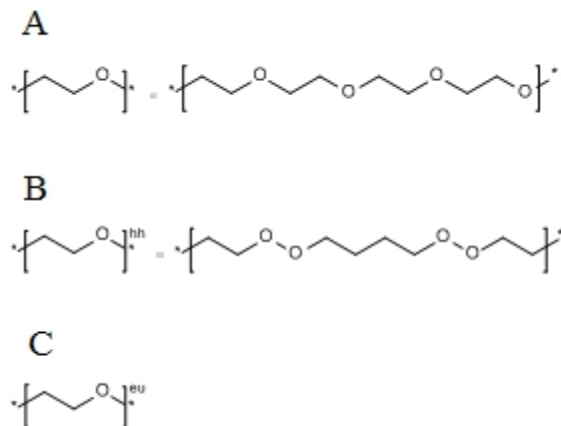

Figure 14.8: Head-to-tail repeat pattern. A and B represent the polymers shown. C represents a mixture of A and B.

Removing Bracket Usage Labels

To remove the bracket usage labels, do one of the following:

- Hover on the label and press **<delete>**.
- Use the Eraser tool to delete the label.

 **Note:** Setting the bracket usage type to 'Unspecified' removes any specific bracket usage assignment.

Link Nodes

You can specify a variable-length chain, or ring, by indicating that one of the atoms can repeat a number of times using link nodes.

Link nodes must have exactly two connecting bonds.

The atom label must meet these conditions:

- It must consist of a generic name, or no more than one element symbol.
- The last part of the label must be in the form: *number hyphen number*, with the numbers and hyphen subscripted.
- Parentheses or braces can be used instead of brackets.

 **Note:** ChemFinder supports only brackets, '[]', for link nodes. Parentheses or braces cannot be used for link nodes in ChemFinder.

- Brackets can be omitted, if not required for clarity, for example with O₁₋₃

To create a link node:

1. Open an atom label text box.
2. Type the link node in this format:

[CH2]3-7

Flip Type

For ladder polymers (polymers with two connecting bonds on each side) the connection order may be undefined. You can assign the Flip Type property to define it. This property is only for brackets with exactly two crossing bonds. Because of its prevalence, the No Flip type does not receive special annotation. The example below illustrates a flip type in ladder polymers.

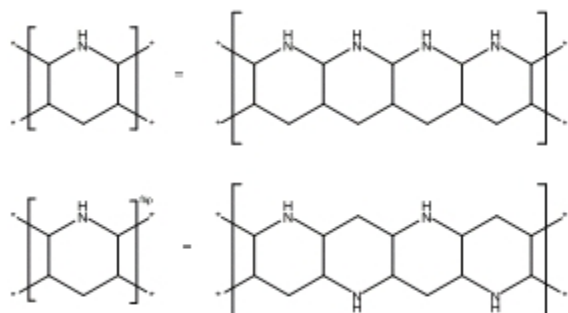

Alternative Groups

You can create a search query that contains variable functional groups or substructures. Instead of submitting multiple queries on structures that share a common substructure, you can submit a single query with the parent structure. The parent structure can have attachment points to a list of alternative groups that you define.

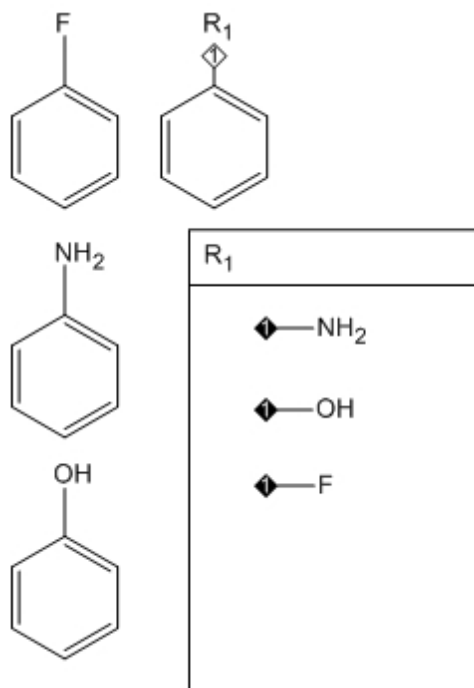

Defining Alternative Groups

You can create alternative group definitions (R, G, and so on.) that represent a set of substituents, each of which is used in the query.

To define alternative groups:

1. Navigate to **View>Other Toolbars>Query Tools** to open the Query toolbar.
2. Click the Alternative Group query tool and drag with the tool to create an area large enough to draw the alternative groups.
3. Type a title, such as R₁, in the Alternative Group Title box, and draw the substructure fragments in the Alternative Group box.

 **Tip:** You can draw the box afterward to enclose the list of alternative groups.

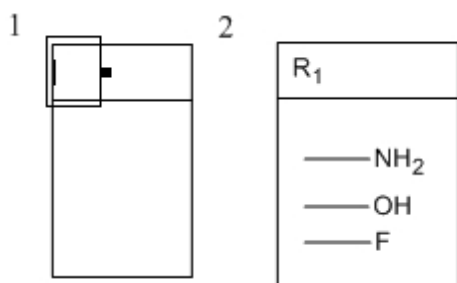

Figure 14.9: Defining an alternative group

Specify where the fragments should bond to the parent structure on the alternative group label by defining attachment points.

1. Do one of the following:
 - Select the diamond-shaped Attachment Point tool on the Chemical Symbols palette (**View>Other Toolbars>Chemical Symbols**), and click a substructure fragment where you want to place the attachment point.
 - Point to a substructure fragment where you want to place the attachment point and press the hotkey “.” (period).

An attachment point symbol appears.

2. Repeat for all fragments.

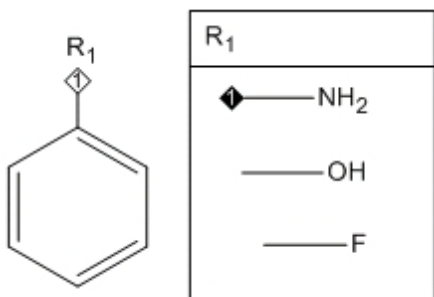

Figure 14.10: Adding attachment points. An attachment point symbol has been applied to the nitrogen atom.

When you create a structure that contains an alternative group, an attachment point symbol appears next to the label. The attachment point number matches that found in the definition.

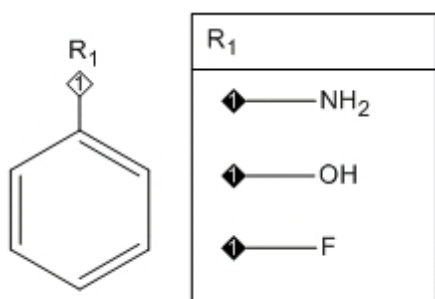
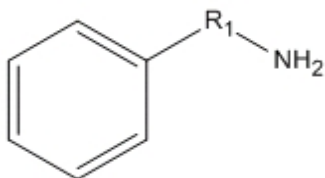

Figure 14.11: Structure with R-group table

The number displayed in the attachment point symbol is the attachment rank order. See the example in "[Multiple Attachment Points](#)" on page 260.

Multiple Attachment Points

You can use R-groups that contain more than one attachment point, for example:



For this type of R-group, you must indicate the attachment point order in your table. If you have well-defined multiple attachment points on your structure fragments, you can search for specific materials. This type of search is useful for finding similar structures that conform.

For example, assume you want to find compounds in figure A below, but not compounds in figure B.

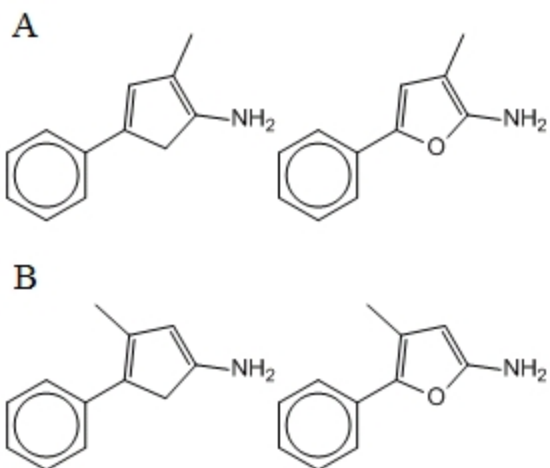
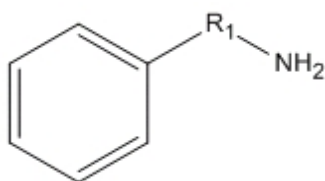

Figure 14.12: Multiple attachment points

By specifying the attachment point order, you can exclude the unwanted compounds.

To specify the attachment points order:

1. Draw the structure shown below



2. Create an alternative group box labeled "R1".
3. Draw the structure fragments and label them with attachment points.

When the alternative group definition is complete, the attachment point symbols appear in the parent compound.

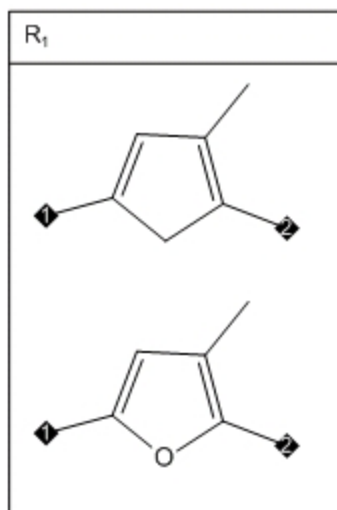

Figure 14.13: R-groups with multi-attachment points

By numbering your attachment points, you specify that the methyl group must be adjacent to the amine group. The conformations that are not of interest are excluded.

Attachment Point Numbering

Numbered attachment points let you specify how the structure fragments connect to your parent structure.

To set the order of the attachment points, use the Attachment Point tool to click the ends of the bonds in the order you want.

To change attachment point order:

- Click the attachment points with the Attachment Point tool.

Hiding Rank Indicators

You can hide the attachment rank indicators if required. For example, in publication-quality drawings the numbering of attachment points is implicit and the numbered attachment rank indicators are superfluous.

To hide the attachment rank indicators and remove the numbers from the attachment points:

1. Navigate to **File>Preferences**.
2. In the Preferences dialog, click **Building/Display**.
3. Deselect **Show Attachment Rank Indicators**.

This change affects all documents.

The figure below shows an alternative group definition and a parent structure with the attachment rank indicators hidden.

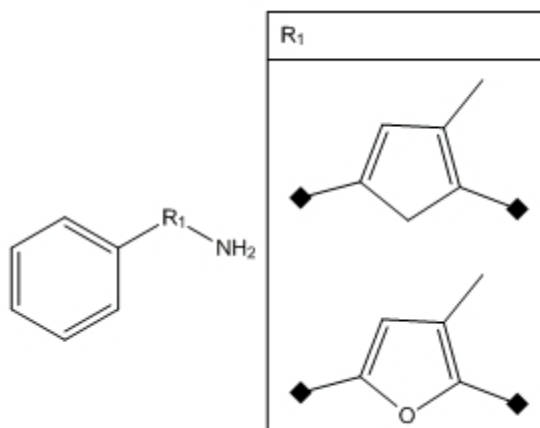
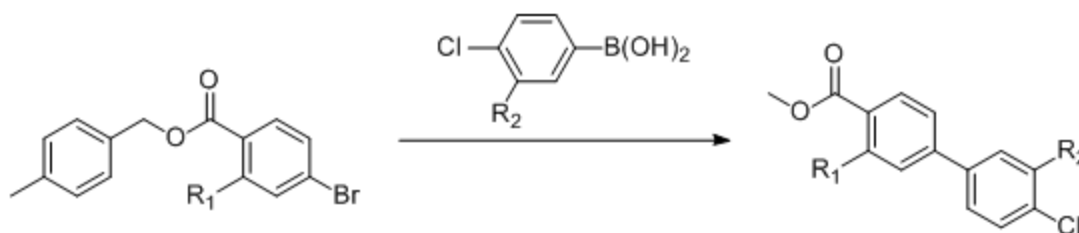

Figure 14.14: Hidden attachment indicators

R-group reaction queries

You can search and store reactions. In a reaction, one or several compounds (reactants) are transformed into other compounds (products). Individual reactants (or products) are separated from each other with plus signs. The reactants are separated from the products with an arrow.

You can also search for chemical reactions containing r-groups. An example of a chemical reaction containing r-groups is shown below:



Searching for reactants

Searching for reactants is useful if you have a known starting material and you are interested in learning more about what substances it can produce. A reactants query is very similar to a reaction search, except that there is nothing to the right of the arrow. For example, consider the query:

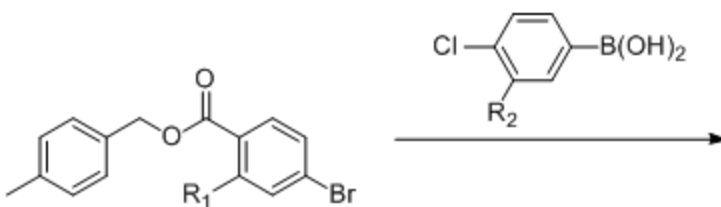
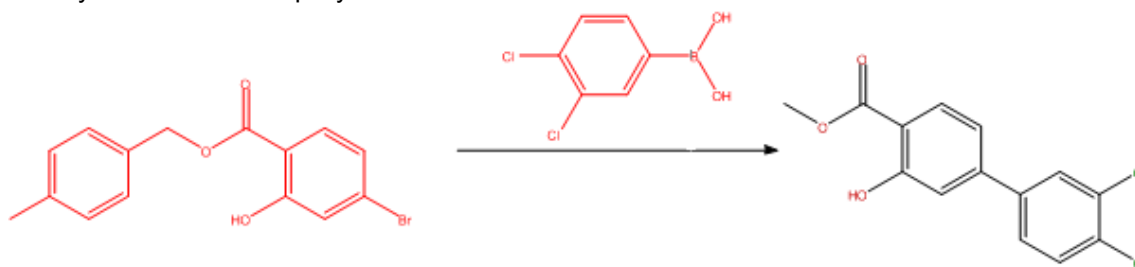

Figure 14.15: Sample r-group reactant query

A likely hit for the above query is shown below:



Searching for products

If you know the desired end product but not how to get there, you can do a products query. A products query is similar to a reaction search, except that there is nothing to the left of the arrow. For example, consider the query:

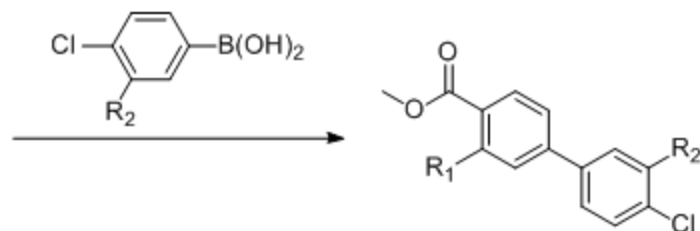

Figure 14.16: Sample r-group product query

Anonymous Alternative Groups

Anonymous alternative groups are a cross between an element list and an alternative group. Element lists comprise single elements, but anonymous alternative groups can contain any structure that can be represented by text, such as nicknames and generic nicknames. Anonymous alternative groups are shortcut notations for regular alternative groups, eliminating the need to specify a name, such as "R1".

You can concisely define your search query using anonymous alternative groups. By labeling an atom position as a list of substructures you specify that one of these substructures must match in the structure for which you are searching. Commas must separate the items in the anonymous alternative group. A space after each comma and the brackets are optional. Examples of anonymous alternative groups are shown below.

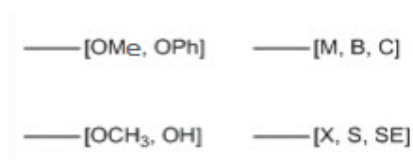

Figure 14.17: Anonymous alternative groups.

To create anonymous alternative groups:

1. Open an atom label text box.

2. Type an open bracket “[” followed by a list of elements, fragments, nicknames, or generic nicknames separated by commas, followed by a close bracket “]”.

Expand Generic Structures

You can generate multiple structures from an abbreviated combinatorial structure with the Expand Generic Structure tool. The tool is limited to 500 generated structures. For large combinatorial expansions, use CombiChem for Excel. Four kinds of abbreviated combinatorial definitions may be used:

Definition

Example

Alternative Groups and
R-tables

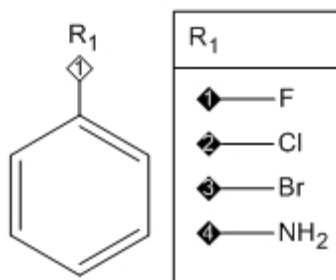

Anonymous Alternative Groups

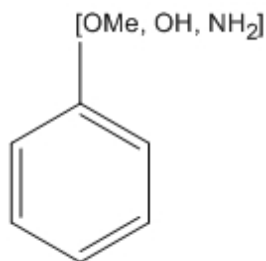

Element
Lists

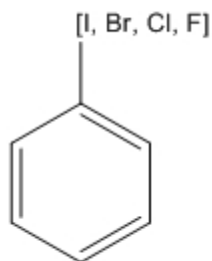

Variable
Attachment

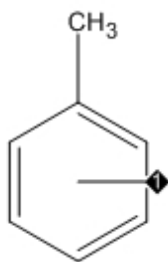
Definition**Example**

Definitions are expanded into multiple complete molecules. If more than one site is present in the selection, the expansion includes all permutations of substitutions. Expansions are generated in a new document.

To expand a generic structure:

1. Select one or more generic structures to expand.

 **Note:** For alternative group/R-tables, you must select the alternative group label and the table must be selected. If the label is selected but not the table, the label will not change in the expansion, and will appear as a label in all generated structures.

2. Navigate to **Structure>Expand Generic Structure**.

The structures are generated in a new document.

R-Logic Queries

After you have your generic structure and a set of R-groups, you can use them to run queries against a structure database. This is called an R-Logic query.

When you run an R-Logic query, you search for structures that all have the generic structure and a combination of your R-groups. The combinations are based on a Boolean expression that you define. To prepare an R-Logic search, navigate to **Structure>R-Logic Query** to open the R-Logic Query dialog.

To define a query, select one or more R-groups in your structure and how many times it must occur. You can indicate that if the first R-group condition is met, another R-group must also be found before the structure is returned as a result. For example, consider this query structure:

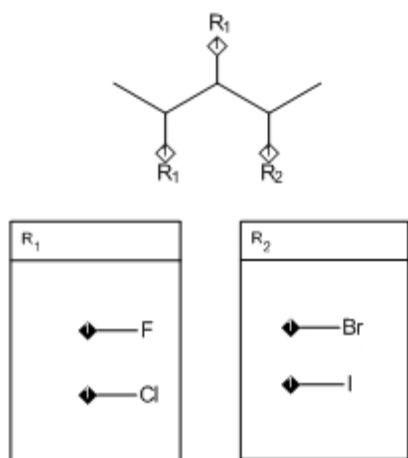

This structure indicates that both R₁ sites must consist of either a fluorine or chlorine atom *and* that the R₂ site must be either a bromine or iodine atom.

Assume you want to find all structures in your database that have either a F or Cl atom at both R₁ locations and either Br or I at R₂:

1. Navigate to **Structure>R-Logic Query**.
2. In the R-Group drop down list, select R₁.
3. For Occurrence range, select 2. This indicates that two instances of an R₁ group must occur in a structure for it to be returned as a result.
4. For If R(i), select R₂. This indicates that the R₂ location must consist of either Br or I.
5. Click **Add**.
6. Click **OK**.

Rest H

Select **Rest H** in the R-Logic Query dialog to indicate that if you have two possible R-group locations, and only one is filled, the other must be a hydrogen to return a positive result.

Atom-to-Atom Mapping

You can create correspondences between atoms in different structures for searching a reaction database. The reactions mapped can be single or multi-step. A drawing that includes atom-to-atom mapping can be added to a database or be used to search.

You can assign atom mapping in two ways:

- Automatic mapping (navigate to **Structure>Map Reaction Atoms**).
- Manual mapping, using the Reaction Atom-Atom Map tool on the main tools palette.

Using either method, ChemDraw assigns a reaction center for the reactants and products.

When a reaction map is established, you can point to an atom in one structure with the Reaction Atom-Atom Map tool to highlight the mapped atom in the other structure.

Displaying and Printing

To display reaction mapping symbols on screen and in print:

1. Navigate to **File>Preferences**.
2. In the Preferences dialog, click the **Building/Display** tab.
3. Select **Always Display and Print Reaction Mapping**.
4. Click **OK**.

Deselect **Always Display and Print Atom Mapping** to show the symbols only when you select the Reaction Atom-Atom Map tool. The symbols do not print.

Automatic Mapping

To create a reaction map:

1. Select the reaction.

 **Tip:** Double-click the arrow with a selection tool to select the reaction.

2. Navigate to **Structure>Map Reaction Atoms**.

The symbol **Rxn** appears next to the bonds in the reactant and product that are modified by the reaction. For more information about the Reaction Center bond property, see "[Bond Properties](#)" on page 249.

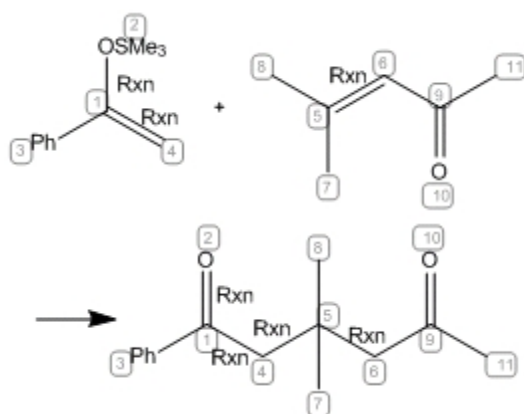

Figure 14.18: Automatic reaction mapping

Manual Mapping

When manual atom-to-atom mapping is required, you can use the Reaction Atom-Atom Map tool. This might be necessary when the automatic mapping is applied to complicated reactions, but gives incorrect results. In these cases you

can manually readjust the reaction mapping.

The figure below shows the initial mapping being amended by using the Reaction Atom-Atom Map tool.

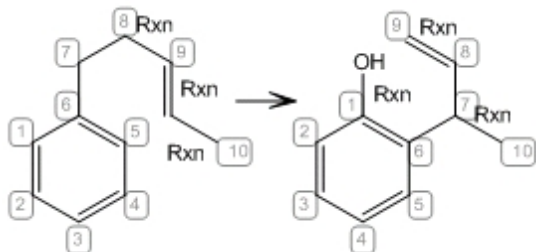

Figure 14.19: Automatic mapping to be amended

When you manually map reactions with the Reaction Atom-Atom Map tool, you can suppress automatic re-mapping of atoms other than your target atom.

To suppress automatic remapping:

1. Navigate to **File>Preferences**.
2. On the General tab, de-select **Automatic Reaction Mapping**.
3. Click **OK**.

To use the Reaction Atom-Atom Map tool to supplement the automatic mapping:

1. Click the Reaction Atom-Atom Map tool on the Query toolbar.
2. Point to the atom in the reactant whose mapping you want to establish. For example, in the following drawing you would point to the acyclic carbon adjacent to the ether oxygen.
3. Drag from the reactant atom to the corresponding product atom.

The remaining atoms are mapped based on the manual mapping.

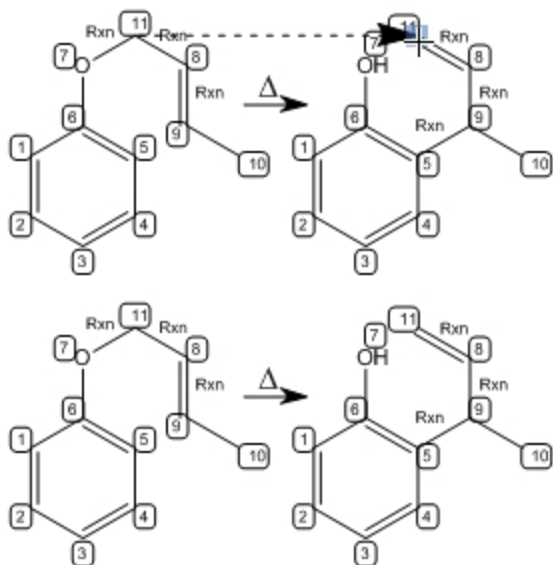

Figure 14.20: Finalized mapping

You can set or change the mapping for other atoms in the reaction.

Clearing Reaction Mapping

To clear reaction mapping:

1. Select the structures whose mapping you want to clear.
2. Navigate to **Structure>Clear Reaction Map**.

Clicking and dragging from any atom to an empty space in the ChemDraw window using the Reaction Atom-Atom Map tool will clear the mapping from that atom.

Exporting Reaction Mapping

Reaction mapping and reaction center perception information are stored in the *.cdx file format. You can open the file in ChemDraw for transfer to other applications that read atom mapping, such as ChemFinder. You can also copy mapped reactions to these same applications using the Clipboard.

Stereochemical Symbols

There are three types of flags that indicate stereochemistry:

Racemic. A racemic mixture.

Absolute. A pure enantiomer of known configuration.

Relative. A pure enantiomer of unknown configuration.

The default atom label size for the document determines font and size for stereochemical flags.

To draw a stereochemical flag:

1. To display the Query tools, navigate to **View>Other Toolbars>Query Tools**, or click the Query Tools icon on the Main Tool palette.
2. On the Query tools palette, click the tool for the flag you want to use.
3. Click next to the structure to which you want to assign the flag.

3D Properties

3D queries are useful in pharmacophore searching when looking for a 3D relationship among atoms and bonds, (for example in a series of potential receptor ligands). To create a 3D query, you add geometries (lines, planes, and so on) and constraints (specified as ranges) to a query structure. For example, you can specify that two atoms must be between 4 and 5 Å apart, or that two planes must be separated by 80-100 degrees.

To assign 3D properties to a structure:

1. Select the structure or substructure.

 **Note:** Because some 3D properties specify an order, use **SHIFT+Click** to select them in the order you want.

2. Navigate to **Structure>Add 3D Property** and select an option from the table below.

 **Note:** In the table, points may be atoms, centroids, or points. Lines may be lines or normals.

Angle. Defines an angle constraint between three points (in order). Indicated as a range.

Dihedral. Defines a dihedral (torsional) angle constraint among four points (in order), between two lines, or two planes. Indicated as a range.

Distance. Defines a distance constraint between two points, a point and a line, or a point and a plane. Indicated as a range, in angstroms.

Line. Defines the best-fit line for the selected points.

Plane. Defines the best-fit plane for the selected points, or for a point and a line.

Exclusion Sphere. Defines an exclusion sphere around a point. If more than one point is selected, the exclusion sphere is around the first selected point, and the subsequent points are allowed within the exclusion sphere when the query is evaluated. Indicated as a range, in angstroms, beginning at 0.

Normal. Defines the normal from a defined plane in the direction of a point.

Point. Defines a point positioned at a specified distance from a first point in the direction of a second point (in order), or in the direction of the normal.

Centroid. Defines a point positioned at the average position of all other points selected.

Notes:

- All constraint values can be edited with the text tool. Only exclusion spheres show the change.
- When you create a point, a dialog appears where you specify the distance from the first selected point to the calculated point. The distance may be an absolute value in Å or a percentage of the distance between the selected points.

- Negative values indicate that the calculated point is further from the second point than the first point is, rather than between them.
- Geometry and constraint objects update when you change the structure; they cannot be moved independently.
 - They may be used with CDX, MOL, SKC, and TGF files (full read-write compatibility); they are not compatible with other formats.
 - They can, however, be saved in print-only formats such as TIFF.

Export Compatibility

Because query properties are useful only in a chemical database, you must transfer your structures from ChemDraw into your search system. Not all file formats support the same query properties and not all chemical databases support the same file formats. Consult the documentation for your database for which file formats are supported. The following table lists the query properties that ChemDraw writes to SKC, TGF, and Clipboard file formats. The CDX format retains all query properties.

Exported Query Properties	ISIS™	Mol	Rxn
Atom Properties			
Substituents			
Unspecified	X	X	X
▪ Free Sites	b	b	b
▪ Up to	a	a	a
▪ Exactly	X ^c	X ^c	X ^c
Implicit Hydrogens			
▪ Not allowed	X	X	X
▪ Allowed	X	X	X
Ring Bond Count			
▪ Any	X	X	X
▪ No ring bonds	X	X	X
▪ As drawn	X	X	X
▪ Simple ring	X	X	X
▪ Fusion	X	X	X
▪ Spiro or higher	X	X	X

Exported Query Properties	ISIS™	Mol	Rxn
Unsaturation			
▪ Unspecified	X	X	X
Must be absent			
▪ Must be present	X	X	X
Reaction Change			
▪ May be anything	X		X
▪ Must be as specified	X		X
Reaction Stereo			
▪ Any	X		X
▪ Inversion	X		X
▪ Retention	X		X
Translation			
Equal			
▪ Broad			
Any			
▪ Narrow			
Abnormal Valence			
▪ Not Allowed	X	X	X
▪ Allowed	X	X	X
Bond Properties			
Bond Type			
▪ Single	X	X	X
▪ Dashed	X	d	X
▪ Hashed	d	d	d
▪ Wedged Hashed	X	X	X

Exported Query Properties	ISIS™	Mol	Rxn
▪ Bold	X	e	e
▪ Wedged	X	X	X
▪ Wavy	X	X	X
▪ Hollow Wedged	e	e	e
▪ Dative	f	f	f
▪ Double	X ^g	X	X
▪ Double Either	X	X	X
▪ Double Bold	h	h	h
▪ Aromatic	X	X	X
▪ Tautomeric	i	i	i
▪ Triple	X	X	X
▪ Quadruple	l	l	l
▪ Any	X	X	X
▪ S/D	X	X	X
▪ D/A	X	X	X
▪ S/A	X	X	X
Topology			
▪ Unspecified	X	X	X
▪ Ring	X	X	X
▪ Chain	X	X	X
Reaction Center			
▪ Unspecified	X		X
▪ Center	X		X
▪ Make/Break	X		X
▪ Change	X		X

Exported Query Properties	ISIS™	Mol	Rxn
▪ Make&Change	X		X
▪ Not Center	X		X
Other Query Attributes			
▪ Generic Nicknames	X ^j	X ^j	X ^j
▪ Element Lists	X ^{ko}	X ^{ko}	X ^{ko}
▪ Element Not Lists	X ^k	X ^k	X ^k
▪ Alternative Groups	X	X ^m	
▪ Anonymous Alternative Groups	n	n	
▪ Link Nodes	p	p	p
▪ Bracket properties	X	X	X
▪ Atom-Atom mapping	X		X
▪ Variable Attachment Positions			
3D query properties			

a—Converted to the appropriate number of exact substituents.

b—Free sites counts of zero translated to “Substitution as drawn”; all other free sites values written as substitution counts equal to the total current valence, plus the free sites value.

c—Substituent counts of greater than 5 are translated to “6 or more”.

d—Converted to wedged hashed.

e—Converted to wedged.

f—Converted to a single, with a positive charge applied to that atom at the base of the dative bond and a negative charge applied to the atom at the point of the dative bond.

g—Interpreted by ISIS™ as unspecified cis/trans stereochemistry.

h—Converted to double.

i—Converted to aromatic.

j—Only M, X, Q, A; others written as aliases.

k—Truncated to the first 5 elements.

l—Converted to single.

m—An RG file will be created automatically.

n—Converted to non-anonymous alternative groups.

- o—Lists of greater than 5 elements converted to alternative groups.
- p—The low end of the repeat range is always treated as 1.

Sharing Information

Many of the system commands you commonly use to transfer content from one place to another can also be used in ChemDraw:

- Copy/paste
- Import and export content files

When you use the clipboard, the objects you copy can be edited.

The Clipboard

You can use the clipboard to transfer part, or all, information within an active document window between applications on the same computer or on a network. Use the standard copy-and-paste or cut-and-paste tools to transfer information to any application that supports these tools. The information is transferred as a drawing object. Double-click the object to edit it in ChemDraw.

You can also use the Copy As tool to translate a selected structure to a SMILES, SLN, or InChI™ string.

If the Clipboard contains structures and you paste into another ChemDraw document, the pasted information is scaled to the settings in the new document. For more information, see ["Autoscaling" on page 280](#).

Text Line Notation

Use text line notation¹ to expand a line of text into the structure that it represents. Several software packages use SMILES strings to enter and store chemical structure information.

If you select a reaction and use the Copy As SMILES command, a SMIRKS string is copied to the clipboard. If you use the Paste Special SMILES command when a SMIRKS string is on the clipboard, a reaction is pasted into your document.

Creating SMILES Strings

To create the SMILES string for a structure:

1. Select the structure.
2. Navigate to **Edit>Copy As>SMILES**.

The SMILES string is transferred to the Clipboard.

To display the SMILES string, paste the string in a document window.

When the SMILES string is on the Clipboard, you can transfer it to another application that can interpret SMILES strings.

If you copy more than one structure from ChemDraw to the Clipboard, the SMILES string are separated by a period. SMILES supports an alternate notation for aromatic structures using lowercase letters. ChemDraw generates this type of SMILES string for any structure drawn with explicit aromatic bonds.

¹A SMILES string is a line of text that represents the structure of a molecule. A SMIRKS string describes chemical reactions in text.

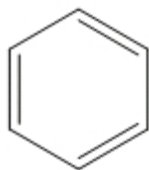
C1=CC=CC=C1

c1ccccc1

Pasting SMILES

To paste a SMILES string as a structure:

1. Select the SMILES string in the source file and press CTRL+C.
2. From ChemDraw, navigate to **Edit>Paste Special> SMILES**.

Creating SLN Strings

You can copy a structure to the Clipboard as an SLN string for export to other applications.

To copy a structure as an SLN string:

1. Select a structure.
2. Navigate to **Edit>Copy As>SLN**.

The Structure is copied to the clipboard as an SLN String.

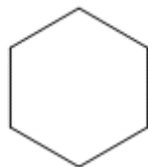
C[1]CCCCC@1

Creating InChI™ Strings

ChemDraw supports IUPAC International Chemical Identifier (InChI™).

To copy structures as InChI™ strings to other documents:

1. Select the structure.
2. Navigate to **Edit>Copy As>InChI**.

You can copy only legitimate InChI™ structures. If you attempt to copy a structure that the InChI protocol does not support, a warning informs you that the structure is not supported.

Creating InChIKey Strings

ChemDraw supports Standard InChIKey, available in InChI 1.02. An InChIKey string is a condensed digital representation of an InChI string. All InChIKey strings are the same length whereas InChI strings are not. This standard makes InChIKey strings useful for Web searching and database indexing.

To copy a structure as an InChIKey string to other documents:

1. Select the structure.
2. Navigate to **Edit>Copy As>InChIKey**.

For more information on InChI™ and InChIKey, see www.iupac.org/inchi/.

Creating CDXML, MOL or MOL V3000 Text

To create the CDXML text or MOL text or MOL V3000 text for a structure:

1. Select the structure you want to create the CDXML, MOL or MOL V3000 text for.
2. Navigate to **Edit > Copy As > CDXML Text** or **MOL Text** or **MOL V3000 Text**.

The CDXML text or MOL text or MOL V3000 text is transferred to the clipboard.

Pasting CDXML or MOL Text or MOL V3000 Text

The **Paste Special>MOL/CDXML** command parses text on the clipboard, and pastes the resulting structure of any MOL or CDXML formats it finds into the document.

To paste and display the CDXML text or MOL text or MOL V3000 text from the clipboard to the document window:

3. Navigate to **Edit > Paste Special > MOL/CDXML Text**.

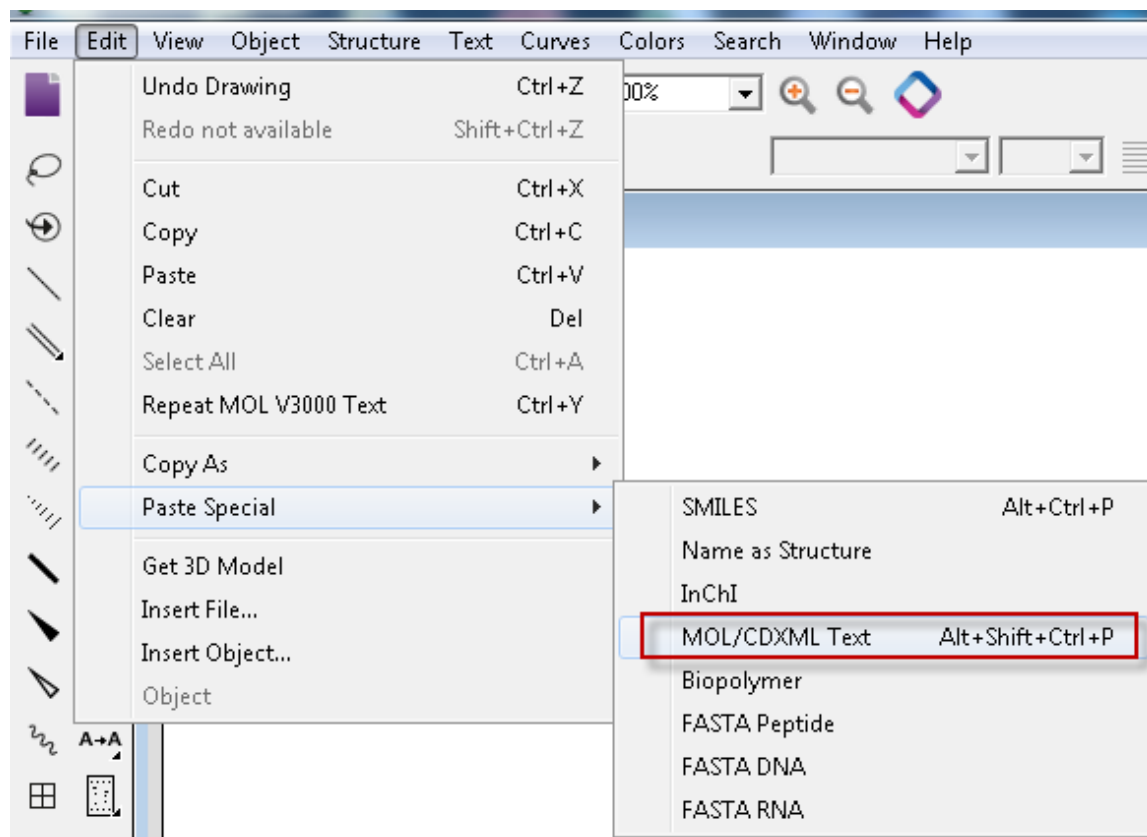

Scrap and Clipping Files

You can use scrap files to copy parts of a drawing to other applications after saving the file in ChemDraw.

To create a scrap or clipping file:

1. Select an object in a document.
2. Drag the selection out of the document window onto the desktop. The file appears on the desktop.

To view the file contents, double-click its icon. To use contents in a document, drag the file into an open window of an application that supports drag-and-drop.

Transferring Objects

This section explains behaviors of certain features in ChemDraw when you transfer objects using the clipboard, or drag and drop from one document to another.

Autoscaling. Objects that you transfer are scaled to match the settings of the destination document.

Bonds. When you copy or move a structure to another document, the structure adopts the new document's fixed-length value, but retains its scaling factor.

For example, assume the fixed length is set to 1.0 cm in a source document. A benzene ring is resized to 200%. The bond length is then 2.0 cm. In the destination document, assume the fixed Length set to 1.7 cm. When the benzene ring is pasted into the destination document, the bonds are scaled by a factor to 200% to a final bond length of 3.4 cm.

Atom Labels. Atom labels are scaled the same way as bonds. For example, in the source document, assume the atom label font size is set to 16 points. One or two atom labels in the source document are resized to 8 points, a ratio of 8:16 or a scale factor of 0.5. Assume that the destination document has an atom label font size set to 14 points. If you paste the atom label into the destination document, the font size is scaled by a factor of 0.5 to give a final atom label font size of 7 points.

Captions. ChemDraw autoscales captions using the ratio of the fixed length in the destination document to the fixed length in the source document times the caption font size. The font size of the caption can be any size and is not related to the setting in the Settings dialog. This ensures that captions are always in proportion to the bonds with which they are pasted.

For example, if the source document has a fixed length of 1.0 cm and the destination document has a fixed length of 2.0 cm, and the caption you are pasting is 12 points, then the resulting caption size after autoscaling is $(2.0 \text{ cm} / 1.0 \text{ cm}) \times 12 \text{ points} = 24 \text{ points}$.

Non-bond Objects and Color. The document settings do not affect all objects. Objects such as arrows and boxes, are scaled to maintain the same proportions to bonds that were in the source document.

Except for the foreground and background color, the colors present in the selection to be pasted are added to the destination document's Color palette if they are not already (up to 20 total colors). The background color in the destination document remains, and all objects colored using the foreground color are changed to match the foreground color in the destination document.

Pasting to an Empty Document. If you paste a ChemDraw drawing into an empty document that has different settings, the Change Settings dialog appears.

To change the settings in the destination document to match the settings in the source document, click **Change Settings**.

All of the settings in the destination document are changed to match those of the source document. All of the colors in the Color palette of the destination document are changed to those specified in the source document.

To scale the objects from the source document to the settings in the destination document, click **Don't Change Settings**.

The settings from the source document are scaled to those in the destination document using the ratios given above.

 **Note:** If the source document was created in a ChemDraw version earlier than 3.0, the name of the document appears as "Unknown" in the dialog box.

Embedding Objects

ChemDraw supports the Object Linking and Embedding (OLE) protocol on Windows. This lets you edit structures that are pasted in other types of documents. ChemDraw is an OLE server, which means it can create OLE objects that you can copy and paste into other OLE client applications.

When you transfer drawing from ChemDraw to another document type that supports OLE, you can open and edit the drawing within the new application.

For example, to edit a drawing inserted into Microsoft Word 2003 or later, do one of the following:

- In Microsoft Word, select the drawing and navigate to **Edit>CS ChemDraw Drawing Object**.
- Double-click the drawing.

The ChemDraw tools and menus replace those of Word. Use the tools to edit the drawing.

When you finish making changes, click in another area of the Word document. The Word tools and menus are restored.

Exporting

You can export ChemDraw drawings in various file formats and open them in other applications. Conversely, ChemDraw recognizes a variety of file formats and can open documents from other applications.

To export a file:

1. Navigate to **File>Save As**.
2. In the Save As dialog, do the following:
 - a. Type a name for the file and a location to save it to. Click **Go To ChemDraw Items** to locate the ChemDraw Items folder.
 - b. Select a file format.
 - c. Click **OK**.

Some file formats do not support atom labels that contain nicknames or structural fragments. When you save in these formats, ChemDraw expands all atom labels and saves the file using the expanded form.

These formats do not support nicknames or structural fragments:

- Connection Table
- MSI MolFile
- SMD

 **Note:** Some versions of ChemDraw do not support all the formats listed.

Some formats can be saved with different options. If a format has no save options, **Options** is grayed out. These text-based formats can use the Text Options:

- ChemDraw XML
- CML
- Connection Table
- ISIS/TGF
- ISIS/Reactions
- MDL MolFile
- Accelrys MolFile
- SMD

Other format options are noted in format descriptions.

Importing

You can import graphics or documents from other applications into ChemDraw.

Objects

Inserted objects are OLE files and can be resized and rotated but not flipped. You also can edit it in its native application from within the drawing window.

Files

Files that you insert become part of the drawing. You can edit a file only if it is in a ChemDraw format.

To insert a file:

1. Navigate to **Edit>Insert File**.
2. In the Open dialog, select the file type from the drop-down list.
3. Select the file and click **Open**. The file is embedded in the drawing.

To insert an object:

1. Navigate to **Edit>Insert Object**.
2. In the Insert Object dialog, click **Create from File**.
3. Browse to the object file and click **OK**.

 **Note:** You will get an error message if you choose a file type that ChemDraw does not support (such as TXT).

To create an object:

1. Navigate to **Edit>Insert Object**.
2. Click **Create New**.
3. Select the **Object Type**.

- Click **OK**.

ISIS™ Compatibility

ChemDraw Professional, and ChemDraw Prime support ISIS/Sketch including R-Logic and leaving groups.

Attached Data

Using field names, you can attach text to objects such as atoms and bonds. The feature is compatible with the “Data SGroup” in MDL formats, and is converted to Data SGroups when saved in MDL formats if a field name is specified *and* it is attached to a collection of atoms and bonds, *or* single set of brackets.

When attached to a collection of atoms and bonds and a set of brackets, a field name is converted to two different Data SGroups.

You can now specify a single character tag while attaching data to an object. These tags will be displayed along with objects. You can add multiple tags to an object.

To attach data to an object:

- Select the object.
- Navigate to **Object>Attach Data**. The Attach Data dialog box appears.
- Enter the field name.
- Select a **Search Operator** from a predefined set of operators provided.
- Enter the data in the **Data** textbox.
- Specify a single character tag in the **Tag** textbox.
- Select the tag position relative to the linked object from the **Position** list box.
- click **OK**.

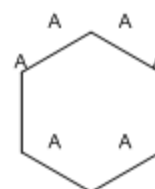
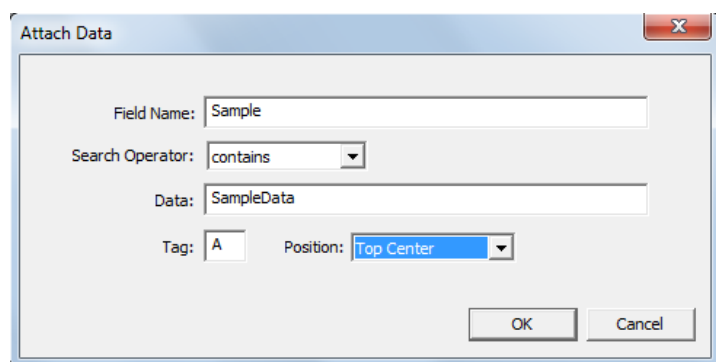

A = contains SampleData

Modifying Attached Data

To edit the attached data, right-click on the attached data and select **Edit Attached Data** from the context menu. The Attach Data dialog appears and lets you make the required changes.

Two additional commands appear on the context menu when you select attached data.

- **Select Linked Objects:** Changes the selection to include all of the objects associated with the data.
- **Position:** Lets you position the data relative to the associated structure.

 **Note:** Positioning information is lost whenever you save to MDL formats.

Graphics Export Border Preference

You can specify the border size when exporting pictures. This preference affects the output of all graphical formats, such as: WMF, PICT, EPS, TIFF, GIF, BMP, and PNG. It applies to the clipboard and saved files. The default value is 2 points (0.278 in; 0.071 cm).

File Formats

The file formats available in ChemDraw are:

Format	Windows
ChemDraw (CDX)	YES
ChemDraw XML (CDXML)	YES
ChemDraw (CHM)	YES
ChemDraw Style Sheets (CDS)	YES
Connection Table (CT)	YES
Chemical Markup Language (CML)	YES
Bitmap (BMP)	YES
TIFF file (TIF)	YES
Graphic Image Format (GIF)	YES
ISIS (SKC, TGF, RXN)	YES
JCAMP (JDX, DX)	YES
JPEG (JPG, JPEG)	YES
MDL SDfile (SDF)	YES
MDL MolFile (MOL)	YES
MSI ChemNote (MSM)	YES
PNG Image (PNG)	YES
Standard Molecular Data 4.2 (SMD)	YES
Galactic Spectra (SPC)	YES
Windows Metafile	YES

Format	Windows
(WMF)	
Enhanced Metafile (EMF)	YES
ChemDraw Templates (CTP)	YES
ChemDraw Templates Style sheets (CTS)	YES
PDF	NO
MDL Molfile V3000 (MOL)	YES
MDL SDF file V3000 (SDF)	YES
Reaction Molfile V3000 (RXN)	YES
PICT	
PICT Scaled 4x	NO
Encapsulated PostScript	YES
Scalable Vector Graphics	YES

ChemDraw supports importing and exporting the file formats listed below. To export in one of these formats, use the **Save As...** option.

Not all formats are supported in all ChemDraw products. Refer to ["Importing" on page 282](#).

Format	Import	Export
ChemDraw (CDX)	YES	YES
ChemDraw XML (CDXML)	YES	YES
ChemDraw 3.5 (CHM)	YES	YES
ChemDraw 2.0 and ChemDraw 2.1 (CHM)	YES	NO
ChemDraw Template (CTP)	YES	YES
ChemDraw Template Style Sheet (CTS)	YES	YES
ChemDraw Style Sheets (CDS)	YES	YES
Connection Table (CT)	YES	YES
Chemical Markup Language (CML)	YES	YES

Format	Import	Export
Bitmap (BMP)	YES	YES
PostScript (EPS)	NO	YES
Graphic Image Format (GIF)	YES	YES
ISIS (SKC, TGF, RXN)	YES	YES
JCAMP (JDX, DX)	YES	NO
JPEG (JPG, JPEG)	YES	YES
MDL MolFile (MOL)	YES	YES
MDL RGFile (MOL)	YES	YES
MDL V3000 MolFile (MOL)	YES	YES
MDL SDFfileV3000	YES	YES
MSI ChemNote (MSM)	YES	YES
Portable Network Graphics (PNG)	YES	YES
Standard Molecular Data (SMD)	YES	YES
Structure Data file (SDF)	YES	YES
Galactic Spectra (SPC)	YES	NO
Windows Metafile (EMF, WMF)	YES	YES
Scalable Vector Graphics (SVG)	NO	YES
Portable Document Format (PDF)	YES	YES
Tagged Image File (TIF, TIFF)	YES	YES

Transferring Across Platforms

You can open cdx files in either ChemDraw for Macintosh, or Windows. When you transfer files across platforms, fonts are not transferred. If a font in the transferred document is not available, ChemDraw substitutes fonts for those that are available on the new platform.

Understanding ChemDraw Cloud

ChemDraw, the chemical structure drawing and editing tool is now available without any installation in ChemDraw Cloud, you can use it in your browser. ChemDraw Cloud consists of a drawing toolbar and document window. The

document window lets you draw and edit chemical structures using the various drawing tools available in the ChemDraw Cloud toolbar. ChemDraw Desktop and ChemDraw Cloud can share files via upload and download.

 **Note:** ChemDraw Cloud feature is available only with ChemDraw Professional.

Logging in to ChemDraw Cloud

To log in to ChemDraw Cloud:

1. Click **File > ChemDraw Cloud**, select **Browse...** or **Upload...**. If you have not yet logged in, the **Login** page appears.

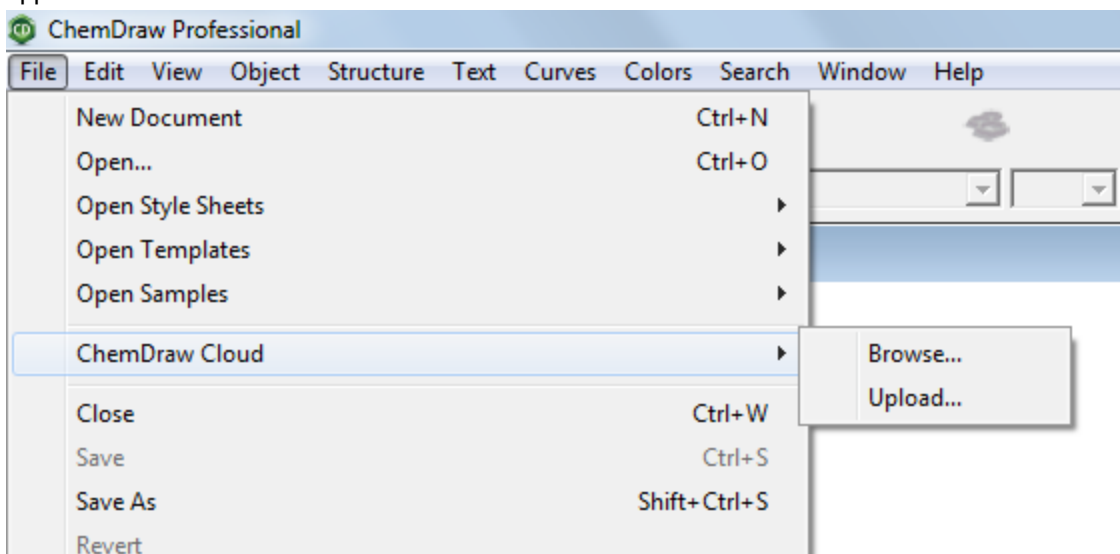

2. Enter your **Username** and **Password**, and then click **Sign In**.

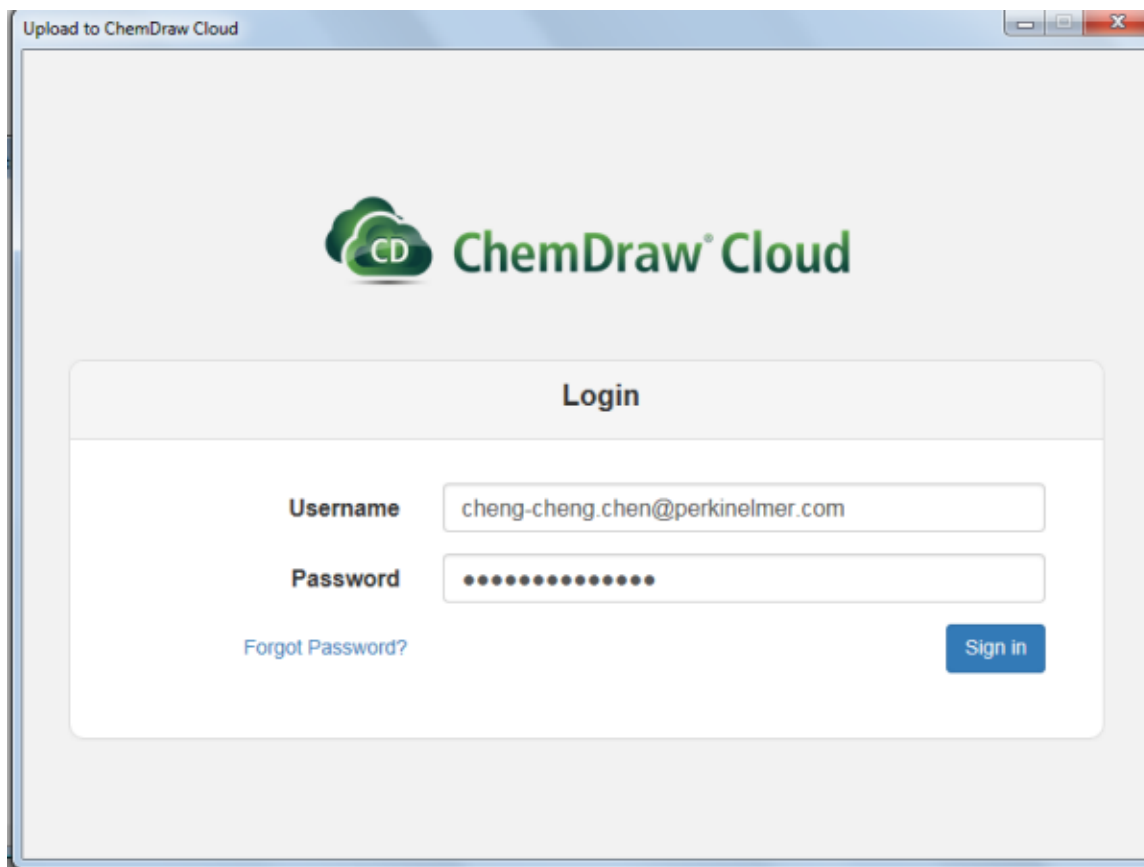

Managing your ChemDraw Cloud Login Credentials

After you log into your ChemDraw Cloud account, you can configure ChemDraw Cloud to remember your login credentials, if desired, using the "**Would you like to remember the password for the user**" pop-up message that appears on the upper-right corner of the ChemDraw Cloud window.



Do one of the following:

- Click **Yes**, to save your login credentials. When you click **Yes**, your login credentials will be saved and next time when you log into ChemDraw Cloud, your login credentials will be displayed automatically in the login window. After you save your credentials, you can do one of the following anytime by clicking the key icon  anytime to show or hide the pop-up message box:
 - Click **Forget It**, to forget the saved credentials.
 - Click **Keep it Remembered**, to keep remembering your saved credentials.

- Click **Not Now**, if you do not want to save your login credentials now, but on a later time.

 **Note:** If you click **Not Now**, your login credentials will not be saved, and you will get this pop-up message when you log into ChemDraw Cloud next time.

- Click **Never**, if you do not want to save your ChemDraw Cloud login credentials.

 **Note:** If you click **Never**, your login credentials will not be saved, and you will not get this pop-up message when you log into ChemDraw Cloud next time.

Uploading Documents to ChemDraw Cloud

To upload documents from ChemDraw to the ChemDraw Cloud:

1. Click **File > ChemDraw Cloud** and select **Upload...**
2. Log in with valid account.

 **Note:** if you are already logged in, the Login page will not appear.

3. Enter the document name and click **Upload** to save the document to the ChemDraw Cloud.

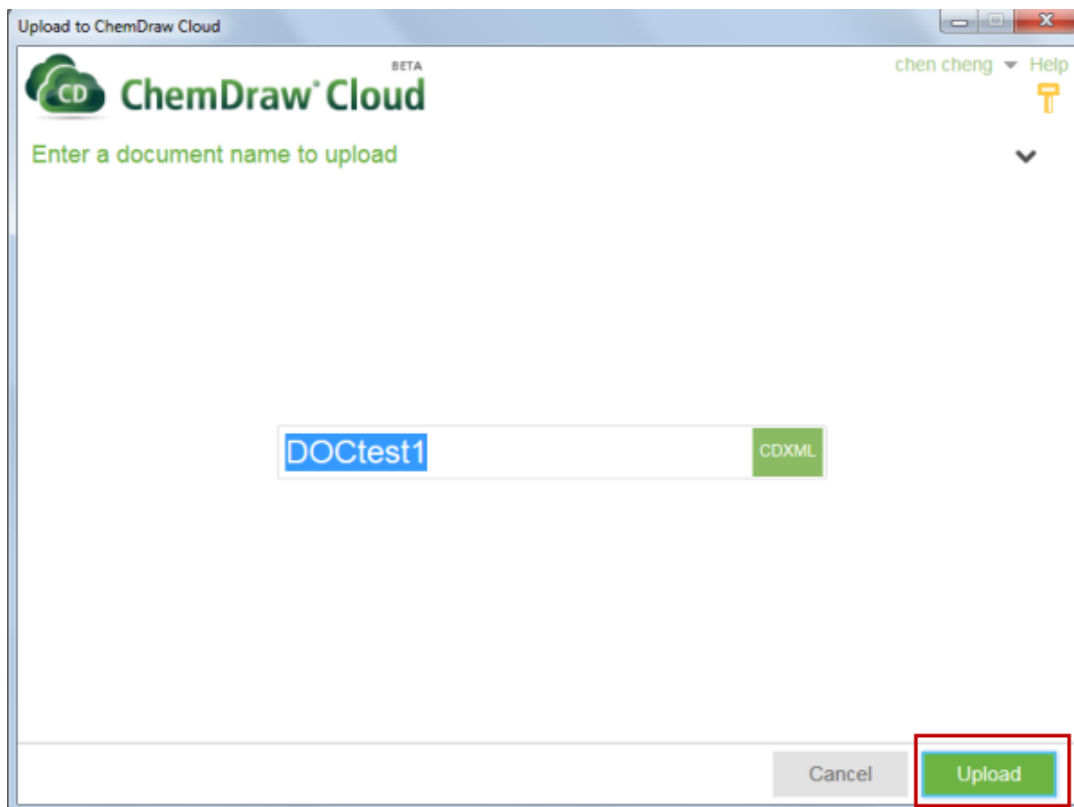

If the specified document name already exists, the following dialog appears:

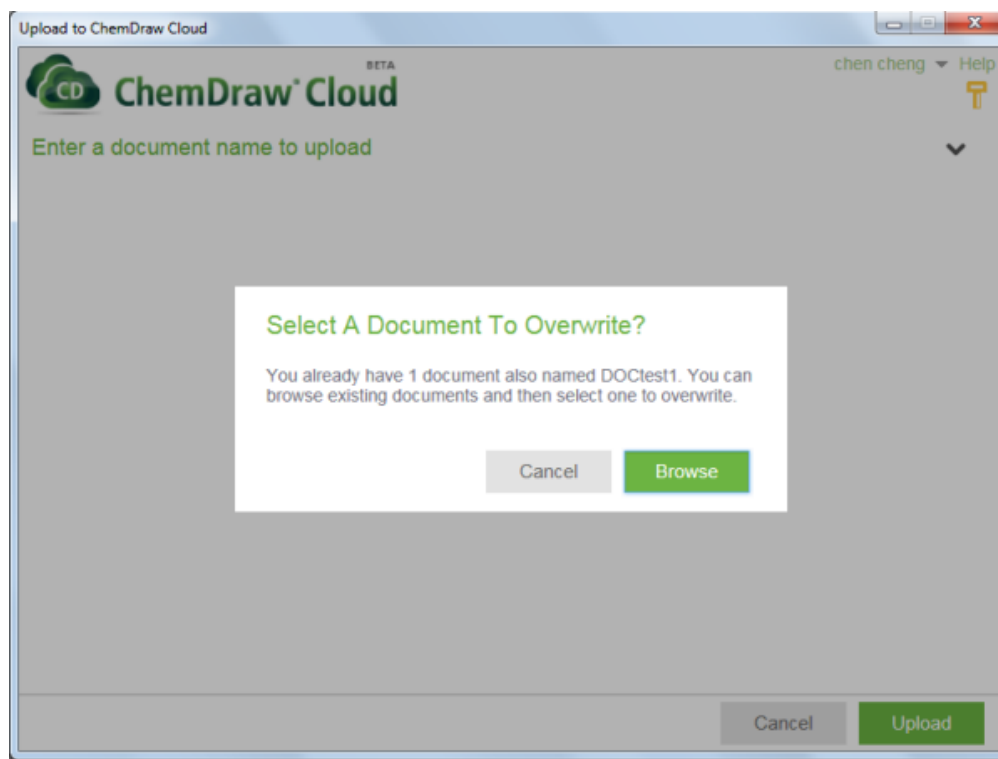

You can choose to do any one of the following:

- Click **Cancel** to cancel upload.
- Click **Browse** to browse for existing documents and select one to overwrite.

Overwrite a Document

There are two ways you can overwrite a document:

- Select a document from the document list view.
- Enter keywords in the Search box to display a suggested list.

To overwrite a document from the document list view:

1. Select the down arrow link in the top right of the page to view a document list:

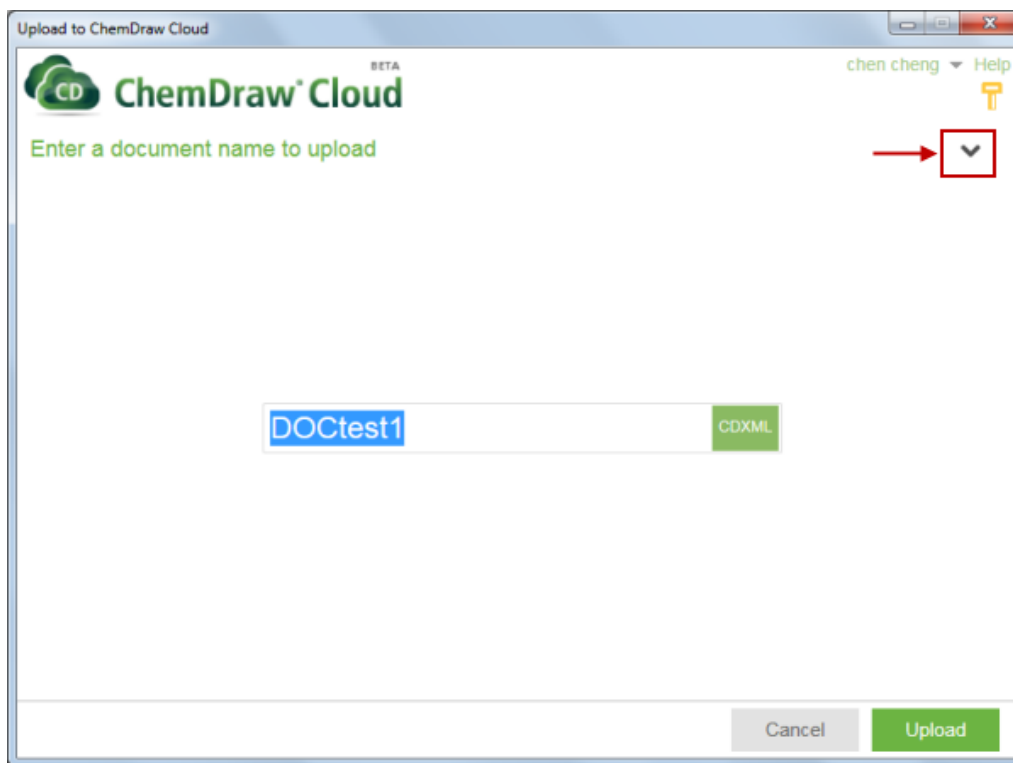

2. Select the document in the list that you want to overwrite.

 **Note:** The **Upload** button changes to **Overwrite**.

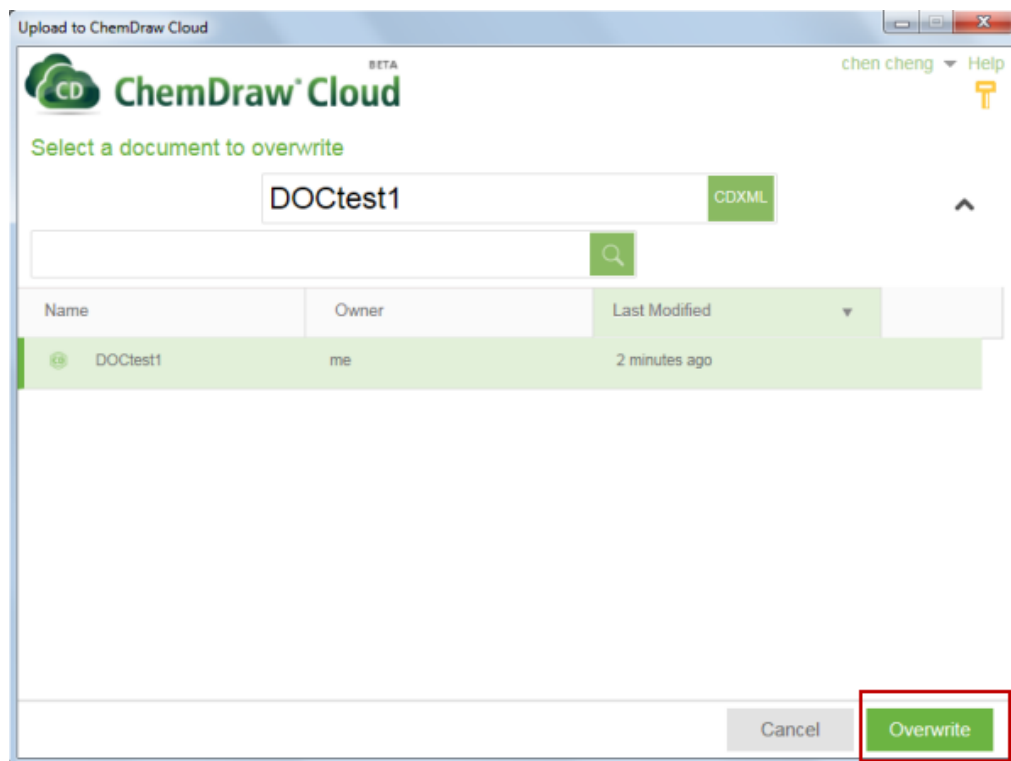

3. Click **Overwrite**. Click **Overwrite** again to confirm it.

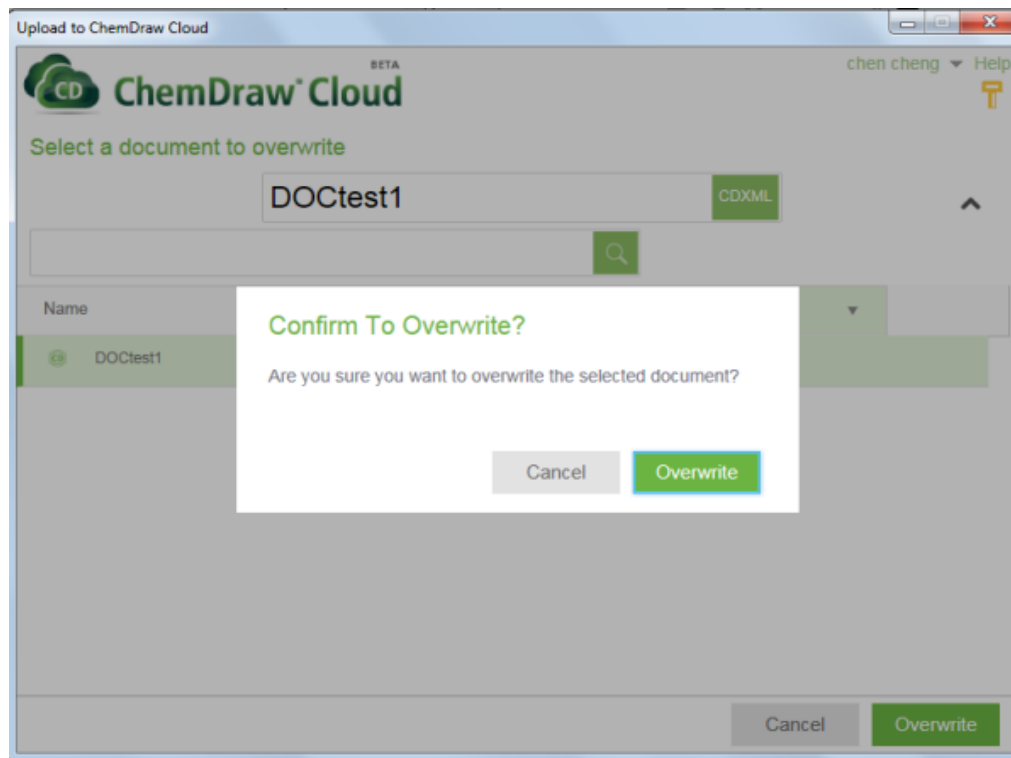

To overwrite a document by entering keywords:

1. Enter some appropriate keywords in the search box to display a suggested list.

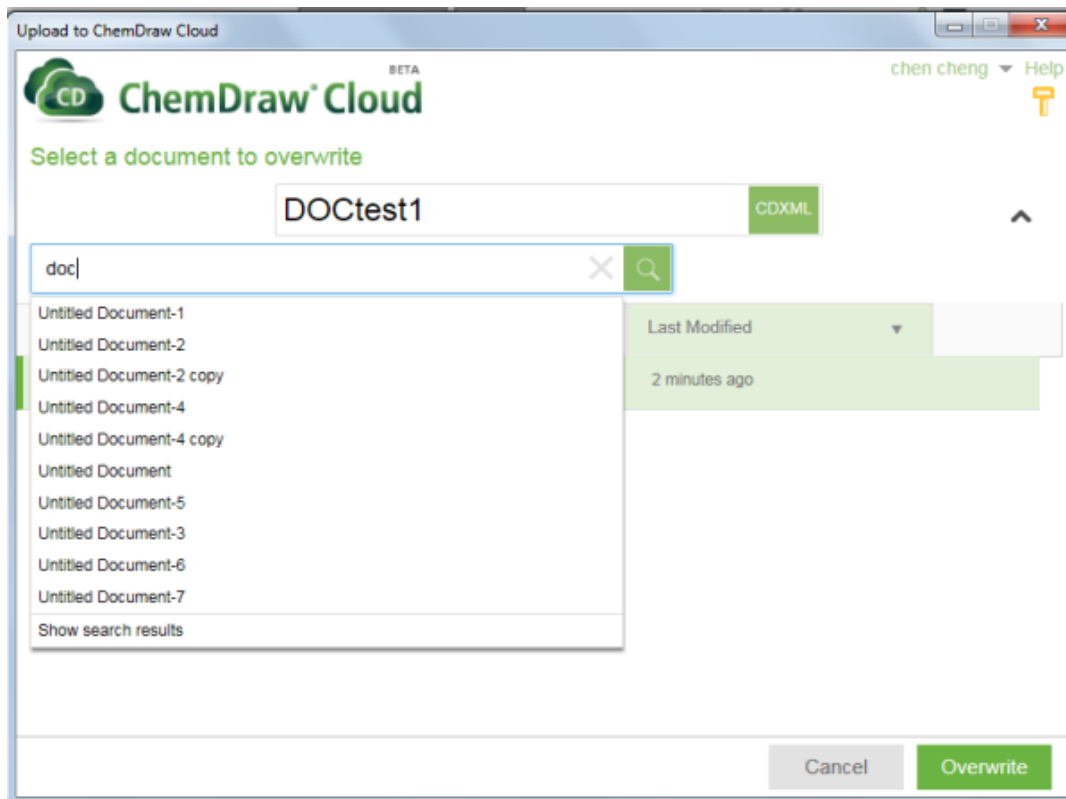

2. Click one of the items from the suggested list and click **Overwrite**. A confirmation message similar to the one in **Step 3** above appears.
3. Click **Overwrite**.

Browsing Documents in ChemDraw Cloud

To browse for documents in the ChemDraw Cloud:

1. Click **File > ChemDraw Cloud**, select **Browse...** and log in with valid account. The Browse ChemDraw Cloud page appears.

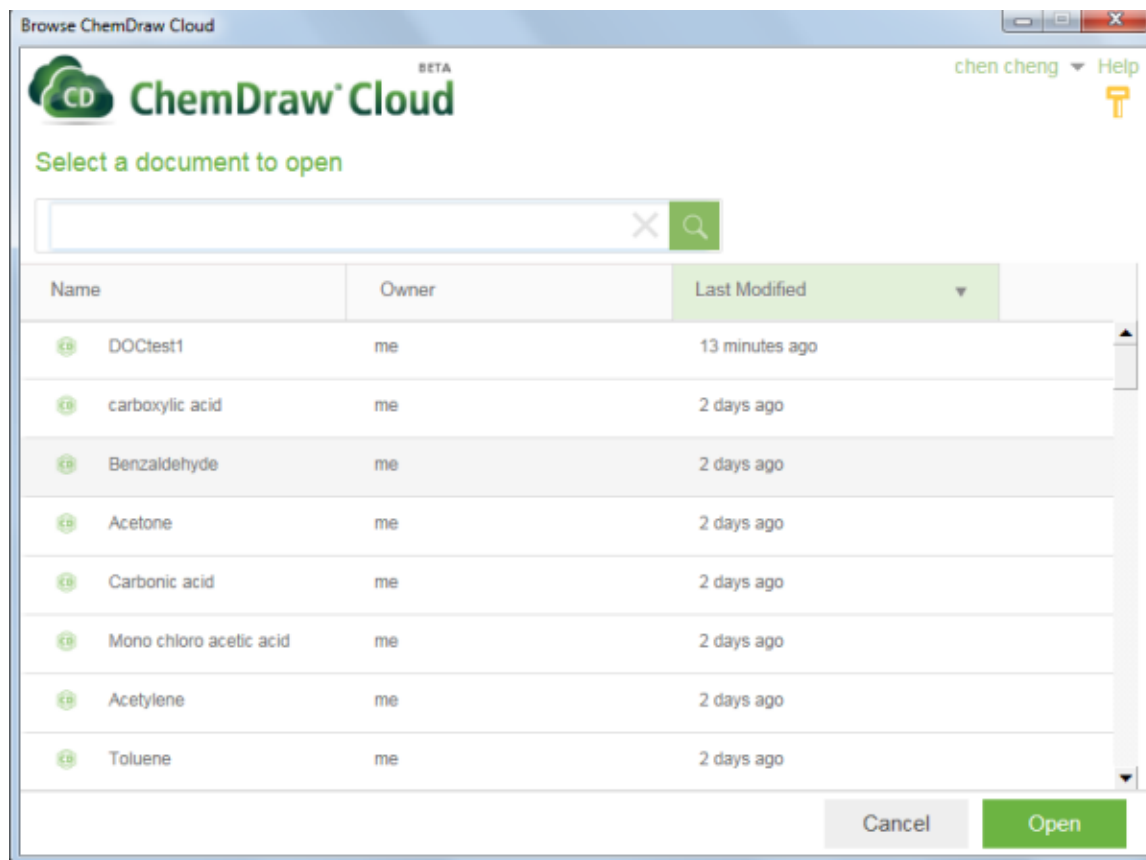

From this page you can:

- Open documents
- Sort documents
- Page through documents
- Search documents

Opening Documents

You can open a document in one of the following three ways:

- Click one row in the list, and then click the **Open** button.

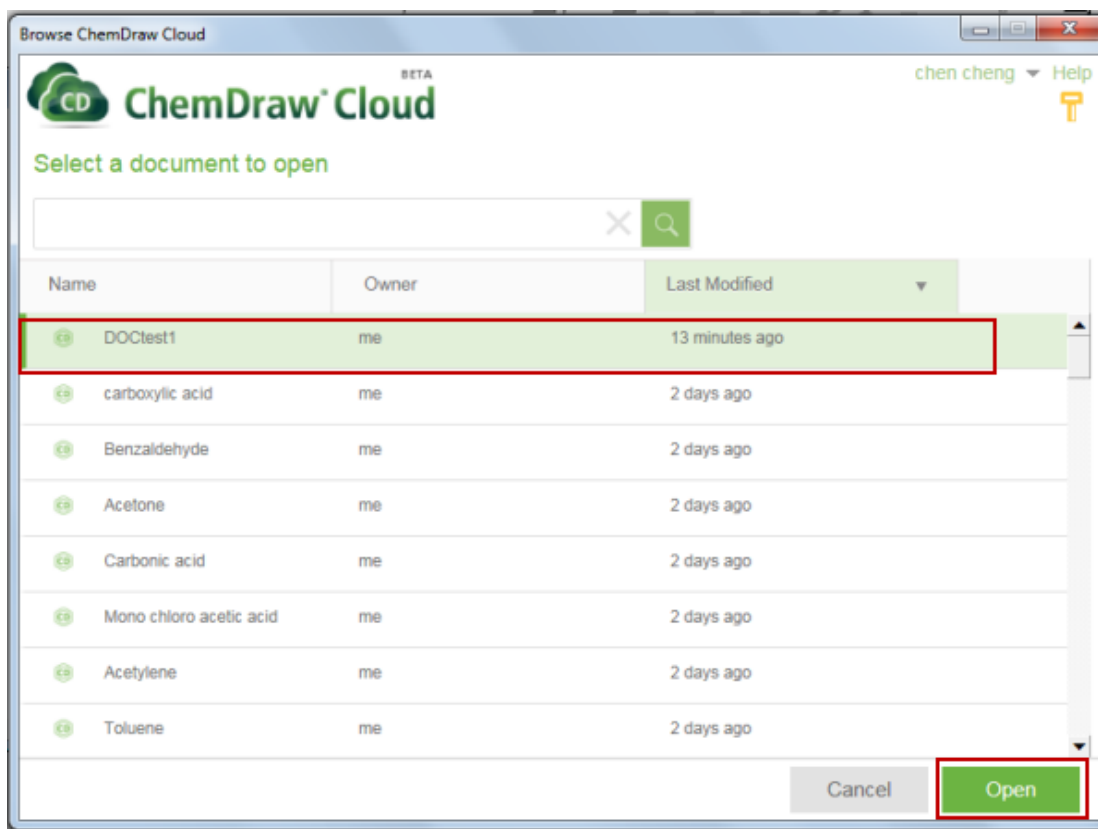

- Double click one row in the list.
- Type characters in the search box to open a dropdown list. Click one item from the list.

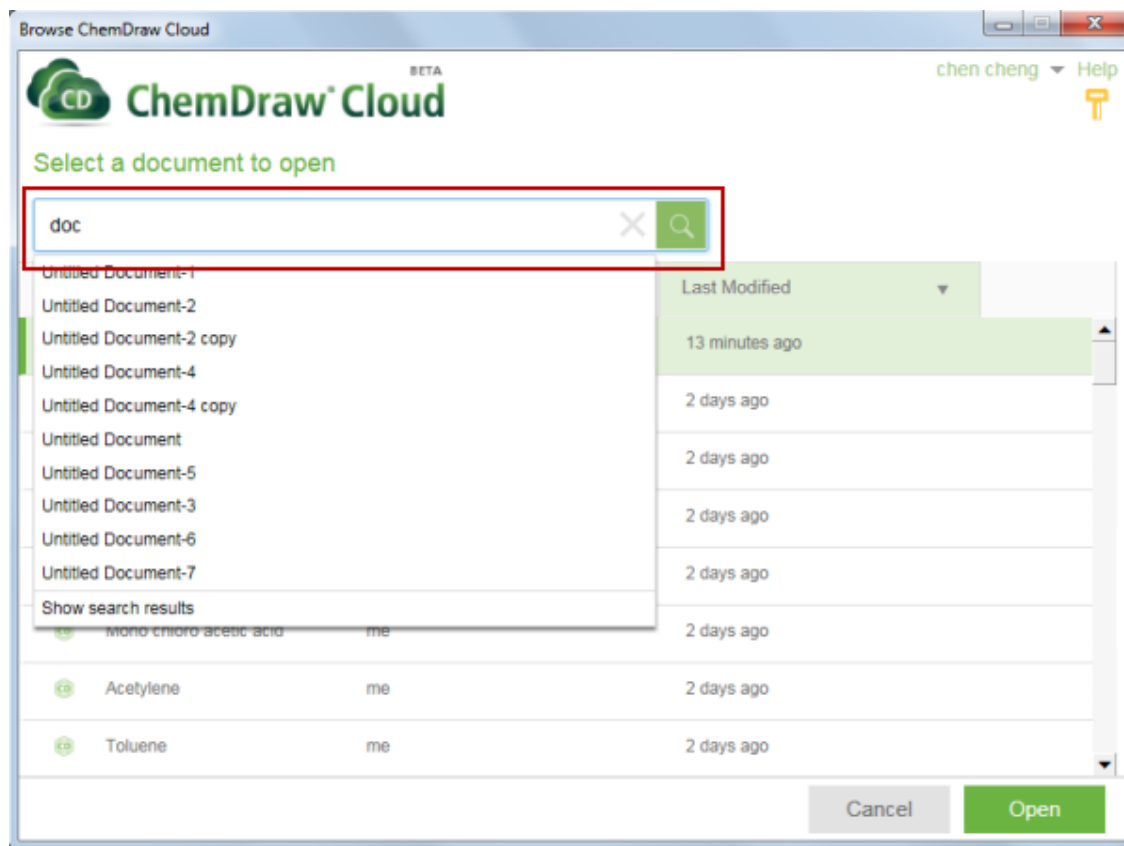

Sorting Documents

To sort documents, click on the desired header. The "Last Modified" header is sorted by default.

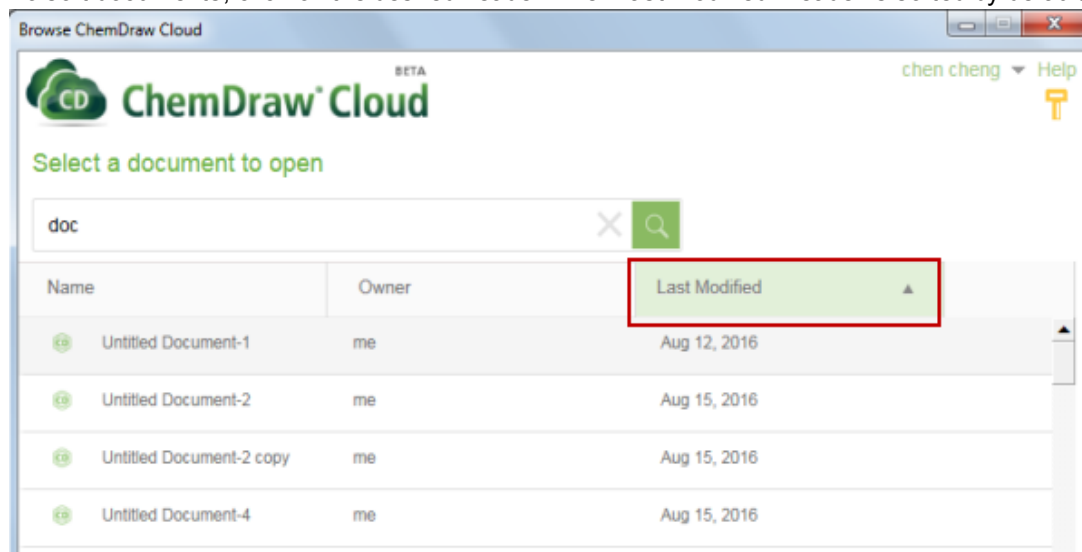

- The "Name" and "Owner" column sorts by ascendant at first click
- The "Last Modified" column sorts by descendant at first click.

Browsing Additional Records

The most recent records load by default. If you want to browse more records, use the scroll bars at the right.

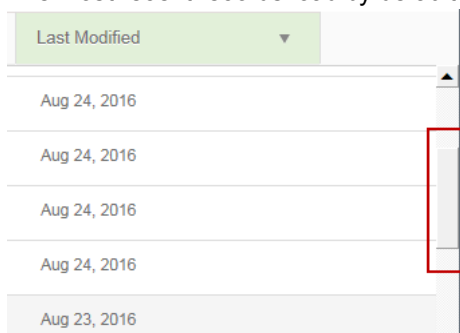

Searching Documents

You can search documents by typing some keywords in the search box. If you do not enter a search term, all records are displayed. There are three ways to trigger a search:

- Type some keywords in the search box, and then click the **Search** button.

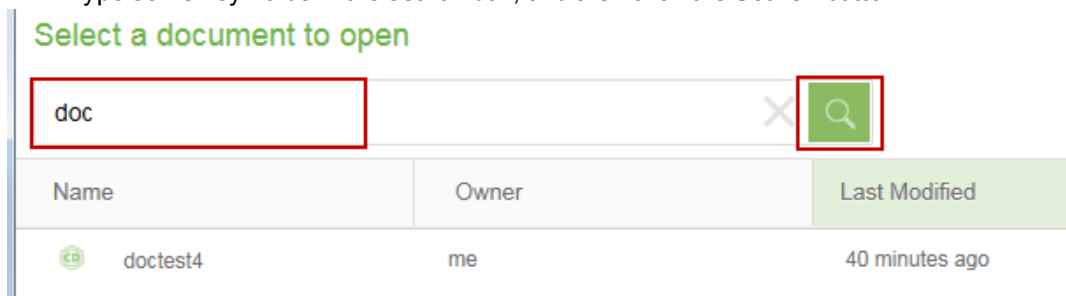

- Type some keywords in the search box, and then select "**Show search results**" from the dropdown list.

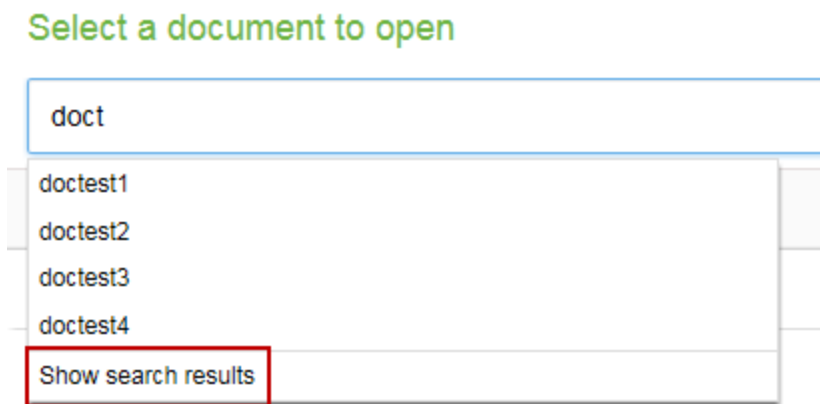

 **Note:** You must enter at least three characters in the search box to display the suggested search list.

- Simply type keywords in the search box, and press the **Enter** key.

 **Note:** After typing characters in the search box, an 'X' mark displays to the right. Click 'X' to clear the filter.

Select a document to open

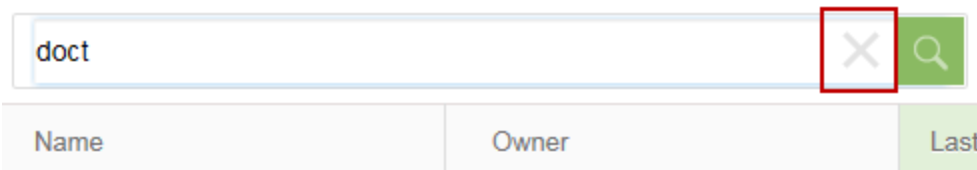

Name	Owner	Last
------	-------	------

What is ChemDraw E-Notebook?

ChemDraw E-Notebook is a cloud-based tool supporting design and recording of chemistry experiments. It will be available soon for the ChemOffice Professional users. ChemDraw E-Notebook and the desktop ChemDraw application can share chemDraw documents. ChemDraw E-Notebook is using HTML5 structure editor features of which and look and feel are aligned with the desktop version of ChemDraw.

 **Note:** ChemDraw E-Notebook application will be available soon to the ChemOffice Professional users.

Accessing ChemDraw E-Notebook

To access ChemDraw E-Notebook:

1. Click **Search>Browse ChemDraw E-Notebook**.

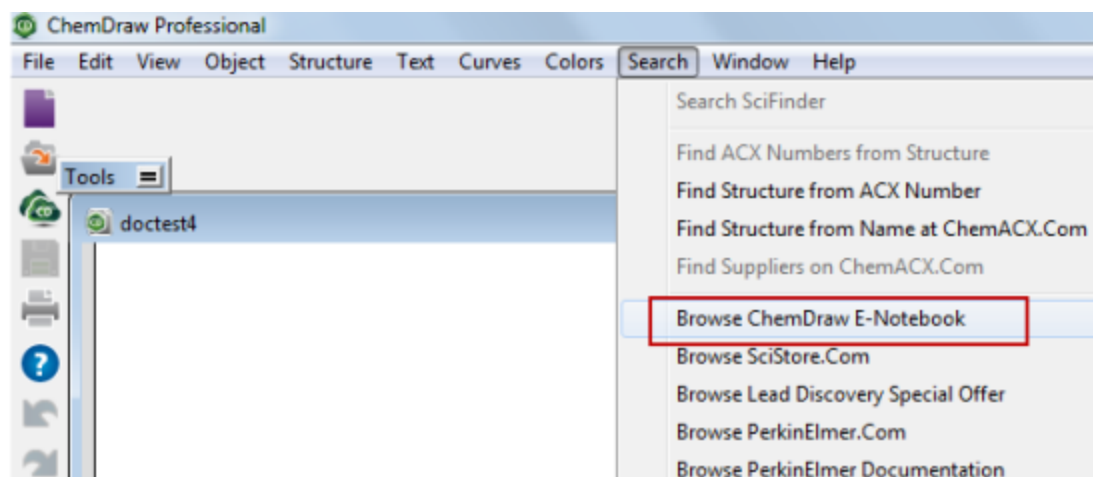

2. The Elements home page appears. Click **Login**.

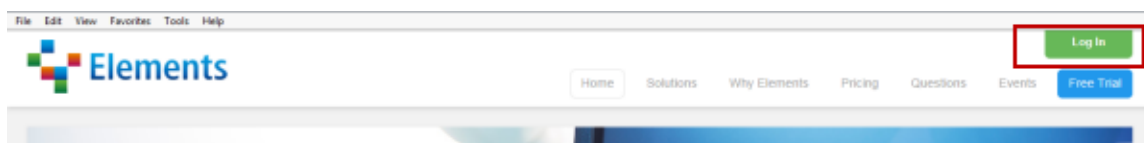

3. In the Login page, enter your **Username** and **Password** and click **Sign in**.

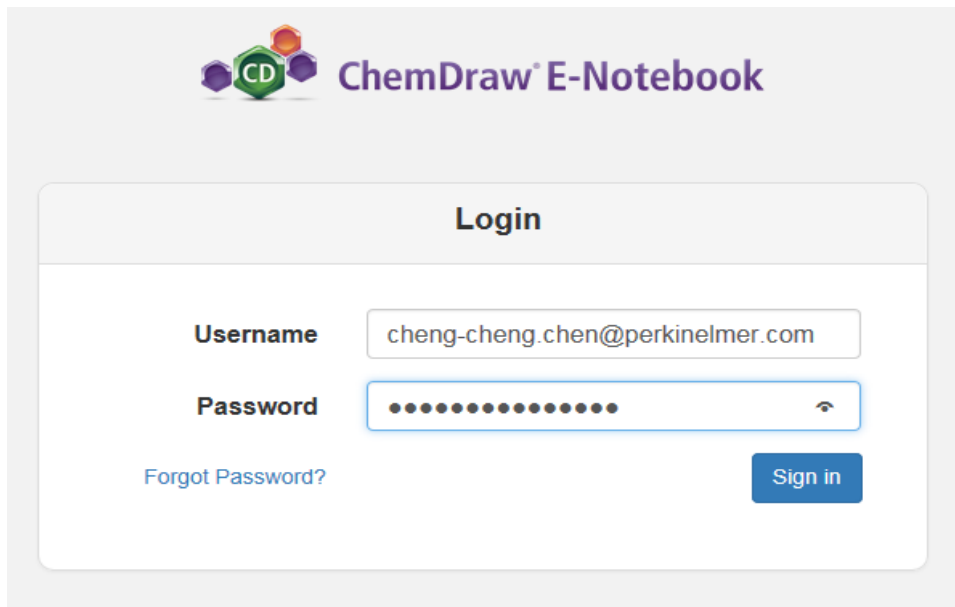

The screenshot shows the ChemDraw E-Notebook login interface. At the top left is the ChemDraw logo (a green hexagon with 'CD' and purple/orange shapes) and the text 'ChemDraw E-Notebook'. Below this is a 'Login' section with a white background and rounded corners. It contains two input fields: 'Username' with the value 'cheng-cheng.chen@perkinelmer.com' and 'Password' with masked characters. A 'Forgot Password?' link is located below the password field. A blue 'Sign in' button is positioned to the right of the password field.

Chemical Interpretation

ChemDraw converts lines, characters, and other symbols into chemically meaningful figures as you work. This occurs in the background, but you can also choose to view this chemical data. ChemDraw uses the data when exporting to file formats that support only a subset of the notations that ChemDraw does.

This section describes how ChemDraw interprets drawings.

Database Conventions

Most databases require not only that you draw a structure in a way that makes sense, but that you draw it in the way that the database expects it. Consider ferrocene, which is represented in at least four different ways in major databases:

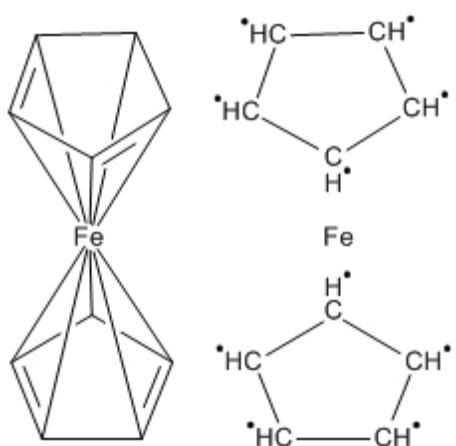
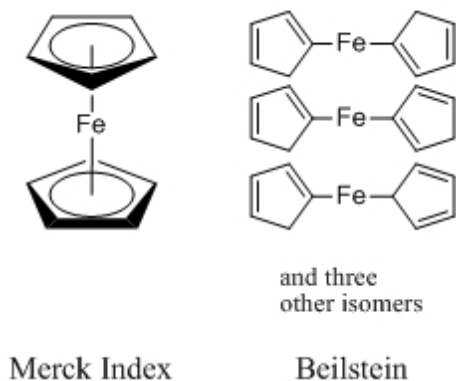













Figure 16.1: Representations of ferrocene

A successful search in one database might not produce results in another. When in doubt, consult the documentation for the conventions your database uses.

Bond Conventions

The following table describes the chemical conventions ChemDraw recognizes.

Bond	Description
	Single bond, unspecified stereo-chemistry.
	Single bond, "down" stereochemistry (into the plane of the paper, away from the viewer), from the first drawn atom to the second drawn atom.
	Single bond, "up" stereochemistry (out of the plane of the paper, toward the viewer), from the first drawn atom to the second drawn atom.
	Single bond, mixture of "up" and "down" stereochemistries in some unspecified proportion.
	Dative bond. Often used to indicate polar bonds, such as the N-O bond in pyridine N-oxide.
	Double bond, with cis/trans stereochemistry as drawn.
	Double bond, with cis/trans stereochemistry unknown.
	Tautomeric bond, either single or double according to rules of tautomerism.
	Aromatic bond, part of a delocalized resonance system.
	Triple bond.
	Quadruple Bond.

A single bond near a closed circle is recognized as aromatic:

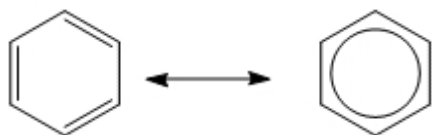

Atom Labels

A simple atom label may contain any of the following:

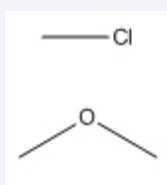

A single element.

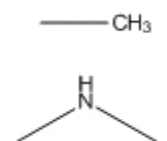

An element and some number of hydrogen atoms.

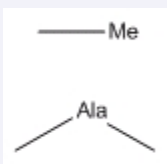

A nickname.



Repeating units within parentheses.



A series of any combination of the above.

ChemDraw analyzes atom labels from left to right, applying standard valence rules to determine which atoms are bonded together. The exception is with an atom label in Automatic alignment on the left side of a compound. This type of atom label is displayed in reverse (H_3CO instead of OCH_3) and is parsed from right to left. Standard valences for each atom are defined in the Isotopes Table.

By definition, a “simple” atom label has all bonds attached to the first (or last) character. A multi-attached atom label has bonds connected to more than one character, or has all of its bonds attached to a character in the middle of the atom label. Multi-attached atom labels are always parsed from beginning to end, but the beginning might be on the right if the atom label was in Automatic style and on the left side of the original structure:

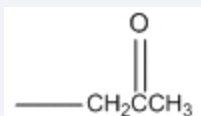

A multi-attached label that is parsed from left to right.

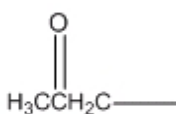

A multi-attached label that is parsed from right to left.

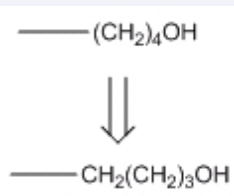

A bond attached to the open parenthesis of a repeating group is treated as if bonded to the first of those groups.

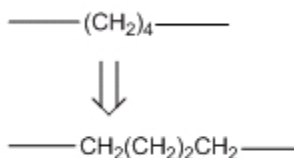

A bond attached to the close parenthesis or repeat count of a repeating group is treated as if bonded to the last of those groups.

Multiple fragments within a single label can be specified:



Implicitly, using standard valence rules.

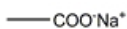

Explicitly, using a space, period (unsubscripted or unsubscripted), bullet, or combination.



An unsubscripted, unsubscripted integer at the start of a frag-

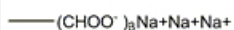

ment is recognized as a stoichiometric multiplier and is treated as if the appropriate number of fragments were drawn explicitly.

Chemically Significant Text

Often, it is simpler to write a chemical formula like MeOH or H₂O than to draw an atoms-and-bonds structure. ChemDraw interprets any *unambiguous* structural formula. For example, CH₃COCH₂CH₃ is recognized as methyl ethyl ketone and MeOH is recognized as methanol. On the other hand, C₆H₆ might mean benzene, or another isomer. Generally, empirical formulas (C₂H₆ and H₂SO₄) are not recognized, but structural formulas (CH₃CH₃ and HOSO₂OH) are.

Molecular weight and elemental analyses of empirical structures are possible, but the Expand Label command does not work with them. Empirical structures are discarded when they are transferred to other applications that require unambiguous structures.

Chemically-significant text must be entirely in formula or, for isotopes and charges, superscript style. ChemDraw does not recognize a chemical formula embedded within a larger block of text.



If you draw a bond, add an atom label, and then delete the bond, you have a chemically meaningful text block whose font, size, and style match other atom labels.



If you create a caption with the text tool and set it to Formula style, you have a chemically meaningful text block whose font, size, and style match other captions.

Charges

You can create charges as part of a atom label or with the appropriate symbol from the Chemical Symbols toolbar. Charges are always assigned to a specific element in the atom label, whose acceptable valences become those of the similar isoelectronic neutral element



A charge following an element is assigned to that element.

A charge that does not follow an element is assigned to the next element.

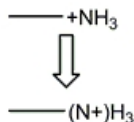

Charges that follow a monovalent element with a repeat count are assigned to the element before that element.

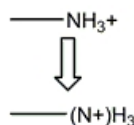

Charges that follow other repeating units are distributed among those units.

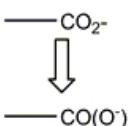

Charges may be superscripted.

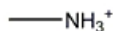

Multiple charges are recognized appropriately.

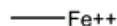

Charges may have repeat counts as long as both the charge and the repeat count are superscripted.



A “floating” charge placed with the Chemical Symbols Tool is assigned to the nearest atom. If no atom is within the distance set as the Fixed Length, the charge is ignored and not assigned to any atom.

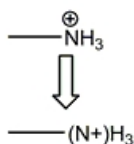

A “floating” charge placed within a delocalized system is recognized by the Analyze Structure function, but is discarded when saved to formats that require all charges to be associated with specific atoms.

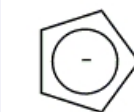

Isotopes and Elements

By default, all isotopes are recognized in the full Table of the Elements. This data is provided by CRC Press, Inc. Isotopes are defined in the Isotopes Table file. You can edit this file in any text editor to add new isotopes.



A super-scripted number before the element symbol indicates isotope numbers.

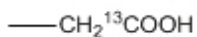

Isotopes can be included anywhere that regular elements can.

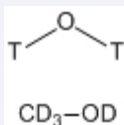

Deuterium and Tritium appear as one-letter symbols.

Radicals

Radicals are indicated with the appropriate symbol from the Chemical Symbols palette. As with charges, they are assigned to the nearest atom. Radicals always occupy one free valence, in addition to any charge effects. Two examples are:

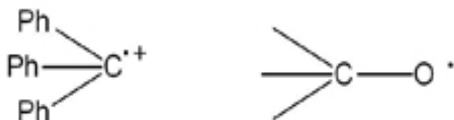

 **Note:** The lone pair symbol is interpreted as a diradical when it is placed next to an unlabeled carbon atom.

H-Dot/H-Dash

H-Dot and H-Dash symbols from the Chemical Symbols palette indicate the stereochemistry of a single hydrogen atom. These symbols are most common in fused systems, such as below:

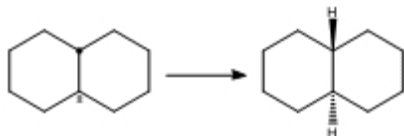

Complexes

Compounds with electron pairs can act as Lewis bases, bonding with Lewis acids that are electron-deficient. Similar behavior can be seen between lone pairs and metals.

The best representation of these types of interaction is with a dative bond from the electron-pair donor to the acceptor. Using a plain bond instead of the dative bond, will cause a valence error. The dative bond more accurately represents the electron donation.

Complexes may also be represented with explicit lone pairs and without any bonds.

If you use a simple bond to indicate a complex, you may want to set Abnormal Valence to **Allowed** in the Atom Properties dialog.

Multi-center Attachments

Multi-center attachments are meaningful only when created using **Structure>Add Multi-Center Attachment**. Multi-center attachments create a pseudo-atom that is disregarded during chemical calculations but still lets you create diagrams that look meaningful to an experienced chemist. A few examples are shown below:

η^3 or π -Allyl complex:



Ferrocene, a π -Aryl complex:

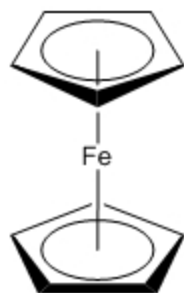

Cp_2TiCl_2 , another π -Aryl complex:

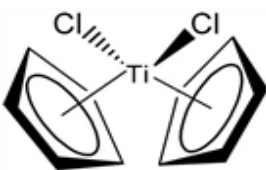

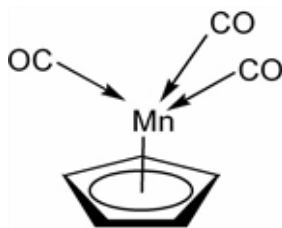
$\eta\text{-C}_5\text{H}_5\text{Mn}(\text{CO})_3$

Cahn-Ingold-Prelog

Absolute stereochemistry is calculated for tetrahedral atoms and double bonds according to the Cahn-Ingold-Prelog (CIP) priority rules.

The CIP rules are designed to order ligands by their priority and determine a descriptor based on the orientation of the ordered ligands in space.

A ligand is an entity attached to a stereocenter. For example, a tetrahedral carbon has four ligands corresponding to its four substituents. When a tetrahedral carbon is in a ring, it still has four ligands: the two ligands outside the ring, a third consisting of the ring “unpeeled” clockwise, and a fourth consisting of the ring “unpeeled” counterclockwise.

Five rules used to determine the priority of ligands are summarized below in simplified form. For more detailed information, see the references.

Rule 1. Higher atomic number precedes lower

Rule 2. Higher atomic mass precedes lower

Rule 3. *cis* precedes *trans*

Rule 4. Like pairs of descriptors precede unlike pairs

Rule 5. R precedes S

ChemDraw checks differences up to 15 atoms distant from the stereocenter.

Stereochemical Indicators

After the ligands are ranked, an indicator is assigned as shown in the following table.

Stereocenter	Indicator
Double bond	Z if the highest ranking ligand of each pair are on the same side of the bond; otherwise E.
Tetrahedral atom	When the lowest-ranking ligand is located behind the central atom: <ul style="list-style-type: none"> ▪ R when remaining 3 ligands are arranged clockwise in descending order ▪ S when remaining 3 ligands are arranged counterclockwise in descending order ▪ r or s is used for pseudo asymmetric atoms

Stereochemical Flags

While the chirality of a specific stereocenter can be indicated with the appropriate wedged, hashed, or plain bond, sometimes it is useful to indicate the relative stereochemistry of a molecule as a whole, considering the relationship between all stereo-centers. Stereochemical flags apply to the nearest structure; if no structure is within the distance specified by the Fixed Length value, the stereochemical flag is not assigned to any structure.

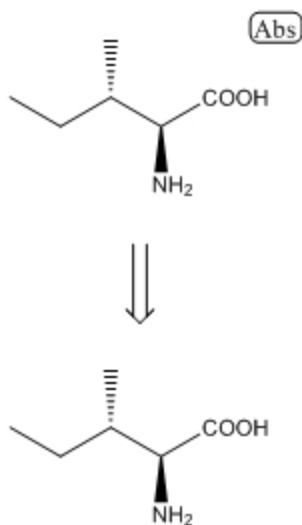

Figure 16.2: The Absolute flag indicates the exact stereoisomer as drawn.

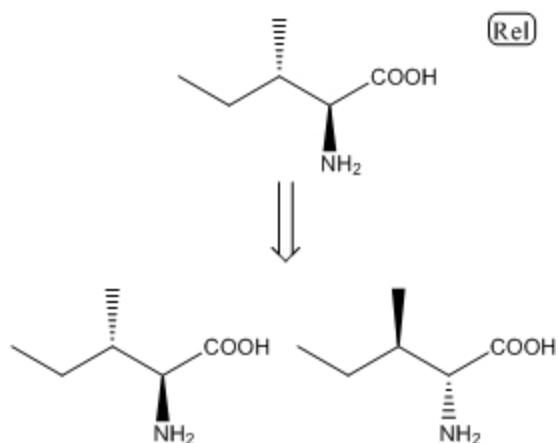

Figure 16.3: The relative flag indicates the exact stereoisomer as drawn, or its enantiomer.

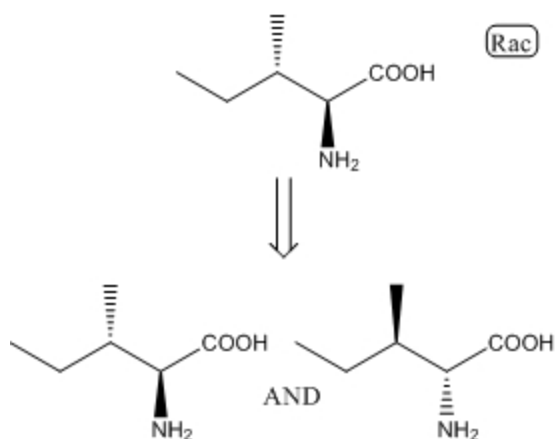

Figure 16.4: The racemic flag indicates a mixture of the exact stereoisomer as drawn and its enantiomer.

Polymer Representations

Polymers are represented by brackets used to enclose repeated structures or structural fragments. Bracket properties specify the orientation and context of the repeating units. For an explanation of the bracket properties, see "[Setting Bracket Properties](#)" on page 254.

References

"Graphic Representations (Chemical Formulae) of Macromolecules (Recommendations 1994)" *Pure Appl. Chem.*, 66, 2469-2482 (1994).

"Source-Based Nomenclature for Copolymers (Recommendations 1985)" *Pure Appl. Chem.*, 57, 1427-1440 (1985).

Also available at: <http://www.iupac.org/publications/books/pbook/PurpleBook-C7.pdf>.

"Basic Definitions of Terms Relating to Polymers (1974)" *Pure Appl. Chem.*, 40, 479-491 (1974) Also available at: <http://www.iupac.org/reports/1996/6812jenkins/index.html>.

Also see the Guide for the authors of papers and reports in polymer science and technology from IUPAC.

Analysis Messages

When a structure cannot be fully analyzed, two general types of messages are displayed:

- Status messages that report a problem that may not affect the final analysis
- Critical messages that may affect the final analysis

Message

There are too many bonds to this unlabeled Carbon.

Description

Displayed for every unlabeled atom with more than four filled valences. Filled valences include sum of bond orders, charge, radicals, and free sites. Aromatic bonds count 1.5 each, rounded down unless it is the only bond to

Message	Description
	the atom. Charge is signed and includes charge implied by dative bonds. The Substituents query property treats free sites, up to and exactly the same way: an atom with two explicit bonds and “Substituents: Up To 3” or “Substituents: Exactly 3” or “Substituents: Free Sites 1” has three filled valences.
<i>An atom in this label has an invalid valence.</i>	Displayed in cases where a place cannot be found to place a bond or a bond cannot be found to place an atom. Valid valences for each element are listed in the Isotopes Table file.
<i>ChemDraw can't interpret this label.</i>	Displayed when text is found that cannot be identified as an element, nickname, generic nickname, or alternative group name.
<i>Parentheses don't match.</i>	Displayed when parentheses cannot be matched into nested open-close pairs.
<i>This label has conflicting or unassignable charges.</i>	Displayed when a plus and minus charge have been assigned to the same element, charges have been assigned in more than one way, or a charge has been assigned to a nickname, generic nickname, or Alternative Group name.
<i>Formula cannot be computed for queries.</i>	Displayed for every label that contains a generic nickname, an element list or an alternative group. This is a status message only; analysis continues as if the problematic label were not selected.
<i>Text not in Formula style won't be interpreted.</i>	Displayed for the first caption that is not an atom label or Alternative Group name, and which contains any text not in Formula, Subscript, or Superscript style. This is a status message only, and appears only once regardless of how many captions are in the selection.
<i>This named alternative group contains no attachment point.</i>	Displayed for any structure within an Alternative Group Box where the structure lacks an attachment point. This is a status message only.
<i>This named alternative group contains fragments with inconsistent valences.</i>	Displayed for any Alternative Group Box whose contained structures have varying numbers of attachment points. Since all structures within an Alternative Group Box are to be used interchangeably, they must have the same number of attachments. This is a status message only.
<i>This named alternative group contains no fragment.</i>	Displayed for any Alternative Group Box that is empty. This is a status message only.
<i>Part of a molecule is outside of the</i>	Displayed for any Alternative Group Box whose border crosses part of a

Message	Description
<i>alternative group definition.</i>	structure. This is a status message only.
<i>This isolated bond is probably not intended to have chemical significance.</i>	Displayed for unlabeled single bonds unattached to other bonds. All bonds are interpreted chemically, usually as C ₂ H ₆ , and may cause unexpected results if intended as a graphical line only. This is a status message only.
<i>The atom is very close to another atom or bond.</i>	Displayed for any atom that is nearly touching another atom or bond but not bound to it. If a bond really was intended, the analysis of the structure produces incorrect results. This is a status message only.
<i>The stereocenter has no stereobonds specified.</i>	Displayed for any asymmetric center without attached wedged, hashed, dashed, or bold bonds. This is a status message only, and appears only when Show Stereochemistry is tuned on and there is at least one other wedged, hashed, dashed, or bold bond in the structure.
<i>There is a valence and charge error somewhere in this aromatic system.</i>	Displayed for any odd-membered ring drawn as a delocalized system (with a circle in the middle), where there is no corresponding associated charge. For example, a delocalized representation of cyclopentadiene must include either a negative charge or a multicenter attachment.
<i>The stereocenter has conflicting or ambiguous stereobonds specified.</i>	Displayed for any stereocenter (tetrahedral atom, asymmetric double bond, etc.) where the absolute stereochemistry cannot be determined from the structure as drawn. For example, this message would be shown for a carbon atom attached by bold bonds to four different ligands. This message is displayed only when Show Stereochemistry is also turned on.
<i>This label has an unrecognized isotopic mass.</i>	Displayed for every label that has a numeric superscript immediately preceding an atomic symbol, where the superscripted number does not correspond to a recognized isotope. For example, ²⁴ CH ₃ .

Property Calculations

You can calculate predicted values of selected physical and thermodynamic properties for structures of up to 200 heavy atoms. This section describes how the values are determined.

LogP

Three fragmentation methods are used to predict the logP values:

- **Method One:** Based on 94 atomic contributions evaluated from 830 molecules by least squares analysis. This method works with a standard deviation of 0.47 logP units and can handle molecules containing hydrogen, oxygen, nitrogen, sulfur, and halogens.
- **Method Two:** An extension of method one but is based on 120 atomic contributions evaluated from 893 molecules by least squares analysis. In addition to the atoms introduced for method one, it can handle molecules that contain phosphorus and selenium atoms. This method works with a standard deviation of 0.50 logP units.
- **Method Three:** Based on 222 atomic contributions calculated from 1868 molecules by least squares analysis. This method allows a calculation of logP with a standard deviation of 0.43 logP units and can handle molecules containing hydrogen, oxygen, nitrogen, sulfur, halogens, and phosphorus atoms. If this method is applied to molecules with internal hydrogen bonds, the standard deviation is 0.83 LogP units.

Henry's Law

Two methods are used to predict Henry's Law constant:

- **Method One:** An approach based on the bond contribution method, this method uses 59 bond contribution values and 15 correction factors. The contributions were calculated by least squares analysis using a data set of 345 chemicals. This method estimates with a mean error of 0.30 units and a standard deviation of 0.45 units, and can handle molecules containing carbon, hydrogen, oxygen, nitrogen, sulfur, phosphorus and, halogens.
- **Method Two:** Henry's Law constant is estimated from an equation found using linear regression. Multifunctional compounds were omitted from this study. This method should not be used for compounds where distant polar interaction is present.

Molar Refractivity

Two fragmentation methods are used to estimate the molar refractivity value:

- **Method One:** Includes 93 atomic contributions evaluated from 504 molecules by using a constrained least squares technique. This method works with a standard deviation 1.27 cm³/mol and can handle molecules containing hydrogen, oxygen, nitrogen, sulfur, and halogens.
- **Method Two:** Is an extension of method one that includes 120 atomic contributions evaluated from 538 molecules by using a constrained least squares analysis technique. In addition to the atoms introduced for method one, this method can handle molecules with phosphorus and selenium atoms. This method works with a standard deviation of 0.77 cm³/mol.

pKa, CLogP, and CMR

- Specific algorithms for calculating LogP and molar refractivity from fragment-based methods developed by the Medicinal Chemistry Project and BioByte. For more information, see <http://www.biobyte.com/blqsar/index.html>.
- LogP and CLogP estimate the Octanol/Water Partition Coefficient, but use different methods.
- CLogP and CMR are calculated as part of the Chemical Properties window. Several other sources exist for LogP data, however:
 - **The ChemDraw Report Window for LogP Prediction:** The Chemical Properties window shows averaged LogP and MR values. Via the "Report" button, you can see the original values from each applicable estimation method. The estimation methods are Crippen's fragmentation, Viswanadhan's fragmentation, and Broto's method.
 - **The ChemDraw Report Window for LogP Empirical Data:** For selected substances, the Chemical Properties window's **Report** button includes a section "Data from Database," which includes measured values of the partition coefficient and pKa values, at specified pH levels, with source citations.
 - **The ChemDraw ChemFinder Hotlink Window:** Several available databases include LogP and pKa information, including:
 - ChemSpider (from InChI link) predicts several variations of LogP and LogD
 - ChemINDEX (Physical Properties section, Environment Science Center database) includes empirical pKa and LogP data

ChemDraw/Excel

The ChemDraw add-in module in Microsoft Excel predicts:

- LogP (function CHEMPROPPRO_LOGP)
- CLogP (function CLOGP_DRIVER_PARTITION_COEFFICIENT)
- MR (function CHEMPROPPRO_MOL_REFRACTIVITY)
- CMR (function CLOGP_DRIVER_MOL_REFRACTIVITY)

ChemFinder/BioViz

The Property Populator predicts:

- LogP (server ChemPropPro, property LogP)
- CLogP (server CLogP driver, property Partition_Coefficient)
- MR (server ChemPropPro, property Mol Refractivity)
- CMR (server CLogP driver, property Mol Refractivity)

Chem3D

The Property Picker predicts:

- LogP (ChemPropPro LogP)
- CLogP (CLogP driver Partition Coefficient)
- MR (ChemPropPro Mol Refractivity)
- CMR (CLogP driver Mol Refractivity)

The Chem3D MOPAC Interface

Calculates the pKa of the most acidic hydrogen atom attached to an oxygen. For more information, see http://www.openmopac.net/pKa_table.html.

For more information, "ChemDraw/Excel Functions" on page 198, "LogP" on page 313, "Property Calculations" on page 313, and "pKa, CLogP, and CMR" on page 314.

Topological Polar Surface Area

The polar surface area of a molecule (measured in square angstroms) can be used to predict of pharmaceutical transport properties in the body. ChemDraw implements a more innovative algorithm. Historically, this property has been calculated using time-consuming 3D techniques. However, a recent paper provided a remarkably accurate way of predicting it rapidly.

Other Properties

Normal Boiling Point and Melting Point

Estimated in K using two methods:

- **Method One:** Joback's fragmentation method
- **Method Two:** Joback's fragmentation method as modified by Stein. All boiling points are estimated for a pressure of 1 atm.

Miscellaneous Properties

Heat of Formation, Gibbs Free Energy, Ideal Gas Thermal Capacity, Freezing Point, Critical Temperature, Critical Pressure, and Critical Volume are estimated using Joback's fragmentation method.

ChemDraw Web Resources

The PerkinElmer Informatics Web site is a valuable source of helpful information. You can:

- Register your software.
- Search for chemical information by name or ACX number; or, insert a structure into a worksheet.
- Get technical support, documentation, software downloads, and more.

You can navigate to the site directly from ChemDraw by selecting the appropriate option in the **Search** menu.

Registering Online

To activate any ChemOffice application, register with the PerkinElmer Informatics Web site to receive a registration code. Upon filling out a registration form, you will receive a registration code by e-mail (this does not apply to site licenses).

If your serial number is invalid or you do not have an Internet connection, contact PerkinElmer Informatics Support to receive a registration code.

You may use your ChemOffice applications a limited number of times while waiting for the registration process to finish. After you reach the limit, you must register the software.

In addition to registering your software, you can request literature, or register for limited free access to ChemFinder.com, ChemACX.com, and the e-mail edition of ChemNews. To register online, navigate to **Search>Register Online**. The user registration Web page opens in your browser.

User's Guide

The **Search** menu also lets you find current and previous versions of the documentation. To access the documentation page, navigate to **Search>Browse PerkinElmer Documentation**.

The Desktop >> Support Documentation Web page appears. Select the Manuals link.

 **Note:** If you do not have a PerkinElmer Informatics user account, you will first be directed to a sign-up page.

Technical Support

The **Search** menu link **Browse PerkinElmer Technical Support** opens the Technical Support Web page. Here you can find desktop support resources, including the PerkinElmer Informatics Knowledge Base, product downloads, FAQ, and documentation.

1. Navigate to **Search>Browse PerkinElmer Technical Support**. The Technical Support Web page opens.
2. Click **Desktop Support**.

Suppliers on ChemACX.com

ChemACX (Available Chemicals Exchange) provides a database of commercially available chemicals. The database contains catalogs from research and industrial chemical vendors.

To link to the ChemACX.com record of suppliers for compounds that you draw:

1. In ChemDraw, select a structure you have drawn.
2. Navigate to **Search>Find Suppliers on ChemACX.com**. The ChemACX.com page opens with information about the selected structure.

For more information on using the ChemACX Web site, see the *ChemOffice Enterprise Workgroup & Databases Guide*.

ACX Structures and Numbers

ChemDraw searches ACX and returns information about related structures and numbers. You can place the returned information in your document.

ACX Structures

There are two ways to find ACX structures, by ACX number or by name.

To find a structure by ACX number:

1. Navigate to **Search>Find Structure from ACX Number**. The Find Structure from ACX Number dialog appears.
2. Type the ACX registry number in the dialog.
3. Click **OK**. The structure appears in your document.

To find a structure by name:

1. Navigate to **Search>Find Structure from Name at ChemACX.com**. The Find Structure from Name dialog appears.
2. Type either a chemical name or trade name in the dialog.
3. Click **OK**. The structure appears in your document.

ACX Numbers

To Find an ACX number for a structure:

1. Select the structure.
2. Navigate to **Search>Find ACX Numbers from Structure**. The ACX number appears in the Find ACX Numbers from Structure dialog.

Chem3D ActiveX Control

The [Chem3D ActiveX Control](#) page provides Chem3D Plugin/ActiveX documentation for end users as well as administrators (web developers) who want to incorporate the controls within the Web pages.

SciStore.com

SciStore offers life science desktop software, enterprise solutions, chemical databases, and consulting services to biotechnology, pharmaceutical, and chemical industries. To visit SciStore, navigate to **Search>Browse SciStore.com**, or visit SciStore at www.scistore.com.

PerkinElmer Informatics

To open the PerkinElmer Informatics Home page, navigate to **Search>Browse PerkinElmer.com**. Check the PerkinElmer Informatics Web site for new product information. You can also visit ChemNews.Com, and other pages through PerkinElmer Informatics Home page.

Using the ChemOffice SDK

The ChemOffice Software Developer's Kit (SDK) lets you customize your applications.

To browse the ChemOffice SDK, navigate to **Search>Browse ChemOffice SDK**.

The ChemOffice SDK page contains documentation, sample code, and other resources for the Application Programming Interfaces (APIs).

Querying SciFinder[®] with ChemDraw (Professional Level)

SciFinder[®] is a research discovery application created by CAS (Chemical Abstract Services) that provides integrated access to the world's most comprehensive and authoritative source of references, substances, and reactions in chemistry and related sciences.

ChemDraw provides an interface to search SciFinder[®] with queries created on the desktop. Send a ChemDraw structure or reaction query to SciFinder[®] using one of the following methods:

- Click the SciFinder[®] icon on the main horizontal toolbar under menu bar. 
- Navigate to **Search > Search SciFinder**.

 **Note:** The SciFinder[®] icon and Search menu item will be grayed out unless the structure(s) being queried is selected.

The Search SciFinder dialog window opens. If you have selected a structure, or multiple structures, you will see the following window:

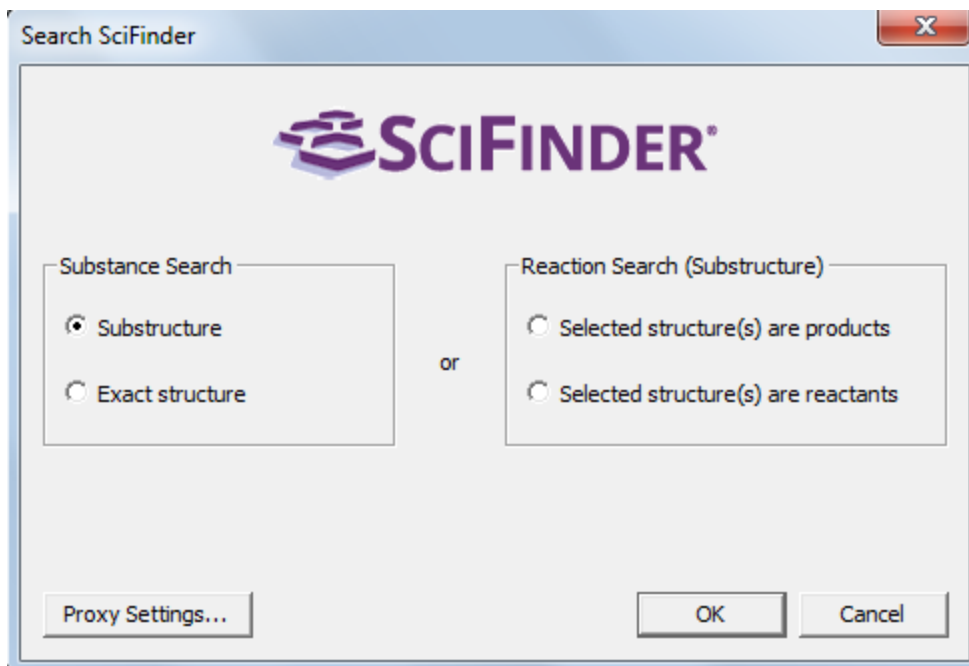

You can now choose whether you are interested in a substructure search or an exact search of the substances database, or, if you want to search the reaction database, whether selected structure(s) is a reactant or a product. All reaction searches are substructure searches.

If you have selected an entire reaction sequence, the following window will open to confirm your reaction search.

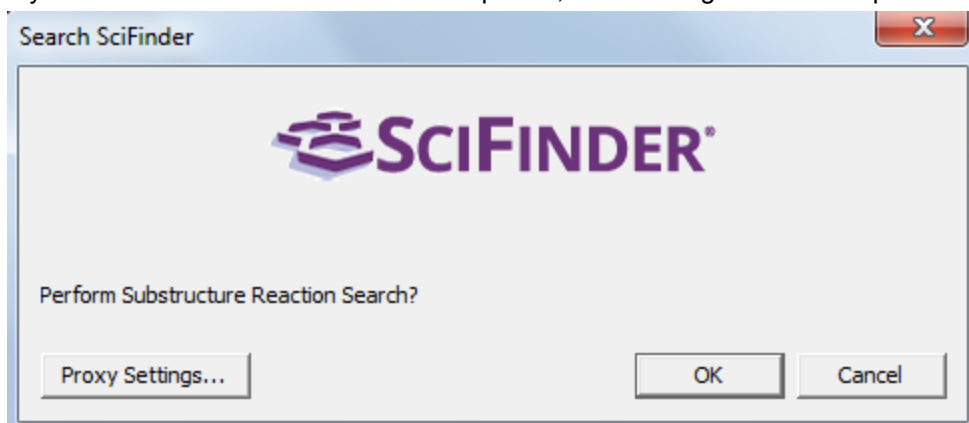

Press **OK** and SciFinder® will be launched to retrieve the results of your search and display them in a browser window.

If you submit a second or later search to SciFinder®, you will see an intermediate screen warning that you already have a SciFinder® answer set. To proceed with the latest search, click **OK**.

 **Note:** For a search to proceed, you must:

- Be connected to the Internet
- Have a valid SciFinder[®] individual subscription to access the database.

 **Note:** If your subscription is through a university and utilizes a proxy server to connect you to SciFinder[®], you must click the Proxy Settings button (Windows), or the arrow next to the Proxy server indicator line (Mac) and enter the proxy server URL for the account you are using. This will only be necessary for the first search you run.

- If you are not logged in or do not have a valid SciFinder[®] subscription, you will be redirected to the main SciFinder[®] page. There you can either log in or find information about how to subscribe. Some of the advanced structure query creation capabilities of ChemDraw cannot be fully interpreted by SciFinder[®]. When your query contains specifications that SciFinder[®] cannot handle, it will try to simplify and interpret them to the best of its ability, and will display a warning message. The interpreted search structure will be displayed in the SciFinder[®] sketcher for further manipulation as needed before starting the search. If the results obtained are not appropriate, please contact Customer Support at CAS, or PerkinElmer, and they will try to address the issue and/or propose an alternate query that might achieve the results you seek.

Some additional information about searching:

- If you select a molecule within a reaction, you can still specify a search of the substances database, rather than a search of the reaction database.
- You can select a portion of a molecule as your search entity. It will be treated just like an entire molecule for exact or substructure searching. If the selection consists of more than one fragment, these will be treated as independent moieties, all of which must be contained within the CAS record in order for it to be registered as a hit.
- Multi-step reactions or multiple reactions, in a single search, are not supported. Each step in the reaction sequence must be searched separately.

Tutorials

The tutorials illustrate fundamental drawing techniques. Each tutorial introduces new techniques, or variations of techniques from previous tutorials. We, therefore, suggest that you follow the tutorials in order.

Before you begin, review ["Conventions used in this Guide" on page 1](#) to familiarize yourself with the terminology. ChemDraw checks for correct chemical syntax as you draw. If there is an error, a red box appears around the erroneous object (the red box does not print). To disable the red box on a specific object, right-click the object and deselect **Display Warnings** on the context menu.

Tutorial 1: Drawing a Structure

In this tutorial, we explain how to draw this structure:

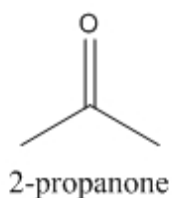

If you want the bond angles and lengths to be fixed, navigate to **Object>Fixed Lengths** and **Fixed Angles**. This ensures that bond lengths and bond angles are consistent throughout the structure.

 **Note:** The fixed length dimension is set in the Drawing tab of the Document Settings dialog. The fixed angle dimension increments angles by 15 degrees.

To create bonds:

1. Navigate to **View>Show Main Toolbar**.
2. On the Main toolbar, select the Solid Bond tool.
3. Click in the document window. A bond appears.
4. To add a second bond, click the right-end of the bond you just created.

The two bonds form a 120-degree angle.

 **Note:** The chain angle setting determines the angle between the two bonds. To change the chain angle, see ["Drawing Settings" on page 27](#).

5. To create a tertiary carbon, click the same place, as shown in step 4 above.

Changing Bond Order

To create the double bond, either hover over the center of the bond and type "2" or click on the bond.

Adding Atom Labels

1. Using the Text tool, click the end of the double-bond shown below. A text box appears at the end of the bond.

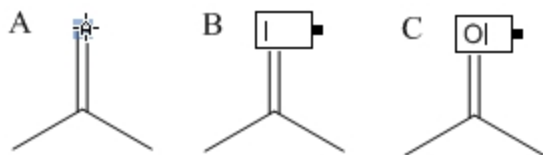

2. Type an uppercase **O** in the text box.
3. Press the <Esc> key on your keyboard to close the text box, or choosing another tool.
4. An alternative is hover over the atom at the end of the double bond and hit the "o" key. This is utilizing the Hotkey functionality of ChemDraw (see [Chapter 5 Shortcuts and Hotkeys](#)).

Adding Captions

To name the molecule:

1. Using the Text tool, click below and to the left of the structure. A text box appears.
2. In the text box, type "2-propanone".
3. Press the <Esc> key on your keyboard to close the text box, or choose another tool.

Tutorial 2: Drawing rings

In this tutorial you use rings to create this structure:

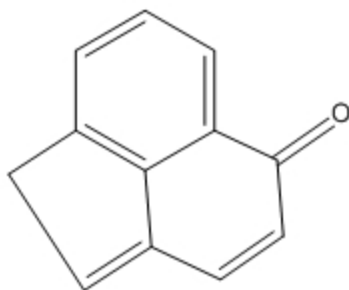

To create the ring system:

1. Using the Benzene tool, SHIFT-click in an empty area of the document.

 **Note:** Hold down the *SHIFT* key to change resonance structures when using the cyclopentadiene or benzene tools.

2. Point to the center of the lower right bond in the benzene ring.
3. Click to fuse another ring.

4. In the final structure, there is only one double bond in the second ring. To correct the current structure, hover the mouse over one of the double bonds in the second ring and type '1'. Do the same for the other double bond.

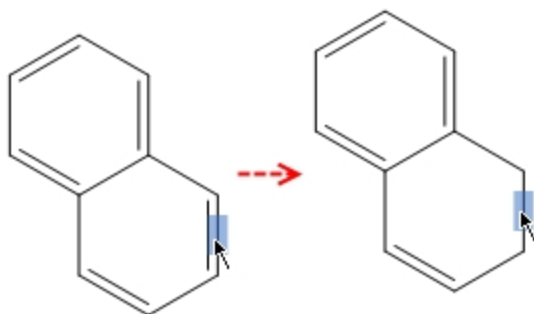
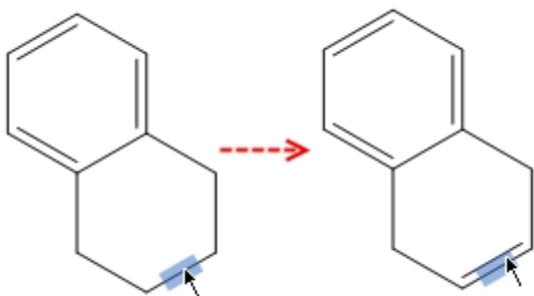
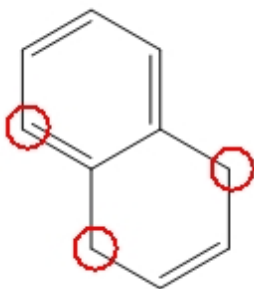

Figure 19.1: To change the bond order, type '1'.

5. To create the double bond in the second ring, either hover the mouse over the bond and type '2' or click it.



6. Using the bond tool, click the carbon atoms circled in the figure below. Three new bonds will appear.



7. Hover your mouse over one of the bond shown below and type '2'. Do the same for the other bond.

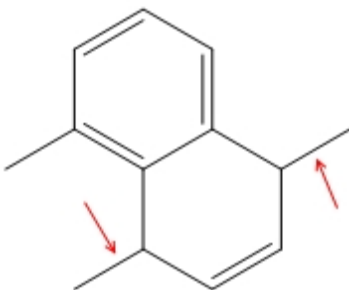

8. Hover the mouse over the right-most terminal carbon and type the letter 'o' to create the ketone functional group.

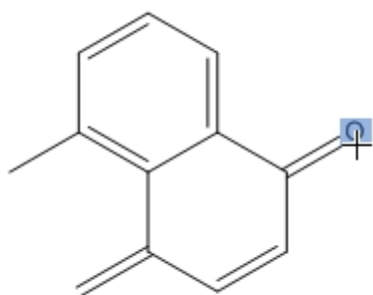

9. To connect the left terminal carbons, select the solid bond tool and click-drag a bond from one carbon to the other. The structure is complete.

Tutorial 3: Fischer projections

This tutorial demonstrates how to create a Fischer projection of glucose:

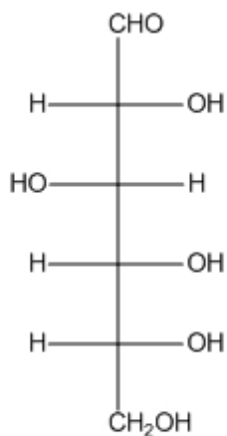

Chemical Formula: C₆H₁₂O₆

Exact Mass: 180.06

Molecular Weight: 180.16

m/z: 180.06 (100.0%), 181.07 (6.9%), 182.07 (1.4%)

Elemental Analysis: C, 40.00; H, 6.71; O, 53.29

Figure 19.2: Fischer projections

To draw the first bond:

1. Click the Solid Bond tool.
2. Point in the document window. Drag downward to draw the first bond.
3. Point to the lower atom, and drag downward again to draw the second bond.

The red wavy box appears because Show Chemical Warnings is selected. We will keep it selected for now.

4. Repeat step 3 there are five bonds.

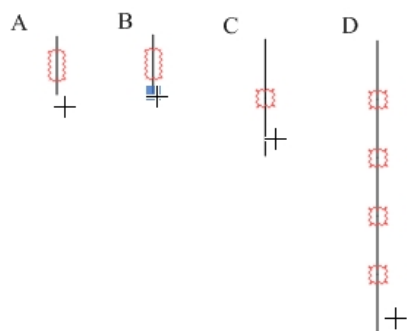



Figure 19.3: Drawing the backbone

 **Note:** When you drag the pointer along the length of the bonds, the pointer alternates between an arrow and a cross. The arrow indicates you are pointing over the center of a bond, and the cross indicates you are pointing to an atom.

Add horizontal bonds to the second atom in the string of bonds you created:

1. To add a horizontal bond, point to the uppermost Chemical Warning box and click it.

Note that the red wavy box disappears when you add a bond.

2. Click again to add a horizontal bond in the opposite direction.
3. Repeat steps 1 and 2 with each Chemical Warning box until all horizontal bonds are added.

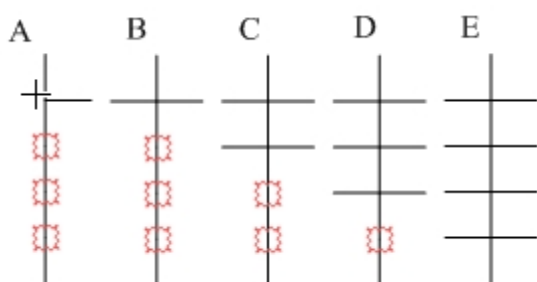

Figure 19.4: Adding horizontal bonds to the backbone

Add labels to the first and last carbon atoms:

1. Select the Text tool.
2. Click the uppermost carbon atom to create a text box, and type **CHO**.
3. Click the lower-most carbon atom, and type **CH₂OH**.

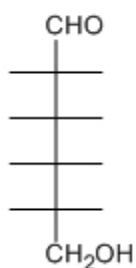

Figure 19.5: Adding atom labels

Add the repeating labels for the hydrogens and hydroxyl groups:

1. Click the atom shown in A below and type the letter **H**.

- Double-click each of the other atoms labeled as hydrogen in *B*.

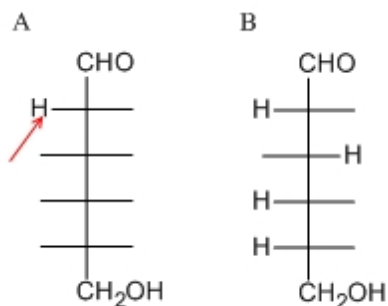

Figure 19.6: Adding repeating atom labels

✔ **Tip:** Double click an atom with the text tool to repeat the last label.

- Click one of the remaining atoms and type **O**.
- Double-click the remaining atoms to repeat the label.

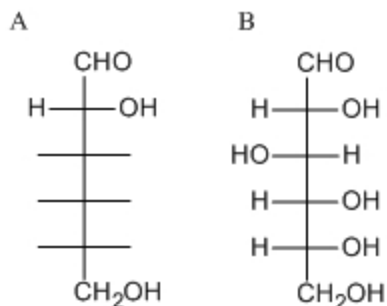

Figure 19.7: Completing the drawing

View the basic properties of the structure and paste the information into your document:

- Click a selection tool to select the last structure drawn. If the structure is not selected, double-click the structure.
- Go to **View>Show Analysis Window**.
- In the Analysis window, click **Paste**. The analysis information appears as a caption below the structure.

Tutorial 4: Perspective Drawings

In this tutorial, we explain how to create a perspective drawing by creating a model of α -D-glucose as a Haworth projection.

Create a new document using the default style:

- Go to **File>Open Style Sheets>New Document**.

 **Note:** If you are following the tutorials in order, ChemDraw will remember your last drawing used the ACS style sheet and open it as the default. This step resets the default to New Document.

Draw a ring:

- Click the Cyclohexane Ring tool.
- Click in an empty area of a document window. A cyclohexane ring appears.

Rotate the ring:

- Go to **Edit>Select All** (or type CTRL+A).
- Go to **Object>Rotate** (or type CTRL+R)
- In the Rotate Objects dialog box, enter 30 degrees for an angle and click **Rotate**. The cyclohexane ring rotates.

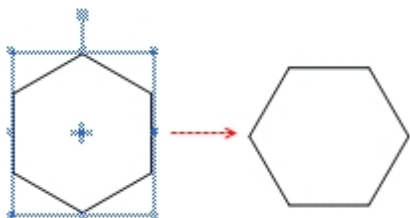

Change cyclohexane to tetrahydropyran:

- Click outside the structure to deselect it.
- Point to the atom in the figure below, and type the letter **o**.

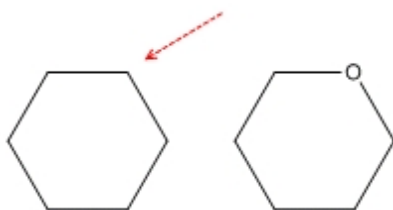

Resize horizontally:

- Go to **Edit>Select All** (or type CTRL+A).
- Using a selection tool, click-drag the right side handle to horizontally resize the ring. Release the mouse button when the ring is stretched about 200%.

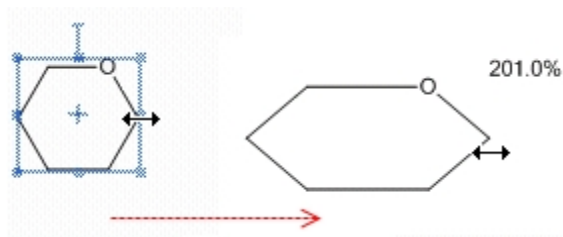

Enlarge the ring:

1. Go to **Edit>Select All** (or type CTRL+A).
2. Click-drag the ring corner adjustment handle to increase the size of the ring to 150%. A dialog box appears, asking you whether you want to scale the drawing and text settings.
3. Click **No**.

Add vertical bonds:

1. Click the Solid Bond tool.
2. Point to the atom shown in the figure below and drag upward to create a bond.



3. Point to the same atom, and drag downward to create another bond.
4. Repeat this procedure four more times, adding the pairs of vertical bonds shown below:

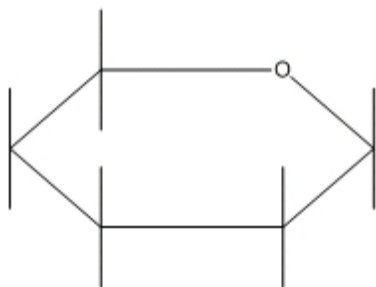

Create OH labels:

You can use the repeating bond label technique in Tutorial 4, or use hotkeys. For the Hotkey method, just point and type the letter "o". The Text tool method is repeated here, with a slight variation.

1. Select the Solid Bond tool, point to the atom shown in the figure below, and double-click to open a text box.

2. Type **OH**.

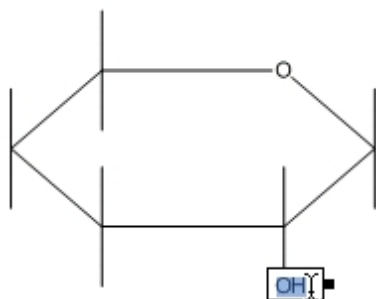
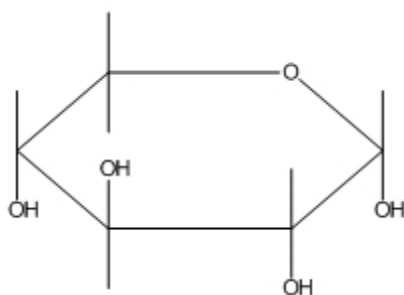



Figure 19.8: Adding the OH labels

3. Move the pointer to the other atoms as shown, and triple-click to repeat the atom label.



 **Tip:** If the drawing is too small to place the labels, go to **View > Magnify** to enlarge it.

Add the CH₂OH label:

1. Triple-click the upper atom of **C5**.
2. Press ENTER to open the atom label text box. Type CH₂ before the OH.

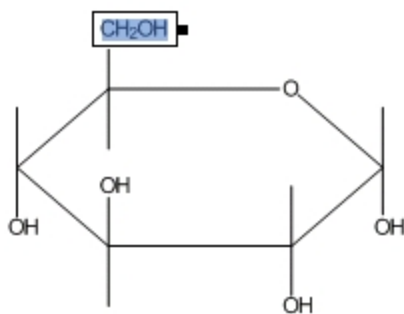

Change the type of the front bonds:

1. Click the Bold Bond tool.
2. Click the bond shown in the figure.

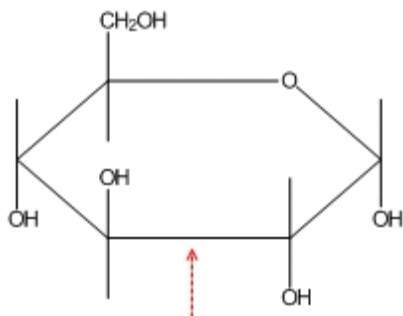

3. The cursor changes to a bold arrow as you point to the bond.
4. Click the Wedge bond tool.
5. Click each ring bond adjacent to the bold bond.

For each bond, point slightly off center in the direction that you want the wide end of the wedge to be oriented and click.

 **Tip:** If you move the pointer too far, the highlight box disappears. If placing the pointer is difficult, go to **View>Magnify**.

 **Note:** If the wedge is pointed in the wrong direction, click the bond again to flip its orientation.

The final structure is:

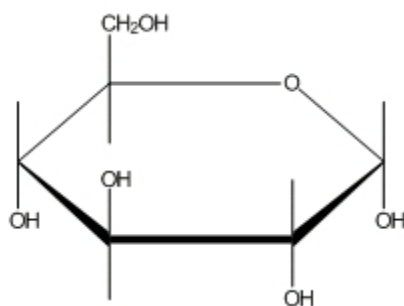

Tutorial 5: Newman projections

This tutorial demonstrates how to draw a Newman projection of ethane:

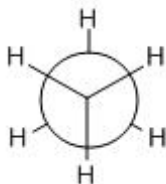

Draw ethane:

1. Click the Solid Bond tool.
2. In the document window, click-drag downward to create the first bond.
3. Click the atom at the bottom of the bond to add a second bond.
4. Click the bottom atom again to add a third bond.

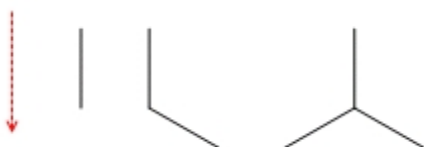

5. Hover the mouse over the end of each bond (without clicking) and type H to add the hydrogen atoms.

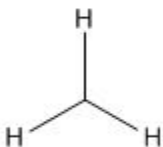

Duplicate the structure:

1. Click a selection tool. The last structure you drew is selected.
2. To create a duplicate, hold down the CTRL key while dragging the selection rectangle upward to the right of the original.

The selection box disappears while you are dragging.

Add a bond between the duplicated structures:

1. Click the Solid Bond tool.
2. Click and drag from the tertiary carbon atom of the lower fragment to the other tertiary carbon.

 **Note:** When connecting existing atoms, the Fixed Length and Fixed Angles commands are ignored.

When you release the mouse button, the ethane structure is complete. Now, create its Newman projection.

Drawing the Newman projection

In this step, you draw the hollow circle that is particular to Newman projections.

1. Click the Orbital tool, and select the **s (Open)** orbital.
2. Point to the left center carbon and click-drag outward.

The size of the orbital is constrained just as bonds are. The constraint is based on a percentage of the Fixed Length setting in the Drawing tab of the Document settings dialog box.

 **Note:** Orbitals are not automatically grouped with the structure. To group the orbital with the existing structure so you can move them together, go to **Object>Group**.

1. Click the Marquee tool. The orbital is selected. Click an empty space to deselect it.
2. Point above the structure and drag around the upper fragment to select the three bonds. Do not select the bond connecting the two fragments.

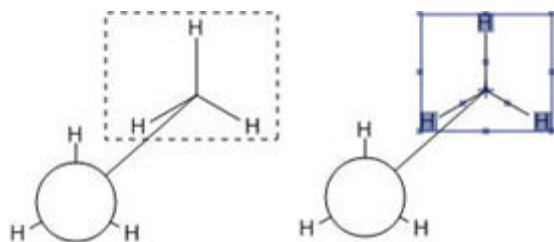

Rotate the selection:

1. Double-click the rotation handle to open the Rotate Objects dialog box.
2. Type 180 in the **Angle** text box and click **Rotate**.

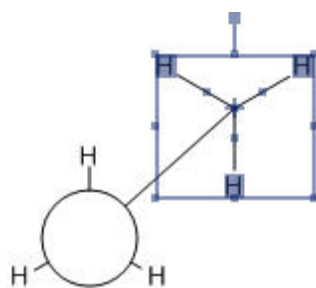



With the rotated bonds still selected, change the structure layering so that the selection is in front.

3. Go to **Object>Bring to Front** (there is no visible change when you do this).

Move the front part of the structure to create a Newman projection:

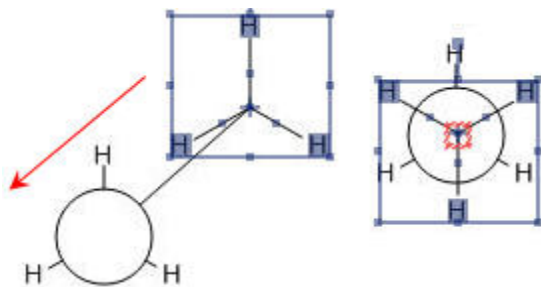
1. Point within the Selection Rectangle so the pointer changes to a hand.
2. Drag the selection until the tertiary carbon is centered within the orbital:



 **Note:** If chemical warnings are turned on, a red warning box appears when you overlay the structure, because the carbon atoms overlay the C-C bond. To turn off the chemical warning, deselect **Chemical Warnings** in the **View** menu. To disable this type of warning, go to **Preferences** and deselect **Atoms Near Other Bonds** in the **Warnings** tab.

3. Release the mouse button and click outside the Selection Rectangle to deselect the structure.

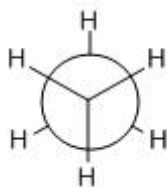

Tutorial 6: Stereochemistry

This tutorial demonstrates stereochemistry markers and the Flip command.

First, we draw this structure:

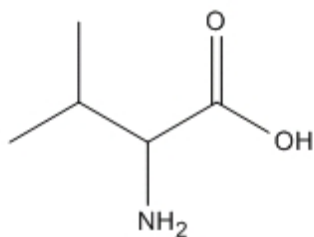

2-amino-3-methylbutanoic acid

To draw the structure:

1. Click the Solid Bond tool.
2. In the document window, click and drag downward to create the first bond.
3. Point at the lower atom and click to add a second bond.

4. Continue pointing at the same atom and click again to add a third bond.

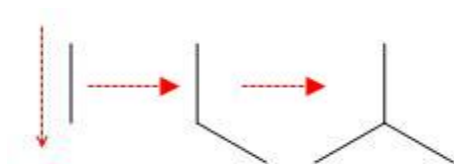

5. Point to the atom shown below and click twice to create two bonds.

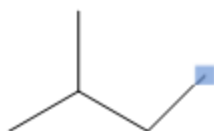

6. Pointing to the bond shown below, right-click, and select **Double>Plain** from the context menu.

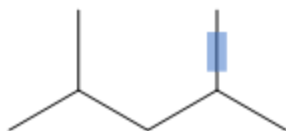

7. Click the Wedged Bond tool, point to the atom below, and then click.

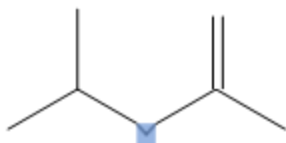

Adding atom labels

1. With the Text tool selected, click the atom shown below, and then type 'NH2' in the text box that appears.

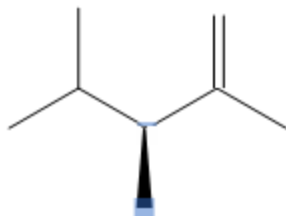

2. With the Text tool selected, click the atom shown below, and then type 'O' in the text box that appears.



3. With the Text tool selected, click the atom shown below, and then type 'OH' in the text box that appears.

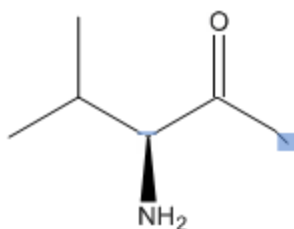

Displaying stereochemical markers

We now display the stereochemical markers, (R) and (S) for the two isomers.

To add the markers:

1. Select the entire structure with the Lasso or Marquee tool.
2. Go to **Object>Show Stereochemistry**. The S marker appears.

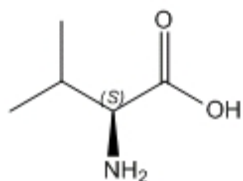

3. Select the structure and go to **Object>Flip Horizontal**. The R marker appears.

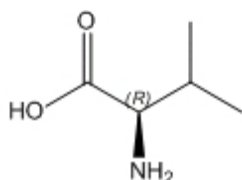

4. With the structure selected, go to **Object>Rotate 180° Vertical**. You can also use the object toolbar to rotate the structure.

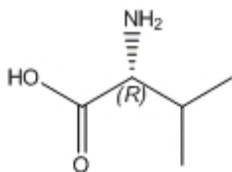

The Wedged bond becomes hashed and the (R) stereochemistry is preserved.

Tutorial 7: Templates

ChemDraw comes with an extensive template library of pre-drawn structures and images. You can use a template to either start a new drawing or to modify one that already exists.

In this tutorial, we use the phenanthrene template to create peroxydibenzene. The template and final drawing are shown below:

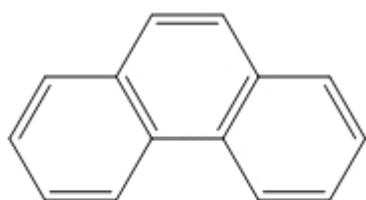

phenanthrene

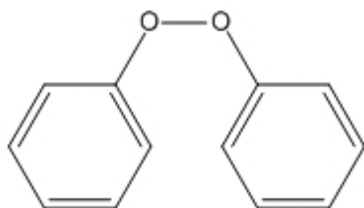

peroxydibenzene

To add the template for phenanthrene:

1. Go to **File>Open Style Sheets>New Document**.
2. In the Main toolbar, select the template tool. The list of template palettes appears.
3. In the Aromatics palette, select the phenanthrene template.
4. Click in the document window. Phenanthrene appears.

Now you must remove two bonds from the center ring of the structure and add two oxygen atoms.

To modify phenanthrene:

1. In the Main toolbar, select the Eraser tool.
2. Click the bottom bond in the center ring.
3. Click the double bond at the top of the ring. It is now a single bond.
4. In the Main toolbar, select the Text tool.
5. Select one of the carbon atoms in the hydrocarbon chain (what was the middle ring).
6. Type **O** to change it to an oxygen atom.
7. Select the other carbon atom and change it to an oxygen. Peroxydibenzene is now shown.