

Chemical Waste Piping Systems

Polypropylene (PP, FRPP) and
Polyvinylidene Fluoride (PVDF)



Table of Contents	1
Descriptions	2
1. Introduction	
Company and Brand Introduction.	3
Chemical Waste Piping Systems Introduction.	4
Installations.	5-6
2. Materials and Joining Methods	7
Materials Overview	7
Joining Methods Overview	8
The No-Hub/Rionfuse Advantage.	9
No-Hub System	10
Rionfuse Clamp-Free Electrofusion System.	11
Thermal Socket Fusion System	12
3. Design Data	13
Physical Properties	13
Maximum Service Temperatures	13
4. Product Dimensions	14
Pipe	14
No-Hub / Rionfuse Fittings and Couplings	15-24
Thermal Socket Fusion Fittings and Couplings	25-32
5. System Installation	33
Transportation, Delivery, and Storage	33
Above Ground Installation.	34
Underground Installation.	35
Temperature Effects on Hot and Cold Weather Installation	38
Testing Procedures	38
Repair Procedures	39
6. Floor Drain & Floor Cleanout Submittals.	40-44
7. Product Specifications	45
Blueline FRPP: Pipe, Fittings, Couplings/Joining.	45
Plenum+ PVDF: Pipe, Fittings, Couplings/Joining	45
8. Chemical Resistance Chart	46
9. Assembly Instructions	53
Rionfuse CF	
Polypropylene and PVDF Chemical Waste Systems	54-55
Orion Thermal Socket Fusion	
Polypropylene and PVDF Chemical Waste Systems	56-57
Orion No-Hub, Part 1: Grooving Pipe	
Polypropylene and PVDF Chemical Waste Systems	58
Orion No-Hub, Part 2: Joint Assembly	
Polypropylene and PVDF Chemical Waste Systems	59
Terms and Conditions	60



Chemical Waste Piping Systems

All data, information, formulas, recommendations and suggestions provided in this manual concerning the use of our products are based upon tests and data believed to be reliable. However, it is the user's responsibility to determine the suitability for his own use of the products described herein, based on the actual conditions of use. Since the actual use by others is beyond our control, no guarantee, expressed or implied, is made by Orion Fittings, Inc., as to the results to be obtained or to the

effects of such use, nor does Orion Fittings, Inc. assume any liability arising out of the use of the information herein. The information contained herein can not be construed to be absolutely complete since additional information may be necessary or desirable when exceptional or particular circumstances or conditions exist or because of applicable laws or government regulations.

Introducing Orion Fittings

Orion Fittings was the first company in North America to injection mold a complete line of polypropylene fittings. Since 1963, Orion corrosion resistant piping systems have been proven in thousands of educational, medical, industrial and research installations across North America and throughout the world. Over fifty years of innovation and experience have established Orion as an industry leader in providing the engineer, the contractor and the ultimate user with high quality corrosive waste drainage piping products that provide years of exceptional service.

In addition to a full range of product sizes, materials and joining options for chemical piping systems, Orion provides the necessary additional products for these specialized types of applications. Laboratory drains completely in PP and PVDF, or in combination with stainless steel upper assemblies; chemical waste

floor sinks; transition pieces for tie-in to existing piping systems – the range and depth of single-source options offered by Orion Fittings remains unmatched in the industry.

Orion chemical and corrosive waste piping systems give engineers, plumbing contractors and building owners peace of mind, through the manufacture of high quality and competitively priced pipe, fittings and accessories specifically designed and constructed from chemically resistant thermoplastic materials, stocked for quick delivery, and assembled using the fastest and easiest joining techniques available. The end result is reliable, verifiably-joined piping systems that meet code requirements, are installed easily and economically, and protect infrastructure investment from the harmful effects of corrosive waste.



Chemical Waste Piping

A Choice of Materials and Joining Systems

For engineers and contractors, Orion chemical drainage systems molded from polypropylene (PP), fire retardant polypropylene (FRPP), and Kynar® brand of polyvinylidene fluoride (PVDF) have been the chemical waste products they've specified and installed for years. Why? Because they know the cost of dependable Orion drainage systems can be far less than competitive corrosion resistant materials. And because they have a choice of materials and joining methods, it's easy to custom design systems to meet their particular needs. It's a choice that is unparalleled in the plumbing industry.

Orion offers the most complete line of fittings and pipe. This includes the widest assortment of sizes and drainage pattern molded geometries of any chemical waste piping system available today. Fittings are available in three different joining systems—socket fusion, No-Hub and Rionfuse Clamp Free electrofusion in two different materials: BlueLine FRPP or for extreme applications or where flame spread and smoke development are issues, Plenum Plus PVDF.

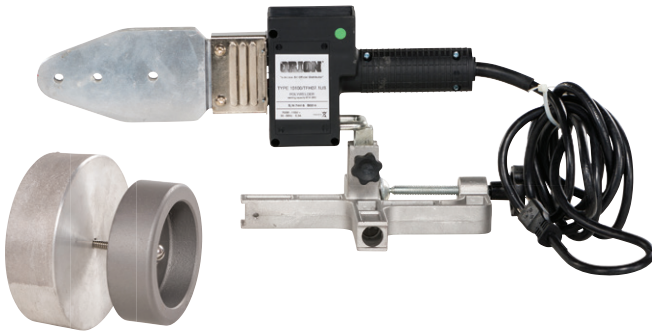

Socket Fusion Systems



Electrofusion Equipment



Floor Drains and Cleanouts



No-Hub Systems

Installations

Orion chemical piping systems have been specified and installed throughout North America and internationally for over fifty years. A list of representative installations is offered here.

Central Midwest Region

Abbott Laboratories, North Chicago, IL
 Bethany Hospital, Kansas City, KS
 Bismarck State College, Bismarck, ND
 Boeing-Engineering, Wichita, KS
 Davis Besse Nuclear Power Plant, Toledo, OH
 Draft Feeds, Huntington, IN
 Eastbrook Middle School, Marion, IN
 Kellogg Company, Kalamazoo, MI
 Kerr-Mcgee Tech Lab, Oklahoma, OK
 Loyola Med. Center-Cancer Research, Maywood, IL
 Mankato State University, Mankato, MN
 Michigan Bio-Tech Research Facility, E. Lansing, MI
 Oklahoma State Hospital, Oklahoma City, OK
 Parke Davis Pharmaceutical, Ann Arbor, MI
 Purdue University, Food Science Bldg., West Lafayette, IN
 Roudebush VA Medical Center, Indianapolis, IN
 SC Johnson Lab, Racine, WI
 St. Mary's Hospital, Minneapolis, MN
 Tony's Pizza, Salina, KS
 University of Michigan, Cancer & Geriatrics, Ann Arbor, MI
 University of South Dakota, Vermillion, SD

Eastern Region

Amherst Sewage Treatment Facility, Amherst, NY
 Binestone Water Treatment Plant, Hinton, WV
 Blue Ridge Community College, Charlottesville, VA
 Boston Globe, Boston, MA
 Brown University, Providence, RI
 Ciba Geigy, Summit, NJ
 Cornell University, Olin Hall, Ithaca, NY
 Danville Middle School, Danville, PA
 E.I. Dupont Experimental Station, Wilmington, DE
 Electro Optics Lab (Naval Research Center), Washington, D.C.
 Ford Motor Company, Edison, NJ
 Gardiner High School, Gardiner, ME
 Harvard University Medical Center, Cambridge, MA
 Harwood Mill Water Treatment Plant, Newport News, VA
 Loudon High School, Washington, D.C.
 Massachusetts Water Resource Authority, Boston, MA
 Molecular Biology Lab, Princeton, NJ

N.I.H., Bethesda, MD
 Pinkerton Academy, Derry, NH
 Princeton University, Frick Labs, Princeton, NJ
 Quabbin Regional School, Barre, VT
 Rockefeller Institute, New York City, NY
 Rockview Prison Hospital, Rockview, PA
 Rutgers University, Rutgers BioLabs, Piscataway, NJ
 Sloan Kettering Laboratory, New York City, NY
 Smith-Kline Beecham, Philadelphia, PA
 U.S.D.A. Center for Disease Control, Plum Island, NY
 Veterans Administration Medical Center, Clarksburg, WV
 Yale University, New Haven, CT

Western Region

Alta High School, Las Vegas, NV
 Berthoud Hall Lab, Colorado School of Mines
 Boyd Coffee, Portland, OR
 Colorado State University, Chemistry Building, Ft. Collins, CO
 DEA/Treasury Building, San Francisco, CA
 Denver Water Board – Marston Treatment Plant, Denver, CO
 Hewlett Packard, Santa Clara, CA
 Idaho State University, College of Pharmacy, Pocatello, ID
 La Cueva High School, Albuquerque, NM
 Metro Water Quality Lab, Seattle, WA
 Micro-Biological Laboratory-Dept. of Water Supply, Lihue, Kauai, HI
 Naval Environmental Laboratory Facilities, Pearl Harbor, HI
 Salk Institute, La Jolla, CA
 San Diego Police Department, Crime Lab, San Diego, CA
 Solar Research Institute, Golden, CO
 State of Hawaii, Dept. of Health Laboratory Facilities, Honolulu, HI
 Strategic Defense Facility, Sandia Base, NM
 University of California at Irvine, Nelson Research, Irvine, CA
 University of Wyoming, Decontamination Center, Laramie, WY
 USDA, Large Animal Isolation Facility, Laramie, WY
 Waste Water Treatment, Albuquerque, NM

Southern Region

Amaco Lab, Texas City, TX
 American Greeting Cards, Bardstown, KY
 Clemson University Chemistry Building, Clemson, SC
 Coca-Cola, Atlanta, GA
 Deer Valley High School, Glendale, AZ

Duke University, Clinical Science Building, Durham, NC
 E.I. Dupont, Research Triangle, NC
 Fairview Middle School, Fairview, TN
 General Electric Corp., Wilmington, NC
 Hermann Heart Institute, Houston, TX
 Hockaday School, Dallas, TX
 Hunters Lane High School, Nashville, TN
 IBM Research Facility, Charlotte, NC
 Kimberly-Clark, Atlanta, GA
 Louisiana State University Nursing School, Boyce, LA
 NASA Launch Facility, Cape Canaveral, FL
 North Carolina State, State University, Raleigh, NC
 Palo Alto College, San Antonio, TX
 Peoria Elementary School, Peoria, AZ
 Pepperidge Farm Labs, Lakeland, FL
 Providence Hospital, Charlotte, NC
 Providence Hospital, Columbia, SC
 Providence Hospital, Mobile, AL
 Rubbermaid Facility, Phoenix, AZ
 Smith-Kline Beecham Labs, Tampa, FL
 Spring Lite Bottling Co., Miami, FL
 Texas Instruments, Sherman, TX
 U.S. Army Ammunition Plant, Shreveport, LA
 Union Carbide, Inc., Research Triangle, NC
 University of South Carolina, Earth & Water Science Building, Columbia, SC
 Veterans Administration Hospital, Columbia, SC
 Wal-Mart Distribution Center, Brookhaven, MS
 Winn-Dixie Distribution Center, Montgomery, AL

International

American Embassy, Chittagong, Bangladesh
 AT&T Microelectric Manufacturing Facility, Madrid, Spain
 Carolina Area Hospital, Carolina, Puerto Rico
 Inter American University, Rio Piedras, Puerto Rico
 King Abdul Aziz University, Jedda, Saudi Arabia
 King Fahad Air Base, Taif, Saudi Arabia
 King Saud University, Riyadh, Saudi Arabia
 McCaw Labs, Sabana Grande, Puerto Rico
 Pepsi Cola Consolidated Lab, San Juan, Puerto Rico
 Smith Kline & French, Guayama, Puerto Rico
 U.S. Customs, San Juan, Puerto Rico

Canada

Canadian Forces Base Esquimalt, Victoria, BC
 Complexe Scientifique, Montreal, PQ
 ALS Laboratories, Vancouver, BC
 Queensway Carleton Hospital, Ottawa, ON

Industrial/Commercial Dominion Stores, Halifax, NS
 Laboratories Magnus Chemicals, Montreal, PQ
 Canadian General Electric, Bromont, PQ
 Culligan Industrial, St. Pierre, PQ
 Burroughs Welcome, Kirkland, ON
 St. Hilaire Sugar Refinery, St. Hilaire, PQ
 Gulf Canada, Quebec, PQ
 I.B.M. Canada, Bromont, PQ
 Warner Lambert Pharmaceuticals, Scarborough, ON
 Syntex Pharmaceuticals, Mississauga, ON
 Green Shield, Windsor, ON
 N.R.C., Ottawa, ON
 INCO Research Centre, Clarkson, ON
 Doulton China, Toronto, ON
 Glaxo Canada, Toronto, ON
 DuPont of Canada Ltd, Kingston, ON
 General Motors, Oshawa, ON
 Amway, London, ON
 IPSCO Research Centre, Regina, SK
 Husky Oil, Lloydminster, AB
 Molson Brewery, Regina, SK
 Hospitals Queen Elizabeth Hospital, Charlottetown, PEI
 Victoria General Hospital, Halifax, NS
 Hopital St Luc, Montreal, PQ
 Hopital St Justine, Montreal, PQ
 Princess Margaret Hospital, Toronto, ON
 Hospital for Sick Children, Toronto, ON
 Kingston General Hospital, Kingston, ON
 Edmonton General Hospital, Edmonton, AB
 Castlegar Hospital, Castlegar, BC
 Universities Dalhousie University, Halifax, NS
 University de Montreal, Montreal, PQ
 College de Jesuits, Quebec, PQ
 Carleton University, Ottawa, ON
 Queens University, Kingston, ON
 University of Ottawa, Ottawa, ON
 University of Toronto, Toronto, ON
 York University, Toronto, ON
 University of Guelph, Guelph, ON
 University of Western Ontario, London, ON
 University of Waterloo, Waterloo, ON
 University of Alberta, Edmonton, AL
 Simon Fraser University, Vancouver, BC

The Complete Solution for Chemical Drainage

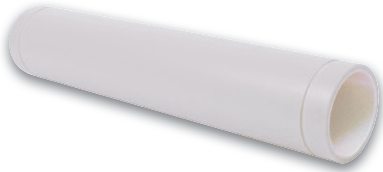

Plenum Plus PVDF

PVDF is one of the most chemically resistant thermoplastics available.

It offers superior chemical resistance to many solvents, acids, bases and halogens. In general, PVDF is resistant to more chemicals and combinations of chemicals, in higher concentrations, and over a broader temperature range than polypropylene.

The Kynar® brand PVDF formulation used by Orion has been certified to meet ASTM E-84 and UL 723 standards for flame spread and smoke generation. The certification means that PVDF piping systems can be used safely in areas such as return air plenums.

PVDF is able to maintain much of its strength and chemical resistance within a broad temperature range of -40°F to 285°F.

In Return Air Plenums

Orion Plenum Plus PVDF

(polyvinylidene fluoride)

- UL-certified to ASTM E84/UL 723 for <25/50 flame spread and smoke values. (PVDF chemical waste systems are the ONLY plastic chemical waste piping systems that meet US standards requirements of ASTM E84 and testing requirements of UL 723 as written, without modification of test procedures or using additional insulation and wrapping.)

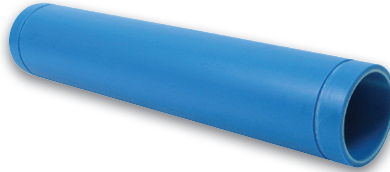

Blueline FRPP

All Orion joining systems are available molded from Blueline FRPP resin.

Blueline FRPP (an Orion trade name) is a fire retardant, thermoplastic material with excellent resistance to most common organic and mineral acids, their salts, strong and weak alkalis, and most organic chemicals.

Blueline FRPP is compounded of polypropylene Type II copolymer with fire retardant additives. Polypropylene is a polyolefin thermoplastic material characterized by a stable and highly ordered stereoregular molecular chain. This structure produces a rigid material with good strength and aging properties.

Blueline FRPP qualifies for Underwriters Laboratory certification of V-2 when tested under UL Subject 94 in thickness of .150 and over. Based on the parameters of ASTM D635, Blueline FRPP also meets established industry criteria for self-extinguishing. Blueline FRPP is not suitable for use in return air plenums.

In the Laboratory

Orion Blueline FRPP

(fire retardant polypropylene)

- Pipe and fittings certified to UPC and CAN/CSA B181.3 requirements.
- Easy transition to Plenum Plus PVDF for return air plenums.

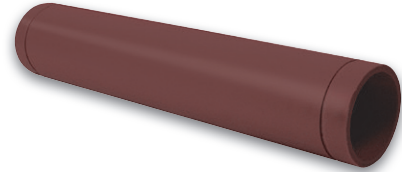

Brownline

Brownline pipe offers all the advantages of Blueline FRPP in installations where non-fire retardant materials are acceptable.

Underground

Orion Brownline PP

(non-fire retardant polypropylene)

- Realize cost savings using the economical non-fire retardant Brownline PP pipe underground.
- Use with Blueline fittings.

Two Fitting Styles, Three Joining Methods

Orion provides three joining methods: No-Hub, Electrofusion, and Socket Fusion for use with three types of chemically resistant pipe.



No-Hub Mechanical Joint

The No-Hub chemical waste mechanical joint drainage system is economical and easy to install.

- Fast and easy installation
- All fittings pre-grooved at factory
- Requires no heat or hot water
- Easily assembled with ordinary hand tools
- Easy to clean and maintain
- Stainless steel outer coupling
- No metal in joint
- Suitable for below ground applications
- Available in 1½" - 6" sizes



Electrofusion

The Rionfuser CF clamp-free electrofusion joining system provides unsurpassed ease of installation and joint strength for chemical waste drainage piping. Its electrofusion coil is molded into the coupling.

- Requires no clamps
- Removable pipe stop allows coupling to be used as a slider for tight installations
- Multiple joining capabilities and both sides of couplings fuse at the same time
- Positive joints made in just a few minutes
- Uses same grooved end fittings as Orion No-Hub system
- Easily assembled with Rionfuser electrofusion machine
- Can be used with polypropylene and PVDF to provide excellent resistance to a wide variety of chemicals and acids
- Available in 1½" - 14" sizes



Socket Fusion

Socket fusion type pipe and fittings for use with chemical waste are joined by heat fusing the polypropylene or polyvinylidene fluoride material with an Orion thermostatically controlled heat tool. In a semi-molten state, pipe and fittings are easily joined to form a strong, permanent sealed joint.

- No metal in joint
- Suitable for below-ground applications
- Homogeneous piping system
- Hermetically sealed joints
- Ideal for severe use applications
- Available in 1½" - 6" sizes

Joining Method Selection Guide

CRITERIA	NO-HUB	RIONFUSE	SOCKET FUSION
Underground	✓	✓	✓
Aboveground	✓	✓	✓
Tamperproof		✓	✓
Thermal Expansion		✓	✓
Reconfigurable	✓		
Permanent Connection		✓	✓
Tight Installation Spaces		✓	
Short Learning Curve	✓	✓	
Material Transitioning	✓		

Orion No-Hub or Rionfuse CF (patent pending)

Both systems use the SAME No-Hub Fittings



NO-HUB BENEFITS

- Easy fitting-to-fitting connections (no pipe in between)
- Time tested and proven No-Hub design
- Quick and easy installation and reliable performance
- Available for both Polypropylene and PVDF systems
- PP and PVDF are easily interchangeable, allows for easy transition between piping materials
- Fittings can easily be disassembled and reassembled
Ideal for system modifications
- Easy assembly with ordinary hand tools
- High resistance to lateral loading, making No-Hub excellent for buried applications

RIONFUSE CF BENEFITS

- No clamps required
- Strongest joint in the industry
- Proven joint design (similar to gas fittings)
- Multiple joint capabilities
- Removable pipe stop allows coupling to be used as "slider" for tie-ins
- Coil is integral to joint
- Continuous coil throughout coupling - both sides fuse at the same time saving installation time.
- Available in Polypropylene and PVDF

Same No-Hub Fitting using your choice of joining method



Proven No-Hub Design

- No need for 2 fitting inventories
- Same fitting lay lengths - regardless of joining type ie: same system design for both joining methods
- Easy transition from No-Hub to Rionfuse CF
- Same system can be used above and below ground



Strongest Electrofusion Joint Available

No-Hub Joining Systems



No-Hub Joining Systems

Orion is recognized as an industry leader in the manufacture of economical, easy-to-install No-Hub chemical drainage systems. Our No-Hub coupling requires only standard hand tools to tighten, plus a manual pipe-grooving tool to prepare cut pipe ends for joining. The simplified design and installation method makes Orion No-Hub couplings ideal for under-counter assembly. If piping system additions or modifications are anticipated, the No-Hub design allows for easy disassembly and reconfiguration. No-Hub couplings are the ideal solution for piping system designs that include transition from one material to another. The strength and security of our stainless steel outer band combined with the chemical resistance and no wetted metal surfaces of the inner coupling body result in a joining system that is durable, versatile, and economical to install.

Check the many other features of the No-Hub drainage system. You'll see why it has become a favorite of engineers and contractors in hundreds of installations in the United States, Canada and Puerto Rico.

Features

- Fast and easy installation means lower labor cost
- All fittings pre-grooved at factory
- All pipe pre-grooved at factory and supplied in standard 10 ft lengths.
- No heat or hot water required
- Easily assembled with ordinary hand tools
- Strong
- Easy to clean out and maintain (made with maintenance people in mind)
- Reusable and easy to move and change. Ideal when systems modifications are called for in remodeling projects. No-Hub systems are adaptable for use with other materials, including PVDF.
- Stainless steel outer coupling
- No metal in joint
- Suitable for below ground applications
- Easy fabrication of complex sub-assemblies.

Rionfuse CF Clamp-Free Electrofusion System



Rionfuse CF Clamp-Free Electrofusion System

Orion's state-of-the-art joining system for polypropylene and PVDF provides unsurpassed ease of installation and joint strength.

Unlike our competition, the Rionfuse CF coupling does not require clamping devices at any time during or after installation, resulting in significant installation cost savings. Our coupling wall thickness insulates the fusion surfaces, preventing thermal expansion and eliminating the need for clamps. The electrofusion wire coil is completely embedded into the inner coupling surface; once fused, there is no wetted metal in the joint. Rionfuse CF couplings may be used to connect the entire piping system, ensuring a durable, fully fused, tamper-proof installation. They may also be used as part of a No-Hub system in sections where the added security of fusion is desirable, without the inconvenience of changing lay lengths or fitting style. Rionfuse CF couplings are the ideal choice for any underground installations.

Features

- No clamps required
- Fast and easy installation means lower cost
- Multiple jointing capabilities and both sides of couplings fuse at the same time, saving labor
- Positive joints are made in just a few minutes
- Uses same grooved end fittings as our No-Hub system
- 10' pipe lengths standard
- Easily assembled with ordinary hand tools & Rionfuser electrofusion machine
- Strongest joint in the industry.
- Rionfuser machine ensures consistent, reliable joints and provides fusion data record
- Available in both Blueline FRPP and Plenum Plus PVDF
- Available in 1.5" through 14" sizes

Thermal Socket Fusion System



Thermal Socket Fusion System

The Time-Tested Drainage System from Orion:

Time-tested Orion Socket fusion drainage systems are durable, strong and tamper-proof. Heat fusion forms a complete hermetically sealed system which makes socket fusion systems ideal for severe usage applications.

Pipe and socket fusion fittings are joined by simultaneously heating the outside end of the pipe and the inside of the fitting socket using an Orion thermostatically controlled heating tool and the appropriate size of tool heads. In a semimolten state, pipe and fittings are joined to form a strong and permanent sealed joint. PVDF fittings and pipe are also available in the socket fusion joining system. However, because PVDF and PP are dissimilar materials they will not fuse together.

Check these outstanding features of Orion's time-tested socket fusion systems.

Features

- Two sizes of heating tools plus tool head sets (one male head, one female head) for pipe sizes to 6" are readily available from Orion.
- Full socket depth thermal fusion means strength and durability
- Forms true hermetically sealed joint
- All identical material, no electrolysis, no metal in joint
- Ideal for severe use applications
- Orion fusion systems meet ASTM D2657 standards in their entirety

Physical Properties

PROPERTY	UNIT	PP VALUE	FRPP VALUE	PVDF VALUE	TEST METHOD STANDARD *
Nominal Melt Flow (at 230°C / 2.16 kg)	g / 10 min.	0.75	0.75	7.0 - 28.0	ASTM D 1238
Specific Gravity	-	0.91	0.91	1.78	ASTM D 792
Tensile Strength at Yield	psi	4,200	4,200	6,500	ASTM D 638
Elongation at Yield	%	12.5	12.5	20 - 100	ASTM D 638
Modulus of Elasticity	psi	175,000	175,000	210,000	ASTM D 790A
Izod Impact, Notched (at 73°F - 1/8" bar)	ft-lb / in	1.3	1.3	3.8	ASTM D 256
Rockwell Hardness	R scale	78	78	-	ASTM D 785
Hardness	Shore D	-	-	78	ASTM D 2240
Melting Point	°F / °C	324 / 162	324 / 162	330 / 166	ASTM D 789 ASTM D 3418
Limiting Oxygen Index	%	17	17	44	ASTM D 2863
Water Absorption (24 hrs at 73°F)	%	0.02	0.02	0.03	ASTM D 570
Coefficient of Thermal Expansion	in / in °F x 10 ⁻⁵	6.1	6.1	7.4	ASTM D 696
Flame Spread	-	-	62	5	ASTM E 84
Smoke Developed	-	-	373	35	ASTM E 84
Underwriters Lab Rating	-	SLOW BURNING	V-2	V-0	UL 94
Material	cell class	PP 0438	PP 0438	Type I, Grade II	ASTM D 4101 ASTM D 3222
Corrosive Waste Drainage Suitability	system	COMPLIES	COMPLIES	COMPLIES	ASTM F 1412 ASTM F 1673

* Where test method standards differ between materials, the standard for PP and FRPP appears above the standard for PVDF.

Maximum Service Temperatures

This general guide is based on water as the medium.

Maximum service temperature factors: piping material, joining type, chemical exposure.

For specific applications please consult our chemical resistance charts.

MAXIMUM SERVICE TEMPERATURES FOR ORION DRAINAGE SYSTEMS			
JOINING METHOD	TYPE OF FLOW	POLYPROPYLENE	PVDF
Thermal Socket Fusion	Intermittent	200°F	285°F
	Constant	200°F	285°F
Rionfuse Thermal Coil Fusion	Intermittent	200°F	285°F
	Constant	200°F	285°F
No-Hub Mechanical Joint Coupling	Intermittent	160°F	180°F
	Constant	120°F	160°F

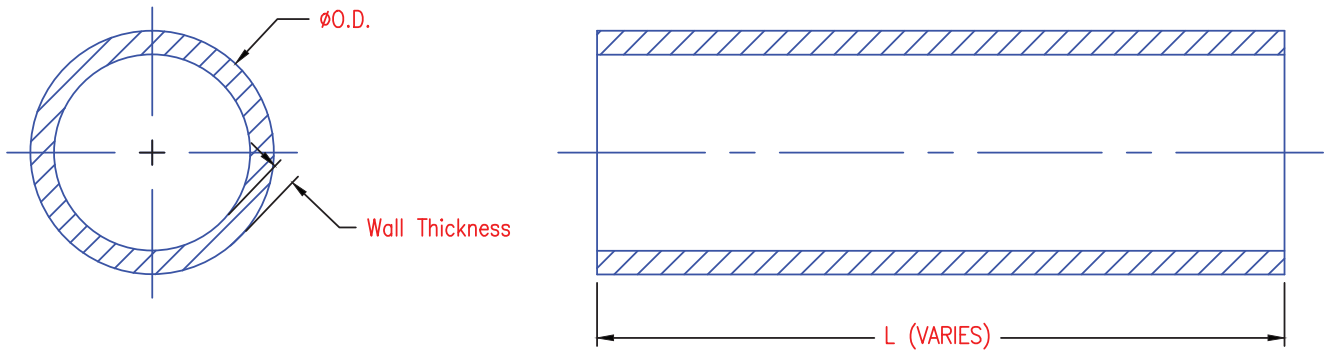

SCHEDULE 40	AVERAGE OD	WALL THICKNESS	WEIGHT PER STICK (LBS)		STICKS PER BUNDLE	
			PP	PVDF	PP	PVDF
1½	1.900	0.145	4	8.8	10	10
2	2.375	0.154	6	12.5	10	5
3	3.500	0.216	10	18	5	3
4	4.500	0.237	15	28	3	1
6	6.625	0.280	24	48	1	1
8	8.625	0.322	42	N/A	1	1
10	10.750	0.365	65	N/A	1	1
12	12.750	0.406	91	N/A	1	1

SCHEDULE 80	AVERAGE OD	WALL THICKNESS	WEIGHT PER STICK (LBS)		STICKS PER BUNDLE	
			PP	PVDF	PP	PVDF
1½	1.900	0.200	6	9	10	5
2	2.375	0.218	7	12	10	5
3	3.500	0.300	13	25	5	3
4	4.500	0.337	18	34	3	1
6	6.625	0.432	29	58	1	1
8	8.625	0.500	55	N/A	1	1
10	10.750	0.593	96	N/A	1	1
12	12.750	0.687	113	N/A	1	1

LARGE DIAMETER	AVERAGE OD	WALL THICKNESS	WEIGHT PER STICK (LBS)		STICKS PER BUNDLE	
			PP	PVDF	PP	PVDF
14	13.98	.423	125	N/A	1	N/A
16	15.75	.477	159	N/A	1	N/A
18	17.75	.538	200	N/A	1	N/A

All weights are approximate.

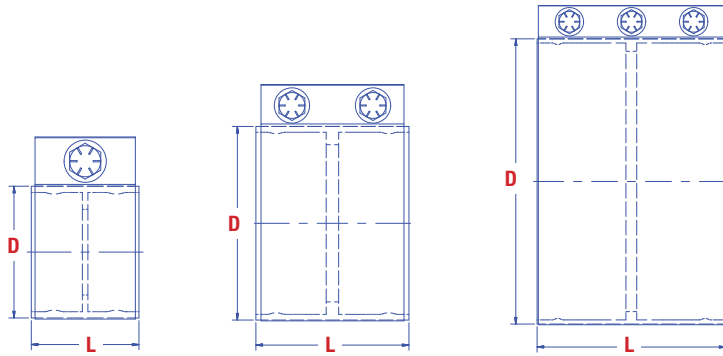

No-Hub Coupling

SIZE (In.)	D	L	QTY OF BOLT	WEIGHT (in ounces)	
				PP	PVDF
1½	2.115	1.730	1	3.92	3.92
2	2.610	2.120	2	5.92	5.92
3	3.730	2.950	2	9.44	9.44
4	4.760	3.310	2	11.92	11.92
6	6.870	4.550	3	22.56	22.56

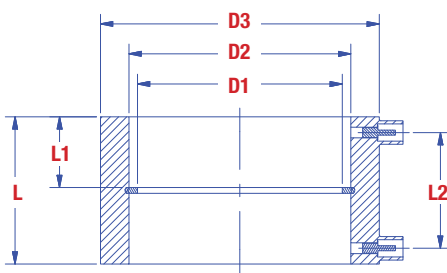
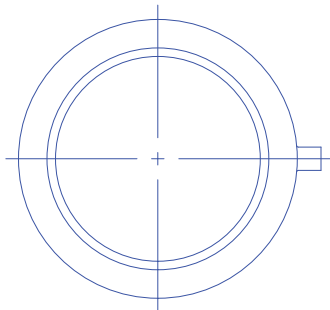

Rionfuse Coupling.

SIZE (In.)	L	L1	L2	D1	D2	D3	WEIGHT (in ounces)	
							PP	PVDF
1 1/2	2.074	0.978	1.602	1.500	1.850	2.440		
2	2.074	0.978	1.602	2.075	2.322	3.090		
3	2.948	1.415	2.320	3.000	3.452	4.470		
4	2.948	1.415	2.320	4.104	4.448	5.590		
6	4.196	2.020	3.410	6.000	6.635	7.775		

All weights are approximate.

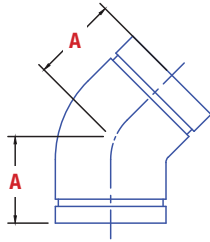

45° Elbow - 45E - 1/8 Bend

SIZE (In.)	A	B	C	D	E	WEIGHT (in ounces)	
						PP	PVDF
1½	1.50	–	–	–	–	2.70	5.67
2	1.56	–	–	–	–	2.62	5.50
3	2.37	–	–	–	–	12.75	26.78
4	2.78	–	–	–	–	19.46	40.87
6	4.75	–	–	–	–	30.25	63.53

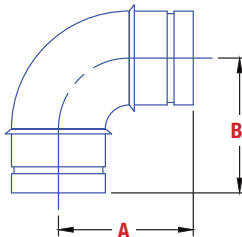

90° Elbow - 90E - 1/4 Bend

SIZE (In.)	A	B	C	D	E	WEIGHT (in ounces)	
						PP	PVDF
1½	2.56	2.56	–	–	–	2.45	5.15
2	3.41	3.41	–	–	–	3.73	7.83
3	4.53	4.53	–	–	–	16.83	35.34
4	5.25	5.25	–	–	–	18.58	39.02
6	7.31	7.31	–	–	–	61.45	129.00

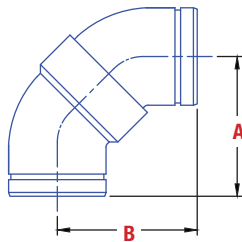

Long Sweep 90 Elbow - LS90E

SIZE (In.)	A	B	C	D	E	WEIGHT (in ounces)	
						PP	PVDF
1½	3.07	3.09	–	–	–	4.2	9.6
2	3.23	3.23	–	–	–	5.8	12.3
3	5.12	4.90	–	–	–	20.8	46.2
4	6.16	5.91	–	–	–	40.6	84.8
6	8.61	8.56	–	–	–	30.25	63.53

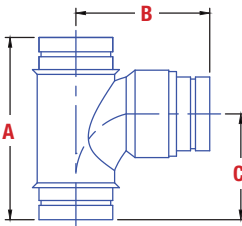

Sanitary Tee - 90T

SIZE (In.)	A	B	C	D	E	WEIGHT (in ounces)	
						PP	PVDF
1½	4.75	3.32	2.46	–	–	4.30	9.03
2	5.53	4.19	2.87	–	–	7.68	16.13
3	7.61	5.97	4.00	–	–	18.08	37.97
4	10.13	7.00	5.56	–	–	34.93	73.35

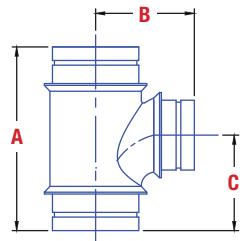

Reducing Sanitary Tee - R90T

SIZE (In.)	A	B	C	D	E	WEIGHT (in ounces)	
						PP	PVDF
2X1½	4.93	2.72	2.56	–	–	10.22	22.00
3X1½	6.69	3.38	3.42	–	–	10.70	22.40
3X2	6.68	3.63	3.50	–	–	35.18	71.60
4X1½	10.06	8.19	5.63	–	–	34.86	76.50
4X2	10.19	6.49	5.72	–	–	34.77	69.60
4X3	10.19	6.84	5.72	–	–	34.88	70.24

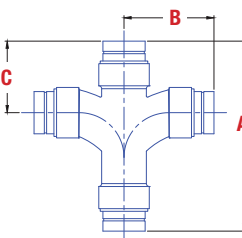

Double Sanitary Cross Tee - D90T

SIZE (In.)	A	B	C	D	E	WEIGHT (in ounces)	
						PP	PVDF
1½	4.75	3.32	2.46	–	–	6.02	12.64
2	5.53	4.19	2.87	–	–	10.75	22.58
3	7.61	5.97	4.00	–	–	25.31	53.16
4	10.13	7.00	5.56	–	–	48.90	102.69

All weights are approximate.

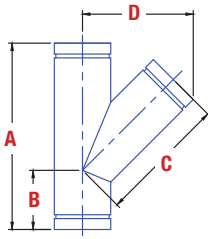

Single Wye - 45Y

SIZE (In.)	A	B	C	D	E	WEIGHT (in ounces)	
						PP	PVDF
1½	6.38	2.00	4.38	3.77	-	3.74	7.85
2	7.25	2.22	5.06	4.37	-	7.63	16.02
3	9.25	2.63	7.13	6.26	-	20.53	43.11
4	11.06	3.25	8.56	7.60	-	30.80	64.68
6	19.41	6.14	12.34	10.27	-	99.96	209.90

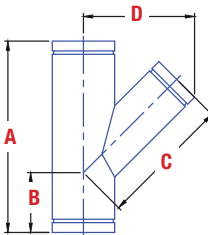

Reducing Single Wye - R45Y

SIZE (In.)	A	B	C	D	E	WEIGHT (in ounces)	
						PP	PVDF
2X1½	7.25	2.25	5.00	4.19	-	6.75	14.21
3X1½	7.30	2.04	5.34	4.42	-	10.43	11.80
3X2	8.06	2.40	5.96	5.03	-	17.33	35.20
4X1½	8.56	2.13	8.87	6.92	-	19.25	40.62
4X2	8.56	2.13	6.77	5.63	-	17.88	36.80
4X3	10.13	2.80	7.54	6.55	-	24.45	50.10
6X2	19.46	6.22	12.31	9.52	-	94.88	189.60
6X3	19.46	6.22	12.74	10.20	-	93.56	186.70
6X4	19.40	6.37	12.50	10.41	-	94.49	189.60

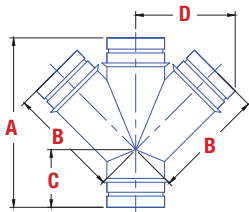

Double Wye - D45Y

SIZE (In.)	A	B	C	D	E	WEIGHT (in ounces)	
						PP	PVDF
1½	6.37	4.13	2.25	3.57	-	8.00	15.04
2	8.27	5.33	2.95	4.55	-	16.70	26.40
3	8.75	6.48	2.27	5.77	-	26.08	52.16
4	11.63	7.91	3.53	7.14	-	39.04	71.68
6	19.52	11.29	6.37	10.16	-	171.84	348.80

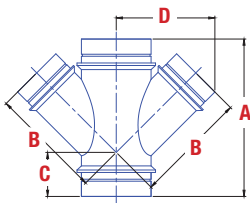

Reducing Double Wye - RD45Y

SIZE (In.)	A	B	C	D	E	WEIGHT (in ounces)	
						PP	PVDF
2X1½	8.27	5.28	2.95	4.39	-	15.56	26.72
3X1½	6.29	5.48	1.33	4.50	-	12.00	23.68
3X2	8.80	6.21	2.30	5.19	-	19.04	38.40
4X1½	8.25	7.59	1.94	6.02	-	22.88	39.68
4X2	8.25	7.80	1.94	6.30	-	24.03	39.68
4X3	10.25	7.23	2.95	6.35	-	29.92	48.00
6X2	19.46	12.31	6.22	9.52	-	156.80	312.00
6X3	19.46	12.84	6.22	10.27	-	156.08	312.00
6X4	19.40	12.50	6.37	10.41	-	160.00	317.12

All weights are approximate.

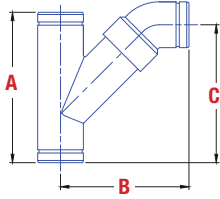

Long Turn Wye - LTY

SIZE (In.)	A	B	C	D	E	WEIGHT (in ounces)	
						PP	PVDF
1½	6.38	5.06	5.58	-	-	5.34	11.21
2	7.25	5.75	6.40	-	-	10.30	21.63
3	9.13	8.48	8.52	-	-	29.18	61.28
4	11.06	10.08	10.30	-	-	35.78	75.14
6	19.86	13.27	15.79	-	-	132.36	278.00

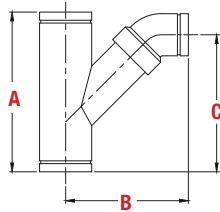

Reducing Long Turn Wye - RLTY

SIZE (In.)	A	B	C	D	E	WEIGHT (in ounces)	
						PP	PVDF
2X1½	7.25	5.64	6.41	-	-	8.70	17.60
3X1½	7.30	5.78	6.34	-	-	13.82	27.60
3X2	8.06	6.33	7.16	-	-	19.55	40.10
4X1½	8.56	7.48	8.25	-	-	20.93	42.60
4X2	8.56	6.97	7.53	-	-	20.70	41.80
4X3	10.13	8.76	8.97	-	-	33.10	66.80
6X2	10.46	10.73	15.38	-	-	95.81	190.60
6X3	19.45	10.95	14.80	-	-	102.20	205.80
6X4	19.39	10.40	14.99	-	-	109.30	220.70

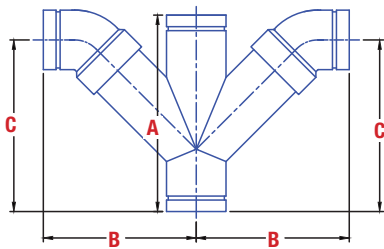

Double Long Turn Wye - DLTY

SIZE (In.)	A	B	C	D	E	WEIGHT (in ounces)	
						PP	PVDF
1½	6.43	4.33	5.11	-	-	10.26	21.55
2	8.25	4.94	6.30	-	-	16.23	34.08
3	8.75	8.05	7.73	-	-	46.90	98.49
4	11.63	9.70	10.20	-	-	64.19	134.80
6	19.52	13.87	16.00	-	-	181.86	381.90

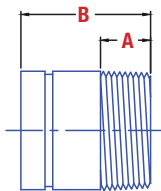

Male Adapter - MA

SIZE (In.)	A	B	C	D	E	WEIGHT (in ounces)	
						PP	PVDF
1½	0.80	2.13	-	-	-	1.12	2.35
2	0.80	2.08	-	-	-	1.38	2.90
3	1.26	3.00	-	-	-	3.85	8.06
4	1.45	3.00	-	-	-	5.38	11.30
6	1.99	4.36	-	-	-	15.30	32.13

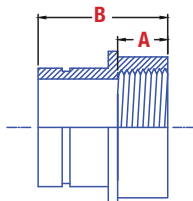

Female Adapter - FA

SIZE (In.)	A	B	C	D	E	WEIGHT (in ounces)	
						PP	PVDF
1½	0.80	2.07	-	-	-	1.12	2.35
2	0.80	2.07	-	-	-	1.90	3.99
3	1.25	3.00	-	-	-	4.93	10.35
4	1.50	3.00	-	-	-	7.78	16.34
6	2.00	4.31	-	-	-	17.48	36.71

All weights are approximate.

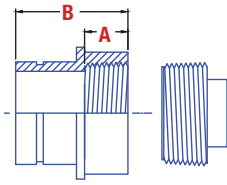

Cleanout Adapter - COA

SIZE (In.)	A	B	C	D	E	WEIGHT	
						PP	PVDF
1½	0.80	2.07	-	-	-	1.57	3.30
2	0.80	2.07	-	-	-	2.94	6.17
3	1.25	3.00	-	-	-	6.76	14.20
4	1.50	3.00	-	-	-	11.88	24.95
6	2.00	4.31	-	-	-	25.41	53.36

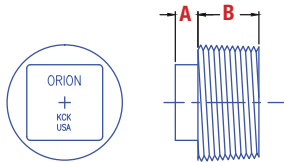

Cleanout Plug - CPC

SIZE (In.)	A	B	C	D	E	WEIGHT (in ounces)	
						PP	PVDF
1½	0.37	0.99	-	-	-	1.57	.95
2	0.68	1.12	-	-	-	1.02	2.14
3	0.68	1.09	-	-	-	1.83	3.84
4	0.68	1.13	-	-	-	4.10	8.61
6	0.95	1.33	-	-	-	7.93	16.65

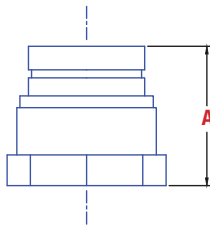

Cap - CAP

SIZE (In.)	A	B	C	D	E	WEIGHT (in ounces)	
						PP	PVDF
1½	2.26	-	-	-	-	2.06	4.33
2	2.55	-	-	-	-	3.16	6.64
3	3.36	-	-	-	-	6.80	14.28
4	3.33	-	-	-	-	12.53	26.31
6	5.21	-	-	-	-	26.55	55.76

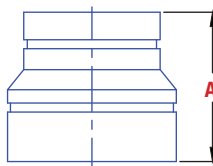

Reducer - RB

SIZE (In.)	A	B	C	D	E	WEIGHT (in ounces)	
						PP	PVDF
2X1½	2.08	-	-	-	-	1.52	3.19
3X1½	2.50	-	-	-	-	4.11	8.63
3X2	2.55	-	-	-	-	3.34	7.01
4X1½	4.33	-	-	-	-	5.98	12.56
4X2	2.75	-	-	-	-	5.03	10.56
4X3	3.00	-	-	-	-	5.35	11.24
6X2	4.86	-	-	-	-	19.34	40.61
6X3	5.39	-	-	-	-	20.10	42.21
6X4	5.49	-	-	-	-	20.08	42.17

All weights are approximate.

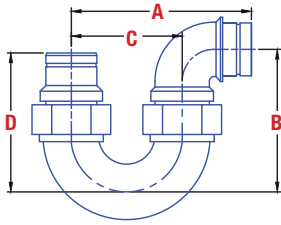

P-Trap - Adjustable Trap - UTP

SIZE (In.)	A	B	C	D	E	WEIGHT (in ounces)	
						PP	PVDF
1½	6.50	5.28	4.00	5.27	–	11.73	24.63
2	8.03	5.77	5.25	5.74	–	18.73	39.33

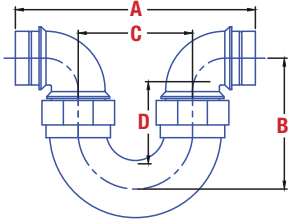

Running Trap - Adjustable Trap - UTR

SIZE (In.)	A	B	C	D	E	WEIGHT (in ounces)	
						PP	PVDF
1½	9.00	5.28	4.00	3.74	–	13.85	29.09
2	10.81	5.76	5.25	3.70	–	19.10	40.11

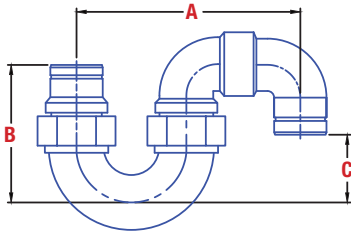

S-Trap - Adjustable Trap - UTPS

SIZE (In.)	A	B	C	D	E	WEIGHT (in ounces)	
						PP	PVDF
1½	8.15	5.00	2.46	–	–	13.10	27.51
2	10.41	5.73	2.11	–	–	22.73	47.73

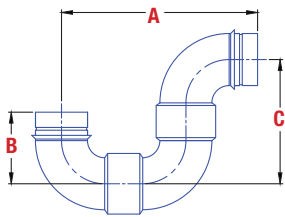

P-Trap - Nonadjustable - RBP-P

SIZE (In.)	A	B	C	D	E	WEIGHT (in ounces)	
						PP	PVDF
1½	6.78	2.56	4.23	–	–	7.01	14.72
2	9.22	3.41	5.81	–	–	11.76	24.70
3	12.19	4.53	7.66	–	–	42.29	88.81
4	14.13	5.25	8.88	–	–	58.59	123.00
6	19.39	9.39	11.39	–	–	192.25	403.70

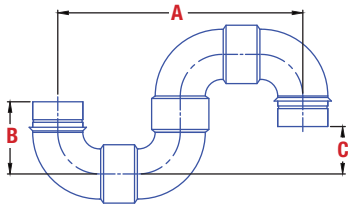

S-Trap - Nonadjustable - RBP-S

SIZE (In.)	A	B	C	D	E	WEIGHT (in ounces)	
						PP	PVDF
1½	8.42	2.55	1.66	–	–	9.09	19.09
2	11.59	3.37	2.40	–	–	15.72	33.01
3	15.29	4.50	3.13	–	–	55.02	115.50
4	18.00	5.57	3.58	–	–	77.17	162.10

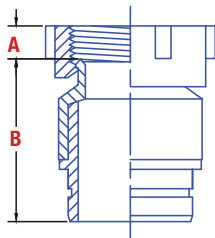

Sink Tailpiece Loose Nut Adapter - RLNS

SIZE (In.)	A	B	C	D	E	WEIGHT (in ounces)	
						PP	PVDF
1½	0.51	2.53	–	–	–	2.50	5.25
2	0.77	3.28	–	–	–	4.66	9.79

All weights are approximate.

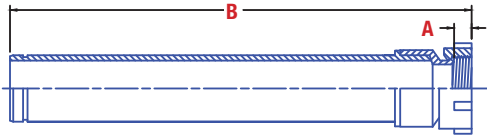

Sink Tailpiece Loose Nut Adapter - RLNS x 12"

SIZE (In.)	A	B	C	D	E	WEIGHT (in ounces)	
						PP	PVDF
1½	0.50	13.25	-	-	-	2.50	5.25
2	0.77	13.87	-	-	-	4.66	9.79

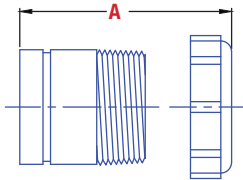

Sink Tailpiece Slip Joint Adapter - SJA

SIZE (In.)	A	B	C	D	E	WEIGHT (in ounces)	
						PP	PVDF
1½	2.48	-	-	-	-	1.38	2.90
2	2.40	-	-	-	-	2.26	4.75

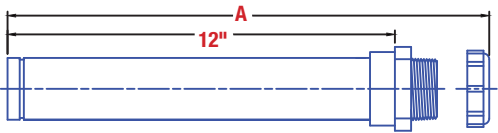

Sink Tailpiece Slip Joint Adapter - SJA x 12"

SIZE (In.)	A	B	C	D	E	WEIGHT (in ounces)	
						PP	PVDF
1½	13.34	-	-	-	-	2.50	5.25
2	13.34	-	-	-	-	4.66	9.79

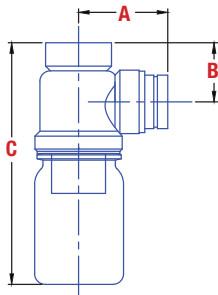

Bottle Trap without Bottle, 1.5" FIP Inlet, 1.5" No-Hub Outlet, for use with PP Bottles - BT1

SIZE	A	B	C	D	E	WEIGHT (in ounces)	
						PP	PVDF
w/o bottle	3.18	2.10	-	-	-	8.15	-
1PT	-	-	8.62	-	-	10.60	-
1QT	-	-	10.26	-	-	11.73	-
2QT	-	-	11.65	-	-	14.00	-

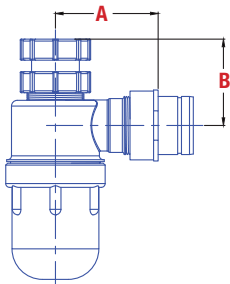

Bottle Trap with 1 Pt Bottle, 1.5" FIP Adjustable Riser Inlet, 1.5" No-Hub Outlet - BT2

SIZE (In.)	A	B	C	D	E	WEIGHT (in ounces)	
						PP	PVDF
1½	3	7.25	-	-	-	-	-

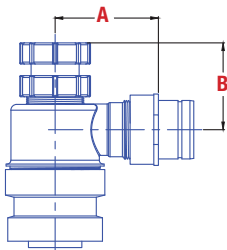

Bottle Trap without Bottle, 1.5" FIP Adjustable Riser Inlet, 1.5" No-Hub Outlet, for use with PP Bottles or Glass Mason Jars - BT3

SIZE (In.)	A	B	C	D	E	WEIGHT (in ounces)	
						PP	PVDF
1½	3	7.25	-	-	-	-	-

All weights are approximate.

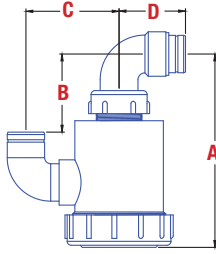

Drum Trap - DT1

SIZE (In.)	A	B	C	D	E	WEIGHT (in ounces)	
						PP	PVDF
1½	9.82	3.96	4.74	3.38	-	2.50	5.25
2	10.34	3.63	5.81	4.69	-	4.66	9.79

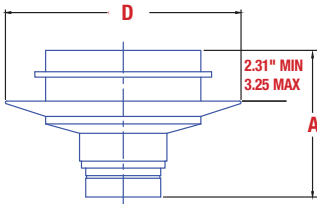

Floor Drain - FD-1

SIZE (In.)	A		B	C	D	WEIGHT (in ounces)	
	(Min.)	(Max.)				PP	PVDF
2	6.71	7.65	-	-	11.00	45.57	95.18
3	6.92	7.86	-	-	11.00	42.43	89.04
4	6.97	7.91	-	-	11.00	50.18	105.77
6	5.89	6.83	-	-	11.00	85.28	179.99

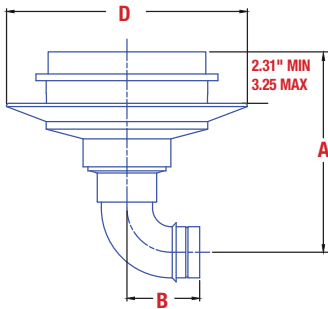

Floor Drain with Side Outlet - FD-2

SIZE (In.)	A		B	C	D	WEIGHT (in ounces)	
	(Min.)	(Max.)				PP	PVDF
2	9.26	10.20	3.41	-	11.00	50.23	105.29
3	8.39	9.33	4.53	-	11.00	60.13	121.99
4	9.21	10.15	5.25	-	11.00	62.58	125.12

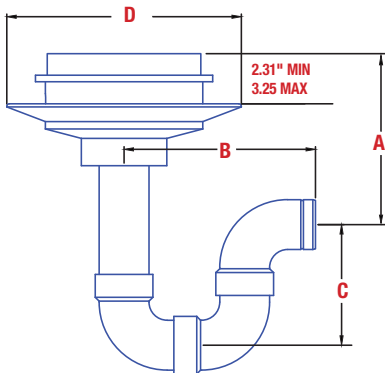

Floor Drain with Integral Trap - FD-3

SIZE (In.)	A		B	C	D	WEIGHT (in ounces)	
	(Min.)	(Max.)				PP	PVDF
2	10.73	11.67	9.13	5.75	11.00	58.26	118.22
3	8.21	9.15	12.08	7.58	11.00	85.59	175.32
4	7.61	8.55	15.16	9.60	11.00	102.69	205.77

All weights are approximate.

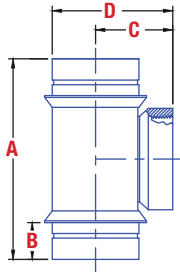

Clean Out Tee - COT

SIZE (In.)	A	B	C	D	E	WEIGHT (in ounces)	
						PP	PVDF
1½	7.72	0.88	2.16	3.11	-	4.85	10.19
2	5.46	1.01	2.16	3.35	-	8.75	18.38
3	10.70	1.36	2.88	4.63	-	22.73	47.73
4	12.29	1.54	3.50	5.75	-	19.93	41.85
6	19.20	2.14	9.31	12.63	-	68.61	144.10

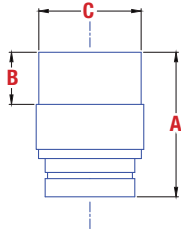

Duriron X MJ Adapter - DA

SIZE (In.)	A	B	C	D	E	WEIGHT (in ounces)	
						PP	PVDF
1½	3.05	1.09	2.17	-	-	1.96	4.12
2	3.38	1.08	2.62	-	-	3.60	7.56
3	4.66	1.08	3.75	-	-	8.60	18.06
4	4.69	1.07	4.79	-	-	13.62	28.60
6	6.47	1.14	6.90	-	-	-	-

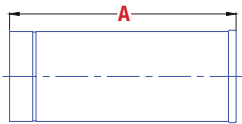

Duriron Hub X MJ Adapter - DHA

SIZE (In.)	A	B	C	D	E	WEIGHT (in ounces)	
						PP	PVDF
1½	6.00	-	-	-	-	2.73	5.73
2	6.00	-	-	-	-	3.60	7.56
3	6.00	-	-	-	-	7.80	16.38
4	6.00	-	-	-	-	10.96	23.02
6	6.00	-	-	-	-	19.60	41.16

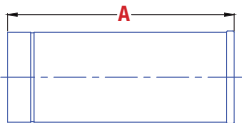

Cast Iron Hub X MJ Adapter - CIA

SIZE (In.)	A	B	C	D	E	WEIGHT (in ounces)	
						PP	PVDF
1½	6.00	-	-	-	-	2.73	5.73
2	6.00	-	-	-	-	3.60	7.56
3	6.00	-	-	-	-	7.80	16.38
4	6.00	-	-	-	-	10.96	23.02
6	6.00	-	-	-	-	19.60	41.16

All weights are approximate.

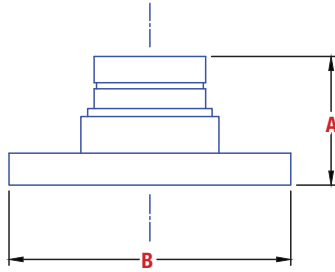

Flange - FLG

SIZE (In.)	A	B	150# ANSI PATTERN HOLES	WEIGHT (in ounces)	
				PP	PVDF
1½	2.18	5.00	4	6.16	12.94
2	2.67	5.75	4	8.48	17.81
3	3.37	7.50	4	18.18	38.18
4	3.33	9.04	8	26.63	55.92
6	4.82	10.75	8	46.86	98.41

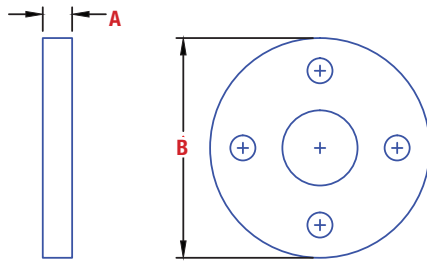

Backup Ring - BACK UP

SIZE (In.)	A	B	150# ANSI PATTERN HOLES	WEIGHT (in ounces)	
				PP	PVDF
1½	.55	5.00	4		
2	.55	6.00	4		
3	.55	7.50	4		
4	.55	9.00	8		
6	.55	11.00	8		

All weights are approximate.

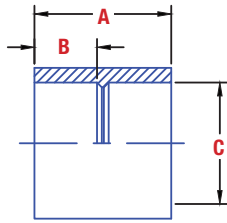

Coupling - CLS

SIZE (In.)	A	B	C	D	E	WEIGHT (in ounces)	
						PP	PVDF
1½	2.05	0.90	1.87	-	-	1.28	2.69
2	2.06	0.92	2.37	-	-	2.18	4.58
3	3.00	1.35	3.47	-	-	5.30	11.13
4	3.00	1.37	4.45	-	-	8.78	18.44
6	4.18	2.00	6.56	-	-	16.88	35.45

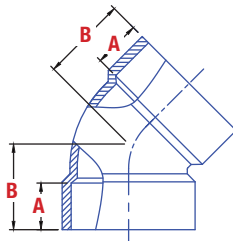

45° Elbow - 45E - 1/8 Bend

SIZE (In.)	A	B	C	D	E	WEIGHT (in ounces)	
						PP	PVDF
1½	0.90	1.65	-	-	-	1.78	3.74
2	0.92	1.78	-	-	-	3.18	6.68
3	1.39	2.55	-	-	-	9.30	19.53
4	1.52	3.03	-	-	-	13.93	29.25
6	2.25	4.25	-	-	-	35.05	73.61

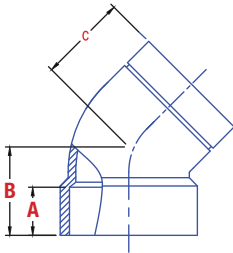

Single-Socket 45° Elbow - F45E - 1/8 Bend

SIZE (In.)	A	B	C	D	E	WEIGHT (in ounces)	
						PP	PVDF
1½	0.88	1.63	1.48	-	-	1.78	3.74
2	0.90	1.75	1.57	-	-	3.18	6.68
3	1.39	2.59	2.59	-	-	9.30	19.53
4	1.68	3.03	3.03	-	-	13.93	29.25
6	2.25	4.20	4.20	-	-	35.05	73.61

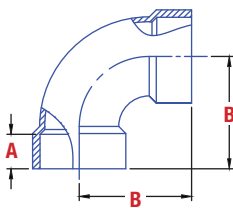

90° Elbow - 90E - 1/4 Bend

SIZE (In.)	A	B	C	D	E	WEIGHT (in ounces)	
						PP	PVDF
1½	0.88	2.54	-	-	-	2.23	4.68
2	1.00	3.41	-	-	-	4.30	9.03
3	1.44	4.53	-	-	-	3.75	7.87
4	1.62	5.25	-	-	-	21.43	45.00
6	2.11	7.21	-	-	-	66.30	139.20

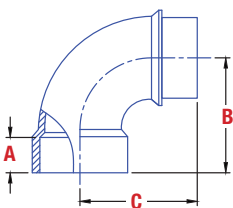

Single-Socket 45° Elbow - F90E - 1/4 Bend

SIZE (In.)	A	B	C	D	E	WEIGHT (in ounces)	
						PP	PVDF
1½	0.91	2.55	2.55	-	-	2.08	4.37
2	1.00	3.37	3.77	-	-	3.96	8.32
3	1.42	4.50	4.50	-	-	12.73	26.73
4	1.35	5.25	5.21	-	-	19.53	41.01
6	2.34	7.00	7.00	-	-	67.45	141.60

All weights are approximate.

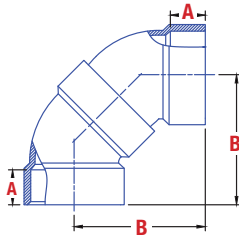

Long Sweep 90° Elbow - LS90E - 1/4 Bend

SIZE (In.)	A	B	C	D	E	WEIGHT (in ounces)	
						PP	PVDF
1½	0.92	3.20	–	–	–	3.63	7.62
2	0.92	3.49	–	–	–	6.38	13.40
3	1.39	5.20	–	–	–	15.80	33.18
4	1.68	6.23	–	–	–	31.03	65.16
6	2.25	8.80	–	–	–	70.10	147.52

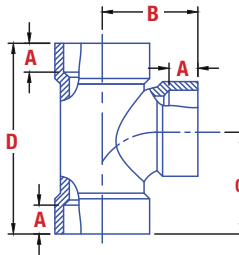

Sanitary Tee - 90T

SIZE (In.)	A	B	C	D	E	WEIGHT (in ounces)	
						PP	PVDF
1½	0.79	2.30	2.55	4.62	–	5.20	10.92
2	1.00	3.38	3.38	6.15	–	9.13	19.17
3	1.23	4.27	4.25	7.60	–	14.53	30.51
4	1.31	5.25	5.35	9.75	–	24.23	33.18

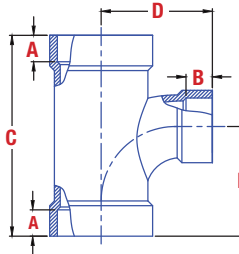

Reducing Sanitary Tee - R90T

SIZE (In.)	A	B	C	D	E	WEIGHT (in ounces)	
						PP	PVDF
2X1½	1.05	0.80	5.17	2.74	2.68	5.00	10.50
3X1½	1.51	0.83	6.70	3.20	3.45	12.13	25.47
3X2	1.36	0.92	9.88	4.59	5.10	12.75	26.78
4X1½	1.31	0.80	9.75	7.13	5.35	36.03	75.66
4X2	1.31	1.03	9.75	6.77	5.35	36.35	76.34
4X3	1.31	1.34	9.75	6.88	5.35	36.33	76.29

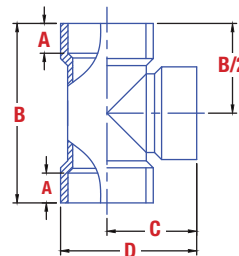

Cleanout Tee with Plug - COT

SIZE (In.)	A	B	C	D	E	WEIGHT (in ounces)	
						PP	PVDF
1½					–	4.03	8.46
2	0.90	5.46	2.23	3.60	–	6.70	14.07
3	1.37	7.37	2.87	4.87	–	19.88	41.75
4	1.51	8.88	3.50	6.09	–	30.98	65.06
6	1.98	14.44	9.31	13.12	–	86.23	181.10

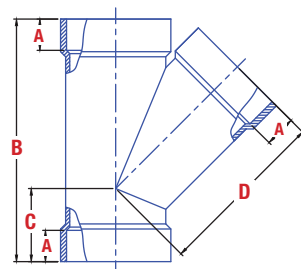

45° Lateral WYE - 45Y

SIZE (In.)	A	B	C	D	E	WEIGHT (in ounces)	
						PP	PVDF
1½	0.81	5.38	1.54	3.88	–	5.84	12.26
2	1.01	7.20	2.28	4.95	–	9.71	20.39
3	1.32	8.18	2.18	6.00	–	28.10	59.01
4	1.38	11.00	3.28	7.73	–	44.50	93.41
6	2.00	14.62	3.75	13.85	–	104.40	219.20

All weights are approximate.

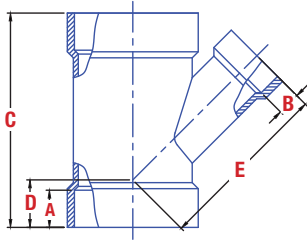

Reducing Single Wye - R45Y

SIZE (In.)	A	B	C	D	E	WEIGHT (in ounces)	
						PP	PVDF
2X1½	1.02	0.92	6.48	2.14	5.75	5.90	12.39
3X1½	1.41	0.80	6.22	1.38	5.27	11.55	24.26
3X2	1.13	0.98	8.19	2.29	6.10	16.55	34.76
4X1½	1.42	0.92	8.19	1.95	7.56	16.10	33.81
4X2	1.50	0.98	8.19	1.95	6.56	14.80	31.08
4X3	1.41	1.25	9.38	2.43	7.24	26.30	55.23
6X2	2.07	1.05	14.56	3.77	12.80	62.23	130.70
6X3	2.07	1.31	14.56	3.77	11.08	57.85	121.50
6X4	1.93	1.50	14.50	3.92	10.79	58.90	123.70

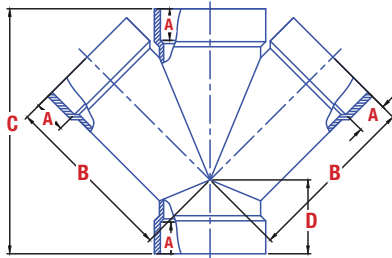

Double WYE - D45Y

SIZE (In.)	A	B	C	D	E	WEIGHT (in ounces)	
						PP	PVDF
1½	0.57	3.13	4.37	1.25	-	4.68	9.83
2	0.85	4.04	5.70	1.66	-	8.35	17.54
3	1.36	8.12	12.05	3.92	-	25.05	52.61
4	1.39	9.52	14.85	5.14	-	39.03	81.96
6	1.88	13.67	14.75	3.75	-	120.26	252.50

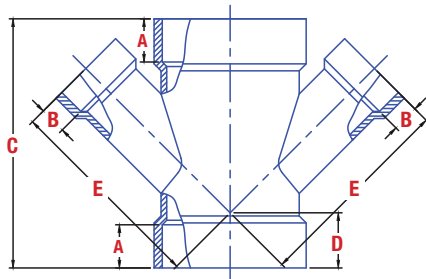

Reducing Double Lateral Wye - RD45Y

SIZE (In.)	A	B	C	D	E	WEIGHT (in ounces)	
						PP	PVDF
2X1½	0.85	0.92	5.70	1.66	5.11	10.95	23.00
3X1½	1.36	0.64	6.23	1.38	5.20	13.10	27.51
3X2	1.36	0.92	12.02	3.91	7.35	19.18	40.28
4X1½	1.39	0.90	11.48	3.55	8.80	23.30	48.93
4X2	1.39	0.90	11.48	3.55	6.55	21.83	45.84
4X3	1.39	1.36	13.48	4.56	8.87	32.43	68.10
6X2	2.07	1.05	14.56	3.77	12.71	72.26	151.70
6X3	2.07	1.31	14.56	3.77	11.08	65.60	137.80
6X4	1.93	1.50	14.50	3.92	10.79	63.50	133.40

All weights are approximate.

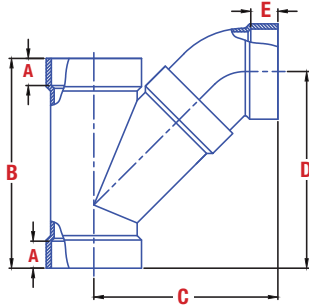

Long Turn Wye - LTY

SIZE (in.)	A	B	C	D	E	WEIGHT (in ounces)	
						PP	PVDF
1½	1.38	11.00	9.67	9.92	1.68	4.68	9.83
2	1.02	7.20	5.71	6.24	0.90	8.35	17.54
3	1.33	8.19	7.82	7.41	1.40	25.05	52.61
4	1.38	11.00	9.67	9.92	1.68	39.03	81.96
6	1.88	14.63	13.52	13.02	2.25	120.26	252.50

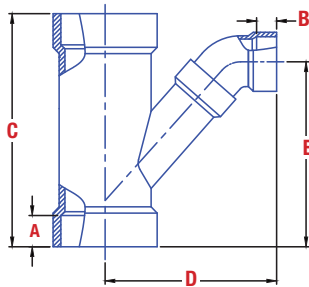

Reducing Long Turn Wye - RLTY

SIZE (in.)	A	B	C	D	E	WEIGHT (in ounces)	
						PP	PVDF
2X1½	0.92	0.92	9.40	5.70	7.38	7.65	16.07
3X1½	1.36	0.92	10.58	5.94	7.97	14.91	31.31
3X2	1.14	0.90	8.19	6.52	7.06	19.56	41.08
4X1½	1.50	0.88	8.19	7.42	7.74	21.67	45.51
4X2	1.50	0.90	8.19	6.85	7.05	21.35	44.84
4X3	1.41	1.40	9.38	8.66	8.50	33.90	71.19
6X2	2.07	0.90	14.56	11.31	13.34	94.63	198.70
6X3	2.07	1.40	14.56	11.32	12.51	67.70	142.20
6X4	1.93	1.68	14.50	11.74	12.63	71.23	149.60

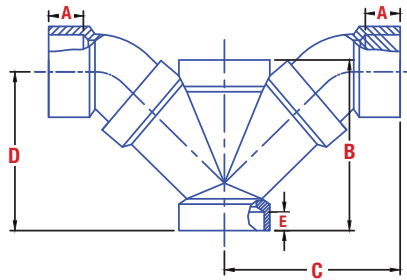

Double Long Turn WYE - DLTY

SIZE (in.)	A	B	C	D	E	WEIGHT (in ounces)	
						PP	PVDF
1½	0.88	4.37	4.38	4.05	0.57	8.05	16.91
2	0.90	5.70	5.20	5.13	0.85	14.37	30.18
3	1.40	12.05	9.21	10.54	1.35	41.35	86.84
4	1.68	14.85	9.64	11.76	1.38	65.79	138.20
6	2.25	14.75	13.52	13.02	1.87	156.60	328.90

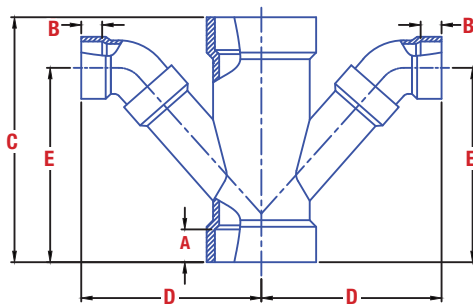

Reducing Double Long Turn Wye - RDLTY

SIZE (in.)	A	B	C	D	E	WEIGHT (in ounces)	
						PP	PVDF
2X1½	0.85	0.88	5.70	5.59	5.62	14.57	30.60
3X1½	1.36	0.88	12.02	7.20	9.48	16.72	35.11
3X2	1.36	0.92	12.02	6.72	8.85	25.20	52.92
4X1½	1.39	0.92	11.48	7.56	9.46	26.40	55.44
4X2	1.39	0.90	11.48	6.90	8.70	49.70	104.40
4X3	1.39	1.40	13.48	9.66	11.64	28.05	58.91
6X2	2.07	0.90	14.56	11.00	13.00	137.06	287.80
6X3	2.07	1.40	14.56	11.32	12.51	83.20	174.70
6X4	1.93	1.68	14.50	11.79	12.68	90.26	189.50

All weights are approximate.

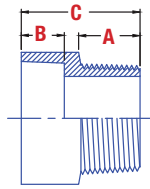

Male Adapter - MA

SIZE (In.)	A	B	C	D	E	WEIGHT (in ounces)	
						PP	PVDF
1½	0.98	0.72	2.04	-	-	1.08	2.27
2	0.78	1.03	2.06	-	-	1.88	3.95
3	1.25	1.36	4.63	-	-	4.30	9.03
4	1.29	1.38	3.00	-	-	6.75	14.18
6	1.99	4.49	6.49	-	-	18.00	37.80

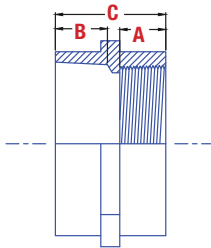

Female Adapter - FA

SIZE (In.)	A	B	C	D	E	WEIGHT (in ounces)	
						PP	PVDF
1½	0.79	0.91	2.06	-	-	1.30	2.73
2	0.80	0.93	2.07	-	-	2.25	4.73
3	1.50	1.35	3.00	-	-	5.53	11.61
4	1.50	1.45	3.00	-	-	9.05	19.01
6	2.00	2.00	6.47	-	-	8.35	17.54

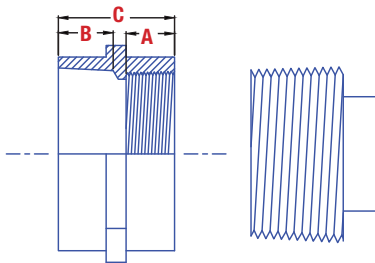

Clean Out Adapter - COA

SIZE (In.)	A	B	C	D	E	WEIGHT (in ounces)	
						PP	PVDF
1½	0.79	0.91	2.06	-	-	1.75	3.68
2	0.80	0.93	2.07	-	-	3.28	6.89
3	1.50	1.35	3.00	-	-	7.35	15.44
4	1.50	1.45	3.00	-	-	13.10	27.51
6	2.00	2.00	6.47	-	-	26.28	55.19

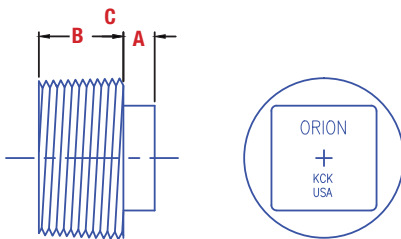

Clean Out Plug - CPC

SIZE (In.)	A	B	C	D	E	WEIGHT (in ounces)	
						PP	PVDF
1½	0.37	0.99	-	-	-	0.50	1.20
2	0.67	0.99	-	-	-	1.02	2.14
3	0.68	1.09	-	-	-	1.83	3.84
4	0.68	1.12	-	-	-	4.10	8.61
6	0.95	1.34	-	-	-	7.93	16.65

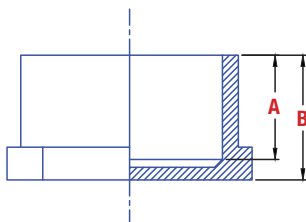

Cap - CAP

SIZE (In.)	A	B	C	D	E	WEIGHT (in ounces)	
						PP	PVDF
1½	0.90	1.27	-	-	-	1.08	2.27
2	0.90	1.27	-	-	-	1.48	3.11
3	1.40	1.70	-	-	-	2.70	5.67
4	1.46	2.00	-	-	-	6.45	13.55
6	2.35	2.83	-	-	-	20.63	43.32

All weights are approximate.

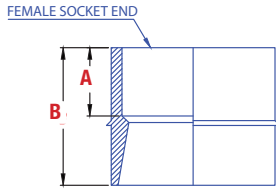

Reducing Bushing - RB

SIZE (In.)	A	B	C	D	E	WEIGHT (in ounces)	
						PP	PVDF
2X1½	0.92	2.00	-	-	-	1.30	2.73
3X1½	1.05	3.00	-	-	-	3.13	6.57
3X2	1.05	3.22	-	-	-	3.33	6.99
4X1½	0.80	3.43	-	-	-	5.00	10.50
4X2	1.03	3.25	-	-	-	5.18	10.88
4X3	1.34	3.00	-	-	-	5.45	11.45
6X2	0.96	5.54	-	-	-	17.68	37.13
6X3	1.38	3.70	-	-	-	14.23	29.88
6X4	1.38	3.78	-	-	-	14.35	30.14

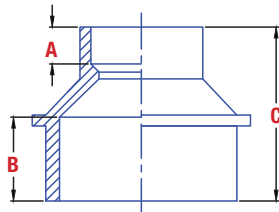

Reducing Coupling - RCLS

SIZE (In.)	A	B	C	D	E	WEIGHT (in ounces)	
						PP	PVDF
2X1½	0.90	0.98	2.06	-	-	1.56	3.28
3X1½	0.92	1.35	4.00	-	-	3.76	7.88
3X2	1.04	1.35	3.00	-	-	4.00	8.39
4X1½	1.16	1.40	4.17	-	-	6.00	12.60
4X2	1.00	1.40	3.00	-	-	6.22	13.06
4X3	1.33	1.38	3.00	-	-	6.54	13.74
6X2	1.05	2.00	7.41	-	-	21.22	44.56
6X3	1.38	2.00	5.95	-	-	17.08	35.86
6X4	0.89	2.00	5.97	-	-	17.22	36.17

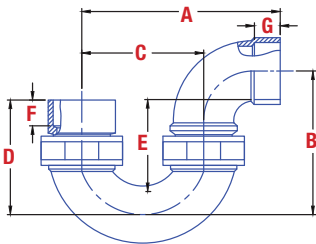

P-Trap - Adjustable Trap - UTP

SIZE (In.)	A	B	C	D	E	F	G	WEIGHT (in ounces)	
								PP	PVDF
1½	6.47	5.05	4.00	5.27	3.31	1.16	0.90	6.80	13.40
2	9.17	5.77	5.25	6.88	3.70	0.92	0.92	11.60	25.30

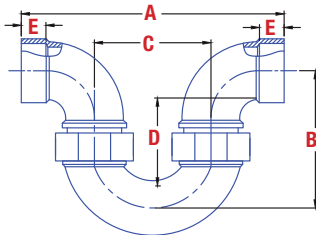

Running Trap - Adjustable Trap - UTR

SIZE (In.)	A	B	C	D	E	WEIGHT (in ounces)	
						PP	PVDF
1½	8.94	5.05	4.00	3.51	0.90	11.89	24.97
2	12.93	5.77	5.25	3.70	0.92	19.20	40.32

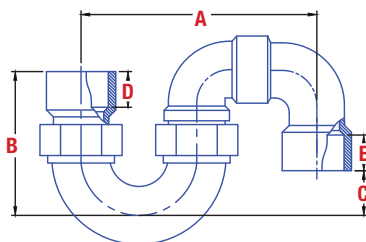

S-Trap - Adjustable Trap - UTPS

SIZE (In.)	A	B	C	D	E	WEIGHT (in ounces)	
						PP	PVDF
1½	8.12	5.27	2.50	1.16	0.91	12.78	26.84
2	10.44	6.88	2.36	0.92	1.01	21.15	44.42

All weights are approximate.

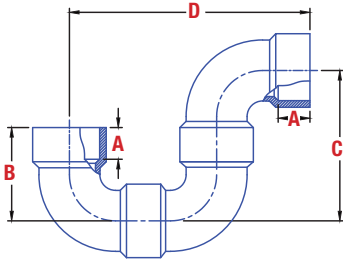

P-Trap - Nonadjustable Trap - RBP

SIZE (In.)	A	B	C	D	E	WEIGHT (in ounces)	
						PP	PVDF
1½	0.88	2.54	4.22	6.76	-	6.91	14.50
2	1.01	3.41	5.81	9.22	-	11.70	24.57
3	1.44	4.53	7.66	12.19	-	38.63	81.12
4	1.55	5.25	8.83	14.08	-	60.25	126.50
6	2.34	7.00	11.61	18.61	-	197.05	413.80

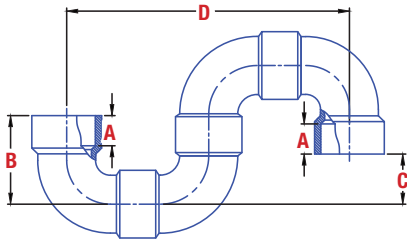

S-Trap - Nonadjustable Trap - RBPS

SIZE (In.)	A	B	C	D	E	WEIGHT (in ounces)	
						PP	PVDF
1½	0.91	2.54	1.67	8.43	-	8.99	18.88
2	1.01	3.41	2.43	11.59	-	16.29	34.21
3	1.44	4.53	3.16	12.19	-	55.02	115.50
4	1.36	5.25	3.58	17.73	-	80.97	170.00

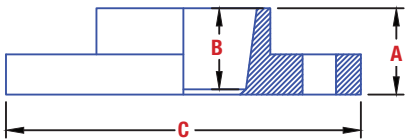

Flange - FLG

SIZE (In.)	A	B	C	150# ANSI PATTERN HOLES	WEIGHT (in ounces)	
					PP	PVDF
1½	1.18	1.08	5.00	4	5.18	10.88
2	1.18	1.38	5.75	4	6.80	14.28
3	1.37	1.65	7.50	4	14.08	29.57
4	1.22	1.62	9.04	8	20.55	43.16
6	2.28	2.28	10.75	8	31.58	66.32

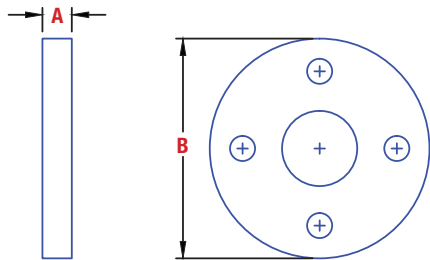

Backup Ring - BACK UP

SIZE (In.)	A	B	150# ANSI PATTERN HOLES	WEIGHT (in ounces)	
				PP	PVDF
1½	.55	5.00	4		
2	.55	6.00	4		
3	.55	7.50	4		
4	.55	9.00	8		
6	.55	11.00	8		

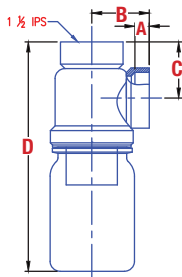

Bottle Trap with Bottle - BT1

SIZE	A	B	C	D	E	WEIGHT (in ounces)	
						PP	PVDF
w/o bottle	3.18	2.10				7.17	15.06
1 PT			8.62		-		
1 QT	-	-	10.62		-		
2QT	-	-	11.65		-		

All weights are approximate.

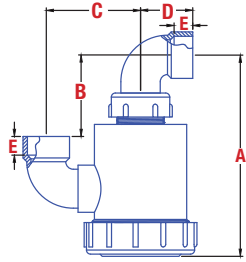

Drum Trap - DT1

SIZE	A	B	C	D	E	WEIGHT (in ounces)	
						PP	PVDF
1½	9.83	3.98	4.60	2.38	0.88	23.80	49.98
2	10.34	3.66	5.66	3.40	1.00	28.28	59.39

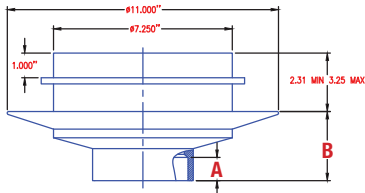

Floor Drain FD-1

SIZE (In.)	A	B	C	D	E	WEIGHT (in ounces)	
						PP	PVDF
2	4.59	1.05	-	-	-	45.57	95.18
3	5.34	1.30	-	-	-	42.43	89.04
4	5.34	1.30	-	-	-	50.18	105.77
6	7.13	2.00	-	-	-	85.28	179.99

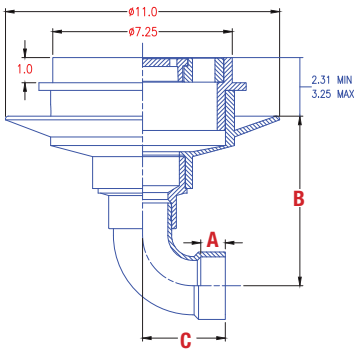

Floor Drain with Side Outlet - FD-2

SIZE (In.)	A	B	C	D	E	WEIGHT (in ounces)	
						PP	PVDF
2	1.00	6.92	3.38	-	-	50.23	105.29
3	1.42	6.01	4.50	-	-	60.13	121.99
4	1.36	6.60	5.25	-	-	62.58	125.12

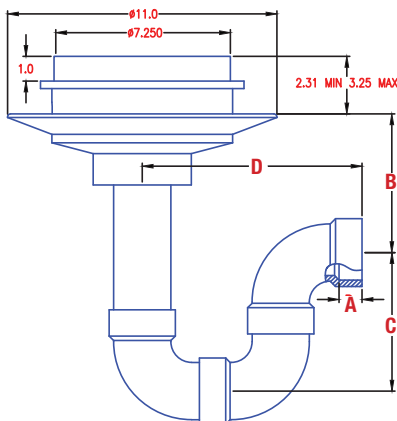

Floor Drain with Integral Trap - FD-3

SIZE (In.)	A	B	C	D	E	WEIGHT (in ounces)	
						PP	PVDF
2	1.00	6.20	5.78	9.15	-	58.26	118.22
3	1.44	6.39	7.59	12.11	-	85.59	175.32
4	1.36	2.95	8.90	14.15	-	102.69	205.77

Installation Considerations for Orion Chemical Waste Drainage Piping Systems

Transportation, Delivery, and Storage

Unlike some other piping materials, many types of thermoplastic piping are susceptible to damage from rough handling. Appropriate care must be taken when transporting, handling, and storing Orion piping to prevent nicking, abrading, crushing, and other types of damage that will have a direct effect on the integrity and performance of the assembled piping system. The diagrams to the right illustrate correct and incorrect examples of transporting, handling, and storage of Orion piping.

When transporting Orion pipe, use pallets to avoid damage from tow motor forks and scraping across floors. Unload pipe using textile slings rather than metal slings or wire cable. To avoid damage especially to pipe ends, care must be taken when handling bundles of pipe or individual pieces: do not drop, drag, or throw pipe. Always ensure that protective wrapping is kept intact until the product is installed. Care must be taken to avoid any sharp metallic edges such as on metal strapping or banding, nail or screw ends protruding from pallets, etc. At low temperatures extra care must be taken: the piping will have less ductility and will be more susceptible to impact damage.

To avoid deformation, a solid, flat, and level base must be provided for Orion pipe while being transported and stored. Pipe should always be stacked in parallel, not askew, to provide full-length support and avoid bowing. When storing pipe on pipe racks, continuous support along the full pipe length is best; if horizontal support arms are used instead, the bearing surfaces should be 3 inches wide minimum and spaced no more than 3 ft apart. To avoid ovaling of the bottom layers, do not stack pipe more than six layers high. When securing pipe, do not use steel banding without cardboard or similar padding between the banding and the pipe. Do not mechanically over-tighten banding as this could cause larger diameter pipes to deform out of round.

Ideally, Orion pipe should always be stored indoors. Brownline PP and Blueline FRPP piping will be damaged by exposure to UV radiation: pipe exposed to sunlight will quickly form a thin oxidation layer on its surface. While this will not affect the ability to make No-Hub grooved joints, and may not affect thermal socket fusion joints, it will interfere with the Rionfuse electrofusion joint process and greatly increase the likelihood of joint failure. If Brownline or Blueline pipe must be stored outdoors, it should be for as short a time as possible and completely covered with UV-resistant tarpaulins or similar to avoid damage. Plenum Plus PVDF pipe is fully UV-resistant; however, exposure to UV will cause it to develop a slight bluish tinge that will be visible when installed alongside pipe that has not been UV-exposed. Shielding pipe that has developed this bluish tinge will cause it to eventually revert back to the original cream color. This color shift is similar to a human suntan and has zero effect on the piping material or performance characteristics.

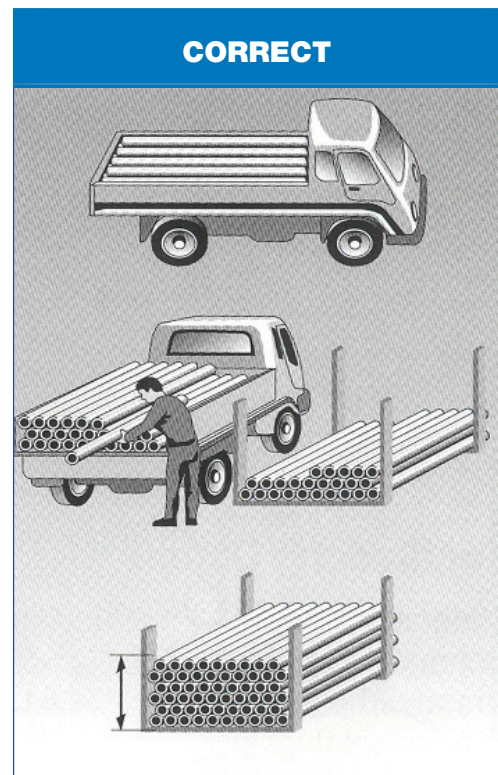
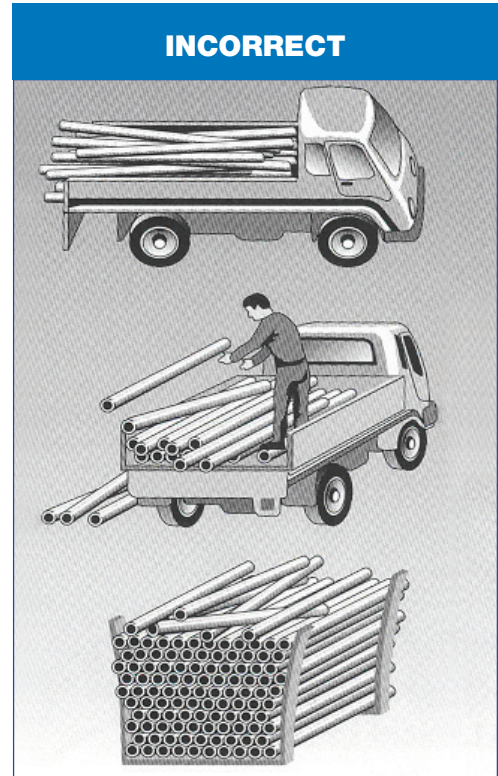

Above Ground Installation

Orion chemical waste drainage systems are designed to allow for ¼ inch per ft pitch. Installation should be planned to allow for full usage of this pitch to promote proper drainage of the chemical waste. Both polypropylene and PVDF have higher thermal expansion rates than some other piping materials, which precludes the use of anchors to restrict movement from thermal expansion incurred from chemical reactions, ambient temperature fluctuations, or the dumping of hot water into the chemical waste piping system.

Orion chemical waste drainage systems are designed for gravity flow. Some low-pressure and vacuum applications may be possible, but should only be considered in consultation with the Orion Engineering department at oriontechs@wattswater.com or 910-865-7530. Do not use compressed air or other compressed gases for testing or use without first seeking application-specific guidance from Orion Engineering.

NOTICE

Orion **DOES NOT RECOMMEND** connecting pipe and fittings with No-Hub couplings in systems used for dumping hot water appliances such as autoclaves, sterilizers, labware dishwashers, etc. For these systems Orion socket fusion or Rionfuse coil fusion is recommended on main stacks carrying hot water, and all runs within 75 ft of such appliances.

Where thermal expansion and contraction of the piping system is anticipated, the effects can be controlled by including sufficient directional changes in the piping, or by including expansion loops in the system design. Temperature changes of less than 30°F will result in thermal expansion effects that are most often compensated for by the inherent flexibility of the piping system and its directional changes. Expansion loops should be considered to accommodate thermal expansion in temperature changes of greater than 30°F.

Coefficients of Thermal Expansion

FRPP/PP 0.61 (IN./10°F/100 FT)

PVDF 0.75 (IN./10°F/100 FT).

THERMAL EXPANSION TABLE: POLYPROPYLENE (PP)

PIPE RUN LENGTH (FT)	DELTA T						
	40°F	50°F	60°F	70°F	80°F	90°F	100°F
20	0.57"	0.70"	0.85"	0.99"	1.13"	1.27"	1.42"
40	1.13"	1.42"	1.67"	1.98"	2.27"	2.55"	2.83"
60	1.70"	2.12"	2.55"	2.97"	3.40"	3.82"	4.25"
80	2.27"	2.83"	3.40"	3.97"	4.53"	5.10"	5.66"
100	2.83"	3.54"	4.25"	4.96"	5.66"	6.37"	7.08"

THERMAL EXPANSION TABLE: POLYVINYLIDENE FLUORIDE (PVDF)

PIPE RUN LENGTH (FT)	DELTA T						
	40°F	50°F	60°F	70°F	80°F	90°F	100°F
20	0.72"	0.90"	1.08"	1.26"	1.44"	1.62"	1.80"
40	1.44"	1.80"	2.16"	2.52"	2.88"	3.24"	3.60"
60	2.16"	2.70"	3.24"	3.78"	4.32"	4.86"	5.40"
80	2.88"	3.60"	4.32"	5.04"	5.76"	6.48"	7.20"
100	3.60"	4.50"	5.40"	6.30"	7.20"	8.10"	9.00"

Orion recommends the use of clevis or loop type pipe hangers. All horizontal supports should provide a wide bearing surface and should be installed such that uniform piping run alignment is maintained. If split-ring or other hanger types are used, the hanger should be a size larger than the pipe being supported to allow the pipe to move freely. When selecting pipe hangers, avoid those with sharp edges or burrs that could scrape or peel expanding and contracting piping. Smaller pipe sizes with elevated operating temperatures will benefit from continuous channel support.

NOTICE

The use of uni-strut type hangers or any hanger that relies on clamp tightness for support voids manufacturer's warranty.

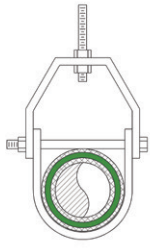

Adjustable Steel Clevis



Adjustable Steel Band Hanger

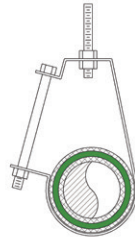

Offset J-Hook

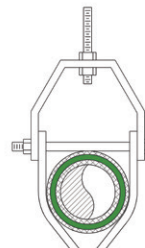

Vee Bottom Clevis Hanger

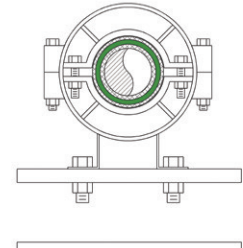

Pipe Alignment Guide Hanger

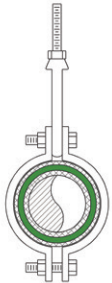

Steel Pipe Clamp

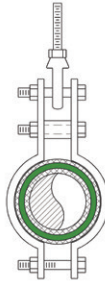

Steel Double Bolt Pipe Clamp

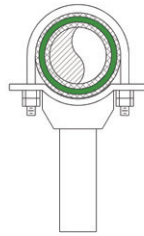

Pipe Stanchion Saddle



Pipe Saddle Support

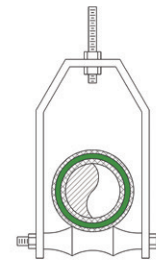

Adjustable Roller Hanger

RECOMMENDED HANGER SPACING FOR ORION DRAINAGE SYSTEMS SCHEDULE 40 AND SCHEDULE 80*			
POLYPROPYLENE (SCHEDULE 40, SCHEDULE 80)		PVDF (SCHEDULE 40)	
Pipe Size (inches)	Hanger Spacing (feet)	Pipe Size (inches)	Hanger Spacing (feet)
1.5	4	1.5	4.5
2	4	2	5
3	5	3	5.5
4	6	4	6
6	6	6	7
8	6	n/a	n/a
10	7	n/a	n/a
12	7	n/a	n/a

*Or per code, or as directed by the authority having jurisdiction.

The above recommended pipe support information is based on Orion pipe supported on uniform centers, carrying liquids of up to 1.30 specific gravity and without major load concentration. These recommendations are for uninsulated lines; if the piping is insulated, reduce the above spans by 35% to accommodate the weight of insulation. Never support pipe in tight clamps; piping system must be free to allow for axial movement.

Where vertical expansion of the piping run is of concern, either variable or constant support type spring hangers may be used at the bottom of the run. Risers should be fully supported but not clamped at each floor or every 10 ft. Ensure that sufficient space is left between riser supports and piping connections to permit free axial but not traverse movement of the piping.

Where extreme operating temperature variations or

elevated operating temperatures are anticipated, please consult the Orion Engineering department at oriontechs@wattswater.com or 910-865-7530 for application-specific piping support guidance.

Chemical waste drainage systems are often required by code to be vented separately from sanitary waste due to the effects of corrosive fumes on vent piping. BlueLine FRPP system vents should be painted or wrapped from the point of roof penetration onward, to protect vent piping from UV effects. Where FRPP vent lines must be run up an exterior building wall, all of the exposed piping must be painted, wrapped or boxed. Plenum Plus PVDF vent lines are UV resistant and need no painting or wrapping. For some installations it may be advantageous to transition from FRPP to PVDF using No-Hub couplings for any UV-exposed vent lines.

Underground Installation

Attention to bedding, haunching, initial and final backfilling, and compaction procedures is critical to:

- 1) prevent damage to piping connections
- 2) maintain correct alignment and grade
- 3) maximize piping resistance to soil load

Further information on this topic is contained within the following standards:

ASTM D2321-18 Standard Practice for Underground Installation of Thermoplastic Pipe for Sewers and Other Gravity-Flow Applications

CAN/CSA B182.11 Recommended Practice for the Installation of Thermoplastic Drain, Storm and Sewer Pipe and Fittings

Pipe Trench Diagram

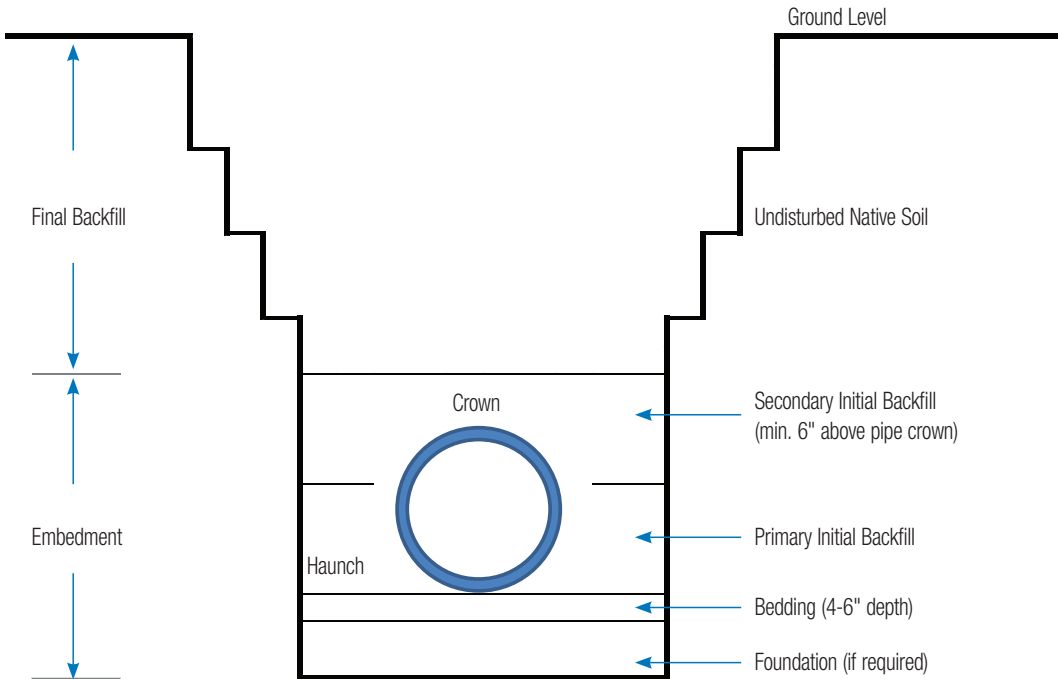

TRENCH DEPTH GENERAL GUIDELINES (ALWAYS CONFIRM WITH THE APPROPRIATE ENGINEER)

Exposed Location	the greater of 1 pipe diameter above installed pipe crown or 1 foot
Heavy Overhead Traffic	minimum of 2 feet above installed pipe crown
Ground Freezing	installed pipe crown at least 1 foot below frost line
Under Slab	minimum of 1 foot above installed pipe crown and bottom of slab

Orion thermoplastic PP, FRPP, and PVDF piping systems are categorized as flexible piping systems. As such, their resistance to soil loads is based on their deflecting and transferring a portion of the vertical soil load to their sidefill. To achieve this, install the piping in a trench at least 1 ft wider at the springline (halfway up pipe diameter) than the outside diameter of the piping, and no wider at the top of the piping than the pipe outside diameter plus 2 ft. If these optimal widths must be exceeded, the soil should be compacted on each side of the piping to the lesser of 2.5X pipe outside diameter or full trench width. Due to site condition variables, all final decisions on trench design should be made for the specific installation by the appropriate engineer or other authority having jurisdiction.

NOM. SIZE	WC' = LOAD RESISTANCE OF PIPE (LB/FT.)				HEIGHT OF FILL ABOVE PIPE (FT.)	WC = SOIL LOADS AT VARIOUS TRENCH WIDTHS AT TOP OF PIPE (LB/FT.)		
	SCHEDULE 40 PIPE		SCHEDULE 80 PIPE			2 FT.	3 FT.	4 FT.
	E' = 1000	E' = 2000	E' = 1000	E' = 2000				
1 1/2	756	1149	1343	1709	10	106	125	136
					20	138	182	212
					30	144	207	254
2	780	1284	1274	1747	10	132	156	170
					20	172	227	265
					30	180	259	317
3	1098	1846	1663	2381	10	196	231	252
					20	256	336	392
					30	266	384	469
4	1259	2241	1745	2679	10	252	297	324
					20	328	432	502
					30	342	493	603
6	1688	3166	2188	3594	10	371	437	477
					20	484	636	742
					30	503	725	888
8	2134	4081	2571	4432	10	483	569	621
					20	630	828	966
					30	656	945	1156
10	2619	5064	3095	5429	10	602	710	774
					20	785	1032	1204
					30	817	1177	1405
12	3083	5996	3616	6392	10	714	842	918
					20	931	1225	1429
					30	969	1397	1709

Note 1: Figures are calculated from minimum soil resistance values (E' = 200psi for uncompacted sandy clay loam) and compacted soil (E' = 700 for side fill soil that is compacted to 90% or more of Proctor Density for distance of two pipe diameters on each side of the pipe). If Wc' is less than Wc at a given trench depth and width, then solid compaction will be necessary.

Note 2: These are soil loads only and do not include live loads.

$$Wc' = x(EI = 0.061 E'r^3)80$$

Wc' = Load Resistance of the pipe lb./ft.

x = Deflection in Inches @ 5% (.05 x ID)

E = Modulus of Elasticity = 2×10^5 psi

t = Pipe Wall Thickness, in.

r = Mean Radius of Pipe (OD - t) / 2

E' = Modulus of Passive Soil Resistance, psi

H = Height of Fill Above Top of Pipe, ft.

I = Moment of Inertia $t^3/12$

Trench depth for piping installed in exposed locations should allow for a minimum of one pipe diameter above the top of the installed piping or 1 ft, whichever is greater. Trenches located where piping will be subjected to heavy or continuous overhead traffic should allow for a minimum of 2 ft above the top of the installed piping. In latitudes subject to ground freezing the top of the installed piping should be at least 1 ft below the frost line. Under slab trenches should provide a minimum of 1 ft clearance between the top of the installed piping and bottom of the slab.

The trench must be dewatered and kept free of water incursion. The trench bottom should be smooth, continuous and free of debris, loose stones, or outcroppings. Unstable subgrades should be excavated and refilled with a suitable foundation material. The trench should then be backfilled with clean #10 screenings as bedding to a depth of 4 inches. Where rock or hardpan is present, increase depth to 6 inches. Bedding should be placed and compacted to equalize load distribution along the pipe invert.

Install piping on top of bedding material at proper grade for drainage: do not use blocks or other intermittent supports to establish grade as this will result in point loading and damage to the piping. Leaving all joints exposed for testing, carefully backfill the straight lengths of piping with #10 screenings to $\frac{3}{4}$ of the pipe diameter, taking care to remove and fill any voids under the haunch of the pipe. Hand-compact the backfill to the required density, taking care not to strike or dislodge the piping from correct grade and horizontal alignment. If the piping is dislodged it must be relaid to correct grade. Continue backfilling to a depth of 6-8 inches above top of piping. After testing, complete initial backfilling of the exposed joints to a depth of 6-8 inches above top of piping, then hand-compact to the required density. Final backfilling may then be performed, ensuring that sufficient backfill of a suitable nature is placed to prevent damage before using heavy compaction equipment directly over the piping.

Temperature Effects on Hot and Cold Weather Installation

Extra care must be taken when installing Orion piping systems in cold weather. In lower temperatures the piping will have less ductility and be more susceptible to impact damage. Piping left in a storage trailer in subfreezing temperatures may not seal as effectively when joined to fittings and couplings that have been left inside a heated area. Thermal fusion requirements will also differ at higher and lower temperatures. Whenever possible, pipe, fittings and couplings should all be warmed to and installed at the same temperature; installation temperatures should be higher than 40°F. When thermal fusion is the joining method it is essential to protect the fusion area and all components from wind which will strip heat from the joints. Tenting and use of thermal blankets may be necessary when assembling and installing in cold weather.

In hot weather or when product installation temperatures are significantly higher than expected operating temperatures, there is a risk of stressing the piping system once it has contracted when temperatures normalize. Pipe and fittings left exposed to sun during the summer months can reach surface temperatures of 150°F. If assembled and installed in a trench or indoors where actual operating temperatures are in the 60-75°F range, the resulting amount of thermal contraction could be enough to cause mechanical No-Hub connections to fail due to pull-out. Whenever possible, the piping and fittings should be stored at or close to anticipated ambient usage temperatures for the 24 hours preceding installation. In hot weather it will often be best practice to install Orion product early in the morning and keep stored product shaded on site.

If there is any doubt as to installation temperature issues please contact the Orion Engineering department before proceeding at oriontechs@wattswater.com or 910-865-7530.

Testing Procedures

Orion recommends testing the piping system in sections not to exceed 1000 ft. After fully inspecting the installed piping for mechanical damage and visually suspect joints, use expandable plugs to cap off each section to be tested. Slowly fill piping with water one section at a time, removing all trapped air in the section using air release valves at high points in the system. Once the section is filled with water and all air has been purged, let sit for at least one hour to allow an equilibrium temperature to be reached, which will minimize thermal expansion effects. Visually inspect the section for leaks; if clear, check for and remove any remaining air in the system. Pressurize the system to a maximum of 10 ft head by means of a standard 10-ft standing water test using a 10-ft vertical riser, or a low pressure hand pump. Leave the system at 10 ft of head pressure for up to eight hours or as required by the authority having jurisdiction, during which time the water level should not change for a standing water test nor should the pressure gauge reading change for a hand pump test.

If there is a significant drop in pressure or extended times are required to achieve the correct pressure, either joint leakage has occurred or there is still air trapped in the piping section. In this event, inspect for joint leaks. If none are found, check for trapped air; this air must be removed prior to continuing the test.

If joints are found to be leaking, the system must be fully drained and the joints must be repaired. Once all leaking joints have been repaired, repeat the test procedure as outlined above.

WARNING

Do not use compressed air or other compressed gases for testing or use – severe injury or death could result.

Repair Procedures

If Rionfuse joints leak during testing, they will need to be dried before repairing them. Dry Rionfuse RFCF joints can be easily re-fused by following the procedures in the assembly instructions. Rionfuse joints may be re-fused a maximum of two times; after this the repetition of heating and cooling the joint will produce undesirable changes in the material properties of the plastic. After re-fusing, allow the joint to naturally cool back down to ambient before repeating the test procedure as outlined above.

If No-Hub coupling joints leak during testing, it is often possible to correct the leak by slightly tightening or loosening the coupling bolts. If the leak persists, No-Hub couplings may be disassembled, cleaned, inspected for abrasion, tearing or other physical assembly damage, then carefully reassembled and tightened as described in the assembly instructions. If damaged, the coupling will need to be replaced.

If socket fusion connections leak during testing, it will be necessary to dry the joint and then carefully back-weld around the fitting socket mouth where the pipe has been inserted. Ensuring that the pipe and socket mouth interface has been heated before firmly applying the heated and softened weld rod to the joint, and ensuring that the weld bead is completely sealed as a continuous circle around the pipe will maximize the likelihood of a successful repair. After back-welding, allow the joint to naturally cool back to ambient before repeating the test procedure as outlined above.

If leaking joints persist, before proceeding please contact the Orion Engineering department at oriontechs@wattswater.com or 910-865-7530.



Floor Drain FD-1

Complete with Grate and Plug

Recommended Specification:

ORION FD-1 corrosion resistant Floor Drain manufactured from fire retardant polypropylene material conforming to ASTM D4101. Grate, plug, and covers are to be made from fiber-filled polypropylene for strength and durability.

ORION FD-1 corrosion resistant Floor Drain manufactured from PVDF material conforming to ASTM D3222. Grate, plug, and covers are to be made from fiber-filled polypropylene for strength and durability.

Note: Funnel replaces plug in FD-1 grate.

Sizes and Connections

- 2", 3", 4", 6"
- No-Hub, Socket Fusion (pictured)

Accessories Available

- Sediment Bucket
- Flashing Clamp
- 1/2" Trap Primer
- Solid Cover
- Funnel
- Vandal Proofing

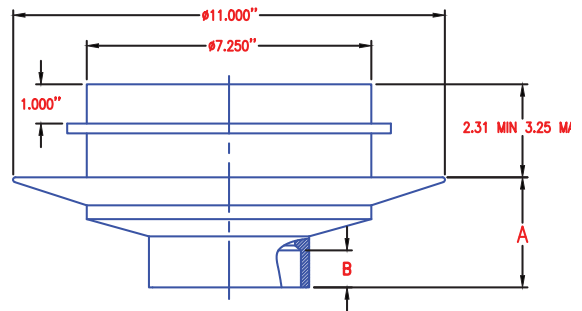
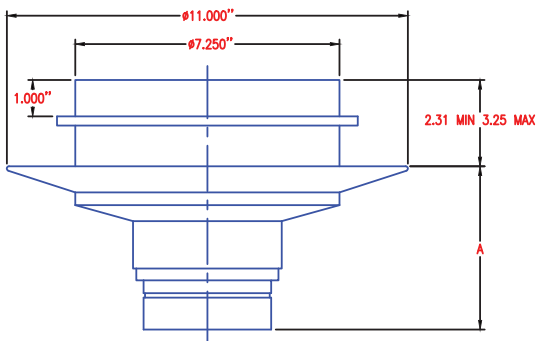

No-Hub Connection

SIZE (In.)	A	WEIGHT (in ounces)	
		PP	PVDF
2	4.40	45.57	95.18
3	4.61	42.43	89.04
4	4.66	50.18	105.77
6	3.58	85.28	179.99

Socket Fusion Connection

SIZE (In.)	A	B	WEIGHT (in ounces)	
			PP	PVDF
2	4.59	1.05	46.50	94.66
3	5.34	1.30	43.30	90.77
4	5.34	1.30	44.10	91.84
6	7.13	4.74	80.26	165.44

All weights are approximate.



Floor Drain FD-2

Complete with Grate and Plug (Side Outlet)

Recommended Specification:

ORION FD-2 corrosion resistant Floor Drain manufactured from Fire Retardant Polypropylene material conforming to ASTM D4101. Grate, plug, and covers are to be made from fiber-filled polypropylene for strength and durability.

ORION FD-2 corrosion resistant Floor Drain manufactured from PVDF material conforming to ASTM D3222. Grate, plug, and covers are to be made from fiber-filled polypropylene for strength and durability.

Sizes and Connections

- 2", 3", 4"
- No-Hub, Socket Fusion (pictured)

Accessories Available

- Sediment Bucket
- Flashing Clamp
- 1/2" Trap Primer
- Solid Cover
- Funnel
- Vandal Proofing

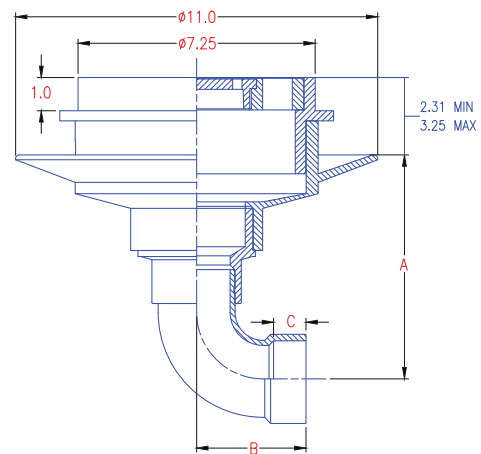
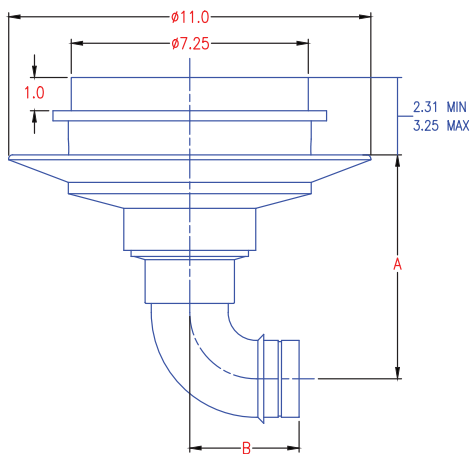

No-Hub Connection

SIZE (In.)	(MIN.) A	B	C	WEIGHT (in ounces)	
				PP	PVDF
2	6.95	3.41	-	50.23	105.29
3	6.08	4.53	-	60.13	121.99
4	6.90	5.25	-	62.58	125.12

Socket Fusion Connection

SIZE (In.)	A	B	C	WEIGHT (in ounces)	
				PP	PVDF
2	1.00	6.92	3.38	50.23	105.29
3	1.42	6.01	4.50	60.13	121.99
4	1.36	6.60	5.25	62.58	125.12

All weights are approximate.



Floor Drain FD-3

Complete with Grate and Plug
(Integral P-Trap)

Recommended Specification:

ORION FD-3 corrosion resistant Floor Drain manufactured from Fire Retardant Polypropylene material conforming to ASTM D4101. Grate, plug, and covers are to be made from fiber-filled polypropylene for strength and durability.

ORION FD-3 corrosion resistant Floor Drain manufactured from PVDF material conforming to ASTM D3222. Grate, plug, and covers are to be made from fiber-filled polypropylene for strength and durability.

Sizes and Connections

- 2", 3", 4"
- No-Hub (pictured), Socket Fusion

Accessories Available

- Sediment Bucket
- Flashing Clamp
- 1/2" Trap Primer
- Solid Cover
- Funnel
- Vandal Proofing

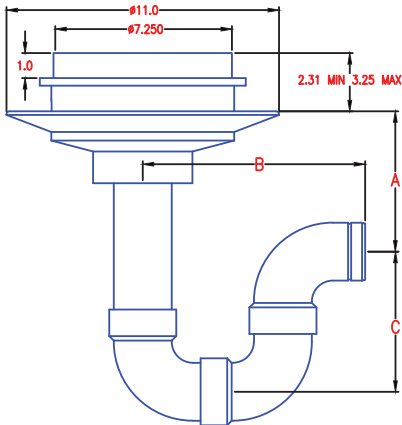

No-Hub Connection

SIZE (In.)	A	B	C	D	WEIGHT (in ounces)	
					PP	PVDF
2	8.42	9.13	5.75	–	58.26	118.22
3	5.90	12.08	7.58	–	85.59	175.32
4	5.30	15.16	9.60	–	102.69	205.77

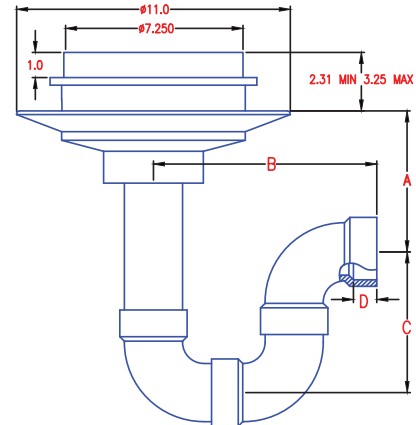

Socket Fusion Connection

SIZE (In.)	A	B	C	D	WEIGHT (in ounces)	
					PP	PVDF
2	6.20	9.15	5.78	1.00	58.26	118.22
3	6.39	12.11	7.59	1.44	85.59	175.32
4	6.04	14.15	9.60	1.36	102.69	205.77

All weights are approximate.



Max. Top Adjustment 1 1/2"

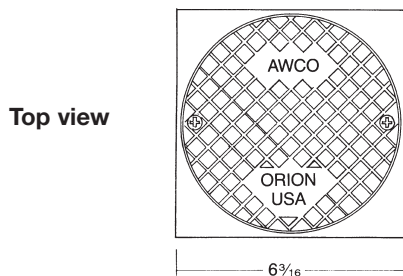
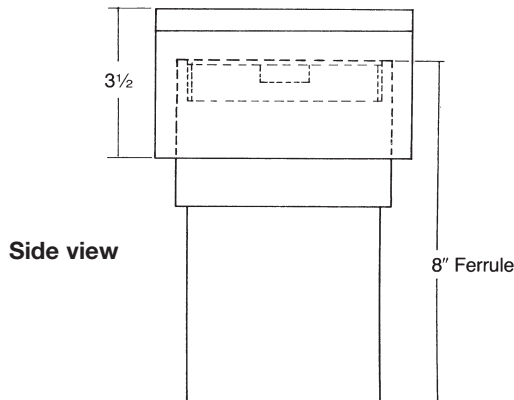

Floor Cleanout FCO

Corrosion Resistant Finished Floor Cleanout

In applications where a cleanout is required in a finished floor, Orion offers either a nickel bronze or brushed bronze cover. The letters AWCO (Acid Waste Cleanout) are cast in the cover to help prevent confusion with a sanitary sewer cleanout if maintenance is required. Both styles of covers are supplied with a ferrule with a countersunk plug and adjustable top to facilitate easy installation when the floor is poured.

Recommended Specification:

ORION FCO corrosion resistant finished floor cleanout. Manufactured from fire retardant polypropylene material conforming to ASTM D 4101, ferrule supplied with countersunk plug and adjustable top with round or square, nickel bronze or brushed bronze cover, with AWCO (Acid Waste Cleanout) cast in cover.

ORION FCO corrosion resistant finished floor cleanout. Manufactured from PVDF material conforming to ASTM D 3222, ferrule supplied with countersunk plug and adjustable top with round or square, nickel bronze or brushed bronze cover, with AWCO (Acid Waste Cleanout) cast in cover.



Max. Top Adjustment 1¼"

Adjustable Combination Floor Cleanout

Corrosion Resistant Finished Floor Cleanout

In applications where a compact, height adjustable finished floor cleanout is required, Orion offers a combination stainless steel top assembly threaded into a corrosion resistant thermoplastic lower assembly.

Recommended Specification:

ORION FCO corrosion resistant finished floor cleanout. Manufactured from fire retardant polypropylene material conforming to ASTM D 4101, supplied with countersunk plug and adjustable stainless steel top assembly with round stainless steel cover.

ORION FCO corrosion resistant finished floor cleanout. Manufactured from PVDF material conforming to ASTM D 3222, supplied with countersunk plug and adjustable stainless steel top assembly with round stainless steel cover.

Sizes and Connections

- 2", 3", 4"
- No-Hub, Socket Fusion (both pictured)

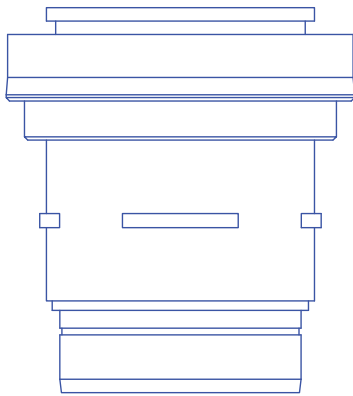

No-Hub

SIZE:	A	B	WEIGHT (IN OUNCES)	
			PP	PVDF
2	6.28	6.45	83.89	125.8
3	6.56	6.45	84.69	127.03
4	6.68	6.45	85.33	128.00

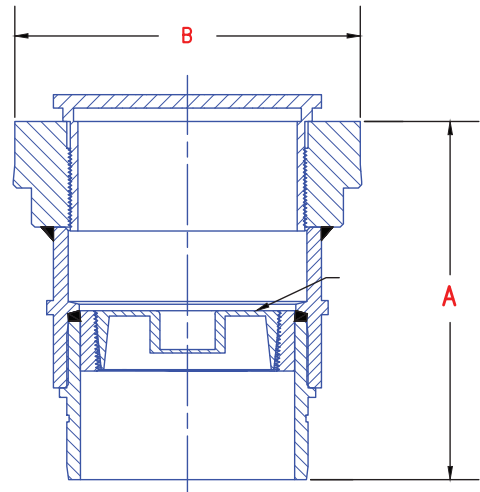

Socket Fusion

SIZE:	A	B	WEIGHT (IN OUNCES)	
			PP	PVDF
2	6.28	6.45	83.89	125.83
3	6.56	6.45	84.69	127.03
4	6.68	6.45	85.33	128.00

All weights are approximate.

Polypropylene Schedule 40

Pipe:

Fire Retardant Blueline Schedule 40: Orion's Blueline chemical waste pipe will be manufactured to the dimensions and tolerances of ASTM F1412 from fire retardant material in 10 ft lengths. Pipe will be cylindrical and straight. Pipe will be supplied with factory grooves. The polypropylene material will conform to ASTM D4101.

Non-Fire Retardant Brownline Schedule 40: Orion's Brownline chemical waste pipe will be manufactured to the dimensions and tolerances of ASTM F1412 from non-fire retardant material in 10 ft lengths. Pipe will be cylindrical and straight. Pipe will be supplied with factory grooves. The polypropylene material will conform to ASTM D4101.

Fittings:

Orion's Blueline chemical waste fittings will be manufactured to schedule 40 dimensions per ASTM F1412 and will be made of fire retardant polypropylene. Fitting layouts will conform to ASTM D3311 and ASTM F1412. The polypropylene material will conform to ASTM D4101.

Joining Methods:

No-Hub Mechanical Joint: Pipe and fittings will be joined using the No-Hub method, utilizing all factory-grooved pipe end fittings joined with Orion's No-Hub couplings. All couplings will have a chemical resistance equal to the pipe and fittings. Each No-Hub coupling will have an outer band of 300 series stainless steel with 5/16" bolts, nuts and washers plated to meet a 100-hour salt spray test per ASTM B117. The No-Hub joint will conform to the requirements of ASTM F1412.

Rionfuse CF (Clamp-Free) Electrofusion: The Orion Rionfuse CF system will utilize the same factory-grooved pipe end fittings as the No-Hub system, but are to be joined using the Rionfuse CF couplings. The Rionfuse machine will be used to produce a hermetically sealed joint. The joints will conform to ASTM 1290, Technique 1.

Socket Fusion: All fittings are to be socket end. All joints are to be made with Orion's heat tools to produce a hermetically sealed joint. Joints and joining procedures will conform to ASTM 2657, Technique 1.

Polyvinylidene Fluoride (PVDF) Schedule 40

Pipe:

PVDF Schedule 40: Orion's Plenum Plus chemical waste pipe will be manufactured to the dimensions and tolerances of ASTM F1673 from PVDF material in 10 ft lengths. Pipe will be cylindrical and straight. Pipe will be supplied with factory grooves. The PVDF material will conform to ASTM D3222.

Fittings:

Orion's Plenum Plus chemical waste fittings will be manufactured to schedule 40 dimensions per ASTM F1673 and will be made of PVDF material. Fitting layouts will conform to ASTM D3311 and ASTM F1673. The PVDF material will conform to ASTM D3222.

Joining Methods:

No-Hub Mechanical Joint: Pipe and fittings will be joined using the No-Hub method, utilizing all factory-grooved pipe end fittings joined with Orion's No-Hub couplings. All couplings will have a chemical resistance equal to the pipe and fittings. Each No-Hub coupling will have an outer band of 300 series stainless steel with 5/16" bolts, nuts and washers plated to meet a 100-hour salt spray test per ASTM B117. The No-Hub joint will conform to the requirements of ASTM F1673.

Rionfuse CF (Clamp-Free) Electrofusion: The Orion Rionfuse CF system will utilize the same factory-grooved pipe end fittings as the No-Hub system, but are to be joined using the Rionfuse CF couplings. The Rionfuse machine will be used to produce a hermetically sealed joint. The joints will conform to ASTM 1290, Technique 1.

Socket Fusion: All fittings are to be socket end. All joints are to be made with Orion's heat tools to produce a hermetically sealed joint. Joints and joining procedures will conform to ASTM 2657, Technique 1.

Any table of this type should be used only as a guide: it is often impossible to duplicate actual operating conditions. In this table, all chemicals are assumed to be in their pure state or in concentrated or saturated aqueous solutions unless otherwise indicated. Concentration percentages used are by weight. Source is referenced at the end of this table.

Chemical compatibility temperature limits in this table are superceded for all applications by Orion piping system maximum service temperatures defined by the combination of both material and joining method.

Temperature values listed are the maximum compatibility temperatures for the material only.

NR indicates that the listed corrodent is Not Recommended for use with the material.

--- indicates that there is no test data available for the listed corrodent and material.

If there is any doubt regarding chemical compatibility, please consult Orion Technical Services.

CHEMICAL OR SUBSTANCE NAME: CONCENTRATION	POLYPROPYLENE (PP)		POLYVINYLIDENE FLUORIDE (PVDF)	
	°F	°C	°F	°C

Acetaldehyde	120	49	150	66
Acetamide	110	43	90	32
Acetate Solvents, Crude	90	32	90	32
Acetate Sovents, Pure	90	32	90	32
Acetic Acid: 5%	220	104	300	149
Acetic Acid: 10%	220	104	300	149
Acetic Acid: 20%	220	104	300	149
Acetic Acid: 30%	200	93	300	149
Acetic Acid: 80%	200	93	190	88
Acetic Acid: Glacial	190	88	190	88
Acetic Anhydride	100	38	100	38
Acetone	220	104	NR	NR
Acetone, 50% Water	90	32	100	38
Acetonitrile	90	32	140	60
Acetophenone	140	60	230	110
Acetyl Chloride	NR	NR	120	49
Acetylene	90	32	220	104
Acetylene Tetrabromide	NR	NR	250	121
Acrylic Acid	NR	NR	150	66
Acrylonitrile	90	32	130	54
Adipic Acid	140	60	280	138
Alcohol, Allyl	140	60	200	93
Alcohol, Amyl	200	93	280	138
Alcohol, Benzyl	140	60	280	138
Alcohol, Butyl	200	93	280	138
Alcohol, Ethyl	180	82	280	138
Alcohol, Isopropyl	210	99	260	127
Alcohol, Methyl	190	88	280	138
Alcohol, Propyl	210	99	250	121
Allyl Chloride	140	60	200	93
Alum (Aluminum Potassium Sulfate)	220	104	210	99
Alum Ammonium	250	121	300	149
Alum Ammonium Sulfate	200	93	260	127
Alum Chrome	220	104	300	149
Alum Potassium	220	104	300	149
Aluminum Acetate (Saturated)	100	38	250	121
Aluminum Bromide	170	77	250	121
Aluminum Chloride Aqueous	200	93	300	149

CHEMICAL OR SUBSTANCE NAME: CONCENTRATION	POLYPROPYLENE (PP)		POLYVINYLIDENE FLUORIDE (PVDF)	
	°F	°C	°F	°C

Aluminum Chloride Dry	220	104	270	132
Aluminum Fluoride (Saturated)	200	93	300	149
Aluminum Hydroxide	200	93	260	127
Aluminum Nitrate (Saturated)	200	93	300	149
Aluminum Oxychloride	---	---	280	138
Aluminum Potassium Sulfate (Potash Alum)	200	93	280	138
Aluminum Sulfate (Saturated)	220	104	300	149
Ammonia (Anhydrous)	220	104	280	138
Ammonia Gas	150	66	270	132
Ammonium Acetate	140	60	180	82
Ammonium Bicarbonate	230	110	---	---
Ammonium Bifluoride	200	93	260	127
Ammonium Bromide: 5%	60	16	300	149
Ammonium Carbonate (Saturated)	220	104	280	138
Ammonium Chloride: 10%	180	82	280	138
Ammonium Chloride: 28%	180	82	280	138
Ammonium Chloride: 50%	180	82	280	138
Ammonium Chloride (Saturated)	200	93	280	138
Ammonium Dichromate	120	49	250	121
Ammonium Fluoride: 10%	210	99	280	138
Ammonium Fluoride: 25%	200	93	280	138
Ammonium Hydroxide: 10%	220	104	280	138
Ammonium Hydroxide: 25%	200	93	280	138
Ammonium Hydroxide (Saturated)	200	93	280	138
Ammonium Metaphosphate	170	77	270	132
Ammonium Nitrate	200	93	280	138
Ammonium Oxalate: 10-30%	220	104	---	---
Ammonium Persulfate	220	104	280	138
Ammonium Phosphate	200	93	280	138
Ammonium Sulfate: 10-40%	200	93	280	138
Ammonium Sulfide	220	104	280	138
Ammonium Sulfite	220	104	280	138
Ammonium Thiocyanate	140	60	280	138
Amyl Acetate	NR	NR	190	88
Amyl Chloride	NR	NR	190	88
Aniline	180	82	300	149
Aniline Hydrochloride	170	77	120	49

Chemical Resistance Chart

CHEMICAL OR SUBSTANCE NAME: CONCENTRATION	POLYPROPYLENE (PP)		POLYVINYLIDENE FLUORIDE (PVDF)	
	°F	°C	°F	°C
Anthraquinone	NR	NR	270	132
Anthraquinone Sulfonic Acid	NR	NR	280	138
Antimony Trichloride	180	82	150	66
Aqua Regia 3:1	NR	NR	170	77
Arsenic Acid	210	99	280	138
Asphalt	140	60	250	121
Barium Carbonate (Saturated)	200	93	280	138
Barium Chloride (Saturated)	220	104	280	138
Barium Hydroxide (Saturated)	200	93	280	138
Barium Nitrate	210	99	270	132
Barium Sulfate	200	93	280	138
Barium Sulfide	200	93	260	127
Beer	280	138	250	121
Beet Sugar Liquors	160	71	250	121
Benzaldehyde	80	27	120	49
Benzene, Benzol	140	60	150	66
Benzene Sulfonic Acid: 10%	180	82	250	121
Benzene Sulfonic Acid: 100%	90	32	90	32
Benzoic Acid	190	88	250	121
Benzoyl Chloride	NR	NR	170	77
Benzyl Chloride	80	27	280	138
Bismuth Carbonate	230	110	280	138
Black Liquor	140	60	260	127
Bleach: 12.5% Active Chlorine	140	60	280	138
Borax (Sodium Borate)	210	99	280	138
Boric Acid	220	104	280	138
Brine Acid	230	110	280	138
Bromic Acid	140	60	220	104
Bromine Gas, Dry	NR	NR	210	99
Bromine Gas, Moist	NR	NR	210	99
Bromine Liquid	NR	NR	140	60
Bromine Water	NR	NR	210	99
Bromobenzene	NR	NR	170	77
Butane	170	77	250	121
Butyl Acetate	NR	NR	140	60
Butyl Alcohol	200	93	280	138
Butyl Alcohol Primary	150	66	280	138
Butyl Alcohol Secondary	150	66	280	138
Butyl Alcohol Tertiary	180	82	280	138
Butyl Bromide	NR	NR	280	138
Butyl Cellosolve	---	---	100	38
Butyl Chloride	NR	NR	280	138
Butylene (Butadiene)	NR	NR	280	138
Butyl Ether	NR	NR	200	93
Butyl Phenol	NR	NR	230	110
Butyl Phthalate	180	82	80	27
Butyl Stearate	---	---	250	121
Butyne Diol	100	38	---	---
Butyric Acid	180	82	230	110
Cadmium Cyanide	180	82	140	60
Cadmium Sulfate: 10%	210	99	---	---
Calcium Acetate	140	60	210	99

CHEMICAL OR SUBSTANCE NAME: CONCENTRATION	POLYPROPYLENE (PP)		POLYVINYLIDENE FLUORIDE (PVDF)	
	°F	°C	°F	°C
Calcium Bisulfate	220	104	280	138
Calcium Bisulfide	210	99	280	138
Calcium Bisulfite	210	99	280	138
Calcium Bromide: 38%	---	---	270	132
Calcium Carbonate	250	121	280	138
Calcium Chlorate	220	104	280	138
Calcium Chloride	220	104	280	138
Calcium Hydroxide: 10%	200	93	270	132
Calcium Hydroxide: 20%	200	93	270	132
Calcium Hydroxide: 30%	200	93	300	149
Calcium Hydroxide (Saturated)	220	104	280	138
Calcium Hypochlorite: 30%	150	66	200	93
Calcium Hypochlorite (Saturated)	210	99	280	138
Calcium Nitrate	210	99	280	138
Calcium Oxide	220	104	250	121
Calcium Sulfate	220	104	280	138
Calcium Sulfide	180	82	220	104
Cane Sugar Liquors	140	60	270	132
Caprylic Acid	140	60	220	104
Carbitol	120	49	270	132
Carbon Dioxide (Dry)	220	104	280	138
Carbon Dioxide (Wet)	140	60	280	138
Carbon Disulfide	60	16	80	27
Carbon Monoxide	220	104	280	138
Carbon Tetrachloride	NR	NR	280	138
Carbonic Acid	220	104	280	138
Castor Oil	140	60	280	138
Caustic Potash (Potassium Hydroxide)	170	77	180	82
Cellosolve	200	93	280	138
Cellulose Acetate	100	38	NR	NR
Chloral Hydrate	NR	NR	200	93
Chloric Acid: 20%	150	66	150	66
Chlorine Dioxide: 15%	NR	NR	200	93
Chlorine Gas (Wet or Dry)	NR	NR	240	116
Chlorine Liquid	NR	NR	210	99
Chlorine Water (Saturated)	140	60	220	104
Chloroacetic Acid	180	82	200	93
Chloroacetic Acid, 50% Water	80	27	210	99
Chloroacetyl Chloride	NR	NR	120	49
Chlorobenzene (Phenylchloride)	NR	NR	220	104
Chlorobenzyl Chloride	NR	NR	60	16
Chloroform	NR	NR	250	121
Chloropicrin	NR	NR	150	66
Chlorosulfonic Acid: 100%	NR	NR	110	43
Chrome Alum	170	77	200	93
Chromic Acid: 10%	140	60	220	104
Chromic Acid: 30%	140	60	250	121
Chromic Acid: 40%	150	66	250	121
Chromic Acid: 50%	150	66	250	121
Chromium Potassium Sulfate	180	82	---	---
Chromyl Chloride	140	60	110	43
Citric Acid: 5%	180	82	270	132

CHEMICAL OR SUBSTANCE NAME: CONCENTRATION	POLYPROPYLENE (PP)		POLYVINYLIDENE FLUORIDE (PVDF)	
	°F	°C	°F	°C
Citric Acid: 10%	220	104	250	121
Citric Acid: 15%	220	104	250	121
Citric Acid (Concentrated)	220	104	250	121
Chlorox Bleach Solution: 5.5% Chlorine	180	82	230	110
Coal Gas	150	66	220	104
Coconut Oil	180	82	280	138
Coffee	150	66	---	---
Coke Oven Gas	80	27	230	110
Copper Acetate	80	27	250	121
Copper Carbonate	200	93	250	121
Copper Chloride	200	93	280	138
Copper Cyanide	200	93	280	138
Copper Fluoride	200	93	280	138
Copper Nitrate	200	93	280	138
Copper Sulfate	200	93	280	138
Corn Oil	180	82	280	138
Cottonseed Oil	150	66	280	138
Cresol	NR	NR	210	99
Cresylic Acid: 50%	NR	NR	210	99
Cresylic Acid (Concentrated)	NR	NR	210	99
Croton Aldehyde	NR	NR	140	60
Crude Oil	150	66	280	138
Cupric Chloride: 5%	140	60	270	132
Cupric Chloride: 50%	140	60	270	132
Cupric Cyanide	200	93	270	132
Cupric Fluoride	140	60	280	138
Cupric Nitrate	200	93	270	132
Cupric Sulfate	180	82	280	138
Cuprous Chloride	180	82	250	121
Cyclohexane	NR	NR	250	121
Cyclohexanol	150	66	210	99
Cyclohexanone	60	16	110	43
Detergents	220	104	---	---
Detergent Solution, Heavy Duty	150	66	---	---
Dextrin	160	71	230	110
Dextrose	220	104	280	138
Diacetone Alcohol	210	99	250	121
Diazo Salts	230	110	280	138
Dibenzyl Ether	---	---	80	27
Dibutyl Phthalate	110	43	NR	NR
Dichloroacetic Acid	100	38	120	49
Dichlorobenzene	150	66	120	49
Dichloroethane (Ethylene Dichloride)	80	27	280	138
Dichloroethylene	180	82	220	104
Diesel Fuels	100	38	280	138
Diethanolamine	150	66	NR	NR
Diethylamine	100	38	100	38
Diethyl Cellosolve	100	38	280	138
Diethyl Ether	90	32	130	54
Diethylene Glycol	120	49	---	---
Diethylene Triamine	120	49	140	60
Diglycolic Acid	220	104	80	27

CHEMICAL OR SUBSTANCE NAME: CONCENTRATION	POLYPROPYLENE (PP)		POLYVINYLIDENE FLUORIDE (PVDF)	
	°F	°C	°F	°C
Dimethylamine	120	49	110	43
Dimethylamine Aqueous	80	27	150	66
Dimethyl Aniline	140	60	210	99
Dimethyl Formamide	140	60	NR	NR
Dimethyl Phthalate	140	60	110	43
Dimethyl Sulfoxide	120	49	NR	NR
Diocetyl Phthalate	NR	NR	80	27
Dioxane	130	54	NR	NR
Diphenyl Oxide	---	---	120	49
Disodium Phosphate	200	93	200	93
Epichlorhydrin	150	66	250	121
Esters, General	---	---	170	77
Ethanolamine	170	77	NR	NR
Ethers, General	NR	NR	120	49
Ethyl Acetate	140	60	160	71
Ethyl Acetoacetate	NR	NR	150	66
Ethyl Acrylate	110	43	180	82
Ethyl Alcohol	180	82	280	138
Ethyl Benzene	NR	NR	140	60
Ethyl Chloride	NR	NR	280	138
Ethyl Chloroacetate	120	49	80	27
Ethyl Ether	NR	NR	150	66
Ethyl Formate	---	---	80	27
2-Ethyl Hexanol	---	---	110	43
Ethylene Bromide	NR	NR	280	138
Ethylene Chloride	NR	NR	280	138
Ethylene Chlorohydrin	200	93	170	77
Ethylene Diamine	140	60	100	38
Ethylene Dibromide	80	27	220	104
Ethylene Dichloride (Dichloroethane)	80	27	280	138
Ethylene Glycol	230	110	280	138
Ethylene Oxide	NR	NR	210	99
Fatty Acids	140	60	280	138
Ferric Chloride	210	99	280	138
Ferric Hydroxide	180	82	250	121
Ferric Nitrate: 10-50%	200	93	280	138
Ferric Nitrate (Saturated)	200	93	280	138
Ferric Sulfate	200	93	280	138
Ferrous Chloride (Saturated)	210	99	280	138
Ferrous Hydroxide	180	82	280	138
Ferrous Nitrate	210	99	280	138
Ferrous Sulfate	210	99	280	138
Fish Oil	---	---	200	93
Fish Solubles	140	60	150	66
Fluoboric Acid	200	93	280	138
Fluorine Gas Dry	NR	NR	80	27
Fluorine Gas Moist	NR	NR	250	121
Fluosilicic Acid: 50%	150	66	280	138
Fluosilicic Acid	140	60	280	138
Formaldehyde (Dilute)	200	93	120	49
Formaldehyde: 35%	200	93	140	60
Formaldehyde: 37%	210	99	120	49

Chemical Resistance Chart



CHEMICAL OR SUBSTANCE NAME: CONCENTRATION	POLYPROPYLENE (PP)		POLYVINYLIDENE FLUORIDE (PVDF)	
	°F	°C	°F	°C
Formaldehyde: 50%	200	93	280	138
Formic Acid: 5%	150	66	250	121
Formic Acid: 10-85%	210	99	250	121
Formic Acid Anhydrous	180	82	140	60
Freon F-11	NR	NR	250	121
Freon F-12	140	60	250	121
Freon F-21	---	---	250	121
Freon F-22	90	32	250	121
Freon F-113	---	---	250	121
Fructose	220	104	280	138
Fruit Juices, Pulp	220	104	200	93
Fuel Oil	170	77	280	138
Furfural	NR	NR	110	43
Gallic Acid	180	82	250	121
Gas, Manufactured	160	71	280	138
Gas, Natural	160	71	280	138
Gasohol	NR	NR	280	138
Gasoline, Leaded	NR	NR	280	138
Gasoline, Refined	NR	NR	---	---
Gasoline, Sour	NR	NR	280	138
Gasoline, Unleaded	NR	NR	280	138
Gelatin	180	82	250	121
Gin	200	93	220	104
Glucose (Corn Syrup)	220	104	280	138
Glue	150	66	250	121
Glycerine (Glycerol)	210	99	280	138
Glycolic Acid	120	49	110	43
Glycols	150	66	280	138
Green Liquor	140	60	280	138
Heptane	70	21	280	138
Hexane	110	43	280	138
Hexanol, Tertiary	140	60	170	77
Hydrazine	80	27	200	93
Hydrobromic Acid Dilute	230	110	260	127
Hydrobromic Acid: 20%	200	93	280	138
Hydrobromic Acid: 50%	190	88	280	138
Hydrochloric Acid Dilute	220	104	280	138
Hydrochloric Acid: 20%	220	104	280	138
Hydrochloric Acid: 35%	220	104	280	138
Hydrochloric Acid: 38%	200	93	280	138
Hydrochloric Acid: 50%	110	43	280	138
Hydrocyanic Acid: 10% (Prussic Acid)	150	66	280	138
Hydrocyanic Acid (Concentrated)	150	66	280	138
Hydrofluoric Acid Dilute	200	93	280	138
Hydrofluoric Acid: 30%	180	82	260	127
Hydrofluoric Acid: 40%	200	93	240	116
Hydrofluoric Acid: 50%	200	93	220	104
Hydrofluoric Acid: 70%	200	93	210	99
Hydrofluoric Acid: 100%	200	93	200	93
Hydrofluosilicic Acid: 10-50%	220	104	280	138
Hydrogen	210	99	280	138
Hydrogen Chloride Gas Dry	220	104	280	138

CHEMICAL OR SUBSTANCE NAME: CONCENTRATION	POLYPROPYLENE (PP)		POLYVINYLIDENE FLUORIDE (PVDF)	
	°F	°C	°F	°C
Hydrogen Chloride Gas Moist	---	---	270	132
Hydrogen Cyanide	220	104	280	138
Hydrogen Fluoride	90	32	250	121
Hydrogen Peroxide Dilute	100	38	250	121
Hydrogen Peroxide: 30%	100	38	250	121
Hydrogen Peroxide: 50%	150	66	250	121
Hydrogen Peroxide: 90%	110	43	120	49
Hydrogen Phosphide (see Phosphine)	140	60	120	49
Hydrogen Sulfide Aqueous Solution	180	82	220	104
Hydrogen Sulfide Dry	170	77	280	138
Hydrogen Sulfide Wet	180	82	280	138
Hydroquinone	140	60	250	121
Hypochlorous Acid	140	60	280	138
Iodine	NR	NR	240	116
Iodine Solution: 10%	NR	NR	250	121
Iodine Solution (Saturated)	NR	NR	150	66
Iodoform	80	27	210	99
Isobutyl Alcohol	80	27	250	121
Isooctane	80	27	250	121
Isopropyl Acetate	80	27	250	121
Isopropyl Alcohol	210	99	260	127
Isopropyl Ether	NR	NR	90	32
Jet Fuel JP-3	70	21	250	121
Jet Fuel JP-4	70	21	250	121
Jet Fuel JP-5	70	21	250	121
Kerosene	90	32	260	127
Ketones, General	110	43	110	43
Kraft Liquor	140	60	---	---
Lactic Acid: 5-25%	150	66	120	49
Lactic Acid: 80%	150	66	250	121
Lactic Acid (Concentrated)	150	66	110	43
Lard Oil	110	43	280	138
Lauric Acid	180	82	250	121
Laurel Chloride	NR	NR	250	121
Lead Acetate (Sugar of Lead)	200	93	280	138
Lead Chloride	140	60	250	121
Lead Nitrate	180	82	250	121
Lead Sulfate	150	66	250	121
Lime Sulfur	220	104	200	93
Linoleic Acid	140	60	250	121
Linseed Oil	210	99	280	138
Liqueurs	140	60	---	---
Lithium Bromide	---	---	250	121
Lithium Chloride: 30%	120	49	250	121
Lubricating Oil	70	21	280	138
Machine Oil	110	43	200	93
Magnesium Carbonate	220	104	280	138
Magnesium Chloride	210	99	280	138
Magnesium Citrate	170	77	250	121
Magnesium Hydroxide	220	104	270	132
Magnesium Nitrate	220	104	280	138
Magnesium Sulfate (Epsom Salts)	220	104	280	138

CHEMICAL OR SUBSTANCE NAME: CONCENTRATION	POLYPROPYLENE (PP)		POLYVINYLIDENE FLUORIDE (PVDF)	
	°F	°C	°F	°C
Maleic Acid	200	93	250	121
Maleic Anhydride	80	27	80	27
Malic Acid	130	54	250	121
Manganese Chloride	120	49	---	---
Mercuric Chloride	210	99	250	121
Mercuric Cyanide	210	99	250	121
Mercuric Nitrate	180	82	280	138
Mercurous Nitrate	140	60	230	110
Mercury (Quicksilver)	160	71	280	138
Methane	110	43	260	127
Methane Sulfonic Acid: 50%	130	54	250	121
Methyl Acetate	100	38	140	60
Methyl Alcohol	190	88	280	138
Methyl Amine	NR	NR	NR	NR
Methyl Bromide	NR	NR	280	138
Methyl Cellosolve	80	27	280	138
Methyl Chloride	NR	NR	280	138
Methyl Chloroform	NR	NR	120	49
Methyl Ethyl Ketone (MEK)	150	66	200	93
Methyl Isobutyl Carbinol	120	49	NR	NR
Methyl Isobutyl Ketone	80	27	110	43
Methyl Methacrylate	220	104	120	49
Methyl Salicylate	130	54	150	66
Methyl Sulfate	NR	NR	280	138
Methyl Sulfuric Acid	150	66	120	49
Methylene Chloride	60	16	120	49
Milk	200	93	220	104
Mineral Oil	110	43	250	121
Molasses	220	104	140	60
Monochlorobenzene	NR	NR	210	99
Monoethanolamine	180	82	NR	NR
Morpholine	150	66	60	16
Motor Oil	NR	NR	250	121
Muriatic Acid	200	93	---	---
Naphtha	110	43	280	138
Naphthalene	210	99	280	138
Nickel Acetate	200	93	240	116
Nickel Chloride	220	104	280	138
Nickel Nitrate	200	93	280	138
Nickel Sulfate	170	77	280	138
Nicotine	140	60	150	66
Nicotinic Acid	140	60	260	127
Nitric Acid: 5%	140	60	200	93
Nitric Acid: 10%	200	93	200	93
Nitric Acid: 20%	140	60	180	82
Nitric Acid: 30%	150	66	180	82
Nitric Acid: 40%	150	66	180	82
Nitric Acid: 50%	150	66	180	82
Nitric Acid: 70%	NR	NR	120	49
Nitric Acid: 100%	NR	NR	150	66
Nitric Acid Fuming (Red)	NR	NR	120	49
Nitric Acid:Sulfuric Acid 50:50	NR	NR	150	66

CHEMICAL OR SUBSTANCE NAME: CONCENTRATION	POLYPROPYLENE (PP)		POLYVINYLIDENE FLUORIDE (PVDF)	
	°F	°C	°F	°C
Nitrobenzene	80	27	150	66
Nitrogen	220	104	200	93
Nitrogen Dioxide	200	93	200	93
Nitromethane	90	32	120	49
Nitrous Acid: 5%	---	---	200	93
Nitrous Acid: 10%	90	32	200	93
Nitrous Acid (Concentrated)	NR	NR	210	99
Nitrous Oxide	NR	NR	NR	NR
Ocenol	100	38	---	---
Octane	90	32	280	138
Oils and Fats	180	82	280	138
Oils, Vegetable	90	32	220	104
Oleic Acid (Red Oil)	150	66	250	121
Oleum	NR	NR	NR	NR
Olive Oil	180	82	250	121
Oxalic Acid: 5%	160	71	160	71
Oxalic Acid: 10%	150	66	150	66
Oxalic Acid: 50%	150	66	200	93
Oxalic Acid (Saturated)	140	60	140	60
Oxygen	150	66	280	138
Ozone	NR	NR	280	138
Palmitic Acid: 10%	180	82	250	121
Palmitic Acid: 70%	180	82	250	121
Palmitic Acid (Concentrated)	180	82	250	121
Paraffin	140	60	250	121
Peanut Oil	80	27	250	121
Peracetic Acid: 40%	NR	NR	---	---
Perchloric Acid: 10%	150	66	250	121
Perchloric Acid: 70%	NR	NR	120	49
Perchloroethylene	NR	NR	280	138
Petrolatum	180	82	280	138
Petroleum Ether	NR	NR	150	66
Petroleum Oils, Refined	150	66	260	127
Petroleum Oils, Sour	90	32	250	121
Phenol (Carbolic Acid)	180	82	200	93
Phenol: 10%	200	93	210	99
Phenylhydrazine	NR	NR	120	49
Phenylhydrazine Hydrochloride	NR	NR	130	54
Phosgene Gas	NR	NR	NR	NR
Phosgene Liquid	NR	NR	80	27
Phosphoric Acid: 5%	180	82	270	132
Phosphoric Acid: 10%	250	121	280	138
Phosphoric Acid: 25-50%	210	99	250	121
Phosphoric Acid: 50-85%	210	99	250	121
Phosphorus	90	32	---	---
Phosphorus Oxychloride	NR	NR	200	93
Phosphorus Pentoxide	180	82	250	121
Phosphorus Red	90	32	250	121
Phosphorus Trichloride	NR	NR	250	121
Phosphorus Yellow	NR	NR	250	121
Photographic Solutions	150	66	260	127
Phthalic Acid	90	32	210	99

Chemical Resistance Chart



CHEMICAL OR SUBSTANCE NAME: CONCENTRATION	POLYPROPYLENE (PP)		POLYVINYLIDENE FLUORIDE (PVDF)	
	°F	°C	°F	°C
Picric Acid	140	60	80	27
Picric Acid: 10%	170	77	210	99
Plating Solutions, Brass	180	82	200	93
Plating Solutions, Cadmium	180	82	210	99
Plating Solutions, Chrome: 25%	180	82	140	60
Plating Solutions, Chrome: 40%	180	82	140	60
Plating Solutions, Copper (Cyanide)	200	93	200	93
Plating Solutions, Gold	180	82	200	93
Plating Solutions, Iron	180	82	200	93
Plating Solutions, Lead	180	82	200	93
Plating Solutions, Nickel	180	82	200	93
Plating Solutions, Rhodium	180	82	200	93
Plating Solutions, Silver	180	82	200	93
Plating Solutions, Tin	180	82	200	93
Plating Solutions, Zinc	180	82	200	93
Polyvinyl Acetate	170	77	280	138
Potassium Acetate	200	93	280	138
Potassium Aluminum Sulfate	230	110	280	138
Potassium Bicarbonate: 30%	230	110	280	138
Potassium Bicarbonate (Saturated)	200	93	250	121
Potassium Bichromate	140	60	280	138
Potassium Bisulfate	180	82	260	127
Potassium Borate	200	93	280	138
Potassium Bromate	220	104	270	132
Potassium Bromide: 30%	210	99	280	138
Potassium Bromide (Saturated)	180	82	270	132
Potassium Carbonate: 50%	210	99	280	138
Potassium Chlorate, Aqueous: 30%	210	99	280	138
Potassium Chloride: 30%	210	99	280	138
Potassium Chromate: 30%	210	99	280	138
Potassium Cyanide: 30%	200	93	260	127
Potassium Dichromate: 30%	220	104	280	138
Potassium Dichromate (Saturated)	220	104	280	138
Potassium Ferricyanide: 30%	190	88	270	132
Potassium Ferrocyanide: 30%	210	99	280	138
Potassium Fluoride	140	60	280	138
Potassium Hydroxide: 5%	210	99	210	99
Potassium Hydroxide: 27%	150	66	220	104
Potassium Hydroxide: 50%	180	82	210	99
Potassium Hydroxide: 90%	150	66	210	99
Potassium Hypochlorite	180	82	250	121
Potassium Iodide: 70%	140	60	240	116
Potassium Nitrate: 1-5%	150	66	280	138
Potassium Nitrate: 80%	150	66	280	138
Potassium Perborate	220	104	280	138
Potassium Perchlorate	220	104	250	121
Potassium Permanganate: 10%	150	66	280	138
Potassium Permanganate: 20%	140	60	280	138
Potassium Persulfate	200	93	250	121
Potassium Sulfate: 10%	220	104	280	138
Potassium Sulfate, Pure	220	104	250	121
Potassium Sulfide	210	99	280	138

CHEMICAL OR SUBSTANCE NAME: CONCENTRATION	POLYPROPYLENE (PP)		POLYVINYLIDENE FLUORIDE (PVDF)	
	°F	°C	°F	°C
Potassium Sulfite	150	66	---	---
Propane	150	66	280	138
Propionic Acid	100	38	250	121
Propyl Acetate	---	---	100	38
Propyl Alcohol	200	93	250	121
Propylene Dichloride	NR	NR	200	93
Propylene Glycol	140	60	260	127
Propylene Oxide	110	43	NR	NR
Pyridine	180	82	NR	NR
Pyrogallol	90	32	110	43
Pyrogallic Acid	---	---	120	49
Pyroigneous Acid	90	32	---	---
Quinine Sulfate	80	27	---	---
Rayon Coagulating Bath	140	60	280	138
Resorcinol	230	110	---	---
Salenic Acid Aqueous	140	60	160	71
Salicylic Acid	140	60	---	---
Salicylaldehyde	120	49	150	66
Salicylic Acid	130	54	220	104
Silicone Oil	140	60	250	121
Silver Bromide: 10%	170	77	250	121
Silver Chloride	100	38	250	121
Silver Cyanide	210	99	280	138
Silver Nitrate	220	104	280	138
Soaps	140	60	250	121
Soap Solution: 5%	140	60	80	27
Soap Solutions	180	82	100	38
Sodium Acetate	220	104	280	138
Sodium Benzoate	180	82	280	138
Sodium Bicarbonate: 20%	220	104	280	138
Sodium Bisulfate	220	104	280	138
Sodium Bisulfite	210	99	280	138
Sodium Borate (Borax)	180	82	220	104
Sodium Bromide	220	104	280	138
Sodium Carbonate (Soda Ash)	220	104	280	138
Sodium Chlorate	220	104	280	138
Sodium Chloride (Salt)	220	104	280	138
Sodium Chlorite	NR	NR	250	121
Sodium Chromate: 80%	100	38	200	93
Sodium Cyanide	220	104	280	138
Sodium Dichromate	140	60	200	93
Sodium Ferricyanide	140	60	280	138
Sodium Ferrocyanide	140	60	280	138
Sodium Fluoride	220	104	280	138
Sodium Hydroxide: 10%	220	104	210	99
Sodium Hydroxide: 15%	210	99	210	99
Sodium Hydroxide: 30%	210	99	210	99
Sodium Hydroxide: 50%	220	104	220	104
Sodium Hydroxide: 70%	220	104	160	71
Sodium Hydroxide, Concentrated (Caustic Soda)	140	60	150	66
Sodium Hypochlorite: 20%	120	49	280	138

CHEMICAL OR SUBSTANCE NAME: CONCENTRATION	POLYPROPYLENE (PP)		POLYVINYLIDENE FLUORIDE (PVDF)	
	°F	°C	°F	°C
Sodium Hypochlorite (Concentrated)	110	43	280	138
Sodium Hyposulfite: 5%	---	---	260	127
Sodium Iodide	160	71	280	138
Sodium Metaphosphate	120	49	240	116
Sodium Metasilicate	180	82	250	121
Sodium Nitrate	210	99	280	138
Sodium Nitrite	210	99	280	138
Sodium Perborate: 10%	200	93	240	116
Sodium Peroxide: 10%	210	99	260	127
Sodium Phosphate Acid	200	93	280	138
Sodium Phosphate Alkaline	210	99	280	138
Sodium Phosphate Neutral	200	93	280	138
Sodium Silicate (Water Glass)	210	99	280	138
Sodium Sulfate	220	104	280	138
Sodium Sulfide to 50%	190	88	280	138
Sodium Sulfite: 10%	140	60	280	138
Sodium Thiosulfate	150	66	280	138
Sour Crude Oil	150	66	280	138
Soybean Oil	160	71	250	121
Speculum Plating Solution	150	66	200	93
Stannic Chloride	150	66	280	138
Stannous Chloride	200	93	280	138
Stearic Acid	180	82	280	138
Stoddard's Solvent	100	38	250	121
Succinic Acid	150	66	280	138
Sulfamic Acid	180	82	200	93
Sulfate Liquors	80	27	---	---
Sulfite Liquors	100	38	250	121
Sulfonated Detergents	120	49	---	---
Sulfur	140	60	250	121
Sulfur Chloride	NR	NR	90	32
Sulfur Dichloride	NR	NR	90	32
Sulfur Dioxide, Dry	170	77	210	99
Sulfur Dioxide, Wet	180	82	210	99
Sulfur Trioxide	NR	NR	NR	NR
Sulfuric Acid: 10%	200	93	250	121
Sulfuric Acid: 30%	200	93	220	104
Sulfuric Acid: 50%	200	93	220	104
Sulfuric Acid: 60%	210	99	240	116
Sulfuric Acid: 70%	180	82	220	104
Sulfuric Acid: 80%	170	77	200	93
Sulfuric Acid: 90%	180	82	210	99
Sulfuric Acid: 95%	70	21	210	99
Sulfuric Acid: 98%	120	49	140	60
Sulfuric Acid: 100%	NR	NR	NR	NR
Sulfuric Acid: 103%	NR	NR	NR	NR
Sulfuric Acid Fuming	NR	NR	NR	NR
Sulfurous Acid	180	82	250	121
Sulfuryl Chloride	NR	NR	NR	NR
Tall Oil	170	77	280	138
Tannic Acid	180	82	240	116
Tanning Liquors	140	60	80	27

CHEMICAL OR SUBSTANCE NAME: CONCENTRATION	POLYPROPYLENE (PP)		POLYVINYLIDENE FLUORIDE (PVDF)	
	°F	°C	°F	°C
Tar	80	27	250	121
Tartaric Acid	150	66	250	121
Tetrachloroacetic Acid	---	---	80	27
Tetrachloroethane	70	21	250	121
Tetrachloroethylene	NR	NR	250	121
Tetraethyl Lead	100	38	280	138
Tetrahydrofuran	70	21	70	21
Tetralin	90	32	---	---
Tetramethyl Ammonium Hydroxide: 50%	150	66	200	93
Thionyl Chloride	100	38	NR	NR
Thread Cutting Oils	120	49	200	93
Tin Chloride	140	60	---	---
Titanium Tetrachloride	10	-12	150	66
Toluene (Toluol)	70	21	210	99
Toluene-Kerosene 25-75%	80	27	200	93
Tomato Juice	220	104	250	121
Transformer Oil	110	43	---	---
Tributyl Phosphate	130	54	130	54
Trichloroacetic Acid	150	66	130	54
Trichloroacetic Acid 2N	160	71	200	93
Trichloroethylene	70	21	260	127
Triethanolamine	90	32	120	49
Triethylamine	NR	NR	150	66
Trimethyl Propane	NR	NR	200	93
Trisodium Phosphate	140	60	270	132
Turpentine	80	27	280	138
Uranyl Sulfate: 5%	200	93	230	110
Urea	230	110	250	121
Urine	200	93	250	121
Varnish	80	27	250	121
Vegetable Oil	270	132	270	132
Vinegar	200	93	220	104
Vinyl Acetate	130	54	240	116
Water, Acid Mine	220	104	220	104
Water, Demineralized	220	104	280	138
Water, Distilled	220	104	280	138
Water, Potable	180	82	280	138
Water, Salt	220	104	280	138
Water, Sea	220	104	280	138
Water, Sewage	220	104	250	121
Whiskey	200	93	250	121
White Liquor	220	104	200	93
Wines	220	104	200	93
Xylene (Xylol)	70	21	210	99
Zinc Chloride	200	93	260	127
Zinc Nitrate	220	104	270	132
Zinc Sulfate: 5%	180	82	270	132
Zinc Sulfate: 25%	180	82	270	132
Zinc Sulfate: 50%	150	66	270	132
Zinc Sulfate (Saturated)	180	82	270	132

Schweitzer, Philip A. (1995).

Corrosion resistance tables: metals, nonmetals, coatings, mortars, plastics, elastomers and linings, and fabrics. Fourth edition, revised and expanded. New York, NY: Marcel Dekker, Inc.

Assembly

Joint Assembly

Many of the questions you may have about assembling Orion No-Hub, Rionfuse CF and Socket Fusion systems are answered in this section. Should you have further questions requiring a more detailed response, please contact our Technical Department at oriontechs@wattswater.com or phone (910) 865 7530.

Cold Weather Assembly

As with all types of plastic piping systems, installation in cold weather can be difficult and therefore is not recommended at temperatures below 40°F unless proper precautions are taken.

In cold weather installations, the area being installed must be shielded from the wind and other outside elements and the joints must be covered with heating blankets, prior to being installed.

If joints are installed in cold weather, they may be difficult to seal. In addition, if above ground systems are installed in cold temperatures and the area is later heated, the system will expand possibly causing undue stress on the entire system. In view of this, special care must be taken when designing and installing any plastic piping system in cold weather. The above information applies to SocketFusion, Electrofusion and No-Hub systems.

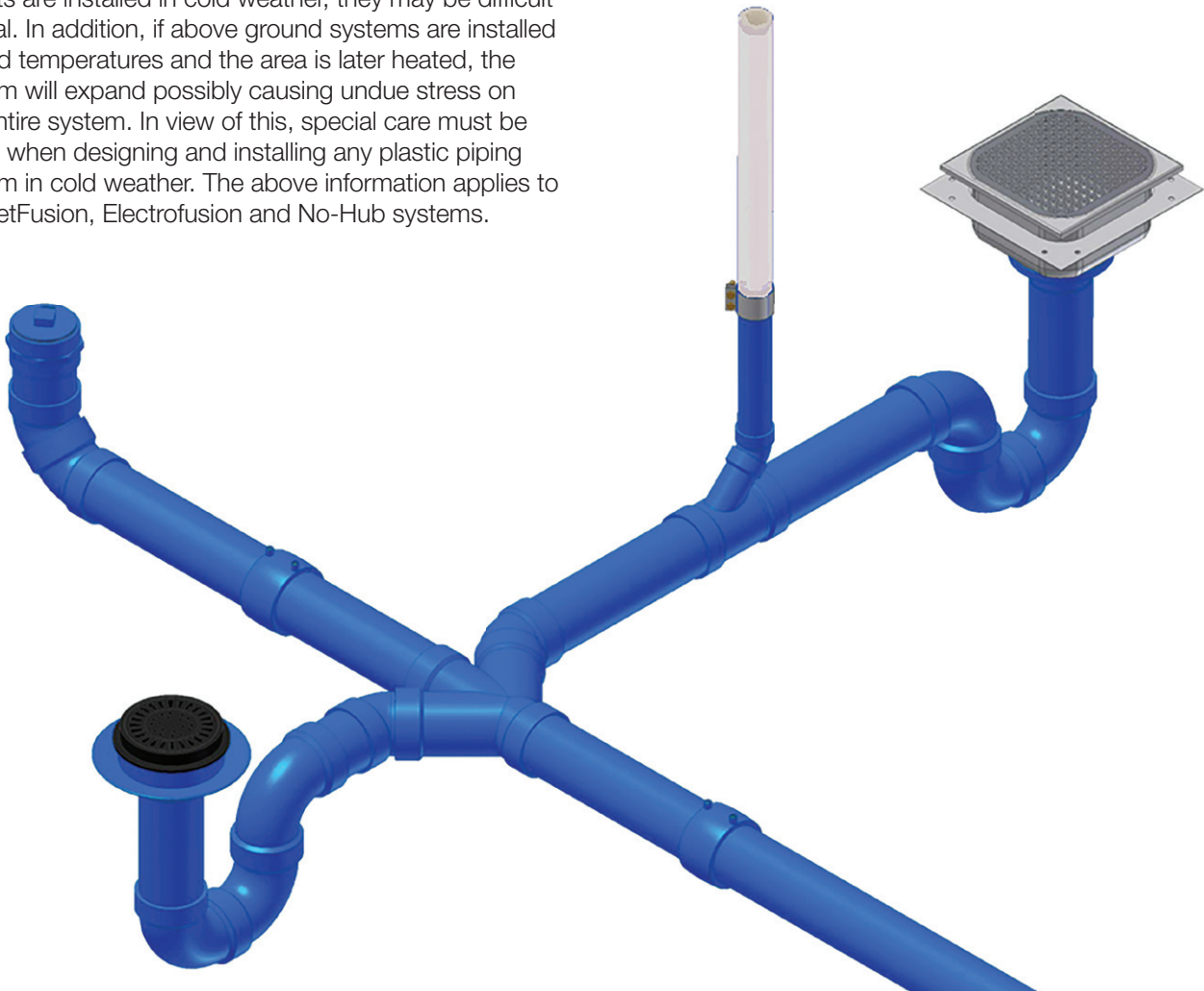

Rionfuse CF

Polypropylene and PVDF
Chemical Waste Systems

STEP 1

Confirming RF-3000LE is Calibrated

Start up your RionFuser RF-3000LE and it will perform a Self Test. If the Cal Due date has passed or is within the life of your project, then STOP, and contact your Orion Representative for instructions on how to get your machine recalibrated. Watts disclaims all liability for installations performed with a RionFuser past its calibration date.

For additional information reference the RF-3000LE Instruction Manual included in the carrying case.

STEP 2

Preparing the Pipe

Material preparation is essential to achieving satisfactory fusion results. Deburr all field-cut pipe ends. Following the coupling insertion depth chart, mark the coupling insertion depth from the end of the pipe/fitting to insure that the coupling is properly positioned during the fusion cycle. Then, using 60 grit emery cloth, abrade the marked ends of the pipe and fitting to remove the natural "sheen" of the plastic. After abrading, clean all joint surfaces thoroughly with isopropyl alcohol to remove any dirt, grease and the contaminants left from the sandpaper and any other foreign matter from the surface. We suggest using a spray bottle with 90% or higher isopropyl alcohol to soak a lint resistant cloth to thoroughly wipe the joint surface clean.

COUPLING INSERTION DEPTH MARKING

Pipe Diameter <i>in.</i>	Mark Distance from Pipe End <i>in.</i>
1½	1
2	1
3	1¾
4	1¾
6	2
8	2½
10	2½
12	2½

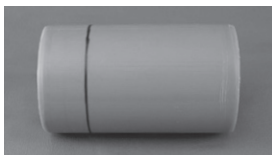

Mark coupling depth

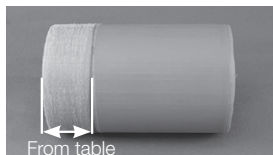

Abrade surface



STEP 3

Joint Assembly

Insert the prepared ends of the pipe/fitting into both hubs of the Rionfuse CF coupling. Double check the markings to verify proper seating of the pipe.

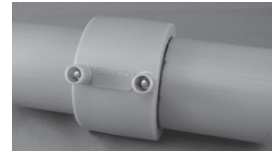

Insert into coupling and verify proper seating

STEP 4

Connecting Lead Cables

The installer must make sure the joint is properly supported during the fusion cycle and afterwards as the joint cools to ambient.

For underground installation the joint must be protected from soil falling into the fusion assembly area. If ambient temperature has dropped below 60F in the last 24 hrs, we recommend the use of warming blankets to support, wrap, and protect the pipe during the fusion process. With the Rionfuser unit connected to a dedicated power source and powered ON, connect the lead cables to the coupling.

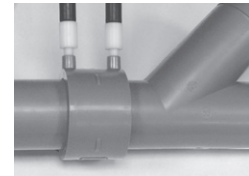

Connect lead cables

STEP 5

Selecting Fitting Style

The unit will now prompt the installer to "SELECT FITTING STYLE". Scroll UP or DOWN to highlight the proper fitting style being fused, then press START to select the fitting style.

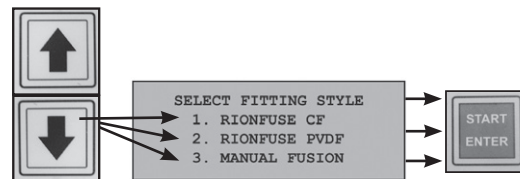

Fitting style selection screen

STEP 6

Selecting Pipe Size

Next the unit will prompt the installer to select the size of the joint being fused. Scroll UP or DOWN to highlight the correct size, then press START to select size.

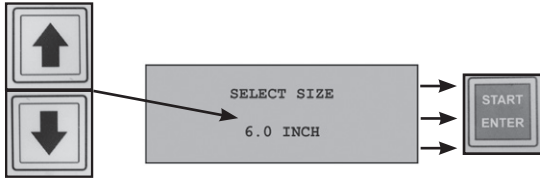

Fitting size selection screen

STEP 7

Selecting Heat Cycle

The unit will ask if a pre-heat cycle is needed for the joint. If fusion will be performed where pipe temperatures are outside the range of 60 - 90 degrees F, please consult Orion Fittings Technical department at (910) 865-7530 before proceeding. All other fusions should be performed using the STANDARD cycle, which is selected by pressing the START button.

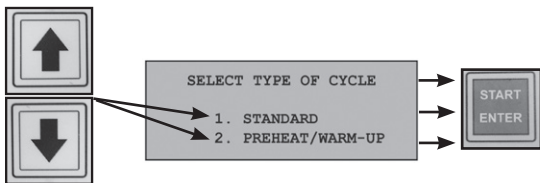

Fusion cycle type selection screen

STEP 8

Verifying Welding Parameters

The screen will display "VERIFY WELDING PARAMETERS" and an audible beep will sound to indicate the fusion unit is ready to begin welding. Verify the welding data displayed on the screen matches the joint being fused. If the information is incorrect, press the STOP/BACK button to return to any of the menu options to correct the fusion parameters. Once the parameters have been verified, press START to begin the fusion weld.



Fusion cycle type selection screen

STEP 9

Successful Weld Completion

After pressing START, the Rionfuser will begin the weld. After the welding cycle has completed, another audible beep will sound to indicate that the fusion weld is complete. If the beeping pattern is an equal, consistent beeping, the joint was successful. If the beeping pattern is irregular, it indicates that an error has occurred during the fusion cycle (if an error code is received during fusion, please contact your local Orion rep for troubleshooting information). Once the joint is completed, the lead cables can be removed and the process repeated for the next joint.

To download completed fusion data please see our IS-OR-RF-3000LE-DataDownload for instructions.

NOTICE

Do not stress newly-fused joints until fully cooled to ambient, typically 10-20 minutes depending on size. Successful weld completion screen does not eliminate need for system leak testing.

Successful weld completion screen

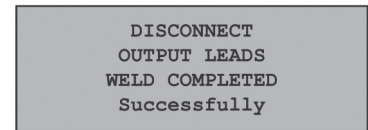

POLYPROPYLENE RIONFUSE CF COUPLING		
Pipe Size <i>in.</i>	Fusion Time <i>min.</i>	Fusion Current <i>amps</i>
1 - 1/2	2:00	8.25
2	2:00	8.25
3	3:00	14.25
4	3:00	14.25
6	4:30	19.00
8	4:45	19.00
10	7:20	17.00
12	8:00	16:50

PVDF RIONFUSE CF COUPLING		
Pipe Size <i>in.</i>	Fusion Time <i>min.</i>	Fusion Current <i>amps</i>
1 - 1/2	2:00	8.25
2	2:00	8.25
3	3:00	14.25
4	3:00	14.25
6	4:45	18.00

MULTIPLE JOINTING RIONFUSE CF	
Pipe Size <i>in.</i>	Maximum number of couplings <i>num.</i>
1 - 1/2	4
2	3
3	3
4	2
6	1
8	1
10	1
12	1

Orion Thermal Socket Fusion

Polypropylene and PVDF
Chemical Waste Systems

⚠ WARNING



Please read carefully before proceeding with installation. Your failure to follow any attached instructions or operating parameters may lead to the product's failure. Keep this Manual for future reference.



⚠ DANGER



Electricity, electrocution and shock hazards.

STEP 1

Remove the socket fusion tool and stand from their case and inspect for any obvious signs of damage, especially the power cord and plug. Should the tool appear damaged, do not continue: if new and purchased from Orion, contact oriontechs@wattswater.com or phone (910) 865 7530; if rented, contact the owner for assistance. With the tool in good working order, attach the required size of tool heads (one male, one female) to either side of the tool heating plate by means of the nut and bolt provided. When properly secured, the tool heads should not be able to rotate on the heating plate.

STEP 2

Mount the tool onto the stand provided, or secure the tool to a bench vise, taking care to protect the tool from damage by padding vise jaws and not overtightening. Plug the tool in and allow it to heat up to fusion temperature, typically about 20 minutes. Orion socket fusion tools are thermostatically controlled and factory set; however, settings can vary due to factors such as weather, current variances, cord lengths, type of power source, etc. These variables should be checked on site, and if necessary compensated for by adjusting the tool thermostat control.

STEP 3

Fusion temperature should be verified by using Tempilstiks[®], which are crayons having specific melt temperatures. After plugging in the fusion tool, make a mark on the outside of the female tool head with the



488°F Tempilstik[®] if fusing PP, or the 525°F Tempilstik[®] if fusing PVDF. When the Tempilstik[®] mark discolors and melts, the tool is ready for fusion.

STEP 4

Material preparation is essential to achieving satisfactory results. Both pipe and fitting socket ends should be cleaned with a lint-free cloth sprayed with 90% isopropyl alcohol before fusing to remove cement dust or any other adhering dirt or debris that will interfere with the fusion process. Once the pipe has been cleaned, cut it with a thin-wheel plastic pipe cutter. Deburr and bevel the cut end of the pipe with a deburring tool. A beveled end will minimize the amount of bead on the inside of the fitting socket when fused.

STEP 5

Measure the depth of the fitting socket to be fused. Subtract $\frac{1}{16}$ ".

STEP 6

Transfer the fitting socket measurement less $\frac{1}{16}$ " to the end of the pipe to be fused. Mark the pipe so the measurement will be seen when inserting the pipe into the tool head.

STEP 7

Push the fitting socket end onto the male tool head, applying firm even pressure as the socket interior softens

and progresses onto the head. Then insert the pipe end into the female tool head, taking care not to push the pipe in past the mark made in the previous step. If the pipe is pushed past the mark, it can result in a large obstructive bead forming in the bore of the joint. Keep both pipe and fitting perfectly straight on the tool as they are heating: letting them sag downwards, or pulling them slightly towards you will deform the connecting surfaces, which can result in a poor fusion.

STEP 8

Typical fusion times are shown in the chart below. These times should be used as a guide only; the same site variables listed in STEP 2 can affect fusion times also. Pipe and fitting are ready to be removed from the tool once a bead 1/32"-1/16" in diameter is visible all around the circumference of the pipe where it enters the female head, and around the circumference of the socket mouth. Checking for this bead while the components are heating will also indicate if they are being held straight on the tool: if the bead is of uniform diameter all the way around, the component is properly aligned on the tool; if there is a thicker and a thinner area on the bead, the component is out of alignment and must be straightened. Push away slightly from the thicker area of the bead toward the thinner area to realign.

TYPICAL THERMAL SOCKET FUSION TIMES IN SECONDS

Material	Pipe Size				
	1-1/2"	2"	3"	4"	6"
PP	20	25	30	35	45
PVDF	25	30	35	45	55

STEP 9

When a uniform bead is visible on both components, pull them both straight back from the tool with firm even pressure, then immediately push the pipe straight into the fitting socket until the bead on the pipe meets the bead at the fitting socket mouth. Do not twist the pipe into the socket; do not over-insert. As the pipe is inserted, check to see that axial alignment is being maintained and adjust only as necessary. The melted surfaces will begin to fuse within 5-7 seconds of being removed from the tool; any attempts to straighten or otherwise alter the joint after this time will break the weld, resulting in a leak. Once inserted, hold the joint under slight pressure for 15 seconds to ensure the surfaces fuse together well. Do not stress the joint until fully cooled to ambient. Do NOT douse cooling joints with cold water.

STEP 10

Clean any melted material from the tool heads with a cotton rag. Do NOT use any abrasive materials or tools like screwdrivers to clean off tool heads. Doing so will damage the teflon coating and the heads themselves, making subsequent fusions more difficult. Using Tempilstiks®, confirm that the tool heads are the correct temperature before fusing the next joint.

NOTES

Satisfactory installation requires careful measurement.

All thermal socket fusion joint components must be kept clean prior to and during assembly. Mud, dirt, cement dust or other foreign matter in joints is the most common cause of failure.

Successful thermal socket fusion is the result of the correct combination of heat and time. Attempts to speed up the process by cheating on how long components remain on the tool heads, fusing before the tool is up to the correct temperature, or trying to cool joints rapidly, will all result in poor fusions with a greater likelihood of failure when pressure tested.

Always protect the fusion tool from external factors that will strip heat from it: cold weather, wind, heating plate/tool head contact with cold surfaces.

Trying to cool down the fusion tool by immersing in water will destroy the tool and void the warranty.

For any questions or concerns about product or installation, please contact oriontechs@wattswater.com or call (910) 865 7530.

Orion No-Hub, Part 1: Grooving Pipe

Polypropylene and PVDF
Chemical Waste Systems

⚠ WARNING



Please read carefully before proceeding with installation. Your failure to follow any attached instructions or operating parameters may lead to the product's failure.



Keep this Manual for future reference.

STEP 1

Material preparation is essential to achieving satisfactory No-Hub coupling assembly. Pipe must be free of scoring or other surface damage, and should be wiped down with a clean cloth sprayed with 90% isopropyl alcohol before cutting to remove cement dust, mud, or other debris that will interfere with the cutter, pipe grooving tool, or interfere with assembly integrity and cause a leak.

STEP 2

Cut the cleaned pipe with a thin-wheel plastic pipe cutter to assure a clean, square cut. Deburr and bevel the cut end of the pipe with a deburring tool. This must be done prior to grooving the pipe.

STEP 3

The grooving tool blade must be fully retracted before use. With the grooving tool handle pointing up, turn the small knob on the handle counter-clockwise to the 12:00 position to retract the blade inside the grooving chamber. **DO NOT OVER-TORQUE THE BLADE ADJUSTMENT KNOB AS THIS WILL DAMAGE THE TOOL AND RENDER IT INOPERABLE.** If unsure whether the blade is retracted, visually check inside the grooving chamber while turning the knob: the blade will visibly extend or retract as the knob is turned. Once the blade is retracted, push the grooving tool onto the pipe end, making sure that the pipe end bottoms out inside the grooving chamber. The roller ball opposite the blade assembly can be adjusted using the hex nut, to ensure that the pipe presses tightly against the blade aperture; this is essential to ensure that the groove is uniform and cut to full depth.



STEP 4

Turn the blade adjustment knob $\frac{1}{4}$ turn clockwise to the 3:00 position on the handle. While maintaining firm pressure to keep the pipe bottomed out inside the tool, rotate the grooving tool clockwise twice around the pipe. If the pipe does not remain bottomed out inside the tool, the resulting groove will be wavy, spiral or otherwise deformed. Should this occur, the pipe end will need to be recut and the process started over because the joint will not seal.

STEP 5

Turn the blade adjustment knob another $\frac{1}{4}$ turn clockwise to the 6:00 position on the handle, remembering not to over-torque the knob. Maintaining firm pressure to keep the pipe bottomed out inside the tool, rotate the grooving tool clockwise twice around the pipe or until no more material is removed from the groove.

STEP 6

Return the blade adjustment knob to the 12:00 position, then remove the tool from the pipe. If the blade is not fully retracted before removing the tool it will score the pipe end, creating a leak path that will prevent the joint from sealing.

STEP 7

Remove all burrs or other material from the groove edges and interior. Ensure that all excess material is removed from the grooving tool and that the blade is clean and free of plastic debris before grooving the next piece of pipe.

Orion No-Hub, Part 2: Joint Assembly

Polypropylene and PVDF Chemical
Waste Systems

⚠ WARNING



Please read carefully before proceeding with installation. Your failure to follow any attached instructions or operating parameters may lead to the product's failure.



Keep this Manual for future reference.

STEP 1

Loosen No-Hub coupling outer band bolts until the inner plastic body moves freely.

STEP 2

Inspect coupling inner plastic body; clean out all cement dust, mud or other debris from the inner body surface with a clean cloth sprayed with 90% isopropyl alcohol.

STEP 3

Insert the pre-grooved pipe or fitting end into the coupling inner body until the coupling ridge can be felt snapping into place in the groove. Sliding the outer band back from the inner body will make this easier. The ridge must seat into the groove to ensure proper fit, seal the joint, and prevent pullout.

STEP 4

Position the coupling outer steel band such that it is centered over the inner coupling body; the inner body should be equally visible at each edge of the outer band. Position the separate steel "pinch plate" between the outer steel band and the inner plastic body so it is centered between the bolt bars. This will prevent the inner plastic body being pinched between the bolt bars as the bolts are tightened. Keeping the coupling band centered, tighten the bolts finger-tight.



STEP 5

Using a standard 1/2" open end or box wrench plus a 1/2" drive ratchet wrench with 1/2" six-point socket, tighten the outer coupling bolts until the bolt bars almost touch at the top. Alternate tightening each bolt to ensure even pressure is applied to both sides of the coupling; fully tightening one side before tightening the other, especially if using a power tool like an impact wrench, can cause the resulting joint to leak.

STEP 6

To ensure full seating of the ridge and groove, tap the coupling above each groove with a mallet, starting opposite the bolt bars and working toward them on each side of the coupling. Finish tightening the coupling bolts until the bolt bars touch at the top and have a 1/16"-1/8" gap at the bottom.

NOTES

Satisfactory installation requires careful measurement.

Cheating on pipe lengths will cause a bind, allowing joints to leak even when fully tightened.

All No-Hub joint components must be kept clean prior to and during assembly. Mud, dirt, cement dust or other foreign matter in joints is the most common cause of failure.

Both over-tightening and under-tightening No-Hub couplings can result in leaks. The description of fully tightened coupling bolts and bolt bar position above is typical and should result in a sound, leak-free joint. However, certain environmental conditions and/or manufacturing tolerances may require more or less tightening than described above.

For any questions or concerns about product or installation, please contact oriontechs@wattswater.com or call (910) 865 7530.



Terms and Conditions (USA)

(For Terms and Conditions applicable to Canadian customers please see current Orion Canada price guide.)

FREIGHT CONDITIONS:

All orders are shipped F.O.B. Once the material leaves our dock, it becomes the property and responsibility of the consignee. If freight is lost or damaged, all freight claims must be filed with the freight company. When shipping to a job site, freight will be third party billed.

FULL FREIGHT ALLOWANCE:

To meet the full freight allowance, orders must be for immediate complete shipment to one location within the contiguous United States. Shipments to Alaska, Puerto Rico, Hawaii or for export are not freight allowed. For shipments to Alaska, Puerto Rico, Hawaii or for export, the freight allowances shown below, for qualified items, are good for shipment to East Coast, West Coast, Gulf Coast, or Great Lakes ports only.

1. **Single Wall PP and PVDF Products:** \$7,000 Net on single wall pipe and fitting products, EXCLUDING Sinks, Tanks and related accessories, Chemical Treatment Systems, 8"-12" (inclusive) Pipe and Fittings.

PAYMENT TERMS:

The invoices are due and payable 30 days from the date of invoice.

ORDER ACCEPTANCE AND PURCHASE ORDER FORMS:

All orders are subject to acceptance by us at our facility. Prices and discounts contained in any of our catalogs, price lists or other literature are subject to change without notice. Your order, when shipped by us, shall be subject to these terms and conditions. Orders submitted on your own purchase order forms will be accepted only with the express understanding that no statements, clauses, or conditions contained in said order form will be binding on us if they are inconsistent with or in any way modify our own terms and conditions of sales.

MINIMUM ORDER CHARGE:

A minimum billing charge of \$50 Net applies to all shipments F.O.B. factory. Customers are encouraged to order sufficient product to avoid this charge which is necessitated by increased costs of processing small orders.

SPECIAL PRODUCTS:

Orders for special or modified products are non-cancelable. In the event that the customer cancels an order for such products, we shall charge the customer an amount equal to our costs and expenses incurred in performing the purchase order prior to receipt of notice of cancellation.

LIMITED WARRANTY:

We (the "Company") warrant each product to be free from defects in material and workmanship under normal usage for a period of one year from the date of original shipment. In the event of such defects within the warranty period, we will, at our option, replace or recondition the product without charge.

THE WARRANTY SET FORTH HEREIN IS GIVEN EXPRESSLY AND IS THE ONLY WARRANTY GIVEN BY THE COMPANY WITH RESPECT TO THE PRODUCT. THE COMPANY MAKES NO OTHER WARRANTIES, EXPRESS OR IMPLIED. THE COMPANY HEREBY SPECIFICALLY DISCLAIMS ALL OTHER WARRANTIES, EXPRESS OR IMPLIED, INCLUDING BUT NOT LIMITED TO THE IMPLIED WARRANTIES OF MERCHANTABILITY AND FITNESS FOR A PARTICULAR PURPOSE.

The remedy described in the first paragraph of this warranty shall constitute the sole and exclusive remedy for breach of warranty, and the Company shall not be responsible for any incidental, special or consequential damages, including without limitation, lost profits or the cost of repairing or replacing other property which is damaged if this product does not work properly, other costs resulting from labor charges, delays, vandalism, negligence, fouling caused by foreign material, damage from adverse water conditions, chemical, or any other circumstances over which the Company has no control. This warranty shall be invalidated by any abuse, misuse, misapplication, improper installation or improper maintenance or alteration of the product.

Some States do not allow limitations on how long an implied warranty lasts, and some States do not allow the exclusion or limitation of incidental or consequential damages. Therefore the above limitations may not apply to you. This Limited Warranty gives you specific legal rights, and you may have other rights that vary from State to State. You should consult applicable state laws to determine your rights.

SO FAR AS IS CONSISTENT WITH APPLICABLE STATE LAW, ANY IMPLIED WARRANTIES THAT MAY NOT BE DISCLAIMED, INCLUDING THE IMPLIED WARRANTIES OF MERCHANTABILITY AND FITNESS FOR A PARTICULAR PURPOSE, ARE LIMITED IN DURATION TO ONE YEAR FROM THE DATE OF ORIGINAL SHIPMENT.

SHIPPING DATES-DELAYS-SHORTAGE CLAIMS:

All shipping dates given are best estimate only and, therefore, cannot be guaranteed. We will not be liable for any delay in delivery. Any claims for shipping errors, shortages or defects must be made to us within 24 hours of receipt of the goods. The customer shall be required to make timely payment to us of any amount which is undisputed or not subject to such claims.

RETURNED GOODS POLICY:

1. Permission to return goods must be requested in written form to us via email, fax or mail. The request must identify original shipment of material by invoice number and date of invoice and list all goods to be returned by Orion part number / MFG number and description. Total value of requested return must meet minimum \$250 Net value to qualify for return authorization due to increased costs of processing small returns.
2. The following are non-cancelable and non-returnable and no credit will be issued on their return: all pipe; all non-standard, special order, or made to order products; all obsolete products; all sinks, tanks and related accessories, sediment interceptors, monitoring equipment, and related accessories; all Standardline products; all 8", 10", 12" fittings; all tools and accessories.
3. Goods must be returned within one year after purchase in order to receive credit.
4. Only 10% of any invoice total (not including the pricing for pipe) may be returned for credit, subject to minimum \$250 Net value as stated above.
5. All goods must be returned "prepaid". For any goods purchased on an FFA basis, outgoing freight charges will be deducted from total credit amount.
6. All goods returned must be in pristine and resalable condition. All returns are subject to our inspection. Any product that is, in our sole judgement, determined not to be in a resalable condition will be either disposed of by us or returned freight collect to the purchaser. In either event, no credit will be given.
7. A restocking charge of 25% will be charged against all returned goods except Whiteline materials for which the charge will be 35%. If goods are returned in a non-pristine condition and need special cleaning to allow them to be resold, a 40% restocking charge will apply to the entire returned shipment.
8. All goods returned must have Orion's return authorization number clearly indicated on all boxes or cartons and must be freight prepaid. If not, they will be refused at our dock.
9. All credit memos issued may be applied to current account balances or to future purchases. No cash refunds will be issued.

NOTE:

Prices and terms are subject to change without notice and supersede all previous quotations. The right is reserved to change or modify product design or construction without prior notice and without incurring any obligation to make such changes and modifications on products previously or subsequently sold.

Watts Family of Brands

Watts designs, manufactures, and sells an extensive line of flow control, water safety, water filtration & treatment, drainage, and PEX plumbing products.

The Watts family of companies provides a single source for solutions used to safely convey, conserve, and manage water.

Making Watts your single source for plumbing-related solutions will streamline your operations, save you money, and reduce the variety of repair parts needed for maintenance.



A **WATTS** Brand

USA: T: (800) 334-6259 • Watts.com
Canada: T: (905) 332-4090 • F: (905) 332-7068 • OrionFittings.ca
Latin America: T: (52) 55-4122-0138 • Watts.com