

Chevy P30 Chassis – J71 Auto Park Brake Revision

Our motorhome has a 1998 Chevrolet P30 chassis with the J71 auto park brake. This means that we, along with many others with the Chevy P30 chassis with the J71, have experienced the sudden, and scary, engagement of the park brake while driving—the dreaded Chevy P30 park brake failure. In this situation, the park brake, without warning and without driver input, engages and locks up, creating a hazardous—and unnerving—driving emergency.

The first time this happened, I realized that somewhere on the motorhome a brake had locked up—not one of the wheel brakes, but I didn't know where that brake was, or why it had locked up.

I wanted to know, of course. So, after spending way too much money for the repair, I researched the Chevy P30 chassis auto park brake and its history of failure—the parking brake applying itself while traveling down the road. What I learned is that a switch—what many fondly refer to as the Rotten Green Switch (RGS)—was leaking, causing enough pressure loss to engage the brake, locking it up.

When the park brake locked up a second time, I was able to pull to the side of the road and out of the way of traffic, where I could safely get underneath the motorhome (after setting wheel chocks to keep the motorhome from rolling) and remove the clevis pin in the linkage that applied the park brake, thus releasing it. This meant setting wheel chocks at the wheels each time we stopped someplace and when we parked the motorhome because there was no parking brake—but it did allow us to continue driving home.

This second time (that RGS again), I did the repairs myself, including removal of the brake drum at the output of the transmission (after removing the multiple section drive shaft), lightly sanded the brake shoes to remove the glaze caused by overheating, then readjusted the park brake linkage so the brake shoes were not dragging on the brake drum. Important note: there was not much adjustment between “brake shoes not dragging” and “brake shoes pulled snug.” “Snug” is not the same as “tight”—which I discovered when the park brake did not hold well when on much of a slope.

The third time the park brake locked up, I recognized it right away and pulled over. We were only going about 45 mph on a local road instead of about 65+ mph on the highway, as we were the first and second times. This third time we were on a local road, about a mile from the campground. The culprit this time, however, was not the RGS; instead, it was a leaking hydraulic cylinder seal, resulting in the loss of pressure that caused the park brake to engage.

For those who are not familiar with the operation of the Chevy P30 and its J71 park brake, I will describe its operation for you.

The Chevy P30 chassis automatic transmission does not have a parking pawl in the transmission to set and lock the gears from rotating, thus locking the transmission in place when shifted to Park. This is what keeps vehicles parked in place. Instead, the P30 chassis automatic transmission has a drum brake mounted on the output shaft of the transmission. When the vehicle is in Park or the ignition is off, that brake is applied to keep the transmission's output shaft from turning. This essentially locks the transmission in place and keeps the vehicle parked in place.

The auto park brake unit contains an hydraulic pump and double-acting hydraulic cylinder. The cylinder extends under hydraulic pressure to release the park brake and retracts by an internal spring, which pushes the cylinder back to its original position engaging the park brake. Thus, when the ignition is off or the shift lever is in P, no voltage is applied to the hydraulic pump, leaving no hydraulic pressure in the system and the park brake engaged. The park brake is applied by the spring which pushes the hydraulic cylinder back to its original, retracted, position with the park brake engaged. The park brake's default (normal) position is brake applied.

When the vehicle ignition is on and the shift lever is moved from P to R, N, or D, voltage is applied to, and turns on, the park brake's hydraulic pump. This puts hydraulic pressure into the system, extending the hydraulic cylinder outward, pushing the brake operating cable and linkage. This then releases the brake at the back of the transmission and allows the vehicle to move (be driven).

Chevy P30 Chassis – J71 Auto Park Brake Revision

The auto park brake is applied while the vehicle is in Park or the ignition is off. At first, this appears to be a safe design, as the default position is brake applied. The safety of that design becomes questionable, however, when one factors in reliability of the equipment and what happens when the equipment fails while driving—i.e., the park brake is applied while driving, creating a hazard while the vehicle is moving. Thus, this brake-applied default design is not a safe design when the failure of any component in the park brake system causes the park brake to be applied while the vehicle is moving.

In addition, the park brake shoes are quite thin and are not designed to actually stop the vehicle, just to keep it stopped. When the park brake fails and applies itself while the vehicle is moving, the brake drags the vehicle speed down considerably, which causes the park brake's brake shoes to overheat and burn up in a very short time, rendering the park brake ineffective once the vehicle does stop moving, unless the vehicle is on relatively flat and level ground.

After our third Chevy P30 J71 auto park brake system failure while driving, I decided to evaluate the original park brake system and redesign the system so that it will still be automatically applied when the vehicle's wiring and control systems call for the application of the park brake, but eliminate—or at least greatly reduce—the possibility that the park brake will activate while the vehicle is moving because of a failure in the system. My redesign's intent is to prevent the park brake from being applied by a system component failure while driving and is described on the following pages.

The original park brake's hydraulic cylinder had an effective stroke of 2 inches and created a very narrow adjustment space between “brake off without brake shoes dragging” and “brake on with holding power.” My revision with a 3-inch stroke now completely disengages the brake shoes from dragging on the brake drum when the brake is off, yet allows a full application of the brake shoes tight against the brake drum when the brake is on, with greater brake pressure than the original hydraulic system provided, and thus providing greater holding power while applied. The last half-inch of the “brake on” stroke is pulling the cable and linkage completely and totally tight, which completely engages the brake's shoes with the brake drum; there is no “partially on—partially off” application of the park brake. The last half-inch of the “brake off” stroke is pushing the cable and linkage completely to its stops, removing any slack in the linkage. This completely disengages the brake shoes from the brake drum, no more brake shoes dragging on the drum during “brake off”.

My first modification in trying to fix the factory hydraulic system was to install additional springs to pull the linkage slack back from the park brake's brake shoes toward the operating cable; I added 2 springs where the removable clevis pin is installed. This pin is the factory-specified manual park brake release point in case the system fails and the park brake cannot be released by the hydraulic mechanism. The springs did minimally increase the adjustment space between “brake off without brake shoes dragging” and “brake on with holding power”; however, even with the new springs installed, the holding power was not fully functional because there was not enough stroke length to pull the brake shoes into full engagement with the brake drum when adjusted for no brake shoe drag on the drum.

My redesign, shown and described on the following pages, adds an additional inch of brake system stroke length. In addition to solving the problem of the park brake activating spontaneously, this also solves the limitation of the brake not being fully engaged, as the 1 inch of additional stroke length allows for full engagement of the brake shoes with the brake drum while also allowing for full disengagement of the shoes from the brake drum.

I installed a 12-volt DC linear actuator, which can produce 1,000 pounds of force extending and 800 pounds of force retracting. As configured and installed, the force required during extending is very little as this only needs to push the cable and linkages to fully release the pressure from the brake shoes; it does this quite well. Also, as configured and installed, the full pulling force of 800 pounds is applied to the cable, which operates the linkages and pulls the brake shoes into full contact with the brake drum; that 800 pounds of pulling force does this quite well.

First, raise the vehicle high enough to provide good working space underneath; if you have a lift, lucky you! I raised our motorhome home all the way up on its levelers, then used suitable jack stands to support the frame. I have 3 pairs of 6-ton jack stands I used to support the motorhome, a wheeled crawler to lie on, and a low wheeled dolly for my tools and the brake unit. This height provided a sufficient working height and clearance without making the brake unit too high to easily reach while lying on the wheeled crawler. **Caution: The brake unit is heavy. Use a lift or floor jack to support the unit when removing it.**

Chevy P30 Chassis – J71 Auto Park Brake Revision

You are now ready to begin removal of the Park Brake Unit as one assembly.

I will describe the sequence for removing the existing hydraulic auto park brake first. Because I did not take photos during removal of the unit, I am including photos from the reinstallation of the unit, with an explanation of the removal sequence of the existing unit.

If the park brake is engaged, release it, either by using the unit itself or by removing the factory-identified clevis pin to release the brake. I already had the clevis pin removed because the park brake unit failed while driving.



The park brake unit, which will be removed as a single assembly. It is heavy, so use a lift such as a transmission jack or a large floor jack which has a large cradle.

There is more weight toward the left end, where the hydraulic cylinder and spring is. You may need to adjust the balance of the unit on the lift/jack, as it takes the weight of the unit.

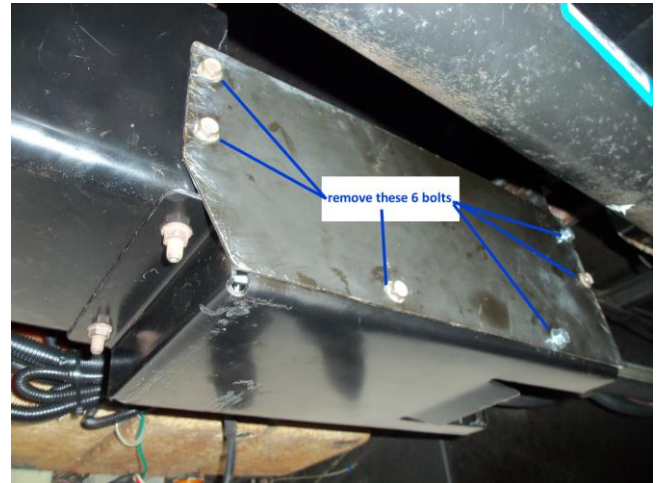

Step 1—Removal of park brake access cover plate.

Remove this access cover plate by removing the 6 bolts. (If yours is like mine was, two of these bolts were not replaced during a previous service; the photo shows the access cover back in place after I installed the new assembly and replaced the missing bolts.)



Step 2—Removal of park brake cable from the threaded shaft of the hydraulic cylinder.

The park brake unit is connected to a cable connected to linkage that operates the park brake.
Note: with the park brake released, measure the distance the cables coupling nut is from the housing surface to the right, upon re-installation, this will be the distance you will screw the coupling nut onto the shaft and secure with the jamb not – this will be your adjustment starting point.

- 1) Loosen jam nut from coupling nut.
- 2) Unscrew coupling nut from threaded shaft.
- 3) Install a worm-gear type hose clamp around the retainer to squeeze in the fingers of the retainer, pry and/or tap the retainer out through the hole, then slide the cable out of the slot.

Steps 3 through 9 are on the next page

Chevy P30 Chassis – J71 Auto Park Brake Revision



Steps 3 through 9—Removal of park brake unit as a single assembly

After disconnecting the park brake unit from the cable, as stated in Step 2 on previous page:

- 3) Disconnect the 2 plug-in connectors (Item 1 in photo above) that connect the park brake unit to the chassis wiring.
- 4) Loosen the nuts on the 2 bolts (Item 2 in photo above) at the right end of the unit a couple of turns. **DO NOT REMOVE THE NUTS OR BOLTS** at this time.
- 5) With the lift or jack under the unit to support its weight, remove the 4 front bolts (Item 3 in photo above). **NOTE:** The front (left) end of the unit will be heavier than the rear (right) end of the unit; balance the unit on the lift/jack.
- 6) Lower the lift/jack just enough to make sure the left end of the unit is free from the chassis. The right end should still be hanging from the 2 bolts (Item 2 in photo) that were loosened a couple of turns in Step 4 above.
- 7) Roll the lift/jack, which is supporting the unit, toward the front of the vehicle (keeping the weight balanced on the lift/jack) so the right end of the unit slides off the 2 bolts (Item 2 in photo) at the right end. These two bolts/nuts may be left in place.
- 8) Lower the unit down. It is now ready to be rolled out from under the vehicle—either on the lift/jack or, as I did, by placing on a low-wheeled dolly, then rolling the entire unit out from under the vehicle.
- 9) Roll the unit to, and place it on, your workbench/work stand. The unit is now ready to be disassembled and gutted to make room for the new, electrically operated linear actuator system.

Chevy P30 Chassis – J71 Auto Park Brake Revision



The unit is on my work stand, ready to be measured, identified, labeled, and disassembled.



The threaded shaft, which projects out of the hydraulic cylinder and onto which the coupling nut was threaded.



Measure the distance from the end of the threaded shaft to the front plate, as the bolt of the new operator will need to be the same length. The end of the threaded shaft of my hydraulic cylinder measured 1-13/16 inches from the front plate when fully retracted.



The hydraulic cylinder with the internal return spring.

Chevy P30 Chassis – J71 Auto Park Brake Revision



This switch is normally closed – closed when brake *is not* fully on; this switch is open when brake *is* fully on and the spring has fully retracted the hydraulic cylinder.



The hydraulic pump motor.



The hydraulic fluid reservoir. The hydraulic pump uses ATF fluid, however, because there will no longer be any need for the ATF fluid there will be no more leakage of it



The RGS (Rotten Green Switch) pressure switch which is normally closed with no pressure in the system and the brake is on; this switch is open when there is pressure in the system and the brake is off. This switch senses pump pressure when it is working—i.e., when it is not leaking the pressure out and causes the park brake to engage while driving. I believe this switch operates the Auto Park light or the Parking Brake light (does not matter which).

Chevy P30 Chassis – J71 Auto Park Brake Revision



The pressure switch on the inlet to the hydraulic cylinder. It is normally closed (no pressure) when the brake is on and open when there is pressure and the brake is off.

This pressure switch has the same failure mode as the RGS pressure switch. It also may leak, allowing the hydraulic pressure to drop and cause the park brake to engage while driving. I believe this switch operates the Auto Park light or the Parking Brake light (does not matter which).

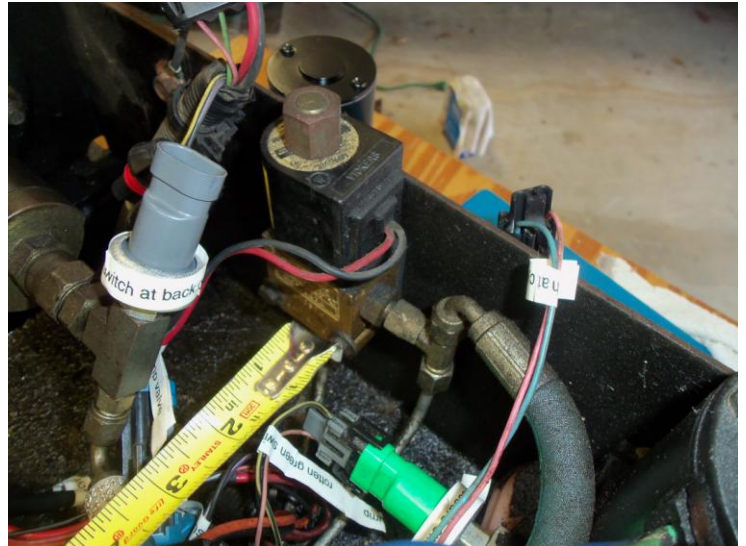

The dump valve which dumps out the hydraulic fluid back into the reservoir tank and allows the hydraulic pressure to go to zero when the park brake is activated by shifting to 'P' and/or turning the ignition 'off'. This dumps the pressure and allows the spring to retract the hydraulic cylinder which engages the park brake when parked.



A view from the end, showing the ATF fluid reservoir tank and access to it—not that I would call that “access” if you were trying to add fluid to the reservoir; regardless, you will no longer need to worry about that lack of access.



A view from the other side. Nothing to look at here except that the hydraulic cylinder is exposed on this side. The cylinder return spring is in the larger part of the housing.

Chevy P30 Chassis – J71 Auto Park Brake Revision



The hydraulic pump, which will be removed.



The dump valve, which will be removed.



The hydraulic cylinder, which will be removed.

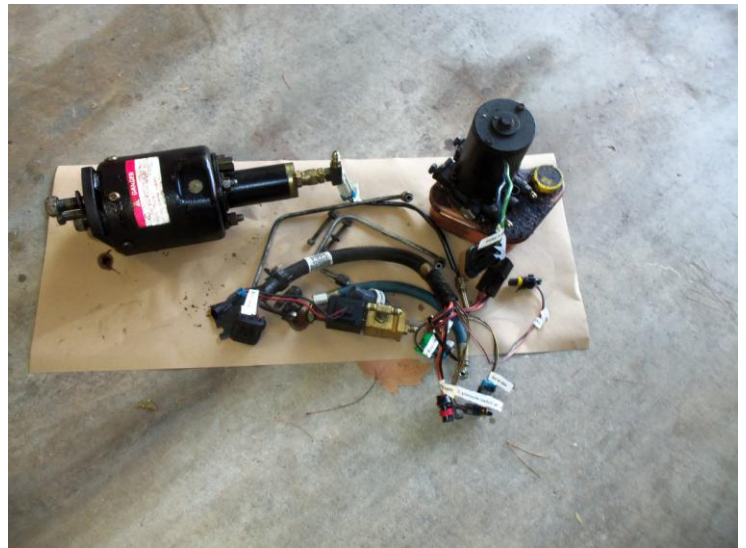

The parts I removed: the hydraulic cylinder (upper left); hydraulic pump with reservoir (upper right); the dump valve (lower center below wiring harness); and the wiring harness (which will be reused). The wiring harness is the only part that will be reused without alteration.

Chevy P30 Chassis – J71 Auto Park Brake Revision



The parts in the previous photo are being replaced with this one part—a 12-volt DC linear actuator with a 3-inch stroke.

I bought this part from Firgelli Automations: Model FA-1000-L-12-3, which has 1,000 lbs. of push force and 800 lbs. of pull force; this one is being used for its pull force.

<http://firgelliauto.com/default.php?cPath=116>



Another view of the linear actuator.

I also purchased two sets of Firgelli's MB3 mounting brackets, and even though I ended up not using them to mount the linear actuator, they did make very good mounting brackets for other items, as shown in later photos.



This photo and the next several photos show various stages of . . .



disassembly and preparation for painting . . .

Chevy P30 Chassis – J71 Auto Park Brake Revision



disassembly and preparation for painting . . .



disassembly and preparation for painting . . .



disassembly and preparation for painting . . .



disassembly and preparation for painting . . .

Chevy P30 Chassis – J71 Auto Park Brake Revision



Typical cleaning of parts for painting ...



Typical cleaning of parts.



The reassembled unit housing after repainting has been completed. This is the access side, where the components were removed and the new components will be installed.

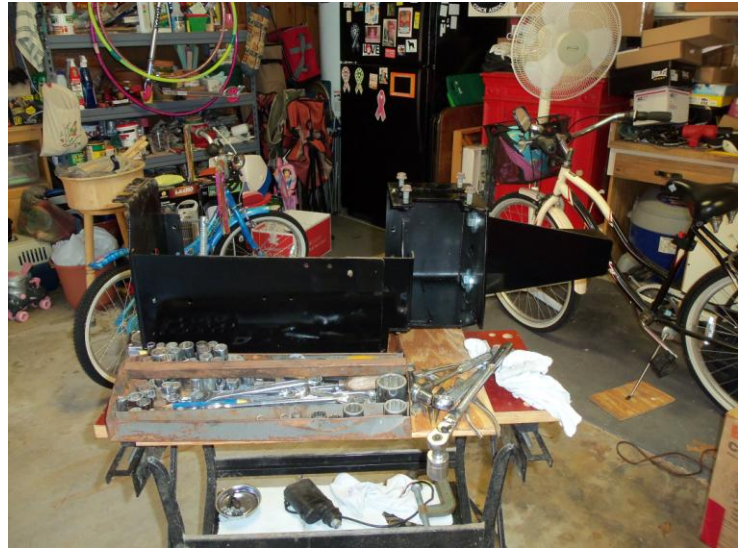

The reassembled unit housing after repainting has been completed. This is the closed side; the other side is the access side, where the components were removed and the new components will be installed.

Chevy P30 Chassis – J71 Auto Park Brake Revision

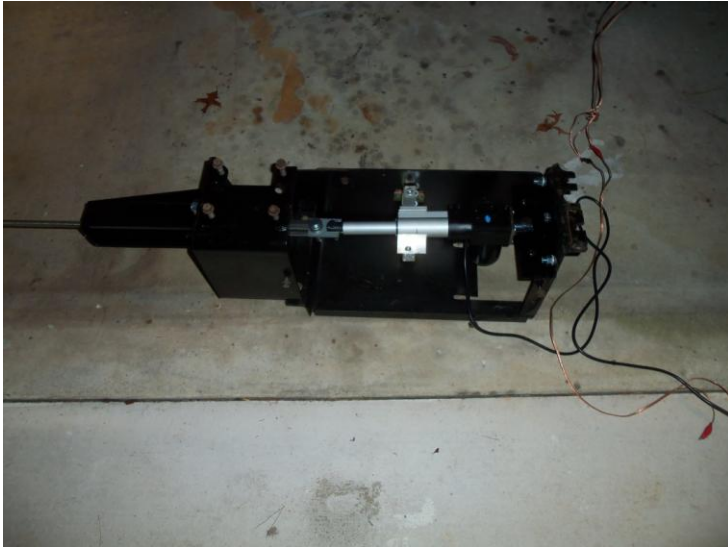

The linear actuator has been installed with a stainless steel 1/2-20 threaded rod. The threaded shaft of the hydraulic cylinder was 1/2-20; I kept the 1/2-20 size and thread to match the coupling nut on the end of the cable. I used stainless steel all-thread rod for its strength to match that of the original threaded shaft.

The linear actuator is being tested and is at full extension.



This photo shows testing of the linear actuator operation with the linear actuator in full extension. The tape measure shows the extent of travel and brake yoke pin, compared to the travel when retracted, shown in the next two photos.



Testing of the actuator with it now fully retracted.

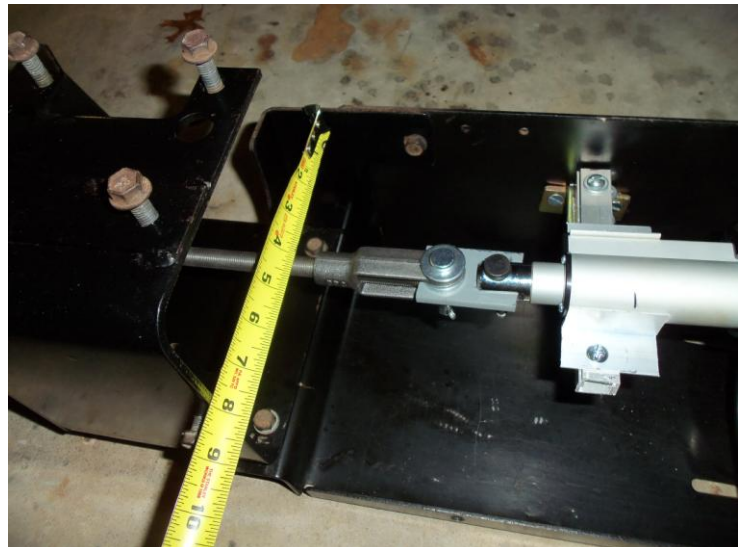

The tape measure shows the location of the brake yoke pin when extended versus the location shown when retracted.

Chevy P30 Chassis – J71 Auto Park Brake Revision



Unit is back on the work stand and ready for more assembly.



Side view showing how little is now in the box where all the hydraulic items were. Operation is now much less complicated and the unit is also much lighter.



Showing the length the threaded rod will be cut to match the retracted 1-13/16-inch length, measured with the original threaded shaft of the hydraulic cylinder.



The simplicity of the new design.

Chevy P30 Chassis – J71 Auto Park Brake Revision



A view of the other side.

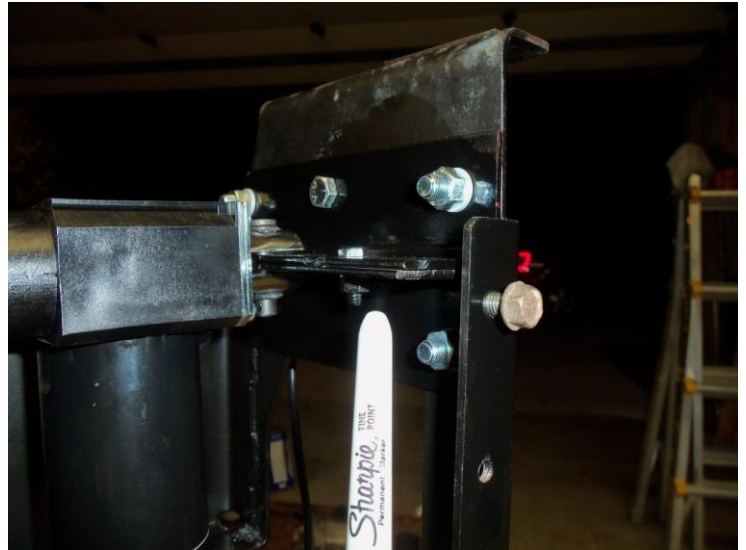

I added this double L angle brace across the end of the unit's box to stiffen the end and provide a mount for this end of the actuator. There is also a side access panel cover that goes on this open side and adds to the rigidity of the end of the box the actuator is mounted to.

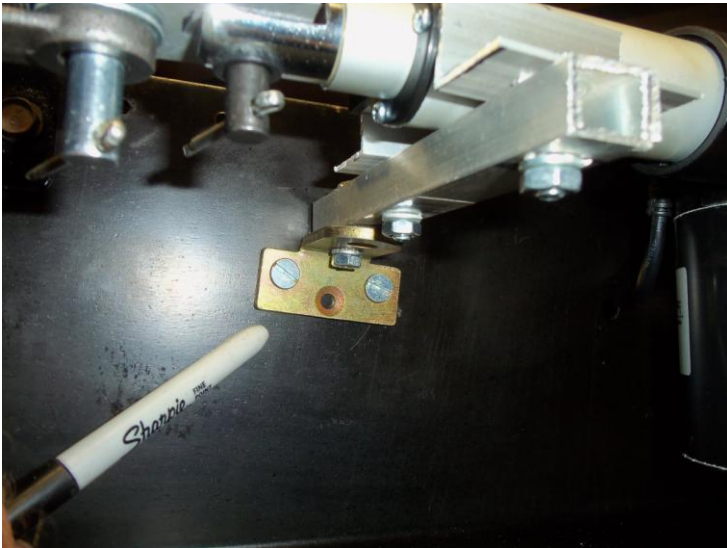

One of the MB3 mounting brackets. It came in handy to serve as the mounting bracket for the intermediate support for the linear actuator, as the MB3 brackets are quite strong (they are designed to withstand 1,000 pounds force in pull/push and are strong as a bracket as well).



The linear actuator is resting on the bracket I made from two 3/4-inch aluminum channels. I used two holes already in the side of the box to mount the MB3; had to drill one hole out slightly, as the holes were not spaced exactly right.

Chevy P30 Chassis – J71 Auto Park Brake Revision



The actuator support bracket is mounted to the MB3 bracket attached to the side of the unit's box.

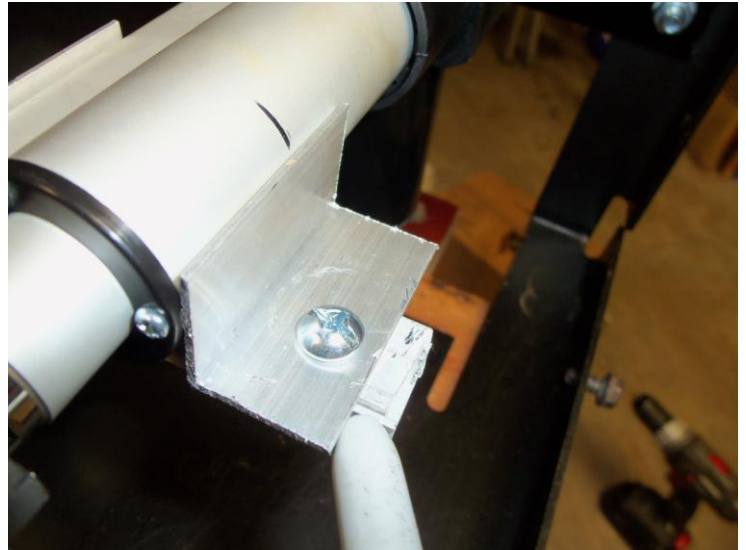

I then installed a bracket to each side of the actuator to keep it centered and in alignment with the hole the threaded rod extends out through to the cable coupling nut.

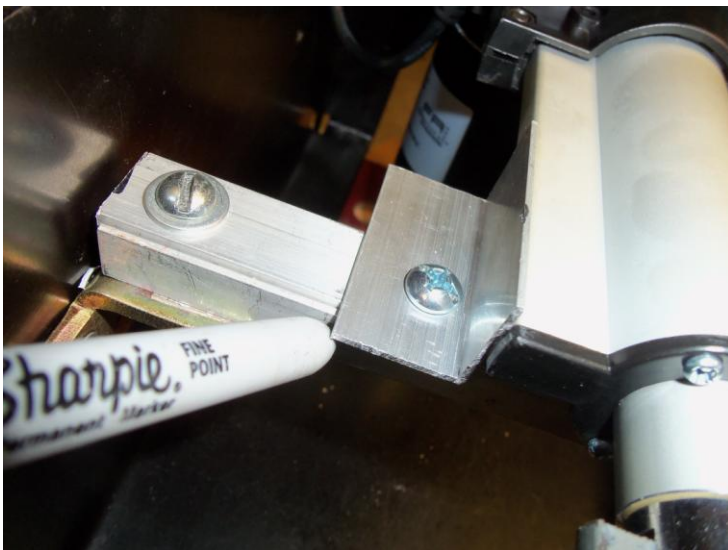

The angle bracket on the other side of the actuator keeping the actuator centered.



I made a steel flat-bar connector to go from the actuator mounting to the brake yoke.

Chevy P30 Chassis – J71 Auto Park Brake Revision



I added a brake yoke, 1/2-20 threaded, to connect the threaded rod to the flat bar connector. I tightened the rod tight to the flat-bar connector to keep proper alignment, as the pins were allowing the connector and brake yoke to move out of straight-line alignment.



The threaded rod has been tightened to the flat bar connector plate to keep it all in proper alignment.



I took the RGS and the other pressure switch (from the inlet at the hydraulic cylinder) and removed the crimped aluminum rings that held the pressure section to the switch body.



One of the pressure sections from those pressure switches. These switches are normally closed ("no pressure," which is "brake on"). I used the switch housings so I would not have to alter the wiring harness connectors.

Chevy P30 Chassis – J71 Auto Park Brake Revision



This is the RGS with the pressure section removed and wires soldered to the contacts.



After soldering the wires to the contacts and making sure the connections were good, I filled the switch body with dielectric sealant.

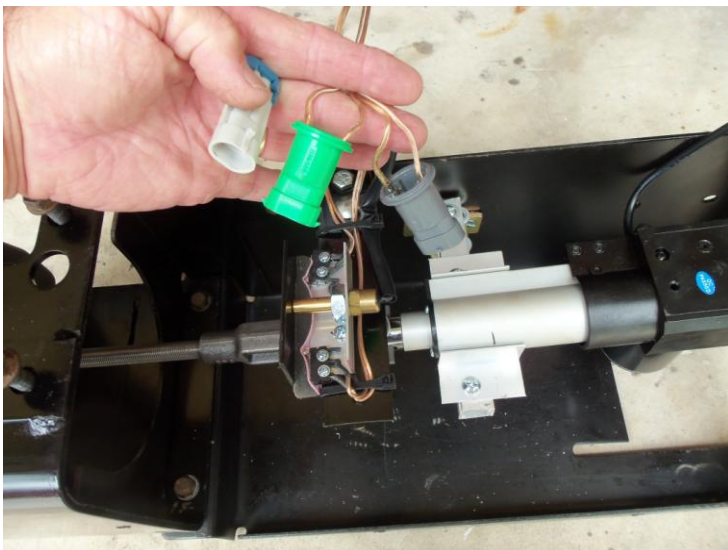

Repeat for the other pressure switch body.

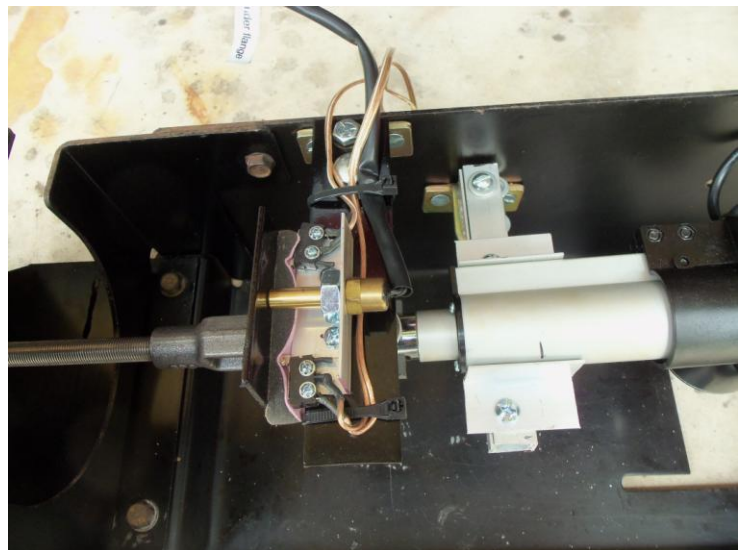

I used the other MB3 mounting bracket as a support for the piece I mounted the three switches to. The two side switches are for the RSG and the other pressure switch. The center switch is the switch that was mounted in the hydraulic cylinder at the spring to indicate when the brake was not fully on.

Chevy P30 Chassis – J71 Auto Park Brake Revision

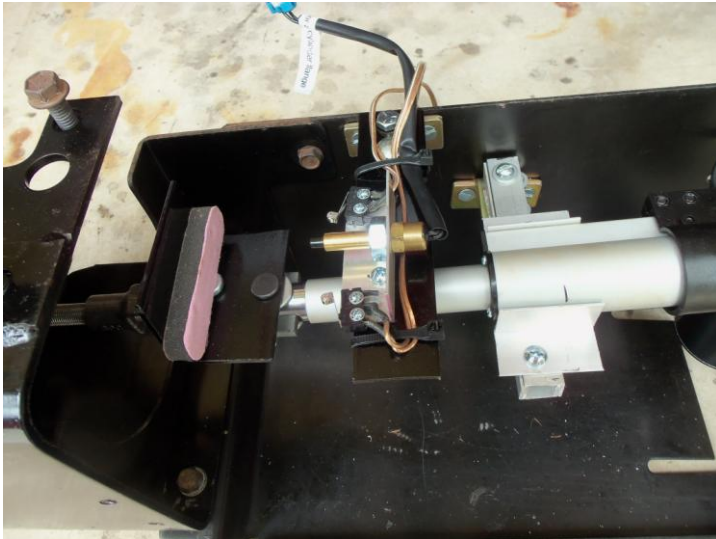

The brass switch with the black plastic end is mounted so the switch is fully pressed in when the brake is on (it indicates when the brake is not fully on). This is the same function the switch performed in the original hydraulic cylinder—it was used to indicate when the brake was not fully on.

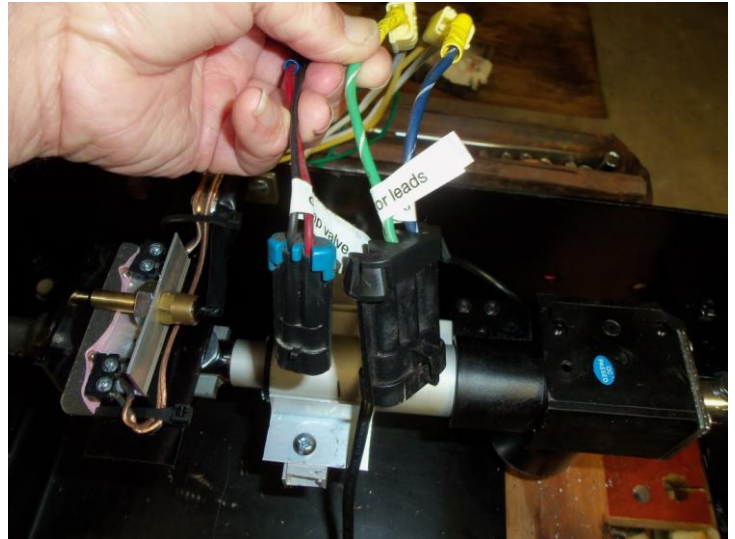

The factory connectors for the motor leads and the dump valve leads. They will connect back into their respective connectors in the factory wiring harness for the park brake.

The foam pad allows for a delay in activation of the two roller lever switches which are pressing against the pad.

This is a good place to state the alteration I did not make, then describe the wiring alterations I did make—the *When*, *What*, *Why*, and *How*.

First, the alteration I did not make:

I did not want to change the wiring harness between the two connectors from the chassis to the connectors, which plug into the various switches. Any changes to that wiring harness would require changing or replacing the connectors—and there really is no need to get into changing or replacing them. By leaving the wiring harness as is, I could use the original wiring harness without alteration.

Then, the alterations I did make:

When—Any time after you have removed the park brake assembly and have it on your workbench and after you get to the linear actuator mounted on its brackets, you need to have done at least some of the following before continuing.

Third, the Alterations I DID make: I will list the *What* (the alterations), followed by the *Why*, then the *How* for each alteration.

- a) *What*—The RSG at the hydraulic pump motor. With no pressure, this pressure switch is normally closed; this means that the switch, in its default state of no action, is closed. When there is no pressure in the hydraulic system of the park brake operator, the internal spring within the hydraulic cylinder applies the park brake. With the park brake applied, the dashboard auto park and parking brake lights turn on. These lights turn on because, with no pressure in the system, the switches are closed.

Why—The linear actuator will not be using the hydraulic system so I needed to use a switch that was not a pressure switch. However, because I did not want to alter the wiring harness between the switch connectors and the chassis connectors, I needed to keep the connector part of the RSG for use with the replacement switch I would be installing in its place; I would need another of the same type of switch to use with the gray pressure switch connector part when replacing its pressure switch body.

I needed a switch that would be normally open—i.e., open in its default state of no action. The switch would need to close when the actuator retracted and pulled the park brake on. I selected a lever w/roller micro switch at Radio Shack; these switches are manufactured with three terminals: common, normally open (NO), and normally closed (NC). I connected the leads from the RGS to the common and the NO terminals. The lever w/roller micro switch closes when the actuator is fully retracted (brake on); the factory wiring to the dash lights is unchanged.

Chevy P30 Chassis – J71 Auto Park Brake Revision

How—I pried the edges of clamping retainer ring out so it was not clamped around the RSG body and the pressure body that operated the switch. After I separated the pressure body from the switch body, I cut out the switch mechanism that was across the switch body opening. I now had a connector that would plug into the factory wiring harness connector, without having to make any alterations to the wiring harness; I had, however, to make leads to connect my new switch to this switch body.



Though the leads I made to connect the switch to the switch body would draw minimal current, I used some 16-gauge 2-conductor speaker wire (heavy-duty lamp cord) I had. I split the conductors apart the same way as the lamp cord splits apart, slid a piece of heat-shrink tubing (acts as an electrical insulator and helps keep dirt and grime off the terminals and connections) over each of the conductors.



I then soldered the lead ends to the switch as follows: one lead end went to the common terminal of the switch, and the end of the other lead end went to the NO terminal of the switch. After soldering, I used a heat gun to shrink the heat-shrink tubing around the soldered connections to the switch and over the end of the lead. I then heat-shrunk a short piece over the exposed and unused switch terminal. I soldered the other ends of the leads to the terminals inside the RGS body, then filled it with dielectric grease to insulate the connections and keep the elements out of the body.

Chevy P30 Chassis – J71 Auto Park Brake Revision

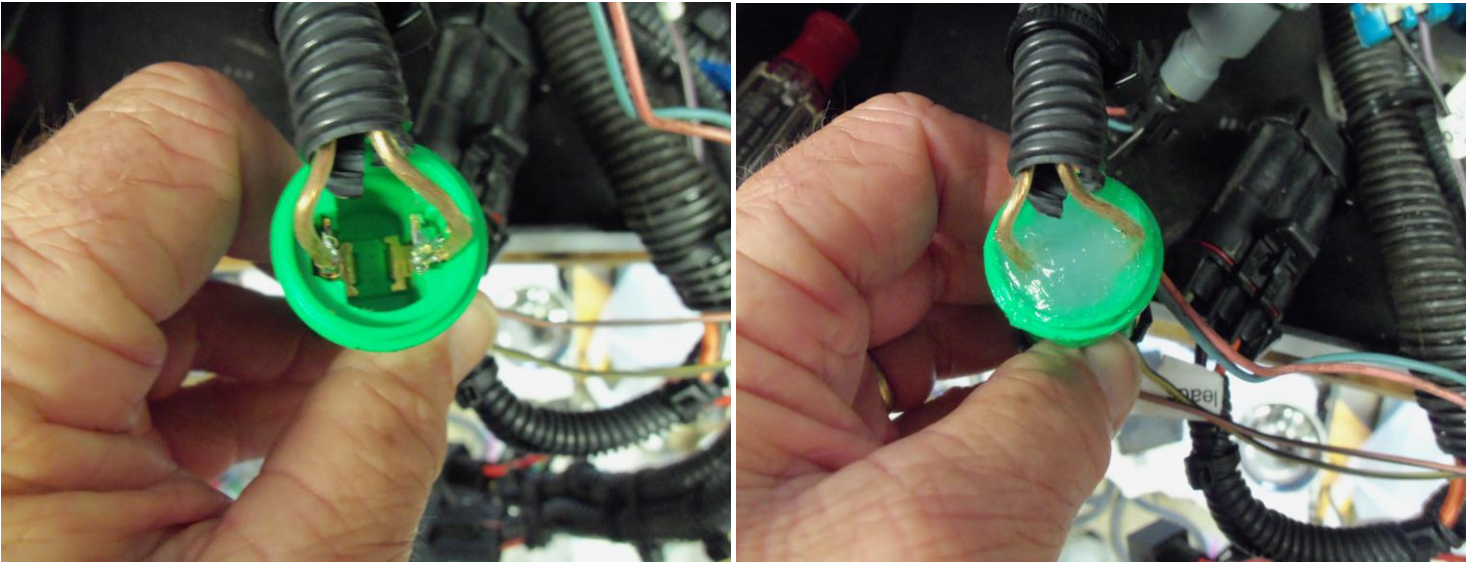

- b) Gray pressure switch in tee at end of hydraulic cylinder.
What—Gray pressure switch in tee at end of hydraulic cylinder. This switch is effectively the same as the RGS, except that on the outside the switch body is gray instead of green, and internally the pressures that operate the two switches are different (one operates at a higher pressure than the other, but that difference is of no consequence now that the hydraulic system is no longer there. For our purposes, the two switches are the same in that both are NC (no pressure and with the brake on).

Why—Handle this switch the same as the green switch above. You will need to make another lead to connect a second identical micro switch to the gray switch body.

How—Repeat steps at How above in a) above for this switch.

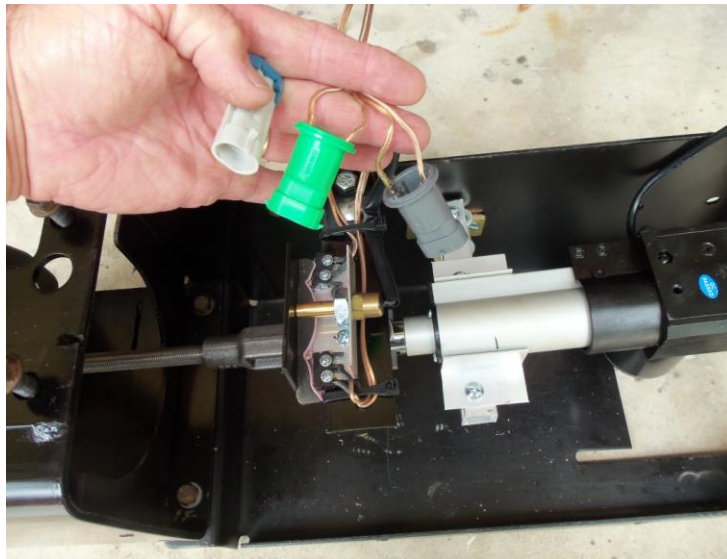

- c) The brass switch screwed into the flange of the hydraulic cylinder where the internal spring is.

What—The brass switch screwed into the flange of the hydraulic cylinder where the internal spring is located. This switch operates differently from the two pressure switches in a) and b) above; it is a typical mechanically operated switch, except that it is normally closed and opens when the switch plunger is pressed into the switch. Though most mechanically operated switches are normally open, this one is normally closed.

Chevy P30 Chassis – J71 Auto Park Brake Revision

Why—This switch operates another item in the brake warning or light system. What this switch operates, however, is just turning something off when there is no pressure and the park brake is fully on (fully applied), and turning something on when the cylinder begins to extend. All you will be doing is installing this switch—with its factory leads and plugs—up at the actuator, and it will serve the exact same purpose that it serves in the hydraulic system.

How—Simple: Just place the switch at the actuator where it will serve the same purpose and operate the same as it did when in the hydraulic brake operator. The switch is mounted to the switch bracket, as the actuator retracts or extends, a steel angle mounted to the actuator/brake yoke coupling moves with the actuator, this opens or closes the switch.



This photo shows the three switches which detect whether the brake is on or off. This assembly of switches is shown installed in the bottom right photo on page 17, that photo shows these switches with the brake on. The top left photo on page 18 shows these switches with the brake off.

d) Another alteration I made was that I ADDED two relays.

What – The two relays I added do one thing and one thing only: they reverse the polarity of the 12 volt power to the actuator so that it will extend or retract as needed.

Why – The actuator extends when power is applied in the correct polarity, then stops at an internal pre-set switch. When the voltage is reversed the actuator retracts and stops at another internal pre-set switch. Reversing the polarity is what extends and retracts the actuator when the brake called for to be “off” or “on”.

How – The leads from the connector which originally went to the hydraulic pump motor provide power to activate the actuator, except that this 12 volt power always has the same polarity between the conductors. The two relays are wired to the two motor leads with one motor lead going to the NO terminal of one relay and the NC terminal of the other relay, at the same time, the other motor lead is going to the NC terminal of the first relay and the NO terminal of the second relay.

When there is power on the motor leads (the hydraulic pump would be turned on and the park brake would be off because the hydraulic cylinder would extend and release the brake), this 12-volt power pulls the relays in and connects the NO terminal to the common terminal, which connects the 12-volt polarity to the actuator in the polarity, extending the actuator.

Chevy P30 Chassis – J71 Auto Park Brake Revision

When there is no power on the motor leads (the hydraulic pump would be turned off, which would allow the spring to retract the hydraulic cylinder, thus applying the brake), there is no 12-volt power to the relays. This created a problem, as the actuator still needs power to retract. I solved it by permanently closing the factory relay, which closes to turn the hydraulic pump motor on and then opens to shut the pump off. The factory relay is now always on, providing power to the actuator when the ignition is on. When the relays are operated, the polarity reverses. The actuator extends or retracts based on the polarity of the 12-volt power; its built-in limit switches open and cause the actuator to stop moving. The actuator moves again when the polarity is reversed, extending if previously retracted, retracting if previously extended.



The way I reversed the polarity to the actuator was to connect the motor leads to the NC contacts of two new relays I added; this powers the actuator. I then connected the leads from the dump valve (this dumps the pressure in the hydraulic system). Instead of opening the dump valve, this power now operates the relays, opening the NC contacts and closing the NO contacts.

The way I reversed the polarity to the actuator was to connect the motor leads to the normally closed (NC) contacts of two new relays I added, this powers the actuator. I then connected the leads from the dump valve (this dumps the pressure in the hydraulic system), however, instead of opening the dump valve this power now operates the relays, opening the NC contacts and closing the NO contacts.

The polarity is reversed because I have 12v+ to one relay NC contact with 12v- to the second relay NC contact, and, 12v- to the first relay NO contact with 12v+ to the second relay NO contact – when the relays switch from NC to NO the relays switch polarity to the red common leads which are connected to the linear actuator.

When the transmission is in Park and the ignition is on, there is power to the dump valve – this causes the relays to switch from the NC contacts to the NO contacts and reverses the polarity to the actuator (this causes the actuator to retract and apply the park brake).

When the transmission is shifted out of Park (with ignition still on) and into Reverse, Neutral, or Drive there is no power to the dump valve – this causes the two new relays to switch from the NO contacts to the NC contacts and reverses the polarity to that actuator (this causes the actuator to extend and release the park brake). Each operation of the relays reverses the polarity of the voltage to the actuator and causes the actuator to operate, i.e., if the actuator is extended it will retract, and if retracted it will extend.

When the transmission is shifted out of Park (with ignition switch still on) and into Reverse, Neutral, or Drive and the 'Park Brake' switch is switched 'on', power is applied to the dump valve – this causes the relays to switch from the NC contacts to the NO contacts and reverses the polarity to the actuator (this causes the actuator to retract and apply the park brake the same as if the transmission was shifted into Park).

Chevy P30 Chassis – J71 Auto Park Brake Revision

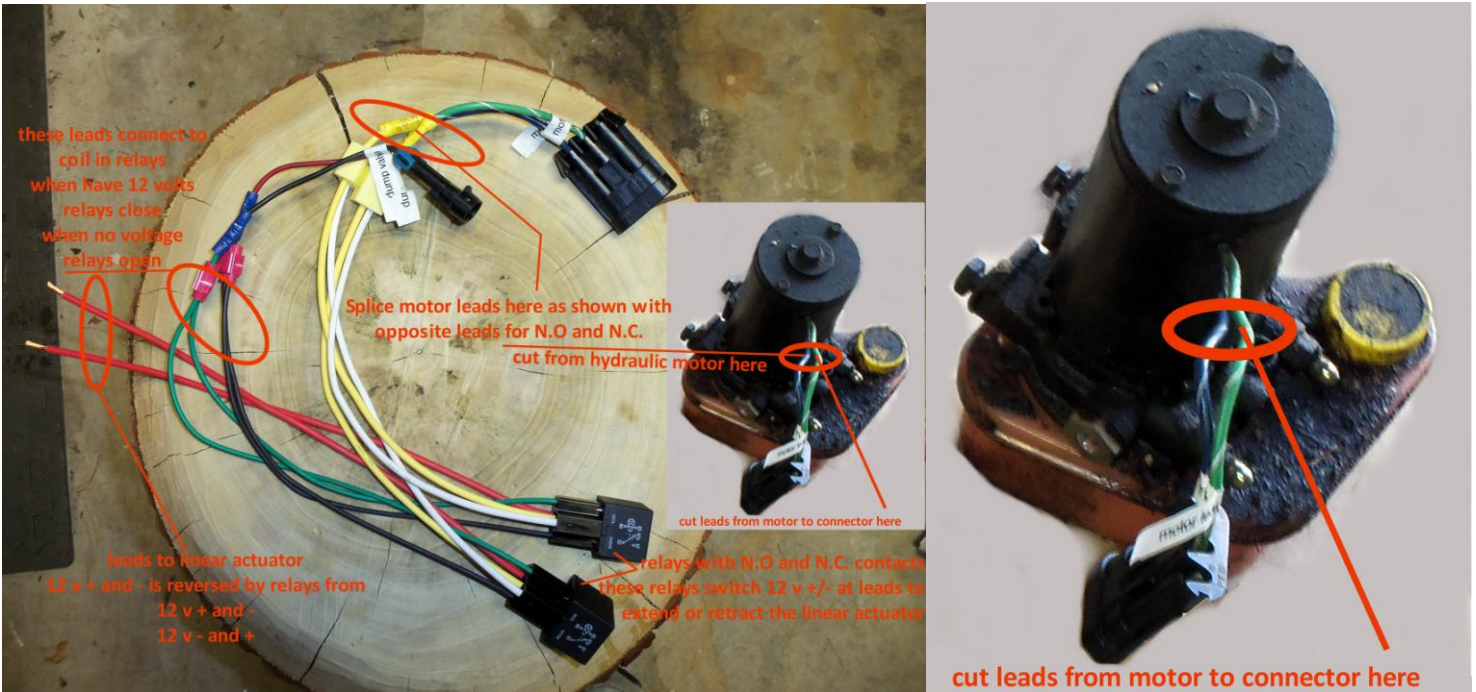

The motor leads from wiring harness connector are color coded green with white tracer and black.

- The green w/white tracer gets connected to the yellow from the first relay and the white from the second relay.
- The black lead from the connector gets connected to the white from the first relay and the yellow from the second relay.

The relay leads are color coded as follows:

- Red leads are the common and go to the actuator.
- Yellow leads are NC.
- White leads are NO.
- The black and green leads are the solenoid leads.

The leads which went to the dump valve now go to the solenoids of the relays. When the Auto Park Brake was powering the dump valve to dump the hydraulic pressure to allow for 'brake on', those leads are now powering the solenoid of the relays to pull the relays in from the NC contacts to the NO contacts.

The 12 volt + and - to the relays and to the red leads to the actuator are reversed from 12 volt + and - to 12 volts - and +.

The reversed polarity activates the actuator to extend if retracted and to retract if extended.

It is not a big deal if your first connection of the red leads to the actuator extend the actuator to brake 'off' when it should have retracted the actuator for brake 'on' as the solution is to reverse the connection of the red leads to the actuator leads - now it will operate correctly.

Chevy P30 Chassis – J71 Auto Park Brake Revision

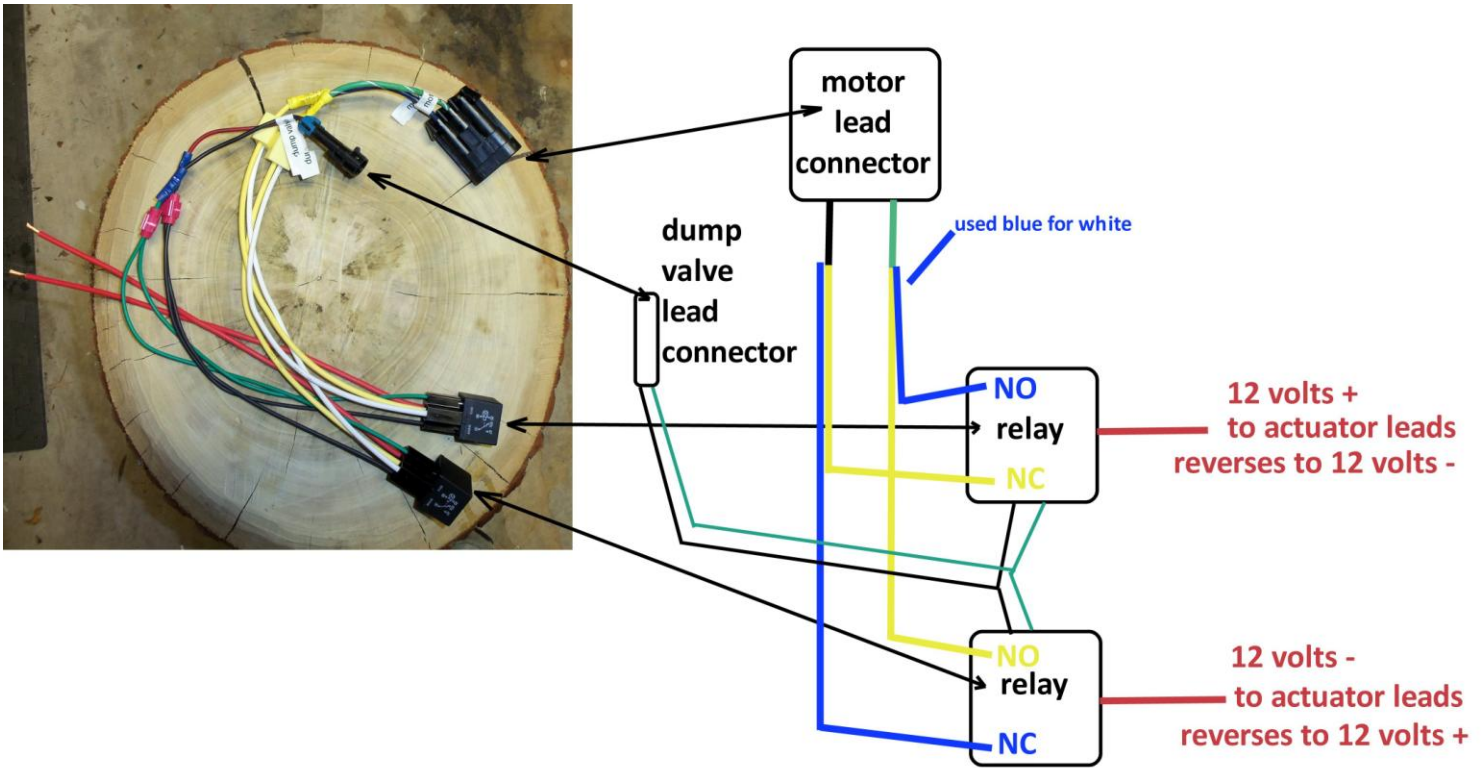

While I was installing the new park brake system, I was going to unplug the various plugs in order to identify which switch turned on the auto park light, which switch turned on the parking brake light, and which switch turned on the alarm (which is located someplace under the dash), However, as I was laying on my crawler checking that the brake unit worked as intended (it did), the weather turned bad and started raining – raining hard. I installed the side cover/access plate and called it a day; I had completed the work and all was performing as it should.

The next day I took the motorhome off the jackstands and drove it back to our parking spot ... I had forgotten to check which switch operated the auto park light and which operated the parking brake light.

The following day I remembered that I had not experimented with the plugs/switches to find out which switch operated which light or the alarm. However, I have not yet brought the motorhome back home to raise it up and go back underneath it to check which switch does what.

I am still curious, though, and would like to know which switch does what, so when I go to replace/repair something else that requires raising the motorhome on jackstands I will try to remember to check this out. I invite anyone who follows my conversion operates which light to please share their results with me. Just send me a much-appreciated note.

Chevy P30 Chassis – J71 Auto Park Brake Revision



The factory wiring harness, which is part of the park brake unit. This is reused without alteration; the two connectors at the top of the harness connect to two connectors on the chassis, the ground connected to a bolt in the park brake unit housing.

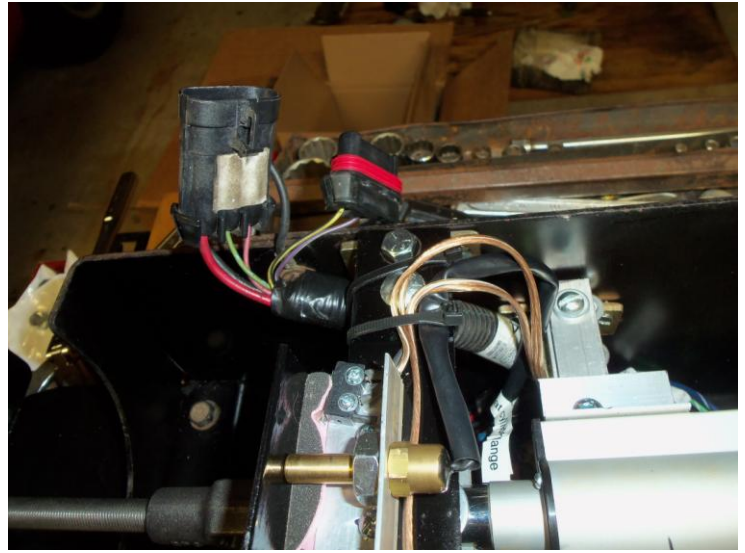

The two connectors that mate with the two connectors from the chassis.

As previously stated, the factory wiring harness was not altered. This allowed the factory wiring and controls to be reconnected and operate as they did originally.

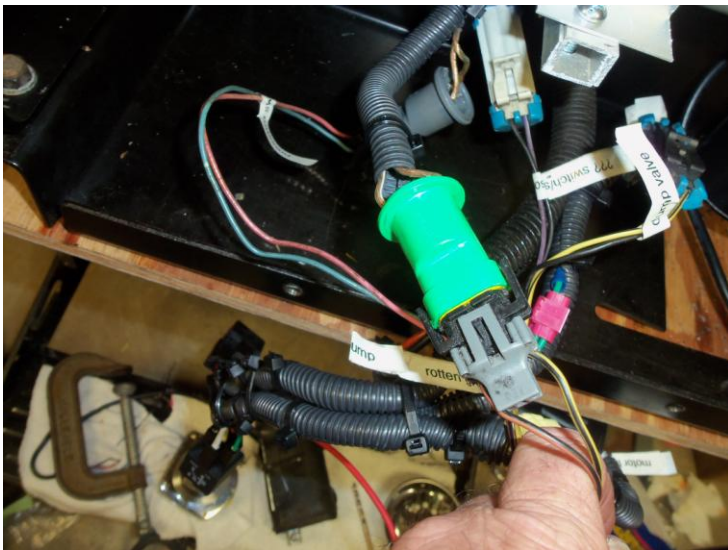

The switch housing from the RGS. It connects with its matching factory connector because the factory wiring harness was not altered.

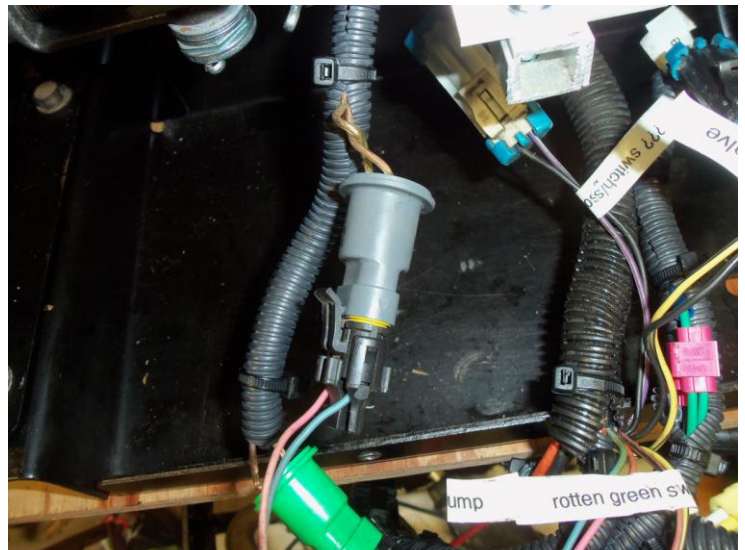

The switch housing from the gray switch, which was into the tee at the back of the hydraulic cylinder; it is a pressure switch almost identical to the RGS. This also connects with its matching factory connector because the factory wiring harness was not altered.

Chevy P30 Chassis – J71 Auto Park Brake Revision



The connector from the switch that went into the hydraulic cylinder housing where the internal spring was. It now connects to the same switch, mounted to indicate when the brake is full on or not full on. It connects with its matching factory connector because the factory wiring harness was not altered.

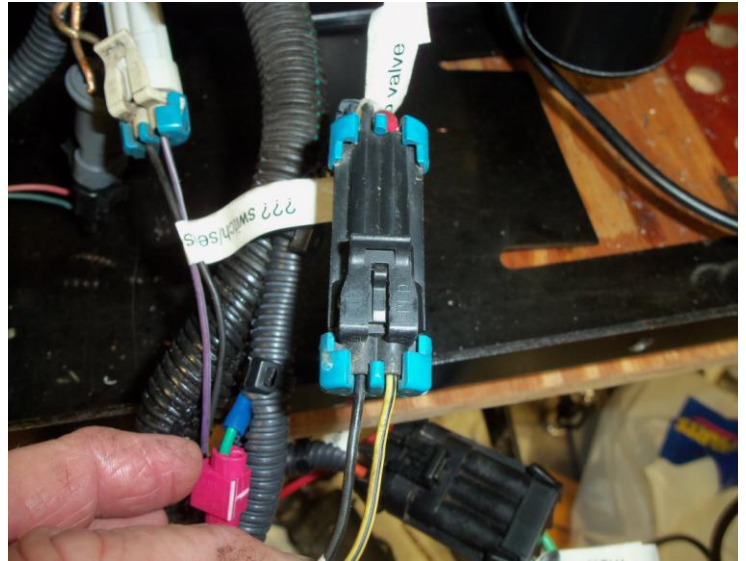

The connector from the dump valve switch. It now provides power to the two new relays, which reverse the polarity as needed to the actuator to extend or retract it. It connects with its matching factory connector because the factory wiring harness was not altered.

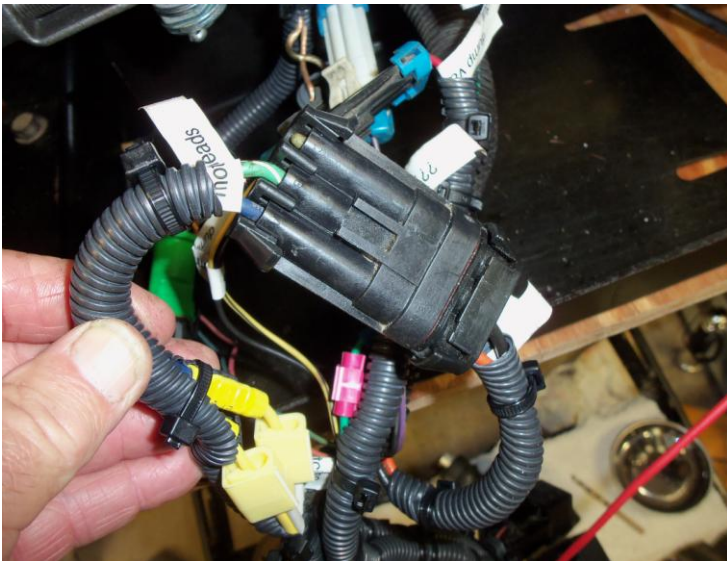

The connector from the hydraulic motor leads; it now provides power to the actuator. It connects with its matching factory connector because the factory wiring harness was not altered.



There are now three relays in the park brake unit:

- The left relay is the factory relay, which turned the motor on when not in P. This relay now has the switch contact inside in permanent contact, making the relay always on.
- The two relays to the right are the two new relays I added to reverse the polarity of the 12 volts to the actuator, which retracts or extends the actuator as called for by the factory park brake system, wiring, and components. Everything remains automatic, as it was originally.

Chevy P30 Chassis – J71 Auto Park Brake Revision

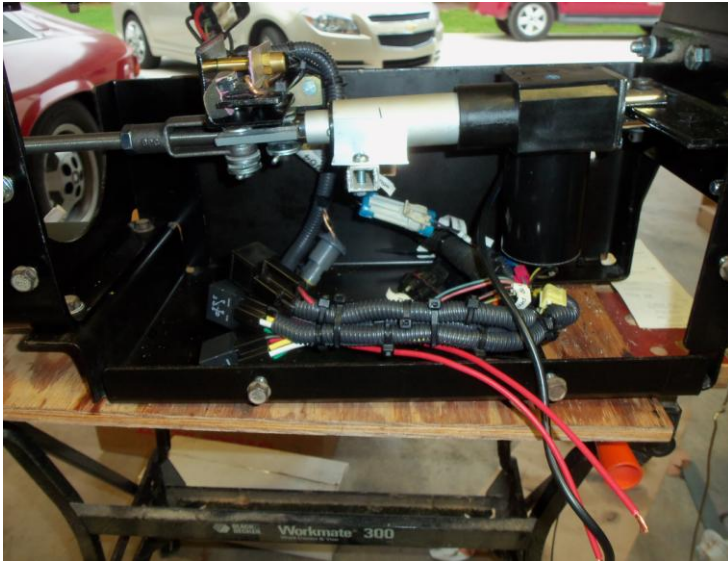

Completed assembly showing the uncomplicated design of the 12-volt linear actuator compared to the original hydraulic system, which was much more complex; see photo at right.

The two red leads to the actuator have not been connected to the actuator at this point; I am leaving them disconnected until I install the unit and verify which polarity extends and which retracts the actuator. Once I have the actuator extending when it should and retracting when it should, I will connect those leads.

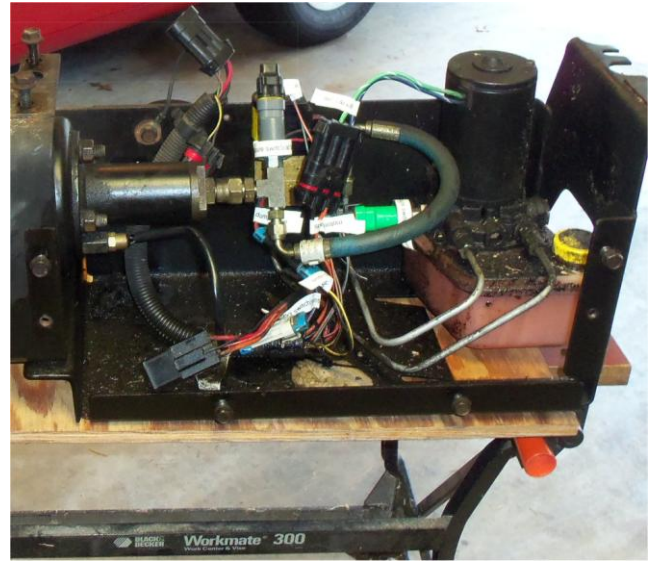

The original hydraulic system, which is prone to leaking and failure while driving.

The photo at upper left also shows where I added washers at the brake yoke/connector plate pin and connector plate/actuator pin to serve as shims to align the various parts and to take the slack out of the extra length of the pins. I also added a jamb nut on the 1/2-20, threaded tight against the brake yoke to keep the rod from becoming loose in the brake yoke. Everything is now snug-fitting and tight.



The two new relays I added.



The two sockets I used for the two new relays.

Chevy P30 Chassis – J71 Auto Park Brake Revision



This is what I used to keep the new wiring neat, orderly, and protected.



The tool I made to pull against the internal spring in the hydraulic cylinder to check the stroke length of the original park brake assembly.

After pulling the threaded shaft all the way out, the stroke measured 2 inches. The new linear actuator has a stroke of 3 inches.



The installed park brake unit with the actuator extended (brake off).



The installed park brake unit with the actuator retracted (brake on).

Chevy P30 Chassis – J71 Auto Park Brake Revision



A view of the completed and installed unit prior to installing the access cover plate. For good measure, I installed two black cable ties X-fashion around the actuator to hold it down so it does not bounce or move up and down. It did not move during my testing, but I want to make sure it also does not move while driving.

Use only black ties for anything outdoors as black ties are rated for outdoor use and are sunlight resistance. White ties are not rated for outdoor use as they are not sunlight resistant.

The cable tie loop visible hanging over the edge of the bottom vertical lip will go around the bolt shown behind it. This loop is connected to the wiring harness and will hold the wiring harness in place on the bottom to make sure the wiring does not move around or hang out the open back of the unit.

In use results:

My redesign of the park brake does all of the same actions (engages/disengages) as the original Chevy P30 J71 park brake was intended to do as I did not change any of the wiring or controls in the coach or chassis – every action is automatically performed just as the original park brake performed those actions, but without as complicated of a design and with fewer components to fail – without the parking brake being applied while driving if a component fails.

I have tested my redesigned park brake on a 4% grade, the park brake set and held tight. My next test will be on an 8% grade (I will update this with results from that test).

DISCLAIMER

(In a nutshell: If you do what I show and describe, and something happens or goes wrong, it is not my fault.)

Anyone who makes this conversion and uses my descriptions of my conversion or bases their conversion on any part or parts of my conversion or descriptions does so at their own risk and agrees to hold me harmless for any such use of my descriptions in whole or in part. I am not doing the work, and therefore have no control over how the work is done or how the work is tested; I am simply describing and showing what I have done to solve a serious defect that affects many owners and drivers of vehicles and motorhomes built on the Chevrolet P30 chassis that incorporates the J71 park brake system. There are also various versions of the J71 park brake system on the various vehicles, some similar or the same as the one on our motorhome and some quite different from the one I worked with. This auto park brake was a self-contained unit, but I have seen some with the hydraulic pump remotely located, and others that are even different from those.

I wish you all a happy result with your own conversion.



The completed unit with the last piece installed: the access cover plate on the side of the unit.

This cover plate also adds to the strength of the unit by securing the back plate in place. Because the actuator is pushing/pulling against the back plate of the unit, this is additional bracing to keep the back from flexing. I could not detect any movement of the back plate during testing without the access cover installed—the access cover installed on the side of the box makes the box a rigid assembly.