

CICA & CANZ Guidance Note

Crane Stability and Ground Pressure

Author: The Crane Industry Council of Australia
Date: 30/01/2017

CICA-GN-0013-A



Table of Contents

| | |
|---|-----------|
| 1. Introduction | 3 |
| 2. Responsibility | 3 |
| 3. Loads and Forces | 4 |
| 3.1 Crane loads..... | 4 |
| 3.2 Rigging gear..... | 4 |
| 3.3 Object loads..... | 4 |
| 3.4 Load cases..... | 4 |
| 3.5 Calculation..... | 4 |
| 3.6 Lifting on rubber..... | 9 |
| 3.7 Articulated crane..... | 9 |
| 3.8 Manufacturer's software..... | 9 |
| 3.9 Theoretical calculations..... | 10 |
| 4. Crane Mats | 10 |
| 4.1 Crane mat size calculation - uniform pressure..... | 10 |
| 4.1.1 Example 1..... | 10 |
| 4.1.2 Example 2..... | 11 |
| 4.2 Crane mat strength and stiffness..... | 11 |
| 5. Ground Condition | 11 |
| 5.1 Ground capacity..... | 11 |
| 5.2 Trench diagram..... | 12 |
| 6. Reference | 13 |
| 7. Further Information | 14 |
| Appendix A – Articulated Crane Axle Loading | 15 |
| Appendix B – Manufacturer Software Calculation Examples Outrigger Pad Load | 17 |

Disclaimer and Copyright

This CICA&CANZ Guidance Note has been compiled for general information only, is not to be considered as a substitute for professional advice, and should not be treated as an exhaustive statement on the subject. The Crane Industry Council of Australia (CICA) and the Crane Association of New Zealand (CANZ) accept no responsibility for the accuracy, completeness or currency of the material included in this Guidance Note. Users of this Guidance Note are encouraged to obtain professional advice and to exercise their own skill and care in relation to any of its material.

CICA and CANZ disclaim any and all liability or responsibility for any loss or damages arising out of any use of, or reliance on, this Guidance Note. This Guidance Note is copyright. Readers may use and reproduce this material in an unaltered form only for non-commercial use within their own organisation. Apart from any use permitted under the Copyright Act 1968, all other rights are reserved.



1. Introduction

Many factors need to be considered when safely setting-up mobile cranes on site. Crane stability often depends on the integrity of the ground on which it stands. Effective assessment of ground conditions is essential to assist with safe set up and operation of cranes. To reduce the risk of crane accidents as a result of improper crane set-up, planning activities shall be carried out by a competent person(s) to assess the capability of the ground to withstand the loads and pressures imposed by the lifting equipment.

All parties who are involved in the planning, set up and use of cranes on site must be aware of the fundamental criteria, planning issues and risk assessments that are needed to ensure lifting operations proceed in a safe and stable manner.

This Guidance Note provides general guidance to assist on:

- determining the load exerted by mobile crane outriggers or crawler crane tracks
- determining the suitability of the crane mats, and
- bearing capacity of different types of soil.

2. Responsibility

As with all activities on construction sites, the effective management of the safety of lifting operations can only succeed if all parties involved are clear about their roles and responsibilities. It is essential for all persons undertaking these roles to be competent, having relevant up-to-date training and the qualifications and experience appropriate to the operations for which they are responsible.

The responsibilities for undertaking the various activities involved in ground assessment are set out below:

- A person conducting a business or undertaking (PCBU) that includes the carrying out of construction work (i.e. the principle contractor in control of the project site) has overall responsibility for the safety of all personnel on site. They should ensure that where a crane is being used to carry out a task, adequate steps have been taken to ensure the stability of the crane during transport onto site, set up, use, movement, maintenance, dismantling and removal from the site. PCBU should provide accurate geotechnical report for the site ground condition or other relevant information for crane stability to the worker responsible for the lifting operations if this is necessary for the safe operation of the lifting activity. It is usually the PCBU's responsibility to make sure the ground is safe to work on.
- A worker who carries out work for a PCBU (i.e. the person or company in control of a lifting operation) is responsible for all aspects of planning, supervision and execution of the lifting operation, including ensuring that the ground or structure on which equipment stands will take the loads imposed by the plant. This does not mean that the worker has to be an expert in ground assessment, they must however take reasonable steps to satisfy themselves that the information provided by the person in control of the site is relevant and appropriate. The worker should have the necessary confidence and authority to carry out their duties effectively and safely.

Where doubt exists as to the accuracy or sufficiency of the information provided it is the responsibility of the worker to ensure that the lifting operation does not proceed until the doubt has been satisfactorily resolved.



3. Loads and Forces

Assessment of loads and forces imposed by the crane on the ground shall be conducted during the planning stage. The following loads and factors should be considered when assess load and forces.

3.1 Crane loads

Information on crane loads and forces can be found from sources including technical data published by the manufacturer. Different rigging configurations of the crane, i.e. using different combination of counterweights or fly jibs in the lift operation may associate with different crane weight distribution. Refer to the manufacturer data to determine what rigging configuration is representative and what weights and loads apply. Information on individual weight and center of gravity of the crane components should be obtained and applied in the load calculations.

3.2 Rigging gear

Correct weight of lifting accessories such as chains, shackles, spreader bars, etc. shall be added up and included as part of the vertical load when calculating loads and forces.

3.3 Object loads

Always obtain accurate information (weight, density, overall dimensions and center of gravity) about the load to be lifted, do not guess and do not use the crane as a 'weighing scale'.

3.4 Load cases

Different load cases can impose different loads and forces to the ground (see Figure 1 and Figure 2). During the lift operation, crane boom length, slew angle and slew arc may vary, these will change the forces on the outriggers. It is often assumed that the maximum loads and forces will occur during operation at maximum capacity, this is not always the case, for example, outrigger loads could be at its highest without any load on the hook at minimum radius due to backward moment from the counterweight^[1]. In some load cases, total load of the crane may be imposed largely on one outrigger or one crawler track when the boom or counterweight is slewed over that outrigger or over the side of that track.

3.5 Calculation

Calculation of the load exerted by the crane outrigger or track should consider both the vertical load (from the crane loads, rigging gear loads and object loads) and the load caused by the moment acting on each outrigger or track under different load cases (see Figure 1 and Figure 2). Refer to detailed examples of calculations included in Cranes and Derricks^[2] for all-terrain and crawler cranes.

In addition, other loads to consider include:

- dynamic loading due to wind pressure
- lateral loading due to incorrect set-up or different settlement of supports
- dynamic loads caused by slewing or a swinging lifted load
- dynamic loads caused by crane travelling with load
- emergency loads

Refer to AS1418^[3] for values of the dynamic load factors.

| No Load On Hook | Load On Hook |
|---|---|
| | |
| <p align="center">Highest Load on front outrigger</p> | <p align="center">Highest Load on rear outrigger.</p> |
| | |
| <p align="center">Highest load on outrigger under counterweight.</p> | <p align="center">Highest load on outrigger under jib.</p> |
| | |
| <p align="center">Highest load on outriggers under counterweight.</p> | <p align="center">Highest load on outriggers nearest load.</p> |
| <p> ■ = greatest pressure imposed on this outrigger for this lifting configuration ■ = intermediate pressure imposed on this outrigger for this lifting configuration ■ = smallest pressure imposed on this outrigger for this lifting configuration </p> | |

Figure 1 (a) – Outrigger Load Change due to Different Load Cases





| No Load On Hook | Load On Hook |
|---|--|
|  |  |
| <p>Highest Load on front outrigger.</p> | <p>Highest load on outrigger under counterweight.</p> |
|  |  |
| <p>Highest load on outrigger under jib.</p> | <p>Highest load on outriggers nearest load.</p> |
| <p>  = greatest pressure imposed on this outrigger for this lifting configuration  = intermediate pressure imposed on this outrigger for this lifting configuration  = smallest pressure imposed on this outrigger for this lifting configuration </p> | |

Figure 1 (b) – Outrigger Load Change due to Different Load Cases

| No Load On Hook | Load On Hook |
|--|--|
|  |  |
| <p>With no load on the hook the pressure is at highest under the rear end of the tracks due to the counterweight.</p> | <p>With load on the hook, the pressure changes from triangular to trapezoidal distribution.</p> |
|  |  |
| <p>With no load on the hook and the jib luffing down, the pressure changes from triangular to trapezoidal distribution.</p> | <p>With load on the hook and the jib luffing down the pressure changes from trapezoidal to triangular distribution, with the highest under the front end of the tracks.</p> |

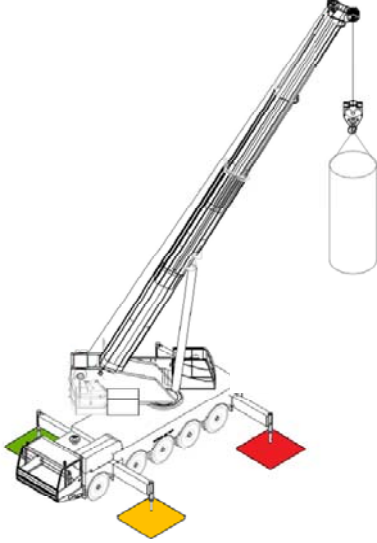
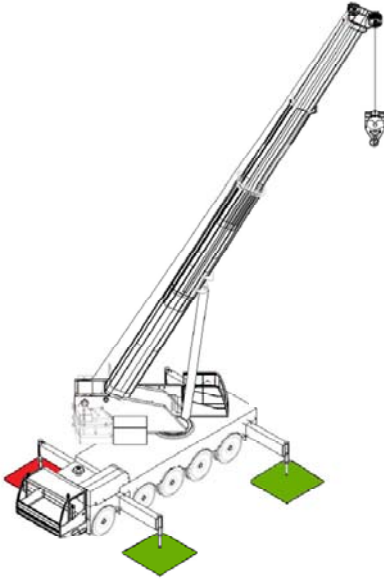
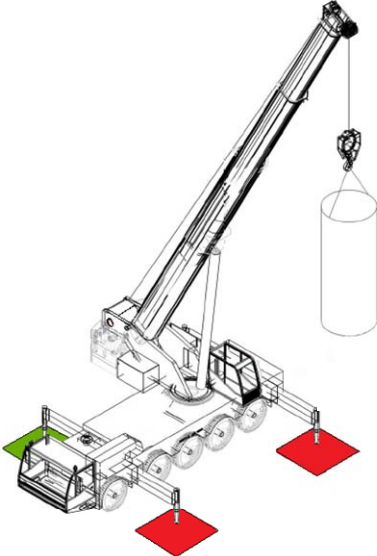
Figure 2 (a) - Crawler Track Pressure Change due to Different Load Cases

| | |
|--|--|
|  |  |
| <p>With no load on the hook the pressure is at highest under the rear of the tracks due to the counterweight.</p> | <p>With the jib in line with the tracks and a load on the hook there will be an equal triangular or trapezoidal loading under each track.</p> |
|  |  |
| <p>As the jib is slewed around until it is over the end of one track, the pressure increases under that track.</p> | <p>If the jib is slewed until it is at right angle to the tracks the pressure becomes a rectangular distribution with the track nearest the load having the greatest pressure.</p> |

Figure 2 (b) - Crawler Track Pressure Change due to Different Load Cases

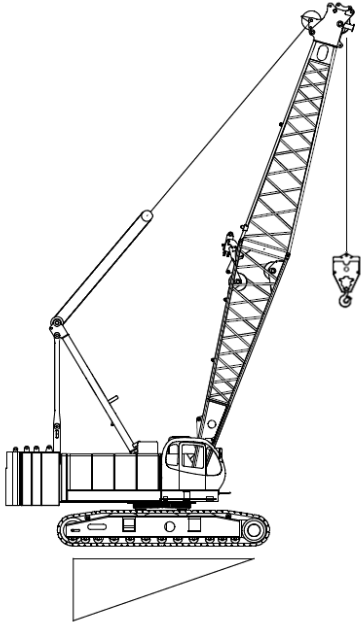
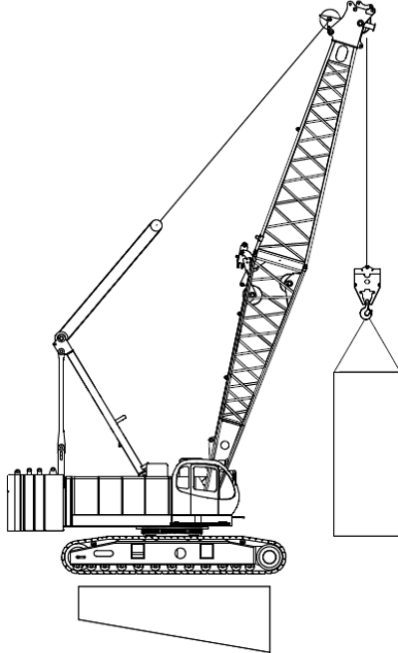
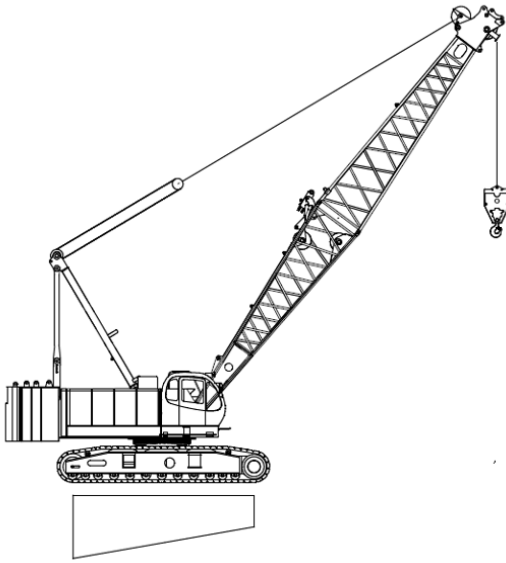
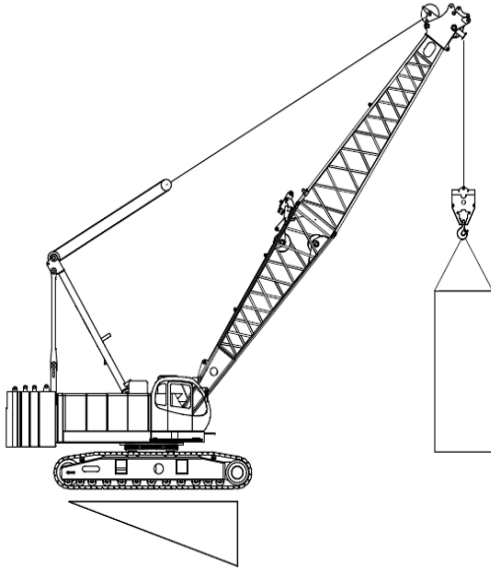

3.6 Lifting on rubber

Crane operated without the outriggers extended is referred to as “operating on rubber”. When operating on rubber, follow the setup procedure and operating limitations specified by the crane manufacturer. On rubber load chart shall be used if operating on rubber. Tire conditions need to be properly checked and tires need to be inflated per the manufacturer’s specifications.

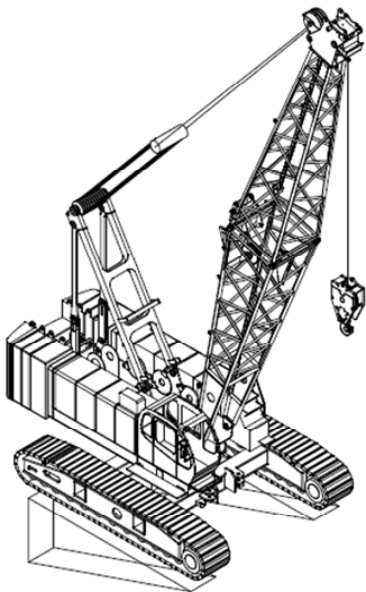
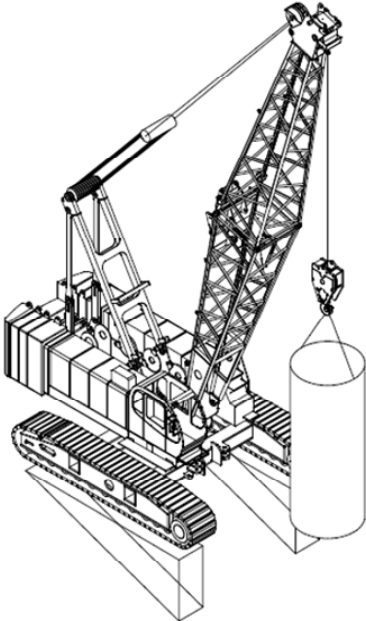
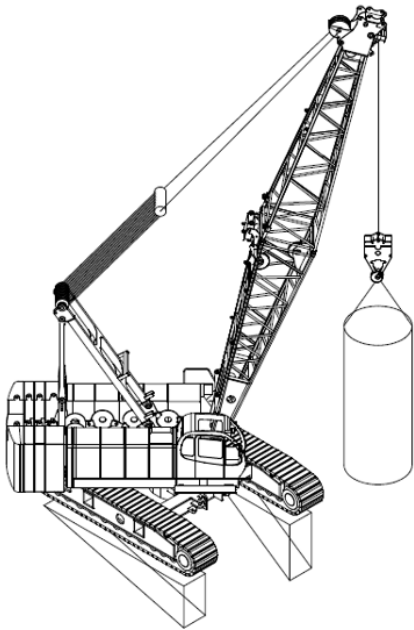
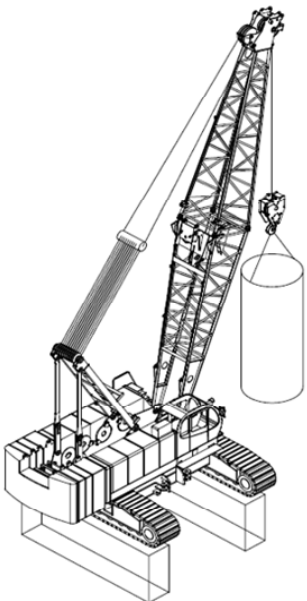
Where the load will be picked from and where it will be placed must also be considered, so ground conditions for the picking and placing area can be assessed.

3.7 Articulated crane

It is recommended that articulated crane loads should be calculated or checked by an engineer through theoretical calculation. Refer to Appendix A for reference for articulated crane axle loading.

3.8 Manufacturer’s software

Many crane manufacturers supply software and tables that can give accurate and comprehensive load data when these resources are used properly.

Table 1 is a list of some of the available software from manufacturers:

| Manufacturer | Link |
|--------------------|--|
| Kobelco | https://www.kobelco-kenki.com/en_cris/top/home.htm |
| Liebherr | http://www.crane-planner.com LICCON work planner |
| LinkBelt | http://www.linkbelt.com/support |
| Manitowoc | http://www.manitowoccranes.com/en/Resources/tools/lift-planning |
| Sumitomo | http://www.hsc-crane.com/e/pressure2.asp |
| Tadano | https://www.tadano.co.jp/service/data/tdnsys/jackale/register.asp |
| Terex-Demag Franna | http://www.terexcranes-liftplan.com/ Contact Terex Product Support Team for Franna Axle Load Calculation |
| Other | http://www.3dliftplan.com http://www.cranimax.com Other Manufacturer provide software/data table |

Table 1 Manufacturer’s Software

Tabulated data for individual models is also available from some Manufacturers. The manufacturer may also provide loads for specific requests and load cases.

When properly used, manufacturers’ resources are the preferred method of calculation. Manufacturer software are provided with static analysis with specific load conditions (example in Appendix B), conditions under which the results are calculated must be



interpreted correctly and limitations of the calculation must be considered when using the results in lift planning.

3.9 Theoretical calculations

Although manufacturer's software is a good resource to use, theoretical calculations are useful for checking the computed results to make sure the resources are properly used. Theoretical calculations can account for conditions not considered in the manufacturer's software or for where the crane model is not covered by the manufacturer's software.

It is recommended that theoretical calculations of crane loads for different load cases should be done by a **competent person** (i.e. qualified engineer).

4. Crane Mats

Crane mats (timber, steel, HDPE, etc.,) are used to distribute the load of the crane to the ground. The suitability of the crane mat used is determined by:

- the size of the mat is suitable to distribute the load to the ground at a stress level less than the ground bearing capacity and
- the strength and integrity of the mat and its ability to handle the load exerted by the crane.

4.1 Crane mat size calculation - uniform pressure

Unit convert:

$$1 \text{ t/m}^2 = 10 \text{ kPa}$$

Mass and pressure unit convertor and ground pressure calculator are available in:

CICA-CS-0020-0 Multi-crane or Multi-hoist Lifting

4.1.1 Example 1

If crane load and crane mat size is known, the pressure imposed by the crane on the ground can be calculated by:

$$\text{Pressure} = \frac{\text{Force}}{\text{Area}}$$

This pressure is then compared with the maximum permissible ground pressure to check whether the mat size is suitable for the lift.

For example, if the lift study indicates that a crane imposes a maximum load of 48 tonnes on the outrigger, and the available crane mat size is 1.7m x 1.7m. Then the pressure imposed by the crane to the ground can be calculated by:

$$\text{Force} = 48 \text{ tonnes} \times 9.8\text{m/s}^2 = 470.4 \text{ kN}$$

$$\text{Area of the crane mat} = 1.7\text{m} \times 1.7\text{m} = 2.89\text{m}^2$$

$$\text{Pressure} = \frac{470.4 \text{ kN}}{2.89\text{m}^2} = 162.8 \text{ kN/m}^2$$

If the maximum permissible ground pressure is 200kPa, then the crane mat size is adequate for the lift.

4.1.2 Example 2

Crane mat size can be calculated by dividing the crane load by the maximum permissible ground pressure.

$$\text{Pressure} = \frac{\text{Force}}{\text{Area}} \quad \rightarrow \quad \text{Area} = \frac{\text{Force}}{\text{Pressure}}$$

$$\text{Required crane mat bearing area (m}^2\text{)} = \frac{(\text{Crane Load}) (\text{tonne}) \times 9.8\text{m/s}^2}{\text{Maximum permissible ground pressure (kPa)}}$$

For example, if the lift study indicates that a crane imposes a maximum load of 48 tonnes on the outrigger, and the maximum permissible ground pressure is 200kPa. Then the size of the crane mat can be calculated by:

$$\text{Force} = 48 \text{ tonnes} \times 9.8\text{m/s}^2 = 470.4 \text{ kN}$$

$$\text{Maximum permissible ground pressure} = 200\text{kPa} = 200 \text{ kN/m}^2$$

$$\text{Required mat bearing area} = \frac{470.4 \text{ kN}}{200\text{kN/m}^2} = 2.35 \text{ m}^2$$

4.2 Crane mat strength and stiffness

Not only do crane mats used for distribute outrigger loads need to be suitably sized they also need to be strong to withstand the load imposed by the crane outriggers.

The strength and stiffness of the crane mats will depend on the material and the thickness. Shear strength, bearing capacity and bending strength should be checked for the selected crane mats.

For timber mats, good quality timbers should be used. Shear stress is critical for timbers, if excessive, the timber can crack, sharply reducing resistance to bending and inviting failure [2]. Timber bending strength and bearing capacity should also be checked. Timber strength should be calculated in line with AS1720-1[4]. For crane mats made of other materials(steel), refer to manufacturer's specification on bending strength and bearing capacity.

It's also important that the load is placed in the center of the pad and away from the edges. If the load is placed too close to one side it has the effect of concentrating the load on a smaller area, resulting in excessive deformation and possible collapse [1].

Refer to Cranes and Derricks [2] for crane mat strength calculations.

5. Ground Condition

5.1 Ground capacity

Prior to setting up a crane on site, the ground condition should be reviewed in the risk assessment process to determine whether the ground is suitable to operate the crane safely.

It is recommended that the ground condition is inspected by a geotechnical engineer to provide accurate permissible ground pressure. Crane lift study results should be provided to the geotechnical engineer and a geotechnical report should be issued by the geotechnical engineer with instruction of the suitability of the ground at the time of the lifting activity conducted.

The report should provide inspection results of the bearing capacity of the ground including surface conditions as well as layers of the ground under the surface that could influence ground bearing capacity. The ground can have weak layers below the surface and these underlying layers of weak or soft ground can possibly leading to a collapse. The report should also outline the estimated settlement due to the load and whether the settlement would cause any instability of the crane during the lift.

If the ground is found to be not suitable, additional measures must be taken before proceeding with task. These may include but not limited to:

- design measures to reduce imposed loads, i.e. re-selection of the crane, repositioning of the crane, reduction of task loads (e.g. splitting of loads), re-sizing of the crane mat used.
- design measures to ensure ground suitability, i.e. soil stabilization, grouting, dynamic compaction.

Table 2 below listed typical maximum permissible ground pressure for different ground types as a reference ^[5].

| Ground type | Maximum permissible ground pressure (t/m ²) | Maximum permissible ground pressure (kPa) |
|--------------------------------------|---|---|
| Hard rock | 200 | 2000 |
| Shale rock and sandstone | 80 | 800 |
| Compacted gravel—with up to 20% sand | 40 | 400 |
| Asphalt | 20 | 200 |
| Compacted sand | 20 | 200 |
| Stiff clay (dry) | 20 | 200 |
| Soft clay (dry) | 10 | 100 |
| Loose sand | 10 | 100 |
| Wet clay | Less than 10 | Less than 100 |

Table 2 Typical maximum permissible ground pressure for different ground types ^[5]

5.2 Trench diagram

When outriggers exert pressure on the ground, it is important that the outrigger feet do not sink into the ground, or cause nearby excavations to collapse – as this could lead to the crane tipping over.

Outriggers put stresses onto the ground beneath them, sometimes called the “zone of influence” as shown in Figure 3. As a rule of thumb, assume that the zone of influence works at a 45° angle or one meter from top whichever is the greater. **This angle can vary depending on the nature of the ground beneath the outrigger**, and the design of the outrigger support. Further investigation by an engineer may be required when ground conditions are unknown, or when clarification is needed on the rule of thumb.

When it comes to setting up a crane near a trench, always set up a crane, so that the nearest outrigger to a trench, is at least as far away from the trench, as the trench is deep. This rule assumes a zone of influence working at a 45° angle (Figure 4).

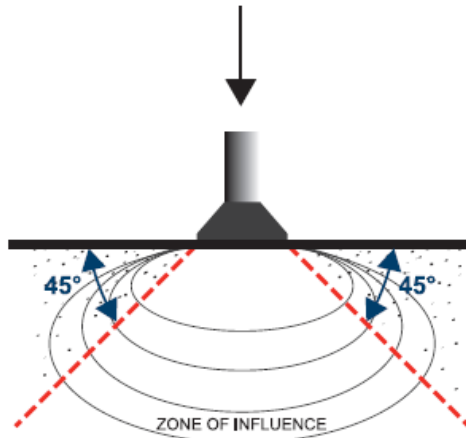

Figure 3 Zone of Influence

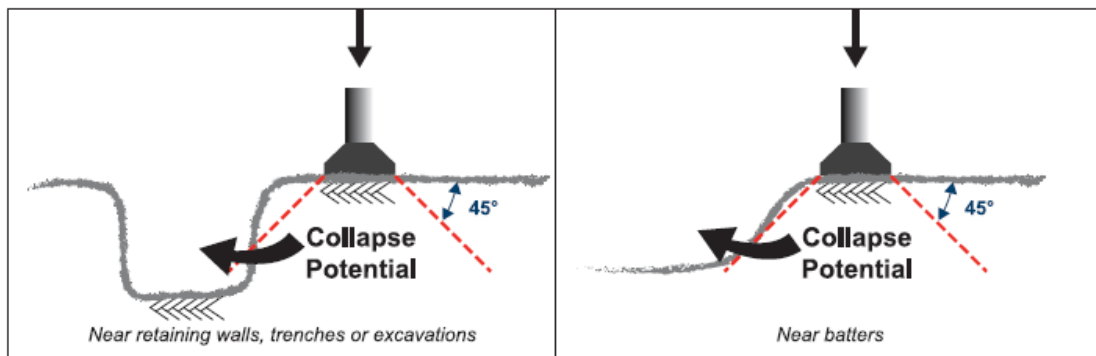

Figure 4 Trench Diagram

6. Reference

1. Good Practice Guide, Ground Conditions for Construction Plant, Strategic Forum for Construction, First Published: October 2014, Construction Plant-hire Association.
2. Cranes and Derricks Fourth Edition, Lawrence K. Shapiro & Jay P. Shapiro. 2011.
3. AS1418 Cranes Hoists and Winches Set.
4. AS1720.1 – 2010 Timber structures Part 1: Design methods.
5. Guidance to Mobile Cranes, Safe Work Australia.



7. Further Information

This Guidance Note is managed by The Crane Industry Council of Australia. It contains summary information only, further information is available by contacting The Crane Industry Council of Australia or the Crane Association of New Zealand:

CICA Contact details

| | |
|-----------------------|--|
| Postal address | PO Box 136, Mount Waverley, Victoria, 3149 |
| Street address | Unit 10, 18-22 Lexia Place, Mulgrave, Victoria, 3170 |
| Telephone | +61 3 9501 0078 |
| Fax | +61 3 9501 0083 |
| Email | admin@cica.com.au |

CANZ Contact details

| | |
|-----------------------|---|
| Postal address | PO Box 12013, Wellington 6144 |
| Street address | Margan House, 21 Fitzherbert Terrace, Thorndon, Wellington |
| Telephone | +64 4 4733558 |
| Email | info@cranes.org.nz |



Appendix A – Articulated Crane Axle Loading

ABN : 86 010 671 048
ACN : 010 671 048
E-Mail : info@terex.com.au
Internet : www.terex.com.au

TEREX  **CRANES**

Terex Lifting Australia Pty. Ltd.



NOTE: ALL DIMENSION IN MILLIMETERS

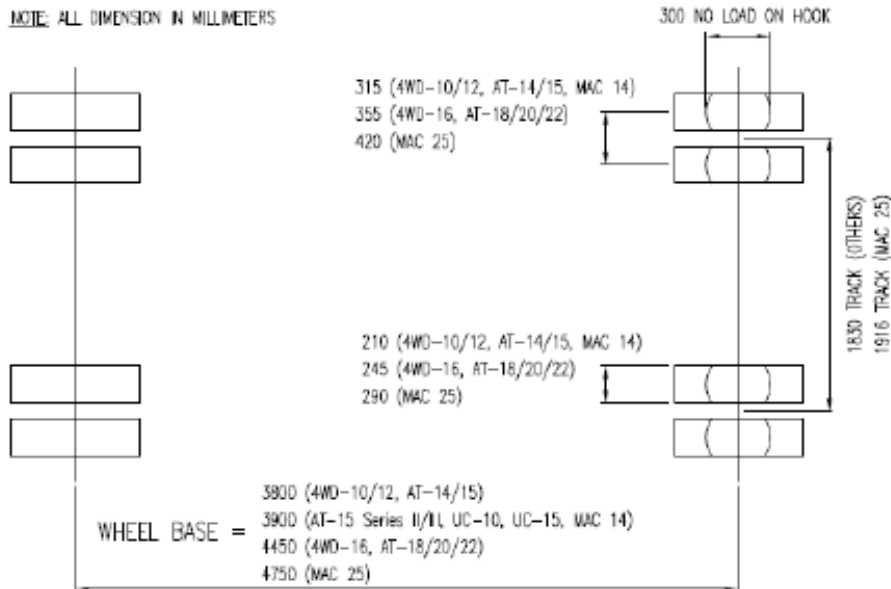

| REAR AXLE TARE (APPROX) | FRONT AXLE TARE (APPROX) | MAX. FRONT AXLE LOADS (APPROX) |
|----------------------------|-----------------------------|-----------------------------------|
| 7200 kg (4WD-10) | 5500 kg (4WD-10) | 20000 kg (4WD-10) |
| 9000 kg (4WD-12) | 5700 kg (4WD-12) | 23200 kg (4WD-12) |
| 9000 kg (AT-14) | 6000 kg (AT-14) | 26030 kg (AT-14) |
| 10000 kg (AT-14 SII) | 6000 kg (AT-14 SII) | 27030 kg (AT-14 SII) |
| 10000 kg (AT-15) | 6000 kg (AT-15) | 28400 kg (AT-15) |
| 10500 kg (4WD-16) | 7200 kg (4WD-16) | 28350 kg (4WD-16) |
| 11000 kg (AT-18) | 8000 kg (AT-18) | 31100 kg (AT-18) |
| 11500 kg (AT-20) | 8000 kg (AT-20) | 34720 kg (AT-20) |
| 12000 kg (AT-22) | 8000 kg (AT-22) | 38500 kg (AT-22) |
| 9000 kg (MAC 14) | 6000 kg (MAC 14) | 26100 kg (MAC 14) |
| 10000 kg (MAC 14 SII) | 6000 kg (MAC 14 SII) | 27100kg (MAC 14 SII) |
| 14000 kg (MAC 25) | 10000 kg (MAC 25) | 42400 kg (MAC 25) |
| 7000 kg (UC-10) | 4000 kg (UC-10) | 19060 kg (UC-10) |
| 10000 kg (UC-15) | 5900 kg (UC-15) | 27900 kg (UC-15) |

CRANE FOOTPRINTS & AXLE LOADINGS

☐ **QLD (Head Office)**
686 Curtin Avenue East
P.O. Box 1398
Eagle Farm QLD 4009
PH: (+81) 7 3888 9800
Fax: (+81) 7 32882489

☐ **N.S.W.**
114 Haccall Street
Wetherill Park, NSW 2184
PH: (+81) 2 8788 4444
Fax: (+81) 2 8788 4455

☐ **W.A.**
83 Poole Street
Welchpool, WA 6108
PH: (+81) 8 9368 9808
Fax: (+81) 8 9368 9861

Simple, available and cost effective™

FRANNA • LORAIN • P&H • RO STINGER • PPM • BENDINI • AMERICAN • PEINER • COMEDIL • **DEMAG**



Appendix B – Manufacturer Software Calculation Examples Outrigger Pad Load

Example 1: GMK 5130 – No load on hook

Example 1 GMK 5130 all-terrain crane, lifting with main boom only, with 40.1t counterweight on board, and no load on the hook. Boom length is 12.9m and lifting radius is 3m. Calculation results from Manufacturer software are shown below for outrigger loads from different crane configurations and load cases.

Outrigger Pad Loads - All Terrain - Results

[Enter Email](#) > [Select Model](#) > [Configure Boom](#) > [Lift Details](#) > Results

Model: Grove GMK5130-2 w/ Main Boom Only - Metric

Boom Length: 12.9 m [0-0-0-0]

Counterweight: 40.1t Cwt

Support Base: 7.8m x 7.5m

Load Radius: 3 m

Load Weight: 325 kg

Slew Angle:

0° =
Directly
Over Rear

Max
Chart 93998
Load kg
=

Front
Right: 29901 kg

Front
Left: 29901 kg

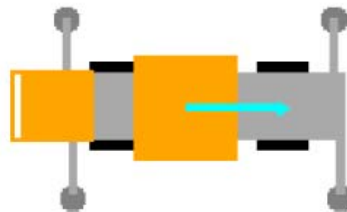

Rear 13161
Right: kg

Rear 13161
Left: kg

Slew Angle:

45° = Over
Rear Left
Outrigger

Max
Chart 93998
Load kg
=

Front
Right: 32882 kg

Front
Left: 21156 kg

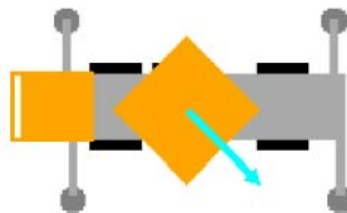

Rear 24788
Right: kg

Rear 7298
Left: kg

Slew Angle:

90° =
Directly
Over Left
Side

Max
Chart 93998
Load kg
=

Front
Right: 28311 kg

Front
Left: 11716 kg

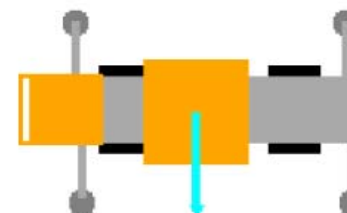

Rear 35420
Right: kg

Rear 10776
Left: kg

Slew Angle:

135° =
Over Front
Left
Outrigger

Max
Chart 93998
Load kg
=

Front
Right: 18871 kg

Front
Left: 7144 kg

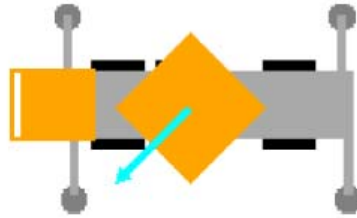

Rear 38799
Right: kg

Rear 21409
Left: kg

Slew Angle:

180° =
Directly
Over Front
Max 93998
Chart kg
Load
=

Front
Right: 10126 kg

Front
Left: 10126 kg

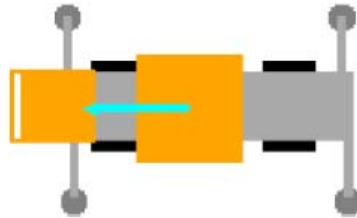

Rear 33036
Right: kg

Rear 33036
Left: kg

Slew Angle:

225° =
Over Front
Right
Outrigger

Max
Chart 93998
Load kg
=

Front
Right: 7144 kg

Front
Left: 18871 kg

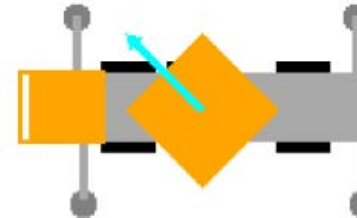

Rear 21409
Right: kg

Rear 38799
Left: kg

Slew Angle:

270° =
Directly
Over Right
Side

Max
Chart 93998
Load kg
=

Front
Right: 11716 kg

Front
Left: 28311 kg

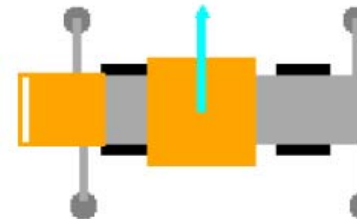

Rear 10776
Right: kg

Rear 35420
Left: kg

Slew Angle:
 315° =
 Over Rear
 Right
 Outrigger
 Max
 Chart 93998
 Load kg
 =

Front
 Right: 21156 kg

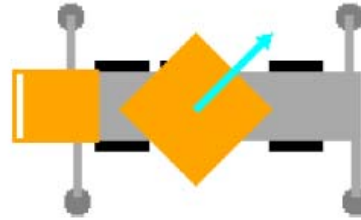

Rear 7298
 Right: kg

Front
 Left: 32882 kg

Rear 24788
 Left: kg

* Slew Angle:
 Maximum
 Outrigger
 Pad Loads
 Max
 Chart 93998
 Load kg
 =

Front
 Right: 32882 kg

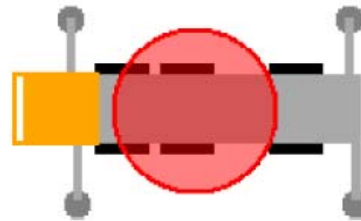

Rear 38799
 Right: kg

Front
 Left: 32882 kg

Rear 38799
 Left: kg

*This shows the highest load the outriggers experienced when the crane boom slews from 0° to 360° slew angle.

Example 2: GMK 5130 – Load on hook

Example 2 GMK 5130 all-terrain crane, lifting with main boom only, with 40.1t counterweight on board, and 35000kg load on the hook. Boom length is 17.6m and lifting radius is 10m. Calculation results from Manufacturer software are shown below for outrigger loads from different crane configurations and load cases.

Outrigger Pad Loads - All Terrain - Results

[Enter Email](#) > [Select Model](#) > [Configure Boom](#) > [Lift Details](#) > Results

Model: Grove GMK5130-2 w/ Main Boom Only - Metric

Boom Length: 17.6 m [0-0-50-0-0]

Counterweight: 40.1t Cwt

Support Base: 7.8m x 7.5m

Load Radius: 10 m

Load Weight: 35000 kg

Slew Angle:

0° =
Directly
Over Rear

Max
Chart 37999
Load kg
=

Front
Right: 11134 kg

Front
Left: 11134 kg

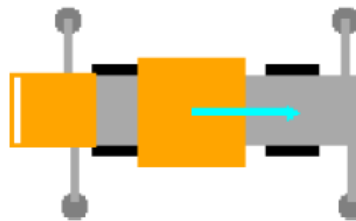

Rear 49958
Right: kg

Rear 49958
Left: kg

Slew Angle:

45° = Over
Rear Left
Outrigger

Max
Chart 37999
Load kg
=

Front
Right: 6410 kg

Front
Left: 25236 kg

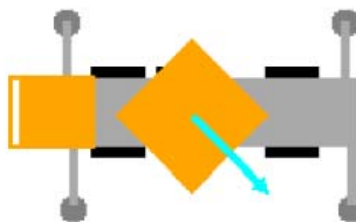

Rear 31223
Right: kg

Rear 59237
Left: kg

Slew Angle:

90° =
Directly
Over Left
Side

Max
Chart 37999
Load kg
=

Front
Right: 13726 kg

Front
Left: 40313 kg

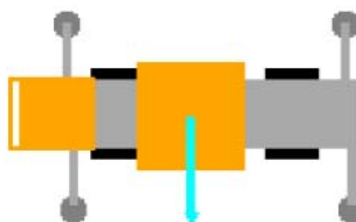

Rear 14184
Right: kg

Rear 53792
Left: kg

Slew Angle:
135° =
Over Front
Left
Outrigger
Max
Chart 37999
Load kg
=

Front
Right: 28887 kg

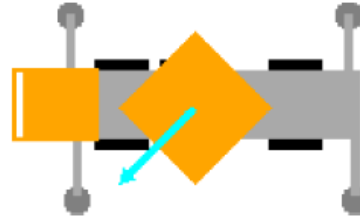

Rear 8739
Right: kg

Front
Left: 47713 kg

Rear 36752
Left: kg

Slew Angle:
180° =
Directly
Over Front
Max 37999
Chart kg
Load
=

Front
Right: 42989 kg

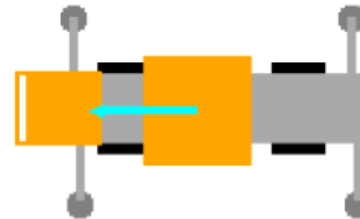

Rear 18110
Right: kg

Front
Left: 42989 kg

Rear 18110
Left: kg

Slew Angle:
225° =
Over Front
Right
Outrigger
Max
Chart 37999
Load kg
=

Front
Right: 47713 kg

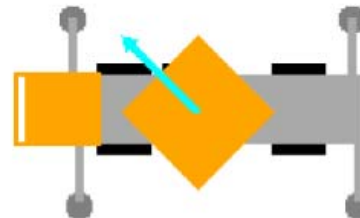

Rear 36752
Right: kg

Front
Left: 28887 kg

Rear 8739
Left: kg

Slew Angle:
270° =
Directly
Over Right
Side
Max
Chart 37999
Load kg
=

Front
Right: 40313 kg

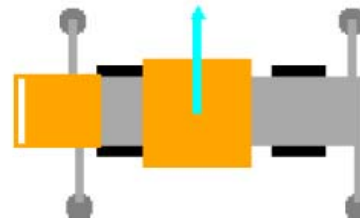

Rear 53792
Right: kg

Front
Left: 13726 kg

Rear 14184
Left: kg

Slew Angle:
 315° =
 Over Rear
 Right
 Outrigger
 Max
 Chart 37999
 Load kg
 =

Front
 Right: 25236 kg

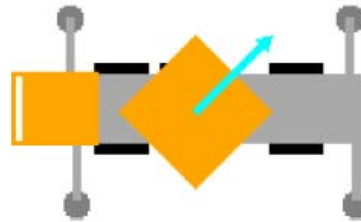

Rear 59237
 Right: kg

Front
 Left: 6410 kg

Rear 31223
 Left: kg

* Slew Angle:
 Maximum
 Outrigger
 Pad Loads
 Max
 Chart 37999
 Load kg
 =

Front
 Right: 47713 kg

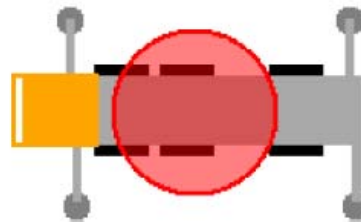

Rear 59237
 Right: kg

Front
 Left: 47713 kg

Rear 59237
 Left: kg

*This shows the highest load the outriggers experienced when the crane boom slews the load from 0° to 360° slew angle.