



# Cisco Model DPC/EPC2325 DOCSIS Residential Gateway with Wireless Access Point User Guide









## In This Document

■ IMPORTANT SAFETY INSTRUCTIONS .....	2
■ Introduction.....	9
■ What's In the Carton?.....	11
■ Front Panel Description .....	12
■ Back Panel Description .....	13
■ Where Is the Best Location for My DOCSIS Residential Gateway? .....	14
■ How Do I Mount the Modem on a Wall? (Optional).....	15
■ What Are the System Requirements for Internet Service?.....	18
■ How Do I Subscribe to High-Speed Internet Service?.....	19
■ How Do I Connect My Devices to Use the Internet?.....	20
■ How Do I Configure My DOCSIS Residential Gateway? .....	22
■ How Do I Troubleshoot My Internet Service Installation? .....	96
■ Frequently Asked Questions.....	97
■ Having Difficulty? .....	104
■ Tips for Improved Performance .....	105
■ Front Panel LED Status Indicator Functions.....	106
■ For Information .....	109
■ Notices.....	110
■ Third Party Software License Notices For Cisco Model DPC/EPC2325 DOCSIS Residential Gateway with Wireless Access .....	112

# IMPORTANT SAFETY INSTRUCTIONS

## Notice to Installers

The servicing instructions in this notice are for use by qualified service personnel only. To reduce the risk of electric shock, do not perform any servicing other than that contained in the operating instructions, unless you are qualified to do so.

<p><b>Note to System Installer</b></p> <p>For this apparatus, the coaxial cable shield/ screen shall be grounded as close as practical to the point of entry of the cable into the building. For products sold in the US and Canada, this reminder is provided to call the system installer's attention to Article 820-93 and Article 820-100 of the NEC (or Canadian Electrical Code Part 1), which provides guidelines for proper grounding of the coaxial cable shield.</p>  <p>This symbol is intended to alert you that uninsulated voltage within this product may have sufficient magnitude to cause electric shock. Therefore, it is dangerous to make any kind of contact with any inside part of this product.</p>	<table border="1"><tr><td></td><td><b>CAUTION</b> RISK OF ELECTRIC SHOCK DO NOT OPEN</td><td></td></tr><tr><td></td><td><b>AVIS</b> RISQUE DE CHOC ÉLECTRIQUE NE PAS OUVRIR</td><td></td></tr></table> <p>CAUTION: To reduce the risk of electric shock, do not remove cover (or back). No user-serviceable parts inside. Refer servicing to qualified service personnel.</p> <p><b>WARNING</b> TO PREVENT FIRE OR ELECTRIC SHOCK, DO NOT EXPOSE THIS UNIT TO RAIN OR MOISTURE.</p>  <p>This symbol is intended to alert you of the presence of important operating and maintenance (servicing) instructions in the literature accompanying this product.</p>		<b>CAUTION</b> RISK OF ELECTRIC SHOCK DO NOT OPEN			<b>AVIS</b> RISQUE DE CHOC ÉLECTRIQUE NE PAS OUVRIR	
	<b>CAUTION</b> RISK OF ELECTRIC SHOCK DO NOT OPEN						
	<b>AVIS</b> RISQUE DE CHOC ÉLECTRIQUE NE PAS OUVRIR						



## Notice à l'attention des installateurs de réseaux câblés

Les instructions relatives aux interventions d'entretien, fournies dans la présente notice, s'adressent exclusivement au personnel technique qualifié. Pour réduire les risques de chocs électriques, n'effectuer aucune intervention autre que celles décrites dans le mode d'emploi et les instructions relatives au fonctionnement, à moins que vous ne soyez qualifié pour ce faire.

<p><b>Remarque à l'attention de l'installateur du système</b></p> <p>Avec cet appareil, le blindage/écran du câble coaxial doit être mis à la terre aussi près que possible du point d'entrée du câble dans le bâtiment. En ce qui concerne les produits vendus aux États-Unis et au Canada, ce rappel est fourni pour attirer l'attention de l'installateur sur les articles 820-93 et 820-100 du Code national de l'électricité (ou Code de l'électricité canadien, Partie 1) qui fournissent des lignes directrices concernant la mise à la terre correcte du blindage (écran) du câble coaxial.</p>  <p>Ce symbole a pour but de vous prévenir que des tensions électriques non isolées existent à l'intérieur de ce produit, pouvant être d'une intensité suffisante pour causer des chocs électriques. Il est donc dangereux d'établir un contact quelconque avec l'une des pièces comprises à l'intérieur de ce produit.</p>	<table border="1"><tr><td></td><td><b>CAUTION</b> RISK OF ELECTRIC SHOCK DO NOT OPEN</td><td></td></tr><tr><td></td><td><b>ATTENTION</b> DANGER ÉLECTRIQUE NE PAS OUVRIR</td><td></td></tr></table> <p>ATTENTION : Pour réduire les risques de chocs électriques, ne pas enlever le couvercle (ou le panneau arrière). Ne contient aucune pièce réparable par l'utilisateur. Confier les interventions aux techniciens d'entretien qualifiés.</p> <p><b>AVERTISSEMENT</b> POUR ÉVITER LES INCENDIES OU LES CHOC ÉLECTRIQUES, NE PAS EXPOSER L'APPAREIL À LA PLUIE OU À L'HUMIDITÉ.</p>  <p>Ce symbole a pour but de vous prévenir de la présence d'instructions importantes relatives au fonctionnement ou à l'entretien (et aux réparations) dans la documentation accompagnant ce produit.</p>		<b>CAUTION</b> RISK OF ELECTRIC SHOCK DO NOT OPEN			<b>ATTENTION</b> DANGER ÉLECTRIQUE NE PAS OUVRIR	
	<b>CAUTION</b> RISK OF ELECTRIC SHOCK DO NOT OPEN						
	<b>ATTENTION</b> DANGER ÉLECTRIQUE NE PAS OUVRIR						

## Mitteilung für CATV-Techniker

Die in dieser Mitteilung aufgeführten Wartungsanweisungen sind ausschließlich für qualifiziertes Fachpersonal bestimmt. Um die Gefahr eines elektrischen Schlags zu reduzieren, sollten Sie keine Wartungsarbeiten durchführen, die nicht ausdrücklich in der Bedienungsanleitung aufgeführt sind, außer Sie sind zur Durchführung solcher Arbeiten qualifiziert.

<p><b>Mitteilung an den Systemtechniker</b></p> <p>Für dieses Gerät muss der Koaxialkabelschutz/ Schirm so nahe wie möglich am Eintrittspunkt des Kabels in das Gebäude geerdet werden. Dieser Erinnerungshinweis liegt den in den USA oder Kanada verkauften Produkten bei. Er soll den Systemtechniker auf Paragraph 820-93 und Paragraph 820-100 der US-Elektrovorschrift NEC (oder der kanadischen Elektrovorschrift Canadian Electrical Code Teil 1) aufmerksam machen, in denen die Richtlinien für die ordnungsgemäße Erdung des Koaxialkabelschirms festgehalten sind.</p>  <p>Dieses Symbol weist den Benutzer auf das Vorhandensein von nicht isolierten gefährlichen Spannungen im Gerät hin, die Stromschläge verursachen können. Ein Kontakt mit den internen Teilen dieses Produktes ist mit Gefahren verbunden.</p>	<table border="1"> <tr> <td data-bbox="760 415 829 485"></td> <td data-bbox="829 390 997 527"> <p><b>CAUTION</b> RISK OF ELECTRIC SHOCK DO NOT OPEN</p> <p><b>ACHTUNG</b> STROMSCHLAGEGFAHR, NICHT ÖFFNEN</p> </td> <td data-bbox="997 415 1083 485"></td> </tr> </table> <p>ACHTUNG: Zur Vermeidung eines Stromschlags darf die Abdeckung (bzw. die Geräterückwand) nicht entfernt werden. Das Gerät enthält keine vom Benutzer wartbaren Teile. Wartungsarbeiten dürfen nur von qualifiziertem Fachpersonal durchgeführt werden.</p> <p><b>WARNUNG</b> DAS GERÄT NICHT REGEN ODER FEUCHTIGKEIT AUSSETZEN, UM STROMSCHLAG ODER DURCH EINEN KURZSCHLUSS VERURSACHTEN BRAND ZU VERMEIDEN.</p>  <p>Dieses Symbol weist den Benutzer darauf hin, dass die mit diesem Produkt gelieferte Dokumentation wichtige Betriebs- und Wartungsanweisungen für das Gerät enthält.</p>		<p><b>CAUTION</b> RISK OF ELECTRIC SHOCK DO NOT OPEN</p> <p><b>ACHTUNG</b> STROMSCHLAGEGFAHR, NICHT ÖFFNEN</p>	
	<p><b>CAUTION</b> RISK OF ELECTRIC SHOCK DO NOT OPEN</p> <p><b>ACHTUNG</b> STROMSCHLAGEGFAHR, NICHT ÖFFNEN</p>			

## Aviso a los instaladores de sistemas CATV

Las instrucciones de reparación contenidas en el presente aviso son para uso exclusivo por parte de personal de mantenimiento cualificado. Con el fin de reducir el riesgo de descarga eléctrica, no realice ninguna otra operación de reparación distinta a las contenidas en las instrucciones de funcionamiento, a menos que posea la cualificación necesaria para hacerlo.

<p><b>Nota para el instalador del sistema</b></p> <p>En lo que se refiere a este aparato, el blindaje del cable coaxial debe conectarse a tierra lo más cerca posible al punto por el cual el cable entra en el edificio. En el caso de los productos vendidos en los EE. UU. y Canadá, el presente aviso se suministra para llamar la atención del instalador del sistema sobre los Artículos 820-93 y 820-100 del NEC (o Código Eléctrico de Canadá, Parte 1), que proporcionan directrices para una correcta conexión a tierra del blindaje del cable coaxial.</p>  <p>Este símbolo tiene como fin advertirle de que una tensión sin aislamiento en el interior de este producto podría ser de una magnitud suficiente como para provocar una descarga eléctrica. Por consiguiente, resulta peligroso realizar cualquier tipo de contacto con alguno de los componentes internos de este producto.</p>	<table border="1"> <tr> <td data-bbox="760 1157 829 1226"></td> <td data-bbox="829 1131 997 1268"> <p><b>CAUTION</b> RISK OF ELECTRIC SHOCK DO NOT OPEN</p> <p><b>ATENCIÓN</b> RIESGO DE DESCARGA ELÉCTRICA NO ABRIR</p> </td> <td data-bbox="997 1157 1083 1226"></td> </tr> </table> <p>ATENCIÓN: con el fin de reducir el riesgo de descarga eléctrica, no retire la tapa (ni la parte posterior). No existen en el interior componentes que puedan ser reparados por el usuario. Encargue su revisión a personal de mantenimiento cualificado.</p> <p><b>ADVERTENCIA</b> PARA EVITAR EL RIESGO DE INCENDIO O DESCARGA ELÉCTRICA, NO EXPONGA LA UNIDAD A LA LLUVIA O A LA HUMEDAD.</p>  <p>Este símbolo tiene como fin alertarle de la presencia de importantes instrucciones de operación y mantenimiento (revisión) contenidas en la literatura que acompaña al producto.</p>		<p><b>CAUTION</b> RISK OF ELECTRIC SHOCK DO NOT OPEN</p> <p><b>ATENCIÓN</b> RIESGO DE DESCARGA ELÉCTRICA NO ABRIR</p>	
	<p><b>CAUTION</b> RISK OF ELECTRIC SHOCK DO NOT OPEN</p> <p><b>ATENCIÓN</b> RIESGO DE DESCARGA ELÉCTRICA NO ABRIR</p>			

20080814\_Installer820\_Intl

## IMPORTANT SAFETY INSTRUCTIONS

# IMPORTANT SAFETY INSTRUCTIONS

- 1) Read these instructions.
- 2) Keep these instructions.
- 3) Heed all warnings.
- 4) Follow all instructions.
- 5) Do not use this apparatus near water.
- 6) Clean only with dry cloth.
- 7) Do not block any ventilation openings. Install in accordance with the manufacturer's instructions.
- 8) Do not install near any heat sources such as radiators, heat registers, stoves, or other apparatus (including amplifiers) that produce heat.
- 9) Do not defeat the safety purpose of the polarized or grounding-type plug. A polarized plug has two blades with one wider than the other. A grounding-type plug has two blades and a third grounding prong. The wide blade or the third prong are provided for your safety. If the provided plug does not fit into your outlet, consult an electrician for replacement of the obsolete outlet.
- 10) Protect the power cord from being walked on or pinched particularly at plugs, convenience receptacles, and the point where they exit from the apparatus.
- 11) Only use attachments/accessories specified by the manufacturer.
-  12) Use only with the cart, stand, tripod, bracket, or table specified by the manufacturer, or sold with the apparatus. When a cart is used, use caution when moving the cart/apparatus combination to avoid injury from tip-over.
- 13) Unplug this apparatus during lightning storms or when unused for long periods of time.
- 14) Refer all servicing to qualified service personnel. Servicing is required when the apparatus has been damaged in any way, such as a power-supply cord or plug is damaged, liquid has been spilled or objects have fallen into the apparatus, the apparatus has been exposed to rain or moisture, does not operate normally, or has been dropped.

## Power Source Warning

A label on this product indicates the correct power source for this product. Operate this product only from an electrical outlet with the voltage and frequency indicated on the product label. If you are uncertain of the type of power supply to your home or business, consult your service provider or your local power company.

The AC inlet on the unit must remain accessible and operable at all times.

## Ground the Product



**WARNING:** Avoid electric shock and fire hazard! If this product connects to coaxial cable wiring, be sure the cable system is grounded (earthed). Grounding provides some protection against voltage surges and built-up static charges.

## Protect the Product from Lightning

In addition to disconnecting the AC power from the wall outlet, disconnect the signal inputs.

## Verify the Power Source from the On/Off Power Light

When the on/off power light is not illuminated, the apparatus may still be connected to the power source. The light may go out when the apparatus is turned off, regardless of whether it is still plugged into an AC power source.

## Eliminate AC Mains Overloads



**WARNING:** Avoid electric shock and fire hazard! Do not overload AC mains, outlets, extension cords, or integral convenience receptacles. For products that require battery power or other power sources to operate them, refer to the operating instructions for those products.

## Provide Ventilation and Select a Location

- Remove all packaging material before applying power to the product.
- Do not place this apparatus on a bed, sofa, rug, or similar surface.
- Do not place this apparatus on an unstable surface.
- Do not install this apparatus in an enclosure, such as a bookcase or rack, unless the installation provides proper ventilation.
- Do not place entertainment devices (such as VCRs or DVDs), lamps, books, vases with liquids, or other objects on top of this product.
- Do not block ventilation openings.

## Protect from Exposure to Moisture and Foreign Objects



**WARNING:** Avoid electric shock and fire hazard! Do not expose this product to liquids, rain, or moisture. Do not expose this product to dripping or splashing liquids, rain, or moisture. Objects filled with liquids, such as vases, should not be placed on this apparatus.



**WARNING:** Avoid electric shock and fire hazard! Unplug this product before cleaning. Do not use a liquid cleaner or an aerosol cleaner. Do not use a magnetic/static cleaning device (dust remover) to clean this product.



**WARNING:** Avoid electric shock and fire hazard! Never push objects through the openings in this product. Foreign objects can cause electrical shorts that can result in electric shock or fire.

## IMPORTANT SAFETY INSTRUCTIONS

### Service Warnings



**WARNING:** Avoid electric shock! Do not open the cover of this product. Opening or removing the cover may expose you to dangerous voltages. If you open the cover, your warranty will be void. This product contains no user-serviceable parts.

### Check Product Safety

Upon completion of any service or repairs to this product, the service technician must perform safety checks to determine that this product is in proper operating condition.

### Protect the Product When Moving It

Always disconnect the power source when moving the apparatus or connecting or disconnecting cables.

20081112\_Modem DSL\_Safety

## FCC Compliance

### United States FCC Compliance

This device has been tested and found to comply with the limits for a Class B digital device, pursuant to part 15 of the FCC Rules. These limits are designed to provide reasonable protection against such interference in a residential installation. This equipment generates, uses, and can radiate radio frequency energy. If not installed and used in accordance with the instructions, it may cause harmful interference to radio communications. However, there is no guarantee that interference will not occur in a particular installation. If this equipment does cause harmful interference to radio or television reception, which can be determined by turning the equipment OFF and ON, the user is encouraged to try to correct the interference by one or more of the following measures:

- Reorient or relocate the receiving antenna.
- Increase the separation between the equipment and receiver.
- Connect the equipment into an outlet on a circuit different from that to which the receiver is connected.
- Consult the service provider or an experienced radio/television technician for help.

Any changes or modifications not expressly approved by Cisco Systems, Inc., could void the user's authority to operate the equipment.

The information shown in the FCC Declaration of Conformity paragraph below is a requirement of the FCC and is intended to supply you with information regarding the FCC approval of this device. *The phone numbers listed are for FCC-related questions only and not intended for questions regarding the connection or operation for this device. Please contact your service provider for any questions you may have regarding the operation or installation of this device.*

### FCC Declaration of Conformity

This device complies with Part 15 of FCC Rules. Operation is subject to the following two conditions: 1) the device may not cause harmful interference, and 2) the device must accept any interference received, including interference that may cause undesired operation.

<p>DOCSIS Residential Gateway          Model: DPC/EPC2325          Manufactured by:          Cisco Systems, Inc.          5030 Sugarloaf Parkway          Lawrenceville, Georgia 30044 USA          Telephone: 678-277-1120</p>
---

### Canada EMI Regulation

This Class B digital apparatus complies with Canadian ICES-003.

Cet appareil numérique de la class B est conforme à la norme NMB-003 du Canada.



## Radiation Exposure Statements

**Note:** This transmitter must not be co-located or operated in conjunction with any other antenna or transmitter. This equipment should be installed and operated with a minimum distance of 7.9 inches (20 cm) between the radiator and your body.

### US

This system has been evaluated for RF exposure for humans in reference to ANSI C 95.1 (American National Standards Institute) limits. The evaluation was based on evaluation per ANI C 95.1 and FCC OET Bulletin 65C rev 01.01. The minimum separation distance from the antenna to general bystander is 7.9 inches (20 cm) to maintain compliance.

### Canada

This system has been evaluated for RF exposure for humans in reference to ANSI C 95.1 limits. The evaluation was based on evaluation per RSS-102 Rev 2. The minimum separation distance from the antenna to general bystander is 7.9 inches (20 cm) to maintain compliance.

### EU

This system has been evaluated for RF exposure for humans in reference to the ICNIRP (International Commission on Non-Ionizing Radiation Protection) limits. The evaluation was based on the EN 50385 Product Standard to Demonstrate Compliance of Radio Base Stations and Fixed Terminals for Wireless Telecommunications Systems with basic restrictions or reference levels related to Human Exposure to Radio Frequency Electromagnetic Fields from 300 MHz to 40 GHz. The minimum separation distance from the antenna to general bystander is 20 cm (7.9 inches).

### Australia

This system has been evaluated for RF exposure for humans as referenced in the Australian Radiation Protection standard and has been evaluated to the ICNIRP (International Commission on Non-Ionizing Radiation Protection) limits. The minimum separation distance from the antenna to general bystander is 20 cm (7.9 inches).

20081016 FCC DSL\_Dom and Intl



# Introduction

## Introduction

Welcome to the exciting world of high-speed Internet! Your new Cisco® Model DPC/EPC2325 DOCSIS® Residential Gateway is a cable modem that meets industry standards for high-speed data connectivity. The DPC/EPC2325 residential gateway delivers data via wired (Ethernet) or wireless gateway capabilities to connect a variety of devices in the home or small office and support high-speed data access all in one device. With a DPC/EPC2325 residential gateway, your Internet enjoyment, home and business communications, and personal productivity will surely soar.

This guide provides procedures and recommendations for placing, installing, configuring, operating, and troubleshooting your DPC/EPC2325 residential gateway for high-speed Internet service for your home or office. Refer to the appropriate section in this guide for the specific information you need for your situation. Contact your service provider for more information about subscribing to Internet services.

## Benefits and Features

Your new DPC/EPC2325 residential gateway offers the following outstanding benefits and features:

- Compliant with DOCSIS/EuroDOCSIS™ 2.0, 1.1, and 1.0 standards along with PacketCable™/EuroPacketCable™ specifications to deliver high-end performance and reliability
- High performance broadband Internet connectivity to energize your online experience
- Four 10/100BASE-T Ethernet ports to provide wired connectivity
- 802.11g Wireless Access Point with 4 service set identifiers (SSIDs)
- Wi-Fi Protected Setup (WPS), including a push button switch to activate WPS for simplified and secure wireless setup
- User configurable Parental Control blocks access to undesirable Internet sites
- Advanced firewall technology deters hackers and protects the home network from unauthorized access
- Attractive compact design that allows for vertical, horizontal, or wall-mounted operation
- TR-068 compliant color-coded interface ports and corresponding cables simplify installation and setup

## Introduction

- DOCSIS-5 compliant LED labeling and behavior provides a user and technician friendly method to check operational status and act as a troubleshooting tool
- Allows automatic software upgrades by your service provider

## What's In the Carton?

When you receive your wireless home gateway, you should check the equipment and accessories to verify that each item is in the carton and that each item is undamaged. The carton contains the following items:



One of the DPC/EPC2325 DOCSIS Residential Gateway versions



One power adapter (models requiring external power supply)



One Ethernet cable (CAT5/RJ-45)



One CD-ROM containing the user guide

If any of these items are missing or damaged, please contact your service provider for assistance.

**Note:** You will need an optional cable signal splitter and additional standard RF coaxial cables if you want to connect a VCR, a Digital Home Communications Terminal (DHCT) or a set-top converter, or a TV to the same cable connection as your wireless home gateway.

## Front Panel Description

The front panel of your residential gateway provides LED status indicators that indicate how well and at what state your residential gateway is operating. See *Front Panel LED Status Indicator Functions* (on page 106), for more information on front panel LED status indicator functions.

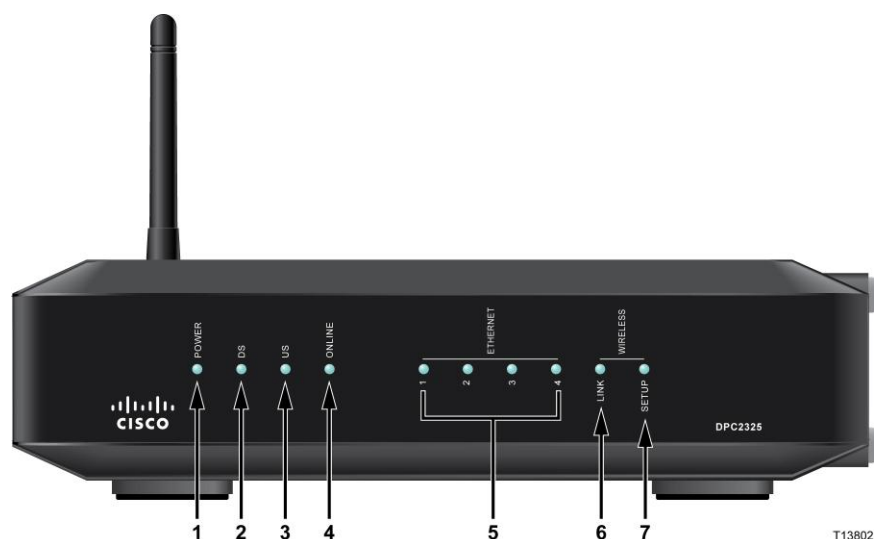

### Model DPC2325

- 1 **POWER**—ON, power is applied to the wireless residential gateway
- 2 **DS**—ON, the wireless residential gateway is receiving data from the cable network
- 3 **US**—ON, the wireless residential gateway is sending data to the cable network
- 4 **ONLINE**—ON, the wireless residential gateway is registered on the network and fully operational
- 5 **ETHERNET 1 - 4**—ON, a device is connected to one of the Ethernet ports. BLINKING indicates that data is being transferred over the Ethernet connection
- 6 **WIRELESS LINK**—ON, the Wireless Access Point is operational. BLINKING indicates that data is being transferred over the wireless connection. OFF indicates that the wireless access point has been disabled by the user
- 7 **WIRELESS SETUP**—OFF (normal condition) wireless setup is not active. BLINKING indicates the user has activated wireless setup to add new wireless clients on the wireless network

## Back Panel Description

The following illustrations show the description and function of the back panel components on the DPC/EPC2325.

### External Power Supply Model

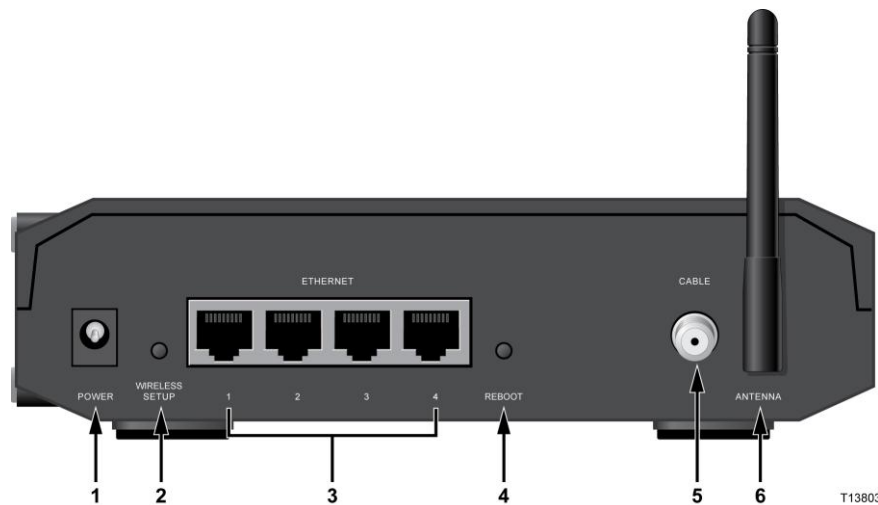

Model DPC/EPC2325

- 1 **POWER** – Connects the residential gateway to the power adapter that is provided with your residential gateway



**CAUTION:**

**Avoid damage to your equipment. Only use the power supply that is provided with your residential gateway.**

- 2 **WIRELESS SETUP** – Pressing this switch initiates wireless setup, this feature allows the user to add new Wi-Fi Protected Setup (WPS) compliant wireless clients to the home network
- 3 **ETHERNET** – Four RJ-45 Ethernet ports connect to the Ethernet port on your PC or your home network
- 4 **REBOOT** – A momentary pressing (1-2 seconds) of this switch reboots the residential gateway. Pressing the switch for more than ten seconds causes a reset-to-factory-default of all settings and then reboots the gateway



**CAUTION:**

**The Reboot button is for maintenance purposes only. Do not use unless instructed to do so by your service provider. Doing so may cause you to lose any cable modem settings you have selected.**

- 5 **CABLE** – F-connector connects to an active cable signal from your service provider
- 6 **ANTENNA** – Connection for external 802.11 antenna

## Where Is the Best Location for My DOCSIS Residential Gateway?

The ideal location for your residential gateway is where it has access to outlets and other devices. Think about the layout of your home or office, and consult with your service provider to select the best location for your residential gateway. Read this user guide thoroughly before you decide where to place your residential gateway.

Consider these recommendations:

- Position your PC and residential gateway so that they are located near an AC power outlet.
- Position your PC and residential gateway so that they are located near an existing cable input connection to eliminate the need for an additional cable outlet. There should be plenty of room to guide the cables away from the modem and the PC without straining or crimping them.
- Airflow around the residential gateway should not be restricted.
- Choose a location that protects the residential gateway from accidental disturbance or harm.

## How Do I Mount the Modem on a Wall? (Optional)

You can mount the residential gateway on a wall using two wall anchors, two screws, and the mounting slots located on the unit. The modem can be mounted vertically or horizontally.

### Before You Begin

Before you begin, choose an appropriate mounting place. The wall can be made of cement, wood, or drywall. The mounting location should be free of obstructions on all sides, and the cables should be able to easily reach the residential gateway without strain. Leave sufficient clearance between the bottom of the residential gateway and any flooring or shelving underneath to allow access to cabling. In addition, leave enough slack in all cables so that the residential gateway can be removed for any required maintenance without disconnecting the cables. Also, verify that you have the following items:

- Two wall anchors for #8 x 1-inch screws
- Two #8 x 1-inch pan head sheet metal screws
- Drill with a 3/16-in. wood or masonry bit, as appropriate for the wall composition
- A copy of the wall-mounting illustrations shown on the following pages



**How Do I Mount the Modem on a Wall? (Optional)**

Mount the modem as shown in one of the following illustrations.

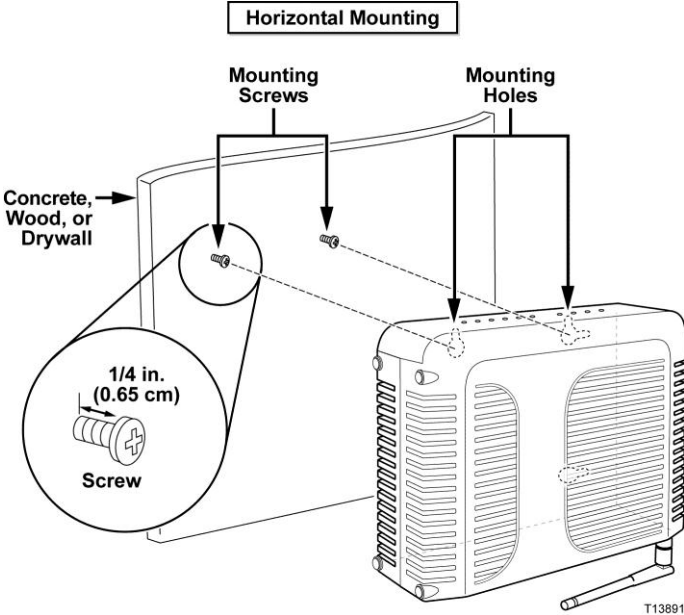
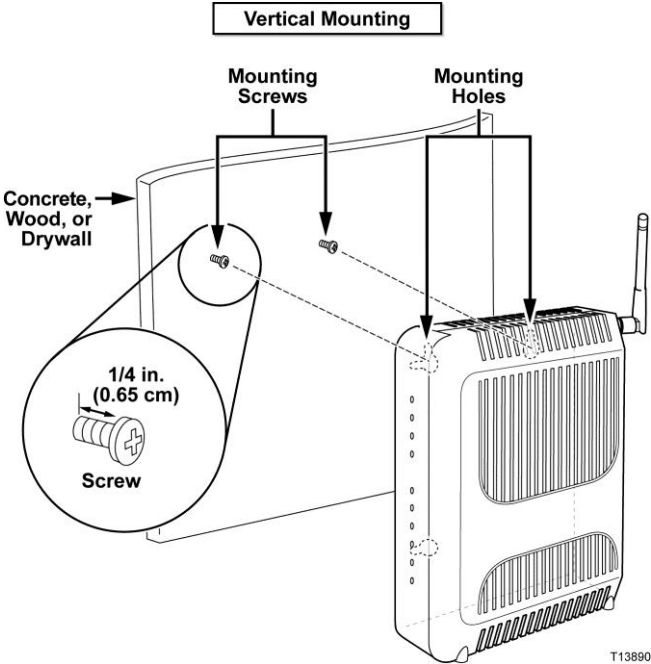

## Location and Dimensions of the Wall-Mounting Slots

The following illustration shows the location and dimensions of the wall-mounting slots on the bottom of the modem. Use the information on this page as a guide for mounting your modem to the wall.

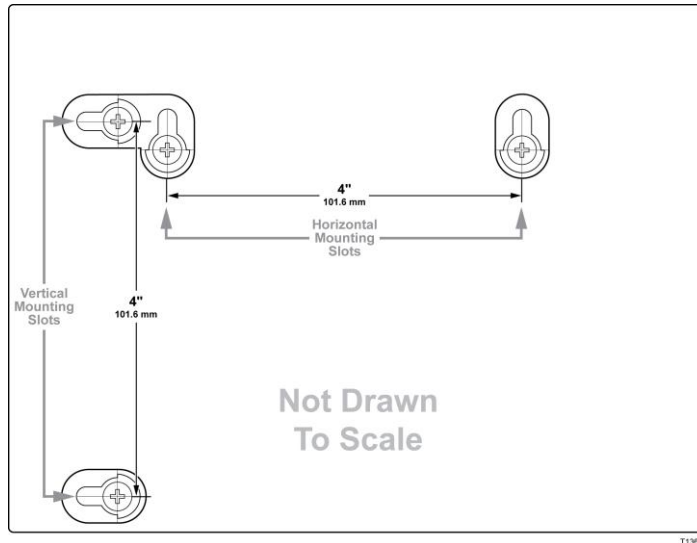

## Mounting the Residential Gateway on a Wall

- 1 Using a drill with a 3/16-inch bit, drill two holes at the same height and 4 inches apart.

**Note:** The preceding graphic illustrates the location of the mounting holes on the back of the residential gateway.

- 2 Are you mounting the residential gateway into a drywall or concrete surface where a wooden stud is available?
  - If **yes**, go to step 3.
  - If **no**, drive the anchor bolts into the wall, and install the mounting screws into the anchor bolts; leave a gap of about 1/4-inch between the screw head and the wall. Then, go to step 4.
- 3 Install the mounting screws into the wall; leave a gap of about 1/4-inch between the screw head and the wall. Then, go to step 4.
- 4 Verify that no cables or wires are connected to the residential gateway.
- 5 Lift the residential gateway into position. Slip the large end of both mounting slots (located in the back of the residential gateway) over the mounting screws, and then slide the residential gateway down until the narrow end of the keyhole slot contacts the screw shaft.

**Important:** Verify that the mounting screws securely support the residential gateway before you release the unit.

## What Are the System Requirements for Internet Service?

To ensure that your residential gateway operates efficiently for high-speed Internet service, verify that all of the Internet devices on your system meet or exceed the following minimum hardware and software requirements.

**Note:** You will also need an active cable input line and an Internet connection.

### Minimum System Requirements for a PC

- A PC with a Pentium MMX 133 processor or greater
- 32 MB of RAM
- Web browsing software
- CD-ROM drive

### Minimum System Requirements for Macintosh

- MAC OS 7.5 or later
- 32 MB of RAM

### System Requirements for an Ethernet Connection

- A PC with Microsoft Windows 2000 operating system (or later) with TCP/IP protocol installed, or an Apple Macintosh computer with TCP/IP protocol installed
- An active 10/100BASE-T Ethernet network interface card (NIC) installed

## How Do I Subscribe to High-Speed Internet Service?

Before you can use your residential gateway, you need to have a high-speed Internet access account. If you do not have a high-speed Internet access account, you need to set up an account with your local service provider. Choose one of the two options in this section.

### I Do Not Have a High-Speed Internet Access Account

If you do *not* have a high-speed Internet access account, your service provider will set up your account and become your Internet Service Provider (ISP). Internet access enables you to send and receive e-mail, access the World Wide Web, and receive other Internet services.

You will need to give your service provider the following information:

- The serial number of the modem
- The Media Access Control (MAC) address of the modem

These numbers appear on a bar code label located on the residential gateway. The serial number consists of a series of alphanumeric characters preceded by **S/N**. The MAC address consists of a series of alphanumeric characters preceded by **CM MAC**. The following illustration shows a sample bar code label.



Write down these numbers in the space provided here.

Serial Number \_\_\_\_\_

MAC Address \_\_\_\_\_

### I Already Have an Existing High-Speed Internet Access Account

If you have an existing high-speed Internet access account, you must give your service provider the serial number and the MAC address of the residential gateway. Refer to the serial number and MAC address information listed previously in this section.

**Note:** You may not be able to continue to use your existing e-mail account with your residential gateway. Contact your service provider for more information.

## How Do I Connect My Devices to Use the Internet?

You can use your residential gateway to access the Internet, and you can share that Internet connection with other Internet devices in your home or office. Sharing one connection among many devices is called networking.

### Connecting and Installing Internet Devices

You must connect and install your residential gateway to access the Internet. Professional installation may be available. Contact your local service provider for further assistance.

#### To connect devices

The following diagram illustrates one of the various networking options that are available to you.

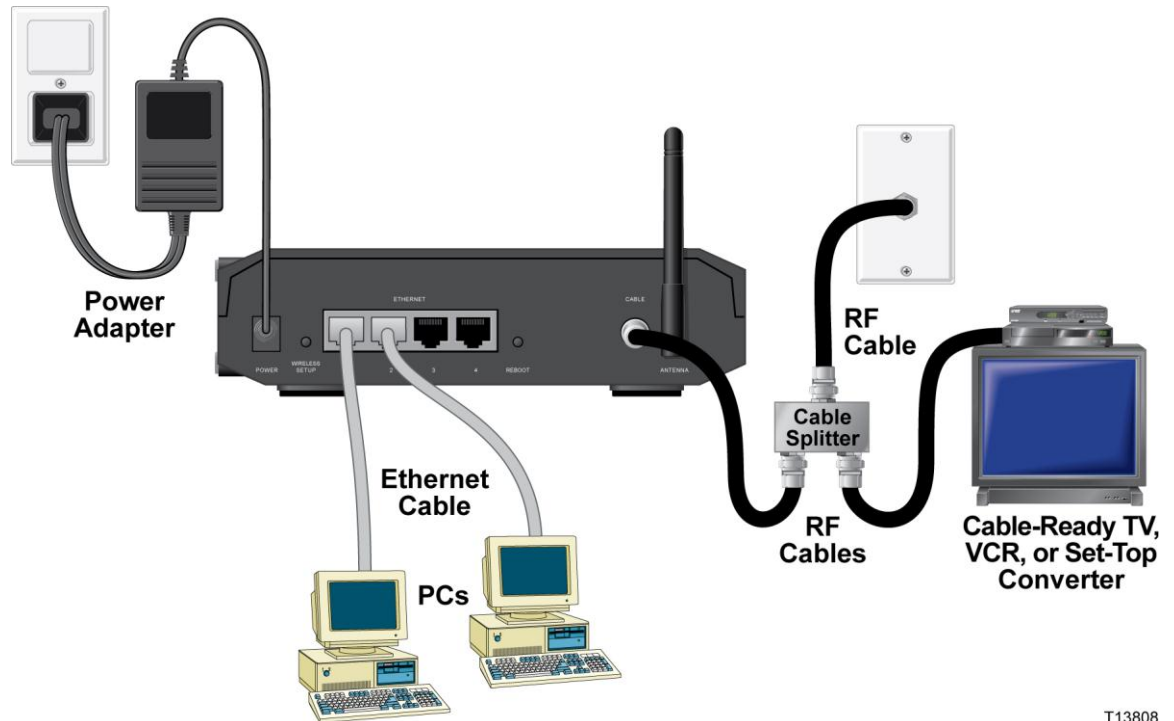

T13808

## Connecting the Modem for High-Speed Data Service



### WARNING:

- To avoid personal injury or damage to your equipment, follow these steps in the exact order shown.
- Wiring and connections must be properly insulated to prevent electrical shock.
- Disconnect power from the residential gateway before attempting to connect to any device.

6 Power off your PC and other networking device; then, unplug them from the power source.

7 Connect the active RF coaxial cable from your service provider to the coax connector labeled **CABLE** on the back of the gateway.

**Note:** To connect a TV, DHCT, set-top box, or VCR from the same cable connection, you will need to install a cable signal splitter (not included).

8 Locate the yellow Ethernet cable. Connect one end of the Ethernet cable to the Ethernet port on your PC and then connect the other end to one of the **ETHERNET** ports on the gateway (any Ethernet port can be used). The Ethernet ports are yellow connectors on the back panel of the gateway.

9 Connect additional Ethernet network devices in a similar fashion to any unused Ethernet ports on the back of the gateway.

**Note:** To install more Ethernet devices than ports provided, use an external multi-port Ethernet switch(s).

10 Locate the AC power adapter provided with your gateway. Insert the barrel shaped DC power connector (attached by a thin pair of wires to the AC power adapter) into the black **POWER** connector on the back of the residential gateway. Then, plug the AC power cord into an AC outlet to power-up the gateway. The residential gateway will perform an automatic search to locate and sign on to the broadband data network. This process may take up 2-5 minutes. The modem will be ready for use when the **POWER**, **DS**, **US** and **ONLINE** LEDs on the front panel of the gateway stop blinking and remain **ON** continuously.

11 Plug in and power on your PC and other home network devices. The **ETHERNET** LEDs on the gateway corresponding to the connected devices should be **ON** or **BLINKING**.

12 Once the gateway is online, most Internet devices will have immediate Internet access.

**Note:** If your PC does not have Internet access, refer to *How Do I Configure TCP/IP Protocol?* (on page 100) for information on how to configure your PC for Internet access. For Internet devices other than PCs, refer to the DHCP or IP Address configuration section of the User Guide or Operations Manual for those devices.

## How Do I Configure My DOCSIS Residential Gateway?

To configure your residential gateway, you must first access the WebWizard configuration pages. This section provides detailed instructions and procedures for accessing the WebWizard pages and for configuring your residential gateway to operate correctly. This section also presents examples and descriptions of each WebWizard configuration page. Use the WebWizard pages to customize your residential gateway to your needs rather than using the default settings. The WebWizard pages in this section are organized in the order shown on the **Setup** page.

**Important:** The WebWizard pages and the examples shown in this section are for illustration purposes only. Your pages may differ from the pages shown in this guide.

**Note:** If you are not familiar with the network configuration procedures detailed in this section, contact your service provider before you attempt to change any of the residential gateway default settings.

### About Your Modem Page Example

The following illustration is an example of the About Your Modem page.

**About Your Modem**  
This page provides the basic information about your cable modem.

**System**  
The data shown in the table below provides information about the system of your cable modem.

Name	SA DPC2325
Modem Serial Number	MG20081003-10
Cable Modem MAC Address	00:1c:ea:21:36:12
Hardware Version	1.0
Receive Power Level	-23.0 dBmV
Transmit Power Level	8.3 dBmV
Cable Modem Status	Not Synchronized
Vendor	Scientific-Atlanta, Inc.
Boot Revision	2.1.7IR1

**Software File Name and Revisions**  
The data shown in the table below provides information about the firmware of your cable modem.

Firmware Name	dpc2325-v202r12811-081003a.bin
Software Revision	dpc2325-v202r12811-081003a



## Accessing the Residential Gateway

You must access the WebWizard in order to configure the residential gateway. To gain access to the WebWizard, use the web browser on the PC attached to the gateway and complete the following steps.

- 1 Open the web browser on your PC.
- 2 Type the following IP address and then select **Go**:  
**http://192.168.0.1.**
- 3 The web browser accesses the WebWizard and displays the default **About Your Modem** page. This page displays information about your cable modem along with a series of tabs for accessing other WebWizard configuration and operation features.

## About Your Modem Page Description

The following table provides a description of each field within the About Your Modem page.

Field Name	Description
Name	The name of the residential gateway
Modem Serial Number	A unique sequential series of alphanumeric characters provided to every modem during manufacturing
Cable Modem MAC Address	A unique alphanumeric address for the cable modem coaxial interface, which is used to connect to the cable modem termination system (CMTS) at the headend. A media access control (MAC) address is a hardware address that uniquely identifies each node of a network
Hardware Version	Identifies the revision of the circuit board design
Receive Power Level	The input level of the downstream CMTS carrier
Transmit Power Level	Indicates the upstream power level

## How Do I Configure My DOCSIS Residential Gateway?

<b>Field Name</b>	<b>Description</b>
Cable Modem Status	Lists one of the following possible current states of the modem: <ul style="list-style-type: none"><li>■ other</li><li>■ notReady</li><li>■ notSynchronized</li><li>■ phySynchronized</li><li>■ usParametersAcquired</li><li>■ rangingComplete</li><li>■ ipComplete</li><li>■ todEstablished</li><li>■ securityEstablished</li><li>■ psrsmTransferComplete</li><li>■ registrationComplete</li><li>■ operational</li><li>■ accessDenied</li></ul>
Vendor	The name of the manufacturer
Boot Revision	Identifies the boot revision code version

### Software File Name and Revisions Section

<b>Field Name</b>	<b>Description</b>
Firmware Name	Identifies the name of the firmware
Software Revision	Identifies the revision version of the firmware

## Setting Configuration Options

Use the Setup page to access the various configuration options for the residential gateway. Detailed descriptions of each configuration option follow later in this guide.

**Important:** After you access the WebWizard by typing the 192.168.0.1 IP address into your web browser while the gateway is online, an authentication window similar to the following window opens:

An authentication dialog box with a light gray background. It contains a 'User name:' label followed by a text input field with a small user icon on the left and a dropdown arrow on the right. Below that is a 'Password:' label followed by a text input field. Underneath the password field is a checkbox labeled 'Remember my password'. At the bottom of the dialog are two buttons: 'OK' and 'Cancel'.

Enter your password; then, click **OK** to continue to the Setup page.

### First Time Users

The gateway ships from the factory without a factory-assigned or default password.

Leave the user name and the password fields blank. Then click **OK** to be directed to the Password Settings page.

**Note:** You will be prompted to set up a password. We highly recommend that you set up a password to prevent unauthorized access to the settings of the gateway. If you choose not to enter a password, this page will appear each time you access the setup pages. See *Configuring Your Password Settings* (on page 30) for assistance in setting up your password. If you choose not to use password security, click the **Setup** tab at the top of the Password Settings page to continue.

## How Do I Configure My DOCSIS Residential Gateway?

### Setup Page

The following illustration is an example of the Setup page.

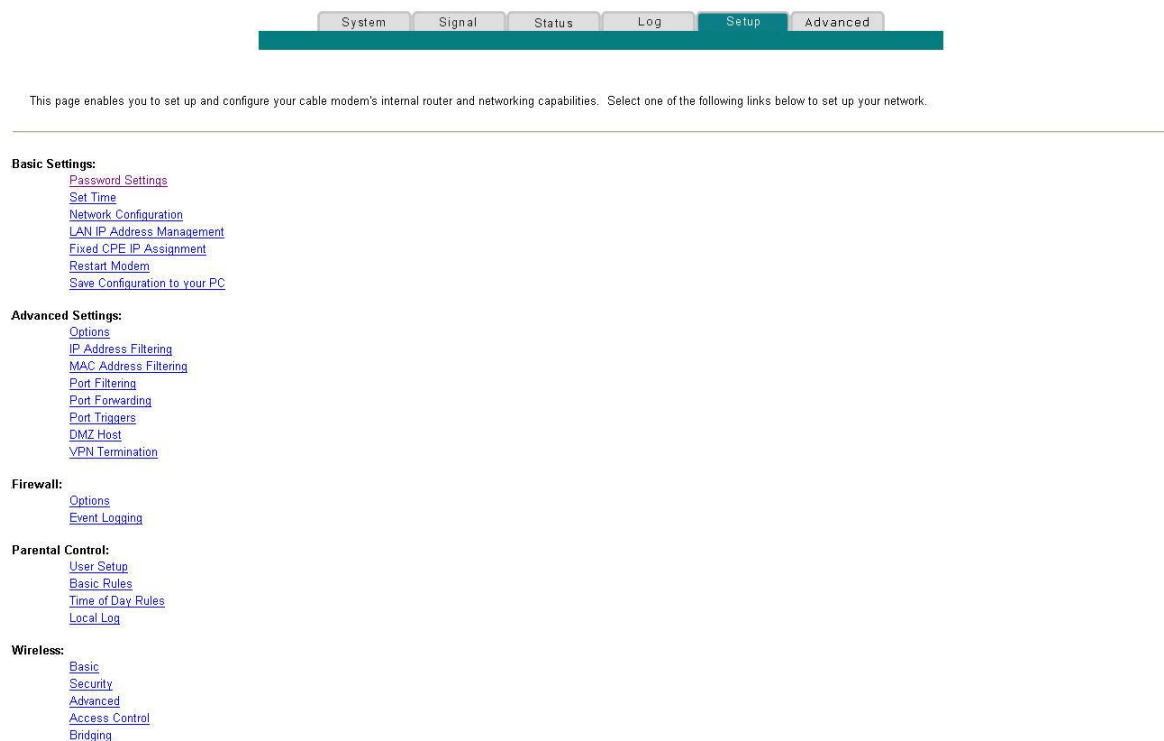

### Setup Page Section Headings

The Setup page is divided into the following section headings:

- Basic Settings
- Advanced Settings
- Firewall
- Parental Control
- Wireless

In the Setup page, click the selections listed within these sections to access the WebWizard page for that selection. A description of the selections available in each section follows next.

### Basic Settings

The following table provides a description of the pages available from within the Basic Settings section of the Setup page.

<b>Field Name</b>	<b>Description</b>
Password Settings	Use this link to set or modify your password settings
Set Time	Use this link to enable or disable time synchronization by Network Time protocol
Network Configuration	Use this link to enter or modify the basic settings for your network
LAN IP Address Management	Use this link to configure how Internet protocol (IP) addresses are assigned and managed in your network
Fixed CPE IP Assignment	Use this link to reserve IP addresses in the DHCP pool that will be used as static IP addresses in your local network.
Restart Modem	Use this link to restart your residential gateway
Save Configuration to your PC	Use this link to save your cable modem RG configuration to your local PC and to restore the RG configuration to your residential gateway, if necessary

### Advanced Settings

The following table provides a description of the pages available from within the Advanced Settings section of the Setup page.

<b>Field Name</b>	<b>Description</b>
Options	Use this link to enable or disable advanced features on your network
IP Address Filtering	Use this link to configure IP address filters. These filters prevent designated IP addresses from accessing the Internet
MAC Address Filtering	Use this link to configure MAC address filters. These filters prevent designated MAC addresses from accessing the Internet
Port Filtering	Use this link to configure transmission control protocol (TCP) and user datagram protocol (UDP) port filters. These filters prevent a range of TCP/UDP ports from accessing the Internet
Port Forwarding	Use this link to configure port forwarding for local IP addresses. Port forwarding allows you to run a server on the local area network (LAN) by specifying the mapping of TCP/UDP ports to local PCs or to the IP address of other devices. This is a static setting that holds the ports open at all times

## How Do I Configure My DOCSIS Residential Gateway?

<b>Field Name</b>	<b>Description</b>
Port Triggers	Use this link to configure TCP/UDP port triggers. Port triggering is similar to port forwarding, but is a dynamic function. In other words, the ports are not held open, and the ports close if no outgoing data is detected on the selected ports for a period of 10 minutes
DMZ Host (Demilitarized Zone)	<p>Use this link to configure an IP address that is visible to the wide area network (WAN). DMZ hosting is commonly referred to as “exposed host,” and allows you to specify the “default” recipient of WAN traffic that Network Address Translation (NAT) is unable to translate to a known local PC</p> <p>A DMZ is used by a company that wants to host its own Internet services without sacrificing unauthorized access to its private network. DMZ allows one IP address to be unprotected while others remain protected. The DMZ is located between the Internet and an internal network's line of defense that is a combination of firewalls and bastion hosts</p> <p>Typically, the DMZ contains devices accessible to Internet traffic, such as web (HTTP) servers, FTP servers, SMTP (e-mail) servers, and domain name system (DNS) servers</p>
VPN Termination	Use this link to create, configure, and control Virtual Private Network (VPN) protocols and manage Internet Protocol Security (IPsec) VPN tunnels.

### Firewall

The following table provides a description of the pages available from within the Firewall section of the Setup page.

<b>Field Name</b>	<b>Description</b>
Options	Use this link to configure webpage filtering and firewall protection
Event Logging	Use this link to access the firewall event log and to enter your e-mail address in order to receive e-mail alerts related to firewall attacks by hackers

### Parental Control

The following table provides a description of the pages available from within the Parental Control section of the Setup page.

<b>Field Name</b>	<b>Description</b>
User Setup	Use this link to add or delete user profiles and to apply access rules to those users
Basic Rules	Use this link to setup access rules that block certain Internet content and certain websites
Time of Day Rules	Use this link to configure web access filters to block all Internet traffic to and from specific network devices based on time of day settings that you select
Local Log	Use this link to view events captured by Parental Control event log feature

### Wireless

The following table provides a description of the pages available from within the Wireless section of the Setup page.

<b>Field Name</b>	<b>Description</b>
Basic	Use this link to configure your wireless access point (WAP) parameters, including service set identifier (SSID) and channel number
Security	Use this link to configure your WAP authentication and data encryption. Using encryption and authentication prevents unauthorized access to your wireless devices
Advanced	Use this link to configure your WAP data rates and wireless fidelity (Wi-Fi) thresholds
Access Control	Use this link to configure the WAP to restrict access to only selected wireless client devices. Authorized clients are selected by MAC address. Use this link to select Open System or Share Key authentication and to enable and disable broadcast of the WAP SSID
Bridging	Use this link to configure a Wireless Distribution System (WDS) in our network



## Configuring Your Password Settings

Use the Basic Settings - Password Settings page to set up or modify a password to restrict unauthorized persons from accessing to your residential gateway settings. Click **Password Settings** in the Basic Settings section of the Setup page to access the Password Settings page.

### Notes:

- Your gateway modem comes from the factory with no password enabled. We highly recommend that you set up a user password to prevent unauthorized users from modifying the settings of your network.
- If you do choose to set up a password, use a password that you can easily remember. Do *not* forget your password.

## Setup Basic Settings - Password Settings

The following illustration is an example of the Basic Settings - Password Settings page.

System Signal Status Log Setup Advanced

**Setup**  
**Basic Settings - Password Settings**  
This page allows you to modify the password settings for this device.

**Security advice: you should change the password, otherwise you are exposed to attacks from the Internet.**

Important: As a matter of good operating practice, it is highly recommended to use this page to establish a personalized user Password. Setting a user password can help prevent unauthorized access to the Setup pages for this residential gateway. Unauthorized access may result in disrupted home network operation or a breach in your home network security, exposing the equipment in your home network to denial of service attacks and hacking from a variety of potentially malicious sources.

Current Password

New Password

Re-Enter New Password

Apply

### To set up your password

- 1 To set up your password, type your current password in the **Current Password** field.
- 2 Type your new password in the **New Password** field, and then re-enter your new password in the **Re-Enter New Password** field.
- 3 Click **Apply** to save your password. A webpage appears to indicate that you have successfully set your password.
- 4 Click on the **Setup** tab to proceed with setting up your gateway. The User Name and Password dialogue box appears as shown below.
- 5 Enter your password; then, click **LOGIN** to continue to the main Setup page.

## How Do I Configure My DOCSIS Residential Gateway?

**Note:** If you set a password, on subsequent access to the Setup pages, a screen similar to the following appears. Do *not* forget your password. Write your password and store it in a secure location known only to you.



The image shows a login dialog box with a light beige background and a blue border. It contains the following elements:

- User name:** A text input field with a small user icon on the left and a dropdown arrow on the right.
- Password:** A text input field.
- Remember my password
- OK** button
- Cancel** button

## Configuring Network Time Synchronization

Use the Basic Settings Enable/Disable time synchronization by Network Time protocol page to enable or disable time synchronization by Network Time protocol.

**Note:** If you are not familiar with the time configuration procedures detailed in this section, contact your service provider before you attempt to change any of the residential gateway default time synchronization configuration settings.

Click **Set Time** in the Basic Settings section of the Setup page to access the Basic Settings Enable/Disable time synchronization by Network Time protocol page.

## Setup Basic Settings - Enable/Disable Time Synchronization by Network Time Protocol

The following illustration is the initial view of the Basic Settings Enable/Disable time synchronization by Network Time protocol page.

The screenshot shows a web interface with a navigation bar at the top containing tabs for System, Signal, Status, Log, Setup, and Advanced. The Setup tab is selected. Below the navigation bar, the page title is "Setup" and the subtitle is "Basic Settings - Enable/Disable time synchronization by Network Time protocol". A description below the subtitle reads: "This page allow you to enable or disable time synchronization by Network Time protocol." The main configuration area includes the following fields and controls:

- Current System Time: Thu Jan 01 00:30:07 1970
- Network Time Protocol:  Enable  Disable
- Latest Update Success: -----
- Time Zone: (GMT) Greenwich Mean Time : Dublin, Edinburgh, Lisbon, London (dropdown menu)
- Daylight Saving Time: 0 minutes  Enable
- Apply button
- Time Server: [input field] Add Server
- Time Server list:
  - time.nist.gov
  - nist-aol-ca.tnetime.com
  - nist1-ny.glassey.com
- Remove Server button

## Setup Basic Settings - Enable/Disable Time Synchronization by Network Time Protocol Page Description

The following table provides a description of the fields within the Basic Settings Enable/Disable time synchronization by Network Time protocol page.

Field Name	Description
Current System Time	Displays the current system time and date
Network Time Protocol	<p>Allows you to enable or disable network time protocol</p> <p><b>Note:</b> The residential gateway will automatically use the time server in your broadband network. Should there be no current time displayed or if the network time is incorrect, enable Network Time Protocol to use a public Internet time server to set the clock in the gateway.</p>
Latest Update Success	Displays the time and date of the last successful time update
Time Zone	Displays the current time zone. The drop-down list allows you to select your local time zone.
Daylight Saving Time	<p>Allows you to adjust the time during periods when Daylight Saving Time is in effect. Check the <b>Enable</b> box to enable or disable this setting.</p> <p><b>Note:</b> If the offset for Daylight Savings Time is other than 60 minutes, enter the offset in the minutes field.</p>
Time Server	<p>Add and delete time server URLs or IP addresses to and from the list, as required. When using Network Time Protocol, multiple time servers can be specified for the gateway to query for time of day. The gateway will sequentially step through the listed time servers until it acquires the current time. There are three well known public time servers entered as default servers.</p>

### Function Keys

Key	Description
Apply	Saves all additions, edits, and changes
Add Server	Allows you to add a network time server
Remove Server	Allows you to remove a network time server

## **How Do I Configure My DOCSIS Residential Gateway?**

Under normal conditions, you should use the default network settings. In the event that the network time does not match your local time, or, if your system requires different settings to operate correctly, you can change the default network settings using the Setup Basic Settings - Network Configuration page.

## Configuring the Network Settings

**Note:** If you are not familiar with the network configuration procedures detailed in the following sections, contact your service provider before you attempt to change any of the residential gateway default network configuration settings.

Click **Network Configuration** in the Basic Settings section of the Setup page to access the Setup Basic Settings - Network Configuration page.

## Setup Basic Settings - Network Configuration

The following illustration is an example of the Setup Basic Settings - Network Configuration page.

## Setup Basic Settings - Network Configuration Page Description

The following table provides a description of the fields within the Setup Basic Settings - Network Configuration page.

Field Name	Description
LAN IP Address	Displays the base IP address of the private home LAN and the WebWizard IP address. Your residential gateway assigns private IP addresses to your attached computers by its internal dynamic host configuration protocol (DHCP) server
IP Network	Displays the address of the private LAN IP network

## How Do I Configure My DOCSIS Residential Gateway?

<b>Field Name</b>	<b>Description</b>
Decimal Netmask	Displays the netmask of the private LAN IP network
Broadcast	Displays the broadcast IP address
MAC Address	Displays the MAC address for the WAN. The factory assigned MAC address for the WAN is also referred to as the WAN MGT MAC
WAN IP Address	Displays the public IP address assigned to your gateway by your ISP. The WAN port will be assigned a public IP address automatically by your ISP except when a static IP address is set up as described below. The WAN IP address will be shared by all the PCs in your private local area network to access the Internet
Subnet Mask	Displays the subnet mask for your WAN port. This address is automatically assigned to your WAN port by your ISP except when a static IP address is set up as described later in this table
Gateway IP	Displays a Gateway IP address for your WAN port. This address is automatically assigned to your WAN port by your ISP except when a static IP address is set up as described later in this table
Duration	Displays the length of time your WAN IP address is valid
Expires	Displays the date and time your WAN IP address expires
Host Name	Displays the host name that is usually downloaded to your gateway by your ISP. However, some ISPs require this information to be entered manually. If manual entry is required, your ISP will provide the information for you to enter into this field.
Domain Name	Displays the domain name that is usually downloaded to your gateway by your ISP. However, some ISPs require this information to be entered manually. If manual entry is required, your ISP will provide the information for you to enter into this field.
Static IP Address	Manual entry is required. Your ISP will provide the information for you to enter into this field.  <b>Note:</b> When setting a static IP address, you must enter the IP address, subnet mask, and default gateway before the static IP address will become operational.
Static IP Mask	Manual entry is required. Your ISP will provide the information for you to enter into this field.
Default Gateway	Manual entry is required. Your ISP will provide the information for you to enter into this field.



<b>Field Name</b>	<b>Description</b>
Primary DNS (static IP only)	Manual entry is required. Your ISP will provide the information for you to enter into this field.
Secondary DNS (static IP only)	Manual entry is required. Your ISP will provide the information for you to enter into this field.
MTU Size	Sets the size of the maximum transmission unit (MTU) for the network interface. The default value is 0 (zero)  <b>Important:</b> Do not change this value unless you are an experienced user.

### Function Keys

The following function keys appear on the Setup Basic Settings - Network Configuration page.

<b>Key</b>	<b>Description</b>
Renew WAN IP Address Lease	Forces a release and renewal of your WAN IP address
Apply	Saves the values you enter into the fields without closing the screen

## Configuring and Managing IP Addresses

Use the Setup Basic Settings - IP Management page to configure how your system manages and assigns IP addresses in your network.

**Note:** If you are not familiar with the IP management procedures detailed in this section, contact your service provider before you attempt to change any of the residential gateway default IP management settings.

Click **LAN IP Address Management** in the Basic Settings section of the Setup page to access the Setup Basic Settings - IP Management page.

## Setup Basic Settings - IP Management Page Example

The following illustration is an example of the Setup Basic Settings - IP Management page.

System Signal Status Log Setup Advanced

**Setup**  
**Basic Settings - IP Management**  
This page allows you to configure how IP addresses are assigned and managed in your network.

DHCP Server  Yes  No  
Starting Local Address: 192.168.0.10  
Number of CPEs: 190  
Lease Time: 3600  
Apply

MAC Address	IP Address	Subnet Mask	Duration	Expires
00155880e196	192.168.0.011	255.255.255.000	D:00 H:01 M:00 S:00	-----

Current System Time: -----  
Force Available

WINS Addresses  
Add Primary Add Secondary Add Tertiary  
Primary: 0.0.0.0  
Secondary: 0.0.0.0  
Tertiary: 0.0.0.0  
Remove WINS Address Clear All

## Setup Basic Settings - IP Management Page Description

The following tables provide a description of the fields within the Setup Basic Settings - IP Management page.

Field Name	Description
DHCP Server	Allows you to enable or disable the DHCP server in the residential gateway
Starting Local Address	<p>Displays the starting address used by the built-in DHCP server to distribute Private LAN IP addresses. In the example shown, addresses between 2 and 9 can be used for devices on your Private LAN that require fixed IP addresses such as printers or a device assigned as a DMZ host</p> <p><b>Note:</b> The LAN IP address ending in 1 is reserved for the internal gateway server. The LAN IP address ending in 255 is also reserved and should not be used for CPE devices</p>
Number of CPEs	<p>Enter the maximum number of devices allowed to connect to the Private LAN.</p> <p><b>Note:</b> The Factory Default is 245. The maximum number of devices is 253. This is the combined total of addresses reserved for static IP addresses, for example, the sum of the IP addresses between 2 and the value entered in the Starting Local Address field and the value entered in the Number of CPEs field.</p> <p><b>Note:</b> The sum of the value entered in the Starting Local Address field and the value entered in the Number of CPEs field must always be 255 or less.</p>
DHCP Client Lease Info	Displays the MAC address, IP Address, Subnet Mask, Duration and Expiration date of all devices issued an IP address by the built-in DHCP server. This field also displays the current system time and date
WINS Addresses	Allows you to manually enter Windows Internet Name Server (WINS) server addresses

## How Do I Configure My DOCSIS Residential Gateway?

### Function Keys

The following function keys appear on the Basic Settings - IP Management page.

<b>Key</b>	<b>Description</b>
Apply	Saves the values you enter into the fields without closing the screen
Force Available	Forces the release of an IP address for you to re-use
Add Primary	Saves the WINS address for one server
Add Secondary	Saves the WINS address for a second server
Add Tertiary	Saves the WINS address for a third server
Remove WINS Address	Removes the WINS address selected
Clear All	Removes all defined WINS addresses

## Reserving IP Addresses

Use the Setup Basic Settings - Fixed CPE IP Assignment page to reserve IP addresses. This feature allows you to assign a fixed IP address to any device in your network by setting static IP addresses in your PC or other network device.

These addresses will be removed from the pool of the IP addresses to be used by your gateway's DHCP server when issuing IP addresses to devices that are connected to your local network.

Reserving IP addresses is useful in making sure that there are no IP address conflicts on the network, for example, two devices using the same IP address. Another example: when using DMZ Host, the IP address for the DMZ Host should always have the same IP address.

**Note:** If you are not familiar with the Fixed CPE IP Assignment procedures detailed in this section, contact your service provider before you attempt to change any of the residential gateway default Fixed CPE IP Assignment settings.

Click **Fixed CPE IP Assignment** in the Basic Settings section of the Setup page to access the Setup Basic Settings - Fixed CPE IP Assignment page.

## Setup Basic Settings - Fixed CPE IP Assignment Page

The following illustration is an example of the Setup Basic Settings - Fixed CPE IP Assignment page.

System Signal Status Log Setup Advanced

**Setup**  
**Basic Settings - Fixed CPE IP Assignment**  
This page allows you to set fixed IP for LAN CPE devices.

MAC Address :  :  :  :  :  :

Assign to IP :  .  .  .

MAC Address	IP Address	Status
00:15:58:80:a1:96 <->	192.168.0.11	Active

## Setup Basic Settings - Fixed CPE IP Assignment Page Description

The following tables provide a description of the fields within the Setup Basic Settings - Fixed CPE IP Assignment page.

<b>Field Name</b>	<b>Description</b>
MAC Address	The MAC address of the PC or device (for example, a printer) for which you want to reserve a specific IP address on the network
Assign to IP	The IP address you assign to the PC or device for which you want to reserve a specific IP address on the network. Only MAC addresses within the range of the gateway's DHCP address pool can be reserved with this feature.  <b>Note:</b> The factory configuration of your gateway sets aside IP addresses 192.168.0.2 through 192.168.0.9 for static IP addresses.

### Function Keys

<b>Key</b>	<b>Description</b>
Add Static IP	Adds the Static IP address to the list of assigned IP addresses
Remove Static IP	Removes the Static IP address from the list of assigned IP addresses

## Restarting the Gateway Modem

Use the Setup Basic Settings - Restart Cable Modem page to restart your cable modem.

- 1 Click **Restart Modem** in the Basic Settings section of the Setup page to access the Basic Settings - Restart Cable Modem page.
- 2 Click **Reboot Cable Modem** to restart the gateway modem.

**Note:** Restarting your gateway modem does not reset any of the settings.

## Setup Basic Settings - Restart Cable Modem Page

The following illustration is an example of the Restart Cable Modem page.

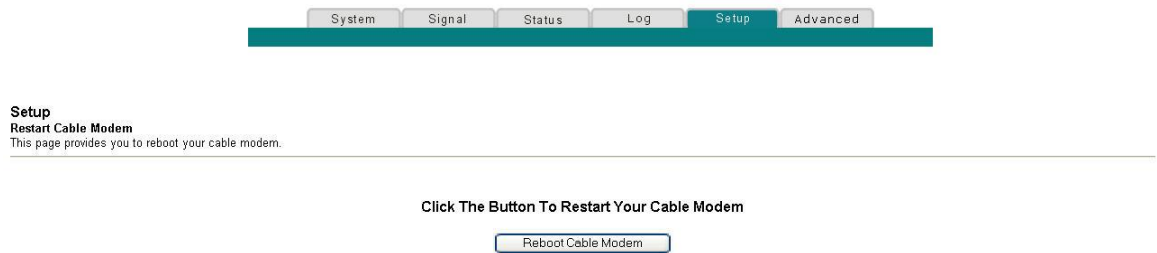

## Saving Your Configuration

Use the Setup Basic Settings - Save RG Configuration to Local PC page to save your current cable modem RG configuration to the hard drive on your PC or to a floppy disk. You will then be able to restore the RG configuration, if necessary.

**Note:** If you are not familiar with the procedures detailed in this section, contact your service provider before you attempt to change any of the residential gateway default settings.

Click **Save Configuration to your PC** in the Basic Settings section of the Setup page to access the Setup Basic Settings - Save RG Configuration to Local PC page.

## Setup Basic Settings - Save RG Configuration to Local PC Page

The following illustration is an example of the Setup Basic Settings - Save RG Configuration to Local PC page.

System Signal Status Log Setup Advanced

**Save RG Configuration to Local PC**  
This page provides you with the ability of saving current RG configuration in this device to your Local PC and restoring RG configuration to your device

Download user setting file to your gateway

File Name  Browse...  
Download

Save current user setting to your computer

FDD

To **Save** your current setting to your computer, click the floppy disk icon in the lower portion of the screen. You will be prompted to provide a file name and location for the backup configuration file.

To **Restore** your setting, click **Browse** and select the backup configuration file name that you saved on your PC. The path and filename of the backup configuration appears in the File Name field. Then, click **Download** to restore your configuration file. A **Download Success** message appears when the restore is complete.



## Enabling and Disabling Advanced Features

Use the Setup Advanced Settings - Options page to enable or disable advanced features on your network. When the wireless interface is disabled, the transmitter is turned off.

**Note:** If you are not familiar with the advanced settings detailed in this section, contact your service provider before you attempt to change any of the residential gateway default advanced options settings.

Click **Options** in the Advanced Settings section of the Setup page to access the Setup Advanced Settings - Options page.

## Setup Advanced Settings - Options Page

The following illustration is an example of the Setup Advanced Settings - Options page.

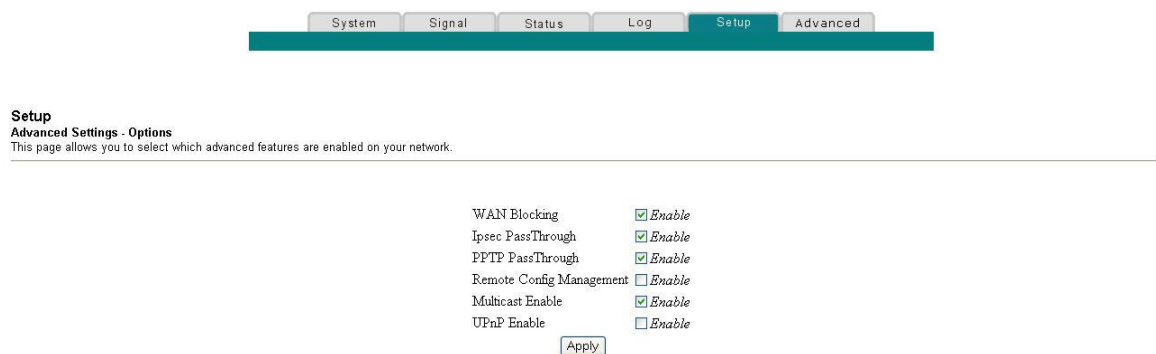

## Setup Advanced Settings - Options Page Description

The following table provides a description of the fields within the Setup Advanced Settings - Options page.

**Note:** If you make changes in the Setup Advanced Settings - Options page, click **Apply** to apply and save your new IP address filter settings.

Field Name	Description
WAN Blocking	Checking this box prevents the residential gateway from being visible to the WAN. For example, pings to the WAN IP address are not returned.
IPsec PassThrough	Checking this box allows applications that use IPsec (IP Security) to pass through the firewall
PPTP PassThrough	Checking this box allows applications that use Point to Point Tunneling Protocol (PPTP) to pass through the firewall

## How Do I Configure My DOCSIS Residential Gateway?

Field Name	Description
Remote Config Management	<p>Checking this box enables Remote Configuration Management that allows the user or network operator to view and/or modify the gateway set-up parameters from a location on the WAN, as opposed to the LAN side of the gateway. Access to the set-up parameters is obtained by using the password to access the WebWizard.</p> <p>Enable this feature by checking the <b>Remote Config Management</b> box on the Setup Advanced Settings - Options page. To access your gateway from a remote location, you must also know the WAN IP address of the gateway. To find the WAN IP address, go to the Network Configuration page under Basic Settings. You will find the gateway's WAN IP address list on this page.</p> <p>Enter the WAN IP address of your gateway into the address field of any web browser using the following format: <code>http://xxx.xxx.xxx.xxx:8080</code> where <code>xxx.xxx.xxx.xxx</code> represents the WAN IP address of your gateway.</p> <p>Be sure to follow the syntax exactly, and then click <b>Go</b> or press <b>Enter</b>. Your gateway webpages will appear on the remote computer. You will still need to enter your password to access the Setup pages of your gateway</p> <p><b>Note:</b> If you choose to enable (check) this feature, be sure to set up a user password to prevent unauthorized access to your gateway settings.</p>
Multicast Enable	Checking this box allows multicasts to pass from the WAN side through to the private network
UPnP Enable	Checking this box enables Universal Plug and Play features

## Configuring IP Address Filters

Use the Setup Advanced Settings - IP Filtering page to configure IP address filters. These filters block a range of IP addresses from accessing the Internet.

**Note:** If you are not familiar with the advanced settings detailed in this section, contact your service provider before you attempt to change any of the residential gateway default advanced IP filtering settings.

Click **IP Address Filtering** in the Advanced Settings section of the Setup page to access the Setup Advanced Settings - IP Filtering page.

## Setup Advanced Settings - IP Filtering Page

The following illustration is an example of the Setup Advanced Settings - IP Filtering page.

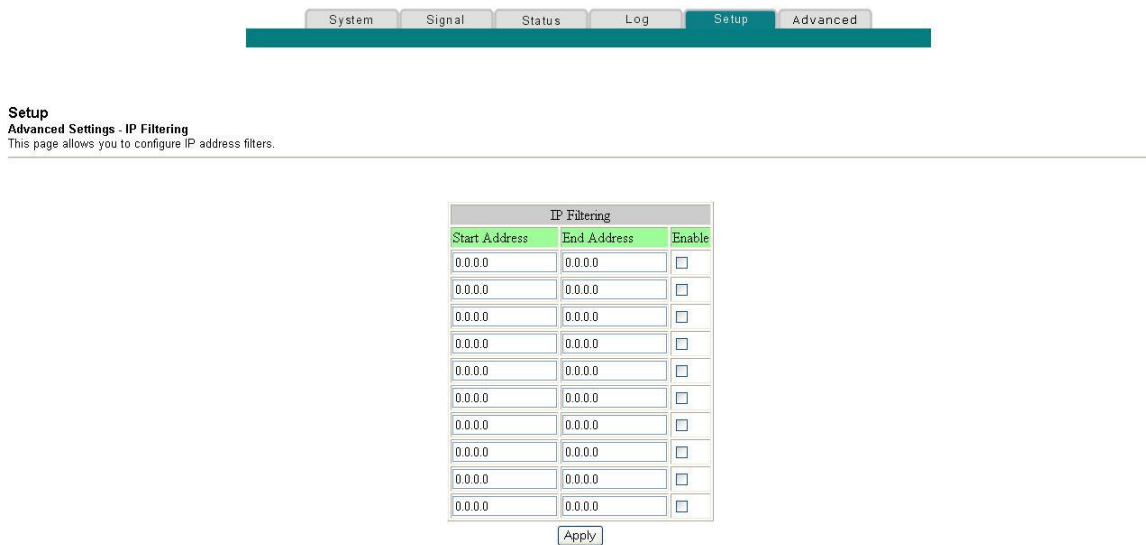

## Setup Advanced Settings - IP Filtering Page Description

Use this link to specify and enable a range of IP addresses that cannot have access to the Internet. Click **Apply** to apply and save your new IP address filter settings.

## Configuring MAC Address Filters

Use the Setup Advanced Settings - MAC Filtering page to configure MAC address filters. These filters allow you to deny or block access to the Internet by the individual MAC addresses listed in the table. You can also prevent individual PCs from sending outgoing TCP/UDP traffic to the WAN using their MAC address.

**Note:** If you are not familiar with the advanced settings detailed in this section, contact your service provider before you attempt to change any of the residential gateway default advanced MAC filtering settings.

Click **MAC Address Filtering** in the Advanced Settings section of the Setup page to access the Setup Advanced Settings - MAC Filtering page.

## Setup Advanced Settings - MAC Filtering Page

The following illustration is an example of the Setup Advanced Settings - MAC Filtering page.

System Signal Status Log Provisioning Setup Advanced

**Setup**  
**Advanced Settings - MAC Filtering**  
This page allows you to configure MAC address filters.

Block Listed

MAC Addresses (example: 01:23:45:67:89:AB)

--

Addresses entered: 0/20

## Setup Advanced Settings - MAC Filtering Page Description

Use this link to enter the MAC address or MAC addresses of devices whose Internet access you want to control. Click **Apply** to apply and save your new MAC address filter settings.

## Setting Up MAC Address Filters

The Block/Pass drop down menu allows you to block or pass Internet access to the MAC addresses of the devices you list in the MAC Address Filters table. The following table describes the function of the Block/Pass drop down menu.

Field Name	Description
Block Listed (Default)	Select <b>Block</b> to deny Internet access to the MAC addresses of the devices you list in the table. All other MAC addresses will be allowed Internet access.
Pass	Select <b>Pass</b> to allow Internet access only to the MAC addresses of the devices you list in the table. Any MAC addresses <i>not</i> listed in the table will be denied Internet access.

### Function Keys

The following function keys appear on the Advanced Settings - MAC Filtering page.

Key	Description
Apply	Saves the values you enter into the fields without closing the screen
Add MAC Address	Saves the MAC Address entered in the associated text field
Remove MAC Address	Removes the selected MAC address
Clear All	Removes all defined MAC addresses

## Configuring and Enabling TCP and UDP Port Filters

Use the Setup Advanced Settings - Port Filtering page to configure and enable TCP and UDP port filters. These filters prevent a range of TCP/UDP ports from accessing the Internet. You can also prevent PCs from sending outgoing TCP/UDP traffic to the WAN on specific IP port numbers. This filter is not IP address- or MAC address-specific. The system blocks the specified port ranges for all PCs.

**Note:** If you are not familiar with the advanced settings detailed in this section, contact your service provider before you attempt to change any of the residential gateway default advanced port filtering settings.

Click **Port Filtering** in the Advanced Settings section of the Setup page to access the Setup Advanced Settings - Port Filtering page.

## Setup Advanced Settings - Port Filtering Page

The following illustration is an example of the Setup Advanced Settings - Port Filtering page.

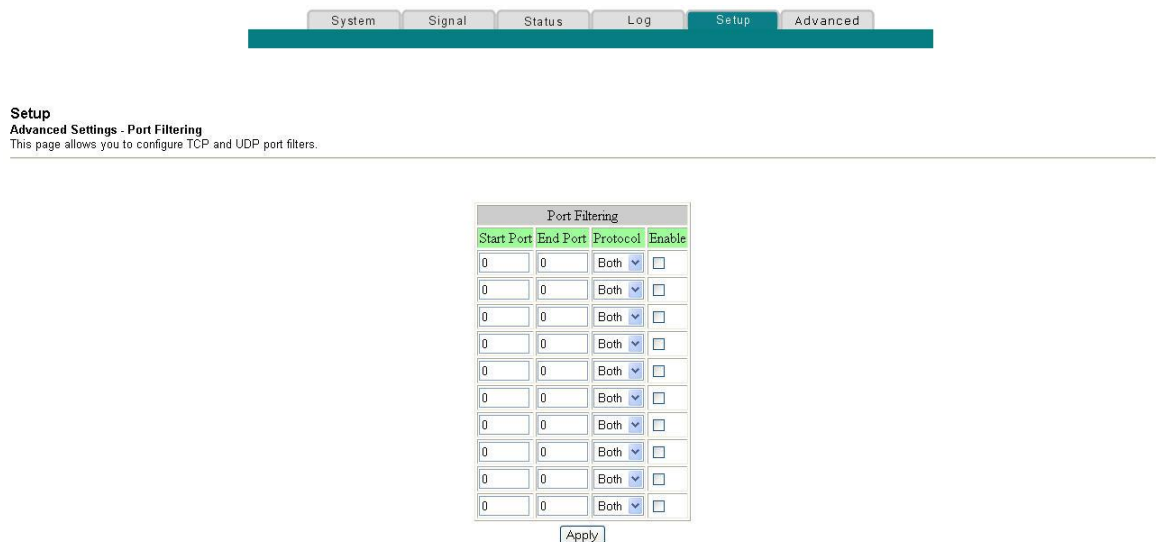

## Setup Advanced Settings - Port Filtering Page Description

Use this link to enter and enable the desired port filtering ranges and protocols in the appropriate fields and then click **Apply** to apply and save your new port filtering settings.

## Configuring Port Forwarding for Local IP Addresses

Use the Setup Advanced Settings - Port Forwarding page to configure port forwarding for local IP addresses. Port forwarding allows you to run a server on the LAN by specifying the mapping of TCP/UDP ports to a local PC. You must also set up a fixed private LAN IP address for the destination device.

**Note:** If you are not familiar with the advanced settings detailed in this section, contact your service provider before you attempt to change any of the residential gateway default advanced port forwarding settings.

Click **Port Forwarding** in the Advanced Settings section of the Setup page to access the Setup Advanced Settings - Port Forwarding page.

## Setup Advanced Settings - Port Forwarding Page

The following illustration is an example of the Setup Advanced Settings - Port Forwarding page.

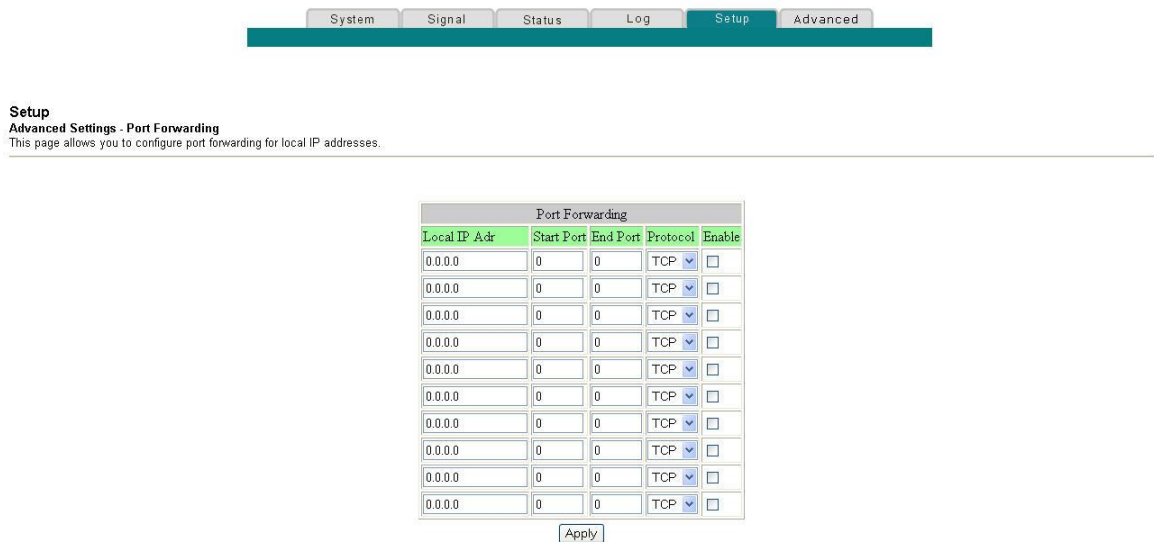

## Setup Advanced Settings - Port Forwarding Page Description

The following example illustrates how to use the port forwarding feature to configure the Microsoft X-Box Online Live for Internet gaming.

**Note:** For most widely used applications (including Microsoft X-Box Online Live), the built-in firewall automatically maps and opens ports required for that application while the application is in use.

- 1 Set the device to be used for port forward to a fixed IP address, for example, **192.168.0.5**.
- 2 In the first entry of the Port Forwarding area of the page, enter the same IP address (192.168.0.5) in the Local IP Address field.

### How Do I Configure My DOCSIS Residential Gateway?

- 3 In the same row, enter the appropriate port numbers in the Start Port and End Port fields.
- 4 In the same row, select the appropriate protocol from the drop-down list in the Protocol field, and then select the box in the **Enable** field.
- 5 To add additional ports, repeat steps 1 through 4, and then go to step 6.
- 6 Click **Apply** to apply and save your new port forwarding settings.



## Configuring TCP/UDP Port Triggers

Use the Setup Advanced Settings - Port Triggers page to configure TCP/UDP port triggers. Port triggering is similar to port forwarding but is dynamic. In other words, the system does not hold the ports open indefinitely. For example, when the residential gateway detects outgoing data on a specific IP port number set in the "Trigger Range," the resulting ports set in the "Target Range" will open for incoming data. If the system detects no outgoing traffic on the "Trigger Range" ports for a period of 10 minutes, the "Target Range" ports close. This is a safer method for opening specific ports for special applications, such as, video conferencing programs, interactive gaming, and file transfer in chat programs. This is safe because the ports are dynamically triggered and not held open continuously or left open erroneously by the router administrator. Therefore, these ports are not exposed and vulnerable for potential hackers to discover.

**Note:** If you are not familiar with the advanced settings detailed in this section, contact your service provider before you attempt to change any of the residential gateway default advanced port triggers settings.

Click **Port Triggers** in the Advanced Settings section of the Setup page to access the Setup Advanced Settings - Port Triggers page.

## Setup Advanced Settings - Port Triggers Page

The following illustration is an example of the Setup Advanced Settings - Port Triggers page.

**Setup**  
**Advanced Settings - Port Triggers**  
 This page allows you to configure TCP/UDP port triggers.

Port Triggering						
Trigger Range		Target Range		Protocol	Enable	
Start Port	End Port	Start Port	End Port			
0	0	0	0	TCP	<input type="checkbox"/>	
0	0	0	0	TCP	<input type="checkbox"/>	
0	0	0	0	TCP	<input type="checkbox"/>	
0	0	0	0	TCP	<input type="checkbox"/>	
0	0	0	0	TCP	<input type="checkbox"/>	
0	0	0	0	TCP	<input type="checkbox"/>	
0	0	0	0	TCP	<input type="checkbox"/>	
0	0	0	0	TCP	<input type="checkbox"/>	
0	0	0	0	TCP	<input type="checkbox"/>	
0	0	0	0	TCP	<input type="checkbox"/>	

Apply

## Setup Advanced Settings - Port Triggers Page Description

Use this link to enter and enable the port forwarding trigger and target range start and end ports along with protocol information in the appropriate fields. The following example illustrates how to use the port triggering feature to configure the Microsoft X-Box Online Live for Internet gaming.

**Note:** For most widely used applications (including Microsoft X-Box Online Live), the built-in firewall automatically maps and opens ports required for that application while the application is in use.

- 1 In the first row, enter **88** in both Start Port and End Port fields.
- 2 In the same row, select **UDP** from the drop-down list in the Protocol field, and then select the box in the **Enable** field.
- 3 In the second row, enter **3074** in both Start Port and End Port fields.
- 4 In the same row as the second entry, select **Both**, and then select the box in the Enable field.
- 5 Click **Apply** to apply and save your new port forwarding settings.

## Configuring the DMZ Host

Use the Setup Advanced Settings - DMZ Host page to configure an IP address that is visible to the WAN. DMZ hosting is commonly referred to as “exposed host,” and allows you to specify the “default” recipient of WAN traffic that Network Address Translation (NAT) is unable to translate to a known local PC. DMZ allows one IP address to be unprotected while others remain protected.

**Note:** If you are not familiar with the advanced settings detailed in this section, contact your service provider before you attempt to change any of the residential gateway default advanced DMZ host settings.

Click **DMZ Host** in the Advanced Settings section of the Setup page to access the Setup Advanced Settings - DMZ Host page.

## Setup Advanced Settings - DMZ Host Page

The following illustration is an example of the Setup Advanced Settings - DMZ Host page.



## Setup Advanced Settings - DMZ Host Page Description

Use this link to place a Private LAN IP device, for example, an FTP, Mail, or webserver directly on the Internet (bypassing the firewall). You set the server with a fixed IP address as a DMZ Host by entering its IP address in the DMZ Address field. Make sure the IP address used is not in the range of addresses delivered by the built-in DHCP server. After setting up a DMZ Host, all ports on this device are open to the Internet. You may configure only one PC to be the DMZ host. DMZ is generally used for PCs running “problem” applications that use random port numbers and do not function correctly with the specific port triggers or port forwarding setups described earlier in this guide. After entering a DMZ Address, click **Apply** to apply and save your new DMZ Host setting.

## Configuring VPN Termination

Use the Setup Advanced Settings - VPN Termination page to configure VPN protocols and manage VPN tunnels. A VPN is a connection between two endpoints in different networks that allows private data to be sent securely and transparently over public networks or other private networks. With a VPN, you can send data securely between these two locations or networks. This is accomplished by creating a "VPN tunnel." A VPN tunnel connects the two PCs or networks and allows data to be transmitted over the Internet as if it were still within those networks. The VPN tunnel uses IPsec (Internet Protocol security) to encrypt the data sent between the two networks and encapsulate the data within a normal Ethernet/IP frame so as to transport the private network securely and seamlessly through other public or private networks.

A VPN provides a cost-effective and more secure alternative to using a private, dedicated, leased line for a private network. Using industry standard encryption and authentication techniques, an Internet Protocol Security (IPsec) VPN creates a secure connection that operates as if you were directly connected to your local network.

For example, a VPN allows users to sit at home and connect to his/her employer's corporate network and receive an IP address in their private network just as though they were sitting in their office connected to their corporate LAN.

Another advantage of a VPN network is that it all proprietary Microsoft Windows-based networking protocols can pass through the router using the VPN tunnel to access corporate shared network drives.

**Note:** If you are not familiar with the advanced settings detailed in this section, contact your service provider before you attempt to change any of the wireless home gateway defaults advanced VPN Termination settings.

Click **VPN Termination** in the Advanced Settings section of the Setup page to access the Setup Advanced Settings - VPN Termination - Status page. The VPN Termination - Status page allows you to create, configure, and control IPsec VPN tunnels.

## Setup Advanced Settings - VPN Termination - Status Page

The following illustration is an example of a blank Setup Advanced Settings - VPN Termination - Status page. No VPN tunnels are configured.



## Setup Advanced Settings - VPN Termination - Status Page Description

This section describes the section headings and field descriptions of the Setup Advanced Settings - VPN Termination - Status page. This page allows you to create, configure, and control IPsec VPN tunnels.

**Note:** You can set up and manage up to 50 different VPN tunnels.

Field Name	Description
IPsec Endpoint	Enables/disables the IPsec endpoint mode
Name	Displays the user-defined tunnel name entered from the VPN Setup page
Status	Displays the current connection state (Connected/NOT Connected)
Control	Displays one of the following three keys based on the current tunnel enable and connection state: <ul style="list-style-type: none"> <li>■ Enable</li> <li>■ Connect</li> <li>■ Endpoint disabled</li> </ul>
Configure	Displays Edit or Delete keys used for settings management
Add New Tunnel	Allows you to create a new tunnel configuration. When you click <b>Add New Tunnel</b> , the <b>VPN Setup</b> page opens
Event Log	Allows you to access the Event Log page. The Event Log page shows a history of VPN connections and activity in chronological order and also displays the IP address of both endpoints on the tunnel (local and remote) <p><b>Note:</b> On the Event Log page, pressing the <b>Refresh</b> key updates the Event Log table to show any changes since the page was loaded. Pressing the <b>Clear</b> key clears the log table of its current contents and only the most recent data appears</p>

## Creating and Configuring IPsec VPN Tunnels

To create and configure IPsec VPN tunnels, click **Add New Tunnel** on the VPN Termination - Status page. The VPN Setup page opens. The following illustration is an example of the VPN Setup page.

The screenshot shows the VPN Setup page with a navigation bar at the top containing tabs for System, Signal, Status, Log, EMTA, and Setup. The Setup tab is active. Below the navigation bar, the page title is "VPN Setup" with a subtitle "This page allows you to configure and manage VPN tunnels." The main configuration area is divided into several sections:

- Tunnel Selection:** A dropdown menu for "Tunnel" is set to "1.". To its right are buttons for "Delete Tunnel", "Add New Tunnel", and "Apply".
- Name:** A text input field for the tunnel name.
- Status:** A dropdown menu currently set to "Disabled".
- Local endpoint settings:**
  - Address group type: IP subnet
  - Subnet: 192 . 168 . 0 . 0
  - Mask: 255 . 255 . 255 . 0
  - Identity type: IP address
  - Identity: (empty text field)
- Remote endpoint settings:**
  - Address group type: IP subnet
  - Subnet: 0 . 0 . 0 . 0
  - Mask: 0 . 0 . 0 . 0
  - Identity type: IP address
  - Identity: (empty text field)
  - Network address type: IP address
  - Remote Address: 0.0.0.0
- IPsec settings:**
  - Pre-shared key: EnterAKey
  - Phase 1 DH group: Group 1 (768 bits)
  - Phase 1 encryption: DES
  - Phase 1 authentication: MD5
  - Phase 1 SA lifetime: 28800 seconds
  - Phase 2 encryption: DES
  - Phase 2 authentication: MD5
  - Phase 2 SA lifetime: 3600 seconds

At the bottom of the form, there is a "Show Advanced Settings" button, an "Apply" button, and a "VPN Status" button.

## Setup Advanced Settings - VPN Setup Page Description

This section describes the section headings and field descriptions of the Setup Advanced Settings - VPN Setup page. This page allows you create, configure, and control IPsec VPN tunnels.

### Tunnel Section

Field Name	Description
Tunnel	Displays existing tunnels and allows each tunnel to be individually configured
Name	Displays the name of a group of settings for a single tunnel. If no name is entered, the tunnels are named sequentially 1, 2, 3, and so on
Enable/Disable	Enables/ disables a VPN tunnel after the tunnel is named and configured. Click <b>Apply</b> to activate the selected setting (Enabled or Disabled)

### Function Keys

The following table describes the function keys associated with the Tunnel section of the VPN Setup page.

Key	Description
Delete Tunnel	Allows you to delete a tunnel
Add New Tunnel	Allows you to create a heading for the tunnel settings that you can select using the Tunnel drop-down menu
Apply	Activates the selected setting (Enabled or Disabled)

## How Do I Configure My DOCSIS Residential Gateway?

### Local Endpoint Settings

The following table describes the fields in the Local endpoint settings section of the VPN Setup page.

Field Name	Description
Address group type	Allows you to select the address group type for the local VPN access group. The following types are available: <ul style="list-style-type: none"><li>■ IP subnet</li><li>■ Single IP address</li><li>■ IP address range</li></ul>
Subnet	Allows you to enter Subnet information based on the selected Address group type as follows: <ul style="list-style-type: none"><li>■ For IP subnet, enter the subnet</li><li>■ For single IP address, enter only the specific IP address</li><li>■ For IP address range, enter the starting and ending IP addresses</li></ul>
Mask	Allows you to enter Mask information based on the selected Address group type as follows: <ul style="list-style-type: none"><li>■ For IP subnet, enter the subnet mask</li><li>■ For single IP address, enter only the specific IP address in the Subnet field. Leave this field blank.</li><li>■ For IP address range, enter the starting IP and ending IP addresses</li></ul>
Identity type	Allows you to select the local Identity type from one of the following options: <ul style="list-style-type: none"><li>■ WAN IP address of the router (default)</li><li>■ User-specified IP address</li><li>■ Fully qualified domain name (FQDN)</li><li>■ Email address</li></ul> <p>This is the identity that the far endpoint will use for identification of the VPN termination point. The remote VPN endpoint on the other end of the tunnel should match these settings for its remote endpoint settings</p>
Identity	Allows you to enter the identity string after you have selected the identity type using one of the following formats: <ul style="list-style-type: none"><li>■ For IP address mode use the format xxx.xxx.xxx.xxx</li><li>■ For FQDN use the format "yourdomain.com"</li><li>■ For email address use the format "yourname@yourdomain.com"</li></ul> <p>The remote VPN endpoint on the other end of the tunnel should match these settings for its remote endpoint settings</p>



## Remote Endpoint Settings

These settings control how the local endpoint (router) connects to the far VPN termination point (the other end of the VPN tunnel).

Field Name	Description
Address group type	<p>Allows you to select the address group type for the remote VPN access group. The following types are available:</p> <ul style="list-style-type: none"> <li>■ IP subnet</li> <li>■ Single IP address</li> <li>■ IP address range</li> </ul> <p>The remote VPN endpoint on the other end of the tunnel should match these settings for its remote endpoint settings</p>
Subnet	<p>Allows you to enter Subnet information based on the selected Address group type as follows:</p> <ul style="list-style-type: none"> <li>■ For IP subnet, enter the subnet</li> <li>■ For single IP address, enter only the specific IP address</li> <li>■ For IP address range, enter the starting and ending IP addresses</li> </ul>
Mask	<p>Allows you to enter Mask information based on the selected Address group type as follows:</p> <ul style="list-style-type: none"> <li>■ For IP subnet, enter the subnet mask</li> <li>■ For single IP address, enter only the specific IP address in the Subnet field. Leave this field blank.</li> <li>■ For IP address range, enter the starting IP and ending IP addresses</li> </ul>
Identity type	<p>Allows you to select the remote Identity type from one of the following options:</p> <ul style="list-style-type: none"> <li>■ WAN IP address of the router (default)</li> <li>■ User-specified IP address</li> <li>■ Fully qualified domain name (FQDN)</li> <li>■ Email address</li> </ul> <p>This is the identity that the far endpoint will use for identification of the VPN termination point. The remote VPN endpoint on the other end of the tunnel should match these settings for its remote endpoint settings</p>

## How Do I Configure My DOCSIS Residential Gateway?

Field Name	Description
Identity	<p>Allows you to enter the identity string after you have selected the identity type using one of the following formats:</p> <ul style="list-style-type: none"><li>■ For IP address mode use the format xxx.xxx.xxx.xxx</li><li>■ For FQDN use the format "yourdomain.com"</li><li>■ For email address use the format "yourname@yourdomain.com"</li></ul> <p>The remote VPN endpoint on the other end of the tunnel should match these settings for its remote endpoint settings</p>
Network address type	<p>Allows you to enter the address type for the endpoint WAN. Choose one of the following options:</p> <ul style="list-style-type: none"><li>■ IP address</li><li>■ FQDN</li></ul>
Remote address	<p>Allows you to enter either the IP address or the FQDN of the remote endpoint depending on what Network Address type you selected</p>

### IPsec Settings

With VPN tunnels there are two phases of Security Association (SA).

- Phase 1 creates an Internet Key Exchange (IKE) SA
- When Phase 1 is complete, Phase 2 creates one or more IPsec SAs that are then used to key IPsec sessions

Field	Description
Pre-shared key	<p>Allows you to enter the Pre-shared key of the firewall identifier if one side of the VPN tunnel is using a unique firewall</p>
Phase 1 DH group	<p>Allows you to select one of following three Diffie-Hellman (DH) encryption/decryption groups:</p> <ul style="list-style-type: none"><li>■ 768 bits</li><li>■ 1024 bits</li><li>■ 1536 bits</li></ul> <p>Diffie-Hellman is a cryptographic technique that uses public and private keys for encryption and decryption. The higher number of bits selected, the more secure the connection</p>

Field	Description
Phase 1 encryption	<p>Allows you to select the form of encryption to secure the VPN connection between endpoints. Select from the following five encryption types:</p> <ul style="list-style-type: none"> <li>■ DES</li> <li>■ 3DES</li> <li>■ AES-128</li> <li>■ AES-192</li> <li>■ AES-256</li> </ul> <p>You may choose any encryption type as long as the other end of the VPN tunnel uses the same method</p>
Phase 1 authentication	<p>Allows you to select an authentication type for another level of security. Select one of the following authentication types:</p> <ul style="list-style-type: none"> <li>■ MD5</li> <li>■ SHA</li> </ul> <p>You may choose either authentication type as long as the other end of the VPN tunnel uses the same method</p> <p><b>Note:</b> SHA is recommended because it is more secure.</p>
Phase 1 SA lifetime	<p>Allows you to enter the number of seconds for an individual rotating key to last until a re-key negotiation between each endpoint occurs. Smaller lifetimes are generally more secure since it would give a hacker a smaller amount of time to try to crack the key. However, key negotiation does take up bandwidth, so network throughput is sacrificed with small lifetimes. The default setting is 28,800 seconds.</p>
Phase 2 encryption	<p>Allows you to select the form of encryption to secure the VPN connection between endpoints. Select from the following five encryption types:</p> <ul style="list-style-type: none"> <li>■ DES</li> <li>■ 3DES</li> <li>■ AES-128</li> <li>■ AES-192</li> <li>■ AES-256</li> </ul> <p>You may select any form of encryption as long as long as the other end of the VPN tunnel uses the same method</p> <p><b>Note:</b> 3DES encryption is commonly used, but AES is recommended because it is very difficult to crack</p>

## How Do I Configure My DOCSIS Residential Gateway?

<b>Field</b>	<b>Description</b>
Phase 2 authentication	<p>Allows you to select an authentication type for another level of security. Select one of the following three authentication types:</p> <ul style="list-style-type: none"><li>■ MD5</li><li>■ SHA</li><li>■ Null (none)</li></ul> <p>You may choose any authentication type as long as the other end of the VPN tunnel uses the same method</p> <p><b>Note:</b> SHA is recommended because it is more secure.</p>
Phase 2 SA lifetime	<p>Allows you to enter the number of seconds for an individual rotating key to last until a re-key negotiation between each endpoint occurs. Smaller lifetimes are generally more secure since it would give a hacker a smaller amount of time to try to crack the key. However, key negotiation does take up bandwidth, so network throughput is sacrificed with small lifetimes. The default setting for Phase 2 is 3,600 seconds.</p>

## Configuring Firewall Protection

Use the Setup Firewall - Options page to configure webpage filtering and firewall protection. This page allows you to enable various firewall protection filters.

**Note:** If you are not familiar with the advanced settings detailed in this section, contact your service provider before you attempt to change any of the residential gateway default firewall options settings.

Click **Options** in the Firewall section of the Setup page to access the Setup Firewall - Options page.

## Setup Firewall - Options Page

The following illustration is an example of the Setup Firewall - Options page.

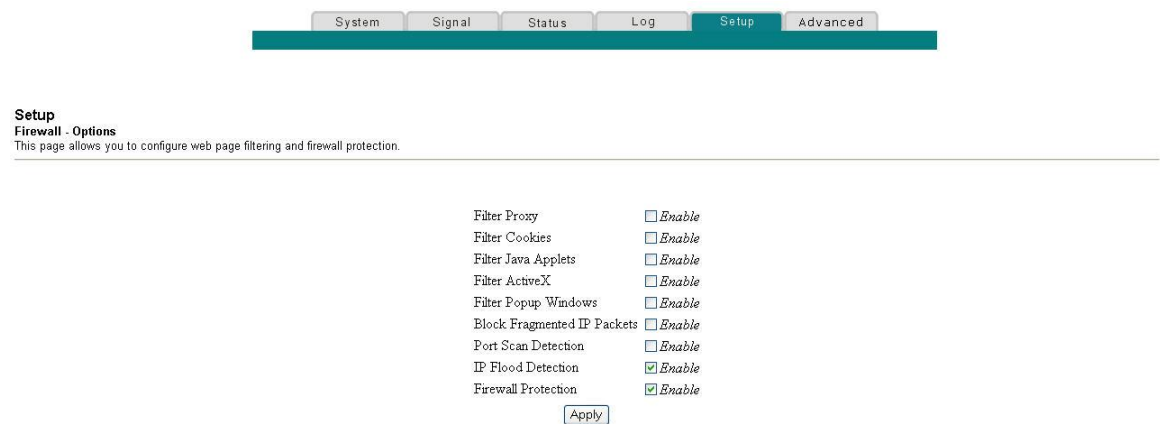

## Setup Firewall - Options Page Description

This section describes the section headings and fields descriptions of the Setup Firewall - Options page.

**Note:** If you make changes in any of the fields in the Setup Firewall - Options page, click **Apply** to apply and save your Firewall settings.

The following table provides a description of each field name within the Setup Firewall - Options page.

Field Name	Description
Filter Proxy	Enables/disables proxy
Filter Cookies	Enables/disables cookie blocking. This feature filters the unsolicited delivery of cookies to devices from the Internet to devices in your private local network. Cookies are computer files that contain personal information or web surfing behavior data.

## How Do I Configure My DOCSIS Residential Gateway?

<b>Field Name</b>	<b>Description</b>
Filter Java Applets	Enables/disables java applets. This feature helps to protect the devices in your private network from irritating or malicious Java applets that are sent, unsolicited, to devices in your private network from the Internet. These applets run automatically when they are received by a PC.
Filter ActiveX	Enables/disables ActiveX controls. This feature helps to protect the devices in your private network from irritating or malicious ActiveX controls that are sent, unsolicited, to devices in your private network from the Internet. These ActiveX controls run automatically when they are received by a PC.
Filter Popup Windows	Enables/disables popup windows. Some commonly used applications employ popup windows as part of the application. If you disable popup windows, it may interfere with some of these applications.
Block Fragmented IP Packets	Enables/disables filtering of fragmented IP packets. This feature helps protect your private local network from Internet based denial of service attacks.
Port Scan Detection	Enables/disables the gateway from responding to Internet based port scans. This feature is designed to protect your private local network from Internet based hackers who attempt to gain unsolicited access your network by detecting open IP ports on your gateway.
IP Flood Detection	Blocks malicious devices that are attempting to flood devices or networks with illegal broadcast packets. Also referred to as "broadcast storm."
Firewall Protection	Enables/disables the firewall. When the firewall is enabled, the firewall will allow most commonly used applications to automatically open IP ports and pass data without any special setup or manual port configuration.

## Configuring Firewall Event Logging and E-mail Alerts

Use the Setup Firewall - Event Logging page to access the firewall event log and allows you to enter your e-mail address in order for you to receive e-mail alerts related to firewall attacks by hackers.

**Note:** If you are not familiar with the settings detailed in this section, contact your service provider before you attempt to change any of the residential gateway default firewall event logging settings.

Click **Event Logging** in the Firewall section of the Setup page to access the Setup Firewall - Event Logging page.

## Setup Firewall - Event Logging Page

The following illustration is an example of the Setup Firewall - Event Logging page.

**Setup Firewall - Event Logging**  
This page provides access to the firewall event log and allows you to enter your email address for email alerts related to firewall attacks.

Contact Email Address

SMTP Server Name

E-mail Alerts  *Enable*

Description	Count	Last Occurrence	Target	Source
-------------	-------	-----------------	--------	--------

## Setup Firewall - Event Logging Page Description

The Setup Firewall - Event Logging page shows events captured by the firewall. The log displays the following items:

- Description of the event
- Number of events that have occurred
- Last occurrence of an event
- Target and source addresses

You can configure the system to send e-mails regarding log events to the administrator in order for the administrator to monitor the firewall.

## How Do I Configure My DOCSIS Residential Gateway?

This section describes the section headings and fields descriptions of the Setup Firewall - Event Logging page.

<b>Field Name</b>	<b>Description</b>
Enable E-mail Address	Allows you to enter the e-mail address of the person who monitors the firewall. When an event occurs, it will be logged and an e-mail will be sent to this address automatically reporting the event.
SMTP Server Name	Allows you to enter the mail server name of your outgoing mail server, or the mail server of your Internet service provider (ISP)
E-mail Alerts	Allows you to enable or disable sending e-mail alerts
Description	Describes what event was detected by the gateway's firewall
Count	Displays the number of times the event has been detected
Last Occurrence	Displays the time the last occurrence of this event was detected
Target	Displays the IP address of the device in your private local network to which the event was directed along with the IP port number targeted by the event
Source	Displays the IP address of the Internet based source of the event along with the IP port number used by that device

### Function Keys

The following function keys appear on the Setup Firewall - Event Logging page.

<b>Key</b>	<b>Description</b>
Apply	Saves the values you enter into the fields without closing the screen
E-mail Log	Allows you to force the system to send an e-mail alert even if the E-mail Alerts box is left unchecked
Clear Log	Allows you to clear all entries in the log



## Configuring Parental Control

Use the Setup Parental Control - User Setup page to configure parental controls on the residential gateway, and to add or delete the individuals who are authorized to set parental controls.

**Note:** If you are not familiar with the settings detailed in this section, contact your service provider before you attempt to change any of the residential gateway default parental control settings.

Click **User Setup** in the Parental Control section of the Setup page to access the Setup Parental Control - User Setup page.

## Setup Parental Control - User Setup Page

The following illustration is an example of the Setup Parental Control - User Setup page.

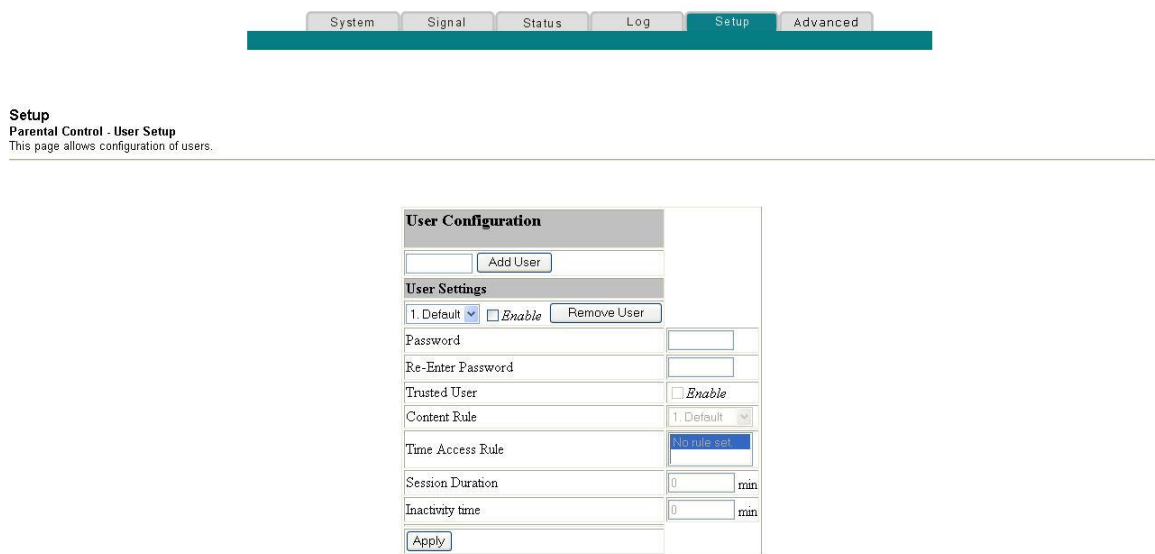

## Setup Parental Control - User Setup Page Description

This section describes the section headings and fields descriptions of the Setup Parental Control - User Setup page. This page allows you to set up user profiles. Each profile can be assigned customized levels of Internet access as defined by the access rules assigned to that user's profile.

**Note:** Once you define and enable user profiles, each user must sign-on each time they wish to access the Internet. The user can sign-on when the pop-up sign-on screen appears in their web browser. The user must enter their correct user name and password in order to gain Internet access.

### Important:

- Make sure to disable pop-up blockers on your web browser when using user profiles.
- User names and passwords are case-sensitive.

Field Name	Description
Add User	Allows you to add a new user profile. Enter the name of the user and click the <b>Add User</b> button to add the user to the list.
User Settings	Allows you to edit a user profile by using the drop-down menu to edit a user profile. The drop-down menu allows you to recall the profile to be edited. User names and passwords are case-sensitive.  Make sure to check the <b>Enable</b> box to activate the user profile. If a profile is not active, that user will not have any access to the Internet.  To remove a user profile, use the drop-down menu to select the user to be removed and click the <b>Remove User</b> button.
Password	Enter the selected user's password in this field. Each user must enter their user name and password each time they use the Internet. User names and passwords are case-sensitive.  <b>Note:</b> The gateway will allow each user access to the Internet, subject to the rules selected on this page for that user.
Re-Enter Password	Re-enter the same password for confirmation of the password in the previous field.
Trusted User	Check this box if the currently selected user is to be designated a trusted user. Trusted users are not subject to Internet access rules.

Field Name	Description
Content Rule	<p>Select the Content Rule for the current user profile. Content Rules must first be defined by going to the Rules Configuration page. You can access the Rule Configuration page by clicking the <b>Basic Rules</b> link under the Parental Control section of the Setup page.</p>
Time Access Rule	<p>Select the Time Access Rule for the current user profile. Time Access Rules must first be defined by going to the Time of Day Filter page. You can access the Time of Day Filter page by clicking the <b>Time of Day Rules</b> link under the Parental Control section of the Setup page.</p>
Session Duration	<p>1440 minutes (factory default).</p> <p>Enter the amount of time in minutes that the user will be granted Internet access beginning at the time they sign on using their user name and password.</p> <p><b>Note:</b> Set the Session Duration to 0 (zero) to prevent session timeout.</p>
Inactivity time	<p>60 minutes (factory default).</p> <p>Enter the amount of time during a user session where there is no Internet access activity, indicating that the user is no longer online. If the inactivity timer is triggered, the user session will be closed automatically. In order to regain Internet access, the user must log in again with their user name and password.</p> <p><b>Note:</b> Set the Inactivity time value to 0 (zero) to prevent timeout due to inactivity.</p>
Available Rules	<p>Lists available rules. Apply a rule by selecting it from the list and adding it to the current user profile.</p> <p><b>Note:</b> This field appears only if rules have been created. Create rules using the Parental Control Setup pages that follow next.</p>
Current Used Rules	<p>Lists rules in use for the current user profile. You can apply a maximum of four rules to each user profile.</p> <p><b>Note:</b> This field appears only when a rule is associated with a user profile.</p>

## How Do I Configure My DOCSIS Residential Gateway?

### Function Keys

The following function keys appear on the Setup Parental Control - User Setup page.

<b>Key</b>	<b>Description</b>
Add User	Adds and saves a new user to the list of user profiles
Remove User	Removes the selected user from the list of user profiles
Apply	Saves all additions, edits, and changes

## Configuring Parental Control Basic Rules

Use the Setup Parental Control - Basic Setup page to select the rules that block certain Internet content and certain websites.

**Note:** If you are not familiar with the settings detailed in this section, contact your service provider before you attempt to change any of the residential gateway default parental control settings.

Click **Basic Rules** in the Parental Control section of the Setup page to access the Setup Parental Control - Basic Setup page.

## Setup Parental Control - Basic Setup Page

The following illustration is an example of the Setup Parental Control - Basic Setup page.

**Setup**  
**Parental Control - Basic Setup**  
This page allows basic selection of rules which block certain Internet content and certain Web sites. When you change your Parental Control settings, you must click on the appropriate "Apply", "Add" or "Remove" button for your new settings to take effect. If you refresh your browser's display, you will see the currently active settings.

---

**Parental Control Activation**  
This box must be checked to turn on Parental Control  
 Enable Parental Control  
Apply

**Rule Configuration**  
Add Rule

**Rule Settings**  
1. Default Remove Rule

Keyword List	Blocked Domain List	Allowed Domain List
anonymizer	anonymizer.com	
Add Keyword	Add Domain	Add Allowed Domain
Remove Keyword	Remove Domain	Remove Allowed Domain

**Override Password**  
If you encounter a blocked website, you can override the block by entering the following password

Password	••••••
Re-Enter Password	••••••
Access Duration	30
Apply	

## Setup Parental Control - Basic Setup Page Description

This section describes the section headings and fields descriptions of the Setup Parental Control - Basic Setup page. This page allows you to create Internet access rules based on the content found in the URLs of Internet sites.

Field Name	Description
Parental Control Activation	Allows you to enable or disable parental controls. To enable parental controls, select the <b>Enable Parental Control</b> check box and click <b>Apply</b> . To disable parental controls, clear the <b>Enable Parental Control</b> check box and click <b>Apply</b> .
Rule Configuration	Allows you to add a new content rule. Enter the name of the rule and click the <b>Add Rule</b> button to add the content rule to the list. Content rules are used to restrict Internet access based on IP addresses, domains, and keywords found in the URLs of Internet sites  <b>Note:</b> It may be useful to set up your first rule as “No Rule,” without any restrictions or settings. This setting will allow you to assign “No Rule” status to users who are not subject to “content-related” access restrictions.
Rule Settings	Allows you to edit a content rule by using the drop-down menu to recall the rule to be edited  To remove a user profile, use the drop-down menu to select the rule to be removed and click on the <b>Remove Rule</b> button.
Keyword List	Allows you to create a list of keywords. Any attempt to access a URL that contains any of the keywords in this list will be blocked by the gateway
Blocked Domain List	Allows you to create a list of domains that the gateway should block access to. Any attempt to access any of the domains in this list will be blocked by the gateway
Allowed Domain List	Allows you to create a list of domains to which the gateway allows access
Override Password	Allows you to create a password to temporarily override user access restrictions to a blocked Internet site
Re-enter Password	Re-enter the same password for confirmation of the override password in the previous field
Duration	Allows you to designate an amount of time in minutes that the Override password will allow temporary access to a restricted Internet site

### Function Keys

The following function keys appear on the Setup Parental Control - Basic Setup page.

<b>Key</b>	<b>Description</b>
Add Rule	Adds and saves a new Rule to the list of content Rules
Remove Rule	Removes the selected rule from the content rule list
Add/Remove Keyword	Allows you to add new keywords to the list or to delete selected keywords from the list
Add/Remove Domain	Allows you to add new domains to the list or to delete selected domains from the list
Add/Remove Allowed Domain	Allows you to add new domains to the list or to delete selected domains from the list
Apply	Saves all additions, edits, and changes

### To use Keyword and Domain Blocking

Keyword and Domain blocking allows you to restrict access to Internet sites by blocking access to those sites based on a word or a text string contained in the URLs used to access those Internet sites.

Domain blocking allows you to restrict access to websites based on the site's domain name. The domain name is the portion of the URL that precedes the familiar .COM, .ORG, or .GOV extension.

Keyword blocking allows you to block access to Internet sites based on a Keyword or text string being present anywhere in the URL, not just in the domain name.

**Note:** The Domain blocking feature blocks access to any domain in the Domain List. It will also block domains, any portion of which contains an exact match to entries in the list.

For example, if you enter **example.com** as a domain, any site that contains "example.com" will be blocked. Generally, you do not want to include "www." in a domain name since doing so limits the blocking to only the site that matches that domain name exactly. For instance, if you enter www.example.com into the list, only the one site that matches that name exactly will be blocked. Consequently, if you do not include the "www.," then all sites within and associated with "example.com" will be blocked.

## Configuring Parental Control Time of Day Access Filters

Use the Setup Parental Control - Time of Day Access Filter page to configure web access filters to block all Internet traffic to and from specific network devices based on day of week and time of day settings that you select.

**Note:** If you are not familiar with the settings detailed in this section, contact your service provider before you attempt to change any of the residential gateway default parental control settings.

Click **Time of Day Rules** in the Parental Control section of the Setup page to access the Parental Control - Time of Day Access Filter page.

## Setup Parental Control - Time of Day Access Filter Page

The following illustration is an example of the Setup Parental Control - Time of Day Access Filter page.

**Note:** The residential gateway uses the network time of day clock that is managed by your data service provider. The time of day clock must be accurate and represent the time of day in your time zone for this feature to operate properly. Verify that the Status and Set Time pages reflect the correct time of day. If they do not reflect the correct time of day, contact your data service provider. You can also adjust your settings to account for the difference.

System Signal Status Log Setup Advanced

**Setup**  
**Parental Control - Time of Day Access Filter**  
This page allows configuration of web access filters to block all internet traffic to and from specific network devices based on time of day settings.

Add

No filters entered  Enabled Remove

Days to Block

Everyday  Sunday  Monday  Tuesday  
 Wednesday  Thursday  Friday  Saturday

Time to Block

All day

Start: 12 (hour) 00 (min) AM  
End: 12 (hour) 00 (min) AM

Apply



### Function Keys

The following function keys appear on the Setup Parental Control - Time of Day Access Filter page.

<b>Key</b>	<b>Description</b>
Add	Allows you to add a new Time of Day access filter or rule. Enter the name of the filter and click the Add key to add the filter to the list. Time of Day rules are used to restrict Internet access based on the day and time.
Remove	Removes the selected filter from the Time of Day filter list.
Apply	Saves all additions, edits, and changes.

## Configure Parental Control Event Reporting

Use the Setup Parental Control - Event Log page to view events captured by the parental control event-reporting feature.

**Note:** If you are not familiar with the settings detailed in this section, contact your service provider before you attempt to change any of the residential gateway default parental control settings.

Click **Local Log** in the Parental Control section of the Setup page to access the Setup Parental Control - Event Log page.

## Setup Parental Control - Event Log Page

The following illustration is an example of the Setup Parental Control - Event Log page.



## Setup Parental Control - Event Log Page Description

This section describes the section headings and fields descriptions of the Setup Parental Control - Event Log page. This page allows you to track, by user, any attempts made by that user to access Internet sites that are restricted.

Field Name	Description
Last Occurrence	Displays the time of the most recent attempt to access a restricted Internet site
Target	Displays the URL of the restricted site
User	Displays the user who attempted a restricted site
Source	Displays the IP address of the PC which was used when attempting to access a restricted website

## Configuring Your Wireless Access Point Parameters

Use the Setup Wireless - Basic page to configure your wireless access point (WAP) parameters, including SSID and channel number.

**Note:** If you are not familiar with the advanced settings detailed in this section, contact your service provider before you attempt to change any of the residential gateway default wireless basic settings.

Click **Basic** in the Wireless section of the Setup page to access the Setup Wireless - Basic page.

## Setup Wireless - Basic Page

The following illustration is an example of the Setup Wireless - Basic page showing the factory default settings.

The screenshot shows a navigation bar with tabs for System, Signal, Status, Log, Setup, and Advanced. The Setup tab is active. Below the navigation bar, the page title is "Setup Wireless - Basic" with a subtitle: "This page allows you to configure your wireless access point parameters, including SSID and channel number." The main content area contains the following settings:

Access Point	Enabled
Service Set Identifier (SSID)	213612
Basic Service Set Identifier (BSSID)	00:22:15:EF:69:F2
Network Type	Open
Country	Worldwide (US)
New Channel	Auto
Current Channel	6
Encryption Mode	TKIP+AES

An "Apply" button is located at the bottom of the settings area.

## Setup Wireless - Basic Page Description

This section describes the section headings and fields descriptions of the Setup Wireless - Basic page.

**Note:** If you make changes in the Setup Wireless - Basic page, click **Apply** to apply and save your wireless basic settings.

Field Name	Description
Access Point	Allows you to turn the access point on the gateway on or off
Service Set Identifier (SSID)	The name assigned to this access point <b>Note:</b> The factory default for the SSID field should contain the last 6 digits of the cable modem's MAC address as found on the label.

## How Do I Configure My DOCSIS Residential Gateway?

<b>Field Name</b>	<b>Description</b>
Basic Service Set Identifier (BSSID)	The MAC address of the access point
Network Type	Allows you to select <b>Open</b> or <b>Closed</b> for your network type
Country	Allows you to select the country in which you are using your access point
New Channel (1-11)	<p>Allows setting a communications channel for your access point</p> <p><b>Note:</b> Wireless networking channels overlap. Channels 1, 6, and 11 do not overlap with each other. For best performance, select one of these channels. If there are other access points in use in the area, select one of these channels that is farthest away from the other access points.</p> <p><b>Example:</b> If channel 8 is in use by another access point, use channel 1 for your wireless network.</p> <p><b>Note:</b> If your wireless network is not operating correctly, or if external devices are interfering with your signal, select a different channel. Use your PC wireless utility software to scan for other access points in your area.</p>
Current Channel	Present channel the WAP is using
Encryption Mode	Shows current encryption mode

## Configuring Your Wireless Network Security and Encryption Parameters

Use the Setup Wireless - Security page to configure your WAP wireless equivalent privacy (WEP) encryption keys and authentication.

**Note:** If you are not familiar with the advanced settings detailed in this section, contact your service provider before you attempt to change any of the residential gateway default wireless security settings.

Click **Security** in the Wireless section of the Setup page to access the Setup Wireless - Security page.

**Important:** Your residential gateway ships from the factory with WPA security enabled to provide you with a *basic* level of wireless network security. To gain initial access to your wireless network, select WPA security on your computer's wireless adapter and enter the WPA key to match the key setup in your gateway. The factory default WPA key in the gateway is the serial number of the device. You can continue to use this factory default key. However, to maximize your wireless security, it is highly recommended that you use something other than the factory default key.

### Using Wi-Fi Protected Setup (WPS)

Wi-Fi Protected Setup (WPS) allows you to easily attach wireless devices that also support WPS. When WPS is enabled and activated, you can attach other wireless clients with the press of a button or by entering the station PIN.

After enabling WPS, you can activate the automatic registration by clicking the **Start WPS** button in the WPS section of the Setup Wireless - Security page.

## How Do I Configure My DOCSIS Residential Gateway?

### Setup Wireless - Security Page

The following illustration is an example of the Setup Wireless - Security page.

The screenshot shows a web interface for configuring wireless security. At the top, there is a navigation bar with tabs: System, Signal, Status, Log, Setup (selected), and Advanced. Below the navigation bar, the page title is "Setup Wireless - Security" with a subtitle "This page allows you to configure your wireless privacy settings." The main content area is divided into several sections:

- Primary Network:** Includes dropdown menus for Primary Network (Enabled), WPA (Disabled), WPA-PSK (Enabled), WPA2 (Disabled), and WPA2-PSK (Disabled).
- WPA/WPA2 Encryption:** Includes a dropdown for TKIP+AES, a text field for WPA Pre-Shared Key (masked with dots), and text fields for RADIUS Server (00.00), RADIUS Port (1612), and RADIUS Key.
- Group Key Rotation Interval:** A text field set to 0.
- WPA/WPA2 Re-auth Interval:** A text field set to 3600.
- WEP Encryption:** Includes dropdown menus for WEP Encryption (Disabled), Shared Key Authentication (Optional), and 802.1x Authentication (Disabled).
- Network Keys:** Four text fields for Network Key 1, Network Key 2, Network Key 3, and Network Key 4.
- Current Network Key:** A dropdown menu set to 1.
- PassPhrase:** A text field with a "Generate WEP Keys" button next to it.
- WiFi Protected Setup (WPS):** Includes a dropdown for WPS Config (Enable) and a text field for Device Name (213612) with an "Apply" button.
- WPS Setup AP:** Includes a text field for PIN (12345670) and buttons for "Start WPS" and "Generate PIN Code".
- WPS Add Client:** Includes radio buttons for "Add a client" (Push-Button and PIN), a text field for PIN (94380507), and a "Start WPS" button.

### Setup Wireless - Security Page Description

This section describes the section headings and fields descriptions of the Setup Wireless - Security page.

**Note:** If you are not familiar with the settings detailed in this section, contact your service provider before you attempt to change any of the residential gateway default wireless security settings. If you make changes in the Setup Wireless - Security page, click **Apply** to save your wireless security settings.

Field Name	Description
Network Authentication	<p>Network Authentication allows only authorized users to gain access to your wireless network. Only users with an authorized user name, password, or pre-shared key are allowed access to the wireless network.</p> <p>Select from the following Network Authentication protocols:</p> <ul style="list-style-type: none"> <li>■ Primary Network</li> <li>■ WPA</li> <li>■ WPA-PSK</li> <li>■ WPA2</li> <li>■ WPA2-PSK</li> </ul> <p><b>Note:</b> Network Authentication restricts access to your wireless network to only authorized computers or users. Authentication does not protect the data you send over the wireless network connection. You must enable encryption to protect data that is transmitted over your wireless network.</p>
WPA/WPA2 Encryption	<p>Allows you to select a WPA/WPA2 security method. The factory default security is WPA-PSK.</p> <ul style="list-style-type: none"> <li>■ TKIP (Temporal Key Integrity Protocol) data encryption is automatically enabled when WPA and WPA-PSK network authentication is enabled. (factory default)</li> <li>■ AES (Advanced Encryption Standard)</li> <li>■ TKIP-AES</li> </ul> <p><b>Note:</b> Select TKIP-AES only if your client adapter supports this mode. Contact your service provider for assistance.</p>

## How Do I Configure My DOCSIS Residential Gateway?

Field Name	Description
WPA Pre-Shared Key	<p>Allows you to set a WPA Pre-Shared key. Enter a text string in this field. The text string or phrase is used to generate a unique set of encryption keys for your network. Use this string to set up wireless devices in your network.</p> <p>The factory default security key is the 9-digit serial number of the gateway. For example: 20167792. See <i>How Do I Subscribe to High-Speed Internet Service?</i> (on page 19) for the location of the serial number on the label.</p> <ul style="list-style-type: none"><li>■ The PSK can be either a text string or a 64 character hexadecimal number.</li><li>■ The text string must be an ASCII character string with a minimum of 8 characters but no more than 63.</li></ul> <p><b>Note:</b> Not all wireless adapter devices support PSK. For these devices, you must enter the encryption keys exactly as they appear in the in wireless gateway fields in the preceding illustration of the Setup Wireless Security page.</p>
RADIUS Server	<p>Allows you to enter the IP address of the RADIUS server used for authentication and encryption key derivation.</p> <ul style="list-style-type: none"><li>■ This field is used with 802.1x and WPA Network Authentication.</li><li>■ The factory default for this field is 0.0.0.0.</li></ul>
RADIUS Port	<p>Determines the port number of the RADIUS server. The port number is usually 1812 (factory default) or 1645, depending on the server used.</p> <p>This field is used with 802.1x and WPA Network Authentication.</p>
RADIUS Key	<p>Allows you to set the Shared Secret key for your RADIUS connection.</p> <ul style="list-style-type: none"><li>■ The factory default for this field is empty.</li><li>■ This field is used with 802.1x and WPA Network Authentication.</li></ul>
Group Key Rotation Interval	<p>Allows you to set the WPA Group Key Rotation Interval in seconds. This only applies when WPA or WPA2 Network Authentication is enabled.</p> <p>Set this value to 0 (factory default) to disable periodic rekeying. The valid range is 1 to 4,294,967,295 seconds.</p>
WPA/WPA2 Re-auth Interval	<p>Allows you to set the WPA/WPA2 Re-authorization Interval in seconds. This only applies when WPA/WPA2 Network Authentication is enabled.</p> <p>Set this value to 0 (factory default) to disable periodic rekeying. The valid range is 1 to 4,294,967,295 seconds.</p>



Field Name	Description
WEP Encryption	<p data-bbox="639 264 1295 327">Allows you to enable data encryption to help secure the data that is sent over your wireless network.</p> <p data-bbox="639 348 786 373">WEP 128-bit</p> <ul data-bbox="639 401 1295 604" style="list-style-type: none"> <li data-bbox="639 401 1295 491">■ 128-bit or-64 bit static key data encryption can be selected when the network is configured to have no authentication.</li> <li data-bbox="639 512 1295 604">■ 128-bit static key data encryption is automatically selected when 802.1x network authentication is enabled.</li> </ul> <p data-bbox="639 625 716 651"><b>Notes:</b></p> <ul data-bbox="639 678 1334 968" style="list-style-type: none"> <li data-bbox="639 678 1334 806">■ Static key authentication uses one of the four encryption keys, as defined below, to encrypt your data. You must manually change keys. The keys do not change or rotate automatically as they do with TKIP.</li> <li data-bbox="639 827 1295 890">■ 64-bit and 40-bit encryption are two different names for the same encryption</li> <li data-bbox="639 911 1328 968">■ 128-bit and 104-bit encryption are two different names for the same encryption</li> </ul>
Shared Key Authentication	<p data-bbox="639 989 1321 1115">Allows you to determine is Shared Key Authentication is used in the network. Shared Key Authentication can be used when there is no other network authentication in the network.</p> <ul data-bbox="639 1142 1321 1325" style="list-style-type: none"> <li data-bbox="639 1142 1321 1247">■ Optional - (factory default) Wireless clients can associate with the wireless access point without authentication.</li> <li data-bbox="639 1268 1321 1325">■ Required - Only wireless clients with a valid network key are allowed to associate with the access point.</li> </ul>
802.1x Authentication	<p data-bbox="639 1346 1284 1409">Allows you to use 802.1x authentication with WEP encryption (similar to when WPA or WPA2 is enabled)</p>

## How Do I Configure My DOCSIS Residential Gateway?

Field Name	Description
Network Keys 1 through 4 64 bit keys	<p>Select these keys for use with Encryption Mode set to 64-bit encryption. Enter 5-byte values for a Key. You do not have to set all four Keys. Only one Key is used for a home network. Each value is represented in hexadecimal. Use only these numbers or letters: 0, 1, 2, 3, 4, 5, 6, 7, 8, 9, a, b, c, d, e, and f to set up your encryption keys.</p> <p><b>Note:</b> It is generally a good practice to use only lowercase letters when entering WEP encryption keys. Uppercase letters can sometimes be confused with numbers. For example, the uppercase letter “B” is often mistaken for the number “8.” Using lowercase characters minimizes the risk of confusing characters when copying keys from one device to another. Uppercase characters will automatically be converted to lowercase when the key or keys are applied and saved to memory.</p> <p>Use two numbers or letters in each box. Record your Key values. You will need these Key values when you set up your client wireless adapter. The Key values in each wireless network device must match.</p>
<p>or</p>	
Network Keys 1 through 4 128 bit keys	<p>Select these keys for use with Encryption Mode set to 128-bit encryption. Enter 13-byte values for a Key. You do not have to set all four Keys. Usually only one is needed for a home network. Each value is represented in hexadecimal. Use only these numbers or letters: 0, 1, 2, 3, 4, 5, 6, 7, 8, 9, a, b, c, d, e, and f to set up your encryption keys.</p> <p>It is generally a good practice to use only lowercase letters when entering WEP encryption keys. Uppercase letters can sometimes be confused with numbers. For example, the uppercase letter “B” is often mistaken for the number “8.” Using lowercase characters minimizes the risk of confusing characters when copying keys from one device to another. Uppercase characters will automatically be converted to lowercase when the key or keys are applied and saved to memory.</p> <p>Use two numbers or letters in each box. Record your Key values. You will need these Key values when you set up your client wireless adapter. The Key values in each wireless network device <i>must</i> match.</p>

Field Name	Description
Current Network Key	<p>Allows you to select which of the four 64-bit or 128-bit keys to use to encrypt your data when you are using encryption that requires the manual entry of an encryption key. Only one WEP key is in use at a time. You must manually change keys. They do not change automatically.</p> <p><b>Notes:</b></p> <ul style="list-style-type: none"> <li>■ 64-bit and 40-bit encryption are two different names for the same encryption</li> <li>■ 128-bit and 104-bit encryption are two different names for the same encryption</li> </ul>

PassPhrase	<p>Automatically generates WEP encryption keys required to communicate with the network.</p> <p>Although not required for WEP operation, use of a PassPhrase can simplify the configuration and setup of each of your client wireless adapters.</p> <p>Using a PassPhrase eliminates the need to manual enter lengthy encryption keys and reduces the chance of error associated with entering entry of large numbers.</p> <p><b>Important:</b> Click <b>Generate WEP Keys</b> when complete.</p>
------------	---

### Wi-Fi Protected Setup (WPS) Section

The selections available in this section allow you to configure WPS.

Field Name	Description
WPS Config	Allows you to enable or disable WPS
Device Name	Allows you to enter your device name

### WPS Setup AP Section

The selections available in this section allow you to use PIN-protected security.

Field Name	Description
PIN	The personal identification number (PIN) of a device trying to connect
Status	Displays WPS status

## How Do I Configure My DOCSIS Residential Gateway?

### WPS Add Client Section

The selections available in this section allow you to add a WPS client.

<b>Field Name</b>	<b>Description</b>
Add a Client	Allows you to select your WPS method (push button or PIN)
WPS Status	Displays WPS status

### Function Keys

<b>Keys</b>	<b>Description</b>
Generate WEP Keys	Automatically generates four WEP keys based on the PassPhrase entry. <b>Notes:</b> <ul style="list-style-type: none"><li>■ For 64-bit WEP, four unique 64-bit WEP keys will be generated</li><li>■ For 128-bit WEP, only one 128-bit WEP key will be generated. The same key will be entered into all four key locations.</li></ul>
Apply	Saves all additions, edits, and changes for the associated section
Start WPS	Starts WPS after you select your WPS Method
Generate PIN Code	Automatically generates a PIN code

## Configuring Wireless Data Rates and Wi-Fi Thresholds

Use the Setup Wireless - Advanced page to configure your WAP data rates and wireless fidelity (Wi-Fi) thresholds.

**Note:** If you are not familiar with the advanced settings detailed in this section, contact your service provider before you attempt to change any of the residential gateway default wireless advanced settings.

Click **Advanced** in the Wireless section of the Setup page to access the Setup Wireless - Advanced page.

## Setup Wireless - Advanced Page Example

The following illustration is an example of the Setup Wireless - Advanced page.

**Note:** We recommend that you do not change the default wireless settings that are shown in the preceding illustration unless you are instructed to do so by your service provider.

The screenshot shows a navigation bar with tabs for System, Signal, Status, Log, Setup, and Advanced. The 'Advanced' tab is selected. Below the navigation bar, the page title is 'Setup Wireless - Advanced' with a subtitle: 'This page allows you to configure your wireless access point data rates and WiFi thresholds.' The main configuration area contains the following settings:

54g™ Network Mode	54g LRS
Basic Rate Set	Default
54g™ Protection	Auto
XPress™ Technology	Disabled
Afterburner™ Technology	Disabled
Rate	Auto
Output Power	100%
Beacon Interval	100 ms (1-65535)
DTIM Interval	1 ms (1-255)
Fragmentation Threshold	2346 bytes (256-2346)
RTS Threshold	2347 (0-2347)
Short Retry Limit	7 (1-255)
Long Retry Limit	4 (1-255)

An 'Apply' button is located at the bottom of the configuration area.

## Setup Wireless - Advanced Page Description

This section describes the section headings and fields descriptions of the Setup Wireless - Advanced page.

**Note:** If you make changes in the Setup Wireless - Advanced page, click **Apply** to apply and save your wireless advanced settings.

Field Name	Description
54g Network Mode	<p>Allows you to optimize the performance of your wireless network using one of the following options:</p> <ul style="list-style-type: none"> <li>■ Max compatibility (factory default) Allows the access point to interoperate with both 802.11b and 802.11g wireless client devices and minimizes interference with nearby 802.11b wireless networks.</li> <li>■ 54g Only The wireless access point will only accept 802.11g wireless clients.</li> <li>■ 54g LRS Allows clients that are not fully compatible with 802.11g to operate with your wireless access point. <b>Note:</b> Switching to 54g-LRS mode can impact wireless performance. It is not recommended that you use this mode unless necessary for the compatibility described above.</li> <li>■ Max Performance Maximum throughput. In this mode, the wireless access point accepts only 802.11g wireless clients. Setting the device in this mode may degrade the operation of near by 802.11b wireless networks.</li> </ul>
Basic Rate Set	Allows you to select the Basic Rate Set
54g Protection	<p>Allows you to prioritize 802.11g communication when there is a mix of 802.11b and 802.11g devices in the wireless network using one of the following options:</p> <ul style="list-style-type: none"> <li>■ Auto (factory default) Maximize 802.11g performance in networks with a mix of 802.11b and 802.11g wireless client devices.</li> <li>■ Off Maximum performance. Networks with 802.11g-only wireless client devices.</li> </ul>
Xpress Technology	Allows you to enable or disable Xpress Technology

Field Name	Description
Afterburner Technology	Allows you to enable or disable Afterburner Technology
Rate	<p>Allows you to fix the data rate for wireless connections. The following data rates are available:</p> <p>Auto (factory default), 1 Mbps, 2 Mbps, 5.5 Mbps, 6 Mbps, 9 Mbps, 11 Mbps, 12 Mbps, 18 Mbps, 24 Mbps, 36 Mbps, 48 Mbps, 54 Mbps</p> <p><b>Note:</b> In the automatic mode, data rate is a function of signal strength and signal quality.</p>
Output Power	<p>Allows you to adjust the relative output power of your gateway wireless transmitter. The following settings are available:</p> <p>100% (factory default), 75%, 50%, and 25%</p>
Beacon Interval	Displays the time interval that the WAP uses to announce itself to remote devices. The Beacon Interval should be left at 100ms for compliance with most client cards. The Beacon Interval specifies how often packets are sent by the Access Point (AP) to synchronize a wireless network and its clients
DTIM Interval	Displays the time interval between Broadcasts/Multicast transmissions. The DTIM (Delivery Traffic Indication Message) Interval is a countdown informing the wireless clients of the next window for listening to broadcast and multicast messages. When the AP has buffered broadcast or multicast messages for associated clients, it sends the next DTIM with a DTIM Interval value. AP clients hear the beacons and awaken to receive the broadcast and multicast messages. The DTIM Interval should be left at 3 ms for compliance with most client cards
Fragmentation Threshold	Allows you to set the fragmentation threshold. This threshold should be set equivalent to the maximum Ethernet frame size allowable on the link including overhead (1536 bytes). Lesser settings can damage data throughput as large frames could be fragmented or collisions could occur. The factory default is 2346
RTS Threshold	Determines at what packet size beyond which the ready to send/clear to send (RTS/CTS) mechanism is invoked. The factory default is 2347
Short Retry Limit	The number of times the gateway transmits an unacknowledged unicast frame that is shorter than the RTS threshold before discarding the frame. The factory default is 7

## How Do I Configure My DOCSIS Residential Gateway?

<b>Field Name</b>	<b>Description</b>
Short Retry Limit	The number of times the gateway transmits an unacknowledged unicast frame that is longer than the RTS threshold before discarding the frame. The factory default is 4



## Configuring Wireless Access Point Access Control

Use the Setup Wireless - Access Control page to configure your wireless access point access control.

**Note:** If you are not familiar with the advanced settings detailed in this section, contact your service provider before you attempt to change any of the residential gateway default wireless advanced settings.

Click **Access Control** in the Wireless section of the Setup page to access the Setup Wireless - Access Control page.

## Setup Wireless Access Control Page

The following illustration is an example of the Setup Wireless - Access Control page.

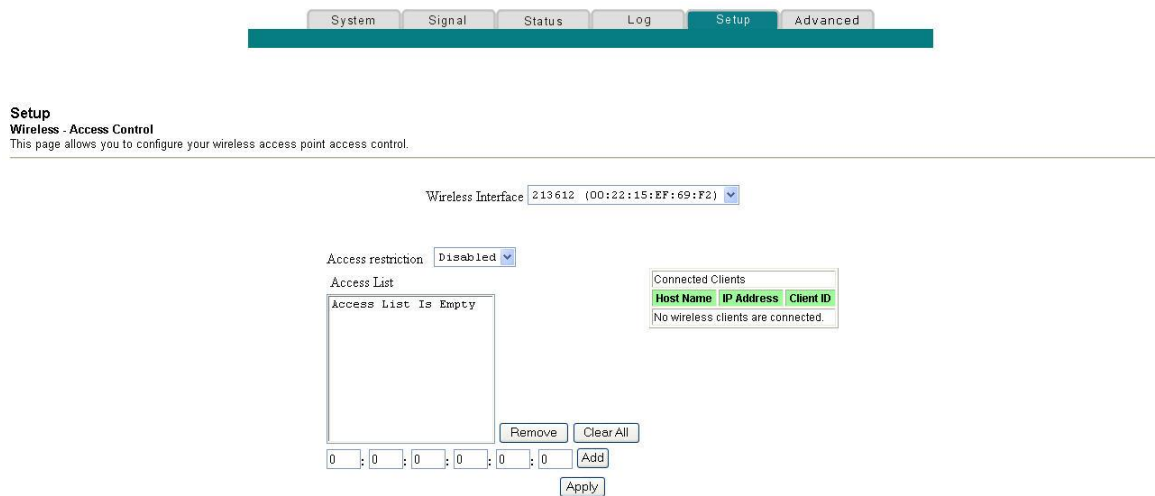

## Setup Wireless - Access Control Page Description

This section describes the section headings and field descriptions of the Setup Wireless - Access Control page.

Field Name	Description
Access restriction	<p>When encryption is enabled, this selection allows you to choose one of the following options from the drop-down list:</p> <ul style="list-style-type: none"> <li>■ Disable (factory default)–No access restrictions based on MAC address of wireless access devices</li> <li>■ Allow–Allows wireless access to only the MAC addresses listed in the Access List</li> <li>■ Deny–Denies wireless access to only the MAC address listed in the Access List</li> </ul>

## How Do I Configure My DOCSIS Residential Gateway?

<b>Field Name</b>	<b>Description</b>
Closed Network	Allows you to disable or enable the network to access by wireless clients. When ON is selected, the access point does not broadcast the SSID. The client device must be configured manually with the SSID and the MAC address of the access point in order to access with wireless network.
Access List	Displays the MAC address of the clients that are subject to wireless access control
Connected Clients	Displays the Host Name, IP Address, and Client ID of wireless clients that are connected to (associated with) the gateway modem

### Function Keys

The following function keys appear on the Setup Wireless - Access Control page.

<b>Key</b>	<b>Description</b>
Apply	Applies and saves the values you enter into the fields without closing the screen
Clear All	Clears the Access List
Remove	Removes entries from the Access List
Add	Adds a client to the Access List using the MAC address of the client

## Configuring Remote Bridges

Use the Setup Wireless - Bridging page to configure your configure remote bridges.

**Note:** If you are not familiar with the advanced settings detailed in this section, contact your service provider before you attempt to change any of the wireless home gateway default wireless advanced settings.

Click **Bridging** in the Wireless section of the Setup page to access the Setup Wireless - Bridging page.

## Setup Wireless Access Control Page Example

The following illustration is an example of the Setup Wireless - Bridging page.

System Signal Status Log Setup Advanced

**Setup**  
**Wireless - Bridging**  
This page allows configuration of WDS features.

Wireless Bridging Disabled

Remote Bridges

Apply

## Setup Wireless - Bridging Page Description

The Setup Wireless - Bridging page allows you to Enable or Disable wireless bridging and to add remote bridges. Click **Apply** to apply and save your new settings.

## How Do I Troubleshoot My Internet Service Installation?

### I cannot connect to the Internet

- Verify that the plug to your residential gateway AC power is properly inserted into an electrical outlet.
- Verify that your residential gateway AC power cord is not plugged into an electrical outlet that is controlled by a wall switch. If a wall switch controls the electrical outlet, make sure the switch is in the **ON** position.
- Verify that the **POWER** and **CABLE** indicator lights on the front panel of your residential gateway are illuminated.
- Verify that the indicator lights on your router or other network connection equipment are illuminated
- Verify that all cables are properly connected, and that you are using the correct cables.
- Verify that your cable service is active and that it supports two-way service.
- Verify that TCP/IP is properly installed and configured on all devices if you are using the Ethernet connections.
- Verify that you have called your service provider and given them the serial number and MAC address of your residential gateway.
- If you are using a cable signal splitter so that you can connect the cable signal to other devices, remove the splitter and reconnect the cable so that the residential gateway is connected directly to the main cable input. If the residential gateway now functions properly, the cable signal splitter may be defective and may need to be replaced.
- For best performance over an Ethernet connect, your PC should be equipped with a 10/100BASE-T network interface card.

### My residential gateway does not recognize the cable network

- The residential gateway works with a standard, 75-ohm, RF coaxial cable. If you are using a different cable, your residential gateway will not function properly. Contact your service provider to determine if you are using the correct cable.
- You may need to renew the IP address on your PC. Refer to How Do I Renew the IP Address on My PC?, for instructions on how to renew the IP address for your particular operating system.

## Frequently Asked Questions

### **Q. How many Ethernet network devices can I connect?**

A. Your residential gateway uses has an integrated Dynamic Host Configuration Protocol (DHCP) to automatically issue IP addresses to devices as they are connected to your home network.

The theoretical maximum number of devices supported by your residential gateway is 253. These addresses are assigned to all connected devices, wired (Ethernet) as well as wireless. Typically, the number of devices connected should be a much lower number.

The residential gateway can support several Ethernet devices by connecting them directly to the Ethernet ports on the back panel or using external multi-port Ethernet switches (purchased separately).

Contact your service provider for more information on the maximum number of Ethernet network devices to connect to your residential gateway to maintain optimal network performance.

### **Q. What are the wiring requirements for Ethernet networking?**

A. A number of factors can impact the practical limit of the network. Although the residential gateway is designed to support several Ethernet network devices, it is important to view the characteristics of the entire network and not just each individual node.

The theoretical distance between two 10/100BASE-T CAT-5 Ethernet hubs is 382 feet (100 meters). Contact your service provider or consult the documentation for your Ethernet network devices for more information.

**Note:** We recommend that you use CAT-5 Ethernet cables.

### **Q. Where is the best location for my Ethernet network devices?**

A. You should work with your service provider to choose the best location for your Ethernet network devices. Consider these recommendations:

- Location of two-way cable outlets
- Distance of the Ethernet network devices from the residential gateway
- Location of computers and other equipment from AC power outlets
- Ease of running Ethernet cable to the Ethernet network devices

## Frequently Asked Questions

### **Q. What are the requirements for wireless networking?**

A. It is important to view the characteristics of the entire network and not just each individual node. The theoretical distance between wireless network devices is 100 feet inside of a building, and 300 feet outdoors.

A number of factors can impact the practical limit of the network. Contact your service provider or consult the documentation for your wireless network devices for more information.

### **Q. Where is the best location for my wireless network devices?**

A. You can use a large variety of wireless network devices with your residential gateway. These include computers, PDAs, etc. On the wireless network, all devices impact the characteristics of the network, because each device transmits a wireless signal.

Contact your service provider or consult the documentation for your wireless network device for more information on selecting the appropriate wireless network devices for your home or office network.

You should work with your service provider to choose the best location for your wireless network devices. Consider these recommendations:

- Distance from the residential gateway to the wireless network devices.
- Do not place the residential gateway near metallic surfaces that may block the wireless communications path. Wireless communication is “line-of-sight” through non-metallic walls. However, the more structures (walls) the signal must pass through, the weaker the received signal.
- Do not place wireless network devices near a microwave oven. When operating, microwave ovens can interfere with wireless transmissions.
- Do not place your wireless network devices near 2.4 GHz wireless telephones because these telephones may also cause interference with your wireless network.

**Q. How do I renew the IP address on my PC?**

A. If your PC cannot access the Internet after the residential gateway is online, it is possible that your PC did not renew its IP address. Follow the appropriate instructions in this section for your operating system to renew the IP address on your PC.

**Renewing the IP Address on Windows NT, 2000, or XP Systems**

- 1 Click **Start**, and then click **Run**. The Run window opens.
- 2 Type **cmd** in the Open field and click **OK**. A window with a command prompt opens.
- 3 Type **ipconfig/release** at the C:/ prompt and press **Enter**. The system releases the IP address.
- 4 Type **ipconfig/renew** at the C:/ prompt and press **Enter**. The system displays a new IP address.
- 5 Click the **X** in the upper-right corner of the window to close the Command Prompt window. You have completed this procedure.

**Note:** If you cannot access the Internet, contact your service provider for further assistance.

**Renewing the IP address on Windows 95, 98, 98SE, and ME Systems**

- 1 Click **Start**, and then click **Run** to open the Run window.
- 2 Type **wiipcfg** in the Open field, and click **OK** to execute the winipcfg command. The IP Configuration window opens.
- 3 Click the down arrow to the right of the top field, and select the Ethernet adapter that is installed on your PC. The IP Configuration window displays the Ethernet adapter information.
- 4 Click **Release**, and then click **Renew**. The IP Configuration window displays a new IP address.
- 5 Click **OK** to close the IP Configuration window, you have completed this procedure.

**Note:** If you cannot access the Internet, contact your service provider for further assistance.

## Frequently Asked Questions

### Q. How do I configure TCP/IP protocol?

A. TCP/IP protocol in a Microsoft Windows environment is different for each operating system. Follow the appropriate instructions in this section for your operating system.

#### Configuring TCP/IP on Windows XP Systems

- 1 Click **Start**, and depending on your Start menu setup, choose one of the following options:
  - If you are using the Windows XP Default Start Menu, select **Connect to**, choose **Show all connections**, and then go to step 2.
  - If you are using the Windows XP Classic Start Menu, select **Settings**, choose **Network Connections**. Double-click the **Local Area Connection** icon in the LAN or High-Speed Internet section of the Network Connections window.
- 2 When the Network Connections window opens, right click on **Local Area Connection**, left click on **Properties** from the menu to open the Properties dialogue box.
- 3 Locate a white box titled "This connection uses the following items:". Use the down arrow on the right side of the box to scroll down until you see Internet Protocol (TCP/IP). Select **Internet Protocol (TCP/IP)**, then click the **Properties** button below the white box on the right hand side.
- 4 Select both **Obtain an IP address automatically** and **Obtain DNS server address automatically** in the Internet Protocol (TCP/IP) Properties window, and then click **OK**.
- 5 Click **OK** at the bottom of the properties box to close the box. At this point, your PC will automatically request and receive an IP address from that gateway. Once the address is received your PC will have Internet access.
- 6 In the event your PC does not automatically request an IP address after completing the above steps, it is recommended that you select Windows **Start** button, then shutdown and restart Windows.
- 7 If you cannot access the Internet, go to *Having Difficulty?* (on page 104). If you still cannot access the Internet, contact your service provider for further assistance.

#### Configuring TCP/IP on Windows 2000 Systems

- 1 Click **Start**, select **Settings**, and choose **Network and Dial-up Connections**.
- 2 Double-click the **Local Area Connection** icon in the Network and Dial-up Connections window.
- 3 Click **Properties** in the Local Area Connection Status window.
- 4 Click **Internet Protocol (TCP/IP)** in the Local Area Connection Properties window, and then click **Properties**.



- 5 Select both **Obtain an IP address automatically** and **Obtain DNS server address automatically** in the Internet Protocol (TCP/IP) Properties window, and then click **OK**.
- 6 Click **Yes** to restart your computer when the Local Network window opens. The computer restarts. The TCP/IP protocol is now configured on your PC, and your Ethernet devices are ready for use.
- 7 Try to access the Internet. If you cannot access the Internet, go to *Having Difficulty?* (on page 104). If you still cannot access the Internet, contact your service provider for further assistance.

#### Configuring TCP/IP on Windows 95, 98, 98SE, or ME Systems

- 1 Click **Start**, select **Settings**, and choose **Control Panel**.
- 2 Double-click the **Network** icon in the Control Panel window.
- 3 Read the list of installed network components under the **Configuration** tab to verify that your PC contains the TCP/IP protocol/Ethernet adapter.
- 4 Is TCP/IP protocol listed in the installed network components list?
  - If **yes**, go to step 7.
  - If **no**, click **Add**, click **Protocol**, click **Add**, and then go to step 5.
- 5 Click **Microsoft** in the Manufacturers list.
- 6 Click **TCP/IP** in the Network Protocols list, and then click **OK**.
- 7 Click the **TCP/IP Ethernet Adapter** protocol, and then choose **Properties**.
- 8 Click the **IP Address** tab, and then select **Obtain an IP address automatically**.
- 9 Click the **Gateway** tab and verify that these fields are empty. If they are not empty, highlight and delete all information from the fields.
- 10 Click the **DNS Configuration** tab, and then select **Disable DNS**.
- 11 Click **OK**.
- 12 Click **OK** when the system finishes copying the files, and then close all networking windows.
- 13 Click **YES** to restart your computer when the System Settings Change dialog box opens. The computer restarts. The TCP/IP protocol is now configured on your PC, and your Ethernet devices are ready for use.
- 14 Try to access the Internet. If you cannot access the Internet, go to *Having Difficulty?* (on page 104). If you still cannot access the Internet, contact your service provider for further assistance.

#### Configuring TCP/IP on Macintosh Systems

- 1 Click the **Apple** icon in the upper-left corner of the Finder. Scroll down to **Control Panels**, and then click **TCP/IP**.
- 2 Click **Edit** on the Finder at the top of the screen. Scroll down to the bottom of the menu, and then click **User Mode**.
- 3 Click **Advanced** in the User Mode window, and then click **OK**.

## Frequently Asked Questions

- 4 Click the Up/Down selector arrows located to the right of the Connect Via section of the TCP/IP window, and then click **Using DHCP Server**.
- 5 Click **Options** in the TCP/IP window, and then click **Active** in the TCP/IP Options window.  
**Note:** Make sure that the **Load only when needed option** is *unchecked*.
- 6 Verify that the **Use 802.3** option located in the upper-right corner of the TCP/IP window is unchecked. If there is a check mark in the option, uncheck the option, and then click **Info** in the lower-left corner.
- 7 Is there a Hardware Address listed in this window?
  - If **yes**, click **OK**. To close the TCP/IP Control Panel window, click **File**, and then scroll down to click **Close**. You have completed this procedure.
  - If **no**, you must power off your Macintosh.
- 8 With the power off, simultaneously press and hold down the **Command (Apple)**, **Option**, **P**, and **R** keys on your keyboard. Keeping those keys pressed down, power on your Macintosh but do not release these keys until you hear the Apple chime at least three times, then release the keys and let the computer restart.
- 9 When your computer fully reboots, repeat steps 1 through 7 to verify that all TCP/IP settings are correct. If your computer still does not have a Hardware Address, contact your authorized Apple dealer or Apple technical support center for further assistance.

### **Q. What if I don't subscribe to cable TV?**

A. If cable TV is available in your area, data service may be made available with or without subscribing to cable TV service. Contact your local service provider for complete information on cable services, including high-speed Internet access.

### **Q. How do I arrange for installation?**

A. Call your cable telephony service provider to inquire about professional installation. A professional installation ensures proper cable connection to the modem and to your PC, and it ensures the proper configuration of all hardware and software settings. Contact your cable telephony service provider for more information about installation.

### **Q. How does the residential gateway connect to my computer?**

A. The residential gateway connects to the 10/100BASE-T Ethernet port on your PC. If your PC is not equipped with an Ethernet interface, an Ethernet card is available from your local PC or office supply retailer, or from your service provider.

### **Q. After my residential gateway is connected, how do I access the Internet?**

A. Your local service provider becomes your Internet Service Provider (ISP). They offer a wide range of services including e-mail, chat, news, and information services. Your service provider will provide the software you will need.

**Q. Can I watch TV and surf the Internet at the same time?**

A. Absolutely! If you subscribe to cable television service, you can watch TV and use your residential gateway at the same time by connecting your TV and your residential gateway to the cable network using an optional cable signal splitter.

**Q. Can I run more than one device on the modem?**

A. Yes. A single residential gateway will theoretically support up to 253 Ethernet devices utilizing user-supplied Ethernet hubs or routers that you can purchase at your local PC or office supply retailer.

## Having Difficulty?

### Common Troubleshooting Issues

#### I don't understand the front panel status indicators

See *Front Panel LED Status Indicator Functions* (on page 106), for more detailed information on front panel LED status indicator operation and function.

#### The modem does not register an Ethernet connection

- Verify that your computer has an Ethernet card and that the Ethernet driver software is properly installed. If you purchase and install an Ethernet card, follow the installation instructions very carefully.
- Verify the status of the front panel LED status indicators.

#### The modem does not register an Ethernet connection after connecting to a hub

If you are connecting multiple PCs to the residential gateway, you should first connect the modem to the uplink port of the hub using the correct crossover cable. The LINK LED of the hub will illuminate continuously.

#### The modem does not register a cable connection

The modem works with a standard 75-ohm RF coaxial cable. If you are using a different cable, your residential gateway will not function properly. Contact your service provider to determine whether you are using the correct cable.

Verify that you have followed the procedures in *How Do I Troubleshoot My Internet Service Installation?* (on page 96).

## Tips for Improved Performance

### Check and Correct

If your residential gateway does not perform as expected, the following tips may help. If you need further assistance, contact your service provider.

- Verify that the plug to your residential gateway AC power is properly inserted into an electrical outlet.
- Verify that your residential gateway AC power cord is not plugged into an electrical outlet that is controlled by a wall switch. If a wall switch controls the electrical outlet, make sure the switch is in the **ON** position.
- Verify that the **POWER** and **ONLINE** LED status indicators on the front panel of your residential gateway are illuminated.
- Verify that your cable service is active and that it supports two-way service.
- Verify that all cables are properly connected, and that you are using the correct cables.
- Verify that your TCP/IP is properly installed and configured if you are using the Ethernet connection.
- Verify that you have called your service provider and given them the serial number and MAC address of your residential gateway.
- If you are using a cable signal splitter so that you can connect the residential gateway to other devices, remove the splitter and reconnect the cables so that the residential gateway is connected directly to the cable input. If the residential gateway now functions properly, the cable signal splitter may be defective and may need to be replaced.
- For best performance over an Ethernet connection, your PC should be equipped with a 10/100BASE-T network interface card.

## Front Panel LED Status Indicator Functions

### Initial Power Up, Calibration, and Registration (AC Power applied)

The following chart illustrates the sequence of steps and the corresponding appearance of the residential gateway front panel LED status indicators during power up, calibration, and registration on the network when AC power is applied to the residential gateway. Use this chart to troubleshoot the power up, calibration, and registration process of your residential gateway.

**Note:** After the residential gateway completes registration, the modem proceeds immediately to Normal Operations. See *Normal Operations (AC Power applied)* (on page 107).

Front Panel LED Status Indicators During Initial Power Up, Calibration, and Registration							
High Speed Data Registration							
Step:		1	2	3	4	5	6
Front Panel Indicator		Self Test	Downstream Scan	Downstream Signal Lock	Ranging	Requesting IP Address	Request High Speed Data Provisioning File
1	POWER	On	On	On	On	On	On
2	DS	On	Blinking	On	On	On	On
3	US	On	Off	Off	Blinking	On	On
4	ONLINE	On	Off	Off	Off	Off	Blinking
5	LAN1-LAN4	On	On or Blinking	On or Blinking	On or Blinking	On or Blinking	On or Blinking
6	WIRELESS	Off	On or Blinking	On or Blinking	On or Blinking	On or Blinking	On or Blinking

## Normal Operations (AC Power applied)

The following chart illustrates the appearance of the residential gateway front panel LED status indicators during normal operations when AC power is applied to the gateway.

Front Panel LED Status Indicators During Normal Conditions		
Front Panel Indicator		Normal Operations
1	POWER	On
2	DS	On
3	US	On
4	ONLINE	On
5	LAN1-LAN4	<ul style="list-style-type: none"> <li>■ On - When a single device is connected to the Ethernet port and no data is being sent to or from the modem</li> <li>■ Blinks - When only one Ethernet device is connected and data is being transferred between the consumer premise equipment (CPE) and the wireless home gateway</li> <li>■ Off - When no devices are connected to the Ethernet ports</li> </ul>
6	WIRELESS	<ul style="list-style-type: none"> <li>■ On - When the wireless access point is enabled and operational</li> <li>■ Blinks - When data is being transferred between the CPE and the wireless home gateway</li> <li>■ Off - When the wireless access point is disabled by the user</li> </ul>

## Special Conditions

The following chart describes the appearance of the cable modem front panel LED status indicators during special conditions to show when you have been denied network access or when the modem is operating on battery power.

<b>Front Panel LED Status Indicators During Special Conditions</b>		
<b>Front Panel Indicator</b>		<b>Network Access Denied</b>
1	POWER	Slow Blinking 1 time per second
2	DS	Slow Blinking 1 time per second
3	US	Slow Blinking 1 time per second
4	ONLINE	Slow Blinking 1 time per second
5	LAN1-LAN4	Slow Blinking 1 time per second
6	WIRELESS	On



## For Information

### **If You Have Questions**

If you have technical questions, contact your local service provider.

## Notices

### Trademarks

Cisco and the Cisco logo are trademarks or registered trademarks of Cisco and/or its affiliates in the U.S. and other countries. A listing of Cisco's trademarks can be found at [www.cisco.com/go/trademarks](http://www.cisco.com/go/trademarks).

DOCSIS is a registered trademark of Cable Television Laboratories, Inc. EuroDOCSIS, PacketCable and EuroPacketCable are trademarks of Cable Television Laboratories, Inc.

Other third party trademarks mentioned are the property of their respective owners.

The use of the word partner does not imply a partnership relationship between Cisco and any other company. (1009R)

### Publication Disclaimer

Cisco Systems, Inc. assumes no responsibility for errors or omissions that may appear in this publication. We reserve the right to change this publication at any time without notice. This document is not to be construed as conferring by implication, estoppel, or otherwise any license or right under any copyright or patent, whether or not the use of any information in this document employs an invention claimed in any existing or later issued patent.

### Copyright

© 2008, 2009, 2012 Cisco and/or its affiliates. All rights reserved. Printed in the United States of America.

Information in this publication is subject to change without notice. No part of this publication may be reproduced or transmitted in any form, by photocopy, microfilm, xerography, or any other means, or incorporated into any information retrieval system, electronic or mechanical, for any purpose, without the express permission of Cisco Systems, Inc.

### Software and Firmware Use

The software described in this document is protected by copyright law and furnished to you under a license agreement. You may only use or copy this software in accordance with the terms of your license agreement.

The firmware in this equipment is protected by copyright law. You may only use the firmware in the equipment in which it is provided. Any reproduction or distribution of this firmware, or any portion of it, without our express written consent is prohibited.

## Third Party Software License Notices For Cisco Model DPC/EPC2325 DOCSIS Residential Gateway with Wireless Access

### Notices

The following notices pertain to third party licenses applicable to this product.

### Broadcom

This product incorporates copyright protection technology that is protected by U.S. patents and other intellectual property rights. Use of this copyright protection technology must be authorized by Broadcom, and is intended for home and other limited viewing uses only unless otherwise authorized by Broadcom. Reverse engineering or disassembly is prohibited.

### Win32 IPSEC Layer from SSH

(See <http://www.ssh.com/>)

For testing and evaluation purposes, CablexChange software contains an IPSEC capable Kerberized Call Agent. The Call Agent uses Win32 based IPSEC software provided by "SSH Communication Security Corporation".

© 1997 - 2002 SSH Communication Security Corp. This software is protected by international copyright laws. All rights reserved. SSH ® is a registered trademark of SSH Communication Security Corp. in the United States and in certain other jurisdictions. SSH2, the SSH logo, SSH IPSEC Express, SSH Certifier, SSH Sentinel, and Making The internet Secure are trademarks of SSH Communication Security Corp. and may be registered in certain jurisdictions. All other names and marks are property of their respective owners. Any questions regarding the License Arrangements with "SSH Communication Security Corporation" should be directed to the following address: SSH Communication Security Inc., 1076 East Meadow Circle, Palo Alto, CA 94303, USA.

### OpenSSL

(See <http://www.openssl.org/> and <http://www.openssl.org/source/license.html>)

The OpenSSL toolkit is licensed under a dual-license (the OpenSSL license and the original SSLeay license). See the license text below.

### A. OpenSSL License

Copyright © 1998-2000 The OpenSSL Project. All rights reserved.

- 1 Redistribution and use in source and binary forms, with or without modification, are permitted provided that the following conditions are met:
- 2 Redistributions of source code must retain the above copyright notice, this list of conditions and the following disclaimer.
- 3 Redistributions in binary form must reproduce the above copyright notice, this list of conditions and the following disclaimer in the documentation and/or other materials provided with the distribution. All advertising materials mentioning features or use of this software must display the following acknowledgment: This product includes software developed by the OpenSSL Project for use in the OpenSSL Toolkit. (<http://www.openssl.org>)
- 4 The names "OpenSSL Toolkit" and "OpenSSL Project" must not be used to endorse or promote products derived from this software without prior written permission. For written permission, please contact [openssl-core@openssl.org](mailto:openssl-core@openssl.org)
- 5 Products derived from this software may not be called "OpenSSL" nor may "OpenSSL" appear in their names without prior written permission of the OpenSSL Project.
- 6 Redistributions of any form whatsoever must retain the following acknowledgment:

"This product includes software developed by the OpenSSL Project for use in the OpenSSL Toolkit ( <http://www.openssl.org> )"

THIS SOFTWARE IS PROVIDED BY THE OpenSSL PROJECT "AS IS" AND ANY EXPRESSED OR IMPLIED WARRANTIES, INCLUDING, BUT NOT LIMITED TO, THE IMPLIED WARRANTIES OF MERCHANTABILITY AND FITNESS FOR A PARTICULAR PURPOSE ARE DISCLAIMED. IN NO EVENT SHALL THE OpenSSL PROJECT OR ITS CONTRIBUTORS BE LIABLE FOR ANY DIRECT, INDIRECT, INCIDENTAL, SPECIAL, EXEMPLARY, OR CONSEQUENTIAL DAMAGES (INCLUDING, BUT NOT LIMITED TO, PROCUREMENT OF SUBSTITUTE GOODS OR SERVICES; LOSS OF USE, DATA, OR PROFITS; OR BUSINESS INTERRUPTION) HOWEVER CAUSED AND ON ANY THEORY OF LIABILITY, WHETHER IN CONTRACT, STRICT LIABILITY, OR TORT (INCLUDING NEGLIGENCE OR OTHERWISE) ARISING IN ANY WAY OUT OF THE USE OF THIS SOFTWARE, EVEN IF ADVISED OF THE POSSIBILITY OF SUCH DAMAGE.

This product includes cryptographic software written by Eric Young ([ey@cryptsoft.com](mailto:ey@cryptsoft.com)). This product includes software written by Tim Hudson ([tjh@cryptsoft.com](mailto:tjh@cryptsoft.com)).

### B. SSLeay License

Copyright ©1995-1998 Eric Young ([ey@cryptsoft.com](mailto:ey@cryptsoft.com)) All rights reserved.

This package is an SSL implementation written by Eric Young ([ey@cryptsoft.com](mailto:ey@cryptsoft.com)).

The implementation was written so as to conform with Netscapes SSL.

This library is free for commercial and non-commercial use as long as the following conditions are adhered to. The following conditions apply to all code found in this distribution, be it the RC4, RSA, lhash, DES, etc., code; not just the SSL code. The SSL documentation included with this distribution is covered by the same copyright terms except that the holder is Tim Hudson (tjh@cryptsoft.com).

Copyright remains Eric Young's, and as such any Copyright notices in the code are not to be removed. If this package is used in a product, Eric Young should be given attribution as the author of the parts of the library used. This can be in the form of a textual message at program startup or in documentation (online or textual) provided with the package. Redistribution and use in source and binary forms, with or without modification, are permitted provided that the following conditions are met:

- 1 Redistributions of source code must retain the copyright notice, this list of conditions and the following disclaimer.
- 2 Redistributions in binary form must reproduce the above copyright notice, this list of conditions and the following disclaimer in the documentation and/or other materials provided with the distribution.
- 3 All advertising materials mentioning features or use of this software must display the following acknowledgement: "This product includes cryptographic software written by Eric Young (eay@cryptsoft.com)". The word 'cryptographic' can be left out if the routines from the library being used are not cryptographic related :-).
- 4 If you include any Windows specific code (or a derivative thereof) from the apps directory (application code) you must include an acknowledgement: "This product includes software written by Tim Hudson (tjh@cryptsoft.com)"

THIS SOFTWARE IS PROVIDED BY ERIC YOUNG "AS IS" AND ANY EXPRESS OR IMPLIED WARRANTIES, INCLUDING, BUT NOT LIMITED TO, THE IMPLIED WARRANTIES OF MERCHANTABILITY AND FITNESS FOR A PARTICULAR PURPOSE ARE DISCLAIMED. IN NO EVENT SHALL THE AUTHOR OR CONTRIBUTORS BE LIABLE FOR ANY DIRECT, INDIRECT, INCIDENTAL, SPECIAL, EXEMPLARY, OR CONSEQUENTIAL DAMAGES (INCLUDING, BUT NOT LIMITED TO, PROCUREMENT OF SUBSTITUTE GOODS OR SERVICES; LOSS OF USE, DATA, OR PROFITS; OR BUSINESS INTERRUPTION) HOWEVER CAUSED AND ON ANY THEORY OF LIABILITY, WHETHER IN CONTRACT, STRICT LIABILITY, OR TORT (INCLUDING NEGLIGENCE OR OTHERWISE) ARISING IN ANY WAY OUT OF THE USE OF THIS SOFTWARE, EVEN IF ADVISED OF THE POSSIBILITY OF SUCH DAMAGE.

The license and distribution terms for any publically available version or derivative of this code cannot be changed. i.e. this code cannot simply be copied and put under another distribution license [including the GNU Public License.

## Mini-HTTPD

ACME Labs Freeware License

(See [http://www.acme.com/software/mini\\_httpd/](http://www.acme.com/software/mini_httpd/))

Copyright © 2000 by Jef Poskanzer <jef@acme.com>. All rights reserved.

Redistribution and use in source and binary forms, with or without modification, are permitted provided that the following conditions are met:

- 1 Redistributions of source code must retain the above copyright notice, this list of conditions and the following disclaimer.
- 2 Redistributions in binary form must reproduce the above copyright notice, this list of conditions and the following disclaimer in the documentation and/or other materials provided with the distribution.

THIS SOFTWARE IS PROVIDED BY THE AUTHOR AND CONTRIBUTORS "AS IS" AND ANY EXPRESS OR IMPLIED WARRANTIES, INCLUDING, BUT NOT LIMITED TO, THE IMPLIED WARRANTIES OF MERCHANTABILITY AND FITNESS FOR A PARTICULAR PURPOSE ARE DISCLAIMED. IN NO EVENT SHALL THE AUTHOR OR CONTRIBUTORS BE LIABLE FOR ANY DIRECT, INDIRECT, INCIDENTAL, SPECIAL, EXEMPLARY, OR CONSEQUENTIAL DAMAGES (INCLUDING, BUT NOT LIMITED TO, PROCUREMENT OF SUBSTITUTE GOODS OR SERVICES; LOSS OF USE, DATA, OR PROFITS; OR BUSINESS INTERRUPTION) HOWEVER CAUSED AND ON ANY THEORY OF LIABILITY, WHETHER IN CONTRACT, STRICT LIABILITY, OR TORT (INCLUDING NEGLIGENCE OR OTHERWISE) ARISING IN ANY WAY OUT OF THE USE OF THIS SOFTWARE, EVEN IF ADVISED OF THE POSSIBILITY OF SUCH DAMAGE.

## eCos

(See <http://ecos.sourceware.org/> and <http://ecos.sourceware.org/license-overview.html>)

This is the full text of the license as found on files within eCos covered by the eCos license. It should be read in conjunction with the GNU General Public License (GPL) on which it depends.

Copyright © 1998, 1999, 2000, 2001, 2002, 2003 Red Hat, Inc.

Copyright © 2002, 2003 John Dallaway

Copyright © 2002, 2003 Nick Garnett

Copyright © 2002, 2003 Jonathan Larmour

Copyright © 2002, 2003 Andrew Lunn

Copyright © 2002, 2003 Gary Thomas

Copyright © 2002, 2003 Bart Veer

eCos is free software; you can redistribute it and/or modify it under the terms of the GNU General Public License as published by the Free Software Foundation; either version 2 or (at your option) any later version.

eCos is distributed in the hope that it will be useful, but WITHOUT ANY WARRANTY; without even the implied warranty of MERCHANTABILITY or FITNESS FOR A PARTICULAR PURPOSE. See the GNU General Public License Version 2 below for more details.

## **GNU GENERAL PUBLIC LICENSE Version 2, June 1991**

Copyright ©1989, 1991 Free Software Foundation, Inc., 51 Franklin Street, Fifth Floor, Boston, MA 02110-1301 USA

Everyone is permitted to copy and distribute verbatim copies of this license document, but changing it is not allowed.

The precise terms and conditions for copying, distribution and modification follow.

This License applies to any program or other work which contains a notice placed by the copyright holder saying it may be distributed under the terms of this General Public License. The “Program”, below, refers to any such program or work, and a “work based on the Program” means either the Program or any derivative work under copyright law: that is to say, a work containing the Program or a portion of it, either verbatim or with modifications and/or translated into another language. (Hereinafter, translation is included without limitation in the term “modification”.) Each licensee is addressed as “you”.

Activities other than copying, distribution and modification are not covered by this License; they are outside its scope. The act of running the Program is not restricted, and the output from the Program is covered only if its contents constitute a work based on the Program (independent of having been made by running the Program). Whether that is true depends on what the Program does.

- 1** You may copy and distribute verbatim copies of the Program's source code as you receive it, in any medium, provided that you conspicuously and appropriately publish on each copy an appropriate copyright notice and disclaimer of warranty; keep intact all the notices that refer to this License and to the absence of any warranty; and give any other recipients of the Program a copy of this License along with the Program. You may charge a fee for the physical act of transferring a copy, and you may at your option offer warranty protection in exchange for a fee.
- 2** You may modify your copy or copies of the Program or any portion of it, thus forming a work based on the Program, and copy and distribute such modifications or work under the terms of Section 1 above, provided that you also meet all of these conditions:
  - a** You must cause the modified files to carry prominent notices stating that you changed the files and the date of any change.



- b** You must cause any work that you distribute or publish, that in whole or in part contains or is derived from the Program or any part thereof, to be licensed as a whole at no charge to all third parties under the terms of this License.
- c** If the modified program normally reads commands interactively when run, you must cause it, when started running for such interactive use in the most ordinary way, to print or display an announcement including an appropriate copyright notice and a notice that there is no warranty (or else, saying that you provide a warranty) and that users may redistribute the program under these conditions, and telling the user how to view a copy of this License. (Exception: if the Program itself is interactive but does not normally print such an announcement, your work based on the Program is not required to print an announcement.)

These requirements apply to the modified work as a whole. If identifiable sections of that work are not derived from the Program, and can be reasonably considered independent and separate works in themselves, then this License, and its terms, do not apply to those sections when you distribute them as separate works. But when you distribute the same sections as part of a whole which is a work based on the Program, the distribution of the whole must be on the terms of this License, whose permissions for other licensees extend to the entire whole, and thus to each and every part regardless of who wrote it.

Thus, it is not the intent of this section to claim rights or contest your rights to work written entirely by you; rather, the intent is to exercise the right to control the distribution of derivative or collective works based on the Program.

In addition, mere aggregation of another work not based on the Program with the Program (or with a work based on the Program) on a volume of a storage or distribution medium does not bring the other work under the scope of this License.

- 3** You may copy and distribute the Program (or a work based on it, under Section 2) in object code or executable form under the terms of Sections 1 and 2 above provided that you also do one of the following:
  - a** Accompany it with the complete corresponding machine-readable source code, which must be distributed under the terms of Sections 1 and 2 above on a medium customarily used for software interchange; or,
  - b** Accompany it with a written offer, valid for at least three years, to give any third party, for a charge no more than your cost of physically performing source distribution, a complete machine-readable copy of the corresponding source code, to be distributed under the terms of Sections 1 and 2 above on a medium customarily used for software interchange; or,
  - c** Accompany it with the information you received as to the offer to distribute corresponding source code. (This alternative is allowed only for noncommercial distribution and only if you received the program in object code or executable form with such an offer, in accord with Subsection b above.)

The source code for a work means the preferred form of the work for making modifications to it. For an executable work, complete source code means all the source code for all modules it contains, plus any associated interface definition files, plus the scripts used to control compilation and installation of the executable. However, as a special exception, the source code distributed need not include anything that is normally distributed (in either source or binary form) with the major components (compiler, kernel, and so on) of the operating system on which the executable runs, unless that component itself accompanies the executable.

If distribution of executable or object code is made by offering access to copy from a designated place, then offering equivalent access to copy the source code from the same place counts as distribution of the source code, even though third parties are not compelled to copy the source along with the object code.

- 4 You may not copy, modify, sublicense, or distribute the Program except as expressly provided under this License. Any attempt otherwise to copy, modify, sublicense or distribute the Program is void, and will automatically terminate your rights under this License. However, parties who have received copies, or rights, from you under this License will not have their licenses terminated so long as such parties remain in full compliance.
- 5 You are not required to accept this License, since you have not signed it. However, nothing else grants you permission to modify or distribute the Program or its derivative works. These actions are prohibited by law if you do not accept this License. Therefore, by modifying or distributing the Program (or any work based on the Program), you indicate your acceptance of this License to do so, and all its terms and conditions for copying, distributing or modifying the Program or works based on it.
- 6 Each time you redistribute the Program (or any work based on the Program), the recipient automatically receives a license from the original licensor to copy, distribute or modify the Program subject to these terms and conditions. You may not impose any further restrictions on the recipients' exercise of the rights granted herein. You are not responsible for enforcing compliance by third parties to this License.
- 7 If, as a consequence of a court judgment or allegation of patent infringement or for any other reason (not limited to patent issues), conditions are imposed on you (whether by court order, agreement or otherwise) that contradict the conditions of this License, they do not excuse you from the conditions of this License. If you cannot distribute so as to satisfy simultaneously your obligations under this License and any other pertinent obligations, then as a consequence you may not distribute the Program at all. For example, if a patent license would not permit royalty-free redistribution of the Program by all those who receive copies directly or indirectly through you, then the only way you could satisfy both it and this License would be to refrain entirely from distribution of the Program.

If any portion of this section is held invalid or unenforceable under any particular circumstance, the balance of the section is intended to apply and the section as a whole is intended to apply in other circumstances.

It is not the purpose of this section to induce you to infringe any patents or other property right claims or to contest validity of any such claims; this section has the sole purpose of protecting the integrity of the free software distribution system, which is implemented by public license practices. Many people have made generous contributions to the wide range of software distributed through that system in reliance on consistent application of that system; it is up to the author/donor to decide if he or she is willing to distribute software through any other system and a licensee cannot impose that choice.

This section is intended to make thoroughly clear what is believed to be a consequence of the rest of this License.

- 8 If the distribution and/or use of the Program is restricted in certain countries either by patents or by copyrighted interfaces, the original copyright holder who places the Program under this License may add an explicit geographical distribution limitation excluding those countries, so that distribution is permitted only in or among countries not thus excluded. In such case, this License incorporates the limitation as if written in the body of this License.
- 9 The Free Software Foundation may publish revised and/or new versions of the General Public License from time to time. Such new versions will be similar in spirit to the present version, but may differ in detail to address new problems or concerns.

Each version is given a distinguishing version number. If the Program specifies a version number of this License which applies to it and “any later version”, you have the option of following the terms and conditions either of that version or of any later version published by the Free Software Foundation. If the Program does not specify a version number of this License, you may choose any version ever published by the Free Software Foundation.

- 10 If you wish to incorporate parts of the Program into other free programs whose distribution conditions are different, write to the author to ask for permission. For software which is copyrighted by the Free Software Foundation, write to the Free Software Foundation; we sometimes make exceptions for this. Our decision will be guided by the two goals of preserving the free status of all derivatives of our free software and of promoting the sharing and reuse of software generally.

#### NO WARRANTY

- 11 BECAUSE THE PROGRAM IS LICENSED FREE OF CHARGE, THERE IS NO WARRANTY FOR THE PROGRAM, TO THE EXTENT PERMITTED BY APPLICABLE LAW. EXCEPT WHEN OTHERWISE STATED IN WRITING THE COPYRIGHT HOLDERS AND/OR OTHER PARTIES PROVIDE THE PROGRAM “AS IS” WITHOUT WARRANTY OF ANY KIND, EITHER EXPRESSED OR IMPLIED, INCLUDING, BUT NOT LIMITED TO, THE IMPLIED WARRANTIES OF MERCHANTABILITY AND FITNESS FOR A PARTICULAR PURPOSE. THE ENTIRE RISK AS TO THE QUALITY AND PERFORMANCE OF THE PROGRAM IS WITH YOU. SHOULD THE PROGRAM PROVE DEFECTIVE, YOU ASSUME THE COST OF ALL NECESSARY SERVICING, REPAIR OR CORRECTION.

**12** IN NO EVENT UNLESS REQUIRED BY APPLICABLE LAW OR AGREED TO IN WRITING WILL ANY COPYRIGHT HOLDER, OR ANY OTHER PARTY WHO MAY MODIFY AND/OR REDISTRIBUTE THE PROGRAM AS PERMITTED ABOVE, BE LIABLE TO YOU FOR DAMAGES, INCLUDING ANY GENERAL, SPECIAL, INCIDENTAL OR CONSEQUENTIAL DAMAGES ARISING OUT OF THE USE OR INABILITY TO USE THE PROGRAM (INCLUDING BUT NOT LIMITED TO LOSS OF DATA OR DATA BEING RENDERED INACCURATE OR LOSSES SUSTAINED BY YOU OR THIRD PARTIES OR A FAILURE OF THE PROGRAM TO OPERATE WITH ANY OTHER PROGRAMS), EVEN IF SUCH HOLDER OR OTHER PARTY HAS BEEN ADVISED OF THE POSSIBILITY OF SUCH DAMAGES. As a special exception, if other files instantiate templates or use macros or inline functions from this file, or you compile this file and link it with other works to produce a work based on this file, this file does not by itself cause the resulting work to be covered by the GNU General Public License. However the source code for this file must still be made available in accordance with section (3) of the GNU General Public License.

This exception does not invalidate any other reasons why a work based on this file might be covered by the GNU General Public License.

To receive a copy of the Source Code under the General License 2, send a request with your name and address to:

Attn: Software Engineer  
Cable Home Network BU  
Cisco Video Technology Group  
5030 Sugarloaf Highway  
Lawrenceville, GA 30044

## **Kerberos**

(See <http://web.mit.edu/Kerberos/>, <http://web.mit.edu/Kerberos/dist/index.html>, and <http://web.mit.edu/Kerberos/krb5-1.5/README-1.5.1.txt> or the corresponding README file for the appropriate release)

Copyright © 1994 by the Massachusetts Institute of Technology. All Rights Reserved.

Export of this software from the United States of America may require a specific license from the United States Government. It is the responsibility of any person or organization contemplating export to obtain such a license before exporting.

WITHIN THAT CONSTRAINT, permission to use, copy, modify, and distribute this software and its documentation for any purpose and without fee is hereby granted, provided that the above copyright notice appear in all copies and that both that copyright notice and this permission notice appear in supporting documentation, and that the name of M.I.T. not be used in advertising or publicity pertaining to distribution of the software without specific, written prior permission. Furthermore if you modify this software you must label your software as modified software and not distribute it in such a fashion that it might be confused with the original M.I.T. software. M.I.T. makes no representations about the suitability of this software for any purpose. It is provided "as is" without express or implied warranty.

## **NetSNMP**

(See <http://net-snmp.sourceforge.net/> and <http://net-snmp.sourceforge.net/about/license.html>)

Various copyrights apply to this package, listed in 4 separate parts below. Please make sure that you read all the parts. Up until 2001, the project was based at UC Davis, and the first part covers all code written during this time. From 2001 onwards, the project has been based at SourceForge, and Networks Associates Technology, Inc hold the copyright on behalf of the wider Net-SNMP community, covering all derivative work done since then. An additional copyright section has been added as Part 3 below also under a BSD license for the work contributed by Cambridge Broadband Ltd. to the project since 2001. An additional copyright section has been added as Part 4 below also under a BSD license for the work contributed by Sun Microsystems, Inc. to the project since 2003.

Code has been contributed to this project by many people over the years it has been in development, and a full list of contributors can be found in the README file under the THANKS section.

### **Part 1: CMU/UCD Copyright Notice: (BSD like)**

Copyright ©1989, 1991, 1992 by Carnegie Mellon University

Derivative Work - 1996, 1998-2000 Copyright© 1996, 1998-2000 The Regents of the University of California. All Rights Reserved

Permission to use, copy, modify and distribute this software and its documentation for any purpose and without fee is hereby granted, provided that the above copyright notice appears in all copies and that both that copyright notice and this permission notice appear in supporting documentation, and that the name of CMU and The Regents of the University of California not be used in advertising or publicity pertaining to distribution of the software without specific written permission.

CMU AND THE REGENTS OF THE UNIVERSITY OF CALIFORNIA DISCLAIM ALL WARRANTIES WITH REGARD TO THIS SOFTWARE, INCLUDING ALL IMPLIED WARRANTIES OF MERCHANTABILITY AND FITNESS. IN NO EVENT SHALL CMU OR THE REGENTS OF THE UNIVERSITY OF CALIFORNIA BE LIABLE FOR ANY SPECIAL, INDIRECT OR CONSEQUENTIAL DAMAGES OR ANY DAMAGES WHATSOEVER RESULTING FROM THE LOSS OF USE, DATA OR PROFITS, WHETHER IN AN ACTION OF CONTRACT, NEGLIGENCE OR OTHER TORTIOUS ACTION, ARISING OUT OF OR IN CONNECTION WITH THE USE OR PERFORMANCE OF THIS SOFTWARE.

**Part 2: Networks Associates Technology, Inc Copyright Notice (BSD)**

Copyright © 2001-2003, Networks Associates Technology, Inc All rights reserved.

Redistribution and use in source and binary forms, with or without modification, are permitted provided that the following conditions are met:

- Redistributions of source code must retain the above copyright notice, this list of conditions and the following disclaimer.
- Redistributions in binary form must reproduce the above copyright notice, this list of conditions and the following disclaimer in the documentation and/or other materials provided with the distribution.
- Neither the name of the Networks Associates Technology, Inc nor the names of its contributors may be used to endorse or promote products derived from this software without specific prior written permission.

THIS SOFTWARE IS PROVIDED BY THE COPYRIGHT HOLDERS AND CONTRIBUTORS "AS IS" AND ANY EXPRESS OR IMPLIED WARRANTIES, INCLUDING, BUT NOT LIMITED TO, THE IMPLIED WARRANTIES OF MERCHANTABILITY AND FITNESS FOR A PARTICULAR PURPOSE ARE DISCLAIMED. IN NO EVENT SHALL THE COPYRIGHT HOLDERS OR CONTRIBUTORS BE LIABLE FOR ANY DIRECT, INDIRECT, INCIDENTAL, SPECIAL, EXEMPLARY, OR CONSEQUENTIAL DAMAGES (INCLUDING, BUT NOT LIMITED TO, PROCUREMENT OF SUBSTITUTE GOODS OR SERVICES; LOSS OF USE, DATA, OR PROFITS; OR BUSINESS INTERRUPTION) HOWEVER CAUSED AND ON ANY THEORY OF LIABILITY, WHETHER IN CONTRACT, STRICT LIABILITY, OR TORT (INCLUDING NEGLIGENCE OR OTHERWISE) ARISING IN ANY WAY OUT OF THE USE OF THIS SOFTWARE, EVEN IF ADVISED OF THE POSSIBILITY OF SUCH DAMAGE.

**Part 3: Cambridge Broadband Ltd. Copyright Notice (BSD)**

Portions of this code are copyright © 2001-2003, Cambridge Broadband Ltd. All rights reserved.

### Third Party Software License Notices For Cisco Model DPC/EPC2325 DOCSIS Residential Gateway with Wireless Access

Redistribution and use in source and binary forms, with or without modification, are permitted provided that the following conditions are met:

- Redistributions of source code must retain the above copyright notice, this list of conditions and the following disclaimer.
- Redistributions in binary form must reproduce the above copyright notice, this list of conditions and the following disclaimer in the documentation and/or other materials provided with the distribution.
- The name of Cambridge Broadband Ltd. may not be used to endorse or promote products derived from this software without specific prior written permission.

THIS SOFTWARE IS PROVIDED BY THE COPYRIGHT HOLDER "AS IS" AND ANY EXPRESS OR IMPLIED WARRANTIES, INCLUDING, BUT NOT LIMITED TO, THE IMPLIED WARRANTIES OF MERCHANTABILITY AND FITNESS FOR A PARTICULAR PURPOSE ARE DISCLAIMED. IN NO EVENT SHALL THE COPYRIGHT HOLDER BE LIABLE FOR ANY DIRECT, INDIRECT, INCIDENTAL, SPECIAL, EXEMPLARY, OR CONSEQUENTIAL DAMAGES (INCLUDING, BUT NOT LIMITED TO, PROCUREMENT OF SUBSTITUTE GOODS OR SERVICES; LOSS OF USE, DATA, OR PROFITS; OR BUSINESS INTERRUPTION) HOWEVER CAUSED AND ON ANY THEORY OF LIABILITY, WHETHER IN CONTRACT, STRICT LIABILITY, OR TORT (INCLUDING NEGLIGENCE OR OTHERWISE) ARISING IN ANY WAY OUT OF THE USE OF THIS SOFTWARE, EVEN IF ADVISED OF THE POSSIBILITY OF SUCH DAMAGE.

#### **Part 4: Sun Microsystems, Inc. Copyright Notice (BSD)**

Copyright © 2003 Sun Microsystems, Inc., 4150 Network Circle, Santa Clara, California 95054, U.S.A. All rights reserved.

Use is subject to license terms below.

This distribution may include materials developed by third parties. Sun, Sun Microsystems, the Sun logo and Solaris are trademarks or registered trademarks of Sun Microsystems, Inc. in the U.S. and other countries.

Redistribution and use in source and binary forms, with or without modification, are permitted provided that the following conditions are met:

- Redistributions of source code must retain the above copyright notice, this list of conditions and the following disclaimer.
- Redistributions in binary form must reproduce the above copyright notice, this list of conditions and the following disclaimer in the documentation and/or other materials provided with the distribution.
- Neither the name of the Sun Microsystems, Inc. nor the names of its contributors may be used to endorse or promote products derived from this software without specific prior written permission.

THIS SOFTWARE IS PROVIDED BY THE COPYRIGHT HOLDERS AND CONTRIBUTORS "AS IS" AND ANY EXPRESS OR IMPLIED WARRANTIES, INCLUDING, BUT NOT LIMITED TO, THE IMPLIED WARRANTIES OF MERCHANTABILITY AND FITNESS FOR A PARTICULAR PURPOSE ARE DISCLAIMED. IN NO EVENT SHALL THE COPYRIGHT HOLDERS OR CONTRIBUTORS BE LIABLE FOR ANY DIRECT, INDIRECT, INCIDENTAL, SPECIAL, EXEMPLARY, OR CONSEQUENTIAL DAMAGES (INCLUDING, BUT NOT LIMITED TO, PROCUREMENT OF SUBSTITUTE GOODS OR SERVICES; LOSS OF USE, DATA, OR PROFITS; OR BUSINESS INTERRUPTION) HOWEVER CAUSED AND ON ANY THEORY OF LIABILITY, WHETHER IN CONTRACT, STRICT LIABILITY, OR TORT (INCLUDING NEGLIGENCE OR OTHERWISE) ARISING IN ANY WAY OUT OF THE USE OF THIS SOFTWARE, EVEN IF ADVISED OF THE POSSIBILITY OF SUCH DAMAGE.

## Apache Software License

(See <http://www.apache.org> and <http://www.apache.org/licenses/>)

Apache Software License Version 1.1 Copyright ©2000 The Apache Software Foundation. All rights reserved.

Redistribution and use in source and binary forms, with or without modification, are permitted provided that the following conditions are met:

- 1 Redistributions of source code must retain the above copyright notice, this list of conditions and the following disclaimer.
- 2 Redistributions in binary form must reproduce the above copyright notice, this list of conditions and the following disclaimer in the documentation and/or other materials provided with the distribution.
- 3 The end-user documentation included with the redistribution, if any, must include the following acknowledgment: "This product includes software developed by the Apache Software Foundation ( <http://www.apache.org/> )." Alternately, this acknowledgment may appear in the software itself, if and wherever such third-party acknowledgments normally appear.
- 4 The names "Apache" and "Apache Software Foundation" must not be used to endorse or promote products derived from this software without prior written permission. For written permission, please contact [apache@apache.org](mailto:apache@apache.org).
- 5 Products derived from this software may not be called "Apache", nor may "Apache" appear in their name, without prior written permission of the Apache Software Foundation.



THIS SOFTWARE IS PROVIDED "AS IS" AND ANY EXPRESSED OR IMPLIED WARRANTIES, INCLUDING, BUT NOT LIMITED TO, THE IMPLIED WARRANTIES OF MERCHANTABILITY AND FITNESS FOR A PARTICULAR PURPOSE ARE DISCLAIMED. IN NO EVENT SHALL THE APACHE SOFTWARE FOUNDATION OR ITS CONTRIBUTORS BE LIABLE FOR ANY DIRECT, INDIRECT, INCIDENTAL, SPECIAL, EXEMPLARY, OR CONSEQUENTIAL DAMAGES (INCLUDING, BUT NOT LIMITED TO, PROCUREMENT OF SUBSTITUTE GOODS OR SERVICES; LOSS OF USE, DATA, OR PROFITS; OR BUSINESS INTERRUPTION) HOWEVER CAUSED AND ON ANY THEORY OF LIABILITY, WHETHER IN CONTRACT, STRICT LIABILITY, OR TORT (INCLUDING NEGLIGENCE OR OTHERWISE) ARISING IN ANY WAY OUT OF THE USE OF THIS SOFTWARE, EVEN IF ADVISED OF THE POSSIBILITY OF SUCH DAMAGE.

## Kame IPv6 Stack

(See <http://www.kame.net> and <http://www.kame.net/dev/cvsweb2.cgi/kame/FAQ?rev=HEAD&content-type=text/x-cvsweb-markup>)

Copyright ©1995, 1996, 1997, and 1998 WIDE Project. All rights reserved.

Redistribution and use in source and binary forms, with or without modification, are permitted provided that the following conditions are met:

- 1 Redistributions of source code must retain the above copyright notice, this list of conditions and the following disclaimer.
- 2 Redistributions in binary form must reproduce the above copyright notice, this list of conditions and the following disclaimer in the documentation and/or other materials provided with the distribution.
- 3 Neither the name of the project nor the names of its contributors may be used to endorse or promote products derived from this software without specific prior written permission.
- 4 THIS SOFTWARE IS PROVIDED BY THE PROJECT AND CONTRIBUTORS "AS IS" AND ANY EXPRESS OR IMPLIED WARRANTIES, INCLUDING, BUT NOT LIMITED TO, THE IMPLIED WARRANTIES OF MERCHANTABILITY AND FITNESS FOR A PARTICULAR PURPOSE ARE DISCLAIMED. IN NO EVENT SHALL THE PROJECT OR CONTRIBUTORS BE LIABLE FOR ANY DIRECT, INDIRECT, INCIDENTAL, SPECIAL, EXEMPLARY, OR CONSEQUENTIAL DAMAGES (INCLUDING, BUT NOT LIMITED TO, PROCUREMENT OF SUBSTITUTE GOODS OR SERVICES; LOSS OF USE, DATA, OR PROFITS; OR BUSINESS INTERRUPTION) HOWEVER CAUSED AND ON ANY THEORY OF LIABILITY, WHETHER IN CONTRACT, STRICT LIABILITY, OR TORT (INCLUDING NEGLIGENCE OR OTHERWISE) ARISING IN ANY WAY OUT OF THE USE OF THIS SOFTWARE, EVEN IF ADVISED OF THE POSSIBILITY OF SUCH DAMAGE.

## Global IP Solutions iLBC

All use of the Original Code (GIPS iLBC , and code provided by GIPS as part of any related IETF Standard or draft standard) is subject to the complete Global IP Sound iLBC Public License, IETF Standard, Limited Commercial Use (the "License"). By accessing the Original Code You agree to the License terms.

PLEASE SEE THE COMPLETE LICENSE FOR ADDITIONAL TERMS. In general:

- Personal, non-commercial use is generally permitted.
- Commercialization is permitted with certain limitations; for example, to ensure that every iLBC decoder can decode every iLBC-encoded payload, commercial "Deployment" must comply with the applicable IETF Standard/draft, and the format of the bitstream may not be modified.
- You are provided no warranty or support, and all liability is disclaimed.
- You must register this license with GIPS prior to any commercial Deployment.

The License is available from <http://www.globalipsound.com/legal/licenses/ilbc>; or from Global IP Sound Europe AB, Ölandsgatan 42, SE-116 63, Stockholm, Sweden, +46.8.545.5.30.40 tel, +46.8.545.5.30.49 fax; or from Global IP Sound Inc., 900 Kearny Street, 5th Floor, San Francisco, California 94133-5124 USA, +1 415.397.2555 tel, +1 415.397.2577 fax; or by sending a request to [info@globalipsound.com](mailto:info@globalipsound.com).

The current IETF Standards can also be found at <http://www.ietf.org/rfc/rfc3951.txt> plus <http://www.ietf.org/rfc/rfc3952.txt>. The initial developer of the Original Code is Global IP Sound Inc. Portions Copyright © 1999-2005, All Rights Reserved.

iLBC is a trademark of Global IP Sound. All redistribution is subject to the License; source code must include this Notice.

## Apache

(See <http://www.apache.org/licenses/LICENSE-2.0>)

Licensed under the Apache License, Version 2.0 (the "License"); you may not use this file except in compliance with the License.

### Apache License, Version 2.0

Apache License  
Version 2.0, January 2004  
<http://www.apache.org/licenses/>

### TERMS AND CONDITIONS FOR USE, REPRODUCTION, AND DISTRIBUTION

#### 1 Definitions.

"License" shall mean the terms and conditions for use, reproduction, and distribution as defined by Sections 1 through 9 of this document.

“Licensor” shall mean the copyright owner or entity authorized by the copyright owner that is granting the License.

“Legal Entity” shall mean the union of the acting entity and all other entities that control, are controlled by, or are under common control with that entity. For the purposes of this definition, “control” means (i) the power, direct or indirect, to cause the direction or management of such entity, whether by contract or otherwise, or (ii) ownership of fifty percent (50%) or more of the outstanding shares, or (iii) beneficial ownership of such entity.

“You” (or “Your”) shall mean an individual or Legal Entity exercising permissions granted by this License.

“Source” form shall mean the preferred form for making modifications, including but not limited to software source code, documentation source, and configuration files.

“Object” form shall mean any form resulting from mechanical transformation or translation of a Source form, including but not limited to compiled object code, generated documentation, and conversions to other media types.

“Work” shall mean the work of authorship, whether in Source or Object form, made available under the License, as indicated by a copyright notice that is included in or attached to the work (an example is provided in the Appendix below).

“Derivative Works” shall mean any work, whether in Source or Object form, that is based on (or derived from) the Work and for which the editorial revisions, annotations, elaborations, or other modifications represent, as a whole, an original work of authorship. For the purposes of this License, Derivative Works shall not include works that remain separable from, or merely link (or bind by name) to the interfaces of, the Work and Derivative Works thereof.

“Contribution” shall mean any work of authorship, including the original version of the Work and any modifications or additions to that Work or Derivative Works thereof, that is intentionally submitted to Licensor for inclusion in the Work by the copyright owner or by an individual or Legal Entity authorized to submit on behalf of the copyright owner. For the purposes of this definition, “submitted” means any form of electronic, verbal, or written communication sent to the Licensor or its representatives, including but not limited to communication on electronic mailing lists, source code control systems, and issue tracking systems that are managed by, or on behalf of, the Licensor for the purpose of discussing and improving the Work, but excluding communication that is conspicuously marked or otherwise designated in writing by the copyright owner as “Not a Contribution.”

“Contributor” shall mean Licensor and any individual or Legal Entity on behalf of whom a Contribution has been received by Licensor and subsequently incorporated within the Work.

**2 Grant of Copyright License.**

Subject to the terms and conditions of this License, each Contributor hereby grants to You a perpetual, worldwide, non-exclusive, no-charge, royalty-free, irrevocable copyright license to reproduce, prepare Derivative Works of, publicly display, publicly perform, sublicense, and distribute the Work and such Derivative Works in Source or Object form.

**3 Grant of Patent License.**

Subject to the terms and conditions of this License, each Contributor hereby grants to You a perpetual, worldwide, non-exclusive, no-charge, royalty-free, irrevocable (except as stated in this section) patent license to make, have made, use, offer to sell, sell, import, and otherwise transfer the Work, where such license applies only to those patent claims licensable by such Contributor that are necessarily infringed by their Contribution(s) alone or by combination of their Contribution(s) with the Work to which such Contribution(s) was submitted. If You institute patent litigation against any entity (including a cross-claim or counterclaim in a lawsuit) alleging that the Work or a Contribution incorporated within the Work constitutes direct or contributory patent infringement, then any patent licenses granted to You under this License for that Work shall terminate as of the date such litigation is filed.

**4 Redistribution.**

You may reproduce and distribute copies of the Work or Derivative Works thereof in any medium, with or without modifications, and in Source or Object form, provided that You meet the following conditions:

- a** You must give any other recipients of the Work or Derivative Works a copy of this License; and
- b** You must cause any modified files to carry prominent notices stating that You changed the files; and
- c** You must retain, in the Source form of any Derivative Works that You distribute, all copyright, patent, trademark, and attribution notices from the Source form of the Work, excluding those notices that do not pertain to any part of the Derivative Works; and
- d** If the Work includes a "NOTICE" text file as part of its distribution, then any Derivative Works that You distribute must include a readable copy of the attribution notices contained within such NOTICE file, excluding those notices that do not pertain to any part of the Derivative Works, in at least one of the following places: within a NOTICE text file distributed as part of the Derivative Works; within the Source form or documentation, if provided along with the Derivative Works; or, within a display generated by the Derivative Works, if and wherever such third-party notices normally appear. The contents of the NOTICE file are for informational purposes only and do not modify the License. You may add Your own attribution notices within Derivative Works that You distribute, alongside or as an addendum to the NOTICE text from the Work, provided that such additional attribution notices cannot be construed as modifying the License.

- e You may add Your own copyright statement to Your modifications and may provide additional or different license terms and conditions for use, reproduction, or distribution of Your modifications, or for any such Derivative Works as a whole, provided Your use, reproduction, and distribution of the Work otherwise complies with the conditions stated in this License.

**5 Submission of Contributions.**

Unless You explicitly state otherwise, any Contribution intentionally submitted for inclusion in the Work by You to the Licensor shall be under the terms and conditions of this License, without any additional terms or conditions. Notwithstanding the above, nothing herein shall supersede or modify the terms of any separate license agreement you may have executed with Licensor regarding such Contributions.

**6 Trademarks.**

This License does not grant permission to use the trade names, trademarks, service marks, or product names of the Licensor, except as required for reasonable and customary use in describing the origin of the Work and reproducing the content of the NOTICE file.

**7 Disclaimer of Warranty.**

Unless required by applicable law or agreed to in writing, Licensor provides the Work (and each Contributor provides its Contributions) on an "AS IS" BASIS, WITHOUT WARRANTIES OR CONDITIONS OF ANY KIND, either express or implied, including, without limitation, any warranties or conditions of TITLE, NON-INFRINGEMENT, MERCHANTABILITY, or FITNESS FOR A PARTICULAR PURPOSE. You are solely responsible for determining the appropriateness of using or redistributing the Work and assume any risks associated with Your exercise of permissions under this License.

**8 Limitation of Liability.**

In no event and under no legal theory, whether in tort (including negligence), contract, or otherwise, unless required by applicable law (such as deliberate and grossly negligent acts) or agreed to in writing, shall any Contributor be liable to You for damages, including any direct, indirect, special, incidental, or consequential damages of any character arising as a result of this License or out of the use or inability to use the Work (including but not limited to damages for loss of goodwill, work stoppage, computer failure or malfunction, or any and all other commercial damages or losses), even if such Contributor has been advised of the possibility of such damages.

## 9 Accepting Warranty or Additional Liability.

While redistributing the Work or Derivative Works thereof, You may choose to offer, and charge a fee for, acceptance of support, warranty, indemnity, or other liability obligations and/or rights consistent with this License. However, in accepting such obligations, You may act only on Your own behalf and on Your sole responsibility, not on behalf of any other Contributor, and only if You agree to indemnify, defend, and hold each Contributor harmless for any liability incurred by, or claims asserted against, such Contributor by reason of your accepting any such warranty or additional liability.

## MIT License

Copyright © 2008 Cisco-Systems, Inc.

The following permission statement pertains only to the portion of software covered under the "MIT license" including portions of the SSH server and XML parser software. This portion is defined as the "Software" referenced below. The MIT license is available from: <http://www.opensource.org/licenses/mit-license.php>

Permission is hereby granted, free of charge, to any person obtaining a copy of this software and associated documentation files (the "Software"), to deal in the Software without restriction, including without limitation the rights to use, copy, modify, merge, publish, distribute, sublicense, and/or sell copies of the Software, and to permit persons to whom the Software is furnished to do so, subject to the following conditions:

The above copyright notice and this permission notice shall be included in all copies or substantial portions of the Software.

THE SOFTWARE IS PROVIDED "AS IS", WITHOUT WARRANTY OF ANY KIND, EXPRESS OR IMPLIED, INCLUDING BUT NOT LIMITED TO THE WARRANTIES OF MERCHANTABILITY, FITNESS FOR A PARTICULAR PURPOSE AND NONINFRINGEMENT. IN NO EVENT SHALL THE AUTHORS OR COPYRIGHT HOLDERS BE LIABLE FOR ANY CLAIM, DAMAGES OR OTHER LIABILITY, WHETHER IN AN ACTION OF CONTRACT, TORT OR OTHERWISE, ARISING FROM, OUT OF OR IN CONNECTION WITH THE SOFTWARE OR THE USE OR OTHER DEALINGS IN THE SOFTWARE.

## BSD License

Copyright ©1993 The Regents of the University of California. All rights reserved.

This software was developed by the Computer Systems Engineering group at Lawrence Berkeley Laboratory under DARPA contract BG 91-66 and contributed to Berkeley.

### Third Party Software License Notices For Cisco Model DPC/EPC2325 DOCSIS Residential Gateway with Wireless Access

THIS SOFTWARE IS PROVIDED BY THE REGENTS AND CONTRIBUTORS "AS IS" AND ANY EXPRESS OR IMPLIED WARRANTIES, INCLUDING, BUT NOT LIMITED TO, THE IMPLIED WARRANTIES OF MERCHANTABILITY AND FITNESS FOR A PARTICULAR PURPOSE ARE DISCLAIMED. IN NO EVENT SHALL THE REGENTS OR CONTRIBUTORS BE LIABLE FOR ANY DIRECT, INDIRECT, INCIDENTAL, SPECIAL, EXEMPLARY, OR CONSEQUENTIAL DAMAGES (INCLUDING, BUT NOT LIMITED TO, PROCUREMENT OF SUBSTITUTE GOODS OR SERVICES; LOSS OF USE, DATA, OR PROFITS; OR BUSINESS INTERRUPTION) HOWEVER CAUSED AND ON ANY THEORY OF LIABILITY, WHETHER IN CONTRACT, STRICT LIABILITY, OR TORT (INCLUDING NEGLIGENCE OR OTHERWISE) ARISING IN ANY WAY OUT OF THE USE OF THIS SOFTWARE, EVEN IF ADVISED OF THE POSSIBILITY OF SUCH DAMAGE.

## GPLv2

Portions of software are provided under the terms of version 2 of the GNU General Public License (the "GPL"), and any use of such GPL Deliverables and Derivatives thereof by Licensee shall comply with the terms and conditions of the GPL. A copy of the GPL is available at <http://www.gnu.org/licenses/gpl.txt>. A machine-readable copy of the source code that is applicable to the GPL version 2 licensed software contained in this product is available from Cisco Systems, Inc. as per the GPL license. See terms of GPL under eCOS Notice above.

To receive a copy of the Source Code under the GPL, send a request with your name and address to:

Attn: Software Engineer  
Cable Home Network BU  
Cisco Video Technology Group  
5030 Sugarloaf Highway  
Lawrenceville, GA 30044



Cisco Systems, Inc.  
5030 Sugarloaf Parkway, Box 465447  
Lawrenceville, GA 30042

678 277-1120  
800 722-2009  
[www.cisco.com](http://www.cisco.com)

This document includes various trademarks of Cisco Systems, Inc. Please see the Notices section of this document for a list of the Cisco Systems, Inc. trademarks used in this document.

Product and service availability are subject to change without notice.

© 2008, 2009, 2012 Cisco and/or its affiliates. All rights reserved.

May 2012 Printed in USA

Part Number 4024320 Rev B