

INSTRUCTION MANUAL

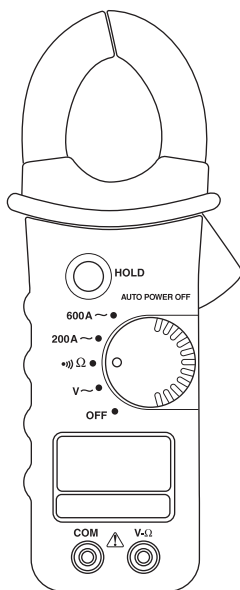

CM-600 • CM-650 Clamp-on Meters



Read and understand all of the instructions and safety information in this manual before operating or servicing this tool.

Description

The Greenlee CM-600 and CM-650 Clamp-on Meters are versatile clamp-on meters intended to measure AC current, AC voltage, resistance and to verify continuity. These units also have data hold capability. In addition, the CM-650 is a true RMS reading meter.

Safety

Safety is essential in the use and maintenance of Greenlee tools and equipment. This instruction manual and any markings on the tool provide information for avoiding hazards and unsafe practices related to the use of this tool. Observe all of the safety information provided.

Purpose of This Manual

This instruction manual is intended to familiarize all personnel with the safe operation and maintenance procedures for the Greenlee CM-600 and CM-650 Clamp-on Meters.

Keep this manual available to all personnel.

Replacement manuals are available upon request at no charge at www.greenlee.com.



Do not discard this product or throw away!

For recycling information, go to www.greenlee.com.

All specifications are nominal and may change as design improvements occur. Greenlee Textron Inc. shall not be liable for damages resulting from misapplication or misuse of its products.

® Registered: The color green for electrical test instruments is a registered trademark of Greenlee Textron Inc.

KEEP THIS MANUAL

Important Safety Information



SAFETY ALERT SYMBOL

This symbol is used to call your attention to hazards or unsafe practices which could result in an injury or property damage. The signal word, defined below, indicates the severity of the hazard. The message after the signal word provides information for preventing or avoiding the hazard.

DANGER

Immediate hazards which, if not avoided, **WILL** result in severe injury or death.

WARNING

Hazards which, if not avoided, **COULD** result in severe injury or death.

CAUTION

Hazards or unsafe practices which, if not avoided, **MAY** result in injury or property damage.



WARNING

Read and understand this material before operating or servicing this equipment. Failure to understand how to safely operate this tool could result in an accident causing serious injury or death.

Important Safety Information

	⚠ WARNING
	Electric shock hazard: Contact with live circuits could result in severe injury or death.

⚠ WARNING
Electric shock and fire hazard:
<ul style="list-style-type: none">• Do not expose this unit to rain or moisture.• Do not use the unit if it is wet or damaged.• Use test leads or accessories that are appropriate for the application. Refer to the category and voltage rating of the test lead or accessory.• Inspect the test leads or accessory before use. They must be clean and dry, and the insulation must be in good condition.• Use this unit for the manufacturer's intended purpose only, as described in this manual. Any other use can impair the protection provided by the unit.
Failure to observe these warnings could result in severe injury or death.

⚠ WARNING
Electric shock hazard:
<ul style="list-style-type: none">• Verify that the unit is not in hold mode before making a measurement. The unit may be in hold mode when turned on. Hold mode is not affected by turning the unit off or by changing the position of the selector.• Do not apply more than the rated voltage between any two input terminals, or between any input terminal and earth ground.• Do not contact the test lead tips or any uninsulated portion of the accessory.
Failure to observe these warnings could result in severe injury or death.

Important Safety Information

WARNING

Electric shock hazard:

- Do not operate with the case open.
- Before opening the case, remove the test leads (or jaw) from the circuit and shut off the unit.

Failure to observe these warnings could result in severe injury or death.

WARNING

Electric shock hazard:

- Unless measuring voltage, current, or frequency, shut off and lock out power. Make sure that all capacitors are discharged. Voltage must not be present.
- Using this unit near equipment that generates electromagnetic interference can result in unstable or inaccurate readings.

Failure to observe these warnings could result in severe injury or death.

CAUTION

Electric shock hazard:

Do not change the measurement function while the test leads are connected to a component or circuit.

Failure to observe this precaution may result in injury and can damage the unit.

CAUTION

Electric shock hazard:

- Do not attempt to repair this unit. It contains no user-serviceable parts.
- Do not expose the unit to extremes in temperature or high humidity. Refer to "Specifications."

Failure to observe these precautions may result in injury and can damage the unit.

IMPORTANT



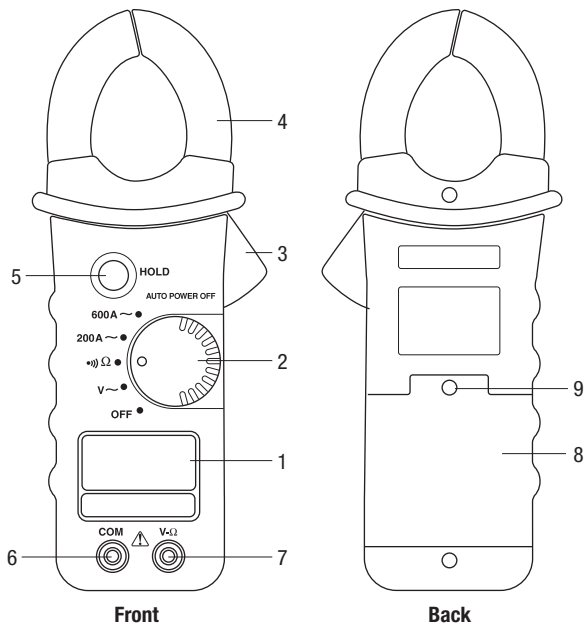

Set the selector and connect the test leads so that they correspond to the intended measurement. Incorrect settings or connections can result in a blown fuse.

Identification

1. Display
2. Selector
3. Lever
4. Jaw
5. Hold button
6. COM terminal
7. V- Ω terminal
8. Battery Cover
9. Battery Cover Screw



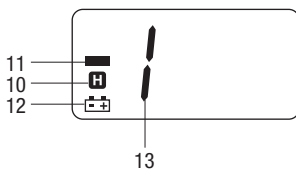

Display Icons

10.  Hold function is enabled.
11.  Polarity Indicator
12.  Low Battery
13.  Overload Indication



Symbols on the Unit

-  Warning—Read the instruction manual
-  Double insulation
-  Battery

AC Measurement



AC measurements are usually displayed as RMS (root mean squared) values. Two methods of AC measurement are average-responding RMS calibrated and true RMS-reading.

The average-responding RMS calibrated method takes the average value of the input signal, multiplies it by 1.11, and displays the result. This method is accurate if the input signal is a pure sine wave. The Greenlee CM-600 is an average-responding meter.

The true RMS-reading method uses internal circuitry to read the true RMS value. This method is accurate, within the specified crest factor limitations, whether the input signal is a pure sine wave, a square wave, sawtooth, half wave or signal with harmonics. The ability to read true RMS provides much more measurement versatility. The Greenlee CM-650 is a true RMS meter.

The Waveforms and Crest Factors table shows some typical AC signals and their RMS values.

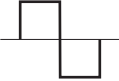
Waveforms and Crest Factors

Waveform				
RMS Value	100	100	100	100
Average Value	90	100	87	64
Crest Factor* (ξ)	1.414	1	1.73	2

* The crest factor is the ratio of the peak value to the RMS value; it is represented by the Greek letter ξ .

Operation

	<h3>⚠ WARNING</h3>
	<p>Electric shock hazard:</p> <ul style="list-style-type: none"> • Do not contact live circuits. • Verify that the unit is not in hold mode before making a measurement. <p>Failure to observe these warnings could result in severe injury or death.</p>

1. Set the selector according to the Settings Table.

Settings Table

To measure this value ...	set the selector to this symbol ...	connect the red lead to ...	and connect the black lead to ...
AC Voltage	V ~	V-Ω	COM
AC Current (200 A max.)	200A ~	N/A	N/A
AC Current (200 A to 600 A)	600A ~	N/A	N/A
Continuity	•)) Ω	V-Ω	COM
Resistance*	•)) Ω	V-Ω	COM

* Tone indicates circuit resistance is less than 50 Ω.

2. Refer to “Typical Measurements” for specific measurement instructions.
3. Test the unit on a known functioning circuit or component.
 - If the unit does not function as expected on a known functioning circuit, replace the battery.
 - If the unit still does not function as expected, send the unit to Greenlee for repair. Refer to the instructions under the Warranty.
4. Verify that the unit is not in hold mode, and then take the reading from the circuit or component to be tested.
5. Press **HOLD** to hold the measured value on the display. Press **HOLD** again to exit hold mode.

Auto Power Off

When the meter is powered on, a timer is activated that will turn the unit off after approximately 30 minutes. To continue making measurements after the unit automatically powers off, switch the selector to **OFF** and then back to the desired function.

Typical Measurements

Clamp Around Wire

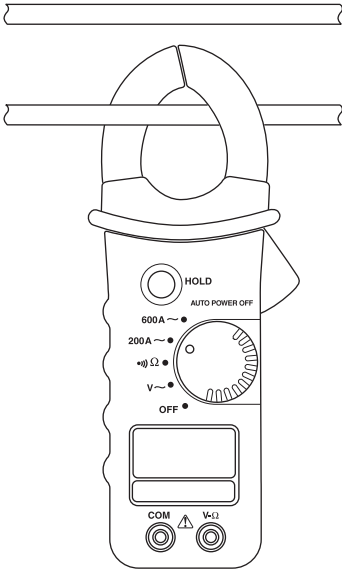

Notes:

- Clamp the jaw around one conductor only.
- Close the jaw completely.
- Center the wire in the jaw for highest accuracy.

Clamp Around Line Splitter

Notes:

- The Greenlee 93-30 Line Splitter is divided. One section renders amps; the other renders amps multiplied by 10.
- Close the jaw completely.
- Center the line splitter in the jaw for highest accuracy.

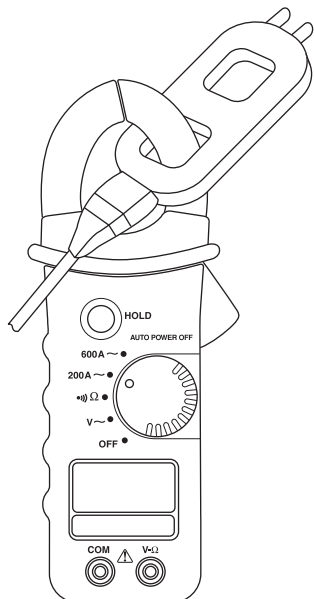

Accuracy

Accuracy is specified as follows: \pm (a percentage of the reading + a fixed amount) at $23\text{ }^{\circ}\text{C} \pm 5\text{ }^{\circ}\text{C}$ ($73.4\text{ }^{\circ}\text{F} \pm 9\text{ }^{\circ}\text{F}$), 0% - 75% relative humidity.

Refer to the “Specifications” section for operating conditions.

Value	Range	Accuracy	Frequency Range	Input Impedance
AC Voltage	0 to 600 V	$\pm (1.2\% + 3\text{ V})$	40 to 500 Hz	2 M Ω 2 nF
AC Current (200 A range)	0 to 199.9 A	$\pm (1.9\% + 0.5\text{ A})$	50/60 Hz	N/A
AC Current (600 A range)	0 to 400 A	$\pm (1.5\% + 5\text{ A})$	50/60 Hz	N/A
	400 to 600 A	$\pm (2.5\% + 5\text{ A})$	50/60 Hz	
Resistance*	0 to 2000 Ω	$\pm (1.5\% + 2\text{ } \Omega)$	N/A	N/A

* Maximum open circuit voltage: 1 V

Continuity

Threshold: Tone sounds if the measured resistance is less than approximately 50 Ω , and turns off when greater than approximately 300 Ω .

For the CM-600, AC accuracy is specified for sine waves only.

For the CM-650, accuracy specification applies for waveforms with crest factors less than 2.

- For crest factors from 2 to 3, add 1.4% to accuracy.
- For crest factors from 3 to 4, add 3% to accuracy.

Specifications

Display: 3-1/2-digit LCD (1999 maximum reading)

Sampling Rate: 4 per second

Low Battery Indication: 

Jaw Opening: 35 mm (1.38")

Maximum Conductor Diameter: 33 mm (1.30")

Overvoltage Category: Category III, 600 V

Temperature Coefficient: 0.2 x (specified accuracy) per °C below 18 °C or above 28 °C

Operating Conditions: 0 °C to 45 °C (32 °F to 113 °F), 0% to 75% relative humidity

Storage Conditions: -20 °C to 60 °C (-4 °F to 140° F), 0% to 80% relative humidity

Remove battery.

Indoor use only.

Altitude: 2000 m (6500') maximum

Pollution Degree: 2

Battery: 9-Volt battery (NEDA 1604, JIS 006P or IEC 6LF22)

Battery Replacement

WARNING

Electric shock hazard:

Before opening the case, remove the test leads (or jaw) from the circuit and shut off the unit.

Failure to observe these warnings could result in severe injury or death.

1. Disconnect the unit from the circuit. Turn the unit OFF.
2. Remove the battery cover screw.
3. Remove the battery cover.
4. Replace the battery (observe polarity).
5. Replace the cover and screws.

Cleaning

Periodically wipe the case with a damp cloth and mild detergent; do not use abrasives or solvents.

Lifetime Limited Warranty

Greenlee Textron Inc. warrants to the original purchaser of these goods for use that these products will be free from defects in workmanship and material for their useful life, excepting normal wear and abuse. This warranty is subject to the same terms and conditions contained in Greenlee Textron Inc.'s standard one-year limited warranty.

For all Test Instrument repairs, contact Customer Service at 800-435-0786 and request a Return Authorization.

For items not covered under warranty (such as items dropped, abused, etc.), a repair cost quote is available upon request.

Note: Prior to returning any test instrument, please check replaceable batteries or make sure the battery is at full charge.



GREENLEE®

A Textron Company

USA	800-435-0786	Fax: 800-451-2632
	815-397-7070	Fax: 815-397-1865
Canada	800-435-0786	Fax: 800-524-2853
International	+1-815-397-7070	Fax: +1-815-397-9247

4455 Boeing Drive • Rockford, IL 61109-2988 • USA • 815-397-7070
An ISO 9001 Company • Greenlee Textron Inc. is a subsidiary of Textron Inc.

www.greenlee.com