

# Clear Edge Filtration

## CERAFIL™

# Overview of Ceramic & Hot Gas Filtration

Mc Ilvaine

Webinar July 12<sup>th</sup> 2012

Richard Lydon

VP Technology & Business Development

Ian Chisem

IP & Business Development Manager

Dirk Otto

Director & Sales Marketing

Mark Daniel

Product Manager/Director – Cerafil & CFE Sales

# CLEAR | EDGE™

## Filtration

### **Mission Statement**

It is the mission of Clear Edge Filtration to be a leading global company, supplying industrial filtration products and filter media to companies engaged in filtering liquids from solids, dewatering, collecting and filtering dust, air filtration, filtering and purifying hot gases and other niche industrial process applications.

A leading company provides top quality products, excellent customer service, and leading edge technical support to its customers. They deliver consistent growth and above average profitability to its shareholders. Leading companies also provide their employees with safe, challenging, and rewarding work environment where mutual respect governs all relationships.

# Clear Edge Presence and coverage

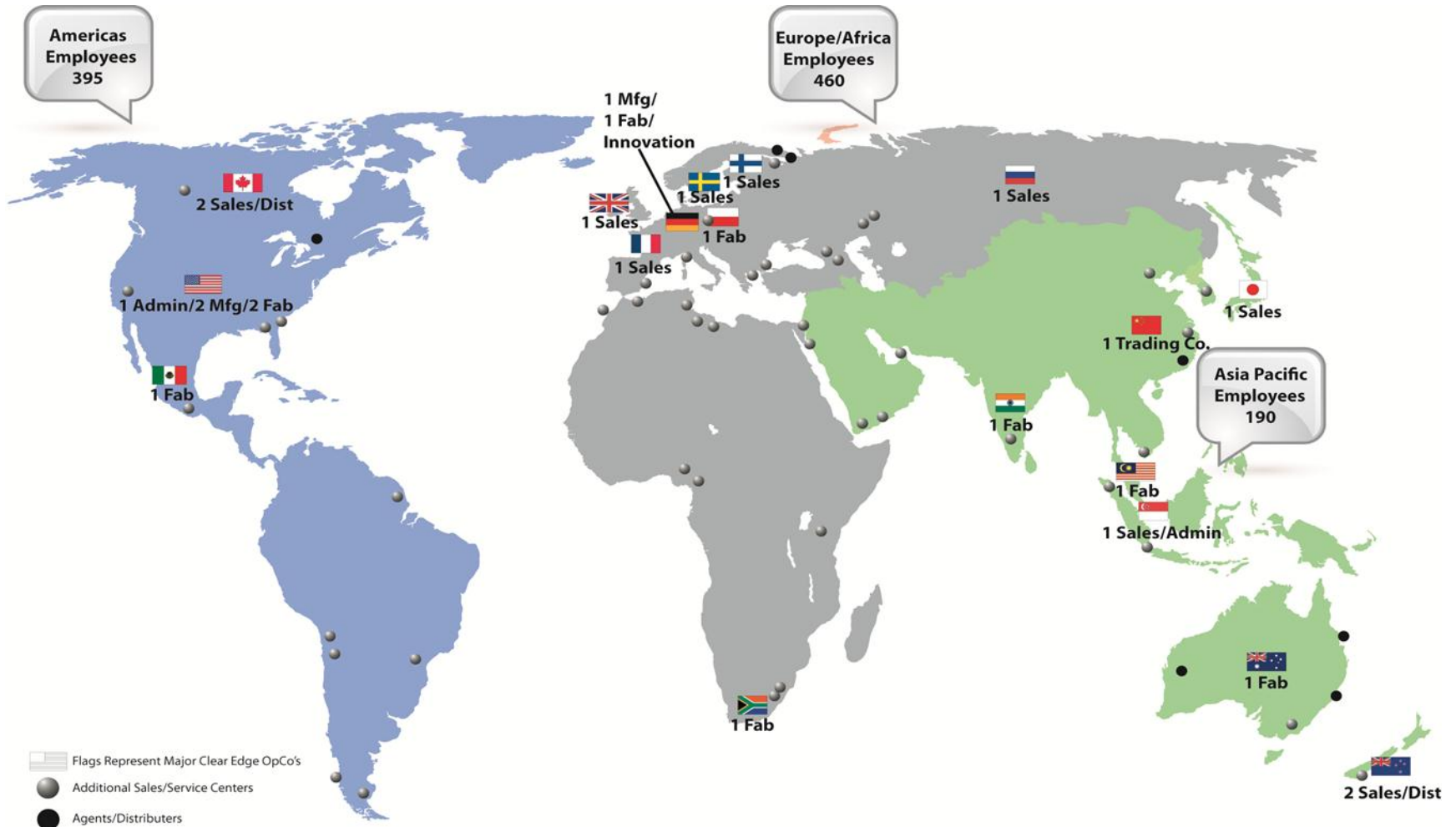

# Ceramic filter duties

- Air pollution control (APC)
- Product recovery
- Product collection

*realised by:*

- Tighten Environmental legislation
- A new filter plant installation
- A bag filter retrofit
- An electrostatic filter (ESP) retrofit



# Ceramic filter benefits

- **High efficiency**
  - Less than 2 mg/m<sup>3</sup> emissions
  - Handles sub-micron particles
- **High temperature capability**
  - Temperature resistant up to 900°C
- **Corrosion resistant**
  - Almost chemically inert
- **Works well in conjunction with a dry scrubbing agent**
- **Range of products and sizes**
  - Aluminosilicate, mineral fibre and catalytic products
  - Up to 3000 mm long by 150mm diameter

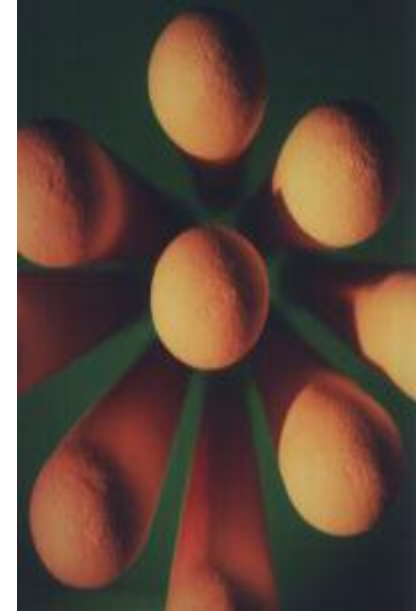



# Ceramic filters characteristics

- Rigid candles which are employed like fabric bags in filter plants
- Capable of operating at elevated temperature
- Applied to “hot” processes where clean off gas is required
- On the market since the mid 1980's
- 100's of references worldwide



# Ceramic filter properties

- Ceramic or mineral fibre composition
- Rigid
- Highly porous structure
- One piece construction
- Self supporting

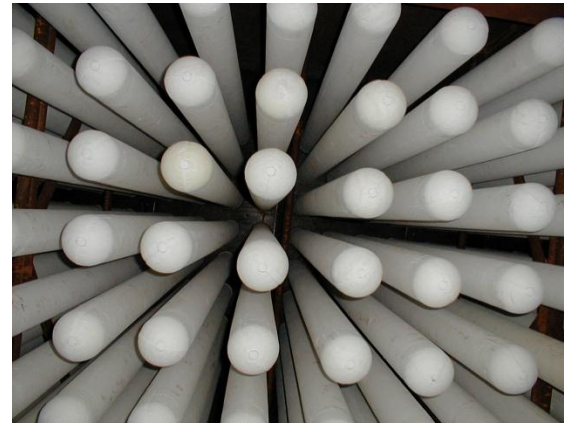
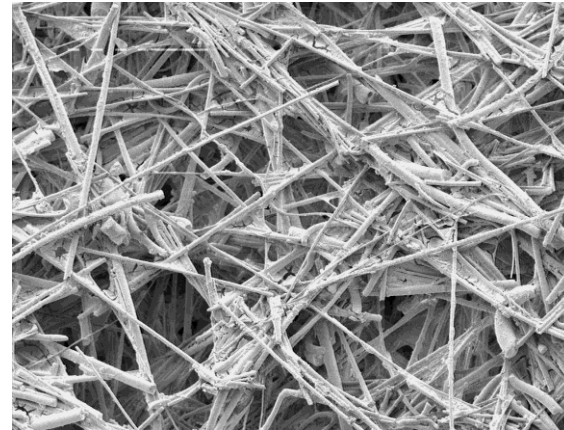

# Filtration mechanism

- High filtration efficiency
- Negligible depth penetration
- Can handle variable conditions
- Potential for long life

Efficiency testing to VDI 3926			
Cleaning cycles		30	2334
dP trigger	Pa	1000	1000
Residual dP	Pa	570	770
Inlet gas conc.	gm/Nm <sup>3</sup>	5	5
Clean gas conc.	mg/Nm <sup>3</sup>	0.37	0.26

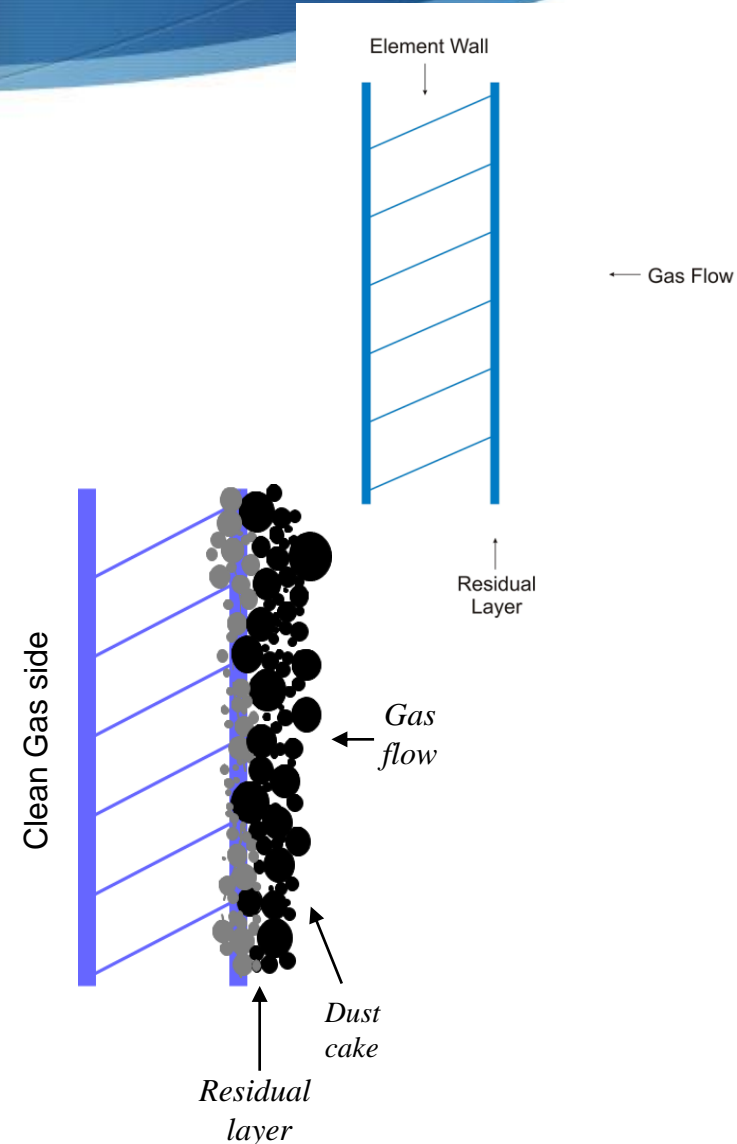



# Benefits of high temperature filtration

- Move away from temperature limitations of fabric bags
- Reduced requirement for dilution = smaller plant
- Avoid acid and water dew-points = minimise plant corrosion
- Effective acid gas scrubbing
- Maintain gas temperature for optimal De NO<sub>x</sub>, SO<sub>x</sub>, etc.
- Potential for heat recovery from clean gas
- Increased stack buoyancy

# Cerafil products

- **XS**
  - Market leading ceramic element
  - 200+ successful references spanning 15 years
- **Green**
  - Manufactured from bio-soluble fibres
  - Excellent strength + performance
- **TopKat**
  - Combined particulate, dioxin and NOx control
  - The solution for stringent emissions legislation

# Catalytic filter technology

## Cerafil TopKat



### ***CERAFIL TopKat***

*Combination of two well established and effective technologies*

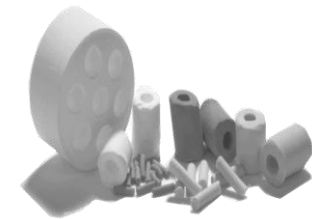

**Cerafil XS**



**SCR**



# Catalytic element performance

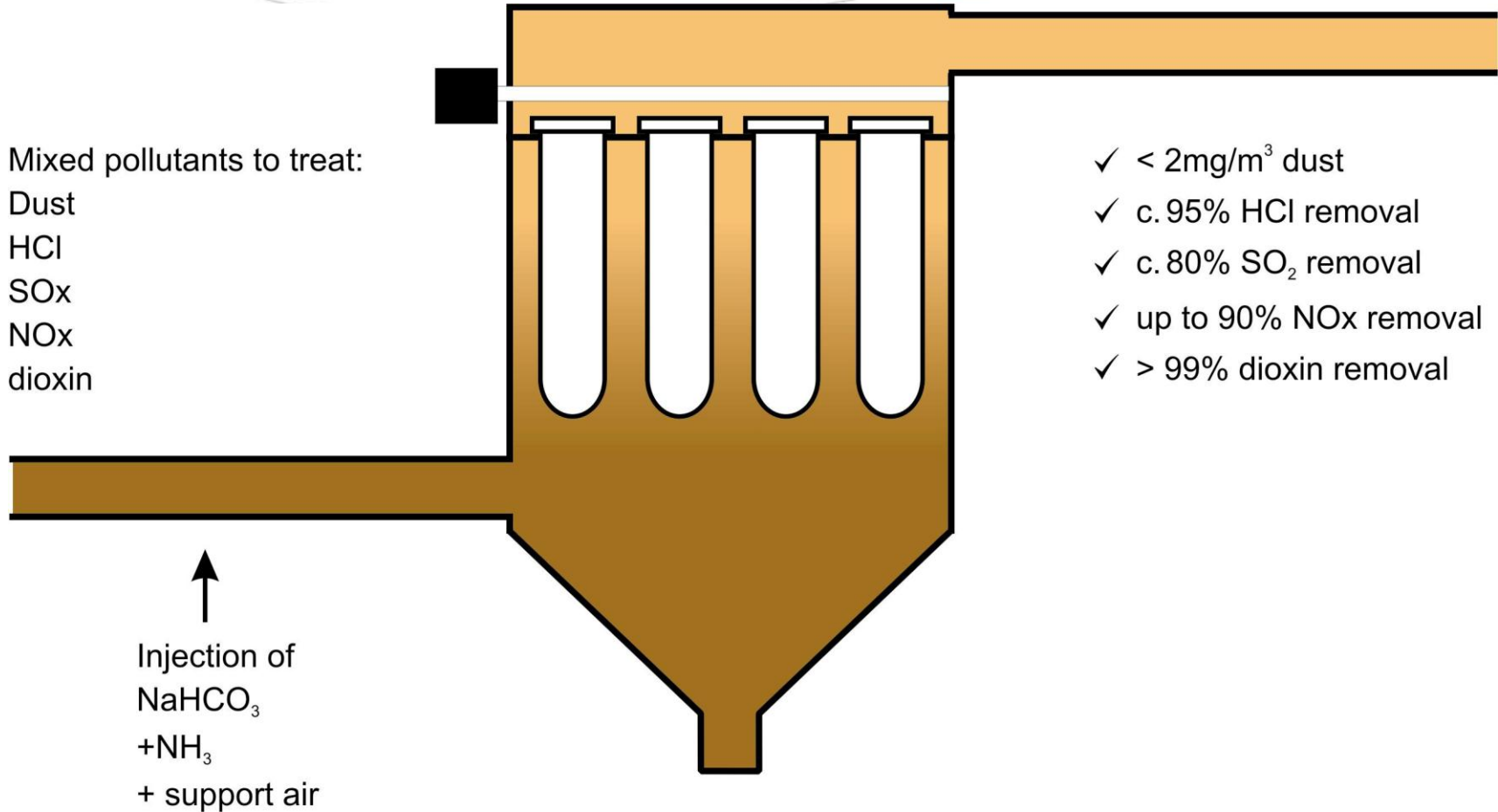

# Catalyst distribution

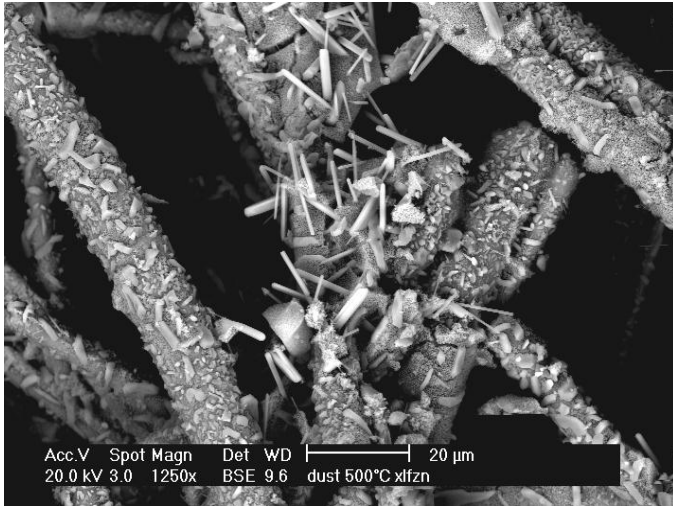

Nano sized catalyst particles promote access to active surfaces

Catalyst distributed throughout element wall

Residence time and efficiency maximised

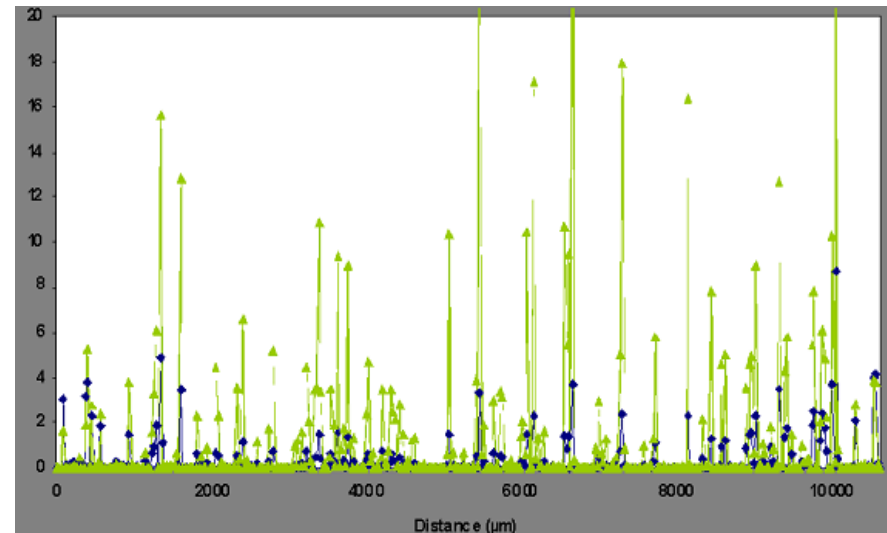



# Filter plant configuration

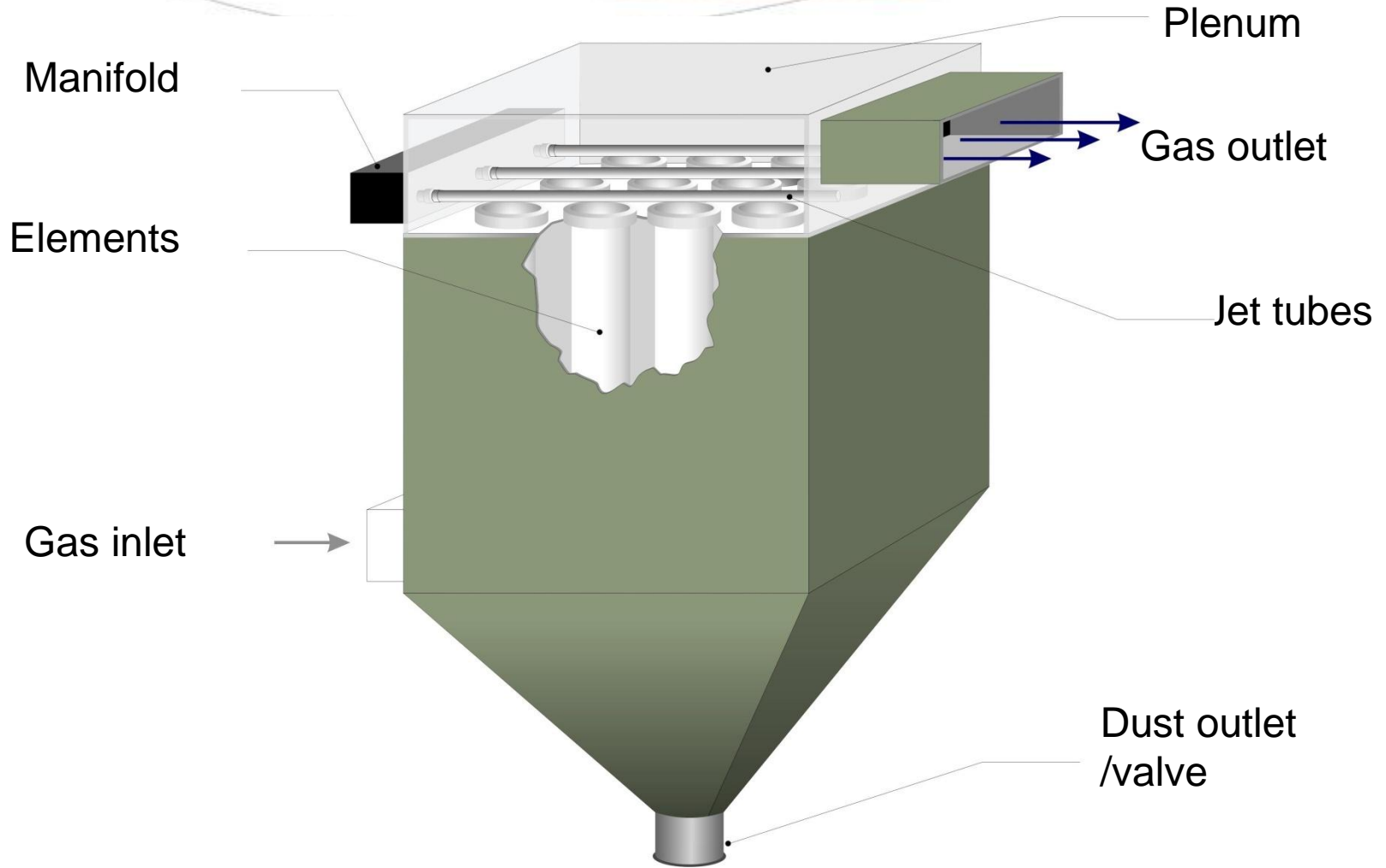

# Filter plant layout

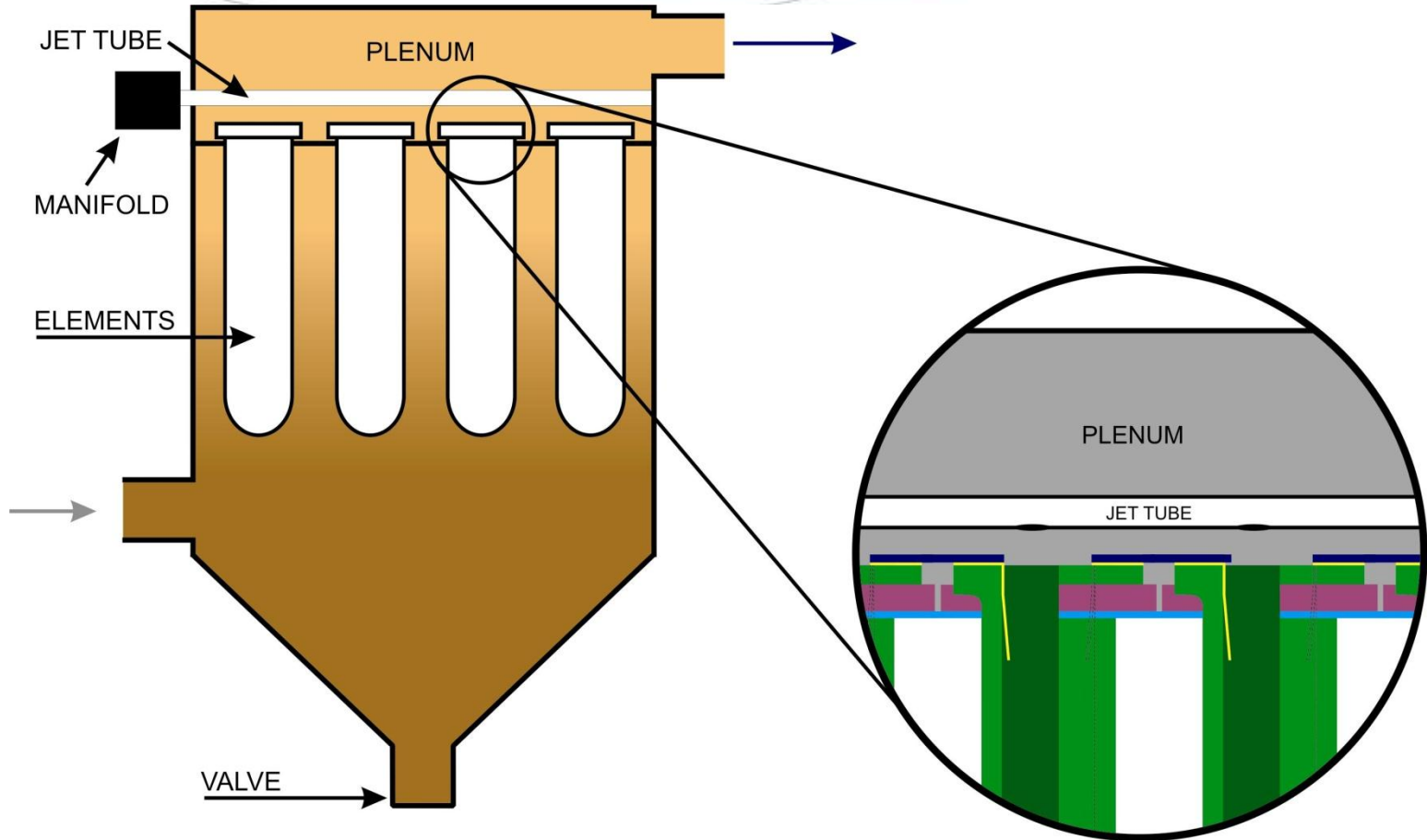

# Element clamping & cleaning



# Applications, such as

- Cement production
- Chemicals manufacture
- Diesel Engines
- Gasification processes
- Glass furnaces
- Metal smelting
- Mineral processing
- Sewage sludge incineration
- Waste incineration



# Case study

## Meat waste incineration

- 80 off TopKat-3000 elements
- 112 m<sup>2</sup> filter area
- Filtration temp- 220°C
- O<sub>2</sub> inlet conc.- 9-15 vol%
- NO<sub>x</sub> inlet conc.- 220±20 ppmV
- Face velocity- 1.2 cm/s
- Pressure drop- 1.8 KPa
- Nov 2005 official testing
  - Dioxins- 0.011 & 0.0013 ng/Nm<sup>3</sup>
  - Particulate- 1.2, 1.1 & 1.8 mg/Nm<sup>3</sup>





# Clinical waste incineration, UK

- 270 TK 1000
- Gas flow @ filter exit 2000 – 2500 Nm<sup>3</sup>/h
- Temperature: 155°C
- Filter element surface velocity: 1.7 – 2.1 cm/s
- Dioxin inlet: 75 ± 10 ng DE/Nm<sup>3</sup> @ 11% O<sub>2</sub> dry
- Dioxin outlet compartment with CERAFIL TK: 0.55 ± 0.2 ng DE/Nm<sup>3</sup> @ 11% O<sub>2</sub> dry
- Dioxin removal efficiency: 99.2 %
- Dust removal efficiency: >99.9 %



# Platinum smelting, South Africa

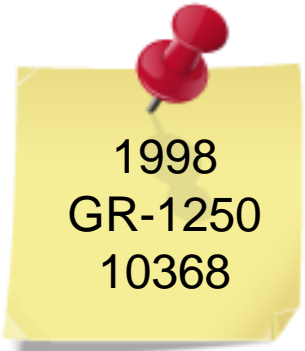

1998  
GR-1250  
10368

# Asphalt reclamation, Netherlands



2006  
XS-3000  
2640



# Glass Furnace, Spain



2009  
TK-3000  
1900

# Case Study

## Waste to Energy (WtE) Power Plant

- 4.000 XS x 2,250mm long
- Newly developed advanced Waste to Energy (WtE) technology at the Lahti Energia, Kymijärvi II plant in Finland.
- First in the world to be fueled by clean gas produced from Solid Recovered Fuel (SRF).
- SRF fuel is fed into the gasification reactor where it is surrounded by a hot sand fluidised bed at circa 900°C. The bed material and unreacted fuel is recycled back to the gasifier via a recycling cyclone.
- The gas is then cooled to approximately 450°C where the impurities in the fuel turn into solid state ash suspended in the gas stream.
- SRF feed rate - 360 cm<sup>3</sup>/h (250,000 t/pa)
- Boiler steam temp - 540<sup>0</sup> C & pressure - 121 bar

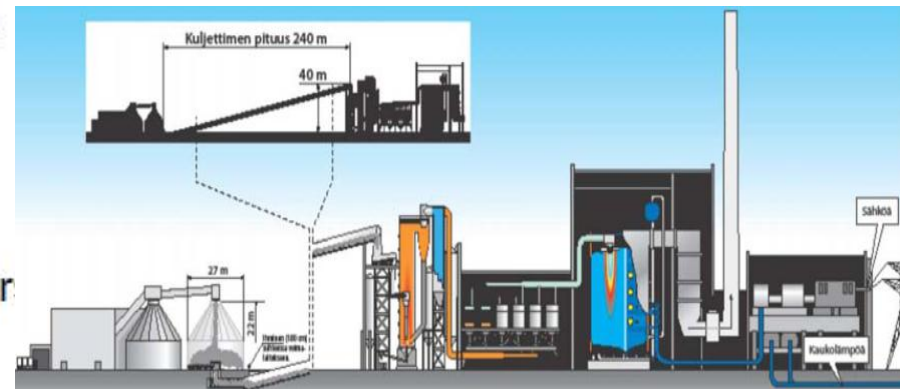



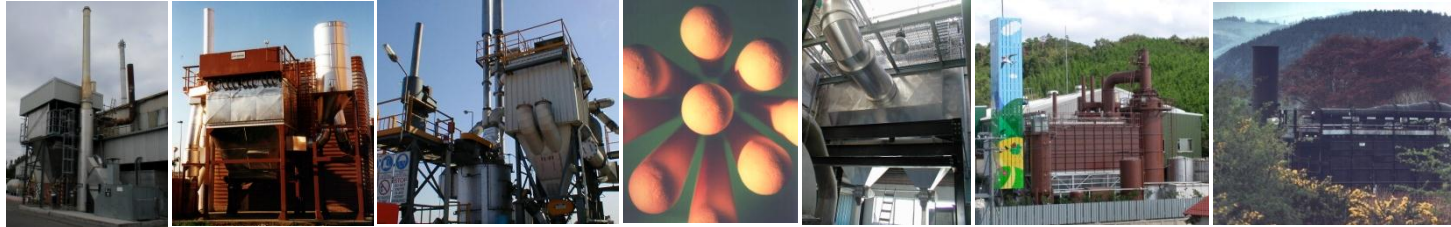

Thank you

[info@clear-edge.com](mailto:info@clear-edge.com)

