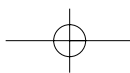
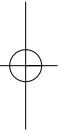
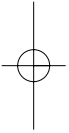
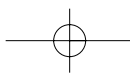
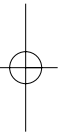
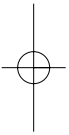
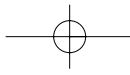
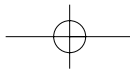


# CLOSE RANGE COMBAT WING CHUN







# CLOSE RANGE COMBAT **WING CHUN**

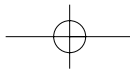
**MOOK YAN JOANG**  
**(WOODEN MAN DUMMY FORM,  
DRILLS AND APPLICATIONS)**

**VOLUME 3**

---

**RANDY WILLIAMS**

**UP** UNIQUE PUBLICATIONS  
Burbank, California



**Disclaimer**

Please note that the author and publisher of this book are NOT RESPONSIBLE in any manner whatsoever for any injury that may result from practicing the techniques and/or following the instructions given within. Since the physical activities described herein may be too strenuous in nature for some readers to engage in safely, it is essential that a physician be consulted prior to training.

First published in 2004 by Unique Publications.

Copyright © 2003 by CFW Enterprises, Inc.

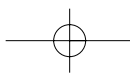
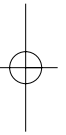
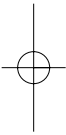
All rights reserved. No part of this publication may be reproduced or utilized in any form or by any means, electronic or mechanical, including photocopying, recording, or by any information storage and retrieval system, without prior written permission from Unique Publications.

Library of Congress Catalog Number: 2002  
ISBN:

Unique Publications  
4201 Vanowen Place  
Burbank, CA 91505  
(800) 332-3330  
First edition  
05 04 03 02 01 00 99 98 97 1 3 5 7 9 10 8 6 4 2

Printed in the United States of America

Editor: John S. Soet  
Design: Patrick Gross  
Cover Design: George Chen



# DEDICATION

This series of books is dedicated to the memory of two favorite CRCA members from the past; Paul Green, whom we tragically lost on May 18, 2001, during the production of this book and Larry Jordan, a good friend and student who loved the art of Wing Chun and is still sorely missed twenty years later by all of us who knew him.

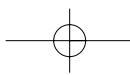
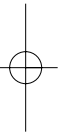
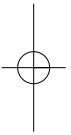
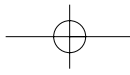
Also during the production of this book, my very good friend Guy Seiji Kurose passed away. He was a 6th degree black belt in Goju-Ryu Karate and was best known for his dedication to children and youth, as well as his high spirit, laughter, and quickness of mind.

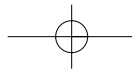


*Guy S. Kurose*  
1952–2002

*Lawrence A. Jordan*  
1956–1982

*Paul M. Green*  
1969–2001





# CONTENTS

FOREWORD BY PROF. DANIEL LEE . . . . . 8

WOODEN MAN . . . . . 10

MOOK YAN JOANG . . . . . 13

DUMMY STRUCTURE . . . . . 15

BUILDING AND INSTALLING THE DUMMY . . . . . 21  
     WOODEN DUMMY PLANS . . . . . 24

PRELIMINARIES . . . . . 31

BENEFITS OF WOODEN DUMMY TRAINING . . . . . 35

THE “108” . . . . . 39

THE EIGHT KICKS AND THE WOODEN DUMMY . . . . . 43

WOODEN DUMMY FORM (PART I) . . . . . 49

WOODEN DUMMY FORM (PART II) . . . . . 101

MOOK YAN JOANG FOT YUT LING BOT FORM SEQUENCE . . . . . 137

MAIN POINTS OF WOODEN DUMMY TRAINING . . . . . 143

SAN SAU—PRACTICAL APPLICATIONS . . . . . 145  
     PART I . . . . . 146  
     PART II . . . . . 191

“YUT DING FOT” . . . . . 233

WOODEN DUMMY DRILLS . . . . . 237

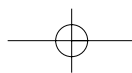
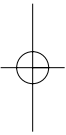
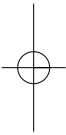
IRON PALM . . . . . 249

EFFECTS OF IRON PALM TRAINING . . . . . 253

THE IRON PALM TRAINING SEQUENCE . . . . . 259

THE TEN IRON HAND MOTIONS . . . . . 263  
     IRON PALM TRAINING TABLE PLANS . . . . . 268

ACKNOWLEDGEMENTS . . . . . 269



## FOREWORD

Wing Chun Kung Fu is regarded as one of the most scientific Chinese fighting systems in the world. This combat system is known for its speed and simplicity. It is brutally effective in close range combat, stressing economy in motion and centerline attacks.

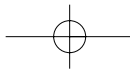
To receive the proper training in Wing Chun, a student must start with the training of *Siu Leem Tau*, the first hand form, and learn to execute all the basic hand techniques in a stationary, toe-in, pyramid stance. Then he progresses to Chum Kiu, the second form, in order to develop agility, mobility, and balance through stance pivoting and combination of hand and foot techniques. After mastering the two-hand forms, the student is then ready to launch into the training of Mook Yan Joang, the Wooden Dummy form, as well as Chi Sao, sticking-hand training. Later, he can further his training in Wing Chun weapons—the Wing Chun Butterfly Knives and the Six-and-a-Half-Point Pole.



My exposure to Wing Chun Kung Fu started in an unusual way. I was fortunate to have studied the art of Jeet Kune Do (JKD) with Bruce Lee in 1967 at his Los Angeles Chinatown school. I noticed that the core material and terminologies used in JKD were all derived from Wing Chun. When I practiced Chi Sau with Bruce, I experienced his marvelous pliable and explosive energies, which he had acquired through years of training in Wing Chun. It was then that I decided that I would take up Wing Chun some day. I continued my JKD training even after Bruce's untimely death in 1973. It was in 1980 that I had the good fortune to start my formal Wing Chun training with Sifu Jim Lau, a well-known Wing Chun teacher in the Los Angeles area, and I still practice what I have learned to this date.

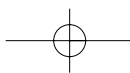
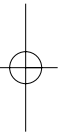
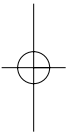
In my experience, a student who wishes to learn Wing Chun Kung Fu must look for a qualified teacher. Sifu Randy Williams is such a teacher who comes from a solid lineage and has had many years of experience. He has written extensively on Wing Chun Kung Fu and is well known for his training video programs. I am impressed with his skills in





Wing Chun Kung Fu and his ability to teach Wing Chun in a clear and systematic way. There are books written on the three Wing Chun forms and on the Wooden Dummy set, but there had not been a single book written that covers the entire Wooden Dummy set until Sifu Williams published his first book. He has finally completed his long awaited second edition of his book on the complete 108-form Wooden Dummy set. The book is based on his years of research and personal training. The book offers clear photographs of each movement, couple with the top view of the foot position with reference to the Wooden Dummy. In addition, the Cantonese pronunciation and description of each movement is clearly given. It is a detailed and comprehensive training manual for students who want to seriously study the Wooden Dummy set. It has been a valuable reference manual for me personally. I want to congratulate Sifu Williams for his monumental work and for his contribution to the advancement fo Wing Chun Kung Fu in the martial arts world. I highly recommend that all Wing Chun students add this wonderful book to their martial-arts library.

—Prof. Daniel Lee



# 木人樁

木人樁法一零八  
多煉勁力得其法  
力由心發射樁心  
步型轉換纏樁身  
上下一往來有摺疊  
功力增強難測箕  
橋橋樁手食著行  
橋勁煉成威力生  
勁力發得如心願  
線位用得正好難輸

## **Wooden Man**

### ***Mook Yan Joang Fot Yut Ling Bot***

There are one hundred and eight Wooden Dummy techniques.

### ***Doh Leen Ging Lick Duck Kay Fot***

Repeated practice brings proper use of energy and power.

### ***Lick Yau Sum Fot Sheh Joang Sum***

Power comes from the heart and shoots straight to the core of the Dummy.

### ***Boh Ying Juen Woon Chuen Joang Sun***

Footwork varies while maintaining close proximity to the body of the Dummy.

### ***Syeung Ha Woang Loy Yau Jeep Deet***

Movements go upward, downward, back and forth with continuity.

### ***Goang Lick Jahng Kyeung Lahng Chock Shuen***

Improvement of strength and power cannot be accurately gauged.

### ***Kiu Chee Joang Sau Sick Joke Hahng***

The Arm Bridge sticks to the arm of the Dummy while moving.

### ***Chee Ging Leen Sing Wai Lick Sahng***

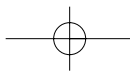
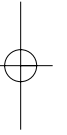
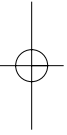
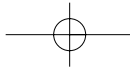
Sticking power, when achieved, is a commanding force.

### ***Ging Lick Fot Duck Yee Sum Yuen***

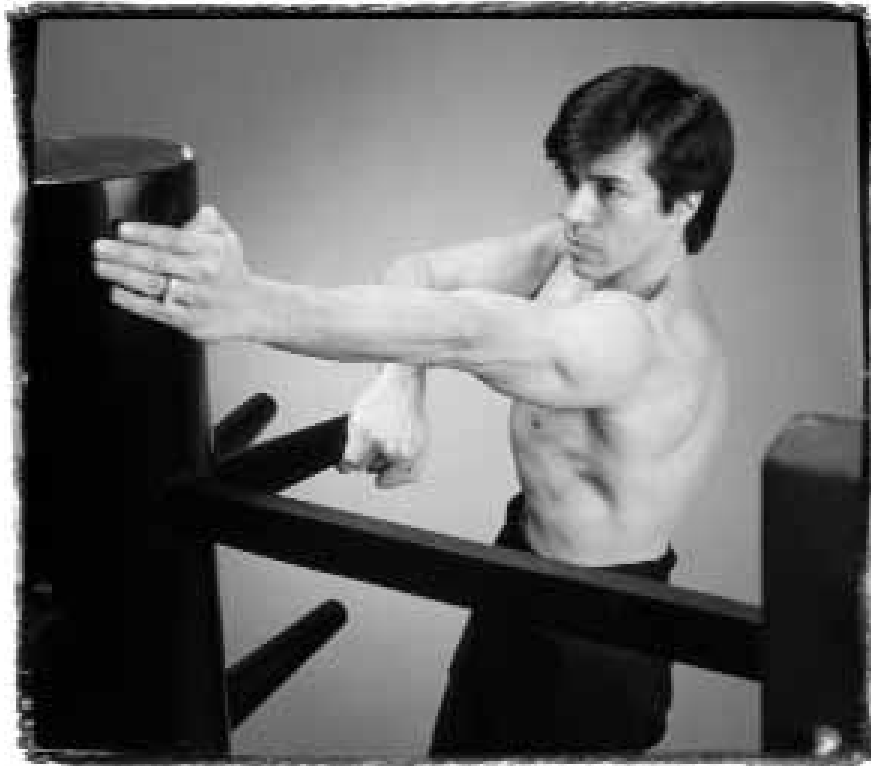
Power and energy can be released as intended.

### ***Seen Wai Yoang Duck Hoh Lahng Chue***

Use of the Centerline will be proper and therefore hard to defeat.



## MOOK YAN JOANG



木  
人  
樁

*Joang Sau*, literally “Dummy Hand,” is the Chinese term for the techniques of the *Mook Yan Joang*, or “Wooden Man Dummy.” The *Mook Yan Joang* is a training device used by many different styles of Chinese Gung Fu such as Choy Lay Fut and Praying Mantis, but is probably most often identified with the Wing Chun system.

The first form of Wooden Man was used in the Shaolin temple of ancient China, where legend has it that in order to graduate from the temple, a disciple had to fight his way out through a complex maze of 108 different Wooden Dummies, some of which were spring-loaded and could inflict fatal injury if not dealt with correctly, others which were mechanically operated by concealed onlookers. It is even rumored that some of the Wooden Men were actually elder monks wearing wooden armor.

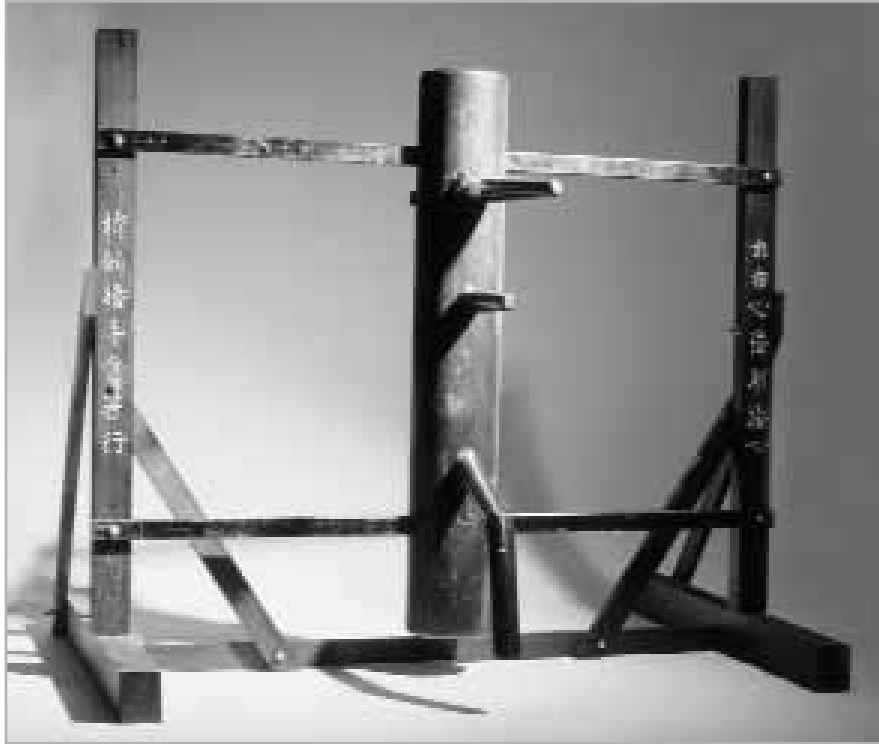
### Close Range Combat Wing Chun: Volume Three

---

*Fig. 236—Another Chinese Gung Fu system that uses a Wooden Dummy as part of its training program is the Choy Lay Fut style. The Balance Dummy is one of a few different types used by Choy Lay Fut practitioners.*



# DUMMY STRUCTURE



*Fig. 237—The Wing Chun Wooden Dummy.*

Various Gung Fu styles use the Wooden Man differently, and the actual Dummy itself will vary in size, shape and configuration depending on the style using it. The Wing Chun Wooden Dummy is constructed from a round hardwood post 4'7" tall and 8"-9" in diameter. This post serves as a trunk, which is suspended in air by two horizontal crossbeams that pass through it and hold it at the proper level as determined by the height of the individual trainee. These beams should be made of a resilient wood during the early phases of Wooden Dummy training. As the practitioner becomes more accustomed to contact with the hardwood Dummy arms and leg, the crossbeams can be replaced with metal bars that reduce the amount of "play" and recoil of the Dummy when hit.

The Wooden Man has three arms set at strategic angles and one leg that extends from its center. The tenons attached to the arms and leg are

### Close Range Combat Wing Chun: Volume Three

---

fitted loosely within square mortised holes through the trunk. These holes are square to prevent rolling of the Dummy arm when it is hit and also to guide the trainee's arm to snap the Dummy arm into whichever corner is appropriate for the technique being executed. For example, the Boang Sau Wing Arm Deflection should snap the Dummy arm up into the high corner opposite the Boang arm. The holes in the Dummy trunk through which the horizontal crossbeams pass are also square for stability and to enable the trainee to smoothly snap each individual element squarely to its limit against the next with a correctly powered and angled technique. Thus, the same Boang Sau not only snaps the Dummy arm to its limit of motion within the square arm hole, but if correct snap and leverage is applied, the entire Dummy trunk will make a short arcing pivot on its Motherline, until the front vertical side of the trunk hole opposite the Boang arm snaps squarely against the front face of the horizontal cross-beam. To illustrate this point, a simple experiment can be performed:

Put one palm on each side of the head area of the Dummy trunk. Holding the trunk firmly between the hands, twist the Dummy to the left and right and note that it is able to pivot on its Motherline to the point where the front of one side of the trunk hole and the rear of the other side reach their limits (the crossbeam).

Other elements in the "linkage" of the Dummy structure are the pins that prevent the arms and leg from being pulled completely out of the Dummy by grabbing or jerking hand techniques and hooking leg motions. Because the pins do not hold the Dummy arms tightly against the trunk, in motions without Yin/Yang Structure created by a stance pivot, the pin can substitute for the corner of the arm hole, allowing the Dummy arm to be pulled a short distance out from the Dummy trunk before snapping to its limit. For example, the Syeung Loy Jut Sau motion seen repeatedly throughout the form first pulls the two upper Dummy arms to their forward limit (the pins) and then the entire Dummy trunk forward to its limit as the rear insides of the square trunk holes snap squarely against the rear faces of the two horizontal crossbeams. Similarly, the double Pau Jyeung motion that follows first snaps the Dummy arms back to their backward limit and then pushes the Dummy trunk back to the point where the front inside faces of the trunk holes snap flat against the front faces of the crossbeams. Due to the multi-directional nature of Wing Chun power, each Dummy technique should snap the arm tenon(s) to either side of the armhole mortise(s) or pin(s), and the entire Dummy trunk to its limit of forward, backward or pivoting movement on the horizontal crossbeams. Any technique that fails to do this is either incorrectly executed, insufficiently powered, or both.

Each part of the Dummy represents one or more parts of the human



## Dummy Structure

---

anatomy, depending on the technique being practiced. For example, the Dummy's low arm can alternately simulate a low punch, a mid-level kick or the groin area for kicking attacks. In this way, the Dummy represents a live opponent, and every move performed on it can be translated to live action once the "language" of the Dummy is fully understood.

The reason the arms are not the same length as the entire arm of a real opponent is that they are designed to simulate the forearm only—not the upper arm. In this way, Dummy training teaches the student to block, grab or otherwise trap the opponent's Arm Bridge. This is why the three arms are approximately the same shape, length and diameter of the human forearm, tapering to a wrist and without hands.

It is vital to the trainee that the Dummy is not only built to absolutely correct specifications, but that it is mounted at the correct height, which is determined by the trainee standing in front of the Dummy in the "Yee" Jee Keem Yeung Ma "Figure 2" Pigeon-toed Horse Stance. While facing the Wooden Man in this position, the two upper Dummy arms should be level with the lower part of the trainee's chest. There should be enough space between the bottom of the Dummy leg and the floor for the trainee's foot to slide underneath the leg. This space allows the trainee to slide his foot smoothly along the floor, directly from one position to the next without obstruction when executing any Moving Stance in a technique that does not relate to the Dummy leg. If the trainee finds that the Dummy leg touches the ground when the Dummy is suspended at the correct height, three to four inches should be cut off from the bottom of the leg to allow clearance of the foot. Mounting the Dummy at this height will help the trainee develop a lower, more solidly "rooted" stance even when smoothly moving around the Wooden Man with flowing footwork patterns. Padding the trunk is optional, but not recommended by the author. The arms, however, should never be padded or overly smooth from lacquering and should retain the natural texture of the wood. The entire Dummy framework should be mounted on a smooth, level wooden, concrete or tile floor or a large platform. This will facilitate quick, gliding footwork to complement the execution of hand techniques.

Close Range Combat Wing Chun: Volume Three

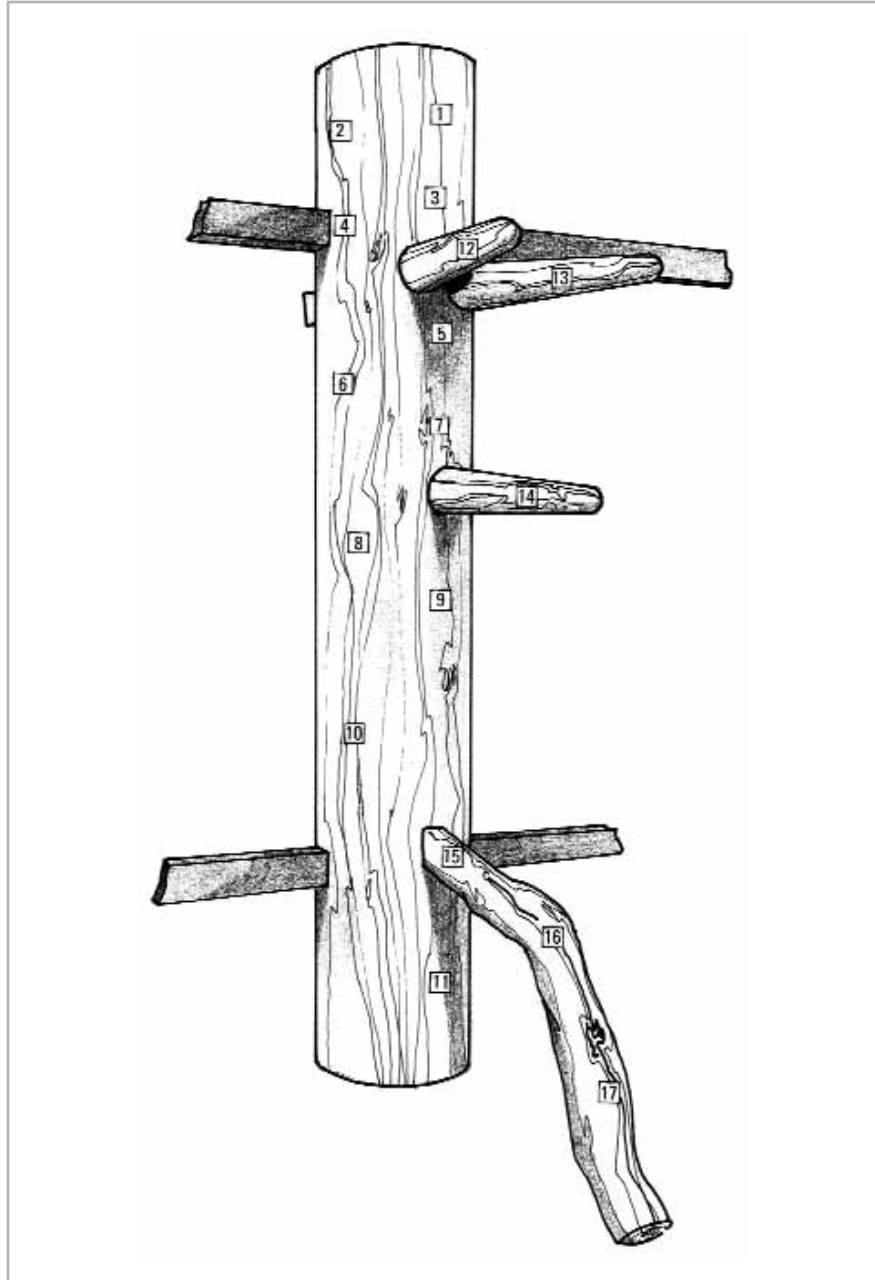
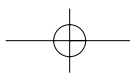
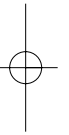
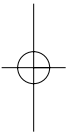
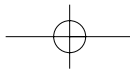
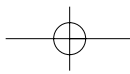


Diagram LL—Areas of the Wooden Dummy.

**Dummy Structure**

<b><i>Area of Dummy</i></b>	<b><i>Area of Body Represented</i></b>
1. High central area of upper trunk	Face, back of head
2. High lateral area of upper trunk	Temple, ear, neck, jaw
3. Area above upper Dummy arms	Throat, neck
4. Mid-lateral area of upper trunk	Side of head, back of head, shoulder
5. Mid-central area of upper trunk	Heart, upper spine
6. Low lateral area of upper trunk	Ribs, vital organs, middle of spine
7. Low central area of upper trunk	Diaphragm, stomach, lower spine
8. High lateral area of lower trunk	Groin, kidney, hip, tailbone
9. High central area of lower trunk	Groin, Don Teen, thigh, hip, tailbone
10. Mid-lateral area of lower trunk	Front thigh, side thigh
11. Low central area of lower trunk	Rear shin
12. Left upper Dummy arm	Arm Bridge
13. Right upper Dummy arm	Arm Bridge
14. Low Dummy arm	Arm Bridge, Leg Bridge, groin area
15. Top surface of Dummy leg	Upper knee, thigh, downed opponent
16. Knee area of Dummy leg	Inner knee, outer knee, kneecap
17. Shin area of Dummy leg	Leg Bridge

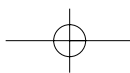




# BUILDING AND INSTALLING THE DUMMY

Plans to build the traditional Mook Yan Joang can be found at the end of this essay, along with plans for a portable, collapsible stand of my own design. Traditionally, the Wing Chun Wooden Dummy is mounted across two vertical uprights, which are themselves anchored at least two feet into the ground. This is of course the most solid method of installing the Dummy and should be used if the trainee has the facility for doing so. In my experience, the best results are obtained when a jackhammer is used to break two 8" diameter holes in a smooth concrete surface at a distance of 69" apart (center-to-center), with at least four inches of clearance from the wall behind them. Once the concrete has been broken through, a small hand spade is then used to dig beneath the surface to minimum depth of two feet. Two 4" x 4" x 7' beams should then be dropped into the holes and a temporary 2" x 4" plank nailed across their front faces to keep them properly aligned. Using a level gauge to determine the vertical position of the uprights, fill the holes with concrete and allow it to dry for at least two days before knocking the temporary 2" x 4" off and mounting the Dummy. When the concrete has set around the vertical uprights, they will be able to support the weight of the Dummy easily, and will have a good amount of resilience with a "springy" feel.

To mount the Dummy on the uprights, solid or portable, the correct height level for the individual trainee should first be determined using the method previously described. Once this level has been decided, use a set of plywood squares or some other similar thin, flat objects to act as shims to support the Dummy at the correct height. The best way to do this is for the trainee to stand in front of the Dummy in "Yee" Jee Keem Yeung Ma position and add or subtract plywood sheets until the Dummy sits approximately one inch above where he wants it. At this point, the lower horizontal 1" x 2" pre-drilled crossbeam should be passed through the Dummy trunk, which is itself placed in the exact center of the two vertical uprights. When the right end of the crossbeam is flush to the outside edge of the right vertical upright, use a centerpunch to pass through the pre-drilled 1/2" hole in the crossbeam whose center is located 1 3/4" to the left of the right end. Mark the upright for drilling. After this is done, slide the crossbeam back through the Dummy trunk to the left until there is enough clearance to drill a matching 1/2" hole through the right upright. Then slide the crossbeam back in place, put a 1/2" x 6" hexhead bolt through both holes and tighten a washer and nut on the back of the upright, finger tight only. Next, lay a level gauge across the top of the



## Close Range Combat Wing Chun: Volume Three

---

crossbeam to the left of the Dummy trunk. Straddle the crossbeam with your back to the Dummy trunk and lift the crossbeam until it is level. Your partner should then again use a centerpunch to mark the left upright for drilling. Remove the bolt on the right upright and slide the crossbeam through the Dummy trunk to the right until there is room to drill the second hole. When this is done, slide the crossbeam back through and put both bolts through. Tighten the nuts down and remove the plywood sheets from under the Dummy trunk, being careful not to let the Dummy fall forward or back.

When installing the upper horizontal crossbeam, it is important to ensure that it supports fifty percent of the Dummy's weight. This is accomplished in the following way:

Slide the upper crossbeam through the square hole in the Dummy trunk until it is centered on both uprights. Then stand behind the Dummy and grip the upper crossbeam palms-up, with one hand on each side of the Dummy trunk. Keeping the crossbeam as level as possible, lift the crossbeam enough to take up part, but not all of the Dummy's weight. Your partner should then centerpunch the right upright through the pre-drilled hole in the crossbeam. Release the Dummy trunk, slide the crossbeam to the left and drill another  $\frac{1}{2}$ " hole through the right upright. Slide the crossbeam back in and put a bolt through without a nut. Place the level gauge on top of the crossbeam, to the left of the Dummy trunk and raise the left side of the crossbeam until it is level. Centerpunch, remove the bolt on the right side, slide the crossbeam over and drill. Put both bolts through and tighten down. You now have a level, correctly positioned Dummy with its weight evenly distributed between the upper and lower crossbeams.

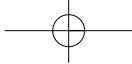
Stops to prevent the Dummy from sliding too far from side to side can be made using eight 1" diameter,  $\frac{3}{16}$ " thick round rubber bushings, such as can be found at any auto parts store. To install these, center the Dummy on the horizontal crossbeams and place one bushing on the top right side of the horizontal crossbeam exactly  $1\frac{1}{2}$ " from the right side of the Dummy trunk. Mark the spot and drill vertically down through the crossbeam. Put the bushing back in place with a smaller diameter metal washer on top. Drop a  $\frac{1}{4}$ " x 3" bolt, preferably a Roundhead for safety reasons, down through the washer, bushing and crossbeam. Put another bushing over the protruding lower portion of the bolt, add another washer and tighten the bolt down with a capnut. Repeat this procedure on the other side and again on both sides of the other crossbeam.

## Building and Installing the Dummy

---

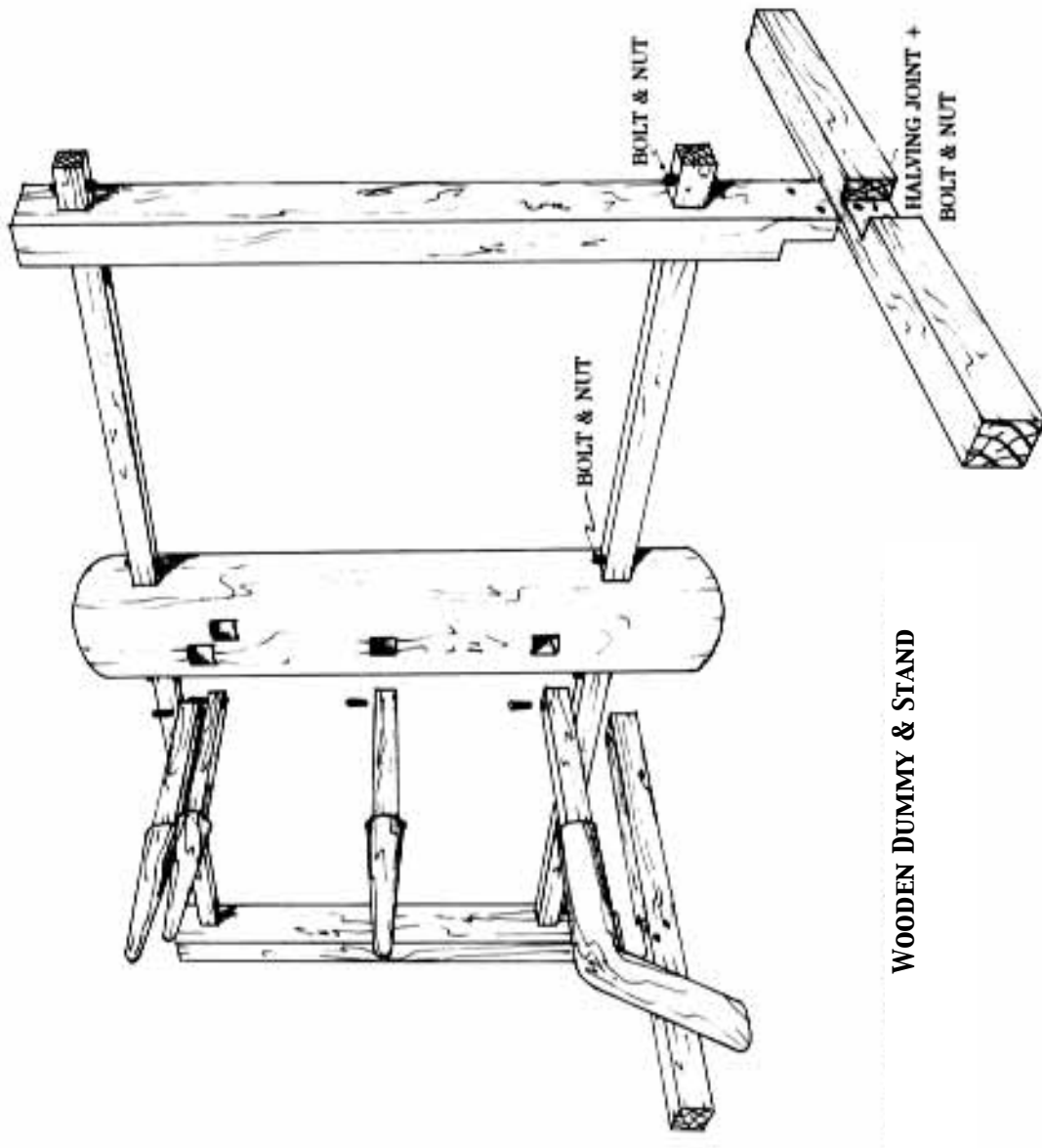
**Photo 92**—A close-up view of the Dummy trunk, upper Dummy arms, horizontal crossbeam and rubber stops. Note the square holes through the Dummy trunk through which the arms and crossbeams pass.



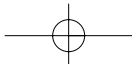


Close Range Combat Wing Chun: Volume Three

*Wooden Dummy Plans*

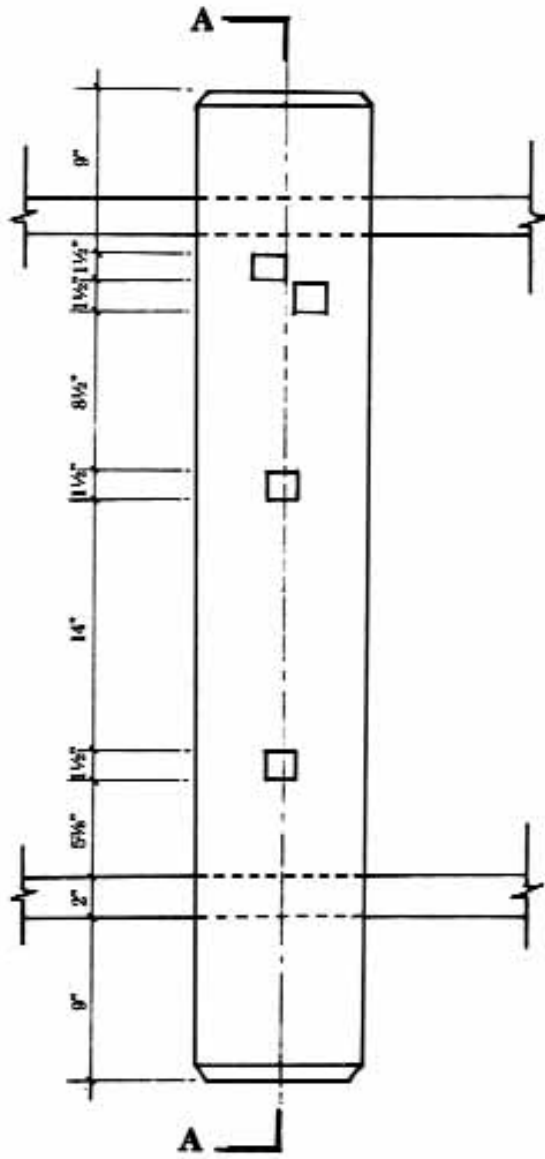


**WOODEN DUMMY & STAND**

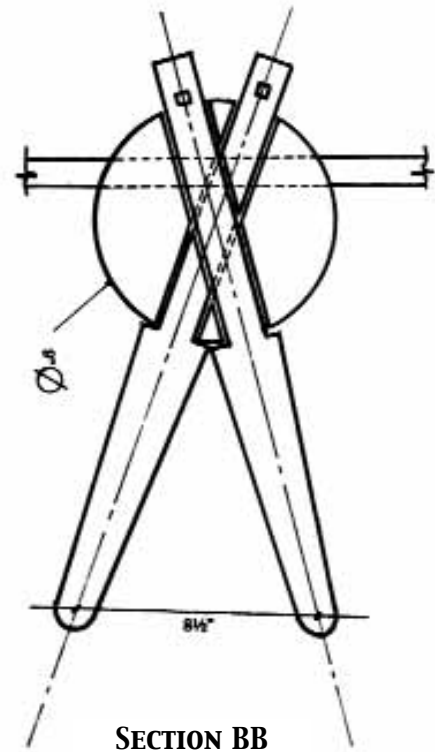




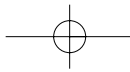
### Building and Installing the Dummy



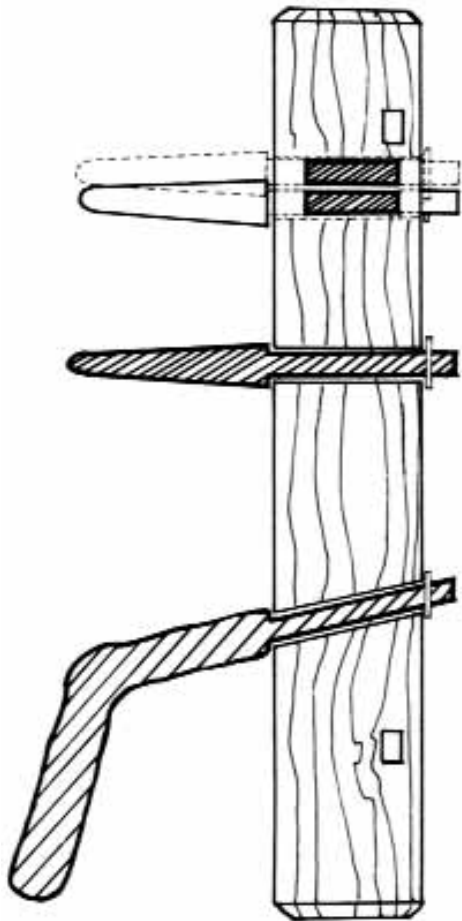
FRONT VIEW



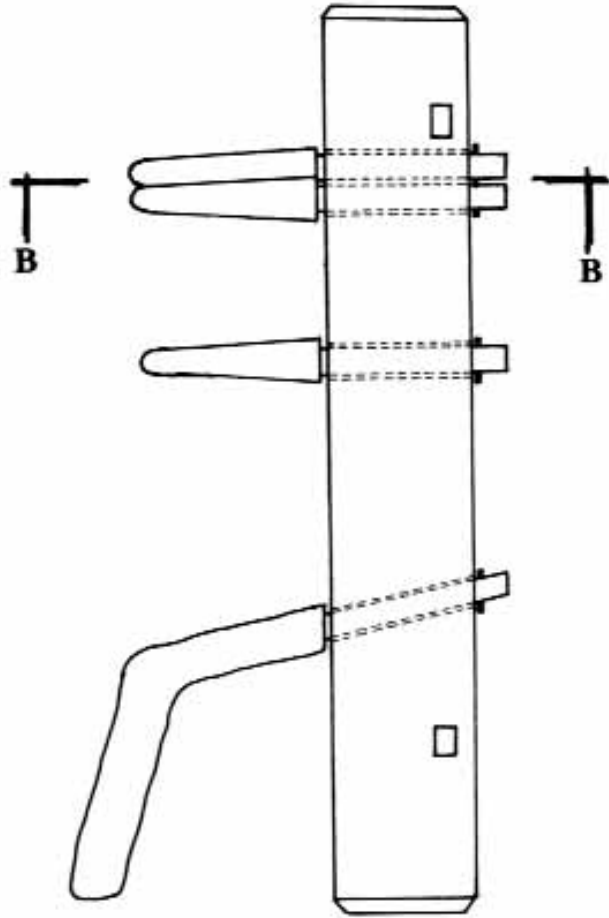
SECTION BB



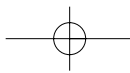
Close Range Combat Wing Chun: Volume Three



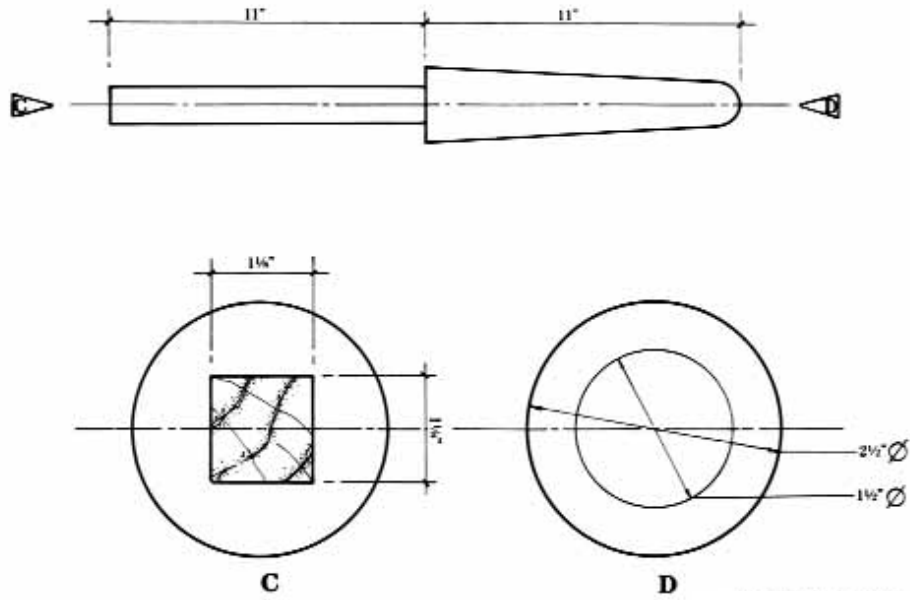
SECTION AA



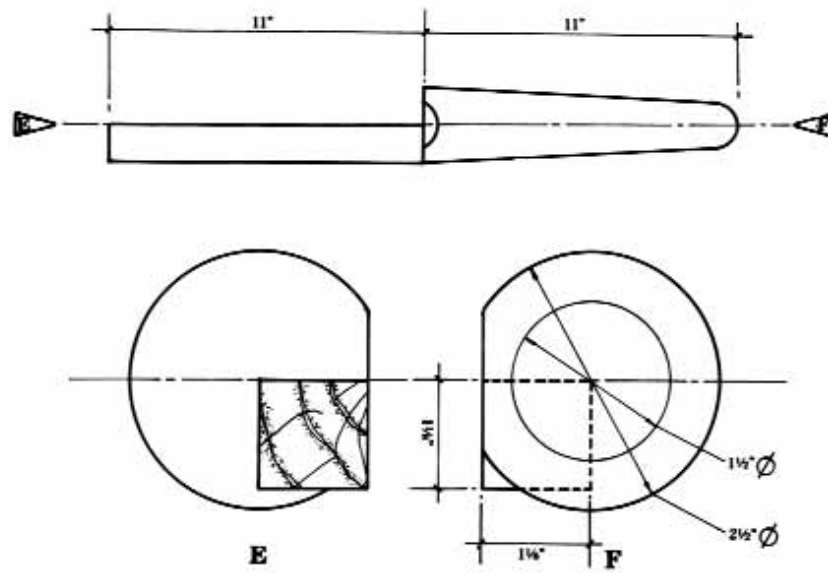
SIDE VIEW



### Building and Installing the Dummy

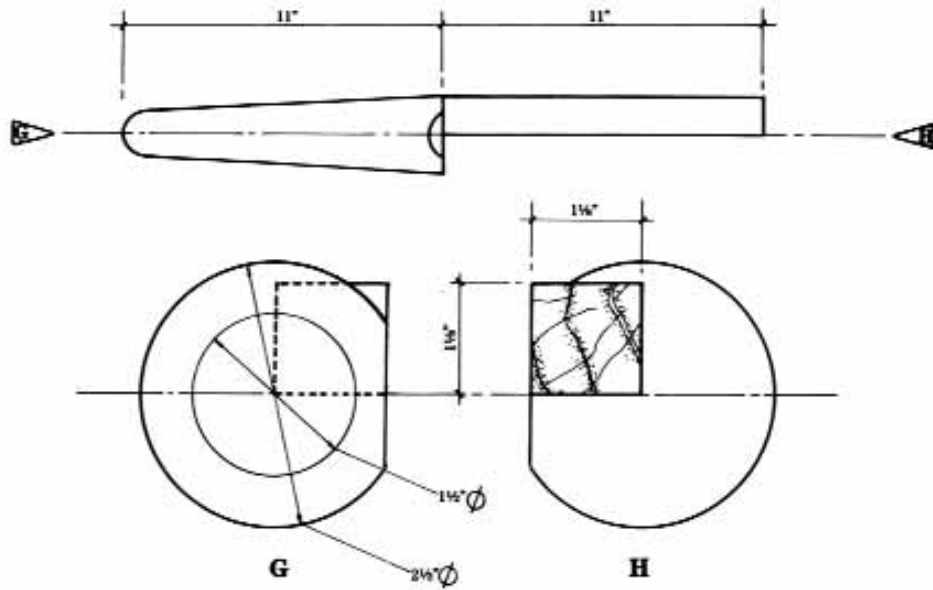


**MIDDLE ARM**

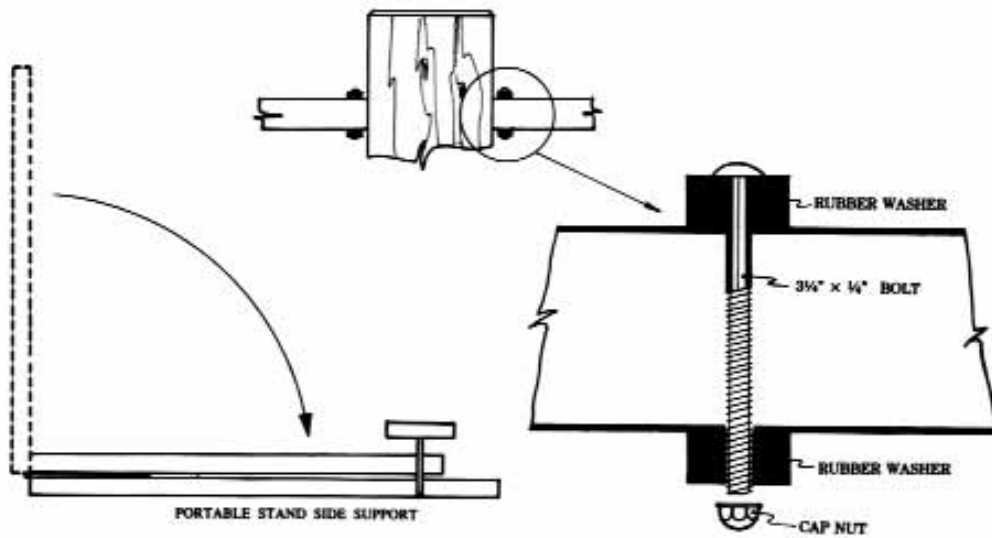


**RIGHT ARM**

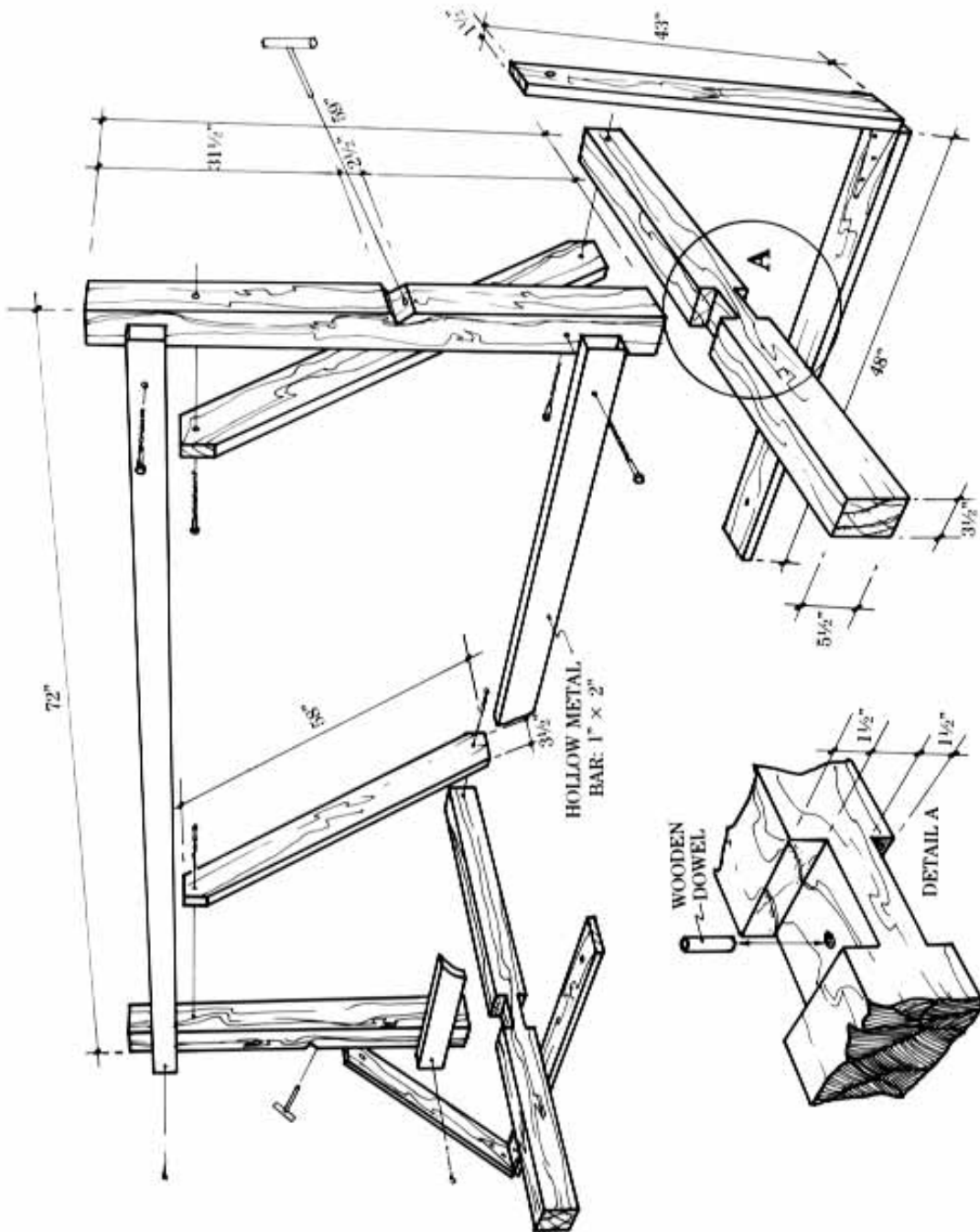
### Close Range Combat Wing Chun: Volume Three

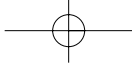


LEFT ARM

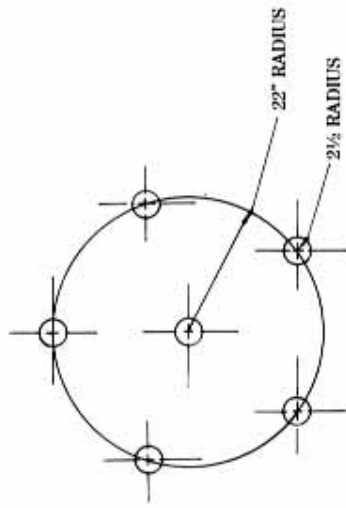
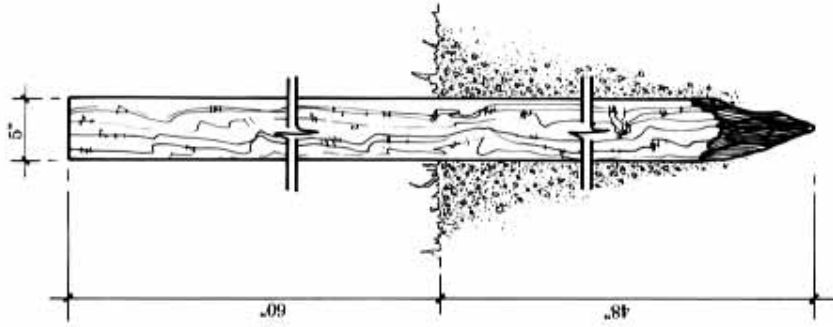


### Building and Installing the Dummy

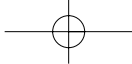
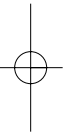
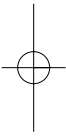
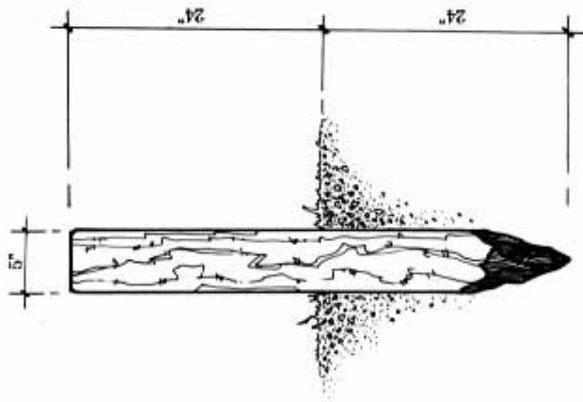




Close Range Combat Wing Chun: Volume Three



MUI FA JOANG CONSTRUCTION



# PRELIMINARIES



Before actually beginning to use the Wooden Dummy, there are certain concepts and skills that must be fully understood and mastered by the Wing Chun student in order to realize maximum benefit from Mook Joang training and to avoid injury. Besides the basic principles of Self and Applied Structure, footwork, Facing and Body Unity, which were thoroughly covered in Volumes I and II of this series, the student must fully understand the Centerline Theory and its implications on his own technique in relation to the Dummy. He must also have developed the ability to exert *Yut Yau Hoang Ging*, or “Soft and Relaxed Power,” and

### Close Range Combat Wing Chun: Volume Three

---

have a good grasp of the concepts of Yin/Yang Structure, Reference, Cutting Angle and Whirlpool Energy.

**Hand Position**—Because the Wooden Dummy formally introduces the concept of making contact with a solid object during the execution of a technique, it is also important that the student learns the correct way to position the hands and arms to prepare them for contact with the hard surface of the Dummy arms and trunk. As in other phases of Gung Fu training, the proper formation of the fist and the position of the fingers and thumb when making arm contact with the Dummy arms is vital to the prevention of injury. When striking the Dummy arms with the wrist or forearm, the thumb of the striking hand should be tucked against the side of the hand with the first section of the thumb folded inward across the bottom of the last index knuckle. This puts the forearm muscles into the correct tonus to prevent injury during a block or strike and also helps direct the Chi to the wrist, rather than letting it escape outward through the fingers. The exception to this rule is the Boang Sau motion, in which the thumb and fingers hang loosely with the wrist relaxed and bent to direct the Chi straight ahead through the forearm.

When striking the Dummy trunk with an open palm, the thumb of the striking hand should be tucked against the side of the hand with the tip of the thumb on the outside bottom of the index finger. This position will protect the thumb from being accidentally hung up on part of the Dummy and will prepare the base of the palm for contact.

Although punches to the Dummy trunk do not actually make contact with its wooden surface, the fist should always be properly formed according to the structure of the punching motion. This teaches the trainee to instinctively form a proper fist on its way to the target area, clenching in the interim between blocking and coming to full extension with a last-moment squeeze of the fist that adds power to the strike. As a punch is executed, the hand should be closed to a flat fist, then the fingers rolled tightly down to form the fist with the thumb wrapped around the front. This seemingly simple movement must be mastered so that the split-second conversion from open-hand block to short range punch can be performed with no retraction of the punching hand.

**Woo Sau Guard**—Another important skill needed at Wooden Dummy level is the correct use of the Woo Sau Guarding Hand. Unlike the other forms of the system, in the Mook Yan Joang set, as in sparring or actual combat, any hand not in use is usually held in Origin Position to guard the Centerline with Woo Sau structure forming second line of defense. This prepares the student for Sticky Hands training with a live partner as the instinctive reaction to keep the guard up and protect the inner gate is developed.

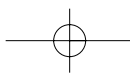
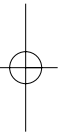
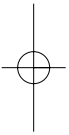
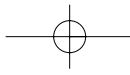


## Preliminaries

---

**Angle Structure**—Unlike practicing motions in the air, Wooden Dummy training provides the student with a “mold” against which his techniques can be fit and restructured to perfection. This not only involves correct spacing between the hands and Reference to the Centerline, but also correct extension of the individual motions. For example, if the trainee executes Dai Boang Sau (Movement 26) and at the end of that motion finds that the low Dummy arm could shoot him in the stomach or hip if it were a gun, or would touch him if it were three feet longer, he knows that either his motion is underextended, his footwork is improperly referenced to the Centerline, or both. Since the two upper Dummy arms are not in use during this motion, they are therefore considered to be non-existent, and it is not important where they point. Only when actual contact is made with any of the Dummy’s arms or its leg are those limbs considered a factor in the trainee’s body positioning. For example, when executing the Toy Ma Gahng/Jom Sau motion as in Movement 6 of the Dummy form, the Light Leg must not step past the Dummy leg, or both the Gahng Sau and the Jom Sau will be improperly referenced, both pointing directly at the trainee. But in the Toy Ma Gum Sau of Movement 62, the stance is stepped further to the right. This is structurally acceptable because the upper left Dummy arm that was being blocked by Jom Sau in Movement 6 is no longer a factor, and the low Dummy arm is being blocked by the trainee’s left hand rather than his right, which was used against that same arm in the Gahng/Jom movement. This implies that the Centerline in the two motions is not the same; in Movement 6, the line is unchanged from that created by the Seep Ma footwork of Movement 5, angled 45° off the Original Centerline. In Movement 62, the line is the same as it would be if the trainee were in “Yee” Jee Keem Yeung Ma position—the Original Centerline itself. Again, this is because in Movement 62, the two upper arms are, for all intents and purposes, “non-existent.” Likewise, when the trainee executes a Complex Motion that contacts two arms, the third arm is treated as non-existent, unless it is simultaneously being used in a kicking or leg blocking technique.

Certain Complex Motions, such as Loy Kwun Sau, violate this principle only because of the inflexible nature of the Dummy arms, as the trainee can only simulate moving one or the other off the line. But in any case, the trainee should always make sure that the Dummy’s “guns” do not point at his Motherline at any time. This structural consideration results in many subtle variations in the execution of techniques and Moving Stances that at first appear to be identical. In many cases, those differences are nearly undetectable to the untrained eye.



# BENEFITS OF WOODEN DUMMY TRAINING

Practice with the Wooden Man benefits the Wing Chun student in many ways. Firstly, the Dummy provides the trainee with a partner when no one else is available to practice the applications of hand and leg movements. All blocks, strikes and kicks can also be executed with full power transfer without fear of injury to a live partner. As the Dummy does not move much, the student learns mobility while circling around it with various footwork in conjunction with blocking and striking hand techniques to “Bridge the Gap”—a universal term for closing the distance between two fighters. Wooden Man training can also be enlightening in regard to use of the Centerline to attack and defend from all angles as the trainee “changes the line” from one movement to the next. This angulation and proper use of the Centerline can enable a smaller, weaker person to overcome a larger force, by “borrowing power” and diffusing strength with body positioning and structure. As the Wing Chun Wooden Dummy proverb goes, “*Seen Wai Yoang Duck Hoh Lahng Chue,*” which means “Use of the Centerline will be proper and therefore hard to defeat.”

The two upper arms are set at a strategic angle to represent the final position of a correctly blocked strike, setting it as an outside limit. For example, when executing a right Pock Sau slap block, rather than imagining them to be two punches moving outward from the center, the trainee should envision the left Dummy arm as a left punch from the opponent which his right hand has knocked across the Centerline. In the same way, the right Dummy arm can be imagined to be a right punch that has been pushed to a point sufficiently outside to keep it from hitting the trainee, but no further than necessary. This outside limit point is dictated by rules of Centerline Advantage, Facing and the “Cutting Angle” that were explained previously in this book series and conforms with the Wing Chun concept of Economy of Motion.

Mook Yan Joang training clearly illustrates applications of the three hand forms under “laboratory conditions.” This is due to the structure of the Dummy itself. Because of the perfect Angle Structure built into the Dummy, the trainee is naturally drawn to execute his techniques with equally perfect Angle Structure. Any structural defect in the trainee’s motion tends to be magnified by the Dummy and can therefore be easily identified and corrected. In addition, if a technique is performed improperly, it will usually cause some excessive pain to the trainee, signaling that the angle of contact or the striking surface of the hand, arm or leg is incorrect.

### Close Range Combat Wing Chun: Volume Three

---

Another advantage of training with the Wooden Dummy is the toughening of the skin and bone of the hand, arm, shoulder, foot and leg. This is accomplished through “Tapping,” also called “Energy Packing.” The Dummy should not be hit with full force initially but instead should only be tapped. Tapping the Dummy’s wooden surface in this way, combined with the use of *Leen Goang Jau* (herbal liniment) will eventually “pack” Chi into the bone cavities, preventing bone brittleness in old age. Although at first the trainee may experience a small degree of pain and bruising, after a short time he will be able to execute all movements sharply and crisply without any more discomfort, having developed an “Iron Bridge Hand,” or *Teet Kiu Sau*. Once the trainee has a toughened arm, not only can he block an opponent’s punch or kick, he can also damage the arm or leg he is blocking. This is a part of the Simultaneous Attack and Defense principle of Wing Chun (*Leen Siu Dai Da*). A toughened arm is less likely to be injured in combat and can withstand more impact if necessary to block a heavy weapon. A student with an arm toughened by Wooden Dummy training can also train for longer periods with harder contact in drills with a live partner without suffering pain or bruising. Toughening skin and bones does not mean callusing or deforming the hand, nor does it mean bruising the bones. This conditioning must be performed gradually; the conditioning becomes a little longer and harder with each training session until the desired result is attained.

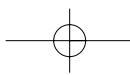
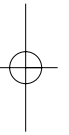
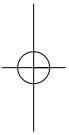
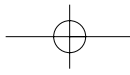
Wooden Dummy training simultaneously develops the student’s ability to transfer power into a stationary object while avoiding choppiness between motions—and drills many of the motions of the system with the added element of contact. As he executes the techniques in a more realistic manner than in the first two hand forms, flowing smoothly from one to the next, up and down, left to right, while completely releasing the power of each into the “core” of the Dummy, the trainee will develop the ability to continually strike from any combination of angle and level while maintaining good balance and posture. This also enables the practitioner to flow directly from one movement into another without interruption of power, momentum and speed. Although it may appear that the movements blend into each other, in actuality each motion is completed and its power totally released into the Dummy before the next motion is begun. This will be apparent in the rhythmic sound produced by the correct flow of motion. In fact, a true master of Wing Chun can actually detect faults in the structure of a student’s Dummy form simply by listening to sounds made by the wood and his footwork, without actually watching. This because of the distinctive sounds and rhythms made by movements that are correctly self-timed and then in turn correctly timed

## Benefits of Wooden Dummy Training

---

on the dummy. A well-trained ear can detect the proper stepping, sliding and release of power by their sound alone.

While the Dummy can be used for training blocks, parries, strikes, kicks, elbow and knee strikes, sweeps and other leg maneuvers, there are other less obvious ways of using the Dummy. The Dummy arms and horizontal crossbeams can be used like a ballet bar to stretch the legs at different levels and the wrist can be stretched by pressing the palm against the Dummy trunk with the palm heel up, fingers down. Even the horizontal crossbeams can be used for support for wrist rolling forearm-conditioning exercises with weights. It is important to be innovative in using the Dummy. Try to find new ways of using all parts of the device, including the top, the area behind the leg and even the vertical upright support beams, which can be padded and used as *makiwara*-type striking posts.



# THE "108"



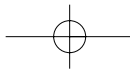
### Close Range Combat Wing Chun: Volume Three

---

The most advanced type of Dummy training is the third form of Wing Chun, known as *Mook Yan Joang Fot Yut Ling Bot*, or “108 Wooden Dummy Motions.” This set drills the basic blocks, strikes and kicks as well as many of the Complex Blocking, Attacking and Kicking Motions found in the three empty-hand sets of Wing Chun. It contains grabbing, trapping, sweeping and throwing movements, and many of its techniques feature examples of simultaneous attack and defense a common characteristic of Wing Chun. Certain motions of the form are designed to improve the trainee’s Sticky Hand and Foot skills, as the hands and feet cling to the Dummy arms and leg while moving from one position to another. The Dummy set also introduces the element of contact not found in the empty-hand sets. Although the concepts of grabbing, deflection, and trapping while hitting are illustrated in the hand forms, they can be practiced more realistically in the Dummy set.

As its name implies, the Wooden Dummy form, like all other Wing Chun sets, is comprised of exactly 108 movements, that number having special significance in Chinese lunar mathematics, religion and superstition. However, due to some restructuring of the form by the late Grandmaster Yip Man, the total number of Wooden Dummy techniques has been increased to 116. This resulted from the addition of the 8 “families” of kicks as well as some overall rearrangement of the base 108. It appears that Grandmaster Yip felt that some motions were overly repeated while certain other techniques he had learned from his two masters, Chan Wah Soon and Leung Bick, had been omitted. So not only was the last section added, but also the main body of the form was rebalanced by Grandmaster Yip. This may account for the fact that students who learned from the Grandmaster at different periods seem to have learned the form in slightly different patterns. For example, the 108 motions practiced and taught in all CRCA locations contains many movements as yet unseen by the author in the forms of other Yip Man descendants. As will be seen in the pages that follow, motions such as *Juen Bock* (Shoulder Block), *Tai Sut* (Raising Knee Strike), *Fook Sut* and *Tan Sut* (Inward and Outward Knee Blocks) and *Boang Gyeuk* (Wing Leg Deflection) all practical, real, recognizably Wing Chun-style movements abound within the text of the 108. Variance from school to school in the pattern of the 108 is not unusual. In fact, the student will find that on close inspection, the Dummy form of each major Wing Chun group will vary slightly in some cases, and considerably in others. Sequence is not of great importance, so long as the principles of Technique, Timing, Power and Angle Structure are adhered to. As the proverb goes, “*Toang Chuet Yut See, Gay Goke Yau Yee*,” which means, “Students from the same teacher will differ in their skills.”





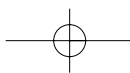
## The “108”

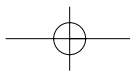
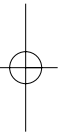
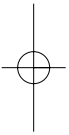
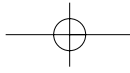
---

Many Wing Chun techniques and variations of footwork are formally introduced within the text of Dummy form. Movements such as *Seep Ma*, the “Motion Interception Stance,” *Pon Geng Sau*, the “Neck-Pulling Hand” and others appear for the first time in the Yut Ling Bot, as do the remaining four of the famous “Eight Kicks of Wing Chun” that do not appear in the system’s hand forms. The *Moh Ying Gyeuk* (Invisible Kick) principle is also seen for the first time in the last half of the set.

The Mook Yan Joang form is divided into two parts, each part being taught at a different level. The first 60 movements of the Dummy form are based on the motions of the Siu Leem Tau and Chum Kiu forms and are taught after the student has reached a substantial degree of proficiency in those forms. Only after mastering Biu Jee set can the Mook Yan Joang form be completed. The last 48 motions, which are based on the motions of the Biu Jee set, take the student through a series of advanced techniques designed for emergency situations, and for coping with radical changes of the Centerline in combat.

The physical presence of the Dummy enables the student to more realistically and accurately execute the motions of all the empty hand forms with reference to an actual Centerline rather than an imaginary line. This helps the trainee to “true-up” his techniques, fine tuning the inherent Angle Structure of each. In turn, when the trainee performs his empty hand sets, armed with Centerline consciousness enhanced by practicing many of their motions in the Yut Ling Bot, he will begin to execute those motions more correctly and to refine his Siu Leem Tau, Chum Kiu and Biu Jee skills.

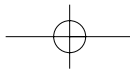




## THE EIGHT KICKS AND THE WOODEN DUMMY



As was explained in *The Eight Kicking Principles of Wing Chun* essay of Volume II of this series, there are eight basic kicks in Wing Chun, each of which can be performed in any one of or any combination of eight different ways. Within the 36 kicking motions seen in the Wooden Dummy form, at least one example of every type of these kicking methods can be found. This is not to say that every possible combination of kicking prin-



### Close Range Combat Wing Chun: Volume Three

---

ciples appears in that set, only that somewhere in the body of the Yut Ling Bot, each individual principle is exemplified.

The Eight Kicking Principles, usually referred to as the “Eight Kicks of Wing Chun,” in the order that they appear in the Dummy form, are:

- 1) Deng Gyeuk—Nailing Kick
- 2) Huen Gyeuk—Circling Kick
- 3) Teo Gyeuk—Jumping Kick
- 4) Tiu Gyeuk—Instep Kick
- 5) Jut Gyeuk—Jerking Kick
- 6) Soh Gyeuk—Sweeping Kick
- 7) Dung Gyeuk—Lifting Kick
- 8) Chai Gyeuk—Scraping Kick

The first kicking principle, *Deng Gyeuk*, is first seen in Movement 28 of the Yut Ling Bot as the right foot stamps the Dummy trunk with a “nailing” effect. *Huen Gyeuk*, which was introduced in Movement 55 of the Chum Kiu form, appears in Movement 30 of the Dummy form as the right hand counterpart motion of the Deng Gyeuk with a circling motion of the kicking leg substituted for the straightline “nailing” action.

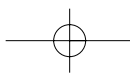
The third kicking principle to appear in the text of the Mook Yan Joang form is *Teo Gyeuk*, or “Jumping Kick.” This name is a bit misleading in that the trainee does not actually jump when executing this motion, but instead quickly shuffles the base leg up or back to the kicking leg, which simultaneously begins to move, as in Movement 58 of the form. The fourth form of Wing Chun kick appearing in the Dummy form, *Tiu Gyeuk*, uses the instep to block or attack with a sharp snap of the ankle that is similar to the wrist snap of Woo Sau. In Movement 67, *Ngoy Tiu Gyeuk*, the outward version of this kick is seen.

Movement 80 of the Mook Yan Joang set contains, among others, the *Jut Gyeuk* motion, also in its outward form. In this motion, the rear ankle and calf are brought down sharply to the inner calf area of the Dummy leg to simulate a downward jerking leg block, breakdown or leg take.

In Movement 90, the sixth kicking principle, *Soh Gyeuk*, appears as an inward-swinging sole/inner arch attack to the front shin area of the Dummy leg. The seventh and eighth principles of Wing Chun kicking, *Dung Gyeuk* and *Chai Gyeuk*, are exemplified by Movements 101 and 102 respectively.

More on these kicking principles and their applications can be found in *The Eight Kicking Principles* essay of Volume II of this series.

As can be seen, the Wooden Man is a sophisticated and complex device with many extrapolations of usage. It can be compared to a calculator with many complex functions that can only be fully utilized by a skilled mathematician who understands memory, rounding, constants,



## The Eight Kicks and the Wooden Dummy

---

etc. and will use those functions in their intended applications when necessary, although each application may differ. Someone who does not fully comprehend the complexities of the device will be limited to simple applications like adding or subtracting. The form in this case is similar to the written instructions for using the calculator. As always, the principle rather than the individual technique is of primary importance.

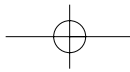
Wooden Man theory goes much deeper than simply striking, blocking or kicking a post at random. Training diligently with the Wooden Dummy with correct structure and the right “idea” in mind will enable the student to unlock its many hidden secrets. As is true for all Wing Chun forms, each motion of the 108 can be applied practically in many ways. These motions were chosen carefully by the founders of the style to best exemplify a universally applicable combat principle rather than to illustrate any one individual technique. Thus, as the trainee moves on the Dummy, he must fully comprehend the “language” of the Wooden Man and how to translate his movements into live action versus a real opponent. Only at that high level of learning can the full meaning of the Mook Yan Joang Fot Yut Ling Bot be realized.

The following pages illustrate the Mook Yan Joang Fot Yut Ling Bot Wooden Dummy form in its entirety. At the end of Movement 60, there is an optional closure of the stance that can be used to finish the first half of the set. When the student has completed the entire form at Biu Jee level, the first stance closure should be omitted and Movement 60 should flow directly to Movement 61.

It will be noted that each of the twelve individual sets that comprise the form end with the double Loy Jut Sau/double Pau Sau sequence. Much like the Huen Sau/Sau Kuen sequences that are repeated many times in the empty hand forms, this repeated Jut/Pau sequence is very important, and appears so many times within the form for that reason. It is therefore important not to rush through them for the sake of getting to the next sequence, but to instead concentrate on each explosive inward-jerking or upward forward snapping motion.

When referring to the Dummy itself, I have treated its front face not as an actual opponent with a right and left arm diagonally opposite the trainee’s own right and left arms, but for ease of explanation I have referred to the Dummy arm to the trainee’s left as he faces the Dummy as the “left Dummy arm.” Likewise, the arm to the right of the Centerline will be referred to as the “right Dummy arm.”

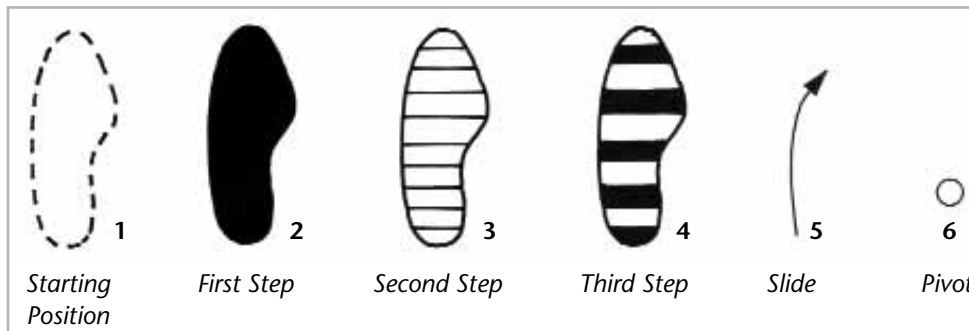
The footwork of each complete motion is illustrated by individual diagrams that identify starting position with a dotted outline of the feet. The first step of the footwork is shown with a solid black footprint. The second step is depicted by a thinly striped footprint. A thickly striped



### Close Range Combat Wing Chun: Volume Three

footprint indicates the third step of a footwork sequence. A pivot of the foot is illustrated by a white dot at the heel of the pivoting foot, and an arrow from one position of the foot to the next indicates a sliding step. No diagram will appear for any motion in which the stance remains unchanged from the previous position.

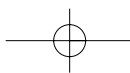
#### Footwork Legend



Another term used in reference to footwork and stepping is “the Semicircle.” By this I mean a semicircle that can be drawn around the Dummy at a distance that passes through the centers of the trainee’s feet when he is in correctly referenced “Yee” Jee Keem Yeung Ma position facing the Dummy. All stepping and kicking occurs on or from this arc, which appears in the individual diagrams to clarify the correct footwork pattern for each motion.

When practicing the form, it is important that the student follows the instructions given in the Main Points section after the form breakdown. All movements should flow naturally from one to the next without chop-piness. Wherever possible, I have included interim shots which will help the reader clarify how I got from one position to the next and will also help illustrate the Whirlpool Energy of the motion, as the arms, wrists and hands are circularly whipped between seemingly straightline motions, supported by arcing and pivoting footwork. Practicing the form in the air without a Dummy is also an excellent way to develop this circular energy, as well as to improve the balance in Complex Kicking Motions. Without practicing these motions in the air, the trainee may end up relying too heavily on leaning on the Dummy for balance and may find it difficult to perform the same techniques without contact.

During the execution of any punch in the form, the front face of the fist will at no time make contact with the Dummy trunk, but will instead stop just short of impact. This is to avoid injury, as the wooden surface of



## The Eight Kicks and the Wooden Dummy

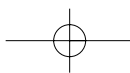
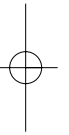
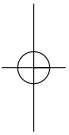
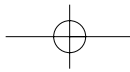
---

the Dummy is extremely hard and unforgiving. Palm strikes do make contact, however, and their striking surfaces should include the entire palm and fingers, except in Fun Sau and Gum Jyeung chopping techniques, where the outer palm edge is the striking surface.

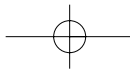
Movements which are repeated more than once will not be described again but instead, the number of the corresponding Movement number will appear in brackets after the movement's Chinese name. The reader will note that certain motions that would at first appear to be repetitions of previous motions are re-explained in some cases. This is because there is some difference, however slight, in the individual execution in question.

As in the previous two volumes of this series, the term "Origin Position" is again used to indicate a position of the elbow when it is extended approximately one fist-width from the body on the Immovable Elbow Line. The reader may also note that the naming of certain complex terms differs from the individual piece-by-piece descriptions in the 108 breakdown after the form sequence. This is because the words "right" and "left" are omitted in the actual names of the motions, as is the naming of the Woo Sau guarding hand that appears in nearly every movement. In other cases, a name given in this text is an alternative term for a Complex Motion created by the individual elements that make it up.

The last term I have used to clarify the body Reference to the Dummy is the "Original Centerline." By this I mean the Centerline created by facing the Dummy directly in "Yee" Jee Keem Yeung Ma position. This line remains unchanged if the trainee pivots to either side with Choh Ma footwork. In any technique where the Original Centerline is mentioned, the trainee should have somehow returned to this Centerline relationship to the Dummy using whatever footwork necessary.

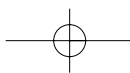
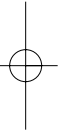
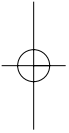


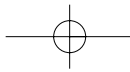




# WOODEN DUMMY FORM (PART I)

木  
人  
樁  
法  
一  
零  
八



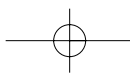
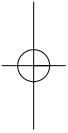


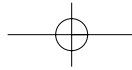
## Close Range Combat Wing Chun: Volume Three

---

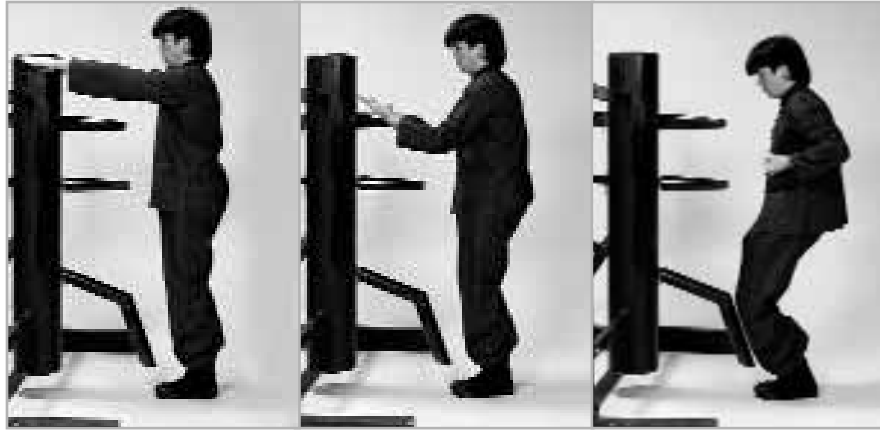
### ***Hoy Sick (Stance-Opening Sequence)***

Beginning with the feet together and looking straight ahead, extend both arms and touch the sides of the Dummy with the insides of the index knuckles (HS1). The point of contact should be at eye-level. This motion determines the correct distance from the Dummy to begin the form. Sharply twist both palms upward as the elbows pull the hands inward and downward in a Double Jom Sau motion (HS2) that corrects the body alignment and leaning posture in relation to the Dummy. Next, simultaneously retract both elbows to pull the fists to a chambered position as both knees bend (HS3). As always, the chambered fists should not touch the body, but the wrists should instead be held 1 finger width's distance from the ribs. Open the stance to "Yee" Jee Keem Yeung Ma position by first turning the toes outward to a straight line pivoting on the heels (HS4), and then turning the heels outward to a distance slightly greater than shoulder width (HS5), pivoting on the balls of the feet.





Wooden Dummy Form (Part I)

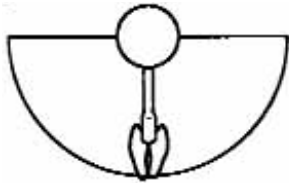


Hoy Sick

1

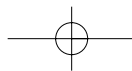
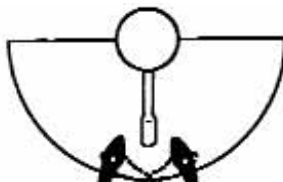
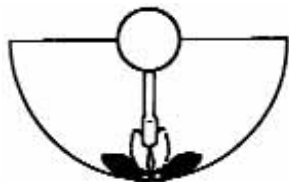
2

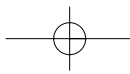
3



4

5





## Close Range Combat Wing Chun: Volume Three

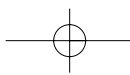
---

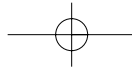
### First Set

*Movement 1*—Joang Sau, Biu Joang Sau (Extended Lead Guarding Hand, Thumb-up Thrusting Hand): Smoothly extend the left hand to guarding position, placing the right Woo Sau just next to the elbow of the leading arm (1A). Twist the left hand outward as it thrusts forward to make contact with the Dummy arm (1B). The left hand should twist to a 45° angle in relation to the floor when it reaches full extension. As the left hand moves forward, the right Woo Sau follows the left elbow, so that on completion of the motion, the Woo hand has moved forward together with the Biu Joang Sau in a triangular “wedging” motion and ends up a position still very near the inner left elbow.

*Movement 2*—Choh Ma Lop/Chahng Geng (Stance Pivot/Grab/ Throat Spade): Turn the left hand over (2A) and, without losing Bridge Contact, convert that hand to a Lop Sau thumbless grab as the stance pivots halfway to the left and the right hand passes between the two upper Dummy arms to strike with Chahng Jyeung at throat-level (2B). Use a pivot of the shoulders to add snap to the motion and keep the Lop elbow down and in on the Elbow Line. The elbow of the striking arm should be fully extended.

*Movement 3*—Choh Ma Chum Jahng (Stance Pivot/Sinking Elbow): Grab the surface of the Dummy trunk at throat level and squeeze with the fingers and thumb (3A). Finish the stance pivot begun in Movement 2 as the right elbow snaps downward, causing the right hand to slide down the surface of the Dummy (3B). The entire stance should sink during the motion and a firm grip should be maintained with both hands throughout the movement to control the Centerline.





Wooden Dummy Form (Part I)



First Set

1A

1B

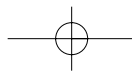
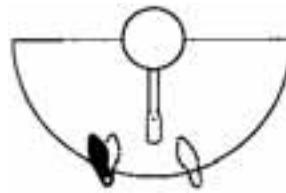
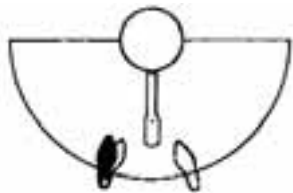
2A



2B

3A

3B

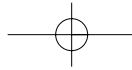


### Close Range Combat Wing Chun: Volume Three

---

**Movement 4**—Boang Sau (Wing Arm Deflection): Without moving the stance, drop the right arm through the two upper Dummy arms (4A) and circle it outside to the right. Continue to circle into a right Boang Sau that threads between the two upper Dummy arms and opens out slightly toward the Dummy in a “jack-knife” motion as the forearm makes contact with the inside left Dummy arm. At the completion of the motion, the tenon of the left Dummy arm should be snapped up into the upper left corner of its square hole by the inward/upward Multi-Directional Motion of the Boang Sau. During the circling motion of the right arm, the left hand is brought up to Woo Sau position, moving in the opposite direction from the right (4B, 4C). Note that the fingers of the left Woo Sau hand should be twisted backward toward the right ear in Kau Sau structure, both to “spring-load” the hand for a follow-up Lop Sau grab and to keep them back and away from being grabbed by an opponent.

**Movement 5**—Seep Ma Tan Da Chahng Dai Jyeung (Three Point Stance/Palm-Up Block/Low “Spade Palm” Thrust): Step the left foot to the left along the Semicircle (5A). Without losing Bridge Contact with the right arm, convert the Boang into Tan Sau as the right foot arc-steps around the Dummy Leg to create a new Centerline 45° off the Original Centerline. Execute a left Chahng Dai Jyeung with the fingers rotated 45° downward, completing that strike with Raising Power as the left foot finishes the three-part footwork with a sliding step (5B, 5C). The footwork has three “syllables” step, circle and slide. At the completion of the motion, both knees should remain bent with the pelvis up. The right wrist should be sharply bent to give the Tan Sau a “sticky” trapping effect with wrist and back of the Tan hand pressing down on the Dummy arm. This motion exemplifies the proverb “The Arm Bridge sticks to the arm of the Dummy while moving.” The Boang Sau dropping to Tan Sau action of this movement is based on the conversion from Boang Sau dropping to Tan Sau in the Siu Leem Tau form. Note that during the execution of this motion, the tenon of the left Dummy arm will have made a rotation around its square hole as follows: 1) Boang—tenon was snapped into the upper left corner. 2) Left sidestep—tenon begins to slide along the upper surface of the hole. 3) Right arc step—tenon continues to slide along, makes contact with the upper right corner of the hole, then snaps down to the lower left corner of hole as the right palm completes its twist to Tan Sau position, creating downward opisthenar pressure.



### Wooden Dummy Form (Part I)



4A

4B

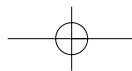
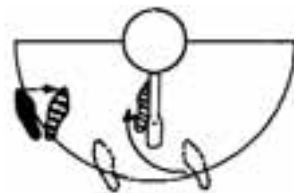
4C

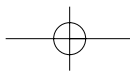


5A

5B

5C





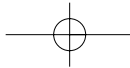
### Close Range Combat Wing Chun: Volume Three

---

**Movement 6**—Toy Ma Gahng/Jom Sau (Retreating Stance Pivot/Low Sweep/High Chop Block): In an action that covers the entire Centerline but does not change the line created by the previous motion, slide the right foot backward, passing through the gap under the Dummy Leg to a point not past the Original Centerline and pivot both feet to the right. This footwork brings the stance to a right Inside Facing Choh Ma position. During the sliding step, begin the Gahng/Jom Sau motion by snapping the right wrist inward and circling the arm into a low outward/forward Sweep Block as the left arm circles up to Jom position. Both motions simultaneously make contact with the Dummy in time with the pivot. Although the Yin Gahng Sau starts earlier in the offset timing of this Complex Motion, it has farther to travel and thus arrives to make contact at the same time as the Jom Sau. At the completion of the motion, the right arm should be angled so that the tucked thumb points toward the trainee's Self-Centerline and the left hand cuts into the Centerline itself. The power of both arms, although apparently sweeping sideward to the right, is focused directly inward to the Dummy's Motherline. This follows the saying "Power starts from the heart and shoots straight to the core of the Dummy." Exerting power correctly in this way will never break the Dummy's arm, because the majority of the impact is being driven straight back into the trunk rather than against the easily breakable tenon.

**Movement 7**—Toh Ma Ngoy Kwun Sau (Step/Slide/Outward Rolling Arms Block): Step the right foot to the right and slide the left foot to recover the original stance width as the right hand circles up to Tan Sau position and the left arm drills downward to Dai Boang Sau. During the circling motion of the arms, the fingers of the right hand pass closely by the inner left elbow as the right wrist spins the palm in a clockwise raising spiral from low to high. If a coin were to be placed in the right palm after the wrist was snapped inward toward the body and before losing contact with the low arm, that coin would not fall out of the right palm as it spiraled upward, but would have rotated 270° by the end of the motion. At the completion of the Ngoy Kwun Sau motion, the wrist of the left low Boang Sau should be closer to the trainee's body than the left elbow. The low arm of the Dummy should not point directly at the body and, even if it were three feet longer, should not be able to touch the trainee. Note also that, although the Dai Boang Sau of Ngoy Kwun hits the low arm and twists downward against it, the Multi-Directional power of that motion, coupled with the taper of the low Dummy arm will cause its tenon to move *upward* in its square hole. You should therefore hear it drop as you release it before the next motion.





### Wooden Dummy Form (Part I)

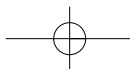
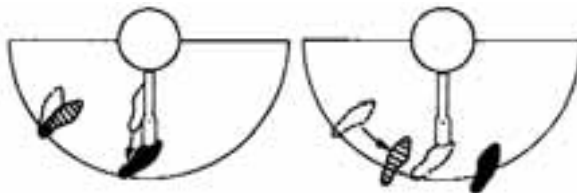
**Movement 8**—Seep Ma Tan Da Chahng Dai Jyeung: Step the right foot to the right on the Semicircle. Circle the left foot around the Dummy Leg with a sliding step (8A) as the left arm circles up to Tan Sau position with a raising spiral of the left hand in which the left wrist is snapped inward after the Dai Boang Sau and, like the previous right Tan Sau, could balance a coin in the palm as it twists in a counter-clockwise spiral to its final position. As the final right sliding step is completed, the right hand executes Chahng Dai Jyeung with the fingers angled 45° downward (8B). This position is a mirror image of Movement 5, with the entire technique referenced to the opposite side, 45° from the Original Centerline. The Low Boang Sau of Ngoy Kwun Sau raising to Tan Sau action of this movement is based on the conversion from double Dai Boang to double Tan in the Chum Kiu form. Note that, although the Tan Sau traveled upward to its final destination, on completion of the motion, the back of the hand still makes contact and exerts downward pressure in a “Natural Hand Hook” of the Dummy’s arm.



6

7

8A



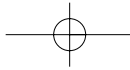
### Close Range Combat Wing Chun: Volume Three

---

*Movement 9*—Toy Ma Gahng/Jom Sau: [6].

*Movement 10*—Loy Seen Wai Loy Kwun Sau, Choh Ma Jut Da Jing Jyeung, Jing Ma Syeung Loy Jut Sau, Syeung Pau Sau (Step-and-Face/Inward Rolling Arms Block, Stance Pivot/Inside Jerk/Vertical Palm Strike, Return to Center/Double Inside Jerk, Double Lifting Palm): Step the left foot to the left, back to its starting position on the Semicircle (10A), and simultaneously pivot both feet to the right as the right foot slides in to balance the stance and recover the original stance width. During the “Step-and-Face” motion, without losing Bridge Contact with the right hand, convert the right Jom Sau into Huen Sau with the thumb and index finger pinched together and the last three fingers pulled in to simulate a grab and to snag the Dummy arm with the wrist. This hooking motion also helps pull the stance around to the right as the left arm chops the left Dummy arm, cutting straight into the Centerline (10B). At the completion of the motion, the right elbow is up with 135° structure and the left hand is angled 45° in relation to the floor. The Huen Sau arm should lift the right Dummy upward and its tenon inward to the upper right corner of its square hole.

Pivoting the stance to the left and without losing Bridge Contact with the left hand, convert the left hand into Loy Jut Sau (10C) with the palm flat on the Dummy arm and the elbow in. Simultaneously deliver a right Jing Jyeung Vertical Palm Strike without circling the right hand outside the right Dummy arm (10D). Pivot the stance back to the center, slightly disengage the left Jut Sau hand and then execute a Double Inside Jerk with the palms flat on the Dummy arms and the elbows in (10E, 10F). Note that a common error here is for the elbows to be out, in Fay Jahng position, rather than on both Elbow Lines. Also note that the left hand disengages slightly from the left Dummy arm between the last two motions to add more *Duen Ging* short snap to the technique. Next, without moving the stance, lift and push forward with both palms (10G) so that at the completion of the motion, the middle fingers end up one finger-width's distance from the Dummy trunk.



Wooden Dummy Form (Part I)



8B

9

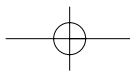
10A



10B

10C

10D



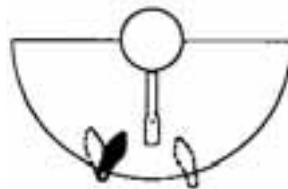
Close Range Combat Wing Chun: Volume Three



10E

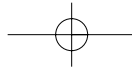
10F

10G



*Movement 11*—Joang Sau, Bui Joang Sau: Drop both hands slightly, then move them out to the left in a clockwise circling motion that brings them to the outside of the left Dummy arm and then over it. Once the right hand reaches the Centerline, it drops down on that line between the two upper arms into a position with that right hand forward and the left Woo Sau near the inner right elbow in guarding position (11A–11C). Twisting the right palm upward and following the right elbow with the left Woo Sau, thrust the right arm into the inside of the right Dummy Arm. Both thumbs should be tucked throughout the motion (11D).

*Movement 12*—Choh Ma Lop/Chahng Geng: [2].



Wooden Dummy Form (Part I)



11A

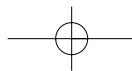
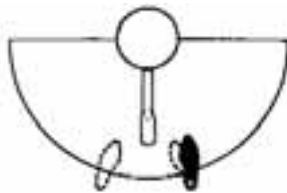
11B

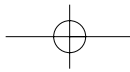
11C



11D

12





### Close Range Combat Wing Chun: Volume Three

*Movement 13*—Choh Ma Chum Jahng: [3].

*Movement 14*—Boang Sau: [4].

*Movement 15*—Seep Ma Tan Da Chahng Dai Jyeung: [5].

*Movement 16*—Toy Ma Gahng/Jom Sau: [9].

*Movement 17*—Toh Ma Ngoy Kwun Sau: [7].

*Movement 18*—Seep Ma Tan Da Chahng Dai Jyeung: [8].

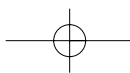
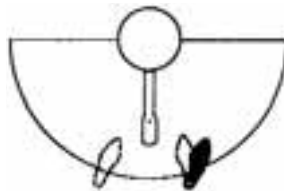
*Movement 19*—Toy Ma Gahng/Jom Sau: [6].

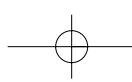


13A

13B

14A





Wooden Dummy Form (Part I)



14B

15

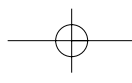
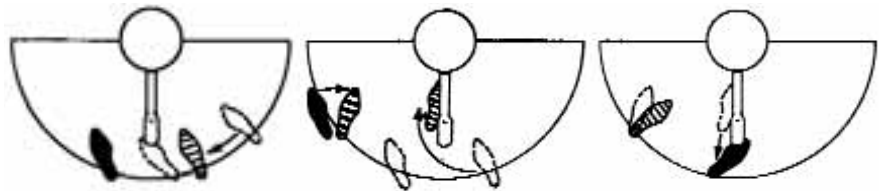
16



17

18

19

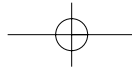


### Close Range Combat Wing Chun: Volume Three

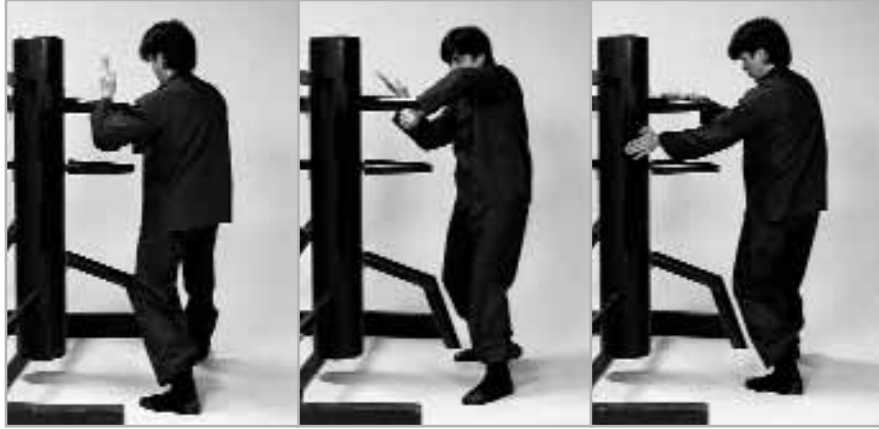
---

***Movement 20***—Loy Seen Wai Loy Kwun Sau, Choh Ma Jut Da Chahng Dai Jyeung, Jing Ma Syeung Loy Jut Sau, Syeung Pau Sau: Step the right foot to the right, back to its starting position on the Semicircle (20A), and simultaneously pivot the stance to the left as the left foot slides in to recover and balance the stance width. During this “Step-and-Face” motion, convert the left Jom Sau into Huen Sau without losing Bridge Contact as the right arm raises to chop the right Dummy arm straight toward the Dummy’s Motherline (20B). At the completion of the motion, the elbow of the left Huen arm has 135° structure and the right Jom Sau palm is angled down at 45° in relation to the floor. Then, pivoting the stance to the right and without losing Bridge Contact with the right hand, convert the right hand into Loy Jut Sau with the palm flat on the Dummy arm and the elbow in. Simultaneously deliver a left Chahng Dai Jyeung low “Spade Palm” strike with the fingers angled 45° downward, snaking the left hand from Huen Sau position to the strike (20C). Slightly disengaging the right hand (20D), pivot the stance back to the center and execute a Double Jut Sau (20E). Next, lift and push forward with both palms (20F) without moving the stance.





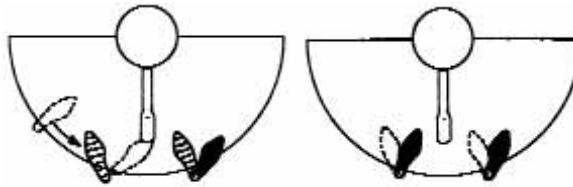
Wooden Dummy Form (Part I)



20A

20B

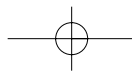
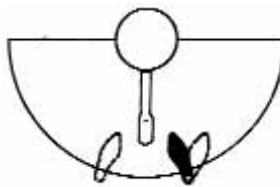
20C



20D

20E

20F



## Close Range Combat Wing Chun: Volume Three

---

### Second Set

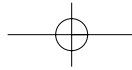
**Movement 21**—Choh Ma Loy Moon Pock Sau (Stance Pivot/“Inside Gate” Slap Block): Pivot the stance to the left and execute a right slap block from inside the left Dummy arm (21A) as the left hand moves to Woo Sau position. At the completion of the motion, the fingers of the Pock hand should be wrapped around the Dummy arm in a forward-energy thumbless grab. This structural change in Pock Sau from the open-handed version seen in Siu Leem Tau is due to its actual contact with the Dummy arm, which signals the fingers to close, securing the trap. The right elbow is on the Immovable Elbow Line. Repeat the motion on the left (21B) and again on the right (21C).

**Movement 22**—Choh Ma Kau Sau, Fun Sau (Stance Pivot/Inward Hooking Hand, Outward Horizontal Chop): Pivot the stance to the right and execute a left inward Kau Sau slap to the outside left Dummy Arm (22A) as the right hand moves to Woo Sau position. At the completion of the motion, the left fingers should be wrapped around the Dummy Arm in a backward-energy thumbless pull. Again like the previous motion and unlike its open-handed Siu Leem Tau counterpart, this version of Kau Sau closes upon actual contact. Next, without moving the stance, execute a left horizontal chop at throat-level (22B). The inner left forearm should remain in contact with the left Dummy arm throughout the chopping motion. This is to serve as a “check” of the blocked arm, necessitated by the fact that your other hand is not grabbing or somehow otherwise trapping that hand. If it were, the forearm contact would not be necessary, and would in fact be counter-productive, slowing the chop down and possibly “telegraphing” your intention to strike. Also, you should ensure that the outside edge of the palm heel makes contact on the Centerline instead of the left fingers striking the Dummy—a common error.

**Movement 23**—Choh Ma Poh Joong Kuen (Stance Pivot/Center-Breaking Punch): Pivoting the stance to the left, retrap the left Dummy arm with a left elbow-in Inside Jerk as the right punch attacks the mid-level area with the fist angled 45° in relation to the floor. The fingers of the left Jut Sau should be flat on the Dummy Arm with the left elbow on the Elbow Line. Note; it is optional to use a Jing Ma pivot back to “Yee” Jee Keem Yeung Ma with the Poh Joong Kuen motion in place of the full Choh Ma pivot, as shown in the footwork diagram.

**Movement 24**—Choh Ma Kau Sau, Fun Sau: [22]. Again, the footwork diagrams depict the optional Jing Ma footwork in place of the stance pivot illustrated in the photos.

**Movement 25**—Choh Ma Poh Joong Kuen, Jing Ma Syeung Loy Jut Sau, Syeung Pau Sau: [23].



Wooden Dummy Form (Part I)

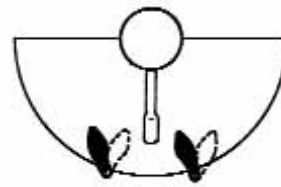
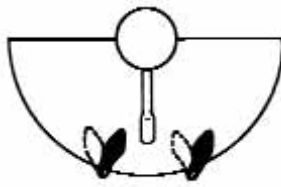
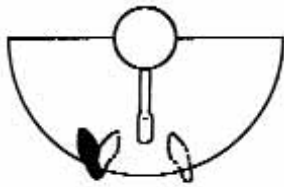


Second Set

21A

21B

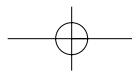
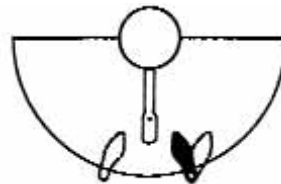
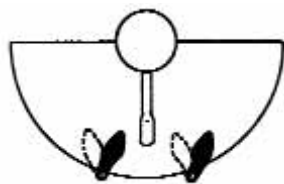
21C

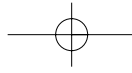


22A

22B

23





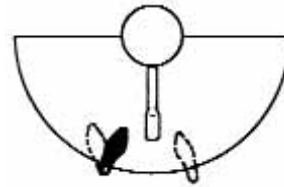
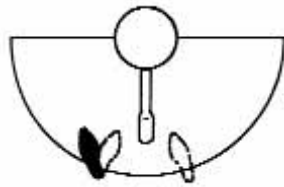
Close Range Combat Wing Chun: Volume Three



24A

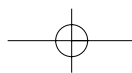
24B

25A



25B

25C



## Wooden Dummy Form (Part I)

---

### Third Set

**Movement 26**—Choh Ma Dai Boang Sau (Stance Pivot/Low Wing Arm Deflection): Pivot the stance to the left and execute a low right Boang Sau with the right elbow closer to the Dummy than the right wrist. The arm should twist from initial contact at the inner right wrist until it ends up with the outer forearm in contact after moving downward with rubbing friction. At the completion of the motion, the low Dummy arm should point past the front of the trainee's body and would not touch him even if it were three feet longer. During the pivot, the left hand moves to Woo Sau position. Note that, even though the right arm twists downward as it makes contact, the low Dummy arm will actually move upward in its square hole.

**Movement 27**—Toh Ma Ngoy Moon Pock Da Fun Sau (Step/Slide/Outside Gate Slap Block/Outward Horizontal Chop): Step the left foot to the left on the Semicircle and slide the right foot an equal distance to recover the original stance width. During the left step, the left hand slaps the outside left Dummy Arm inward. As the right foot slides, the right hand chops outward and upward to the left side of the Dummy. At the completion of the motion, the stance is in Outward Facing relationship to the Dummy. The left hand is turned horizontally with the fingers parallel to the Dummy arm. The fingers point toward the Dummy to prevent the chest and shoulder from tightening up, as they would if the Pock Sau structure were not altered to suit its Outward Facing application. This "sideways" Pock Sau slap keeps the chest relaxed, allowing the blocking hand to travel farther, and forms the root of the shoulder trap that is often used as a brace with forearm strikes and neckbreaks.

**Movement 28**—Boang Sau Fon Sun Deng Jing Gyeuk, Syeung Ma Dai Boang Sau (Wing Arm Deflection/Regaining Position/Nailing Straight Kick, Stepdown/Low Wing Arm Deflection): Pivot inward on the ball of the left foot to face the Dummy (28A) and raise the right arm to Boang Sau position with the elbow at eye level. This Boang Sau motion is primarily for use as a Joang Sau guard. Note also that the pivot on the ball of the foot will bring the trainee slightly farther from the Dummy than pivoting on the heel would have. Shoot the right foot directly to a hip-level Stamping Front Kick to the Dummy trunk (28B). At the completion of the motion, the toes of the right foot should be angled 45° upward. Smoothly step down and slide the left foot to the right as the left low Wing Arm Deflection twists into the low Dummy arm with downward friction (28C).

**Movement 29**—Toh Ma Ngoy Moon Pock Da Fun Sau: [27].

## Close Range Combat Wing Chun: Volume Three

---

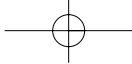
**Movement 30**—Boang Sau Fon Sun Huen Jing Gyeuk, Syeung Ma Gahng/Jom Sau (Wing Arm Deflection/Regaining Position Circling Front Kick, Stepdown/High Sweep/Low Chop Block): Turn back inward to face the Dummy, pivoting on the ball of the right foot. As the pivot completes, raise the left arm to a guarding Boang Sau position with the elbow at eye-level and the right hand in Woo Sau position, not blocking the vision. After the Boang arm is in position, circle the left foot to a hip-level Huen Jing Gyeuk to the Dummy trunk (30A). Smoothly step down with the left and slide the right foot as both the high Sweep Block and low Chop Block make contact (30B). At the completion of the stepdown, the left foot should be positioned very near the Dummy leg, but not past it.

**Movement 31**—Loy Seen Wai Loy Kwun Sau: [10].

**Movement 32**—Jing Ma Kwok Sau, Syeung Chahng Dai Jyeung, Syeung Chahng Jyeung, Syeung Jom Sau, Syeung Pau Sau (Return to Center/Double Circling Spread, Double Low “Spade Palm” Strike, Double “Spade Palm” Strike, Double Inward Chop Block, Double Lifting Palm): Without losing Bridge Contact with either hand, flip the right hand up from its previous Huen Sau position to Fook Sau structure (32A). This action should snap the right Dummy arm inward in its square hole. Next, pivot the stance back to the center with a double downward/outward circling snap of both wrists to Kwok Sau (double Huen Sau) position with both elbows up in 135° structure (32B). Because of the previous positioning of both upper Dummy arms in their square holes from your last contact with each of them, they will both move outward with an audible snap. Circling the wrists to get inside the Dummy arms, shoot both hands in and down to a double Chahng Dai Jyeung strike with the fingers angled 45° downward on both sides (32C).

Next, roll both hands in an inside whipping motion (32D) up to a double Chahng Jyeung palm strike with the fingers angled 45° upward (32E, 32F).

Without moving the stance, sharply pull both elbows in, twisting both palms inward as they strike the Dummy arms with backward-pulling energy (32G). At the completion of the motion, the elbows should be on the Elbow Line in Origin Position with the palms parallel and facing each other. Then lift and push forward with a sharp snap of both palms (32H).



Wooden Dummy Form (Part I)

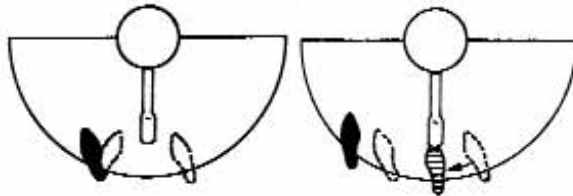


Third Set

26

27

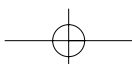
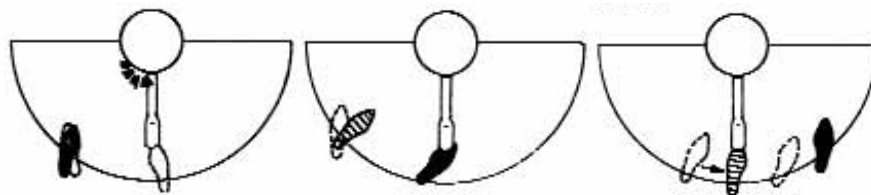
28A

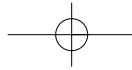


28B

28C

29





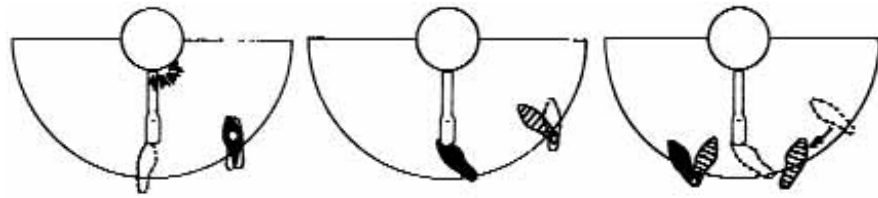
Close Range Combat Wing Chun: Volume Three



30A

30B

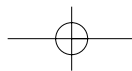
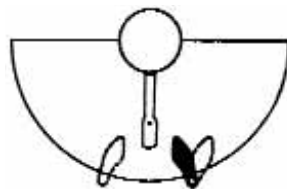
31



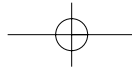
32A

32B

32C







Wooden Dummy Form (Part I)



32D

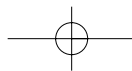
32E

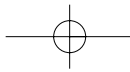
32F



32G

32H





### Close Range Combat Wing Chun: Volume Three

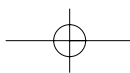
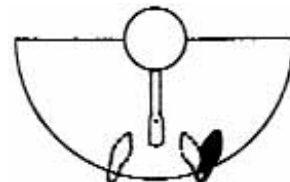
#### Fourth Set

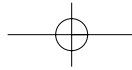
**Movement 33**—Choh Ma Loy Kwun Sau: Without losing Bridge Contact with either hand, pivot the stance to the right as the right hand circles counter-clockwise over the right Dummy arm to Huen Sau position and the left follows a clockwise arc over the left Dummy arm to Jom Sau position (33A). During this Yin/Yang Complex Motion, the “receiving” Huen Sau pulls inward and slides slightly toward the trainee’s body, while the Yang Jom Sau motion rubs forward with inward-twisting friction. Although the inflexible nature of the Dummy arm will prevent the Jom Sau from pushing it to the desired position of Centerline Advantage, you should be aware that your *intention* is to achieve perfect Applied Structure. Staying as close as possible to the Dummy arms, pivot the stance to the left as the left hand follows a clockwise over-the-top circle to Huen Sau position and the right hand snakes around the right Dummy arm to Jom position from underneath in a counter-clockwise circling motion (33B). Again, the Huen Sau should pull in and up with an inward slide on the left Dummy arm and the Jom Sau should burn forward. Next, repeat the motion on the right (33C) and finish with a Stance Pivot/Inside Jerk/Vertical Palm Strike (33D, 33E) as was previously described in Movement 10.

Jing Ma Syeung Loy Jut Sau, Syeung Pau Sau: [10C], [10D].

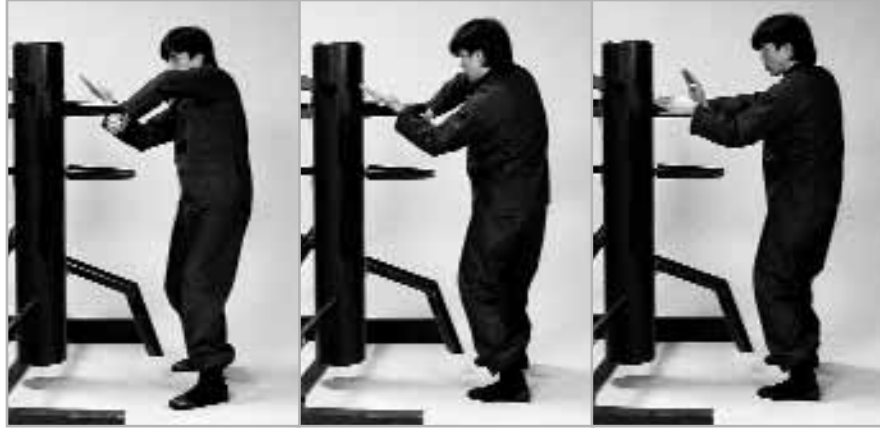


Fourth Set 33A





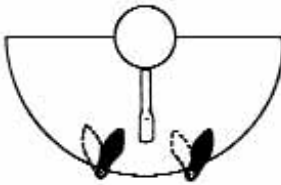
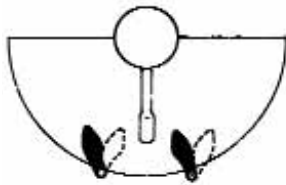
Wooden Dummy Form (Part I)



33B

33C

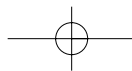
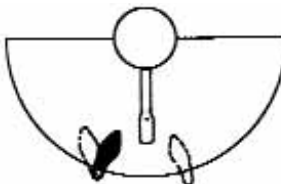
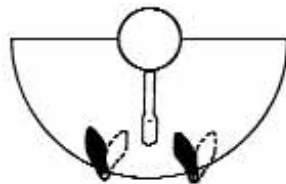
33D

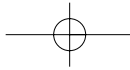


33E

33F

33G





### Close Range Combat Wing Chun: Volume Three

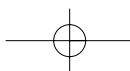
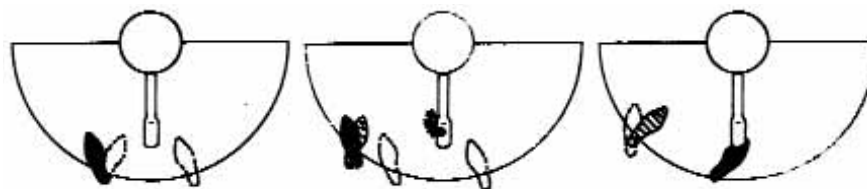
**Movement 34**—Choh Ma Boang Sau, Tan Da Chahng Dai Jyeung Jau Wai Yai Sut, Syeung Ma Gahng/Jom Sau (Stance Pivot/Wing Arm Deflection, Palm-Up Block/Low “Spade Palm” Strike/Step to a New Line/Knee Attack, Stepdow/Low Sweep/High Chop Block): Pivot the stance to the left and execute a right Boang Sau as the left hand moves to Woo Sau position (34A). Step the left foot to the left on the Semicircle and, without losing Bridge Contact with the right arm, pivot the left foot inward to face the Dummy as the right hand becomes Tan Sau, the left hand strikes with a low “Spade-Palm” thrust and the right foot stomps the Dummy leg (34B). The right foot begins to raise as the right arm flips from Boang Sau to Tan Sau. At the completion of the motion, the Tan Sau should contact the left Dummy arm with the back of the hand and a sharply bent wrist. The thumb should be tucked with the palm flat and parallel to the floor. The fingers of the left hand are angled 45° downward. The kicking foot is turned toes-out and the striking surface is the heel. Step down with the right foot to a position not past the Dummy leg

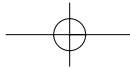


34A

34B

34C





### Wooden Dummy Form (Part I)

as the Tan hand flips inward toward the trainee's body and then circles downward to an outward, forward-cutting Sweep Block while the left hand moves to Jom Sau position (34C). This motion should not change the Centerline from that created by the previous movement. Both blocks should coincide with a short, sharp inward pivot to the right.

**Movement 35**—Loy Seen Wai Loy Kwun Sau, Choh Ma Loy Kwun Sau, Choh Ma Jut Da Chahng Dai Jyeung: [20A, 20B, 33A, 33B, 20B].

Jing Ma Syeung Loy Jut Sau, Syeung Pau Sau: [20C, 20D].

**Movement 36**—Choh Ma Boang Sau, Tan Da Chahng Dai Jyeung Jau Wai Yai Sut, Syeung Ma Gahng/Jom Sau: [34A–C].

**Movement 37**—Loy Seen Wai Loy Kwun Sau, Choh Ma Jut Da Jing Jyeung: [10A, 10B].

Syeung Loy Jut Sau: [10C].

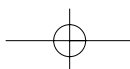
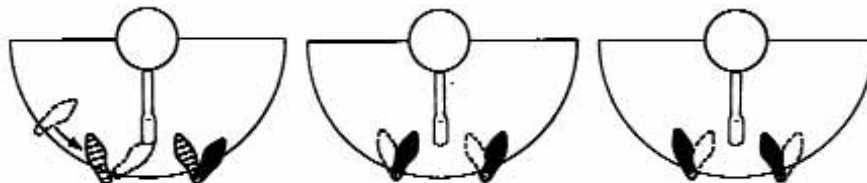
Syeung Pau Sau: [10D].

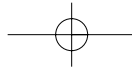


35A

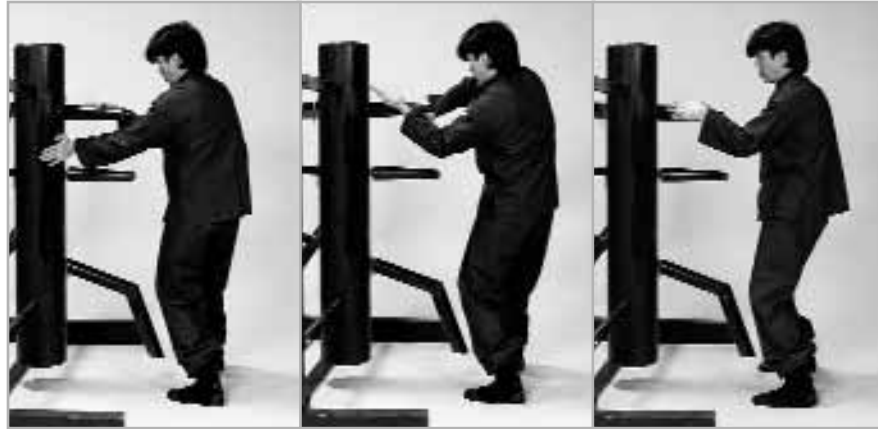
35B

35C





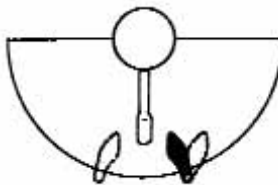
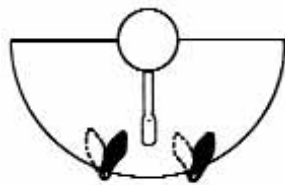
Close Range Combat Wing Chun: Volume Three



35D

35E

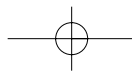
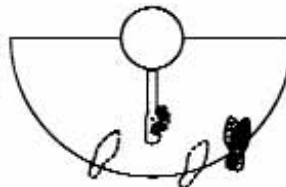
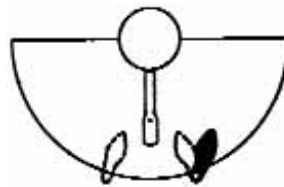
35F

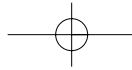


35G

36A

36B





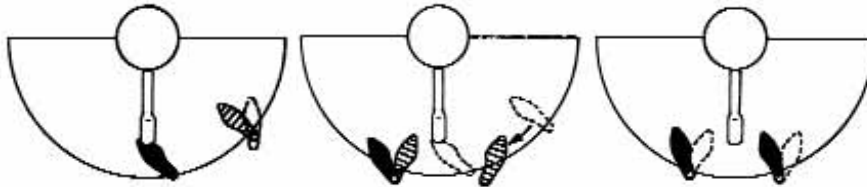
Wooden Dummy Form (Part I)



36C

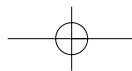
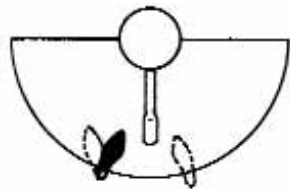
37A

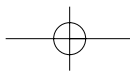
37B



37C

37D



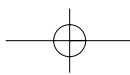
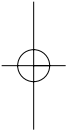


## Close Range Combat Wing Chun: Volume Three

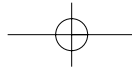
---

### **Fifth Set**

*Movement 38*—Huen Fook Sau, Loy Jut Sau, Biu Sau (Circling Bridge, Inside Jerk, Thrusting Hand): Without moving the stance, retract the left fist to a Sau Kuen chambered position near the ribs as the right hand turns palm-down. Begin to circle the right hand clockwise out and around the left Dummy arm (38A) and back in between the Dummy arms with the palm facing downward and the middle finger on the Centerline (38B, 38C). At the completion of the motion, the right elbow should be in Origin Position and the right wrist should be “loaded-up” with a 45° outward bend that resembles Loy Jut Sau structure. The circle of the right forearm should end in time with the completion of the Sau Kuen retraction of the left fist. Next, retract the right elbow slightly to pull the right hand inward and strike the inside left Dummy arm with the base of the right palm, pressing down and in (38D). Then, unloading the right wrist, shoot the right hand forward on the Centerline so that the outer right forearm burns forward and outward against the inside right Dummy arm as the wrist straightens (38E). Due to the inflexible nature of the Dummy arms, the Biu Sau motion will be stopped before it can reach 100% completion.







Wooden Dummy Form (Part I)



Fifth Set

38A

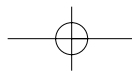
38B

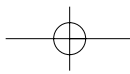
38C



38D

38E





### Close Range Combat Wing Chun: Volume Three

---

**Movement 39**—Choh Ma Jom Sau, Loy Seen Wai Huen Da Chahng Dai Jyeung (Stance Pivot/Inward Chop Block, Step-and-Face/Circling Hand/Low “Spade Palm” Thrust): Keeping the left hand chambered at the ribs, pivot the stance to the left and execute a right Inward Chop Block to the left Dummy arm (39A). The power of the right hand should be focused down the Centerline toward the Dummy’s Motherline. Without losing Bridge Contact with the right arm, step the left foot to the left on the Semicircle to begin the Inside Facing footwork. As the right foot slides to the left to recover the original stance width, both feet pivot to the right to face the Dummy and the right wrist circles counter-clockwise over the top of the left Dummy arm to become Huen Sau, lifting the arm upward in its square hole. During this same time, the left hand thrusts inward from its chambered position to a low “Spade Palm” strike with the fingers angled 45° downward for bone alignment (39B). The pivot, circling block and low strike should all come to full extension at the same time in one integrated motion.

**Movement 40**—Toh Ma Ngoy Kwun Sau, Jing Ma Poh Pai Jyeung (Step/Slide/Outward Rolling Arms Block, Return to Center/Twin Palm Strike): Step the right foot to the right on the Semicircle and begin to circle the right hand underneath the left Dummy arm. As the left foot slides to the right to recover the original stance width, the right elbow snaps downward, adding whipping power to the already spiraling right Tan Sau and the left arm twists inward and downward, making contact with the low Dummy arm beginning at the inner left wrist and rubbing it with spinning friction that ends up at the outer forearm (40A). At the completion of the motion, the low Dummy arm should not be pointing at the trainee’s body and the left elbow should be closer to the Dummy than the left wrist. The right Tan Sau should make contact with the inside right Dummy arm at the back of the hand and wrist with the palm facing directly upward. The power of both should be directed toward the Dummy’s Motherline. Next, pivot the stance to the center and execute a simultaneous right Jing Jyeung and left Pau Jyeung with the right hand on top (40B). Both palm heels should be on the Centerline and both thumbs should be tucked to prepare the hands and arms for contact.

**Movement 41**—Choh Ma Boang Sau, Seep Ma Poh Pai Jyeung, Toy Ma Gahng/Jom Sau (Stance Pivot/Wing Arm Deflection, Three Point Stance/Twin Palm Strike, Retreating Pivot/Low Sweep/High Chop Block): Pivot the stance to the right and begin to circle the left arm outside the left Dummy arm. Thread the left Boang Sau between both Dummy arms from above the left arm and make contact with the inner right Dummy arm with a forward, twisting “swimming” motion, slightly opening the left

**Wooden Dummy Form (Part I)**

arm to 135° structure as the pivot is completed (41A). Step the right foot to the right on the Semicircle and slide the left foot around the Dummy leg in an arcing path as the left elbow snaps downward, spinning the left palm into a Pau Jyeung reverse vertical palm strike which makes contact with a partially-bent elbow together with the right Jing Jyeung vertical palm strike as the right foot slides forward to complete the Seep Ma footwork (41B). The hips and pelvis should come forward to add Raising Power to the Poh Pai Jyeung strike.

Slide the left foot back to a position near but not past the Dummy leg and execute Gahng/Jom Sau in time with a short, sharp pivot of both feet to the left (41C). This motion should not change the Centerline originally created by the Seep Ma footwork of the previous motion.

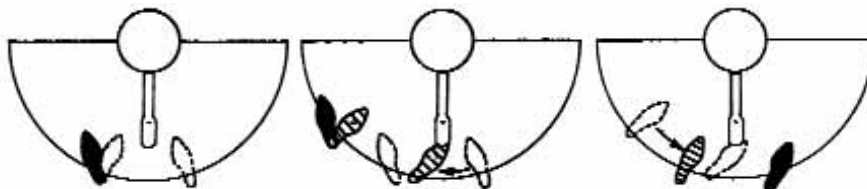
**Movement 42—Jing Ma Poh Pai Jyeung:** Step the left foot to the left on the Semicircle and pivot back to the original “Yee” Jee Keem Yeung Ma position with a slide of the right foot. Simultaneously strike the Dummy with Poh Pai Jyeung, right over left.

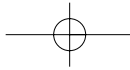


39A

39B

40A





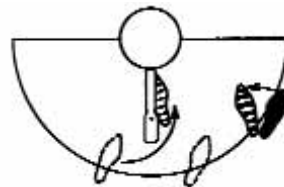
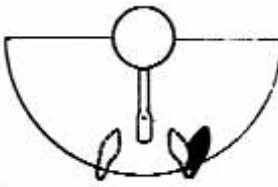
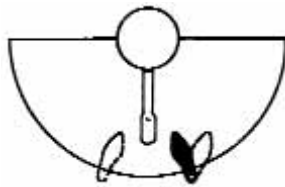
Close Range Combat Wing Chun: Volume Three



40B

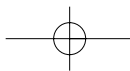
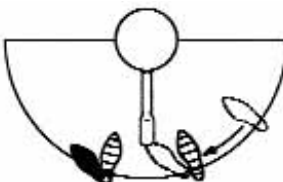
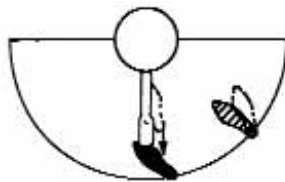
41A

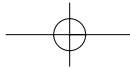
41B



41C

42





### Wooden Dummy Form (Part I)

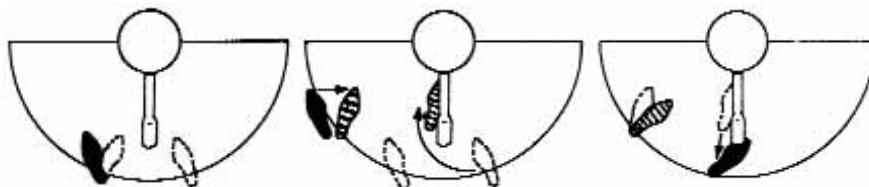
**Movement 43**—Choh Ma Boang Sau, Seep Ma Poh Pai Jyeung, Toy Ma Gahng/Jom Sau: Pivot the stance to the left and execute a right Wing Arm Deflection (43A). Step the left foot to the left on the Semicircle and begin to slide the right foot around the Dummy leg and toward the Dummy's left side. As the right foot arc-steps inward, the right hand extends as the top half of another Poh Pai Jyeung strike which, together with the left Pau Jyeung, comes to completion in time with the left sliding recovery step (43B). As the double strike makes contact, the hips and pelvis come forward to add Raising Power. Next, step back with the right foot to a point near but not past the Dummy leg and execute the Low Sweep/High Chop block beginning with an inward snap of the right wrist and extending with a “Whirlpool Energy” release of both circular and straight snap (43C). This motion doesn't alter the Centerline created by the previous Seep Ma footwork and comes to full extension in time with a short, sharp inward pivot of the stance.

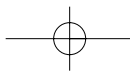


43A

43B

43C





### Close Range Combat Wing Chun: Volume Three

---

**Movement 44**—Loy Seen Wai Loy Kwun Sau, Choh Ma Jut Da Chahng Dai Jyeung: [20A].

Jing Ma Syeung Loy Jut Sau, Syeung Pau Sau: [20C, 20D].

**Movement 45**—Huen Fook Sau, Loy Jut Sau, Biu Sau: Without moving the stance, begin to retract the right hand to the ribs and turn the left palm down with the middle finger pointing straight down the Centerline (45A). Circle the left palm to the right of the right Dummy arm and then over it. Continue the counter-clockwise circling motion (45B) until the left hand is between the two upper Dummy arms in Loy Jut Sau structure, palm-down with the middle finger on the Centerline (45C).

Loy Jut Sau, Biu Sau: [38C, 38D].

**Movement 46**—Choh Ma Jom Sau, Loy Seen Wai Huen Da Chahng Dai Jyeung: [39].

**Movement 47**—Toh Ma Ngoy Kwun Sau, Jing Ma Poh Pai Jyeung: [40].

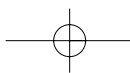
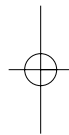
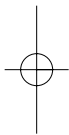
**Movement 48**—Choh Ma Boang Sau, Seep Ma Poh Pai Jyeung, Toy Ma Gahng/Jom Sau: [41].

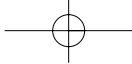
**Movement 49**—Jing Ma Poh Pai Jyeung: [42].

**Movement 50**—Choh Ma Boang Sau, Seep Ma Poh Pai Jyeung, Toy Ma Gahng/Jom Sau: [43].

**Movement 51**—Loy Seen Wai Loy Kwun Sau, Choh Ma Jut Da Jing Jyeung: [10A, 10B].

Jing Ma Syeung Loy Jut Sau, Syeung Pau Sau: [10C, 10D].





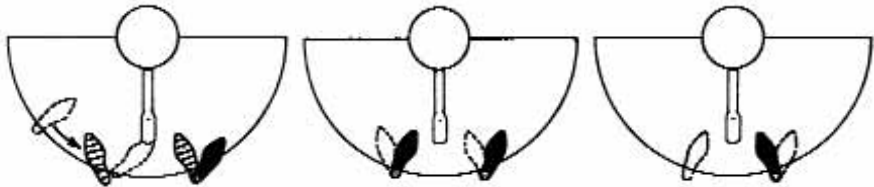
Wooden Dummy Form (Part I)



44A

44B

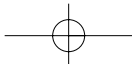
44C

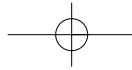


44D

44A

44B





Close Range Combat Wing Chun: Volume Three



45C

45D

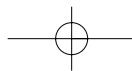
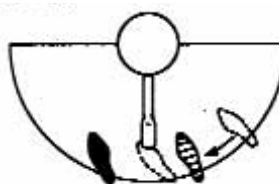
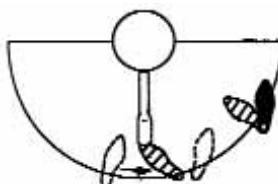
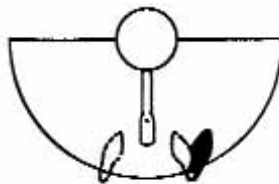
45E



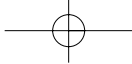
46A

46B

47A







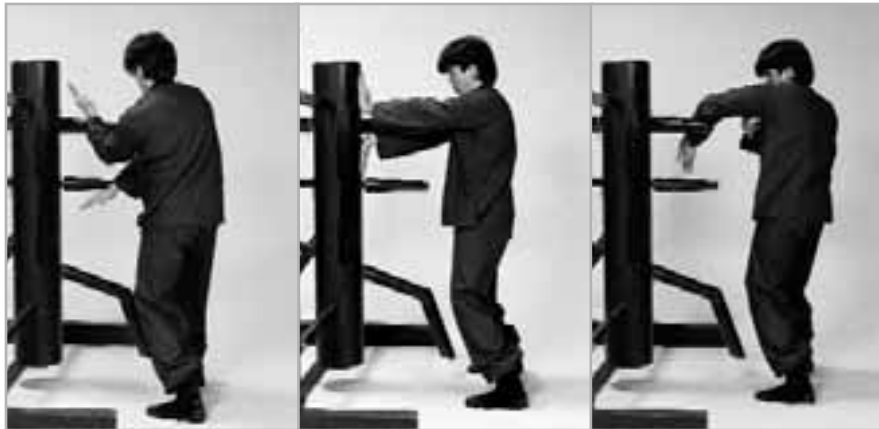
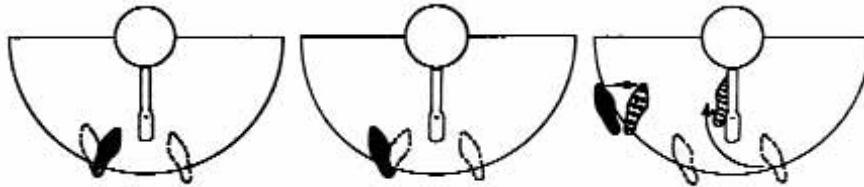
Wooden Dummy Form (Part I)



47B

48A

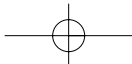
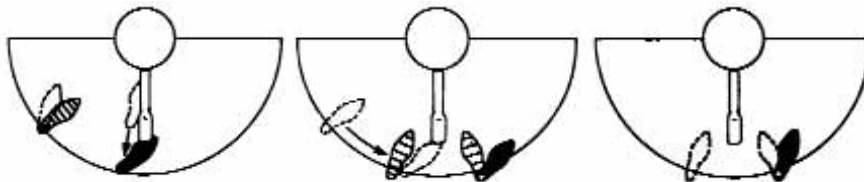
48B

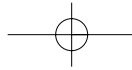


48C

49

50A





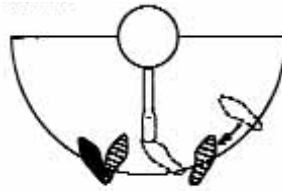
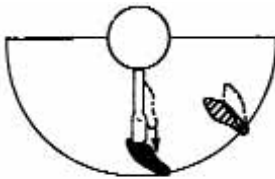
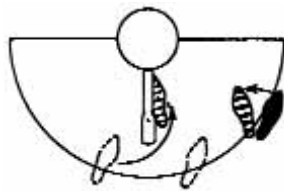
Close Range Combat Wing Chun: Volume Three



50B

50C

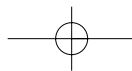
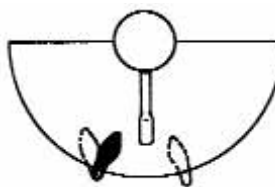
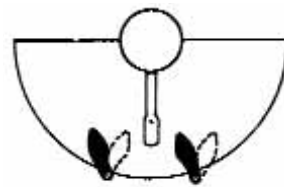
51A



51B

51C

51D



## Wooden Dummy Form (Part I)

---

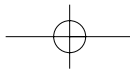
### Sixth Set

**Movement 52**—Choh Ma Gahng/Jom Sau (Stance Pivot/Low Sweep/High Chop Block): Pivot the stance to the right as the right wrist snaps inward (52A) and then circles downward and forward to Gahng Sau position. During the downward circling motion of the right arm, the left arm thrusts forward to the outer left Dummy Arm in Jom Sau position, burning inward on the Centerline toward the Dummy's Motherline (52B). At the completion of the motion, the right hand should be twisted 45° outward so that the thumb is pointing back toward the trainee's Motherline, remaining tucked to prepare the arm and wrist for contact which is made above the wrist, with the heel of the hand not touching the low Dummy arm. The left elbow should be on the Elbow Line, and the right hand should be angled 45° in relation to the floor. Repeat this motion, remembering to close three fingers, pinch two and to snap the Gahng wrist inward before circling downward, on the left (52C and D) and again on the right (52E).

**Movement 53**—Choh Ma Boang Sau, Loy Seen Wai Lop/Fun Sau (Stance Pivot/Wing Arm Deflection, Step-and-Face Grab/Outward Horizontal Chop): Pivot the stance to the left and execute a right Boang Sau (53A), circling the right hand outside the right Dummy Arm and then down through both Dummy arms in a threading "jack-knife" motion. Without losing Bridge Contact with the right arm, step the left foot to the left on the Semicircle (53B) as the left hand chambers near the right ear and the right hand circles under to become a thumbless Lop Sau grab. Pivot both feet to the right as the left hand chops out to throat level and the right foot slides to the left to recover the original stance width (53C). The shoulders should turn sharply to the right to add clockwise Yang power to the chop through a counterturn.

**Movement 54**—Loy Seen Wai Jut Da Chahng Geng (Step-and-Face/Inside Jerk/Throat Spade): Step the right foot to the right on the Semicircle as the right hand releases its grab, chambering for a "Spade Palm" thrust, and the left hand drops from Fun Sau position to retrap the left Dummy Arm (54A). Sliding the left foot inward to recover the original stance width, pivot both feet to the left as the left hand pulls inward on the left Dummy arm and the right hand shoots between both Dummy arms to a Chahng Jyeung "Spade Palm" strike on the Centerline (54B). At the completion of the motion, the stance should be fully pivoted to the left, directly in front of the Dummy on the Original Centerline. The left palm should be flat on the left Dummy arm and the left elbow should be in Origin Position. The striking surface of the right hand is the entire palm, which is angled 45° upward with the elbow fully extended.

Jing Ma Syeung Loy Jut Sau, Syeung Pau Sau: [10C, 10D].



**Close Range Combat Wing Chun: Volume Three**

*Movement 55*—Choh Ma Gahng/Jom Sau: [52].

*Movement 56*—Choh Ma Boang Sau, Loy Seen Wai Lop/Fun Sau: [53].

*Movement 57*—Loy Seen Wai Jut Da Chahng Geng: [54].

Jing Ma Syeung Loy Jut Sau: [20C].

Syeung Pau Sau: [20D].

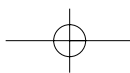
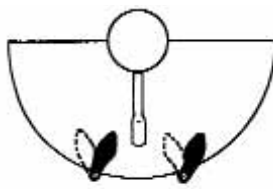
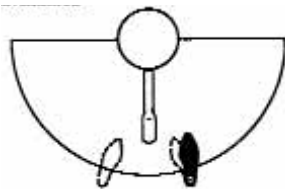


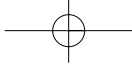
Sixth Set

52A

52B

52C





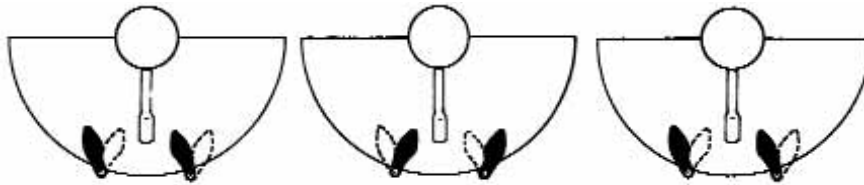
Wooden Dummy Form (Part I)



52D

52E

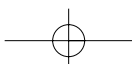
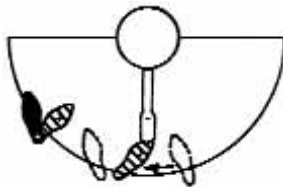
53A

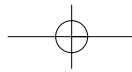


53B

53C

54A





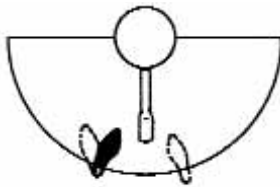
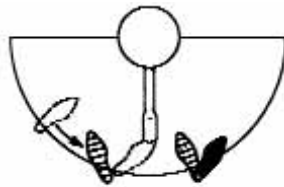
Close Range Combat Wing Chun: Volume Three



54B

54C

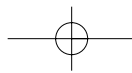
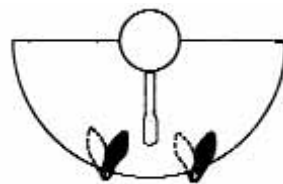
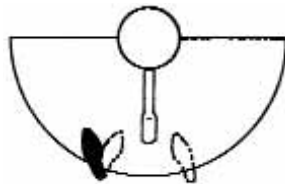
54D

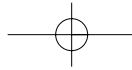


55A

55B

55C





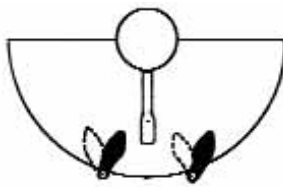
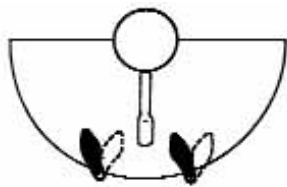
Wooden Dummy Form (Part I)



55D

56A

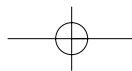
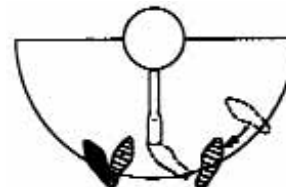
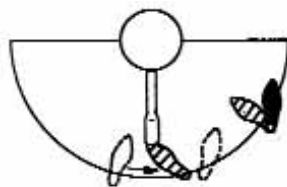
56B

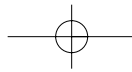


56C

57A

57B



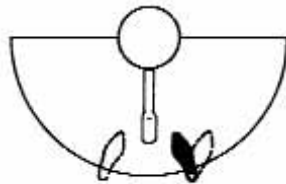


Close Range Combat Wing Chun: Volume Three



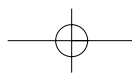
57C

57D



**Seventh Set**

*Movement 58*—Choh Ma Boang Sau, Jau Wai Tan Da Chahng Dai Jyeung Yai Hau Gyeuk, Syeung Ma Gahng/Jom Sau (Stance Pivot/Wing Arm Deflection, “Walk Crooked” Palm-up Block/Low “Spade Palm” Thrust/Attack the Rear Leg, Stepdown/Low Sweep/High Chop Block): Pivot the stance to the left and execute a right Boang Sau, circling the right hand outside the right Dummy arm and then down through both Dummy arms in a threading “jack-knife” motion (58A). Without losing Bridge Contact with the right arm, step the left foot to the left on the Semicircle, flip the right arm into Tan Sau position, and slide the right foot heel-to-heel in a straight line with the knees bent similarly to the first opening movement of “Yee” Jee Keem Yeung Ma (58B) as the left hand chambers for a low palm strike. Still pressing forward and downward with the right wrist and back hand of Tan Sau, execute a simultaneous low left “Spade Palm” thrust with the fingers angled 45° downward and same-side left Jing Gyeuk to the Dummy trunk with the kicking foot angled 45° upward (58C). Step the left foot back down to the same spot it was in just before the kick (58D) and then step the right foot to a point on the Semicircle near but not past the





## Wooden Dummy Form (Part I)

---

Dummy leg, sliding the left to recover the original stance width in time with the snap of Gahng/Jom Sau (58E).

**Movement 59**—Toh Ma Boang Sau, Tan Da Chahng Dai Jyeung Yai Hau Gyeuk, Syeung Ma Gahng/Jom Sau: Take a long step with the right foot to the right on the Semicircle as the left hand begins to thread between the Dummy arms from above the left Dummy arm, snapping to completion in time with the right heel touching the ground as it does in Movements 66 and 68 of the Chum Kiu form (59A). Be sure to focus the wedging action of the left Boang Sau towards the Dummy's core in the same direction as the force of the lunging right step. The sliding motion that would normally end when the normal Choh Ma stance width was recovered instead continues on as the feet are brought together heel-to-heel again on the Semicircle.

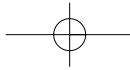
Without losing Bridge Contact with the left hand, slide the left foot along the Semicircle until it is heel-to-heel with the right as the left elbow whips down into Tan Sau position and the right hand chambers for a low "Spade Palm" thrust (59B). Still maintaining forward/downward pressure with the backhand and sharply-bent wrist of the left Tan Sau, execute a simultaneous right Chahng Dai Jyeung/right Jing Gyeuk (59C). At the completion of the motion, the left palm faces directly upward, the fingers of the right hand are angled 45° downward for proper bone alignment, and the right foot is angled 45° upward to expose and extend the heel. Step down first heel-to-heel (59D), then to a point near but not past the Dummy leg and execute Gahng/Jom Sau in time with a right sliding step-and-pivot that recovers the original stance width (59E).

**Movement 60**—Loy Seen Wai Loy Kwun Sau, Choh Ma Jut Da Jing Jyeung: [10A, 10B]

Jing Ma Syeung Loy Jut Sau, Syeung Pau Sau: [10C, 10D].

(Optional) Sau Sick (Closing Stance Position): If the form is to end at this point, simultaneously slide the left foot to the right and retract both fists to the ribs (SS-1). Turn both palms downward, exhale and bring the palms down to the sides (SS-2).

This completes Part I of the form. The remaining 48 motions should be performed only by students at Biu Jee level and above. If the form is to continue past this point, the last two motions seen in photos SS-1 and SS-2 should be omitted so that next movement (Choh Ma Gum Sau) follows directly after the Double Lifting Palm seen above.



Close Range Combat Wing Chun: Volume Three

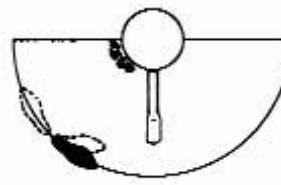
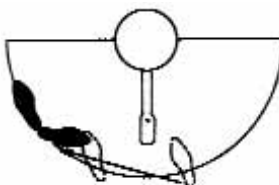
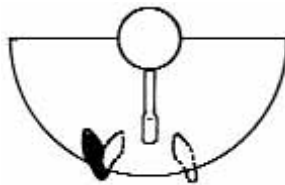


Seventh Set

58A

58B

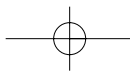
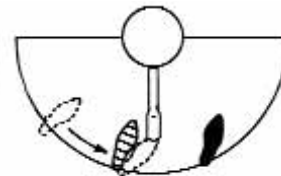
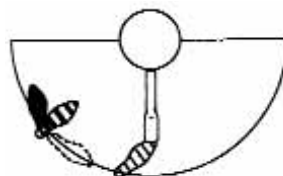
58C

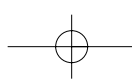


58D

58E

59A





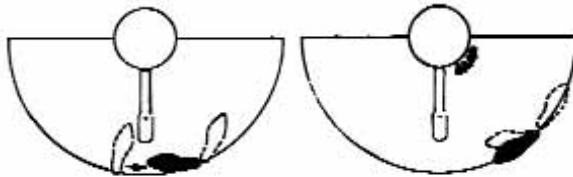
Wooden Dummy Form (Part I)



59B

59C

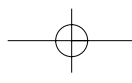
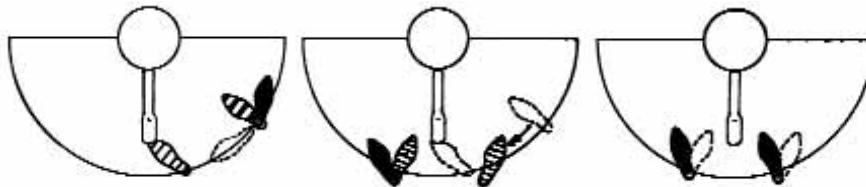
59D

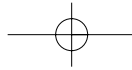


59E

60A

60B



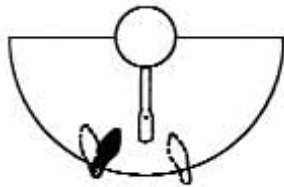


Close Range Combat Wing Chun: Volume Three



60C

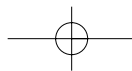
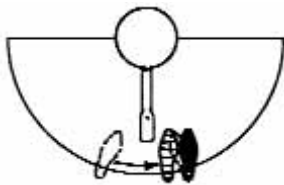
60D

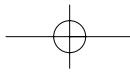


*Sau Sick*

SS1

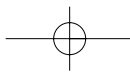
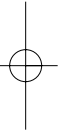
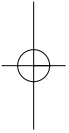
SS2





# **WOODEN DUMMY FORM**

## **(PART II)**



## Close Range Combat Wing Chun: Volume Three

---

### **Eighth Set**

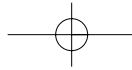
**Movement 61**—Choh Ma Gum Sau (Stance Pivot/Downward Pressing Block): Pivot the stance to the left and execute a right palm-down slap block to the low Dummy arm as the left hand raises to Woo Sau position (61A). At the completion of the motion, the right elbow is up in 135° structure and the fingers of the right hand are closed around the Dummy arm in a thumbless grab. Repeat the motion with a right stance pivot/left Gum Sau (61B) and again with a left pivot/right downward block (61C). Like Pock Sau and Kau Sau, Gum Sau Applied Structure changes in the Dummy form due to the added element of contact.

**Movement 62**—Seep Ma Pock Da Dai Jyeung, Toy Ma Gum Sau (Three Point Stance/Slap Block/Low Palm Strike/Retreating Pivot/Downward Pressing Block): Step the left foot to the left on the Semicircle, slide the right foot in an arcing path around the Dummy leg and begin a left Slap Block to the outer left Dummy arm. As the left sliding step is completed, execute a low right palm strike to the midsection (62A). At the completion of the motion, both elbows are in Origin Position on the Elbow Line and the right hand is horizontal with the palm heel on the Original Centerline, although the body is referenced 45° off that line. The right heel should not be raised from the floor. Slide the right foot back to a point past the Dummy leg to recover the Original Centerline and pivot both feet to the right as the left hand drops to a counter-clockwise-twisting downward palm block and the right hand raises to Woo Sau (62B). This version of Toy Ma can step further than when executing Gahng/Jom Sau because its point of Reference is the low Dummy arm; the upper left Dummy arm used in Gahng/Jom Sau is in this case “non-existent.”

**Movement 63**—Choh Ma Gum Sau: [61A, 61B].

**Movement 64**—Seep Ma Pock Da Dai Jyeung, Toy Ma Gum Sau: [62].

**Movement 65**—Pock Sau Chai Sut Dai Gyeuk, Syeung Ma Gum Sau (Slap Block/Knee-Scraping Low Kick, Stepdown Downward Pressing Block): Step the left foot to the left on the Semicircle and turn in to face the Dummy with a simultaneous left Pock Sau to the outer left Dummy arm and low right stomp to the Dummy's knee (65A). As the block and kick are extended, the right hand moves to Woo Sau position. At the completion of the motion, the base leg should remain bent to keep the body straight and balanced. The fingers of the left hand should be closed around the left Dummy arm in a thumbless grab. Step down with the right foot past the Dummy leg to recover the Original Centerline and slap downward on the low Dummy arm with a clockwise-spinning left Gum Sau as the left foot slides to recover the original stance width (65B).



### Wooden Dummy Form (Part II)

During this motion, the right hand remains in Woo Sau position. At the completion of the motion, the fingers of the left hand should be closed around the low Dummy arm in a thumbless grab.

**Movement 66**—Pock Sau Chai Sut Dai Gyeuk, Syeung Ma Gum Sau: [65].

**Movement 67**—Pock Sau Ngoy Tiu Gyeuk (Slap Block/Outward Instep Kick): Step the left foot to the left on the Semicircle and turn to face the Dummy with a simultaneous left Pock Sau to the outer left Dummy arm and right Outward Instep Kick to the left side of the Dummy's inner knee joint. During the execution of the kick, the right ankle should be snapped sharply inward to add *Bau Ja Ging* Explode Power to the motion.

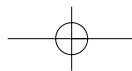
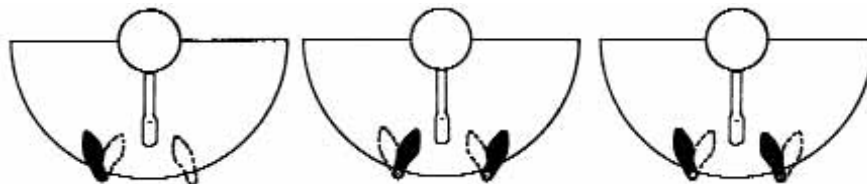


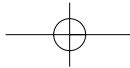
Eighth Set

61A

61B

61C





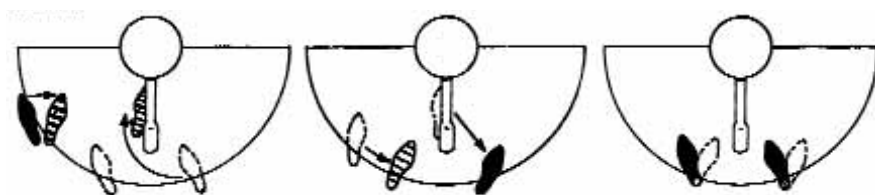
### Close Range Combat Wing Chun: Volume Three



62A

62B

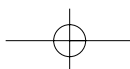
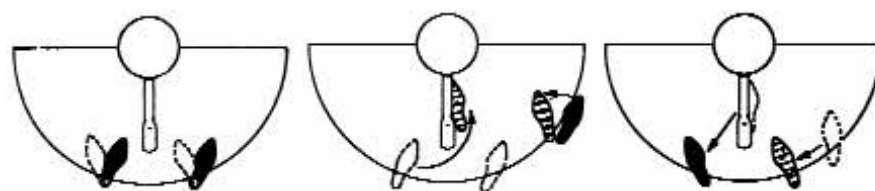
63A



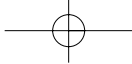
63B

64A

64B







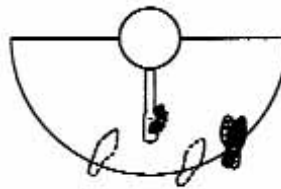
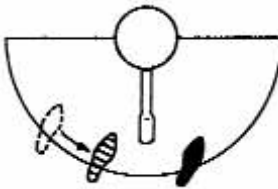
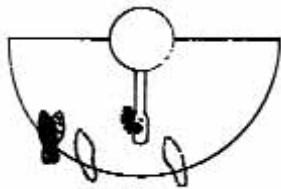
Wooden Dummy Form (Part II)



65A

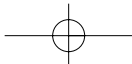
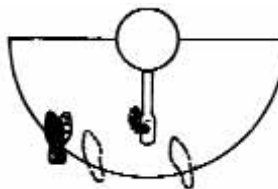
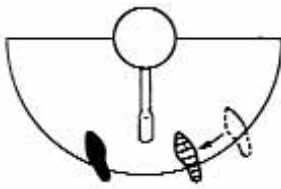
65B

66A



66B

67



### Close Range Combat Wing Chun: Volume Three

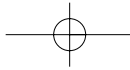
---

**Movement 68**—Bai Ying Jing Ngau Gyeuk, Wui Ying Gum Sau (Losing Balance/Straight Hooking Foot, Regain Balance/Downward Pressing Block): Without losing Bridge Contact with the right foot, slip the instep underneath inner knee joint of the Dummy leg and simulate a loss of balance by leaning backward until the entire torso is in line with the extended right leg. As the body leans back, the right hand circles over the left, remaining in Woo Sau structure become a Joang Sau extended-lead Guarding Hand (68A). At the completion of the motion, the left hand is in Woo Sau position, and the line formed by the body and the extended right leg is angled 45° in relation to the floor. The head should remain upright.

Use the descent of the right foot to sharply snap the body back to an upright position and execute a left Downward Press Block powered by the falling momentum of the body as the right hand circles under the left to Woo Sau position (68B). At the completion of the motion, the stance is once again referenced to the Original Centerline.

**Movement 69**—Pock Sau Ngoy Tiu Gyeuk: [67].

**Movement 70**—Bai Ying Jing Ngau Gyeuk, Wui Ying Boang Sau, Pock Da Foong Ngon Kuen Kup Yai Sut Dai Gyeuk, Syeung Gahng/Jom Sau (Losing Balance/Straight Hooking Foot, Regaining Balance/Wing Arm Deflection, Slap Block/“Phoenix-Eye” Punch/Knee Attack, Stepdown/Low Sweep/High Chop Block): Without losing contact with the left foot, slip the left instep under the inner knee joint of the Dummy leg and turn the toes outward to hook the leg from the inside right. Using the left foot to support the bodyweight, lean radically backward until the torso and extended left leg are aligned at a 45° angle in relation to the floor. As the body moves backward, the right hand retracts to Woo Sau position and the left circles forward over the right to guard the Centerline in extended Joang Sau position (70A). At the completion of the motion, the head should remain upright and the body and left leg should be in line and supported by a 135° bent knee. Using the left foot to snap the body back to good structure and balance, step the left foot down past the Dummy leg to a position that leaves both feet equally spaced to either side of the Original Centerline at the completion of the right sliding step, which coincides with the execution of a right Boang Sau (70B). Step the left foot to the left on the Semicircle and turn in to face the Dummy (70C) with a simultaneous left Slap Block to the outer left Dummy arm and right index-knuckle “Phoenix-Eye” Punch at eye-level. As these two moves are being applied, the right foot circles to stomp the Dummy leg (70D). Step down and execute Gahng/Jom Sau with an inward pivot of both feet (70E).



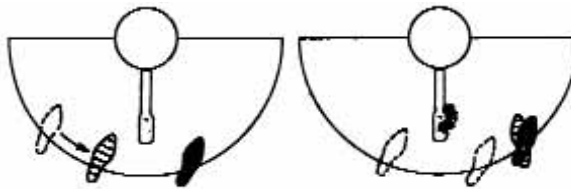
Wooden Dummy Form (Part II)



68A

68B

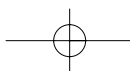
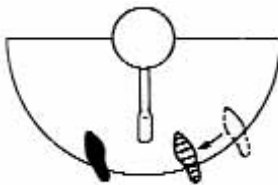
69

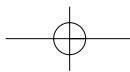


70A

70B

70C





### Close Range Combat Wing Chun: Volume Three

---

**Movement 71**—Toh Ma Boang Sau, Pock Da Foong Ngon Kuen Kup Yai Sut, Syeung Ma Gahng/Jom Sau: [59A, 70C, 70D].

**Movement 72**—Loy Seen Wai Loy Kwun Sau, Choh Ma Jut Da Chahng Jyeung: Without losing Bridge Contact with right hand, step the left foot to the left on the Semicircle and execute an Inward Rolling Arms Block as the right foot slides in to recover the original stance width and both feet pivot to the right (72A). At the completion of the motion, the thumb and index finger of the right hand should be pinched together and the last three fingers should be closed and pulled back toward the body. This hand formation hooks the Dummy arm with a trapping effect. When applied on a live opponent, the Huen Sau motion snags his wrist and hand using the last three fingers, rather than just scooping outward and allowing him to “run the hand” outside the block. Then, without losing Bridge Contact with the left hand, partially pivot the stance to the left as the Jom Sau becomes Loy Jut Sau, and shoot the right hand between both Dummy arms to a throat-level “Spade Palm” thrust (72B). At the completion of motion, the left elbow is down, the left palm is flat on the left Dummy arm and the fingers of the right hand are angled 45° upward.

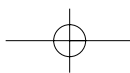
**Movement 73**—Choh Ma Loy Kwun Sau, Choh Ma Jut Da Chahng Dai Jyeung: Without losing Bridge Contact with left hand, slightly pivot the stance the rest of the way to the left and simultaneously circle the left hand clockwise to Huen Sau position as the right hand moves backward to Jom Sau position (73A) with *Jut Ging* (Jerking Energy).

Without losing Bridge Contact with the right hand, partially pivot the stance to the right, convert the right Jom Sau into Loy Jut Sau and snake the left hand inward to a low “Spade Palm” thrust (73B).

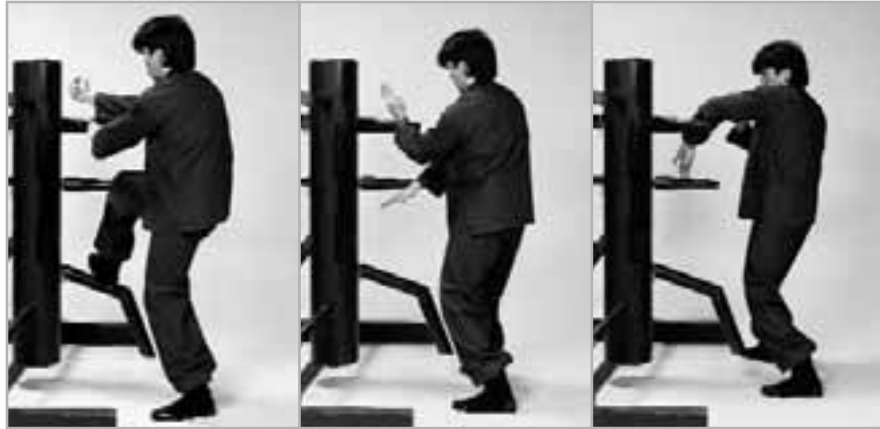
**Movement 74**—Choh Ma Loy Kwun Sau, Choh Ma Jut Da Chahng Dai Jyeung: Without losing Bridge Contact with the right hand, finish the right stance pivot and execute an Inward Rolling Arms block, circling the right hand counter-clockwise over the top of the right Dummy arm to Huen Sau position as the left arm thrusts up and forward from the low strike to the Chop Block (74A). Without losing Bridge Contact with the left Jom, partially pivot the stance to the left as the left hand becomes Loy Jut Sau and the right hand snakes inward and downward to strike with Chahng Dai Jyeung (74B).

**Movement 75**—Choh Ma Loy Kwun Sau, Choh Ma Jut Da Chahng Jyeung: [73A, 72B]. Jing Ma Syeung Loy Jut Sau: (20C).

Syeung Pau Sau: [20D].



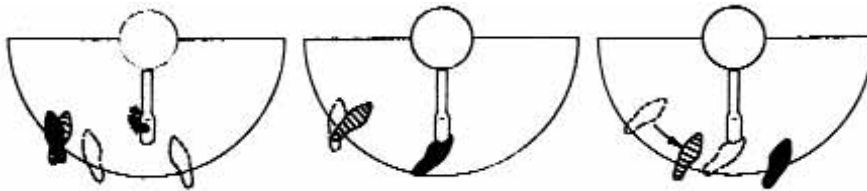
Wooden Dummy Form (Part II)



70D

70E

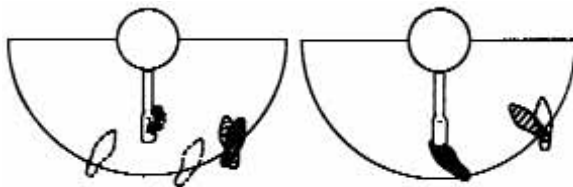
71A

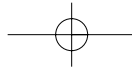


71B

71C

71D





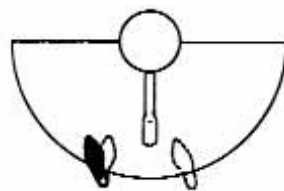
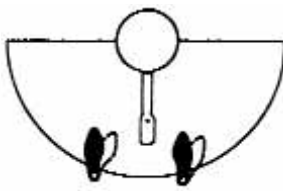
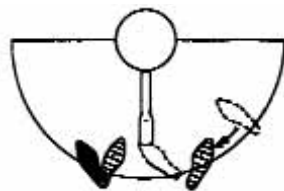
Close Range Combat Wing Chun: Volume Three



72A

72B

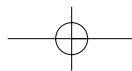
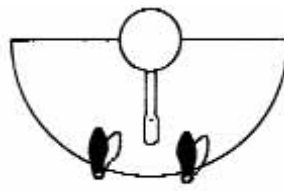
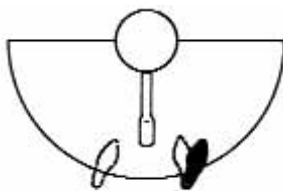
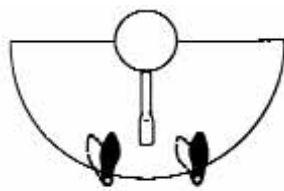
73A



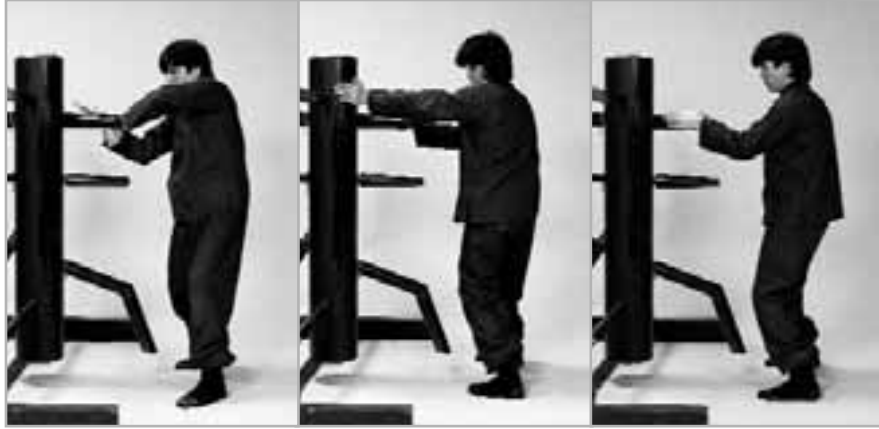
73B

74A

74B



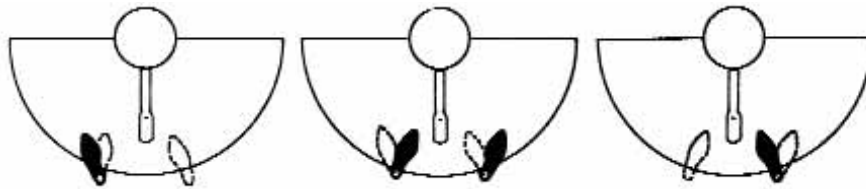
Wooden Dummy Form (Part II)



75A

75B

75C



75D

## Close Range Combat Wing Chun: Volume Three

---

### Ninth Set

*Movement 76*—Choh Ma Dai Boang Sau, Gyeung Jee Kuen, Chuen Ging Jing Jyeung (Stance Pivot/Wing Arm Deflection “Ginger” Fist, “Inch-power” Vertical Palm Strike): Pivot the stance to the left, drilling the right hand downward to low Boang Sau position and raising the left hand to Woo Sau position (76A). At the completion of the motion, the right elbow should be closer to the Dummy than the right wrist, and the outside right forearm should be in contact with the low Dummy arm after having rotated counter-clockwise on its way down, starting from the inner wrist and twisting inward as it descended. Repeat this motion with a right stance pivot/left Dai Boang Sau (76B) and again with a left pivot/right Boang Sau (76C). Using an inside whip of the right forearm, circle the right half-formed fist toward the body and then between the Dummy arms in a motion that resembles a backfist (76D). At the completion of the motion, the right hand should in “Ginger Fist” position with the thumb bracing the right index knuckle and the outer right forearm in contact with inner right Dummy arm. The right palm should be turned toward the trainee. Without retracting the hand or elbow, open the right hand as it rotates to face the Dummy and travels inward to strike vertically on the Original Centerline with “Inch Power” derived from the elbow (76E). The right thumb should be tucked to avoid injury and to prepare the palm for contact while helping to focus the Chi at the palm-heel. The right elbow should be fully extended.

*Movement 77*—Choh Ma Dai Boang Sau, Gyeung Jee Kuen, Chuen Ging Jing Jyeung: [76].

*Movement 78*—Choh Ma Dai Boang Sau: [76A].



Wooden Dummy Form (Part II)

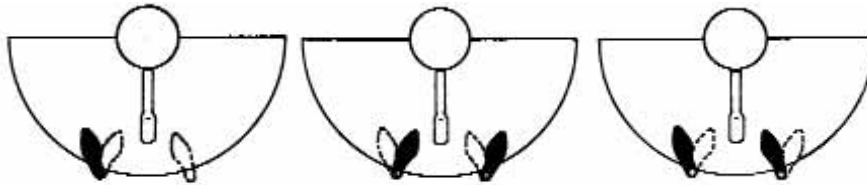


Ninth Set

76A

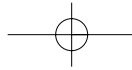
76B

76C



76D

76E



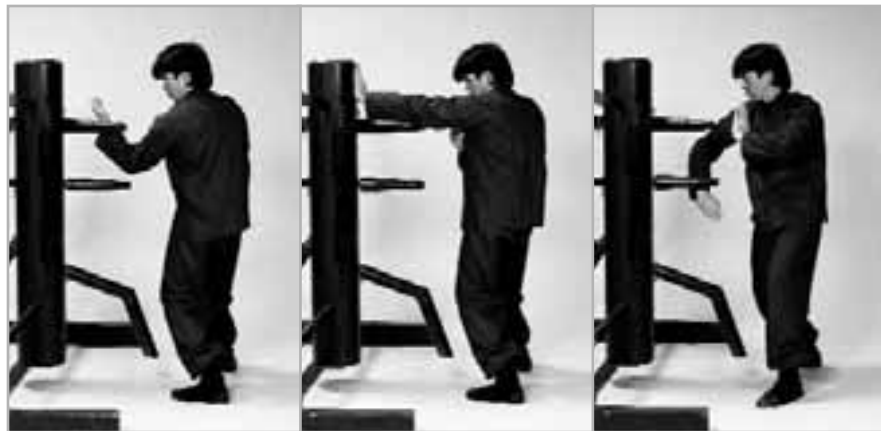
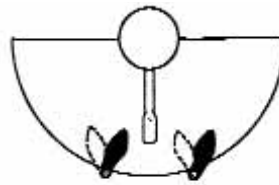
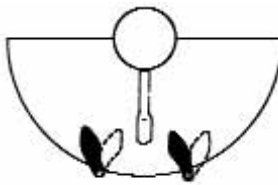
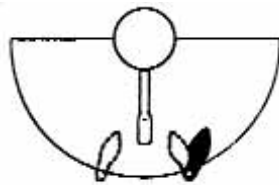
Close Range Combat Wing Chun: Volume Three



77A

77B

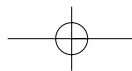
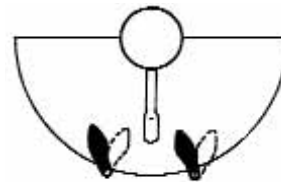
77C



77D

77E

78



## Wooden Dummy Form (Part II)

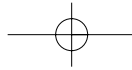
---

**Movement 79**—Juen Bock Gum Jyeung (Turning Shoulder Block/Low Palm-Down Palm Edge Thrust): Without moving the stance, sharply pivot the shoulders to power a simultaneous right downward/forward palm-down, palm-edge strike and Inward Shoulder Block that slams the outside right Dummy arm with the lower front face of the right shoulder. At the completion of the motion, the right palm heel should be on the Centerline, striking the Dummy just above the low Dummy arm.

**Movement 80**—Tan/Pock Sau/Tan Sut, Woo Sau/Jut Gyeuk, Syeung Lop Tai Sut, Syeung Ma Dai Boang Sau (Palm-up Slap Block/Outward Knee Block, Protective Hand/Jerking Leg, Double Grab/Raising Knee Strike, Stepdown/Low Wing Arm Deflection): Step the left foot to the left on the Semicircle and pivot inward to face the Dummy with a simultaneous right Tan Sau and left Pock Sau which are both directed to the outside left Dummy arm. As the hands make contact, bring the right leg up to strike the outside left low Dummy arm with the outside lower knee (80A). At the completion of the motion the lower right leg should be angled at 45° in relation to the floor with the foot tucked in Woo Gyeuk structure to avoid hitting the Dummy trunk. The base leg should remain bent in Dook Lop Ma structure. Next, pulling the left hand back to Woo Sau position but not losing Bridge Contact with the right hand, which also snaps into Woo Sau structure, pivot slightly outward with the left foot and bring the right leg sharply down to the inside left calf area of the Dummy leg (80B). At the completion of the motion, both hands are on the Centerline, and the right leg makes contact with the Dummy leg calf-to-calf in a downward rubbing motion supported by a slightly deeper bend of the base leg knee. Pivoting the base foot back inward, convert the right Woo Sau to a thumbless grab as the left Woo Sau retraps the same left Dummy arm and the right knee raises to an Upward Knee Strike to the low Dummy arm (80C). Step down into a left low Wing Arm Deflection that returns the stance to the Original Centerline with a sliding step of the left foot (80D).

**Movement 81**—Juen Bock Gum Jyeung: [79].

**Movement 82**—Tan/Pock Sau Tan Sut, Woo Sau Jut Gyeuk, Syeung Lop Sau/Tai Sut, Syeung Ma Gahng/Jom Sau: [80A-C, 36E].



Close Range Combat Wing Chun: Volume Three

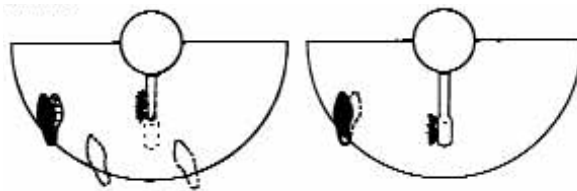


79

80A

80B

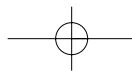
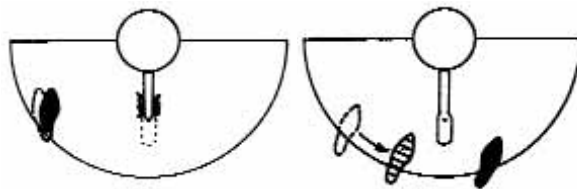
COMPARISON



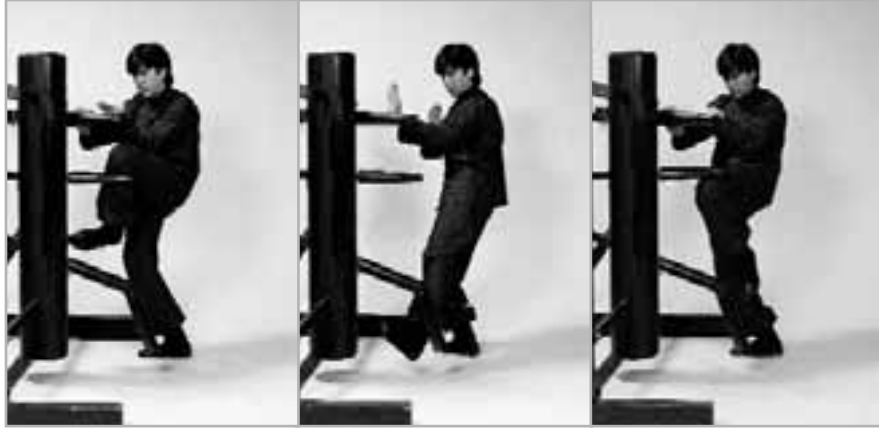
80C

80D

81



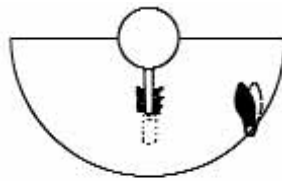
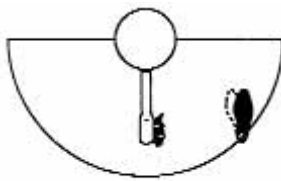
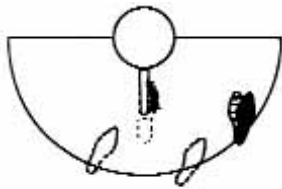
Wooden Dummy Form (Part II)



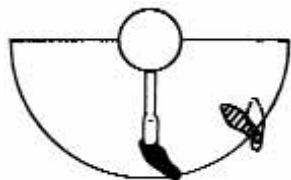
82A

82B

82C



82D



### Close Range Combat Wing Chun: Volume Three

---

**Movement 83**—Toh Ma Ngoy Kwun Sau, Ngoy Moon Pock Da Chuo Kuen (Step/Slide/Outward Rolling Arms Block, Outside Gate Slap Block/Hammer Fist): Step the left foot to the left on the Semicircle and execute an Outward Rolling Arms block that makes contact with the Dummy arms as the right sliding step returns the stance to the Original Centerline (83A). Without moving the stance, simultaneously slap the inside right Dummy arm with the left palm and shoot the right bottom fist downward to strike just under the low Dummy Arm (83B). At the completion of the motion, the structure of the left Pock hand is altered slightly with the hand twisted 45° outward to prevent the wrist, elbow and shoulder from tensing up, and the right thumb braces the inside of the index knuckle to support the Chuo Kuen from the top, directly opposite its striking surface.

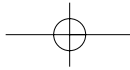
**Movement 84**—Jau Wai Huen Da Fun Sau Kup Yai Sut, Syeung Ma Jeep Sau (Step to a New Line/Circling Hand/Outward Horizontal Chop/Knee Attack, Stepdown/Bridge-catching Hand): Step the left foot to the left on the Semicircle and reach the right hand over both upper Dummy arms (84A) to become a Hooking Trap on the outside left Dummy arm. As the hooking motion is completed, use the right elbow to pull the stance around to face the left side of the Dummy and execute a simultaneous left Outward Horizontal Chop to the midsection/right Front Kick to the knee (84B). Step down to a point just past the Dummy leg and circle the right hand into an Inside Jerk on the same left Dummy arm as the left hand raises to press upward and forward in Pau Sau structure with a sliding step of the left foot (84C). At the completion of the motion, the right hand pulls the left Dummy arm backward and the left hand pushes it forward with counterpressure designed to simulate a Jeep Sau armlock or break.

**Movement 85**—Choh Ma Kau Da Joong Loh Kuen, Choh Ma Gahng/Jom Sau (Stance Pivot/Midsection Punch, Stance Pivot/Low Sweep/High Chop Block): Without losing Bridge Contact with the left hand, pivot the stance to the left and execute a simultaneous left Kau Sau inward-pulling thumbless grab and a right palm-up Drilling Punch to the midsection (85A). At the completion of the motion, the left elbow is in Origin Position and the right fist is angled 45° in relation to the floor. Pivot the stance to the right with Gahng/Jom Sau covering the entire Centerline (85B).

**Movement 86**—Toh Ma Ngoy Kwun Sau, Ngoy Moon Pock Da Chuo Kuen: [83].

**Movement 87**—Huen Da Fun Sau Kup Yai Sut, Syeung Ma Jeep Sau: [84].

**Movement 88**—Choh Ma Kau Da Joong Loh Kuen, Choh Ma Gahng/Jom Sau: [85].



Wooden Dummy Form (Part II)

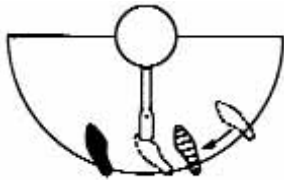
*Movement 89*—Loy Seen Wai Loy Kwun Sau, Choh Ma Jut Da Jing Jyeung: [10A, 10B].  
Jing Ma Syeung Loy Jut Sau, Syeung Pau Sau: [10C, 10D].



83A

83B

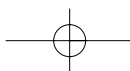
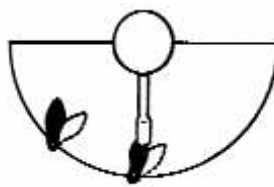
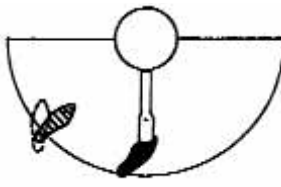
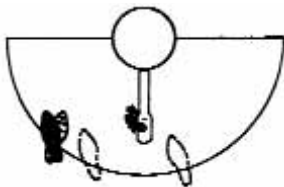
84A

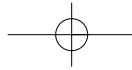


84B

84C

85A





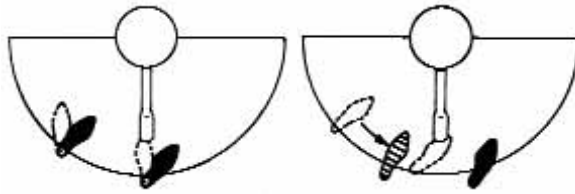
Close Range Combat Wing Chun: Volume Three



85B

86A

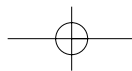
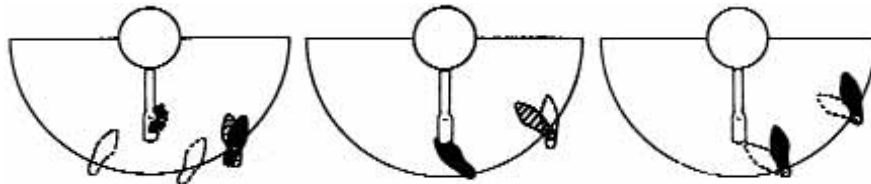
86B



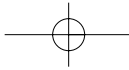
87A

87B

88A







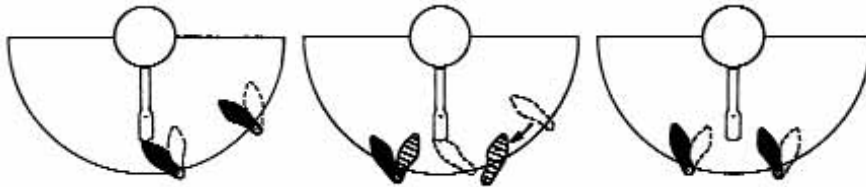
Wooden Dummy Form (Part II)



88B

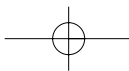
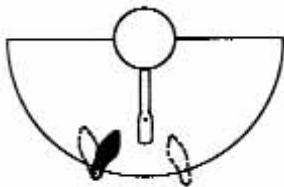
89A

89B



89C

89D



## Close Range Combat Wing Chun: Volume Three

---

### Tenth Set

**Movement 90**—Choh Ma Boang Sau, Gum Jahng Soh Gyeuk (Stance Pivot/Wing Arm Deflection, Arm Bar/Sweep Kick): Circling the right arm down and around the outside of the right Dummy arm, pivot the stance to the left and execute a right Boang Sau to the inside left Dummy arm, threading between both Dummy arms from above the right one (90A). Without losing Bridge Contact with the right arm, step the left foot to the left on the Semicircle and convert the right hand to a thumbless Lop Sau grab as the left palm presses inward on the outside left Dummy arm and the right foot Sweep Kicks the shin area of the Dummy leg (90B). The striking surface is the inner arch and bottom of the right foot.

**Movement 91**—Bai Ying Lon Joang Sau Loy Ngau Gyeuk, Wui Ying Pock Da Loy Doy Gock Kuen (Losing Balance Horizontal Guarding Hand/Inside Hooking Foot, Regaining Balance/Slap Block/Inside Diagonal Punch): Without losing Bridge Contact with the right foot, pivot the base foot and slip the toes around to hook the outer right knee area of the Dummy leg with the right instep. Lean to the left and bring the right arm to Lon Sau position to guard the Centerline with a closed fist. The rear left hand retracts to Woo Sau position with the palm on the Centerline facing the inner left forearm (91A). At the completion of the motion, the upper body and right leg are aligned with a 45° angle lean. The Lon Sau forearm is held horizontally at rib level and the right leg is fully extended in Wahng Gyeuk structure. Using the right foot to snap the body back to good balance and structure, step down to a position near but not past the Dummy leg to face the Dummy as the left hand executes a Slap Block to the outer left Dummy arm followed by an Inward Diagonal Punch to the midsection with the right fist angled 45° upward (91B). This punch coincides with a sliding step of the left foot that recovers the original stance width and adds power to the strike. At the completion of the motion, both elbows are in Origin Position, the left to protect the ribs and the right to keep the elbow directly behind the fist as it pistons the punch down the Centerline.

**Movement 92**—Toh Ma Ngoy Moon Pock Da Chop Kuen (Step/Slide/Outside Gate Slap Block/Low Horizontal Fist): Step the right foot to the right on the Semicircle and execute a right inward Slap Block to the inside left Dummy arm with the right elbow in Origin Position. As the left foot slides in to recover the original stance width on the Original Centerline, the left hand punches past the low Dummy arm and the left arm rubs against that arm in an excluding low punch based on the *Tuet Sau Chop Kuen* of the Biu Jee form. At the completion of the motion, the left forearm should be in contact with the low Dummy arm and the left

Wooden Dummy Form (Part II)

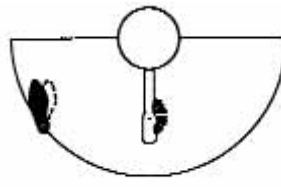
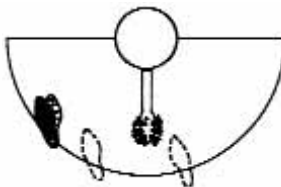
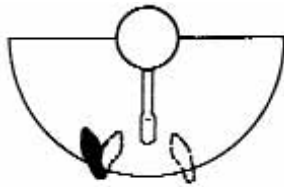


Tenth Set

90A

90B

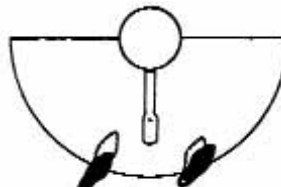
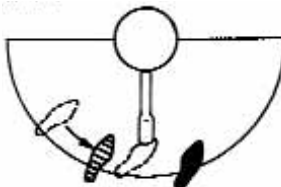
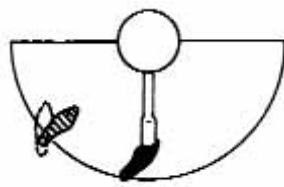
91A

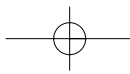


91B

92

93A





### Close Range Combat Wing Chun: Volume Three

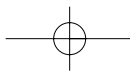
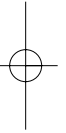
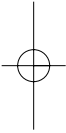
---

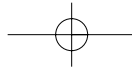
fist is angled 45° downward. The right Pock Sau is angled 45° upward to keep the arm and chest relaxed.

**Movement 93**—Hau Chong Ma Boang Sau, Gum Jahng Soh Gyeuk (Backward Stance Brace/Wing Arm Deflection, Arm Bar/Sweep Kick): In a motion that formally introduces *Chong Ma* footwork, step the left foot directly backward to a Back-Braced position and pivot a bit more to the right with a left Boang Sau and right Woo Sau (93A). Without losing Bridge Contact with the left arm, step the right foot to the right on the Semicircle, converting the right hand to Lop Sau with a simultaneous forward/downward press of the right palm or the outside right Dummy arm simulating an armlock, lever or break as the inner arch and bottom of the left foot kicks the front shin area of the Dummy leg (93B).

**Movement 94**—Bai Ying Lon Joang Sau Loy Ngau Gyeuk, Wui Ying Pock Da Loy Doy Gock Kuen: [91].

**Movement 95**—Toh Ma Ngoy Moon Pock Da Chop Kuen: [92].  
Jing Ma Syeung Loy Jut Sau, Syeung Pau Sau: [10C, 10D].





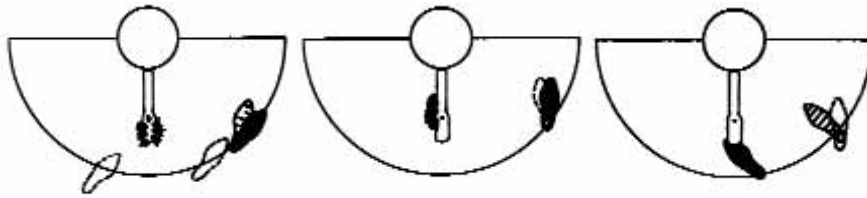
Wooden Dummy Form (Part II)



93B

94A

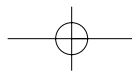
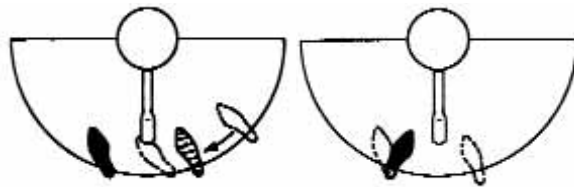
94B



95A

95B

95C



## Close Range Combat Wing Chun: Volume Three

---

### Eleventh Set

*Movement 96*—Choh Ma Tan Da, Choh Ma Poh Joong Kuen (Stance Pivot/Palm-Up Block/Including Punch, Stance Pivot Inside Jerk/Center-Breaking Punch): Snapping the left wrist downward and inward (96A), pivot the stance to the left and circle the left forearm in an inside whipping motion that spins the left hand into Tan Sau position on the inner left Dummy arm as the right forearm circles outside the right Dummy arm in an outside whipping motion with the right elbow as a pivotal point (96B). At the completion of the motion, the sharply bent wrist and back of the left Tan Sau hand should be in contact with the inside left Dummy arm and the right forearm should be in contact with the outside right Dummy arm in an “including” motion. Without losing Bridge Contact with the right arm, partially pivot the stance to the right as the right hand pulls downward and inward, converting to Loy Jut Sau, and the left hand punches on the Centerline between the two upper Dummy arms in an “excluding” motion (96C).

*Movement 97*—Choh Ma Tan Da, Choh Ma Poh Joong Kuen: Partially pivot the stance to the right and snap the right wrist downward and inward, circling the forearm in an inside-whipping motion that spins the right hand into Tan Sau position on the inner right Dummy arm as the left forearm circles outside the left Dummy arm in an outside-whipping motion that uses the left elbow as a pivotal point (97A). At the completion of the motion, the sharply bent wrist and back of the right Tan Sau hand should be in contact with the inside right Dummy arm and the left forearm should be in contact with the outside left Dummy arm in an “including” motion. Without losing Bridge Contact with the left arm, partially pivot the stance to the left as the left hand pulls downward and inward, converting to Loy Jut Sau with the right hand punching on the Centerline between the two upper Dummy arms (97B).

Wooden Dummy Form (Part II)

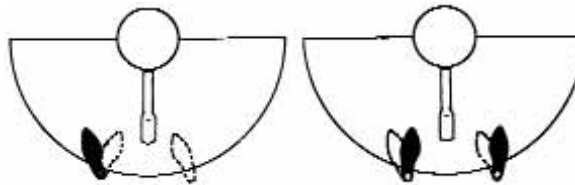


Eleventh Set

96A

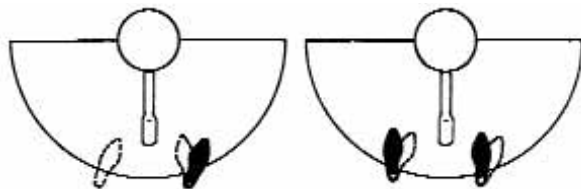
96B

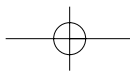
96C



97A

97B





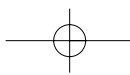
### Close Range Combat Wing Chun: Volume Three

---

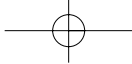
*Movement 98*—Choh Ma Gahng Da, Choh Ma Poh Joong Kuen (Stance Pivot/Low Sweep Block/Including Punch, Stance Pivot/Center-Breaking Punch): Begin pivoting the stance further to the left as the left wrist snaps inward and begins to circle inward and forward down to Gahng Sau position. As the stance continues to pivot, the right fist retracts and circles around the outside of the right Dummy arm in an outside-whipping motion to execute an “including” punch on the outside right Dummy arm in time with the completion of the left pivot (98A). Without losing Bridge Contact with the right hand, partially pivot the stance to the right and execute a simultaneous right Inside Jerk/left mid-level Drilling Punch (98B).

*Movement 99*—Choh Ma Gahng Da, Choh Ma Poh Joong Kuen: Pivot the stance the rest of the way to the right, circling the right arm inward and downward to Gahng Sau position as the left hand punches with an outside-whipping motion. This including punch makes contact with the inner left forearm on the outside left Dummy arm (99A). Without losing Bridge Contact with the left arm, pivot the stance to the left as the left hand turns over and pulls inward to Loy Jut Sau and the right hand punches to the midsection with a palm-up Drilling Punch (99B).

Jing Ma Syeung Loy Jut Sau, Syeung Pau Sau: [10C, 10D].







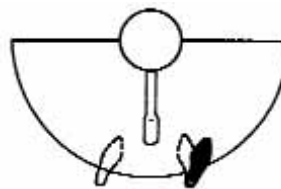
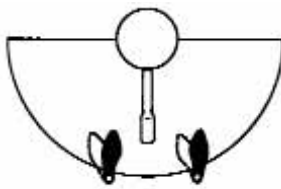
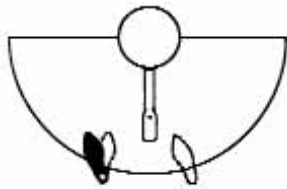
Wooden Dummy Form (Part II)



98A

98B

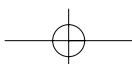
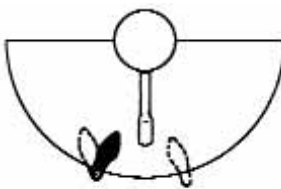
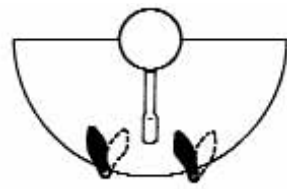
99A

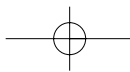


99B

99C

99D





## Close Range Combat Wing Chun: Volume Three

---

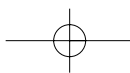
### Twelfth Set

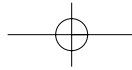
**Movement 100**—Syeung Ma Dai Boang Sau (Advancing Stance/Low Wing Arm Deflection): Step the left foot forward off the Semicircle to the left of the Dummy leg and pivot inward with a downward twisting low left Boang Sau to the outside low Dummy Arm. During this motion, the right hand raises to Woo Sau position.

**Movement 101**—Biu Joang Sau/Dung Jing Gyeuk (Thumb-up Thrusting Hand/Lifting Front Kick): Slide the left foot back until it is heel-to-heel with the right foot (101A). Thrust the left forearm into the inside left Dummy arm with a counter-clockwise twist of the forearm that leaves the left palm angled 45° upward at full extension of the arm. As the left arm thrusts forward, the right Woo Sau follows it, staying close to the left elbow, and the right heel shoots directly to the Centerline in a straight lifting motion to stamp kick the Dummy trunk (101B). At the completion of the motion, both hands are on the Centerline at the upper level and the right heel is on that same line at low-level.

**Movement 102**—Pock Sau Fook Sut, Tan Sau Boang Gyeuk, Boang Sau Chai Wahng Gyeuk, Syeung Ma Joang Sau (Slap Block/Inward Knee Block, Palm-Up Block/Wing Leg, Wing Arm Deflection/Sidekick, Stepdown/Extended Lead Guarding Hand): Without putting the foot down, pivot the left foot slightly outward and whip the right knee inward and downward to contact the low Dummy arm from above right. Simultaneously execute an inward right Slap Block to the inside left Dummy Arm and retract the left hand to Woo Sau position (102A). Without putting the foot down or losing Bridge Contact with the right leg, pivot the left foot back inward and whip the right shin inward, forward and upward in a multi-directional Wing Leg Deflection as the right hand flips to Tan Sau position, making contact with the inside right Dummy arm at the outer wrist (102B).

Still without putting the foot down, pivot the left foot back outward, twisting the right foot counter-clockwise (102C) as it screws down to contact the shin area of the Dummy leg with the knife edge of the foot and continues to scrape downward with a simultaneous right Boang Sau serving as a Joang Sau Guarding Hand and moving downward as the kick scrapes down the Dummy leg (102D). On completing that scraping motion, step the right foot backward and to the right (102E) as the left foot steps forward to the left on the Semicircle (102F). The stance then pivots to the right to face the Original Centerline with the left hand circling downward to Joang Sau position and the right hand circling under the left and up to Woo Sau as the right foot slides slightly inward to recover the original stance width (102G).





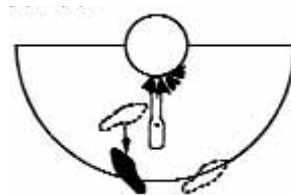
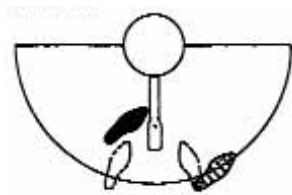
Wooden Dummy Form (Part II)



Twelfth Set 100

101A

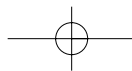
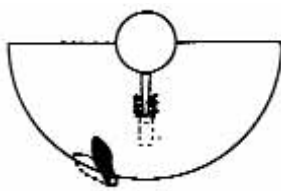
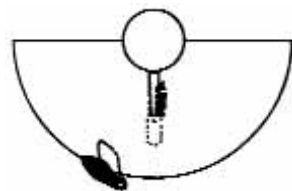
101B

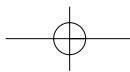


102A

102B

102C





### Close Range Combat Wing Chun: Volume Three

---

*Movement 103*—Syeung Ma Dai Boang Sau: [100].

*Movement 104*—Biu Joang Sau/Dung Jing Gyeuk: [101].

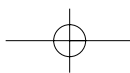
*Movement 105*—Pock Sau Fook Sut, Tan Sau Boang Gyeuk, Boang Sau Chai Wahng Gyeuk, Syeung Ma Joang Sau: [102].

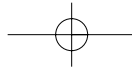
*Movement 106*—Syeung Loy Jut Sau Jing Gyeuk, Syeung Pau Sau Chai Sut Dai Gyeuk (Double Inside Jerking Hand/Front Kick, Double Lifting Hand/Knee-Stomping Low Kick): Slide the left foot to the right and circle both hands outside the two upper Dummy arms (106A). Simultaneously bring both elbows inward and downward to pull both Inside Jerking Hands in as the right heel shoots straight to stamp kick the Dummy trunk on the Centerline between the low Dummy arm and Dummy leg (106B). The Double Jut Sau motion should pull the trainee into the kick.

Without putting the foot down, simultaneously lift both upper Dummy arms a forward-energy Double Pau Jyeung and, in a splitting motion, bring the right foot down to stomp the upper knee joint of the Dummy leg with the heel (106C).

*Movement 107*—Syeung Loy Jut Sau Jing Gyeuk, Syeung Pau Sau Chai Sut Dai Gyeuk: Put the right foot down next to the left (107A) and circle both hands outside the upper Dummy arms (107B) as the left foot begins to raise for a stamping kick on the Centerline that makes contact just as both wrists are snapped inward on the outsides of the Dummy arms (107C). Next, circle both hands downward and forward into Double Lifting Palm position, simultaneously stomping the knee area of the Dummy leg with the left heel (107D).

*Movement 108*—Sau Sick (Closing Stance sequence): Put the left foot down next to the right and bring both hands up to chest level with the palms down (108A, 108B). Bring the palms down to the sides of the body and exhale (108C). This concludes the Mook Yan Joang form.





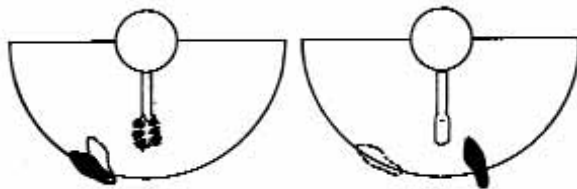
Wooden Dummy Form (Part II)



102D

102E

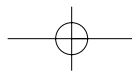
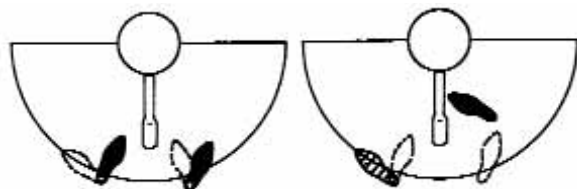
102F

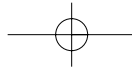


102G

103

104A





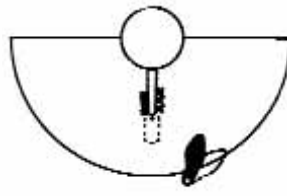
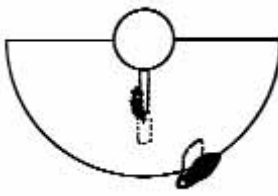
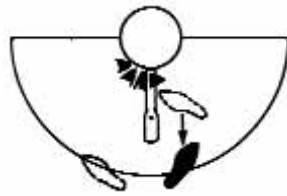
Close Range Combat Wing Chun: Volume Three



104B

105A

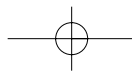
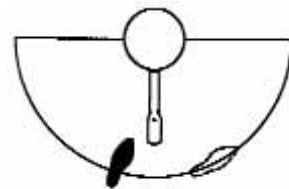
105B



105C

105D

105E



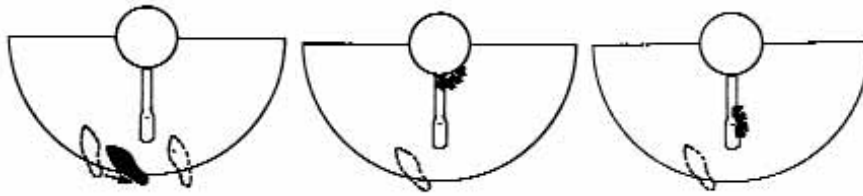
Wooden Dummy Form (Part II)



106A

106B

106C

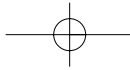


107A

107B

107C





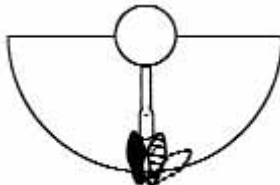
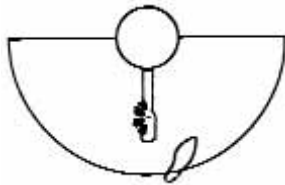
Close Range Combat Wing Chun: Volume Three



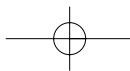
107D

108A

108B



108C





# MOOK YAN JOANG FOT YUT LING BOT FORM SEQUENCE

## PART I

HOY SICK—“YEE” JEE KEEM YEUNG MA  
INSIDE OF HANDS CHECK DISTANCE—EYE LEVEL  
SYEUNG JOM SAU  
SAU KUEN

HOY MA

- 1) (L) JOANG SAU / (R) WOO SAU, (L) BIU JOANG SAU
- 2) (L) CHOH MA (L) LOP SAU (R) CHAHNG GENG
- 3) (R) SAU JAHNG
- 4) (L) CHOH MA (R) BOANG SAU / (L) WOO SAU
- 5) (R) SEEP MA (R) TAN DA (L) CHAHNG DAI JYEUNG
- 6) (R) TOY MA GAHNG/JOM SAU
- 7) (R) TOH MA NGOY KWUN SAU
- 8) (L) SEEP MA (L) TAN DA (R) CHAHNG DAI JYEUNG
- 9) (L) TOY MA GAHNG/JOM SAU
- 10) (R) LOY SEEN WAI LOY KWUN SAU, (L) CHOH MA (L) JUT DA  
(R) JING JYEUNG  
(R) JING MA SYEUNG LOY JUT SAU, SYEUNG PAU SAU
- 11) (R) JOANG SAU / (L) WOO SAU, (R) BIU JOANG SAU
- 12) (R) CHOH MA (R) LOP SAU (L) CHAHNG GENG
- 13) (L) CHUM JAHNG
- 14) (R) CHOH MA (L) BOANG SAU / (R) WOO SAU
- 15) (L) SEEP MA (L) TAN DA (R) CHAHNG DAI JYEUNG
- 16) (L) TOY MA GAHNG/JOM SAU
- 17) (L) TOH MA NGOY KWUN SAU
- 18) (R) SEEP MA (R) TAN DA (L) DAI CHAHNG JYEUNG
- 19) (R) TOY MA GAHNG/JOM SAU
- 20) (L) LOY SEEN WAI LOY KWUN SAU, (R) CHOH MA (R) JUT DA  
(L) CHAHNG DAI JYEUNG  
(L) JING MA SYEUNG LOY JUT SAU, SYEUNG PAU SAU
- 21) (L) CHOH MA (R) LOY MOON POCK SAU / (L) WOO SAU,  
(R) CHOH MA (L) LOY MOON POCK SAU / (R) WOO SAU,  
(L) CHOH MA (R) LOY MOON POCK SAU / (L) WOO SAU
- 22) (R) CHOH MA (L) KAU SAU / (R) WOO SAU, (L) FUN SAU
- 23) (L) CHOH MA (JING MA) POH JOONG KUEN
- 24) (L) CHOH MA (R) KAU SAU / (L) WOO SAU, (R) FUN SAU

**Close Range Combat Wing Chun: Volume Three**

---

- 25) (R) CHOH MA (JING MA) POH JOONG KUEN  
(L) JING MA SYEUNG LOY JUT SAU, SYEUNG PAU SAU
- 26) (L) CHOH MA (R) DAI BOANG SAU / (L) WOO SAU
- 27) (L) TOH MA / (L) NGOY MOON POCK DA CHUO KUEN (R)  
FUN SAU
- 28) (R) BOANG SAU / (L) WOO SAU / FON SUN (R) DENG JING  
GYEUK, (R) SYEUNG MA (L) DAI BOANG SAU / (R) WOO SAU
- 29) (R) TOH MA / (R) NGOY MOON POCK DA CHUO KUEN (L)  
WAHNG JYEUNG
- 30) (L) BOANG SAU / (R) WOO SAU / FON SUN (L) HUEN JING  
GYEUK, (L) SYEUNG MA GAHNG/JOM SAU
- 31) (R) LOY SEEN WAI LOY KWUN SAU
- 32) (L) JING MA KWOK SAU, SYEUNG CHAHNG DAI JYEUNG,  
SYEUNG CHAHNG JYEUNG, SYEUNG CHUM SAU, SYEUNG  
PAU SAU
- 33) (R) CHOH MA LOY KWUN SAU, (L) CHOH MA LOY KWUN  
SAU, (R) CHOH MA LOY KWUN SAU, (L) CHOH MA (L) JUT DA  
(R) JING JYEUNG  
(R) JING MA SYEUNG LOY JUT SAU, SYEUNG PAU SAU
- 34) (L) CHOH MA (R) BOANG SAU / (L) WOO SAU, (L) JAU WAI  
(R) TAN DA (L) CHAHNG DAI JYEUNG / (R) YAI SUT,  
(R) SYEUNG MA GAHNG/JOM SAU
- 35) (L) LOY SEEN WAI LOY KWUN SAU, (R) CHOH MA LOY  
KWUN SAU, (L) CHOH MA LOY KWUN SAU, (R) CHOH MA  
(R) JUT DA (L) CHAHNG DAI JYEUNG  
(L) JING MA SYEUNG LOY JUT SAU, SYEUNG PAU SAU
- 36) (R) CHOH MA (L) BOANG SAU / (R) WOO SAU, (R) JAU WAI  
(L) TAN DA (R) CHAHNG DAI JYEUNG / (L) YAI SUT DAI  
GYEUK, (L) SYEUNG MA GAHNG/JOM SAU
- 37) (R) LOY SEEN WAI LOY KWUN SAU, (L) CHOH MA (L) JUT DA  
(R) JING JYEUNG  
(R) JING MA SYEUNG LOY JUT SAU, SYEUNG PAU SAU
- 38) (R) HUEN FOOK SAU, LOY JUT SAU, BIU SAU
- 39) (L) CHOH MA / (R) JOM SAU, (R) LOY SEEN WAI (R) HUEN DA  
(L) CHAHNG DAI JYEUNG
- 40) (R) TOH MA NGOY KWUN SAU, (L) JING MA [(R) TOP] POH  
PAI JYEUNG
- 41) (R) CHOH MA (L) BOANG SAU / (R) WOO SAU, (L) SEEP MA  
[(R) TOP] POH PAI JYEUNG, (L) TOY MA GAHNG/JOM SAU
- 42) (R) JING MA [(R) TOP] POH PAI JYEUNG
- 43) (L) CHOH MA (R) BOANG SAU / (L) WOO SAU, (R) SEEP MA  
[(R) TOP] POH PAI JYEUNG, (R) TOY MA GAHNG/JOM SAU

Mook Yan Joang Fot Yut Ling Bot Form Sequence

---

- 44) (L) LOY SEEN WAI LOY KWUN SAU, (R) CHOH MA (R) JUT DA  
(L) CHAHNG DAI JYEUNG  
(L) JING MA SYEUNG LOY JUT SAU, SYEUNG PAU SAU
- 45) (L) HUEN FOOK SAU, JUT SAU, BIU SAU
- 46) (R) CHOH MA / (L) JOM SAU, (L) LOY SEEN WAI (L) HUEN DA  
(R) CHAHNG DAI JYEUNG
- 47) (L) TOH MA NGOY KWUN SAU, (R) JING MA [(L) TOP] POH  
PAI JYEUNG
- 48) (L) CHOH MA (R) BOANG SAU / (L) WOO SAU, (R) SEEP MA  
[(L) TOP] POH PAI JYEUNG, (R) TOY MA GAHNG/JOM SAU
- 49) (L) JING MA [(L) TOP] POH PAI JYEUNG
- 50) (R) CHOH MA (L) BOANG SAU / (R) WOO SAU, (L) SEEP MA  
[(L) TOP] POH PAI JYEUNG, (L) TOY MA GAHNG/JOM SAU
- 51) (R) LOY SEEN WAI LOY KWUN SAU, (L) CHOH MA (L) JUT DA  
(R) JING JYEUNG  
(R) JING MA SYEUNG LOY JUT SAU, SYEUNG PAU SAU
- 52) (R) CHOH MA GAHNG/JOM SAU, (L) CHOH MA GAHNG/JOM  
SAU, (R) CHOH MA GAHNG/JOM SAU
- 53) (L) CHOH MA (R) BOANG SAU / (L) WOO SAU, (R) LOY SEEN  
WAI (R) LOP SAU / (L) FUN SAU
- 54) (L) LOY SEEN WAI (L) JUT DA (R) CHAHNG GENG  
(R) JING MA SYEUNG LOY JUT SAU, SYEUNG PAU SAU
- 55) (L) CHOH MA GAHNG/JOM SAU, (R) CHOH MA GAHNG/JOM  
SAU, (L) CHOH MA GAHNG/JOM SAU
- 56) (R) CHOH MA (L) BOANG SAU / (R) WOO SAU, (L) LOY SEEN  
WAI (L) LOP SAU / (R) FUN SAU
- 57) (R) LOY SEEN WAI (R) JUT DA (L) CHAHNG GENG  
(L) JING MA SYEUNG LOY JUT SAU, SYEUNG PAU SAU
- 58) (L) CHOH MA (R) BOANG SAU / (L) WOO SAU, (R) TAN DA  
(L) CHAHNG DAI JYEUNG / (L) YAI HAU GYEUK, (R) SYEUNG  
MA GAHNG/JOM SAU
- 59) (R) TOH MA (L) BOANG SAU / (R) WOO SAU, (L) TAN DA (R)  
CHAHNG DAI JYEUNG / (R) YAI HAU GYEUK, (L) SYEUNG MA  
GAHNG/JOM SAU
- 60) (R) LOY SEEN WAI LOY KWUN SAU, (L) CHOH MA (L) JUT DA  
(R) JING JYEUNG  
(R) JING MA SYEUNG LOY JUT SAU, SYEUNG PAU SAU

SAU SICK (OPTIONAL)

**END OF PART I**

**Close Range Combat Wing Chun: Volume Three**

---

**PART II**

- 61) (L) CHOH MA (R) GUM SAU / (L) WOO SAU, (R) CHOH MA  
(L) GUM SAU / (R) WOO SAU, (L) CHOH MA (R) GUM SAU /  
(L) WOO SAU
- 62) (R) SEEP MA (L) POCK DA (R) DAI JYEUNG, (R) TOY MA  
(L) GUM SAU / (R) WOO SAU
- 63) (L) CHOH MA (R) GUM SAU / (L) WOO SAU, (R) CHOH MA  
(L) GUM SAU / (R) WOO SAU
- 64) (L) SEEP MA (R) POCK DA (L) JUCK JYEUNG, (L) TOY MA  
(R) GUM SAU / (L) WOO SAU
- 65) (L) POCK SAU / (R) WOO SAU / (R) CHAI SUT DAI GYEUK,  
(R) SYEUNG MA (L) GUM SAU / (R) WOO SAU
- 66) (R) POCK SAU / (L) WOO SAU / (R) YAI SUT DAI GYEUK,  
(L) SYEUNG MA (R) GUM SAU / (L) WOO SAU
- 67) (L) POCK SAU / (R) WOO SAU / (R) NGOY TIU GYEUK
- 68) BAI YING (R) JING NGAU GYEUK / (L) JOANG SAU / (R) WOO  
SAU, WUI YING (L) GUM SAU / (R) WOO SAU
- 69) (R) POCK SAU / (L) WOO SAU / (L) NGOY TIU GYEUK
- 70) BAI YING (L) JING NGAU GYEUK / (R) JOANG SAU /  
(L) WOO SAU, WUI YING (R) BOANG SAU, (L) POCK DA  
(R) FOONG NGON KUEN KUP (R) YAI SUT, (R) SYEUNG MA  
GAHNG/JOM SAU
- 71) (R) TOH MA (L) BOANG SAU / (R) WOO SAU, (R) POCK DA  
(L) FOONG NGON KUEN KUP (L) YAI SUT, (L) SYEUNG MA  
GAHNG/JOM SAU
- 72) (R) LOY SEEN WAI LOY KWUN SAU, (L) CHOH MA (L) JUT DA  
(R) CHAHNG JYEUNG
- 73) (L) CHOH MA LOY KWUN SAU, (R) CHOH MA (R) JUT DA  
(L) CHAHNG DAI JYEUNG
- 74) (R) CHOH MA LOY KWUN SAU, (L) CHOH MA (L) JUT DA  
(R) CHAHNG DAI JYEUNG
- 75) (L) CHOH MA LOY KWUN SAU, (R) CHOH MA (R) JUT DA  
(L) CHAHNG JYEUNG  
(L) JING MA SYEUNG LOY JUT SAU, SYEUNG PAU SAU
- 76) (L) CHOH MA (R) DAI BOANG SAU / (L) WOO SAU,  
(R) CHOH MA (L) DAI BOANG SAU / (R) WOO SAU,  
(L) CHOH MA (R) DAI BOANG SAU / (L) WOO SAU,  
(R) GYEUNG JEE KUEN, (R) CHUEN GING JING JYEUNG
- 77) (R) CHOH MA (L) DAI BOANG SAU / (R) WOO SAU,  
(L) CHOH MA (R) DAI BOANG SAU / (L) WOO SAU,  
(R) CHOH MA (L) DAI BOANG SAU / (R) WOO SAU,  
(L) GYEUNG JEE KUEN, (L) CHUEN GING JING JYEUNG

Mook Yan Joang Fot Yut Ling Bot Form Sequence

---

- 78) (L) CHOH MA (R) DAI BOANG SAU / (L) WOO SAU
- 79) (R) JUEN BOCK GUM JYEUNG
- 80) (R) TAN/POCK SAU / (R) TAN SUT, SYEUNG WOO SAU /  
(R) JUT GYEUK, SYEUNG LOP SAU / (R) TAI SUT, (R) SYEUNG  
MA (L) DAI BOANG SAU / (R) WOO SAU
- 81) (L) JUEN BOCK GUM JYEUNG
- 82) (L) TAN/POCK SAU / (L) TAN SUT, SYEUNG WOO SAU / (L) JUT  
GYEUK, SYEUNG LOP SAU / (L) HAY SUT, (L) SYEUNG MA  
GAHNG/JOM SAU
- 83) (L) CHOH MA NGOY KWUN SAU, (L) NGOY MOON POCK DA  
CHUO KUEN (R) CHUO KUEN
- 84) JAU WAI (R) HUEN DA (L) FUN SAU KUP (R) YAI SUT,  
(R) SYEUNG MA JEEP SAU
- 85) (L) CHOH MA (L) KAU DA (R) JOONG LOH JUEN KUEN,  
(R) CHOH MA GAHNG/JOM SAU
- 86) (R) TOH MA NGOY KWUN SAU, (R) NGOY MOON POCK DA  
CHUO KUEN (L) CHUO KUEN
- 87) JAU WAI (L) HUEN DA (R) FUN SAU KUP (L) YAI SUT,  
(L) SYEUNG MA JEEP SAU
- 88) (R) CHOH MA (R) KAU DA (L) JOONG LOH CHAU KUEN,  
(R) CHOH MA GAHNG/JOM SAU
- 89) (R) LOY SEEN WAI LOY KWUN SAU, (L) CHOH MA (L) JUT DA  
(R) JING JYEUNG  
(R) JING MA SYEUNG LOY JUT SAU, SYEUNG TOCK SAU
- 90) (L) CHOH MA (R) BOANG SAU / (L) WOO SAU, (L) GUM  
JAHNG / (R) SOH GYEUK
- 91) BAI YING (R) LOY NGAU GYEUK / (R) LON JOANG SAU /  
(L) WOO SAU, WUI YING (L) POCK DA (R) LOY DOY GOCK  
KUEN
- 92) (R) TOH MA (R) NGOY MOON POCK DA (L) CHOP KUEN
- 93) (R) HAU CHONG MA (L) BOANG SAU / (R) WOO SAU,  
(R) CHEH SAU / (L) SOH GYEUK 94) BAI YING (L) LOY NGAU  
GYEUK / (L) LON JOANG SAU / (R) WOO SAU, WUI YING  
(R) POCK DA (L) LOY DOY GOCK KUEN
- 95) (L) TOH MA (L) NGOY MOON POCK DA (R) CHOP KUEN  
(R) JING MA SYEUNG LOY JUT SAU, SYEUNG PAU SAU
- 96) (L) CHOH MA (L) TAN DA, (R) CHOH MA (L) GOH LOH POH  
JOONG KUEN
- 97) (R) CHOH MA (R) TAN DA, (L) CHOH MA (R) GOH LOH POH  
JOONG KUEN
- 98) (L) CHOH MA (L) GAHNG DA, (R) CHOH MA (L) JOONG LOH  
POH JOONG KUEN

**Close Range Combat Wing Chun: Volume Three**

---

- 99) (R) CHOH MA (R) GAHNG DA, (L) CHOH MA (R) JOONG LOH  
POH JOONG KUEN  
(R) JING MA SYEUNG LOY JUT SAU, SYEUNG PAU SAU
- 100) (R) SYEUNG MA (L) DAI BOANG SAU / (R) WOO SAU
- 101) (L) BIU JOANG SAU / (R) DUNG JING GYEUK
- 102) (R) POCK SAU / (L) WOO SAU / (R) FOOK SUT, (R) TAN SAU /  
(R) BOANG GYEUK, (R) BOANG SAU / (R) CHAI WAHNG  
GYEUK, (R) SYEUNG MA (L) JOANG SAU / (R) WOO SAU
- 103) (L) SYEUNG MA (R) DAI BOANG SAU / (L) WOO SAU
- 104) (R) BIU JOANG SAU / (L) DUNG JING GYEUK
- 105) (L) POCK SAU / (R) WOO SAU/ (L) FOOK SUT, (L) TAN SAU /  
(L) BOANG GYEUK, (L) BOANG SAU / (L) CHAI WAHNG  
GYEUK, (L) SYEUNG MA (R) JOANG SAU / (L) WOO SAU
- 106) SLIDE (L) FOOT TO (R), SYEUNG LOY JUT SAU / (R) JING  
GYEUK, SYEUNG PAU SAU / (R) YAI SUT DAI GYEUK
- 107) PUT (R) FOOT DOWN NEXT TO (L), SYEUNG LOY JUT SAU /  
(L) JING GYEUK, SYEUNG PAU SAU/ (L) YAI SUT DAI GYEUK
- 108) SAU SICK  
PUT LEFT FOOT DOWN NEXT TO RIGHT  
PALMS TO CHEST, THEN DOWN  
EXHALE  
**END OF THE MOOK YAN JOANG FORM**

## MAIN POINTS OF WOODEN DUMMY TRAINING

- 1) Don't hit the Dummy too hard; overemphasis of strength will lead to choppiness and restricted flow of power, Gradually build up to more powerful technique without injury or loss of relaxation; *"Doang Leen Ging Lick Duck Kay Fot."*
- 2) Move in a semicircle around the Dummy; either foot can step forward from the Semicircle toward the center, but the leading step should always move along the circular path.
- 3) Stick to the Dummy arms; try not to lose contact with the arms between motions. When moving around the Dummy while moving the hands from one Dummy arm to another, stay as close to the arms as possible; snake around the Dummy arms, clinging to them with forward, inward pressure from the fore-arms. *"Kiu Chee Joang Sau Sick Joke Hahng."*
- 4) Direct your power to the center of the Dummy; even those movements which appear to sweep the Dummy arms sideways are actually focused inward to the core of the Dummy trunk; *"Lick Yau Sum Fot Sheh Joang Sum."*
- 5) Always look at the Dummy; no matter what angle you face or technique you use, keep your eyes focused inward on the Centerline.
- 6) Adjust your movements to the size of the Dummy; be able to adapt to an opponent of any size. Learn to make alterations in the arms for a high Dummy and in the stance for a low Dummy. When sticking on the Wooden Dummy, stance mobility becomes very critical. Since the Dummy arm will not roll or flex like that of a live partner, you have to compensate by shifting your weight at just the right time to enable you to stay balanced, in control and in perfect structure at all points of the cycle. Once this ability to flow around a stationary object is mastered, it becomes much

### Close Range Combat Wing Chun: Volume Three

---

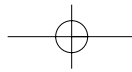
easier to roll arms with a live partner whose arms “give,” or to manipulate the opponent’s arm and move it off the Centerline, thus opening the body or head for striking.

- 7) Stay within 45° from the front of the Dummy; never expose your back or too much of your Dead Side to the Centerline. Stay within striking or kicking range at all times.
- 8) Maintain “Body Unity” while moving; keep the waist and stance moving as one. This will maximize the power obtained through stepping and/or turning; “*Yiu Ma Chai Doang*.”
- 9) Learn to execute inside a Centerline; understand the Centerline Theory and its relationship to the principles behind each of the 108 movements. Be conscious of the Centerline and how it comes into play as Centerline Advantage is created, lost and regained repeatedly in the form.



# SAN SAU—PRACTICAL APPLICATIONS





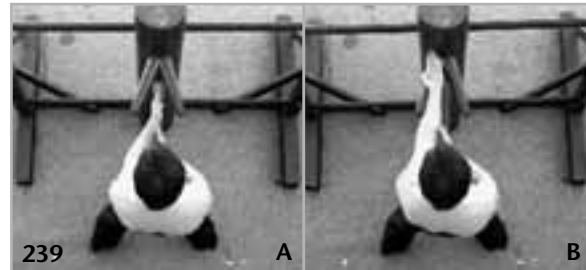
Close Range Combat Wing Chun: Volume Three

**Part I**

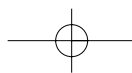
**Fig. 238**—Seen from overhead, the first motion of the Hoy Sick sequence puts the trainee at the correct distance from the Dummy to begin the set. The double Jom Sau of the Hoy Sick sequence positions the tenons of both arms inward in their square, mortised holes so that Biu Joang Sau, the first movement of the form, will contact the left Dummy arm and be able to move it outward. This motion can also be used in combat as a forearm smash known as Ngahn Woon.



**Fig. 239**—Biu Joang Sau, the thumb-up Thrusting Hand can be used to “Create Timing” by initiating Bridge Contact (239A) or to deflect an oncoming punch off the line with Multi-Directional Power (239B). Note the positioning of the Woo Sau hand near the inner elbow of the Biu Joang arm in the overhead view.

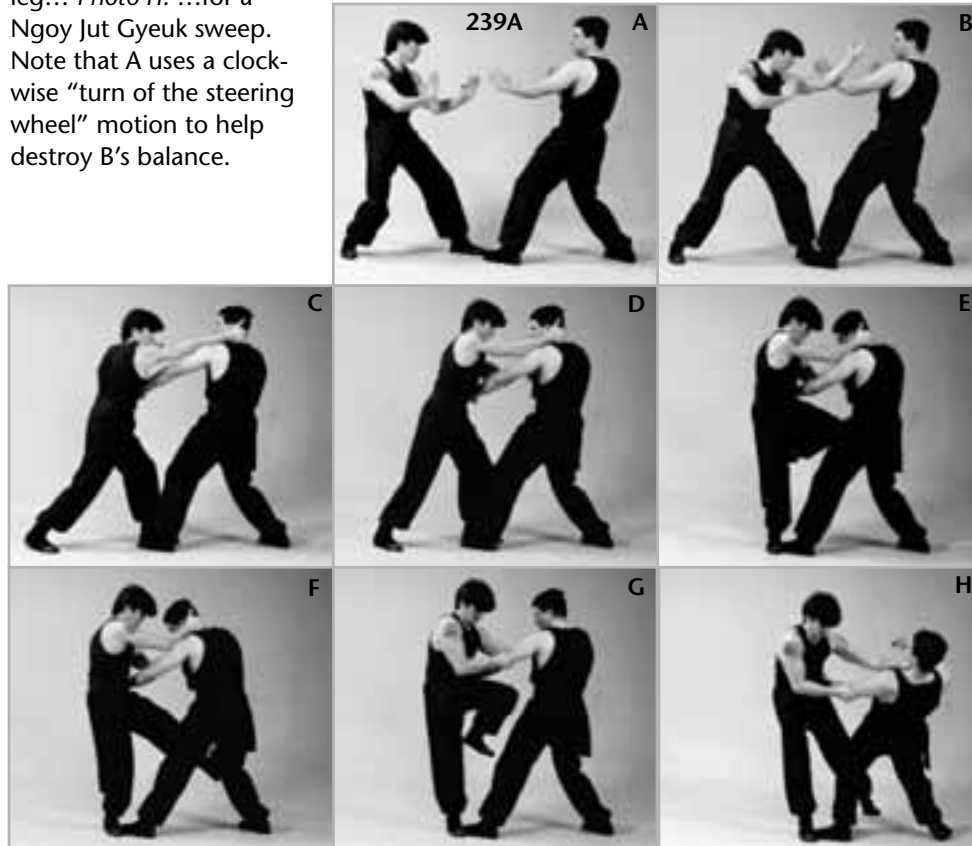


**239A**—Photo A: Fighters are in a Closed relationship. Photo B: Fighter A uses Biu Joang Sau to create Bridge Contact with B’s leading arm. Photo C: Without losing Bridge Contact, Fighter A converts the Biu Joang Sau into a Lop Sau grab to pull B forward as he reaches behind B’s neck. Photo D: Completing the Pon Geng Sau neck grab as in the form, Fighter A pulls himself forward as B also stumbles forward into a palm-up Gyeung Jee Kuen “Ginger Fist” punch to the throat. Photo E: Keeping the neck trap, Fighter A skips into a knee strike to the groin. Photo F: Without putting the foot down between kicks, Fighter A continues in with a “shadowless” Moh Ying Jing Gyeuk to the right knee. Photo G: Converting the left punch to a neck trap



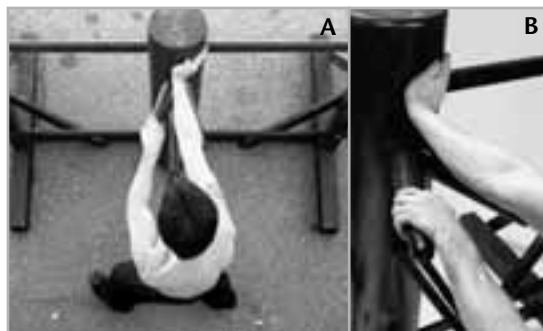
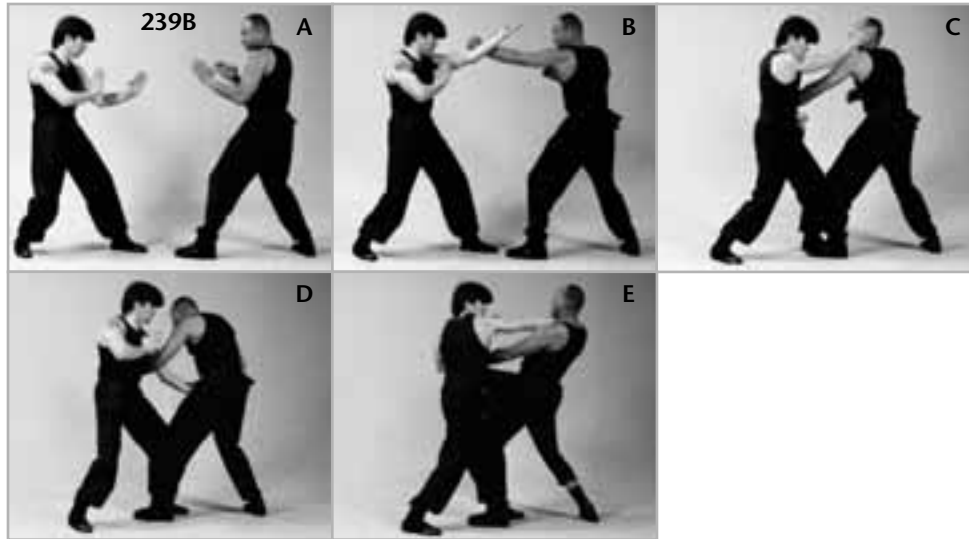
San Sau—Practical Applications

as his right hand slides down to trap B's tricep area with a palm-up Pau Sau grab, and still without putting his foot down, Fighter A chambers his left leg... *Photo H*: ...for a Ngoy Jut Gyeuk sweep. Note that A uses a clockwise "turn of the steering wheel" motion to help destroy B's balance.



**239B**—*Photo A*: Fighters in a Closed relationship. *Photo B*: Fighter A uses his lead left Biu Joang Sau to deflect B's jab, shearing into it at 45° and guiding it outward. *Photo C*: Without losing Bridge contact with B's arm, Fighter A uses a Gwot Sau sweep of that arm to guide it into a left Long Bridge Clamping Trap as his right hand comes up to strike the left ear. *Photo D*: First using a short, backward-jerking, counter-clockwise twist of his shoulders to cause B to stumble forward, Fighter A drives a low Pau Jyeung palm strike to the groin. *Photo E*: Converting the strike into a painful grab, Fighter A pulls B into a right Fun Sau chop to the throat.

Close Range Combat Wing Chun: Volume Three

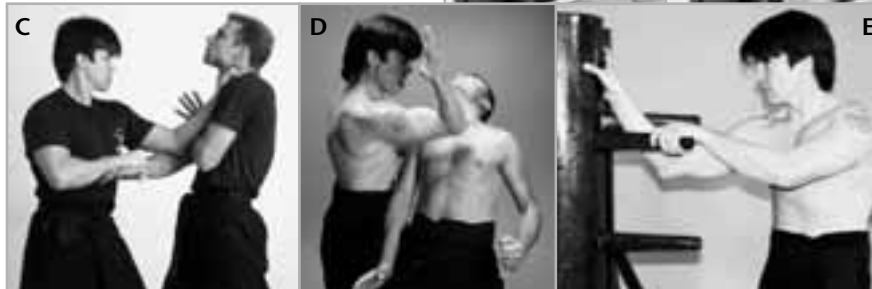
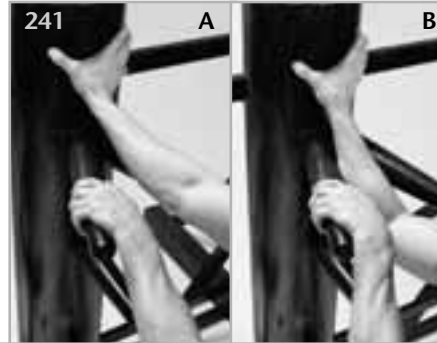


**Fig. 240**—The Lop/Chahng Geng Complex Trapping Motion teaches the trainee to pull his opponent into an openhanded strike using a thumbless grab, as was seen in series 239A and B.

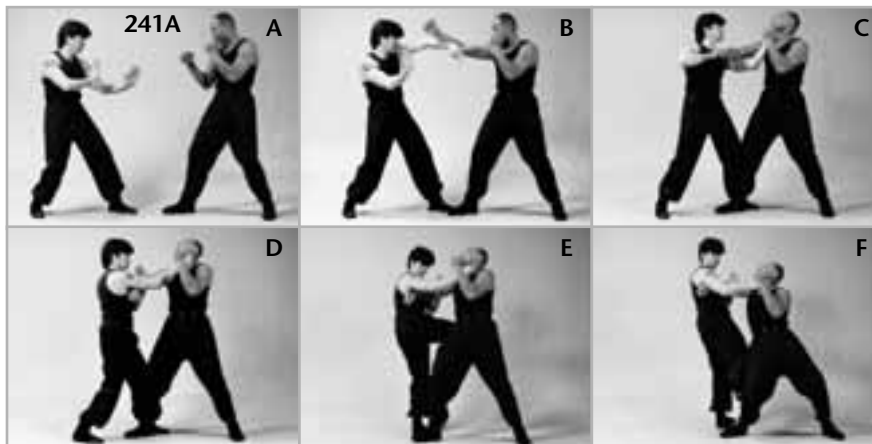
**Fig. 241**—The Sau Jahng grabbing and sinking motion can be interpreted in a number of ways. First, as a throat grab, shown in 241A to choke and hold the opponent while kicking his legs out. Another application is seen in 241B, where Fighter A jerks B's leg out with Loy Jut Gyeuk and uses a throat grab to push her off balance. The sinking elbow motion can also be used to gain control over the opponent's neck as was seen in photos C and D of series 239A, where Fighter A's Chahng Jyeung palm strike is converted to Pon Geng Sau as he punches to the throat, preventing his opponent from "fading back" by pulling him into the blow. Besides its application as a neck trap, the Chum Jahng motion can be used as a blinding thrust that digs the thumb and fingers into the opponent's eyes. Yet another application of the Pon Geng Sau motion was seen in sequence ODJC-2 in Volume II of this series, where after launching a successful Pock Da Fun Sau

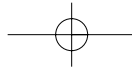
### San Sau—Practical Applications

attack, Fighter A quickly converts the chop into a neck trap that pulls him off balance for a sweep. This reverse usage of Pon Geng Sau is also seen in series 247A and 249B in this volume.



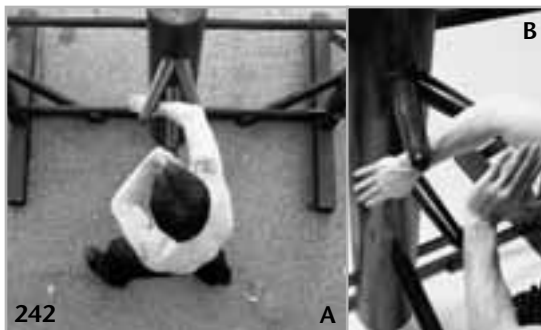
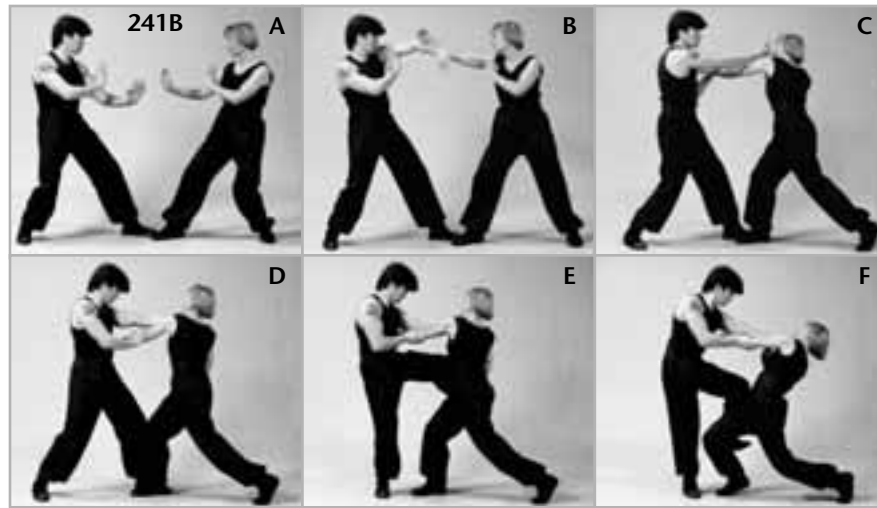
**241A**—Photo A: Fighters are in an Open relationship. Photo B: Fighter A uses left Boang Sau to stop B's jab. Photo C: A then "leaks" upward with his left arm to an uppercut punch. Photo D: Sharply drawing his left elbow backwards in a reverse Woo Sau Wrap, Fighter A grips B's throat using the Sau Jahng motion. Photo E: Keeping the throat grab, A steps off to the left with his left foot and chamber the right leg... Photo F: ...for a Huen Wahng Gyeuk Circle Sidekick to the back of the leg.





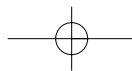
**Close Range Combat Wing Chun: Volume Three**

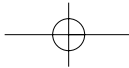
**241B**—*Photo A:* Fighters are squared off in an Open relationship. *Photo B:* Fighter A again uses left Boang Sau to stop B's jab. *Photo C:* As B's cross comes in, Fighter A takes a short forward/sideward step to the outside and counters with Toh Ma Tan Da. *Photo D:* With another short, shuffling Toh Ma advance, Fighter A Switchtraps and grabs B's throat. *Photo E:* Keeping the throat grab, A takes a skipping step to chamber his left leg... *Photo F:* ...for a Loy Jut Gyeuk hock breakdown to the back of the leg, simultaneously extending his left arm to shove B backward off balance. Note that B can be taken to the ground at this point, guiding her head to be the first point of contact with the floor to absorb the combined falling weight of both fighters.



**Fig. 242**—As is seen in 242A, the Choh Ma Boang Sau can be used to deflect a chest- to chin-level straight punch from the opposite arm, as long as that punch originates from above the blocking arm. Photo 242B shows Boang Sau used in its more commonly seen application from an Open relationship. The same Boang/Woo structure is seen in 242C, with the Woo Sau serving

as both a trap and lever and Boang Sau used as a fulcrum to break the arm. In 242D, Lop Sau is used to pull the opponent's arm into a Boang Sau break. By substituting a Gum Jyeung palm heel strike for the relaxed wrist of the Boang

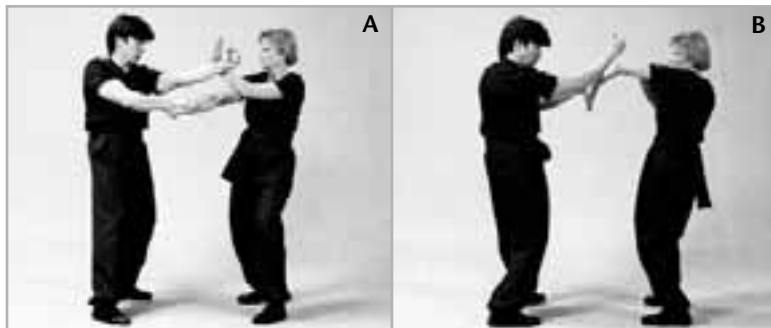




## San Sau—Practical Applications

*Sau and treating the Woo Sau as an inward shoulder trap, the opponent's neck can be snapped with a "hidden" motion that is unmistakably derived from Choh Ma Boang Sau (242E).*

242A



242B



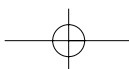
242C

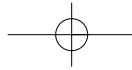


242D



242E



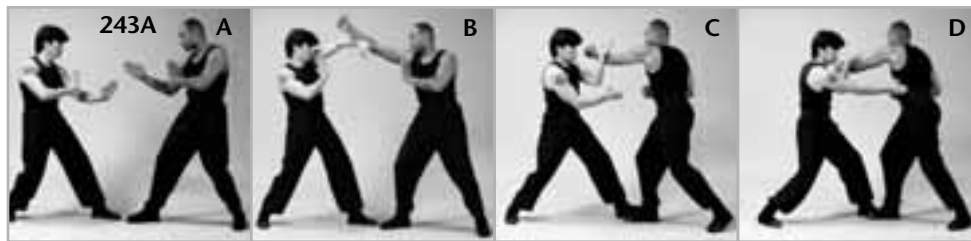


### Close Range Combat Wing Chun: Volume Three

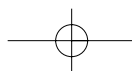
**Fig. 243**—*Seep Ma Tan Da Chahng Dai Jyeung*. In 243A and B, Fighter A uses this Complex Motion to defend against the opponent's second punching attempt while simultaneously striking him broadside with a low "Spade Palm" thrust. 243C shows how *Seep Ma* footwork can be used as an outer sweep of the opponent's legs after a successful headbutt attack. The Inner *Seep Ma* Sweep is seen in 243D and E.



**243A**—*Photo A*: Fighters are in an Open relationship. *Photo B*: Boang Sau stops the jab. *Photo C*: As B's left cross comes in, Fighter A steps outside to the left with his left foot and begins the Tan Sau and low "Spade Palm" strike. *Photo D*: Tan Da Chahng Dai Jyeung.

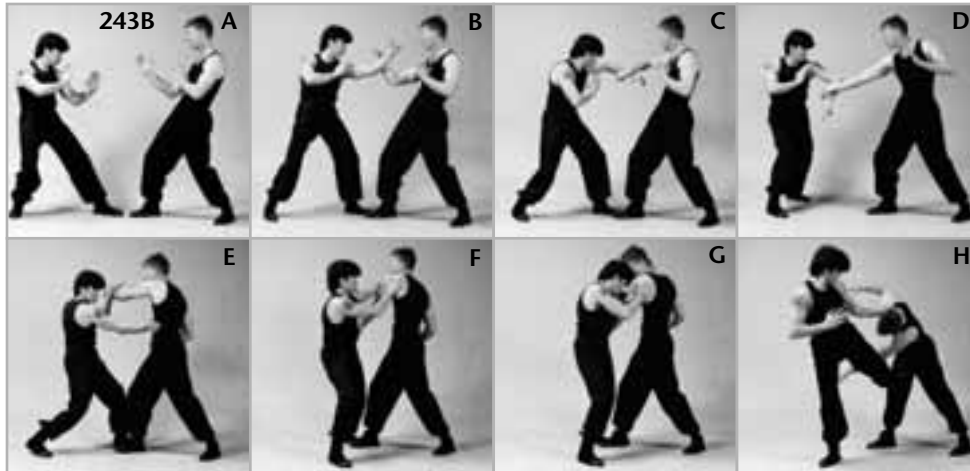


**243B**—*Photo A*: Fighters are in an Open relationship. *Photo B*: Fighter B uses his lead right Jom Sau to stop A's left jab. *Photo C*: After successfully blocking the punch, B uses a Huen Sau scoop to open the Centerline. *Photo D*: As the low "Spade Palm" of B's Huen Gwot Sau attack is fully extended, Fighter A uses Back Bracing Hau Chong Ma footwork to create space and relieve the pressure from B's strike as he drops his left arm and converts it into Dai Boang Sau to redirect B's hand. *Photo E*: As B's left cross comes in, Fighter A steps outside to the left with his left foot and counters with Tan Da Chahng Dai Jyeung. *Photo F*: Sidestepping out to the right with his right foot, Fighter A slaps B's left shoulder, causing him to stumble sideward into a Ngahn Woon forearm smash. *Photo G*: A keeps the neck trapped and headbutts B to the temple. *Photo H*: Still keeping the neck trapped, Fighter A finishes the second circling syllable of his *Seep Ma* footwork in the air, pulling B's weight over his own right leg and then kicking the knee from the side.



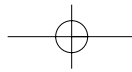


San Sau—Practical Applications



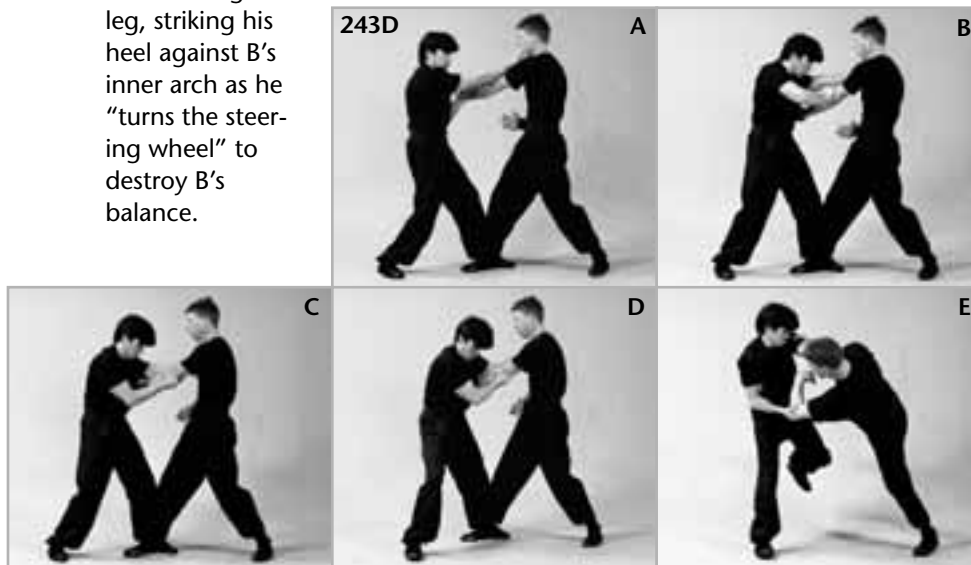
**243C**—*Photo A:* Fighters are in a Closed relationship. *Photo B:* Tan Da stops the jab. *Photo C:* As B continues with a rear cross, Fighter A “fades back” with Boang Sau/Wahng Gyeuk. *Photo D:* A plants, traps and strikes with Syeung Ma Lop Chahng Jyeung. *Photo E:* Converting the palm strike to a neck trap, Fighter A snaps his head forward to butt B’s head. *Photo F:* Keeping the neck trapped, A takes the first right sidestep of Seep Ma with his right foot. *Photo G:* Fighter A then brings his left leg around behind B’s left leg in an Outer Seep Ma Sweep.



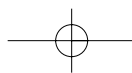


**Close Range Combat Wing Chun: Volume Three**

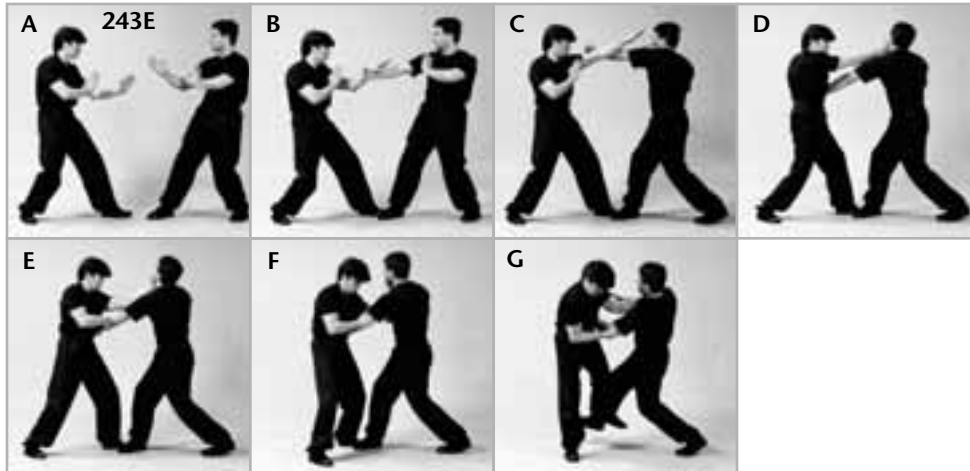
**243D**—*Photo A:* Fighter A stops B’s rear cross with Tan Da. *Photo B:* A then switches the trapping duty while attacking the throat with a “Spade Palm” strike. *Photo C:* Converting the strike to a neck trap, A turns his right palm over to become a Pau Sau trap at the tricep. *Photo D:* Fighter A takes the first right sidestep of Seep Ma. *Photo E:* A then sharply circles his left leg inside B’s right leg, striking his heel against B’s inner arch as he “turns the steering wheel” to destroy B’s balance.



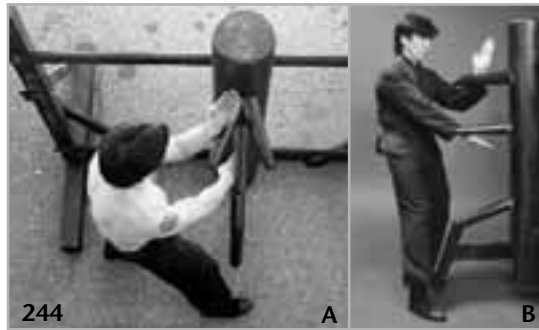
**243E**—*Photo A:* Fighters are in an Open relationship. *Photo B:* Fighter A uses Fook Sau to stop B’s jab. *Photo C:* Using “Yut Fook Yee” principle, Fighter A uses the same hand to stop B’s second punching attempt. *Photo D:* Without losing Bridge Contact, Fighter A pulls B’s left arm and punches. *Photo E:* Retrap/Punch. *Photo F:* Fighter A sidesteps to the right with his right foot in the first syllable of Seep Ma footwork... *Photo G:* ...and circles his left foot inside B’s right foot to kick his leg out. Note that A uses a “turn of the steering wheel” as in the previous technique.



San Sau—Practical Applications

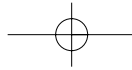


**Fig. 244**—Toy Ma Gahng/Jom Sau uses two forward chopping motions to cover the entire Centerline with one sweep. In 244A, Gahng/Jom is used to stop two rapid-fire punches with offset timing. Both 244B and 244C show how Gahng/Jom Sau can be used to defend against a powerful Roundhouse Kick, followed by a Lau Sau scoop of the kicking leg derived from Movements 78 and 79 of Siu Leem Tau. Series 244D illustrates an attacking application of this movement, and in photos B and C of that figure, Gahng Da, one of three main Complex Attacking Origins is shown. As can clearly be seen, this motion has its roots in Gahng/Jom Sau. Later in this volume, fig. 265 will show other ways of using Gahng/Jom Sau as a Complex Blocking and Attacking Motion.



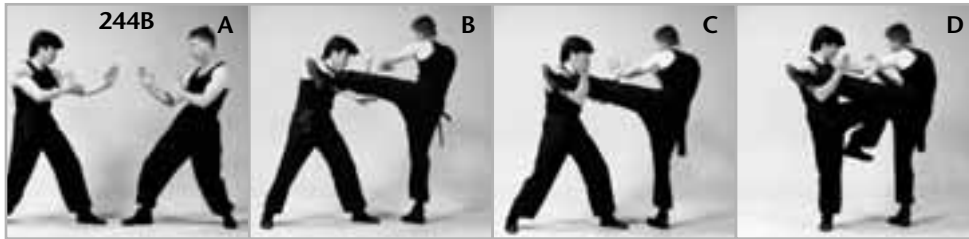
**244A**—Photo A: Fighter A has swept B's right punch to the low line, and sees the rear cross coming with "one-and-a-half-beat" timing. Photo B: Using his own offset timing, Fighter A completes his Gahng/Jom motion in time with B's cross.





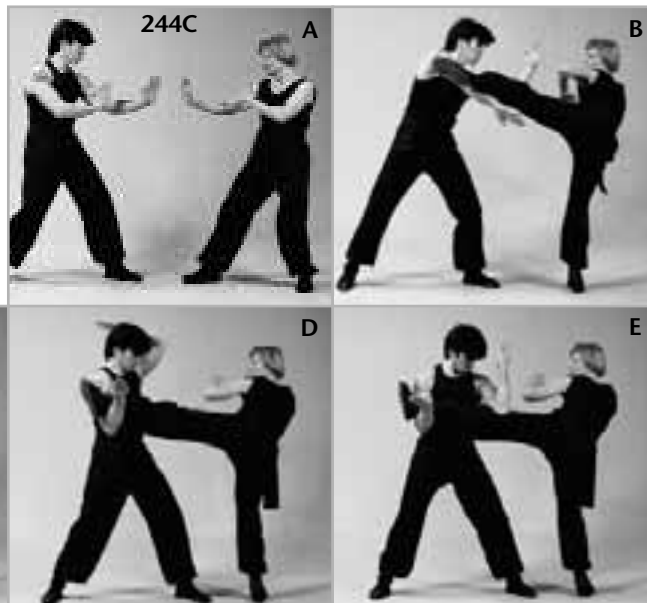
**Close Range Combat Wing Chun: Volume Three**

**244B**—*Photo A:* Fighters are in an Open relationship. *Photo B:* As B attempts a left rear mid-level Round Kick, Fighter A meets the kick with Gahng/Jom Sau. *Photo C:* A's right arm immediately scoops upward to trap B's kicking leg with Lau Sau from the Siu Leem Tau form. *Photo D:* Keeping the leg trapped, Fighter A skips into knee attack to the inner thigh.

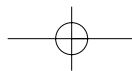


**244C**—*Photo A:* Fighters are in an Open relationship. *Photo B:* As B attempts a high left rear Round Kick, Fighter A again meets the kick with Gahng/Jom Sau. *Photo C:* Fighter A scoops his right arm upward to trap B's kicking leg with Chum Kiu. *Photo D:* Keeping her leg trapped, Fighter A brings his left elbow up...

*Photo E:* ...then brings it sharply down on the side of B's knee to break her leg.



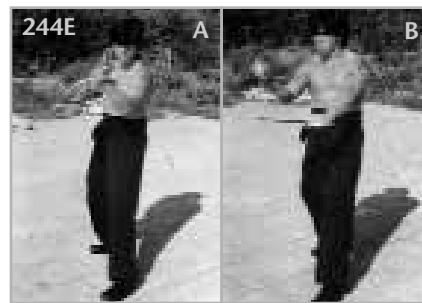
**244D**—*Photo A:* Fighter A sees B about to launch a pivoting Choh Ma Chop Kuen attack. *Photo B:* As B pivots and punches on the low line, Fighter A blocks and counterstrikes with Gahng Da. *Photo C:* Gahng Da is used again on the other side when B pivots into a second Chop Kuen Attack.



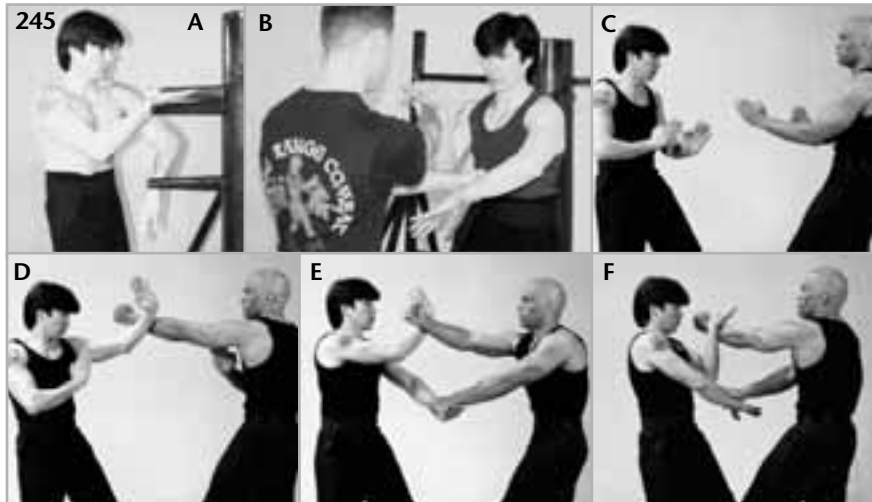
### San Sau—Practical Applications



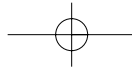
**244E**—Gahng/Jom Sau with the Rattan Ring and “Bot” Jom Doh



*Fig. 245—Ngoy Kwun Sau, the Outward Rolling Arms Block, is used here to “borrow” the power of the opponent’s grab by spinning it downward while redirecting that power into the Tan Sau defense hand.*

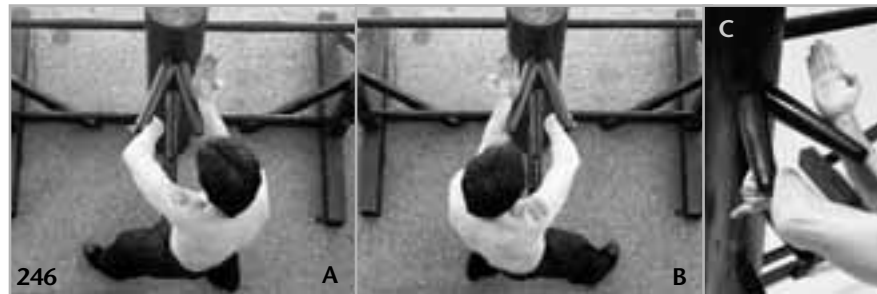


*Fig. 246—A combination of Huen Sau and Jom Sau, the Loy Kwun Sau Inward Rolling Arms Block (shown from overhead on both sides) is most often used as a Complex Block with offset timing to defend against two closely-timed “one-and-a-half-beat” strikes. At times, Loy Kwun Sau can be used to “double-up” on an*

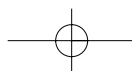
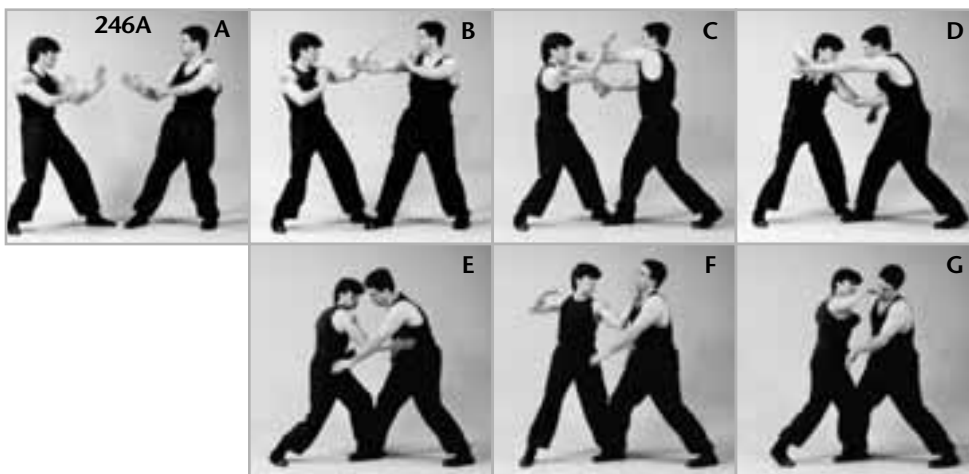


### Close Range Combat Wing Chun: Volume Three

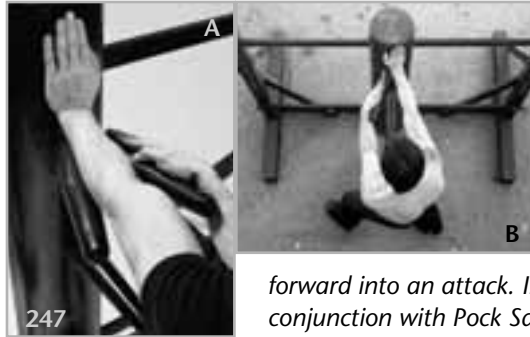
*extremely powerful and well-focused attack or as a Hook and Strike trapping attack to snag the opponent's arm and pull him into a simultaneous counterattack an action that formally introduces the concept of Huen Da.*



**246A**—*Photo A:* Fighters are in ready position with an Open relationship. *Photo B:* Fighter A uses his left Jom Sau to stop B's jab. *Photo C:* As the second part of B's "one-and-a-half-beat" double punching attack comes in, Fighter A uses his own offset-timing Loy Kwun Sau to simultaneously Hook Trap the first punch with Huen Sau while borrowing its power to be used in the Jom Sau block against the cross. *Photo D:* Again converting Jom to Huen, Fighter A scoops the line open with his right hand as he strikes the open low line with Chahng Dai Jyeung. *Photo E:* Unloading the coiled right Huen Sau wrist for "artificial running start" to add power to the strike, Fighter A again attacks the body with a second Chahng Dai Jyeung. As he strikes, his left hand is chambered for the next punch. *Photo F:* While again chambering his right hand for the follow-up, Fighter A shoots Chau Kuen up the middle. *Photo G:* Fighter A finishes the combination with Loy Doy Gock Kuen.



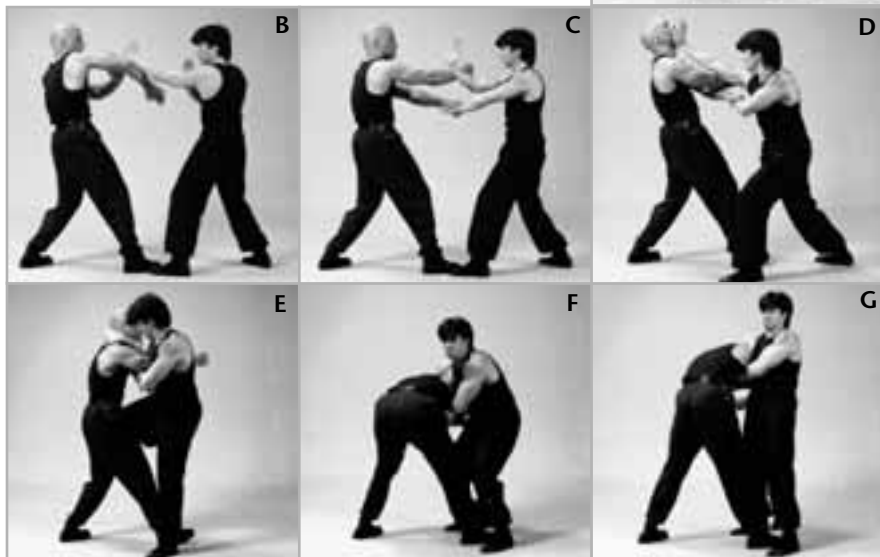
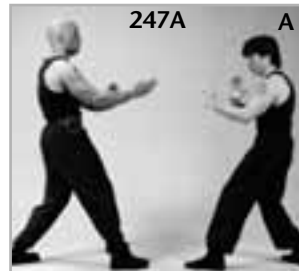
### San Sau—Practical Applications

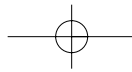


*Fig. 247—The Jut Da Jing Jyeung motion, which is repeated six times within the 108, can be applied in its purest form (247A), but its principle is the root of many Complex Attacks in which the opponent is sharply jerked*

*forward into an attack. In 247B, Jing Jyeung is used in conjunction with Pock Sau.*

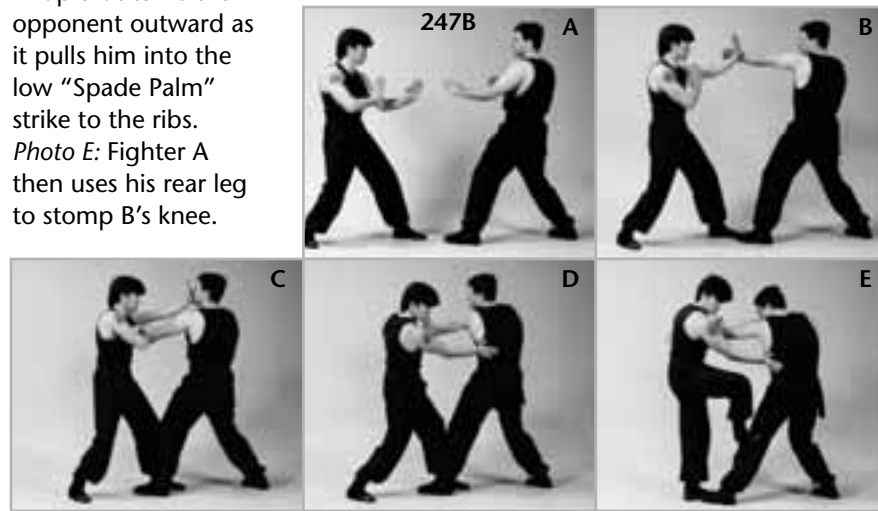
**247A**—*Photo A:* Fighters square off in an Open relationship. *Photo B:* Fighter B stops A's jab with Boang Sau. *Photo C:* B continues in with Lop Da Loy Fon Kuen, which is blocked by Fighter A's right Woo Sau. *Photo D:* Using B's left grab as a Trapping Reversal, Fighter A pulls his own left hand back toward himself in Jut Sau structure to pull B into his step/sliding Toh Ma Jut Da Jing Jyeung. *Photo E:* A then converts the strike to a reverse Pon Geng Sau neck trap that pulls B into a knee strike. *Photo F:* Fighter A puts his foot down and begins to slip his right arm under to meet the left... *Photo G:* ... for a standing "Guillotine" choke.



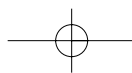


### Close Range Combat Wing Chun: Volume Three

**247B**—*Photo A:* Fighters face off in a Closed relationship. *Photo B:* Fighter B attempts a lead left jab, which is stopped by A's left Woo Sau. *Photo C:* Switching the trapping duty from left to right, Fighter A takes a small forward step to the outside for Facing advantage and to add power to his Pock Da Jing Jyeung. *Photo D:* Dropping the left striking hand down and to the left of B's extended left arm, Fighter A envelops that arm with a cross Woo Sau Wrap that turns the opponent outward as it pulls him into the low "Spade Palm" strike to the ribs. *Photo E:* Fighter A then uses his rear leg to stomp B's knee.

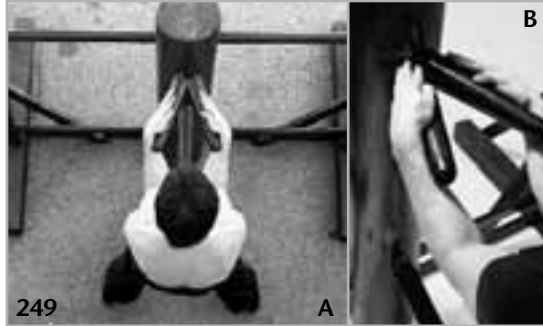


**Fig. 248**—*Jut Da Chahng Dai Jyeung*, the left hand counterpart motion used in each left section closure of the Dummy form, shown close-up and from overhead (photos A and B). Photos C and D show this technique in application.





### San Sau—Practical Applications

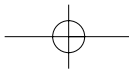


*Fig. 249—Syeung Loy Jut Sau, used in 249A in double form to pull the opponent into a knee attack, can also be applied singly as can be seen many times in this book series. Series 249B shows a combat application of Jing Ma footwork used to sweep the opponent's foot. 249C shows Jut Sau princi-*

*ple at work, as Fighter A pulls the opponent into a punch with a sharp, jerking motion that adds shock to the strike.*

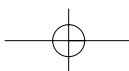
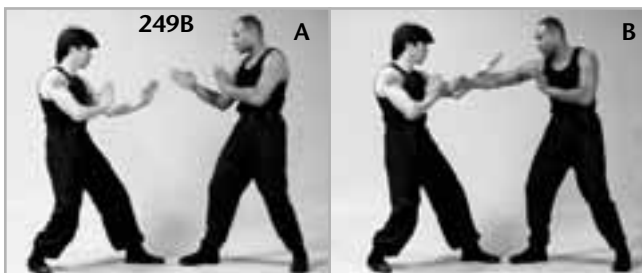
**249A**—*Photo A:* Fighters are in an Open relationship. *Photo B:* Fighter A blocks B's lead Round Kick with his own left Gahng Sau. *Photo C:* Quickly moving inside, Fighter A traps both of B's shoulders as he skips in. *Photo D:* Using the double Jut Sau motion from the Dummy form, A jerks B sharply downward into a Tai Sut upward knee strike. *Photo E:* Without putting the foot down between kicks, Fighter A swings his right foot out to attack B's rear left knee. *Photo F:* A continues to hold B down by the neck as he chambers his left arm... *Photo G:* ...for a downward-twisting Chum Sau attack to the spine with the point of his elbow.





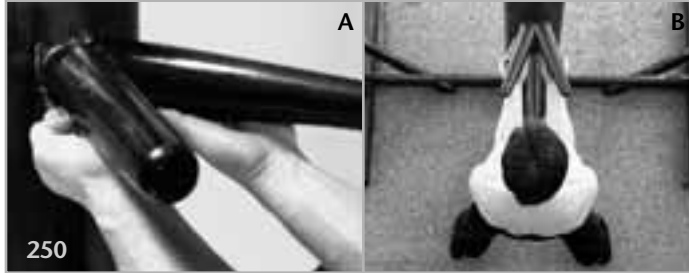
### Close Range Combat Wing Chun: Volume Three

**249B**—*Photo A:* Fighters are in an Open relationship. *Photo B:* Fighter A uses Fook Sau to stop the jab. *Photo C:* As B throws the left cross, A uses a Fon Sau Whip Grab to catch up to the punch, pulling him into Lon Sau Jing Gyeuk from the Chum Kiu form. *Photo D:* Fighter A then plants, switchtraps and strikes with Pai Jahng. *Photo E:* Taking a small step with his left foot behind B's right foot, Fighter A hooks his foot around B's heel as he converts his left hand to a reverse Pon Geng Sau neck trap in time with an inward Jing Ma pivot on his left heel to break B's balance.



San Sau—Practical Applications

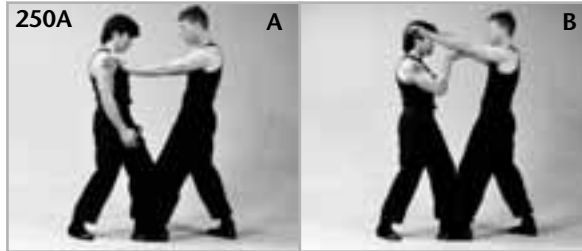
**Fig. 250**—Pau Jyeung, the Lifting Palm, is shown in its double form used to defend against a two-handed push in 250A. As is seen in 250B, the same motion is used on the ground as a



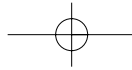
painful flesh grab. Pau Sau is often used as a palm-up trap, as was seen in fig. 243D, where it was used to help “turn the steering wheel” during a sweeping throw. The striking form of Pau Sau was seen in fig. 239B as a fully rotated Reverse Vertical Palm Strike on the low line. Pau Jyeung also forms the lower half of the Jeep Sau motion, which will be seen later in fig. 284.

**250A**—Photo A: Fighter B uses a continuous two-handed push on A’s chest. Photo B: A uses double Pau Sau to lift B’s hands off his chest and over his shoulders, opening the Centerline and causing B to stumble forward.

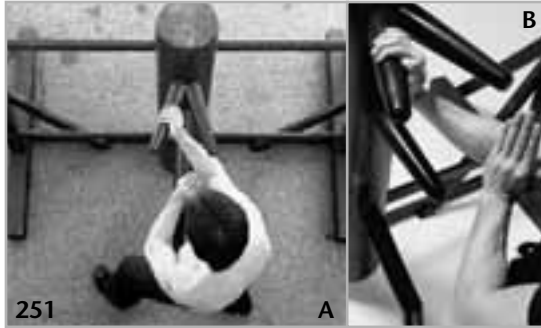
Photo C: When B’s arms are over his shoulders, Fighter A drops his hands... Photo D: ...and reaches to trap B’s shoulders from behind. Photo E: Continuing his forward momentum, Fighter A moves in with the headbutt.



**250B**—Double Pau Sau used as a flesh grab in Groundfighting.



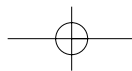
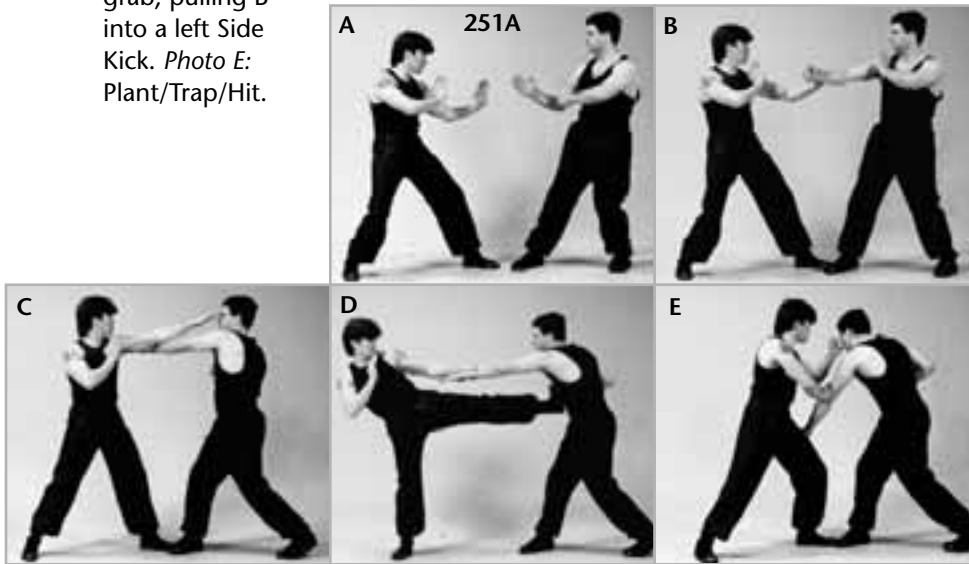
### Close Range Combat Wing Chun: Volume Three



*Fig. 251—Striking the Dummy arms from inside does not necessarily mean that the motion being executed is always directed to the inside of the opponent's striking arm. Although the Loy Moon Pock Sau is sometimes used to slap the opponent's arm from inside, this motion is normally applied to the outer arm as in 251A, where Fighter A stops B's jab by jamming it into the*

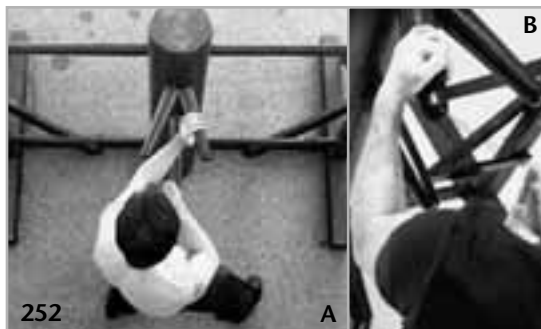
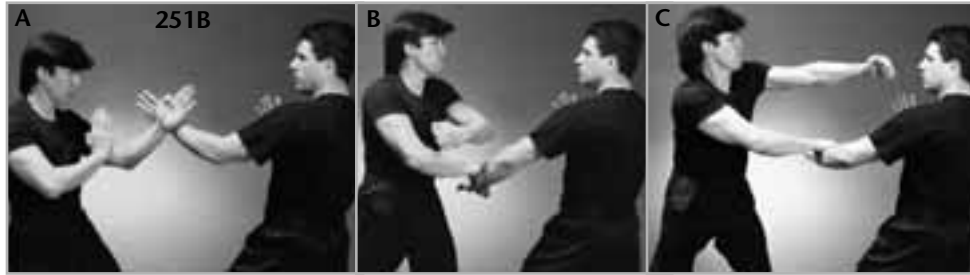
*Centerline. Another way of using Pock Sau to break the line open is seen in 251B, where Fighter A executes the Pock Da Complex Attack as a Poh Joong Kuen "Center-breaking" technique.*

**251A**—Photo A: Fighters are squared off in an Open relationship. Photo B: Fighter A stops B's jab with his own left Pock Sau. Photo C: Using Yut Fook Yee principle, A stops B's second punch with his own left Biu Sau. Photo D: Without losing Bridge Contact, Fighter A converts the left Biu Sau to a grab, pulling B into a left Side Kick. Photo E: Plant/Trap/Hit.



**San Sau—Practical Applications**

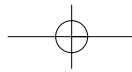
**251B**—*Photo A:* Bridge Contact from a Closed relationship. *Photo B:* Using a wheel-like rolling motion of the hands, Fighter A slaps B’s guard down and begins the inside-whipping Loy Fon Kuen. *Photo C:* Having “broken the center” with Pock Sau, A’s punch is completed.



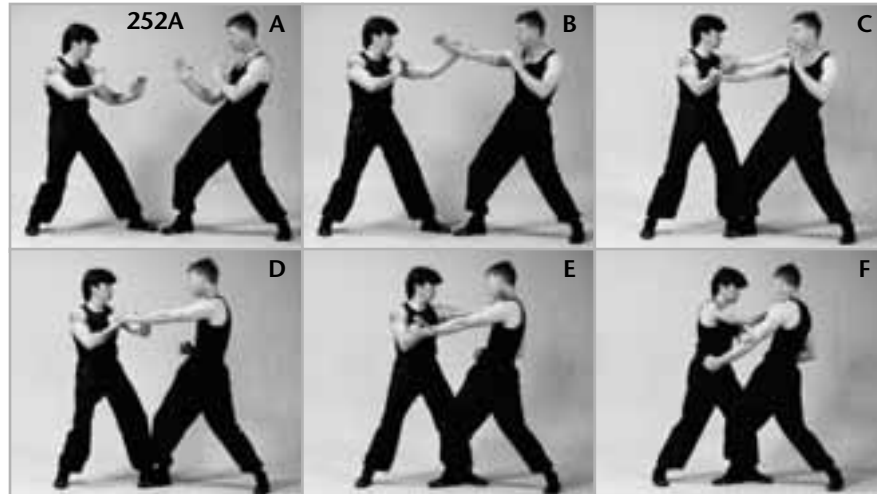
**Fig. 252—Kau Sau.** Following the same Elbow Line as Pock Sau, but in the opposite direction, Kau Sau is most often used as a “Catch-up Block,” as in 252A, where Fighter A’s striking hand has to move backwards to block B’s hand. It is also used as a “Catch-up Trap” to reach

in and trap the opponent’s hand from behind as seen in 252B. Series 252C shows how Kau Sau can be used to take over the trapping duty by pulling the opponent’s arm to full extension for a joint-locking attack.

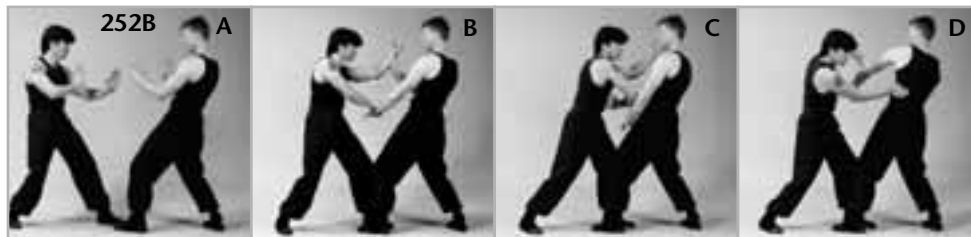
**252A**—*Photo A:* Fighters are in an Open relationship. *Photo B:* Fighter A stops B’s jab with Pock Sau. *Photo C:* A then takes over the trapping duty with the palm-up block of a step-sliding Toh Ma Tan Da. *Photo D:* As B’s second punch is launched before A can retract his left hand, Fighter A uses Kau Sau to “catch up” with B’s punch from behind. *Photo E:* Again taking over the trap with his right hand, Fighter A then releases the Kau Sau and shoots the hand in to chop B’s throat. *Photo F:* Retracting the left chopping hand to switchtrap B’s left arm, Fighter A reattacks the throat using a right “Spade Palm.”



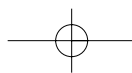
Close Range Combat Wing Chun: Volume Three



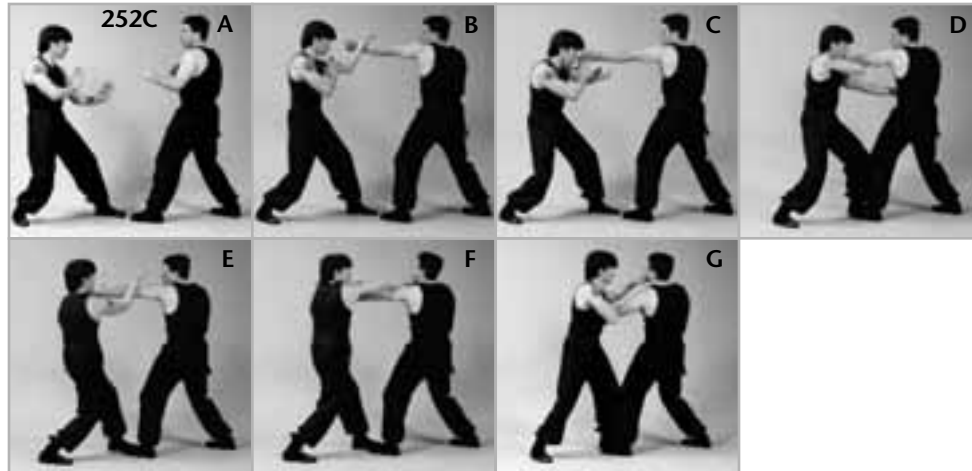
**252B**—*Photo A:* Fighters are in an Closed left relationship. *Photo B:* Fighter A attacks B using Toh Ma Pock Da to “break center,” but B uses his own Pock Sau to stop the punch. *Photo C:* Moving his right hand backwards to “catch up trap” B’s right hand with Kau Sau, Fighter A moves in with a Lon Sau lay-over trap as he punches with his left hand. *Photo D:* A then drops the left hand to hook B’s left elbow, scooping the low line open with Huen Da Chahng Dai Jyeung.



**252C**—*Photo A:* Fighters are in a Closed relationship. *Photo B:* Fighter A stops B’s jab with his own left Tan Sau. *Photo C:* Using Kau Sau to pull B’s left arm to full extension over his own left shoulder, Fighter A begins a Huen Sau circle of his left hand... *Photo D:* and step/slides in to add more power to the left Chahng Dai Jyeung strike to the ribs. *Photo E:* Still using Kau Sau to keep B’s arm fully extended, Fighter A breaks the arm with a Chum Kiu strike to the inner wrist and outer elbow. *Photo F:* Converting the left hand to Huen Sau to circle over the top of B’s left arm to clear it out of the way, Fighter A chops forward with the right hand to B’s throat. *Photo G:* A then finishes up with Toh Ma Gum Da Loy Doy Gock Kuen.

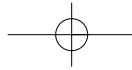


San Sau—Practical Applications

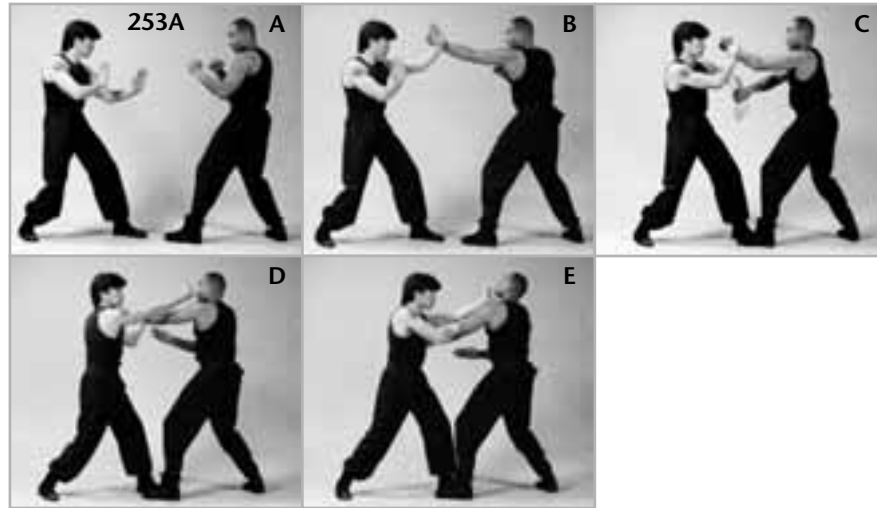


*Fig. 253—Poh Joong Kuen—the “Center-breaking” punch. Seen earlier in 251B and 252 B, Poh Joong Kuen is more a principle than an actual technique. If the Centerline is obstructed, it is often possible to knock or slap the obstruction away while delivering a simultaneous strike.*

**253A**—*Photo A:* Fighters are squared off in a Closed relationship. *Photo B:* Fighter A stops B’s left jab with his own left Woo Sau. *Photo C:* B uses Poh Joong Kuen principle to knock the line open with Pock Da, but Fighter A drops his left arm into a “Sinking Bridge” Dai Boang Sau to absorb most of the technique’s power, and uses Pock Sau to block the attack. *Photo D:* In another example of Poh Joong Kuen, Fighter A uses the Raising Tan Sau from the Chum Kiu form to break the line open for his punch, which lands successfully. *Photo E:* Even if the previous punch had been fully or partially blocked by B’s left arm, A’s final Pock Da would have acted as yet another Poh Joong Kuen to break the line open for attack.



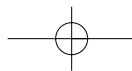
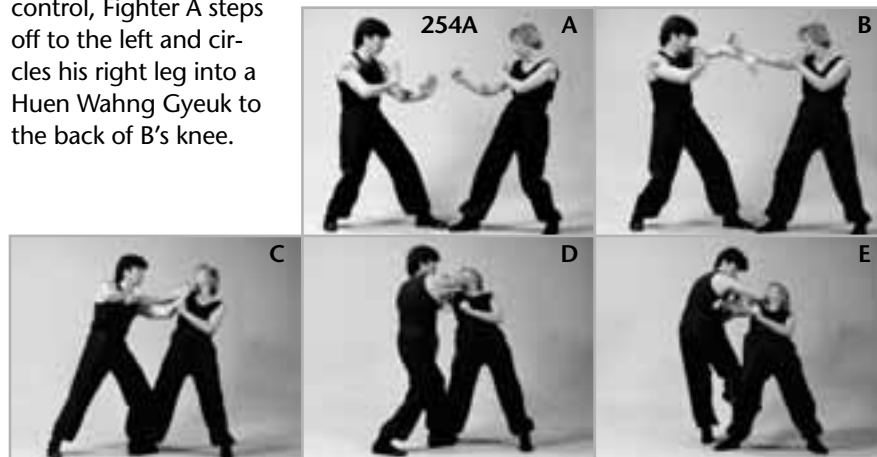
Close Range Combat Wing Chun: Volume Three



**Fig. 254—Chau Kuen—The Drilling Punch.**

**254A—Photo A:** Fighters are squared-off in an Open ready position. **Photo B:** Fighter A uses Boang Sau to stop B's right jab. **Photo C:** Using his right Lon Sau to pull horizontally instead of using Lop to pull downward, Fighter A keeps the line open for his left Chau Kuen uppercut to come through from beneath. Note that Lop Sau would have blocked A's path for this punch.

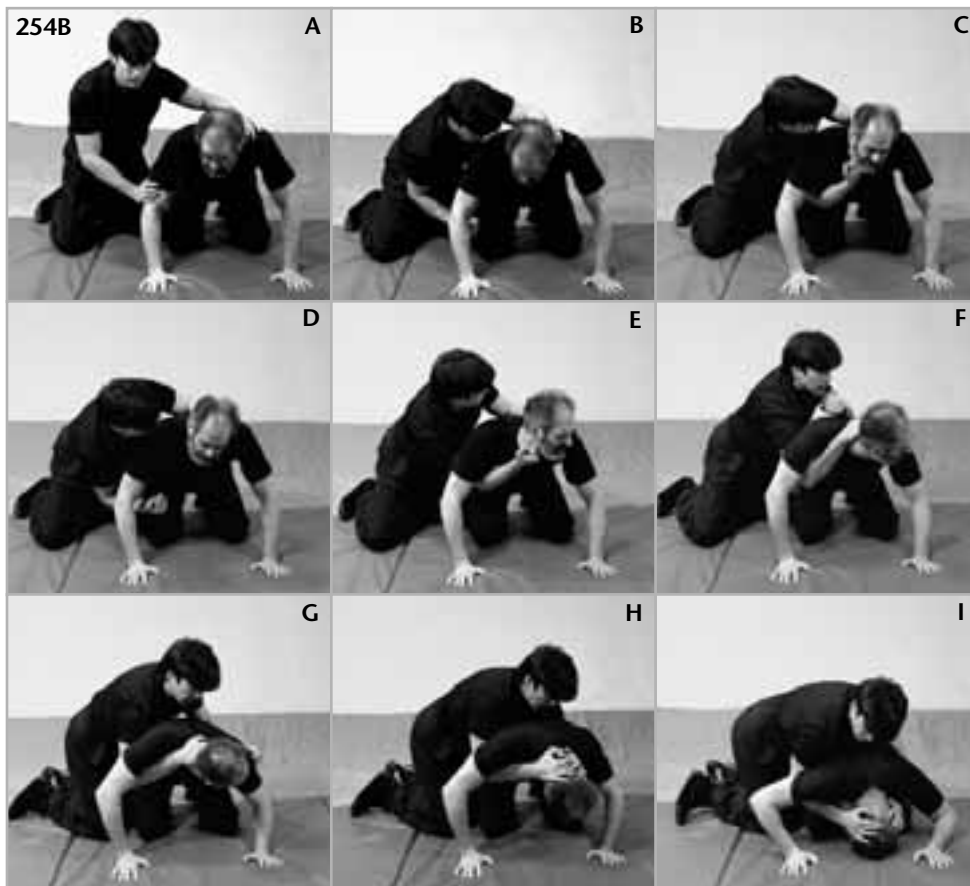
**Photo D:** Keeping the right grab, Fighter A retracts the left hand into a reverse Woo Sau Wrap to pull B's forearm up tight against his chest as he pivots into a Pai Jahng Hacking Elbow attack to the jaw. **Photo E:** Keeping both points of control, Fighter A steps off to the left and circles his right leg into a Huen Wahng Gyeuk to the back of B's knee.





### San Sau—Practical Applications

**254B**—The same conversion of the Chau Kuen to Kau Sau seen in the change from Movements 23 to 24, is shown here in a Groundfighting application. *Photo A:* With his opponent on “all-fours,” Fighter A uses double Kau Sau at the neck and elbow. *Photo B:* Pulling B’s head down into the strike, Fighter A comes up from under B’s arm... *Photo C:* ...and punches him with an upward Chau Kuen. *Photo D:* Keeping the neck trapped, A retracts his right fist... *Photo E:* ...for a second punch. *Photo F:* When B begins to turn his head away from the strikes, Fighter A converts the Chau Kuen to a Kau Sau neck trap. *Photo G:* At this point, the opponent can be punched again from the other side, or... *Photo H:* ...if he turns his head again, both hands interlock behind his neck... *Photo I:* ...and, in an application of the Chum Sun motion of the Biu Jee form, his head is driven into the ground.

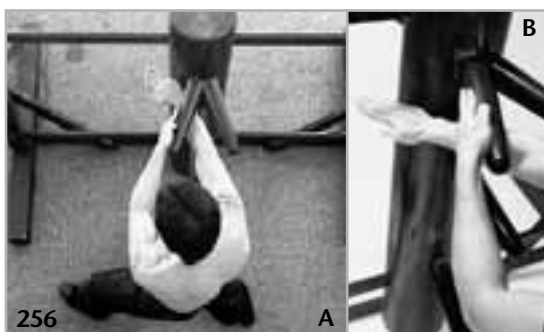
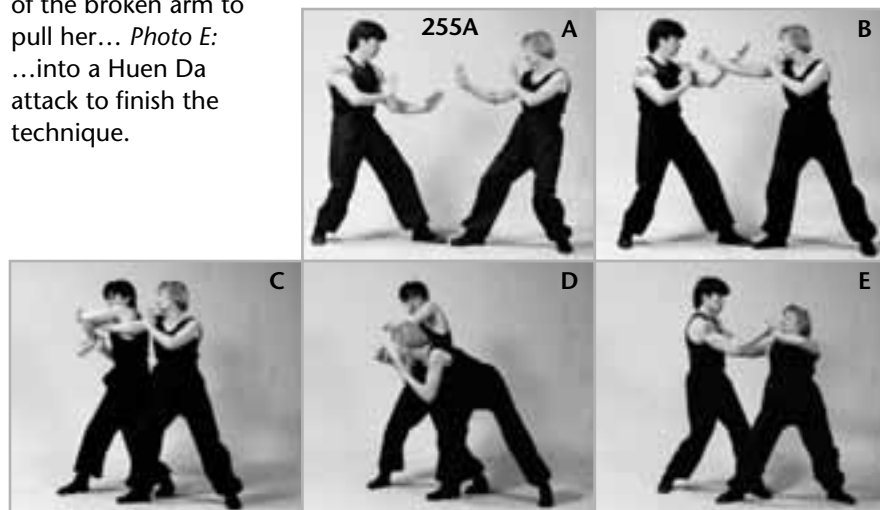


Close Range Combat Wing Chun: Volume Three



**Fig. 255**—*Dai Boang Sau*. Most often used to redirect a low strike from a position of prior Bridge Contact, as was seen in fig. 243B, or as a “Sinking Bridge” to absorb the shock of an opponent’s slap or grab as in fig. 253A, the low Wing Arm Deflection can also be used as a joint-locking Wrapping Trap.

**255A**—Photo A: Fighters face off in an Open relationship. Photo B: Fighter A uses a left Fook Sau to stop the jab. Photo C: Stepping forward and behind the opponent, Fighter A slips his left arm down and around her right arm in Dai Boang Sau structure and pivots to complete the Loy Seen Wai footwork that powers the armbreak. Photo D: At the completion of the break, Fighter A turns sharply back, creating a “whiplash” effect as he hooks the inner elbow of the broken arm to pull her... Photo E: ...into a Huen Da attack to finish the technique.



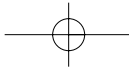
**Fig. 256**—Within the Choh Ma Ngoy Moon Pock Da Fun Sau motion, many principles are at work. 256A shows Ngoy Moon Pock Sau used to trap the opponent’s shoulder, pushing him into a forearm smash. Also very importantly, this movement puts the trainee into an Outside Facing relationship to the opponent—a position that can be used to gain Facing advantage as was seen in Photo D

## San Sau—Practical Applications

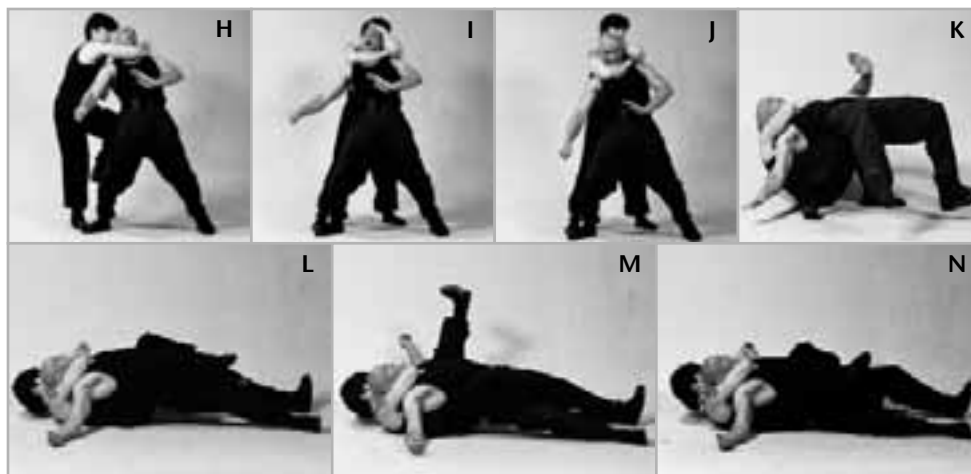
of 247A, or as in 256B, where Fighter A steps and turns away from the Centerline to avoid the power of a kick without sacrificing Facing advantage. The altered structure of the Pock Sau, shown close up, can also enable the Wing Chun fighter to use the Slap Block to “pass” an incoming hook punch before attacking from the newly-exposed Dead Side of the opponent.

**256A**—*Photo A*—Fighters are in an Open relationship. *Photo B*: B’s jab is blocked by A’s left Boang Sau. *Photo C*: Fighter A uses a wheel-like rolling motion to trap B’s extended arm and pull him into an Inside Whip punch to the face. *Photo D*: Jerking B further off-balance with his right hand and taking a small left sidestep to the left, Fighter A uses Ngoy Moon Pock Sau to shove B into the oncoming forearm strike, and to brace his shoulder to prevent him from moving away from its force. *Photo E*: Turning his right hand over to a Lon Sau Pon Geng Sau to trap B’s neck from behind, Fighter A attacks the temple with a headbutt. *Photo F*: Fighter A then begins to slip his right arm around B’s neck, lining his own elbow up directly under B’s chin. *Photo G*: A then slides his rear right foot up to meet his own left... *Photo H*: ...then kicks the back of B’s right knee with Pock Gyeuk to break down his stance, causing him to roll further into the choke. *Photo I*: To complete the choke, A places his right palm on his own left bicep and uses his left hand to pull B’s head back, exposing the throat. *Photo J*: Before B can counter by rolling or side-stepping, Fighter A takes a small backward step with his left foot... *Photo K*: ...and continues moving backward until he takes B to the ground. *Photo L*: Maintaining the choke, Fighter A uses a double Jut Gyeuk motion to first hook both of B’s legs from the insides... *Photo M*: ...and then another Jut Gyeuk to attack B’s groin... *Photo N*: ...with an adductive heel kick.





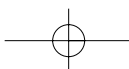
### Close Range Combat Wing Chun: Volume Three



**256B**—*Photo A:* Fighters face off in a Closed relationship *Photo B:* As Fighter B attacks with a high rear Round Kick, Fighter A steps off away from the kick to an Outside Facing relationship as he guards his head with a counterturned Woo Sau. *Photo C:* In one continuous motion powered by the lunging stepoff, Fighter A finishes the jumping Teo Loy Tiu Gyeuk counterkick to the back of B's base leg.



**Fig. 257**—*Fon Sun Boang Sau Huen Jing Gyeuk, a Complex Kicking Defense, shown from overhead.*

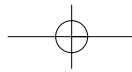


San Sau—Practical Applications

257A—*Photo A:* Fighters ready. *Photo B:* Fighter B stops A's left Jab with his own right Jom Sau. *Photo C:* Fighter A steps forward and pivots to the outside with Ngoy Seen Wai Outside Facing footwork as he threads his right Ngoy Doy Gock Kuen over his own left arm to exclude B's blocking arm. *Photo D:* Using the Fon Sun principle from Movement 28 of the form, Fighter A turns back in to face B as he grabs, punches and kicks the side of the knee. *Photo E:* Fighter A then grabs B's hair... *Photo F:* ...and begins to pull B backwards... *Photo G:* ...to expose the throat to a Chum Jahng downward elbow smash.

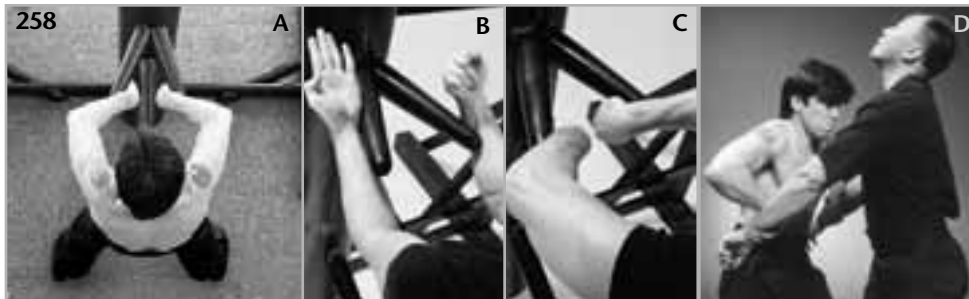


**Fig. 258**—The swing up of the wrist that begins Movement 32 of the form represents the shaking motion of the High Fook Sau in Look Sau Rolling Hands, where both partners use a sharp sideward snap of their wrists at the top of the Riding Hand Cycle as is seen in 258A. This snap is used to create forward energy in the high Fook Sau without unnecessary muscular tension. The resulting Syeung Huen Sau, also called Kwok Sau, or “Spreading Hands,” is used to open the Centerline for attack. This can be applied in double form, as seen in series 258B and C, or with only one hand at a time with offset timing as was seen earlier in fig. 246A, where Fighter A first converted his left Jom Sau into a continuous circular envelopment that drilled in to strike the low line with Bau Ja Ging (Explode Power) gathered from the “load-up” and release of the wrist. When Huen Sau is used to circle into the low “Spade Palm” strike, the resulting combination is known as Huen Gwot Sau, or “Circling Wiping Hand.” A Huen Sau circle of the left hand was also used to go around and under the opponent’s arm in fig. 252C, where Fighter A snaps his wrist inward to circle under B’s extended left arm while gathering power for the Chahng Dai Jyeung strike to the body. A defensive application

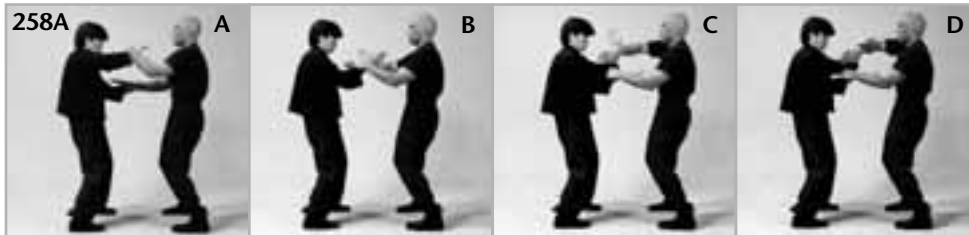


**Close Range Combat Wing Chun: Volume Three**

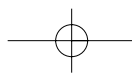
of the double Chahng Dai Jyeung is illustrated by 258D, where Fighter A cuts off the opponent's knee attack at its source by jamming her hips with the palm heels.



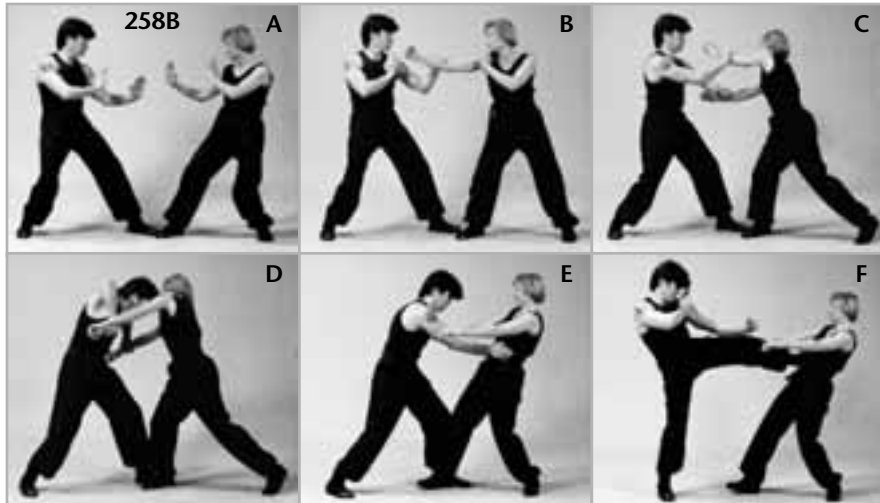
**258A**—*Photo A:* Partners are in an Equal relationship in the Look Sau Rolling Hands Cycle. *Photo B:* As the first rolling cycle begins, Partner A starts to turn his right Boang Sau over as his left wrist clings to B's right hand, which is itself beginning to flip over from its from previous Tan Sau position. *Photo C:* As the rolling cycle nears completion, Partner A's left wrist has reached its fully chambered position... *Photo D:* ...which is unloaded with a sharp forward/sideward of the wrist into High Fook Sau position at the top of the new rolling cycle.



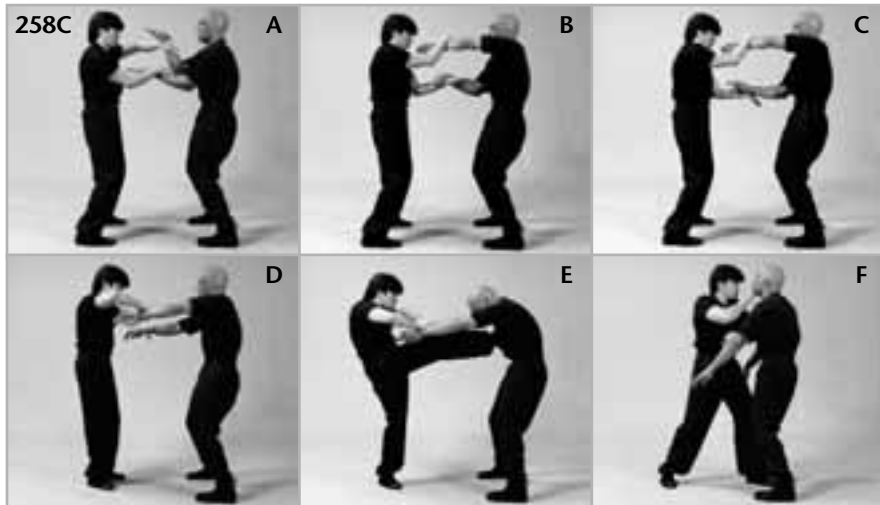
**258B**—*Photo A:* Fighters are in an Open relationship. *Photo B:* Fighter A stops B's jab with Pock Sau. *Photo C:* Keeping the first hand trapped, A stops B's second punch with another Pock Sau. *Photo D:* Maintaining both grabs and converting them to a Kwok Sau double Hooking Trap to pull the opponent in as he spreads her arms apart, Fighter A steps forward with a headbutt down the now-open Centerline. *Photo E:* Unloading the wrists, which were chambered by the Kwok Sau action, Fighter A completes the double Huen Gwot Sau attack to the midsection. *Photo F:* A then finishes her off with a Front Kick.

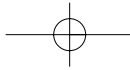


San Sau—Practical Applications

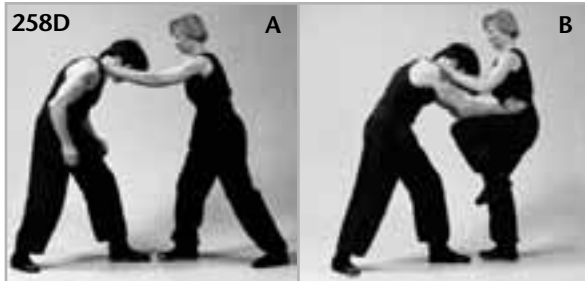


258C—*Photo A:* Partners are in Look Sau position. *Photo B:* Both partners complete one rolling cycle. *Photo C:* Partner A begins what appears to be a left Tan Sau switch... *Photo D:* ...but instead circles his hand around B's right wrist to become the left half of Kwok Sau as his right Fook Sau is also converted to Huen Sau. *Photo E:* When the Centerline is completely opened by his double Huen Sau motion, Fighter A kicks up through the middle... *Photo F:* ...then uses his descending momentum to add power to his punching attack as he plants his foot forward between B's feet and uses his left arm as a Lon Sau Layover Trap.





### Close Range Combat Wing Chun: Volume Three

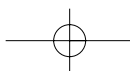
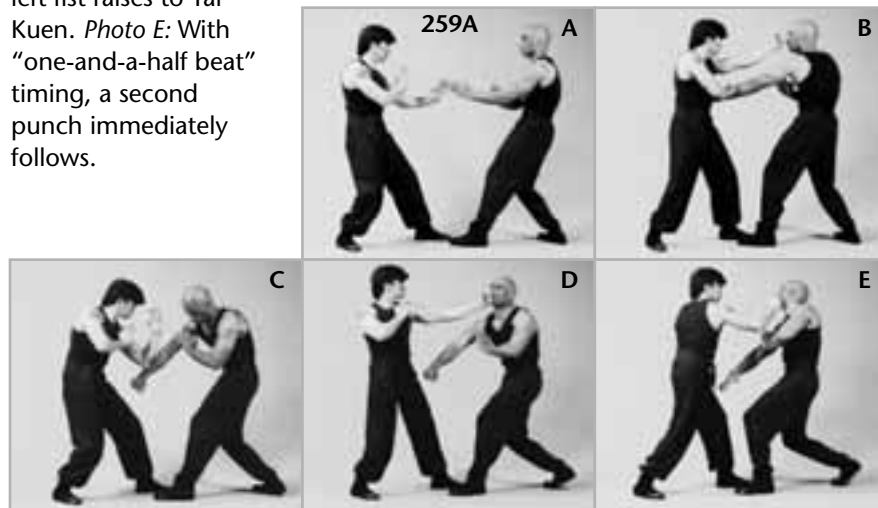


**258D**—*Photo A:* The opponent traps A's neck with both hands. *Photo B:* As B brings her left knee up to strike, Fighter A strikes both hips with a double low Chahng Dai Jyeung "Spade Palm" strike to stop the attack at its source.



**Fig. 259**—*The double, backward-pulling version of Jom Sau teaches the trainee to apply inward/backward pressure on the opponent's forearm to trap his hands or to block a strike with a retraction of his own extended arm as in 259A. It can also be used as a Double Block to stop a powerful round attack such as in 259B, where Fighter A uses double Jom Sau to stop a wide, looping hook punch.*

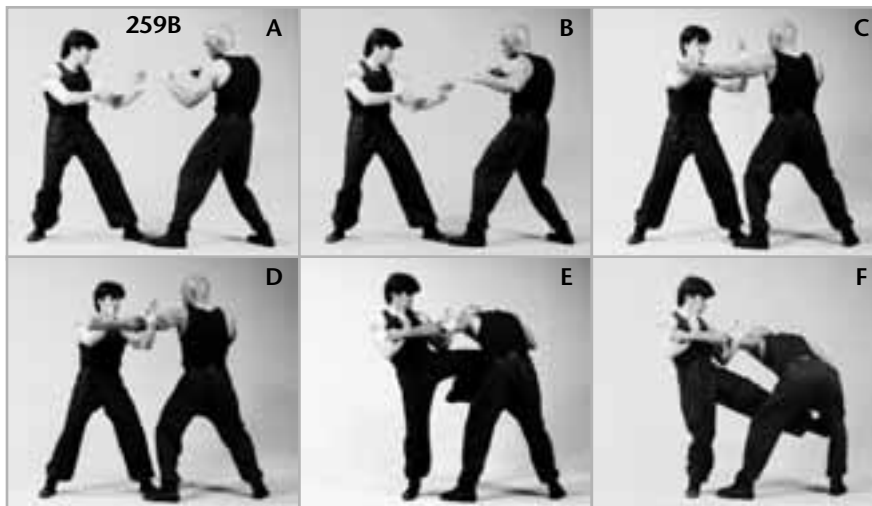
**259A**—*Photo A:* Fighters ready. *Photo B:* Pock Da is used to stop the jab. *Photo C:* The opponent then attempts a palm-down Chop Kuen to attack the opening created by A's punch. Fighter A uses a retraction of his extended punching arm to Chum Jahng position to both block and attack the opponent. *Photo D:* Bouncing straight in and upward after the block, Fighter A's left fist raises to Tai Kuen. *Photo E:* With "one-and-a-half beat" timing, a second punch immediately follows.



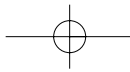


### San Sau—Practical Applications

**259B**—*Photo A:* Fighters are in a Closed relationship. *Photo B:* As Fighter B retracts his left fist to punch, A reads the “telegraph”... *Photo C:* ...and meets B’s hook with double Jom Sau. This two-handed block stops the punch as it attacks the punching arm. *Photo D:* After the punch has been stopped, Fighter A slips his left arm under B’s extended arm, catching it just behind the elbow with a reverse Woo Sau Wrap. *Photo E:* Using the armlock as a lever, Fighter A pulls B forward into a knee strike. *Photo F:* Without putting his foot down between kicks, A continues the leg motion by kicking B’s the inside of B’s rear right knee with Moh Ying Jing Gyeuk.

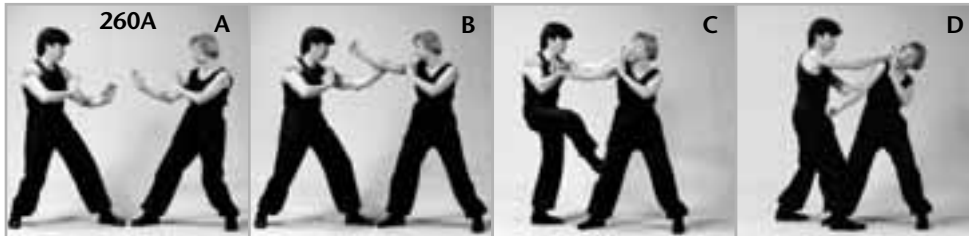


**Fig. 260**—*Tan Da Kup Yai Sut* introduces the knee-stomping kick as well as the concept of simultaneous blocking, striking and kicking known in CRCA Wing Chun as a “Complex Kicking Attack.”



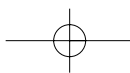
**Close Range Combat Wing Chun: Volume Three**

**260A**—*Photo A:* Fighters face off in an Open relationship. *Photo B:* A stops B's jab using Pock Sau. *Photo C:* Fighter A then takes over the trapping duty from Pock Sau as he counterattacks on two levels with Tan Da Kup Yai Sut. *Photo D:* Plant/Trap/Hit.

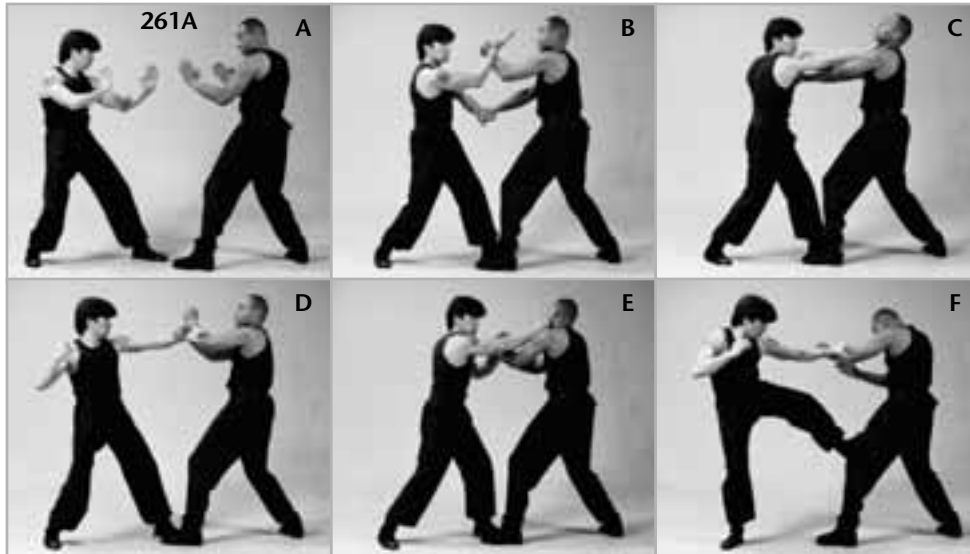


**Fig. 261**—*The circling Huen Fook Sau motion executed with a Sau Kuen chamber of the other hand can be used to put the opponent into a type of reversal known in CRCA Wing Chun as the "Stupid Trap," or can simulate a thumbless, whipping cross grab made without prior Bridge Contact. Examples of both are seen here.*

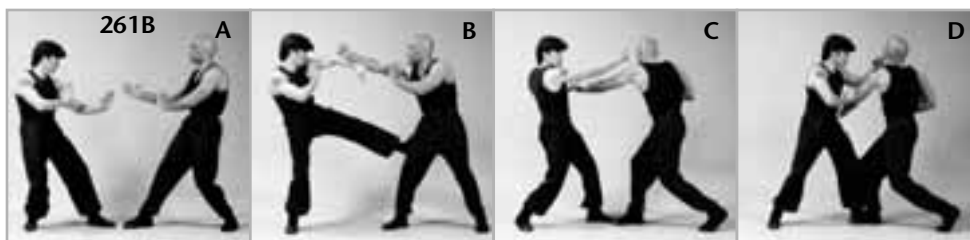
**261A**—*Photo A:* Fighters are squared-off. *Photo B:* As B attempts a Pock Da Slap and Strike, Fighter A collapses his left hand in a "Sinking Bridge" motion to absorb most of the shock, while blocking with his own right Jom Sau. *Photo C:* Using Tuet Sau principle, without losing Bridge Contact, Fighter A slides his right arm down along B's left to attack with Fun Sau. Note that this was made necessary by the fact that A could not free his left hand to take over the trapping duty from the right, as would normally be the case. *Photo D:* Using the spent right Fun Sau to guide B's left arm inward and downward into the trap, Fighter A uses the Huen Fook Sau motion as a Trapping Reversal, circling his still-trapped left hand first upward, then outward to grab B's left forearm from beneath. This action creates what is known in CRCA Wing Chun as the "Stupid Trap." As this trap is being applied, Fighter A is also chambering his right hand for a punch. *Photo E:* Since B is too stupid to let go, Fighter A punches him. *Photo F:* Although the opponent has finally released his grab, Fighter A maintains his left grip on the arm, takes a small sidestep to the right with his right foot, and kicks B's left knee from the outside.



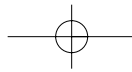
San Sau—Practical Applications



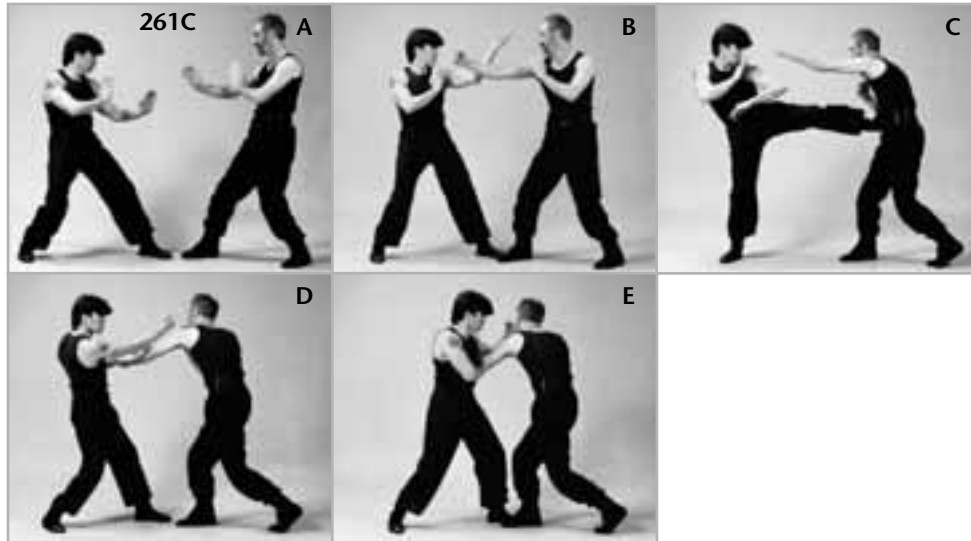
**261B**—*Photo A:* Fighters are in an Open ready position. *Photo B:* Fighter A meets B's jab with a simultaneous Boang Sau/Wahng Gyeuk. *Photo C:* As Fighter B throws a second punch, A snatches it out of mid-air with a Fon Sau Whip Grab and plants his foot to add momentum to his right punch. *Photo D:* Moving in and behind B's leg, Fighter A retraps and punches him again.



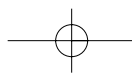
**261C**—*Photo A:* Fighters square off in an Open relationship. *Photo B:* Fighter A stops B's jab using Jom Sau. *Photo C:* As A senses B's rear cross coming, he leans back and meets B mid-motion with a Jeet Wahng Gyeuk Side Stopkick. *Photo D:* As he plants the kicking leg, Fighter A uses a Fon Sau whip grab to trap B's still-extended left punching arm, pulling him into a counterpunch. *Photo E:* Fighter A continues the attack by stepping in with Toh Ma Gum Da.



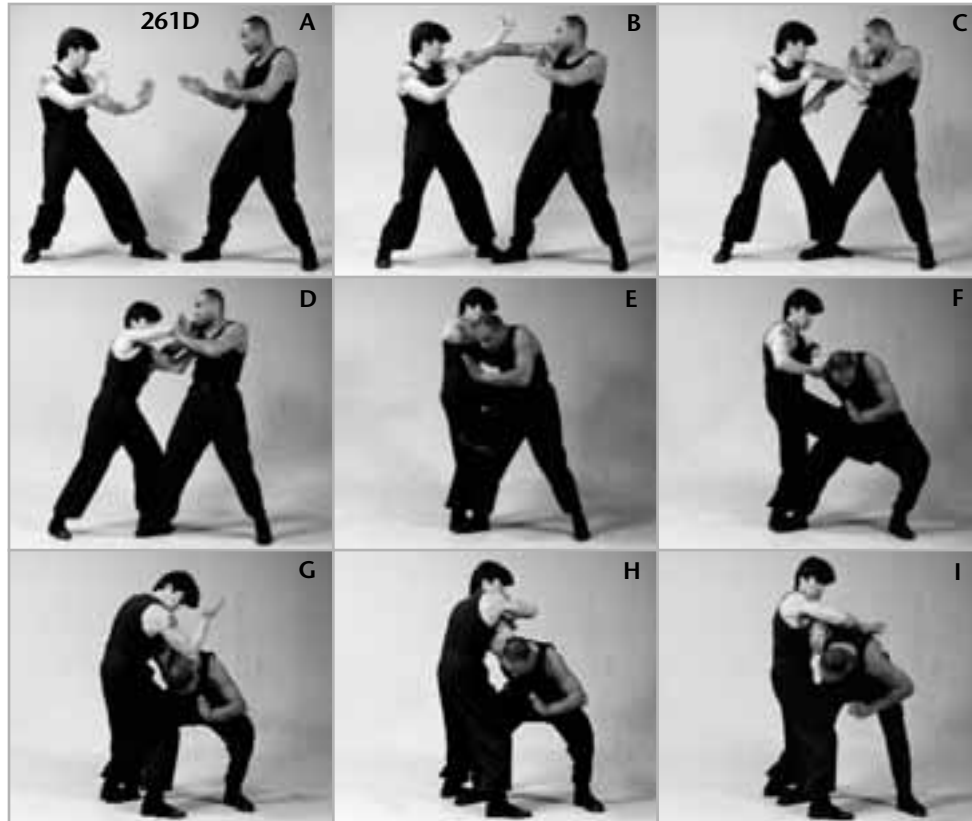
Close Range Combat Wing Chun: Volume Three



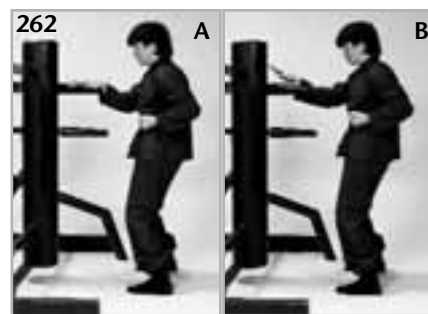
**261D**—*Photo A:* Fighters are in an Open relationship. *Photo B:* Fighter A's jab is stopped by B's right Boang Sau. *Photo C:* Stepping slightly forward and to the outside, Fighter A matches the 135° angle of B's arm and "leaks" over the top of it with a Gum Jyeung attack to the body. *Photo D:* Fighter A uses Huen Fook Sau structure as he reaches through to place his left palm on B's right shoulder, then places his own right palm on top of his left hand. *Photo E:* Using the two-handed shoulder trap to pull the opponent downward, Fighter A drives his right knee up to attack the body. *Photo F:* Without putting his foot down between motions, A then kicks the inside of B's rear knee with Moh Ying Jing Gyeuk. *Photo G:* Using his descending momentum for additional power, Fighter A drops a Chum Jahng Sinking Elbow strike down on B's spine. *Photo H:* Still keeping B's shoulder trapped with his own left arm, A then grabs B's right wrist, which is already behind his back. *Photo I:* Using a motion from the Chum Kiu form, Fighter A sharply pivots to break the arm.

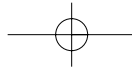


San Sau—Practical Applications



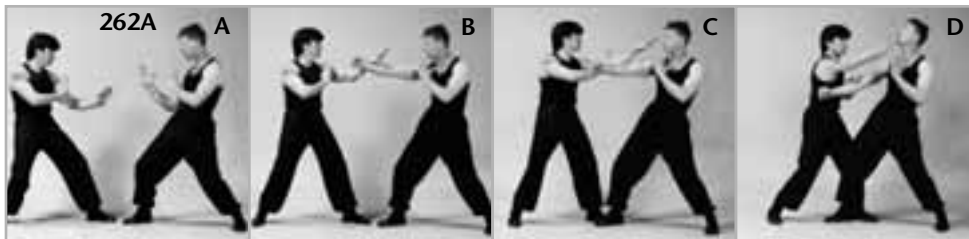
**Fig. 262**—The Loy Jut-Biu Sau Combination in Application. As the opponent launches a leading right straight punch, Fighter A counters that attack with an inward-circling Loy Jut Sau (photo B), which leaves him “set-up,” clearing the line for a follow-up Biu Jee Sau, taking over the trapping duty with Woo Sau while simultaneously delivering the blinding return-fire (photo C). The excluding power of Biu Sau is also seen in photo B of series 262B, where it is used to deflect a punch off the Centerline. Even in cases where the opponent’s punch and the Biu Sau defense are both executed with equal power, angulation and leverage, the two motions will often cancel each other out on the Centerline, which implies that the Biu Sau has successfully defended that line.



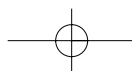
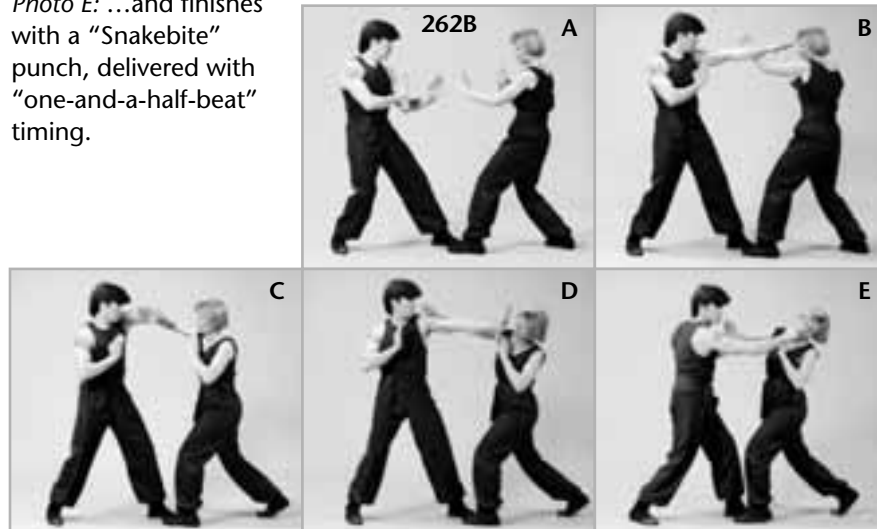


### Close Range Combat Wing Chun: Volume Three

**262A**—*Photo A:* Fighters are in an Open relationship. *Photo B:* A uses his left Fook Sau to stop B's jab. *Photo C:* In a lightning-fast Switchtrap, Fighter A uses Woo Sau to push B's arm across the Centerline as he shoots the left hand in to attack the eyes with Biu Jee Sau. *Photo D:* Although the Woo Sau was angled 45° off the Centerline to create a Cutting Angle, it is also coincidentally angled perfectly to drive straight in to become a Jing Jyeung Vertical Palm Strike, executed here with a Gum Sau retrap.



**262B**—*Photo A:* Fighters are in a Closed ready position. *Photo B:* Fighter A stops B's jab using Biu Jee Sau, which also attacks the eyes as it deflects the punch to the outside. *Photo C:* As B attempts to attack the now-open side of A's head with a looping hook punch, Fighter A quickly brings his left elbow upward and backward to meet the punching arm in an "attacking defense." *Photo D:* Driving the left palm directly inward with "bounce-off" energy, Fighter A counterattacks with a Vertical Palm Strike to the face... *Photo E:* ...and finishes with a "Snakebite" punch, delivered with "one-and-a-half-beat" timing.

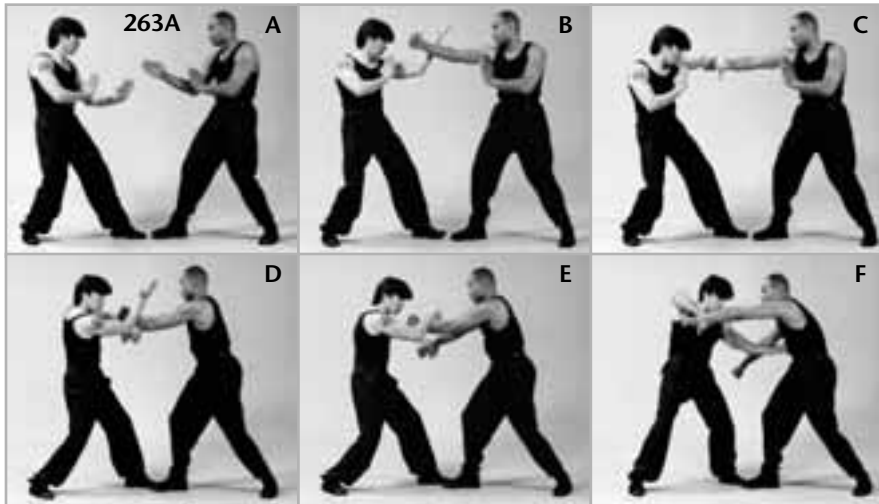


San Sau—Practical Applications

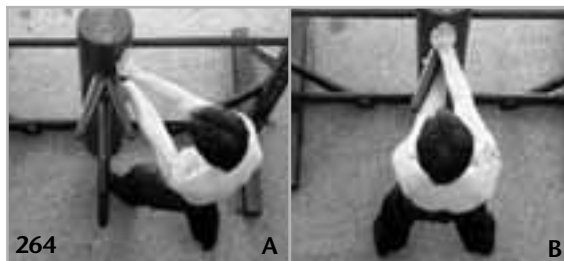


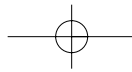
**Fig. 263**—Using the Loy Seen Wai footwork from a position of Bridge Contact with Jom Sau and converting that hand into the hook-trapping half of Huen Da Chahng Jyeung in the form teaches the trainee how to carry the opponent’s hand across the Centerline in an application known as Gwot Sau (photos B & C). This motion should not be confused with the Giu Sau error that results from forcing the opponent’s hand across the Centerline during his striking attempt; Gwot Sau sweeps are only used to manipulate an arm that is no longer “carrying power.”

**263A**—Photo A: Fighters Ready. Photo B: Fighter A stops B’s right jab with Jom Sau. Photo C: A begins a Huen Gwot Sau scoop to open the Centerline... Photo D: ...but ends up “opening a can of worms” and has to stop the cross with Loy Kwun Sau using offset timing. Photo E: Fighter A begins to convert his right Jom Sau into a second Gwot Sau scoop... Photo F: ... to open the low line for a low left “Spade Palm” attack.



**Fig. 264**—Appearing in the Dummy form with both Seep Ma and Jing Ma footwork (both versions shown here from overhead), Poh Pai Jyeung is a blend of Jing Jyeung and Pau Jyeung. One application of this “chest-smashing”





### Close Range Combat Wing Chun: Volume Three

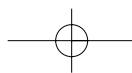
motion is shown in fig. 264A. Many ways of moving into the twin palm strike from Boang Sau position based on two Seep Ma versions from the 108 are also possible, with the Boang Sau arm dropping to become the lower half of Poh Pai Jyeung as it does in Movement 41 of the form, or becoming the top half of a double strike as in Movement 43.

#### 264A



*Fig. 265—Using Gahng/Jom Sau with offset “one-and-a-half-beat” timing allows the Wing Chun fighter to stop two closely timed punches from the opponent and immediately follow up with a counterattack. In series 265B, an application of the triple Gahng/Jom sequence from the form is seen.*

**265A**—Photo A: Fighters are in an Open relationship. Photo B: Fighter A stops B’s jab with Jom Sau. Photo C: Using the first Jom Sau as a Gwot Sau carry to bring B’s right arm to the low line in Gahng Sau structure, Fighter A stops B’s cross with a second Jom Sau Chop Block. Photo D: Sliding his right hand directly in from its previous blocking position to check B’s arm, A attacks his throat with Fun Sau. Photo E: Then, sliding the right hand back down B’s arm to keep it checked, Fighter A shoots Jing Jyeung to the face. Photo F: Another Jing Jyeung finishes the engagement.

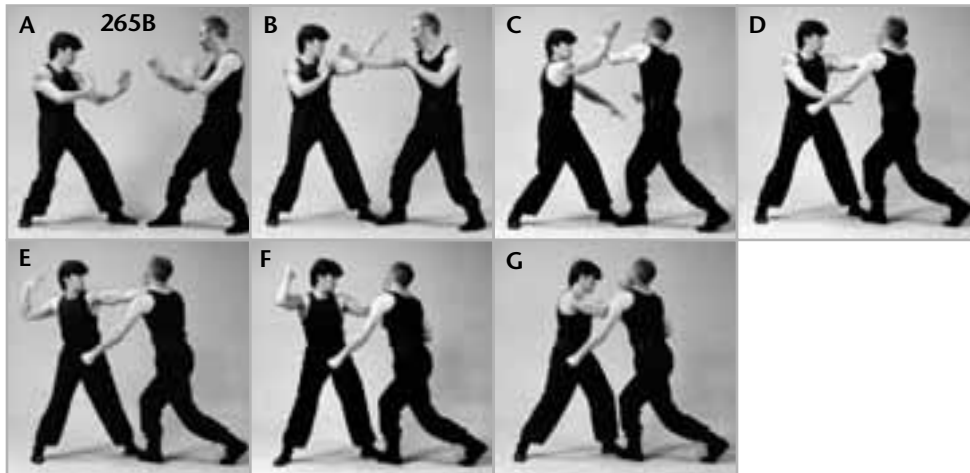




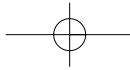
San Sau—Practical Applications



**265B**—*Photo A:* Fighters face off in an Open ready position. *Photo B:* A stops the jab using Jom Sau. *Photo C:* Again using the Gahng Sau half of Gahng/Jom Sau as a Gwot Sau, Fighter A carries B's spent punch to the low line as he meets the second half of B's "one-and-a-half-beat" punching attack with his own "one-and-a-half-beat" Jom Sau defense. *Photo D:* In another Gwot Sau application of the Gahng/Jom Sau motion, Fighter A carries the second spent punch to the low line and uses the chopping half of the Complex Motion as an attack to the throat. *Photo E:* Converting the chop to a Pon Geng Sau neck trap, Fighter A draws his right hand back... *Photo F:* ...twisting it to add Juen Ging Drilling Power... *Photo G:* ...to a second chopping attack to the neck.

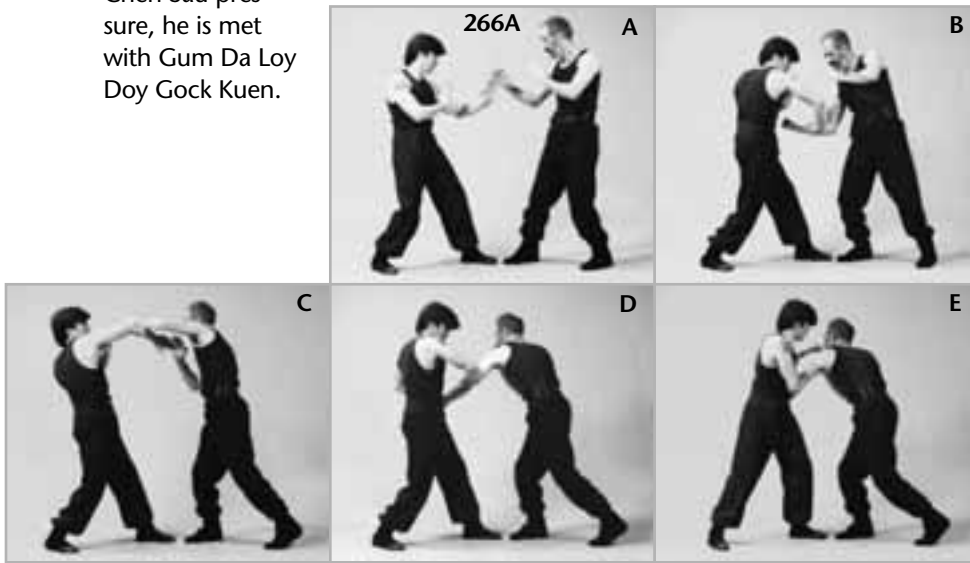


**Fig. 266**—In series 266A, Fighter A uses Raising Boang Sau to quickly defend against a second punch with a conversion of his Gum Sau blocking hand. In 266B, a simultaneous pulldown of the trapped arm and Raising Boang Sau work together to attack the elbow joint of a locked out arm.

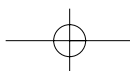
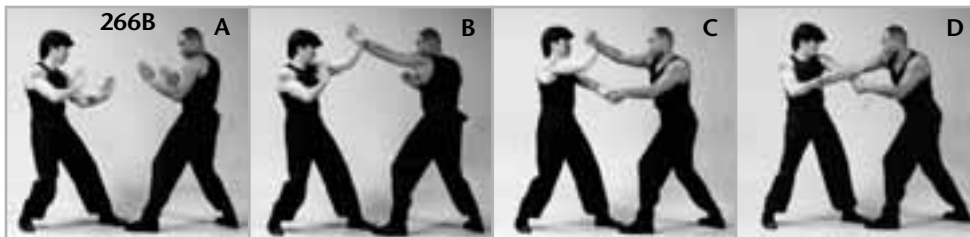


### Close Range Combat Wing Chun: Volume Three

**266A**—*Photo A:* Fighters are ready in an Open relationship. *Photo B:* Fighter A uses his own rear right Gum Sau to stop B's uppercut. *Photo C:* As B's rear cross comes in, Fighter A uses Raising Boang Sau as an emergency defense. *Photo D:* With a circular Lop Sau trapping motion to grab the wrist of the blocked arm, Fighter A uses his right palm to hyperextend B's arm, pulling and pressing him downward with Cheh Sau. *Photo E:* As B stumbles forward as a result of A's Cheh Sau pressure, he is met with Gum Da Loy Doy Gock Kuen.



**266B**—*Photo A:* Fighters ready. *Photo B:* Fighter B's left jab is stopped by A's Woo Sau. *Photo C:* Without losing Bridge Contact, B converts his left punch into a grab and pulls Fighter A into a second punch, which is again blocked by another Woo Sau. *Photo D:* Sensing that the opponent will not release his left grab, Fighter A converts his right Woo hand to a grab that sharply locks out and pulls B's right arm downward to be broken as Raising Boang Sau snaps upward to meet it at the outer elbow joint.

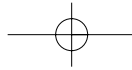


## San Sau—Practical Applications

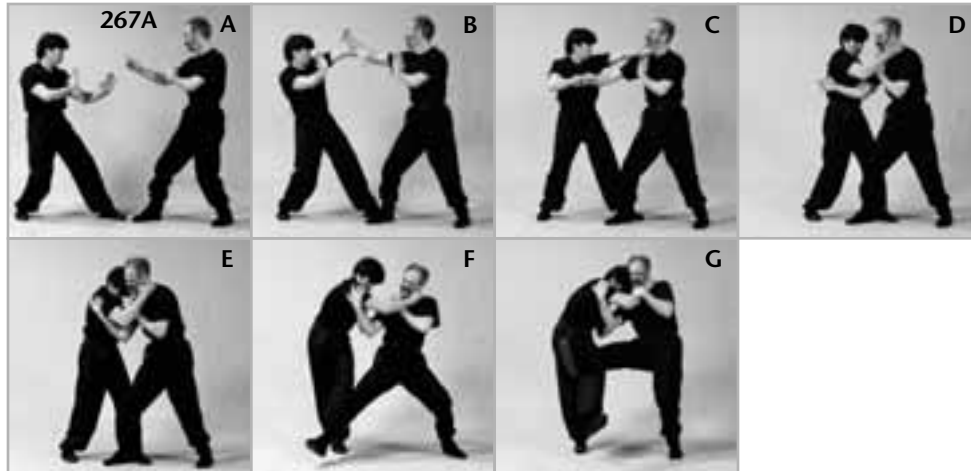
**Fig. 267**—Practical Application of the Lop/Fun/Jut/Chahng Sequence. The simultaneous trap and chop seen from above and subsequent retrapping jerk into a “Spade Palm” attack teaches the trainee how to apply the Syeung Lon Sau/Syeung Fun Sau/Syeung Lon Sau sequence from the Siu Leem Tau form as well as line-changing footwork. In series 267A, Fighter A moves from Boang Sau (photo B) and steps his left foot outside to the left while converting the right hand to a thumbless grab that pulls B into a Fun Sau Outward Chop and a follow-up Retrap/“Spade Palm” attack. The Inside Facing Loy Seen Wai footwork from this section of the form is used in series 267B, as Fighter A steps and pivots inward to face the new Centerline created by that step while delivering a renewed trapping attack. This technique illustrates how the Wooden Dummy form encourages the student to be conscious of the Centerline, and to manipulate that line in combat. In this case, the line was changed and the opponent was hit from a new angle. By the time he realizes that the line had been changed and could react to that change, Fighter A will already have changed back to the old line and reattacked. As was explained in the Centerline Theory essay of Volume II, changing the line in this manner can create openings in an otherwise airtight defense.



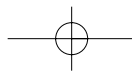
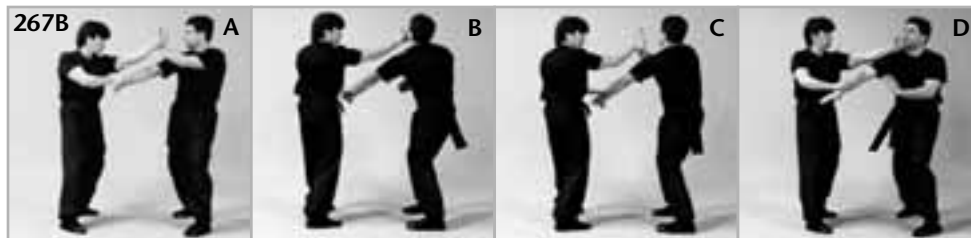
**267A**—Photo A: Fighters are ready in an Open relationship. Photo B: A stops B's jab using Boang Sau. Photo C: Fighter A step/slides slightly forward and behind B's lead right leg as he smoothly flows into Lop/Fun Sau. Photo D: Taking another small shuffling step, A then retraps and reattacks the throat with Gum Da Chahng Jyeung. Photo E: Converting the “Spade Palm” to a Pon Geng Sau neck trap, Fighter A holds B's head in position for a headbutt attack to the temple. Note that at this point, the inner arch of A's foot has been placed behind and around B's right heel. Photo F: Keeping the neck and turning the left hand to become a palm-up Pau Sau grab for better control, Fighter A sweeps B's leg out. Note that A keeps his sweeping foot low to the ground for better leverage. Photo G: The sweep is completed.



### Close Range Combat Wing Chun: Volume Three



**267B**—*Photo A:* Fighter B has blocked A's Choh Ma Lop Da attack using Woo Sau. *Photo B:* It is possible to simply grab the Woo Sau hand and pivot into another punch, as is seen here. *Photo C:* But the opponent will often pivot into another Woo Sau block. *Photo D:* When this happens, Fighter A uses a Loy Seen Wai step to gain Facing advantage as he pivots into another grab and punch. This technique illustrates how stepping to a new line and turning to face that line can be applied, as Fighter A senses that he is "whipping a dead horse" by continuing to attack a well defended line. Rather than to attempt a third attack on the same line that is likely to be blocked, A instead traps the opponent's hand, steps to a new line and turns to face that line with an obliquely angled Cheh Kuen from a position of Centerline and Facing Advantage.



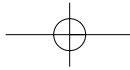
## San Sau—Practical Applications

**Fig. 268**—Besides illustrating to the practitioner that both the heel of the hand and the heel of the foot reference to the Centerline in striking, the *Tan Da Chahng Dai Jyeung Yai Hau Gyeuk* Complex Kicking Attack teaches the trainee how to put all of his Yang energy into the same side in both the upper and lower pyramids without losing balance or power. This is seen in photo 268A, where Fighter A uses a simultaneous right punch/right kick. This “same side hit/kick” idea is almost never used without prior Bridge Contact, as the opponent’s power is still largely unknown before contact is made. But used as a Takeover Trapping follow-up as in 268B or against the second of a “one-two” punching combination, it is safe and effective to hit and kick on the same side. In series C, Fighter A uses *Yai Hau Gyeuk* to kick out the opponent’s rear leg from behind, although using the *Yai Hau Gyeuk* principle does not always necessarily mean kicking the opponent’s rear leg from behind. Another important concept that this motion illustrates is the idea of substituting a kick for the various “syllables” of footwork of the *Seep Ma Tan Da Chahng Dai Jyeung*. If the position of the upper body in Movements 5, 34 and 58 in the Dummy form are compared, it will be seen that they are identical. The only differences are in the lower pyramid, where a kick takes the place of either the arc-step or sliding recovery step of the *Seep Ma* motion. This concept was explained in more detail under the *Jing Gyeuk* heading of the Eight Kicks of Wing Chun essay in Volume I of this series.

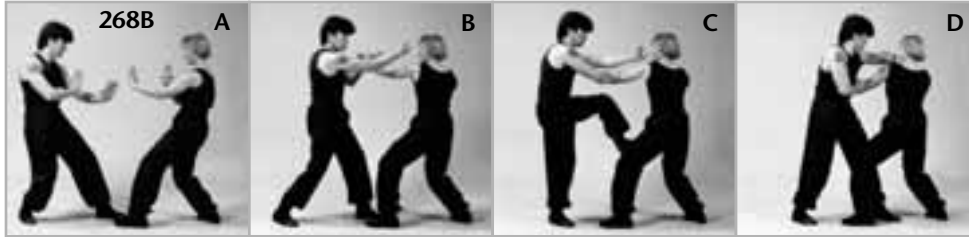


268A

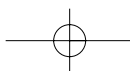
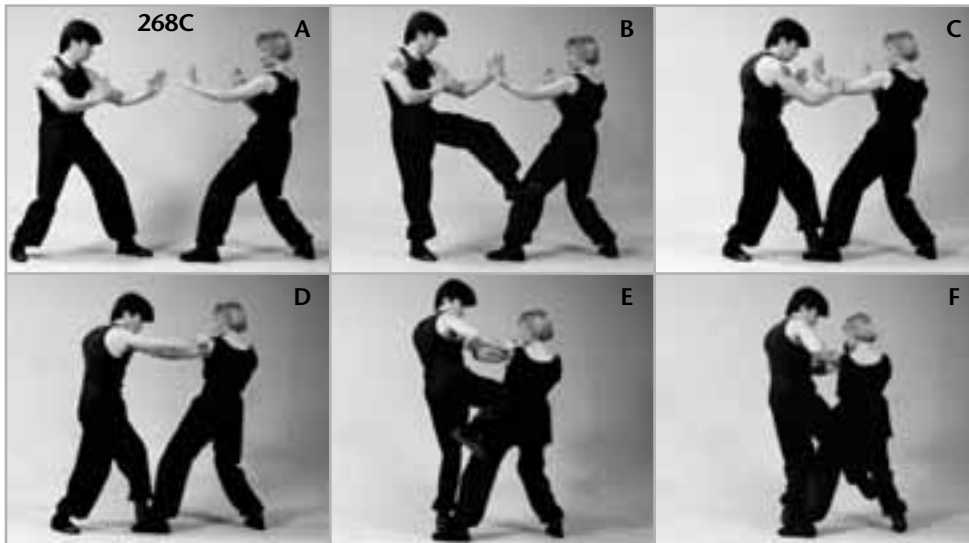
**268B**—Photo A: Fighters ready. Photo B: Fighter A meets B’s left jab with *Tan Da*. Photo C: In a less-commonly seen application of same side hitting and kicking, Fighter A switches the trapping duty and attacks with *Pock Da Jing Gyeuk*, with the punch and kick both executed from the left side. This is made possible by the fact that the majority of B’s forward momentum was stopped by the initial *Tan Da*, thus making it much safer to use both the counterpunch and kick from the same side on the second “syllable.” Photo D: Capitalizing on his descending momentum after the kick, Fighter A plants, traps and strikes with a *Pai Jahng Hacking Elbow* to the face.



### Close Range Combat Wing Chun: Volume Three



**268C**—*Photo A:* Fighters Ready in Closed position. *Photo B:* Fighter A skips in with a Teo Jing Gyeuk attack to the knee. *Photo C:* Trapping B's left arm with Pock Sau, Fighter A scrapes and stomps her lead shin and instep with Chai Jing Gyeuk, ending up with her foot pinned to the floor by Gum Gyeuk in Lau Sut Soh structure. *Photo D:* Keeping her foot pinned, he traps her shoulder... *Photo E:* ...and pulls her backward into an inward knee strike to the spine. *Photo F:* Without putting the foot down between kicks, Fighter A swings his right leg down to attack B's rear leg using the Yai Hau Gyeuk motion from the form.



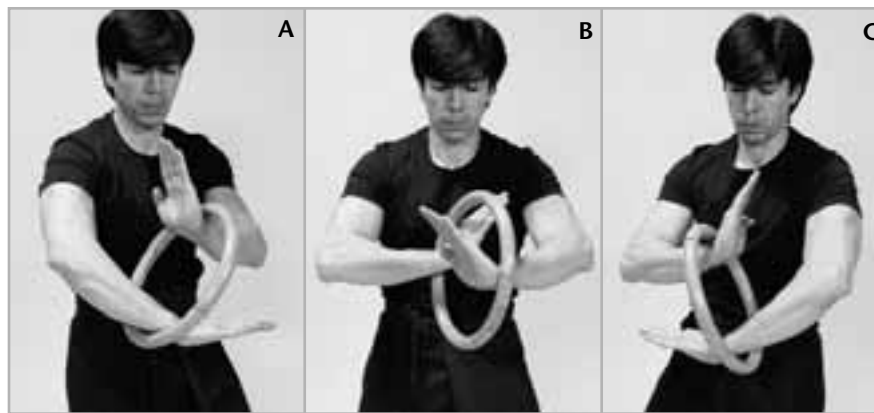
San Sau—Practical Applications

**Part II**

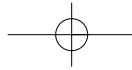
**Fig. 269**—The inward-twisting, downward-pressing Gum Sau motion, seen in series A with the Rattan Ring, can be used in a variety of ways to block and/or trap the opponent's position. In photo B of series B, Fighter A uses Gum Sau to block a low-line punch, then shoots his hand directly forward and upward to block a second punch with the "bamboo springback" action of Fock Sau. Another function of Gum Sau is to act as a "Conversion Press" from prior Bridge Contact in another hand formation. For example, in Gwoh Sau practice, if the opponent begins to raise his "riding" hand in anticipation of the Tan hand converting to Boang, the Tan hand can instead circle outside that riding hand to weave the opponent's arms into a trap as it becomes the downward-pressing half of Gum Da. Gum Sau is also very often used in Plant/Trap/Hit follow-ups after kicks, as has been seen many times throughout this series and will be illustrated again in fig. 271.



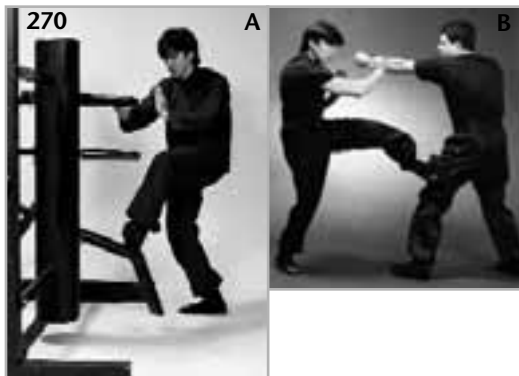
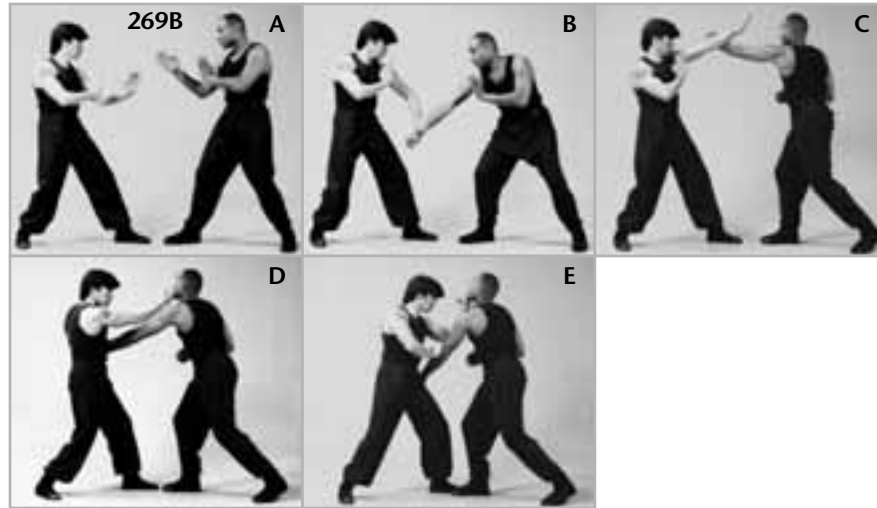
**269A**—Gum Sau with the Rattan Ring.



**269B**—*Photo A:* Fighters are in an Open relationship. *Photo B:* Fighter A defends against B's lead right Chop Kuen using his own left Gum Sau. *Photo C:* As B tries to reattack on the open high line, Fighter A uses Yut Fook Yee principle by springing up to Fock Sau with the same arm that had already blocked the first punch. *Photo D:* Without losing Bridge Contact, A converts the left block into a Lop Sau grab to pull B into a punch. *Photo E:* Fighter A retraps and punches again.



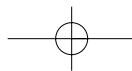
Close Range Combat Wing Chun: Volume Three



*Fig. 270—The Simultaneous slap block and knee-stomping kick of the Chai Sut Dai Gyeuk motion is seen applied here.*



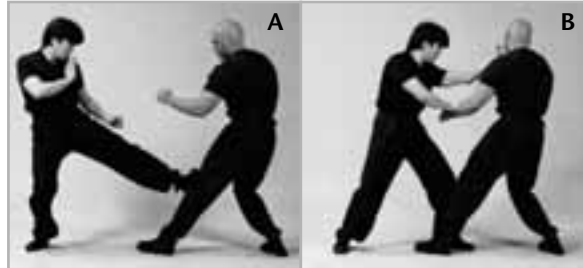
*Fig. 271—Putting the foot down and trapping the Dummy arm with the hand on the non-kicking side in Syeung Ma Gum Sau illustrates the Chum Kiu principle of putting descending momentum into a follow-up technique after a kick. Like the Chum Kiu version of Syeung Ma Gum Sau, the trainee uses the non-kicking side as the trapping hand when putting the foot down after a kick to illustrate the fact that it is almost always preferable to use the kicking side to strike on the way down, as that side will have more power due to the kicker's descending momentum, which can be channeled into the hands. This is what is known in CRCA Wing Chun as the "Plant/Trap/Hit" principle.*





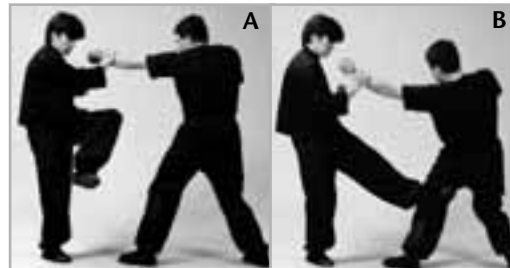
### San Sau—Practical Applications

**271A**—*Photo A:* Fighter A scores with a lead Side Kick to B's knee. *Photo B:* Using his weight and momentum to add power to his hand technique, Fighter A falls into a Plant/Trap/Hit follow-up technique.



**Fig. 272**—*Seen from above and in the application of its pure form in photo B of series 272A, Pock Sau Ngoy Tiu Gyeuk defines the correct Reference of an outward instep kick by executing it in combination with the Slap Block, whose own Reference was well established at Siu Leem Tau level. Ngoy Tiu Gyeuk is executed with Jing Gyeuk upper body structure and teaches the trainee how to deliver an effective low-line instep kick from an unexpected angle. Its inward counterpart Loy Tiu Gyeuk is seen in 272B.*

**272A**—*Photo A:* Fighter A has blocked B's punch with a right Pock Sau and chambers his left leg... *Photo B:* ...for a Ngoy Tiu Gyeuk attack to the back of the knee to break the opponent's stance. Another view is shown in *Photo C.*



**272B**



## Close Range Combat Wing Chun: Volume Three

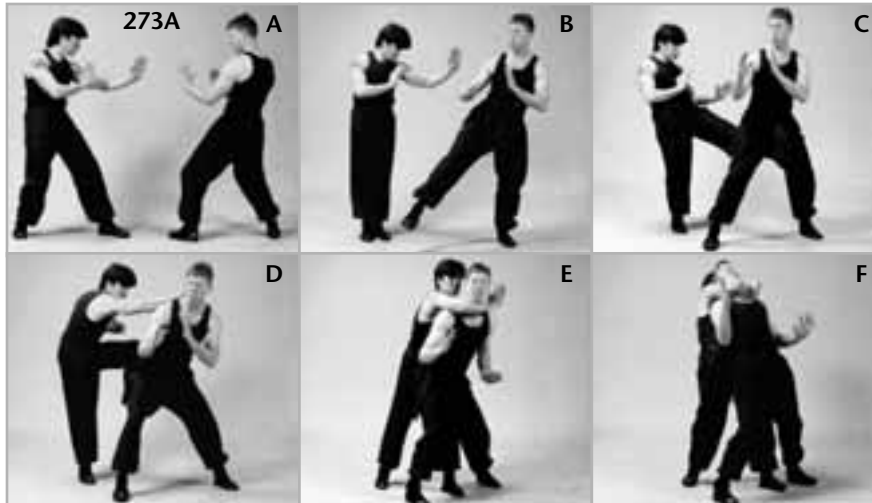


**Fig. 273**—*Jing Ngau Gyeuk, The “Straight Hooking Foot,”* named for its toes-out Jing Gyeuk structure, can be used as a follow-up attack after a kick. In series 273A, Fighter A first “ducks” B’s right low Roundhouse Kick by momentarily sliding the feet together to allow the kicking leg to pass the Centerline. The momentum of B’s kick carries him to a position of extreme Centerline disadvantage, enabling Fighter A to attack him from his “Dead Side.” After countering with his own Dung Jing Gyeuk (photo C), Fighter A adds extra damage to the blow with a hooking motion that is used to pull the opponent into an attack to the rear of the neck (photo D). The Ngau Gyeuk Hooking Foot motion can also be used for recovery from a backward fall when the opponent’s punch has caused the Wing Chun fighter to temporarily lose balance.

Using the foot to hook the opponent’s leg for stability, the Wing Chun man can keep himself from falling by “borrowing” the stability of the opponent’s stance by hooking his foot around the opponent’s knee from inside or outside. Another Jing Ngau Gyeuk application will be seen in fig. 274A.

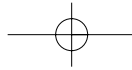
**273A**—*Photo A:* Fighters are faced off in a Closed ready position. *Photo B:* As Fighter B attempts to kick the back of his lead leg, Fighter A slides his leg back to evade the kick. This is an example of the “ducking” principle introduced by the Syeung Dai Boang Sau motion of the Chum Kiu form. *Photo C:* As the circular momentum of his failed kick causes B’s leg to cross the Centerline, Fighter A takes advantage of facing B’s “Dead Side” by kicking him from behind with a lifting Dung Jing Gyeuk to the groin. *Photo D:* Using the Jing Ngau Gyeuk Straight Hooking Foot to pull B into the strike, Fighter A punches him in the back of the neck. *Photo E:* Retracting his left foot in a scraping motion to rake through the groin area as he puts it down, Fighter A reaches around B’s neck to begin the choke, making sure that the point of his right elbow lines up directly under B’s chin. *Photo F:* Grabbing his own left bicep with the right choking arm and placing his left palm behind B’s head, Fighter A cuts off B’s blood and air flow by squeezing his elbows together and arching his back. This choking motion is rooted in the Gwai Jahng Downward-arcing Elbow of the Biu Jee form, executed in double form with both hands in unison.

San Sau—Practical Applications



*Fig. 274—Foong Ngon Kuen, the “Phoenix-Eye” Punch, seen here close-up, is used to attack vital points with the index knuckle while the rest of the fist strikes as normal. In photo E of series 274A, Fighter A applies a Pock Da Loy Fon Foong Ngon Kuen to trap the opponent’s hands and attack the base of his jaw with the sharp point of the index knuckle, which digs in deeper as the other knuckles smash into the side of the neck. Foong Ngon Kuen was analyzed in more detail and illustrated by Photo 28 of the Eight Punches of Wing Chun essay in Volume I.*

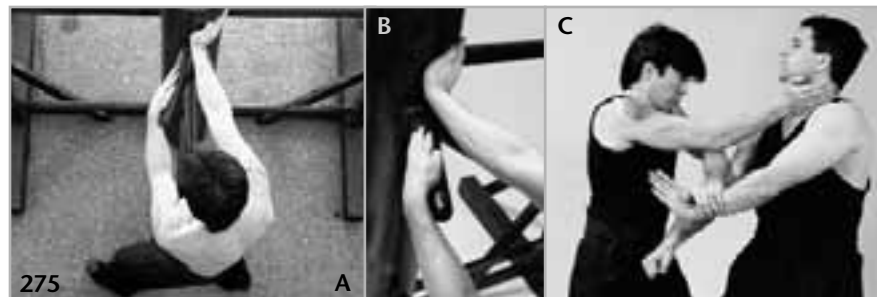
*274A—Photo A: Fighters are in an Open ready position. Photo B: Fighter B stops A’s jab with Boang Sau. Photo C: First matching the angle of B’s Boang Sau arm, Fighter A “leaks” through the gap between B’s arms to attack the body with Tuet Sau Chop Kuen from the Biu Jee form. Photo D: As he makes the first right sidestep of the three-syllable Seep Ma footwork, Fighter A traps B’s left hand with Pock Sau while beginning to circle the left fist downward... Photo E: ...and then up to a “Phoenix-Eye” Punch that makes contact in time with the second arc-stepping Seep Ma syllable. Photo F: Taking advantage of his Facing relationship to B, Fighter A then uses an upward Dung Jing Gyeuk Lifting Instep Kick to attack the groin. Photo G: Converting the kick to Jing Ngau Gyeuk, Fighter A uses his foot to pull B into a punch.*



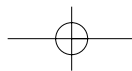
### Close Range Combat Wing Chun: Volume Three



**Fig. 275**—*Jut Da Chahng Jyeung in Application.* Fighter A uses *Jut Ging Jerking Power* to pull his opponent into a simultaneous left inward jerking trap/right “Spade Palm” thrust to the neck and jaw area.

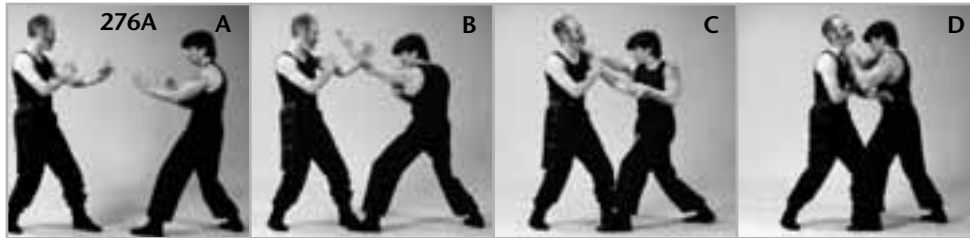


**Fig. 276**—*Gyeung Jee Kuen, the “Ginger Fist”* is seen in application here, as Fighter A turns his left *Ginger Fist* palm-up, enabling that strike to be fit in under the opponent’s jaw to smash the larynx with the scalloped edge of the flat, half-formed fist (photo D).



San Sau—Practical Applications

276A—*Photo A:* Fighters are in a Closed relationship. *Photo B:* Using his lead left Biu Joang Sau Thrusting Guard Hand to “Create Timing,” Fighter A initiates Bridge Contact. *Photo C:* Lifting his lead foot and pushing off the rear leg to “launch” himself forward, Fighter A jerks B’s arm towards himself and reaches behind his neck to trap it. *Photo D:* As his lead left foot hits the floor, Fighter A drives a palm-up Gyeong Jee Kuen knuckle jab under B’s jaw to attack the throat, still holding him by the back of the neck.



*Fig. 277—The conversion from Gyeong Jee Kuen to Jing Jyeung without retraction of the hand is designed to help the trainee develop Chuen Ging or “Inch Power.” Striking a telephone book held by a partner using punches, palms and elbows can further develop this short-distance striking power.*

277A—*Photo A:* Fighters are in a Closed relationship. *Photo B:* Fighter A uses his left Woo Sau to stop B’s left jab. *Photo C:* Without retracting the left hand before striking, Fighter A shoots it straight in to a Vertical Pam Strike. Note that the 45° angle of Woo Sau following A’s Self-Centerline leaves his left hand perfectly angled to shoot directly into Jing Jyeung. This technique also exemplifies the Wing Chun concept of striking directly off the block without retraction of the hand.



Close Range Combat Wing Chun: Volume Three



**Fig. 278**—Juen Bock Gum Jyeung is a combination shoulder slam/palm heel thrust that can be used with emphasis on either element, or with both in combination. The palm-down palm-edge thrust is seen in photo C of 278A as a downward-cutting leakage attack to the midsection while in photo D of 278B, the shoulder alone is used to break the opponent's elbow after a block. At times, both motions can work together to simultaneously break the arm and rib, striking at once while grabbing the wrist after Boang Sau has deflected the opponent's punch. A twisting Juen Bock shoulder block can also be used as a last-ditch emergency defense when both hands are "crossed-up" by the opponent's hand trap.

**278A**—Photo A: Fighters ready in an Open relationship. Photo B: Fighter B uses a right Boang Sau to stop A's jab. Photo C: Fighter A "matches Boang for Boang" to leak through B's properly structured defense with a Gum Jyeung palm edge thrust.

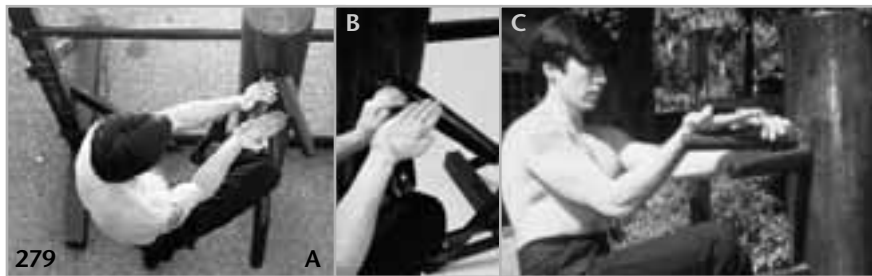


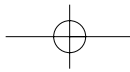
**278B**—Photo A: Fighters are squared off in an Open ready position. Photo B: Fighter B again uses a right Boang Sau to stop A's jab. Photo C: As B attempts a Lop/Fun Sau grab/chop, Fighter A defends with his own right Woo Sau. Photo D: Sensing that the opponent will not release the grab, Fighter A pulls B's fully extended striking arm forward as he twists his shoulders to add both centrifugal and centripetal force to his front shoulder punch that attacks B's elbow joint. Photo E: As B has still not released his grab, Fighter A presses B's right hand down to guide him into the "Stupid Trap" as he chambers his own right fist for a punch. Note that it is important not to pull up on the lower arm, as this action will probably cause him to release his grab, which at this point you do not want him to do. Photo F: Using B's own grab against him, Fighter A fires in the punch. Photo G: A then converts the punch into a reverse Pon Geng Sau neck trap that pulls B into a knee strike. Photo H: Without putting his foot down between motions, Fighter A swivels his right leg behind B's right leg and then kicks it out using Ngoy Jut Gyeuk.

San Sau—Practical Applications



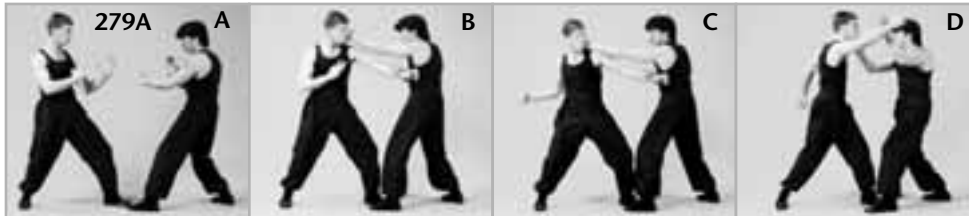
**Fig. 279**—Tan/Pock Tan Sut, the first Complex Kicking Defense to be formally introduced in the system, teaches the trainee to “execute three motions at once” as the proverb “Som Jiu Chai Doh” advises. Tan/Pock Sau, the Complex Blocking Motion of the upper pyramid in this movement, is seen in three applications in series A, B and C, as Fighter A momentarily uses both hands to block the opponent’s hook punch, backfist and Round Kick by stopping the main force of the blow with Pock Sau at the bicep or thigh while Tan Sau keeps the hand or foot from coming around the outside. In each case, the bent wrist of Tan Sau keeps that hand or foot from slipping over the blocking hand. Tan Gyeuk, the leg’s counterpart to Tan Sau is shown here used against a Round Kick. In series D and E, Tan Gyeuk is used to block an angular kick and is followed up with a “Shadowless” Jing Gyeuk. This introduces the student to the important concept of using the legs to assist the hands. More can be read on this principle in the Eight Kicks of Wing Chun essay of Volume I.



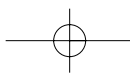
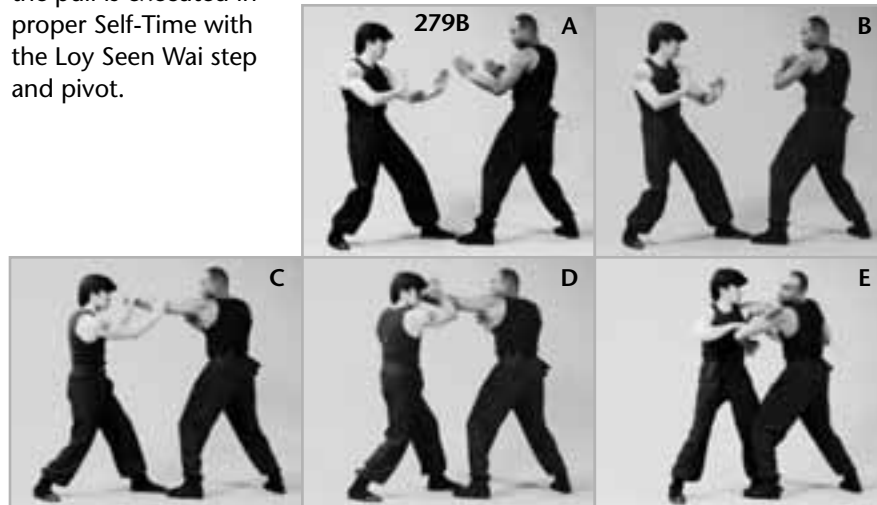


### Close Range Combat Wing Chun: Volume Three

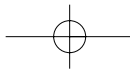
**279A**—*Photo A:* Fighters ready. *Photo B:* As B extends his lead left jab, Fighter A deflects it off the line and step/slides in with Toh Ma Pock Da. *Photo C:* Fighter B retracts his right fist to load up for a follow-up hook punch. *Photo D:* Fighter A uses Tan/Pock Sau to stop the hook.



**279B**—*Photo A:* Fighters are faced off in a Closed ready position. *Photo B:* Fighter B telegraphs his intention to throw a backfist. *Photo C:* Fighter A uses Tan/Pock Sau to stop the strike. Note that in the conservative combat logic of CRCA Wing Chun, neither of the two blocks alone are thought to be sufficiently effective to be used without the other to stop an extremely powerful circular attack. *Photo D:* Converting the left Tan Sau to a Fook Sau hook of B's wrist to act as a fulcrum, Fighter A attacks the locked-out elbow joint with an upward Hay Jahng elbow smash. *Photo E:* Using "Step-and-Face" footwork to add power and leverage to the technique, Fighter A then converts the elbow strike to a Huen Sau hook of the inner elbow that pulls B's arm up tight against his own chest, then pivots into a Pai Jahng Hacking Elbow strike to the face. Note that placing the opponent's arm against the chest creates a leverage point that allows him to be easily pulled off balance, especially if the pull is executed in proper Self-Time with the Loy Seen Wai step and pivot.





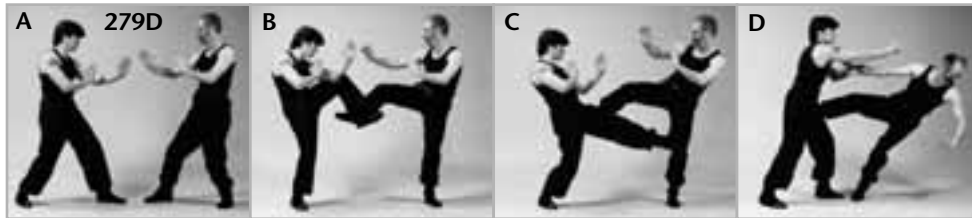


### San Sau—Practical Applications

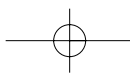
**279C**—*Photo A:* Fighters are in an Open relationship. *Photo B:* Fighter A uses Tan/Pock Sau to stop B's left high Round Kick as he kicks the base leg to destroy B's balance and power. *Photo C:* Plant/Trap/Hit.



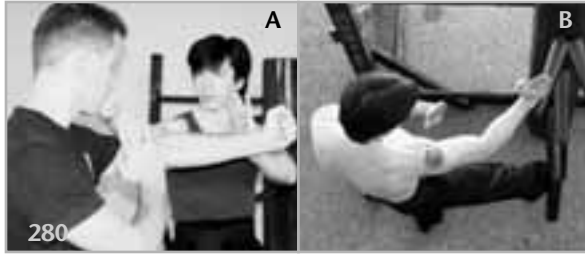
**279D**—*Photo A:* Fighters are in an Open ready position. *Photo B:* As B's lead right Round Kick comes in, Fighter A counters with an outward Tan Gyeuk leg lock. *Photo C:* Without putting his foot down between motions, Fighter A uses a Leg Block-to-Kick application of the Moh Ying Gyeuk principle as he kicks B's inner rear knee with the same leg that blocked. *Photo D:* Fighter B is blown backwards by the Plant/Trap/Hit follow-up.



**279E**—*Photo A:* Fighters face off in a Closed relationship. *Photo B:* As B skips in with a Teo Ngoy Tiu Gyeuk Reverse Round Kick, Fighter A draws his lead leg backwards and upwards to a Tan Gyeuk leg block. *Photo C:* In another Moh Ying Gyeuk "Invisible Kick" application, Fighter A shoots his blocking leg directly into a Front Kick to B's base leg without putting it down between motions.



## Close Range Combat Wing Chun: Volume Three

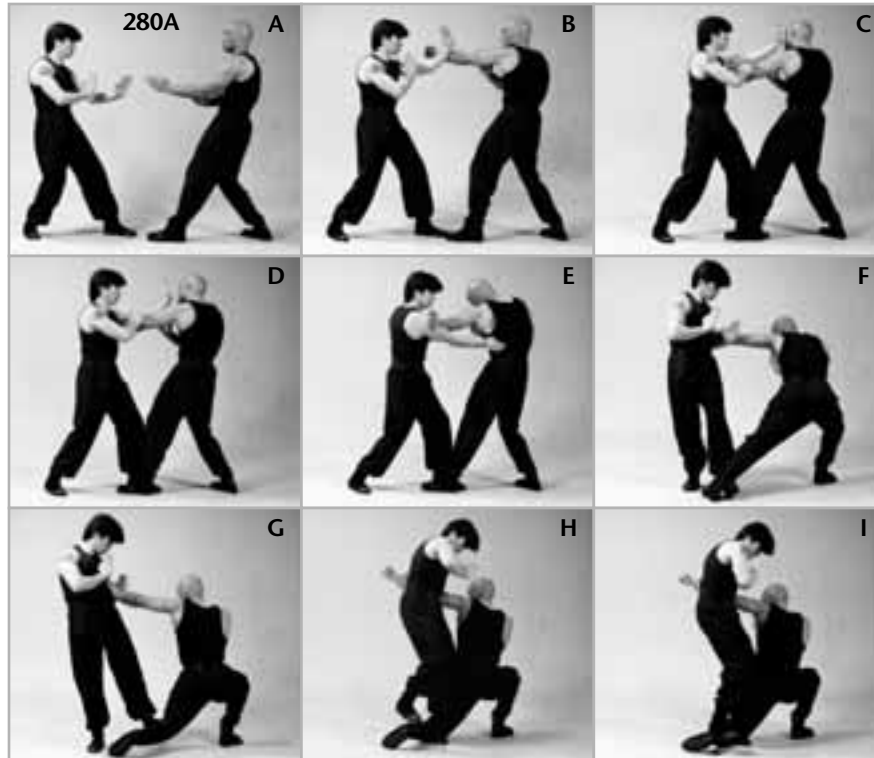


**Fig. 280**—Maintaining Bridge Contact with the Dummy arm with Woo Sau while executing the downward jerking leg motion, Woo Sau/Ngoy Jut Gyeuk simultaneously develops the trainee's skill in defending the inside gate with a correctly

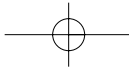
placed Guarding Hand, as well as the ability to bring the leg sharply downward to block a kick or to sweep the opponent's leg. In photos series A, two versions of Woo Sau application are seen, as Fighter A moves from having used his left Woo Sau to stop B's left punch into a cross "Woo Sau Wrap" to trap his arm. This trapping use of the Guarding Hand is rooted in the backwards-moving Woo Sau motion of the Siu Leem Tau form. Series B shows Woo Sau used as a Straight Wrap. Photos 280 C and D show other versions of the Woo Sau Wrap. For more Woo Sau Wrapping Trap applications, see fig. 114 of Volume I of this series. Series E illustrates the usage of the Ngoy Jut Gyeuk motion to stop an attempt by the opponent to counterkick the base leg of the Wing Chun man after a successful kicking attack. As Fighter B kicks toward A's base right leg while his left is still suspended, Fighter A uses Ngoy Jut Gyeuk to stop that attempt. Ngoy Jut Gyeuk is shown used as a sweep in photo 280F, while another application of the Outside Jerking Leg as a sweep was seen earlier in fig. 239A. More applications of Ngoy Jut Gyeuk are shown in fig. 176 of Volume II of this series.

**280A**—Photo A: Fighters ready. Photo B: Fighter A stops B's left Jab with his own left Woo Sau Guarding Hand. Photo C: Fighter A uses Pock Da Jing Jyeung to open the Centerline for his Vertical Palm Strike to the side of B's jaw. Photo D: After the strike, Fighter A begins to drop his left arm down to begin the cross Woo Sau Wrap. Photo E: As the Woo Wrap is completed, Fighter A twists his shoulders to lock B's elbow while adding length and power to his Chahng Dai Jyeung low Spade Palm attack to the ribs. Photo F: From the shin-to-shin position achieved through short Toh Ma advances to a position of best possible Facing Advantage, and without releasing the Woo Wrap, Fighter A hooks B's leading left ankle and sweeps it out from under him using a Loy Jut Gyeuk Inside Jerking Leg. Photo G: Without putting his foot down between motions or releasing the trap, Fighter A circles his left foot into a Yai Sut Huen Wahng Gyeuk to stomp B's knee into the floor. Photo H: Applying yet more pressure to B's knee by standing on it, Fighter A raises his right foot off the ground... Photo I: ...and stomps B's left ankle into the ground.

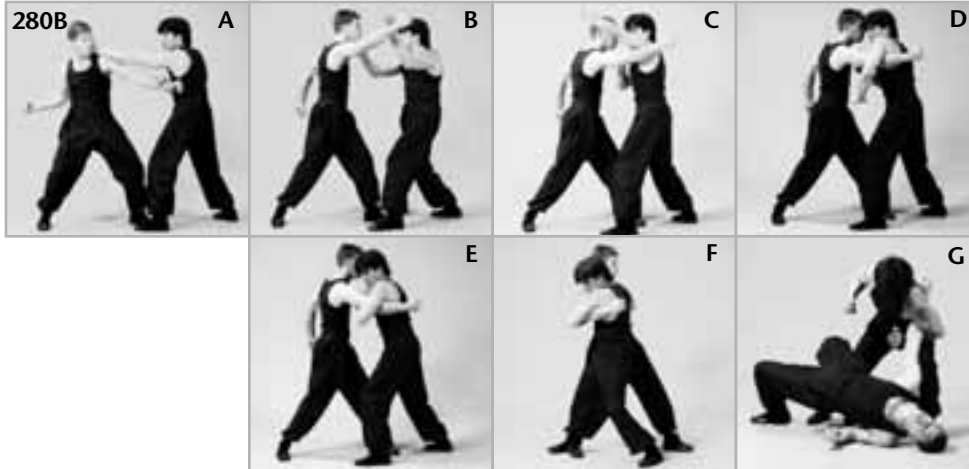
San Sau—Practical Applications



**280B**—*Photo A:* As Fighter A's left Pock Da makes contact, B winds up for a looping hook punch. *Photo B:* Fighter A then uses Tan/Pock Sau to stop the hook. *Photo C:* After the block, Fighter A moves his left hand over B's blocked arm to begin the Woo Sau Wrap. *Photo D:* The wrap is continued. *Photo E:* As the wrap is finished, Fighter A throws his right arm across B's chest to trap the left shoulder. *Photo F:* A uses Seep Ma footwork to first sidestep to make space, then circle his right leg behind B's right leg. *Photo G:* Using a twist of the hips and shoulders, Fighter A throws B to the floor in a motion that breaks the arm and leaves him trapped and vulnerable to further punishment.



### Close Range Combat Wing Chun: Volume Three



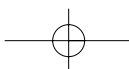
**280C**—The Cross Reverse Woo Sau Wrap.



**280D**—The Double Woo Sau Wrap.



**280E**—*Photo A:* Fighter A pulls B into a Side Kick. *Photo B:* While A's kicking leg is still in the air, Fighter B attempts to kick out his base leg. *Photo C:* Fighter A shoots his left leg directly down to Ngoy Jut Gyeuk to exclude B's kick.



San Sau—Practical Applications



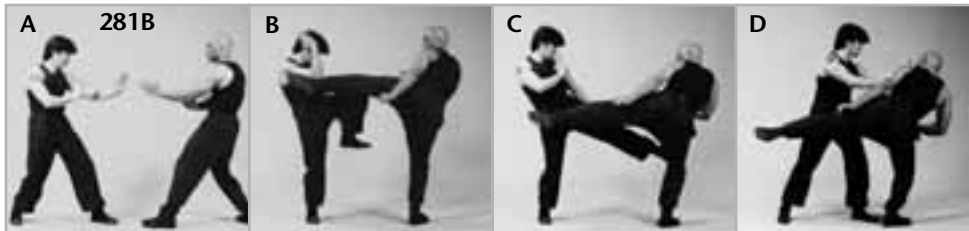
280F

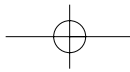
**Fig. 281**—Syeung Lop/Tai Sut. This motion introduces the double overhead grab and the Raising Knee Strike. Based on the Tai Sau principle of Siu Leem Tau (photo A), Tai Sut is used to attack or defend from various angles. The upper knee joint can be used in an upward attack as was seen in 239A, or the front face of the knee can block, attack or cover when the opponent kicks as shown in series B, C and D. When both the Wing Chun fighter's hands are occupied on the high line, Tai Sut can provide a surface upon which the opponent's hands can be pressed using one hand to "sandwich" trap them while freeing the other hand to strike (series E).



**281A**—The Tai Sut Raising Knee Strike has its root in the Tai Sau motion of Siu Leem Tau.

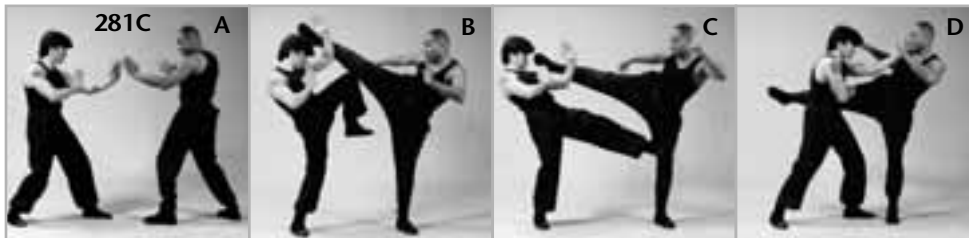
**281B**—*Photo A:* Fighters are in a Closed left relationship. *Photo B:* Fighter A uses his right Hay Jahng upward elbow to cover up as he drives the left Tai Sut under B's left knee to block the mid-level Loy Tiu Gyeuk from beneath. *Photo C:* Without putting the foot down between kicks, A continues in to attack the base leg with Moh Ying Wahng Gyeuk. *Photo D:* Plant/Trap/Hit.



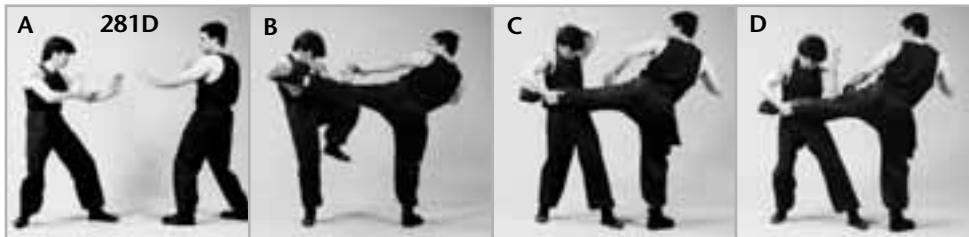


### Close Range Combat Wing Chun: Volume Three

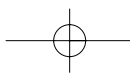
**281C**—*Photo A:* Fighters are again faced-off in a Closed left relationship. *Photo B:* Fighter A this time uses his left Hay Jahng to cover up as he drives the left Tai Sut under B's left knee to block his high Round Kick from beneath. *Photo C:* Without putting the foot down between motions, A attacks the base leg with Moh Ying Jing Gyeuk. *Photo D:* Using Poh Joong principle by slapping B's kicking leg out of the way, Fighter A plants, traps and punches.



**281D**—*Photo A:* Fighters are in a Closed left relationship. *Photo B:* As B's mid-level Round Kick comes in, Fighter A uses offset timing to first contact the shin and knee of the kicking leg with the double Jom Sau motion of the Siu Leem Tau form, then immediately upon contact brings his left knee up to "sandwich" B's left leg with Tai Sut. *Photo C:* Trapping B's kicking leg with his right hand, Fighter A chambers his left arm... *Photo D:* ...for a Chum Jahng Sinking Elbow smash to the side of the knee that breaks B's leg.



**281E**—*Photo A:* Fighter A scores with a "Cross-up" Trap/Tai Sut knee strike to the groin. *Photo B:* He then keeps the opponent's arms trapped and uses his knee like a "third hand," sandwiching them between the knee and the top half of the grab... *Photo C:* ...and releases his grip with the left hand, which is then free to strike.



### San Sau—Practical Applications

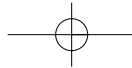


281F—Tai Sut, used in Groundfighting.

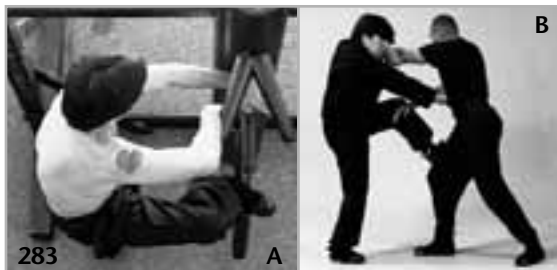
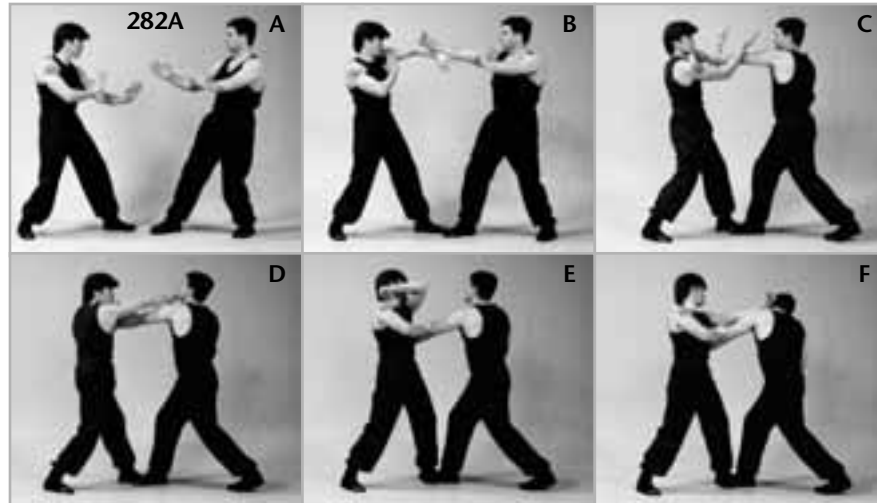


*Fig. 282—Chuo Kuen, the Hammer Fist punch, when combined with a simultaneous hand or body trap, is a heavy blow that can do severe damage to vital areas, especially if the trainee has developed his Teet Sa Jyeung Iron Palm skills. Series A illustrates the inward and outward versions of this “Heavy Hand” blow. It can also be executed in upward, downward and forward low versions.*

282A—Photo A: Fighters are faced-off in an Open relationship. Photo B: Fighter A stops B’s right jab with his own left Boang Sau. Photo C: As B continues in with a left cross, Fighter A uses Delayed Timing to intercept that punch with a Chum Kiu armbreak. Photo D: Converting his left hand to a scooping Huen Sau motion to clear the Centerline, Fighter A attacks B’s chin with a right outward Chuo Kuen Hammer Fist. Photo E: A then switches the trapping duty as he chambers the left hand... Photo F: ...for an inward Hammer Fist to the temple.



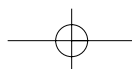
Close Range Combat Wing Chun: Volume Three



**Fig. 283**—In executing the Huen Da Fun Sau Kup Yai Sut Dai Gyeuk motion, the trainee is introduced to the concept of striking and kicking to the Original Centerline from an Inside Facing position, as can be seen clearly in the overhead view. This Biu Jee principle is shown here in actual application.



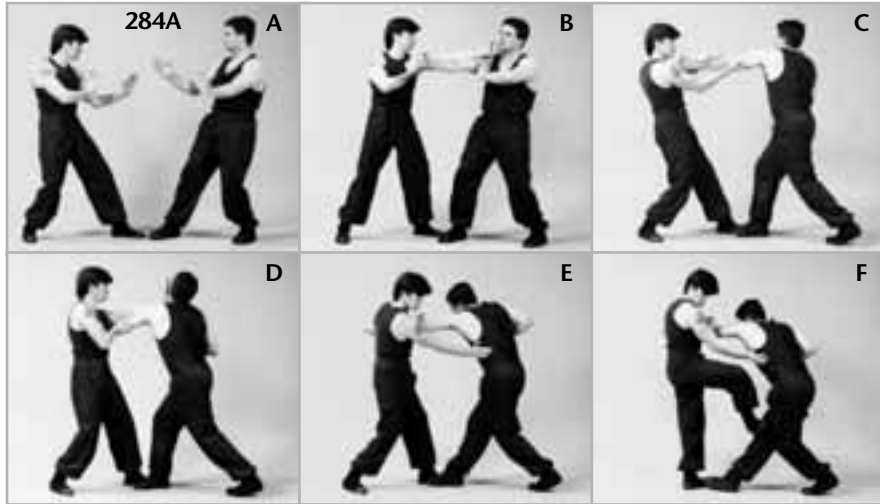
**Fig. 284**—The upward/forward-lifting, backward/downward-pulling action of Jeep Sau a combination of Pau Sau and Loy Jut Sau can be applied in its pure form to break an extending arm (series A) or can be interpreted in a number of other ways. Jeep Sau works on the same “Catch-up” principle as Kau Sau and Ngoy Jut Sau, but instead of merely defending, using Jeep Sau, the Wing Chun fighter can apply Delayed Timing in another form of “Attacking Defense.” Jeep Sau also forms the root of the Lai Sau “over-and-under” Grab used in series C.



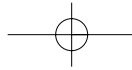


San Sau—Practical Applications

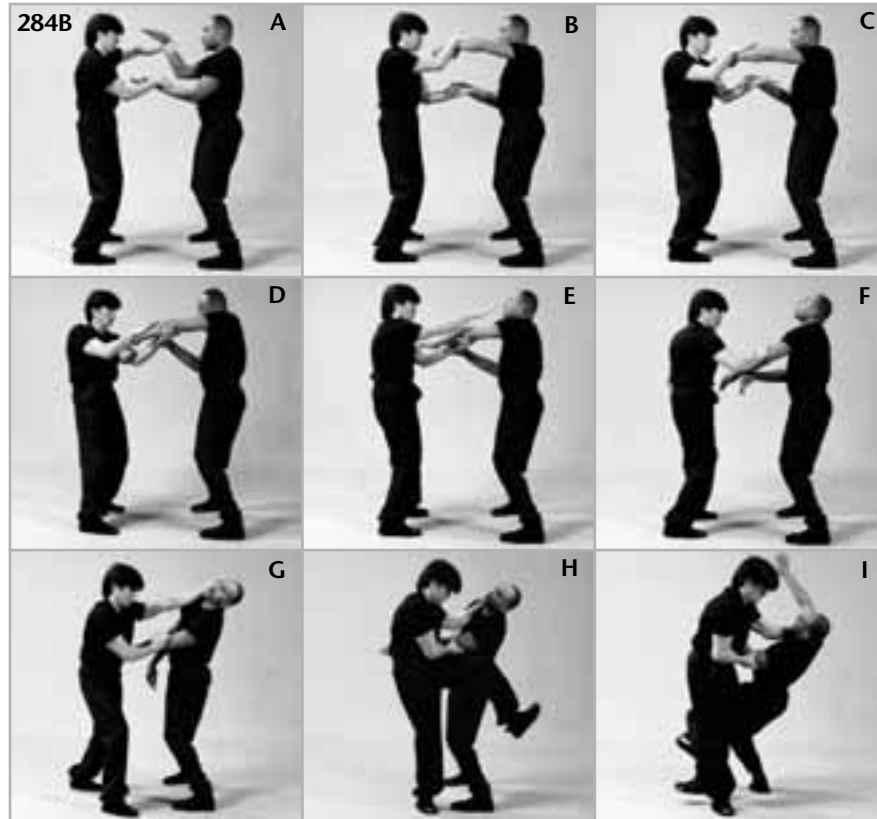
**284A**—*Photo A:* Fighters are squared off in an Open relationship. *Photo B:* Fighter A uses an including *Kuen Siu Kuen* motion to intercept and redirect B’s jab inward with a wedging action that shears into the oncoming punch, allowing his own punch to both defend and counterattack. *Photo C:* Using the same principle as *Kau Sau* to “catch-up” to B’s second punch, Fighter A also uses Delayed Timing to “set the trap,” breaking B’s arm with the Multi-Directional action of *Jeep Sau*. *Photo D:* Keeping contact with his *Pau Sau* hand and converting it to a palm-up grab, Fighter A pulls B’s arm towards him as he shoots his left hand forward to a *Jing Jyeung Vertical Palm Strike* to B’s face. *Photo E:* Fighter A then drops his extended left arm down and around B’s left arm to trap it with a *Woo Sau Wrap* that pulls him into a *Chahng Dai Jyeung* attack to the ribs. *Photo F:* Keeping the armwrap, Fighter A follows up with a kick to the right knee.



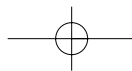
**284B**—After completing one *Look Sau* rolling cycle (*photos A and B*), Partner A uses the *Jeep Sau* motion from the *Chum Kiu* form as he simultaneously presses B’s left *Boang Sau* arm downward with *Jut Sau* to be met with his left *Pau Sau*, which raises B’s right *Fook Sau* hand up into the trap (*photos C and D*). Then, using the *Split-Second Release* trapping principle, Partner A quickly attacks B’s eyes with a right *Biu Jee Sau* (*photo E*) and snaps that hand back to retrap B’s left arm (*photo F*) as he moves in with a *Front Bracing Pau Sau* forearm strike (*photo G*). Keeping both points of contact for control, Partner A then raises his left leg (*photo H*) to chamber for a *Ngoy Jut Gyeuk* leg take that is executed while “turning the steering wheel” to improve leverage (*photo I*).

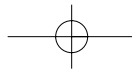


Close Range Combat Wing Chun: Volume Three

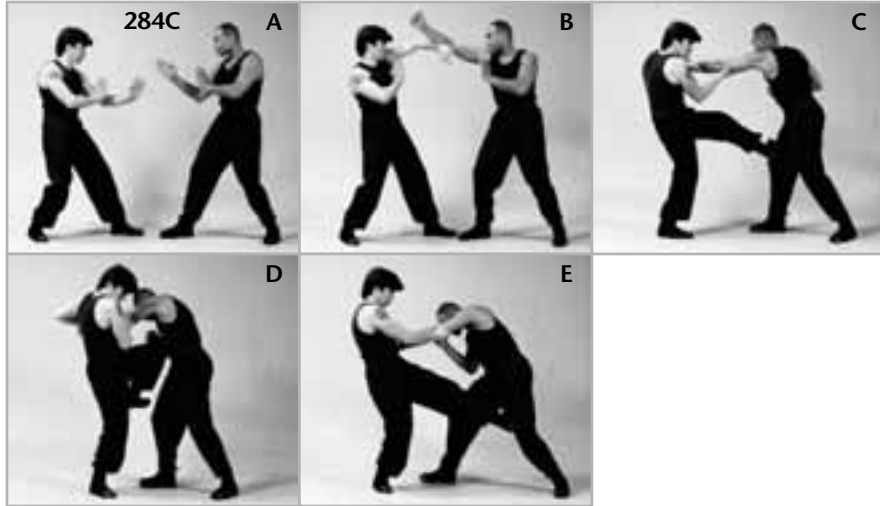


**284C**—*Photo A:* Fighters square off in an Open relationship. *Photo B:* A stops B’s right jab using left Boang Sau. *Photo C:* As B’s left cross extends, Fighter A intercepts it using a Jeep Sau “Bridge-catching” hand that is immediately converted into a Lai Sau over-and-under double grab that pulls B into a kick. *Photo D:* Maintaining both grabs, Fighter A uses the retracting *Deem Gwun* motion of the “Look Deem Boon” pole form to pull B into a skipping Moh Ying Loy Doy Gock Gyeuk knee attack. *Photo E:* Now using his grip on B’s locked-out left arm like the *Biu Gwun* Thrusting Pole motion, Fighter A shoves B back to kicking distance and snaps his left leg out to kick B’s knee.

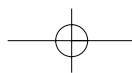




### San Sau—Practical Applications



**Fig. 285**—The short backward step to a Back-Braced position can be used when the Wing Chun fighter needs only to relieve the pressure created by the opponent's advancing footwork but does not wish to alter the Centerline. In photo C, Partner B moves forward as she executes a Cheen Chong Ma Biu Sau attack. The advantage of stepping directly backward to a braced position is clearly seen in photo C, as Partner A is able to equalize his opponent's forward momentum and increased range using this abbreviated Moving Stance.



Close Range Combat Wing Chun: Volume Three



**Fig. 286**—Cheh Sau Soh Gyeuk, the Arm Bar/Sweep Kick, in Application. In photo A, Fighter A uses both hands to pull his opponent in the opposite direction of the right Sweep Kick, using counterpressure between the right Kau Sau which pulls the arm straight and the left Gum Sau which locks the elbow. This pull causes him to put more weight on the leg that is being kicked, therefore causing that leg to absorb full impact. The Cheh Sau motion, also called Gum Jahng, can be used separately as was seen

earlier in fig. 266 to press the opponent's arm to a fully locked out position, causing him to stumble forward into a counterstrike. Cheh Sau principle is also used very often in Groundfighting, as seen in series C and D, where Fighter A uses it both as a head slam and an arm smash. This technique is an interpretation of the downward-snapping Ngahn Gwun motion from the "Look Deem Boon" Gwun "Six-and-a-half-point" pole form.

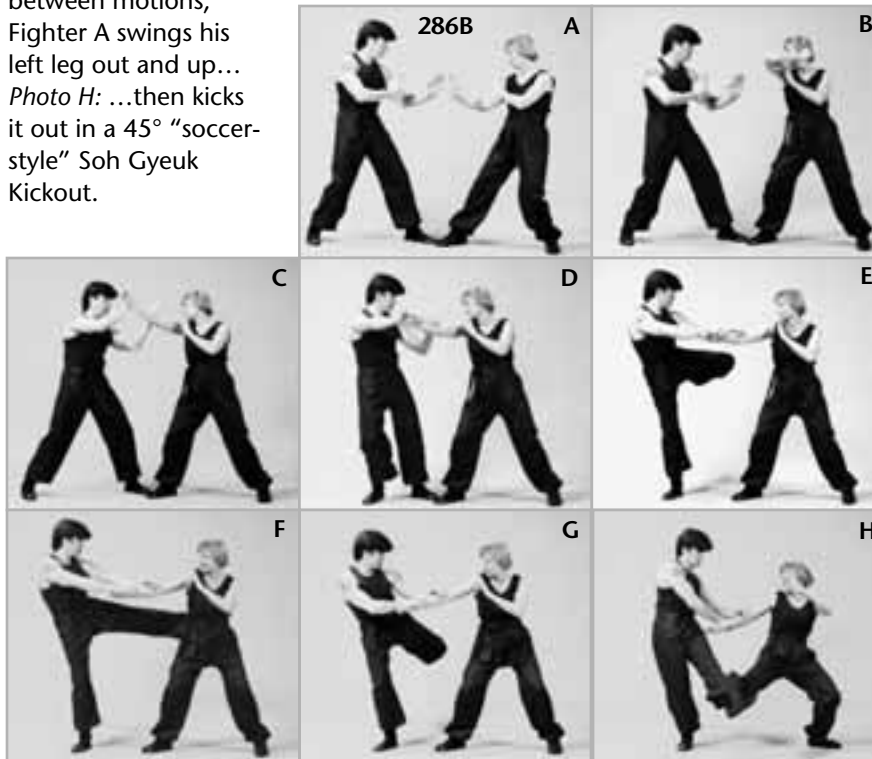
**286A**—Photo A: Fighters are ready in an Open relationship. Photo B: As B jabs, Fighter A counters with Boang Sau. Note that A's guarding hand is held lower than it would normally be positioned. Photo C: Snaking his right hand from its guarding position underneath his own left Boang Sau, Fighter A steps off to the left with his left foot and sharply turns his shoulders to add length and power to his right Biu Jee Sau attack to B's eyes, which comes in from an unexpected angle. Photo D: Using the Cheh Sau/Soh Gyeuk motion, Fighter A pulls the opponent into a Sweep Kick to the knee. Photo E: Converting Cheh Sau to the Syeung Lop Sau double grab from the Biu Jee form, Fighter A begins a Jumpswitch as he chambers his left leg... Photo F: ...for another Sweep Kick, this time to the back of B's ankle. Note that kicking lower on the leg gives Fighter A's Sweep Kick better leverage than a higher-level kick would give.

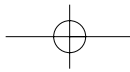


San Sau—Practical Applications



**286B**—*Photo A:* Fighters square off in Open ready position. *Photo B:* B “telegraphs” her lead right backfist. *Photo C:* Fighter A uses the Syeung Jom Sau motion from the Siu Leem Tau form to stop the strike. *Photo D:* Without losing Bridge Contact, A begins the Cheh Sau double grab... *Photo E:* ...that pulls B in as he chambers his left leg for... *Photo F:* ...a Biu Gyeuk Piercing Toe Kick to the spine. *Photo G:* Without putting the foot down between motions, Fighter A swings his left leg out and up... *Photo H:* ...then kicks it out in a 45° “soccer-style” Soh Gyeuk Kickout.



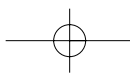


### Close Range Combat Wing Chun: Volume Three

**286C**—*Photo A:* The opponent is on “all fours,” with Fighter A on his right. *Photo B:* Fighter A places his left hand on the side of B’s neck as he grabs B’s right wrist. *Photo C:* Using the Cheh Sau motion of the Biu Jee form, Fighter A pulls B’s near arm out from under him, causing him to fall forward as his head is rammed into the floor by A’s left Gum Sau. *Photo D:* Again using the Cheh Sau motion, Fighter A slams B’s arm into the floor... *Photo E:* ...then kneels on it. *Photo F:* A then loops his left arm around B’s neck, making sure that the point of his elbow lines up directly beneath B’s chin. *Photo G:* Placing his own left hand on his own right bicep as he uses his right leg to hook B’s, Fighter A completes the choke by placing his right hand behind B’s head and squeezing his elbows together. This action cuts off both the air and blood flow to B’s head.

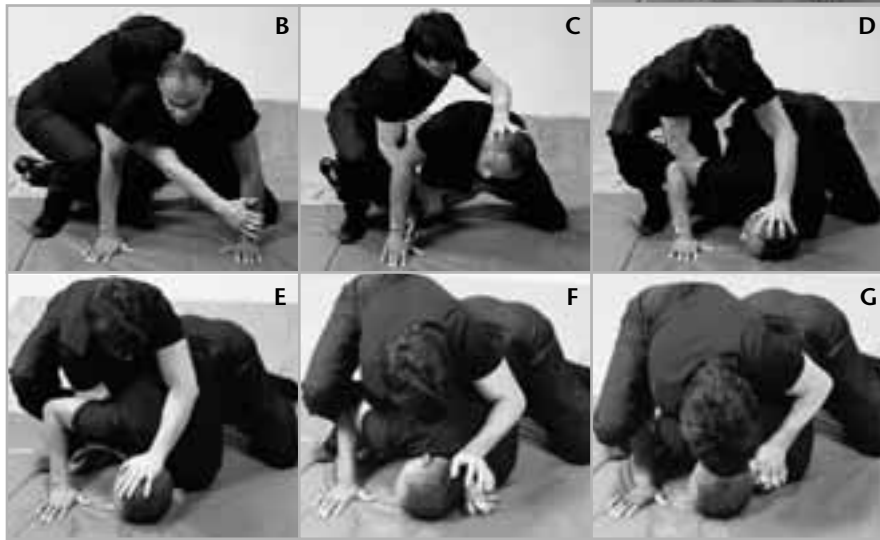


**286D**—*Photo A:* The opponent is on “all fours,” with Fighter A on his right. *Photo B:* A reaches his “near arm” to catch B’s “far arm” near the wrist from the front. *Photo C:* Fighter A places his left hand on the side of B’s head. *Photo D:* Again using Cheh Sau, Fighter A pulls B’s far arm out from under him, causing him to fall forward as his head is rammed into the floor by A’s left Gum Sau. *Photo E:* Maintaining left Gum Sau pressure on the opponent’s head to keep it pinned to the floor, Fighter A places his right palm on the

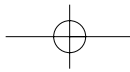


San Sau—Practical Applications

floor, passing his hand through the gap between B's neck and the floor. *Photo F:* Releasing B's head from the floor, Fighter A brings his hands together... *Photo G:* ...and interlocks his fingers to choke B with Lon Sau from the side of the neck.



*Fig. 287—The Inward Hooking Foot, like its Jing Gyeuk counterpart, is used either to hook onto the opponent's leg to prevent a backward loss of balance, or to hook the opponent's leg in a sweeping motion as seen here. Ngau Gyeuk skills are also important in Sticky Foot training as the opponent's suspended leg and foot is often hook-trapped and manipulated off the Centerline to open the base leg to attack.*



### Close Range Combat Wing Chun: Volume Three



**287A**—Photo A: Fighter A hooks the inner arch of his left foot behind B's right heel...  
 Photo B: ...and pulls her foot out from under her using Loy Ngau Gyeuk.



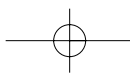
**Fig. 288**—Although appearing to the untrained eye to be a Hook Punch, the Loy Doy Gock Kuen Inward Diagonal Punch is simply a straightline strike delivered from across the chest to its final point of Reference on the Centerline when the Wing Chun fighter finds himself in a "T" relationship with the opponent. The punching forearm follows the Elbow Line, regardless of the fighters' Reference. As it appears in the Biu Jee form (photo A), the punch seems to be going outside the Centerline as if hooking. But note that the head and eyes are focused toward the reference point of the punch. In the "language" of Wing Chun forms, this head position and eye focus signifies that the motion is referenced to a point off the Original Centerline.

Seen in application in photos B-D, it is obvious that the strike is focused on the Centerline, but note also that Fighter A's Angle of Facing is 45° from that line. Thus this punch, when executed without a partner or Wooden Dummy to bring its actual point of Reference to light, seems to travel from the Centerline outward, but actually does just the opposite in application.

**288A**



**288B**





San Sau—Practical Applications

288C



288D

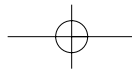


*Fig. 289—Shown in its exact application with Pock Sau and Toh Ma footwork from the form in photo A, Chop Kuen is a Multi-Directional downward/outward/forward twisting low punch that can exclude an oncoming punch with Kuen Siu Kuen principle, or can “leak” over to drive in from an unexpected angle as in series B. The downward 45° angle of arm rotation keeps the bones of the punching arm in proper structural alignment to support the Chop Kuen without relying on muscle tension that can hinder the proper release of power.*

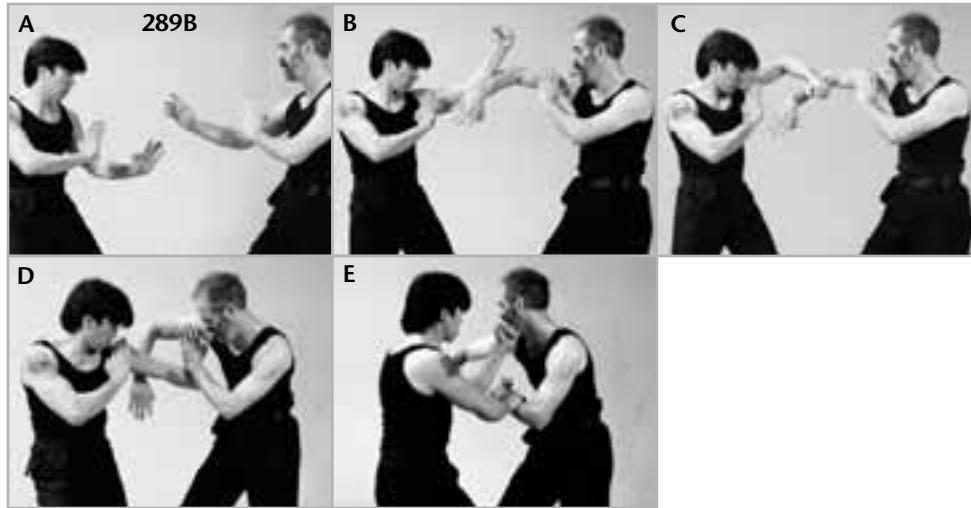


289A

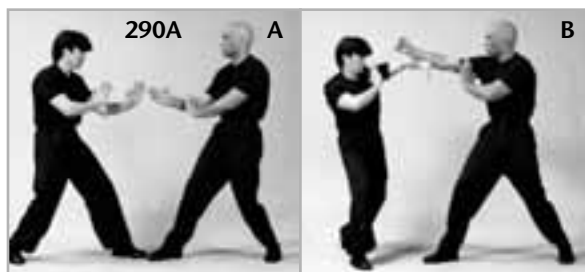
**289B**—*Photo A:* Fighters are in an Open ready position. *Photo B:* Fighter B stops A’s left jab with right Boang Sau. *Photo C:* Using the “Leakage” principle introduced by the Toh Ma Boang Sau motion of the Chum Kiu form, Fighter A matches the angle of B’s blocking arm... *Photo D:* ...then drives his Chop Kuen punch inward and downward, excluding B’s arm. *Photo E:* Using his right hand to trap B’s left, as it is the most likely to strike, A slaps and strikes with a wheel-like Pock Da Loy Fon Kuen. Note that had A used his left hand to trap B’s right instead, he might have been jammed by a right punch from B.



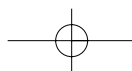
### Close Range Combat Wing Chun: Volume Three



**Fig. 290**—The Hau Chong Ma Boang Sau motion formally introduces Back Bracing footwork. This combination of the Choh Ma pivot and the Syeung Ma advancing step was discussed in detail in the Ma Boh essay of Volume I of this series, as was the strategy of its use.

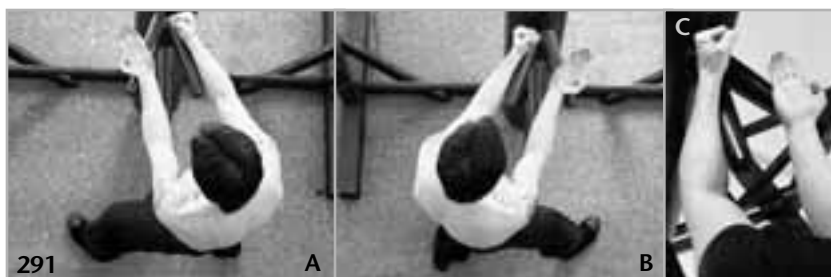


**290A**—Photo A: Fighters are in an Open relationship. Photo B: As B advances with his right jab, Fighter A relieves the pressure caused by that advance while supplementing the power of his pivoting left Boang Sau defense using Back Bracing Hau Chong Ma footwork.



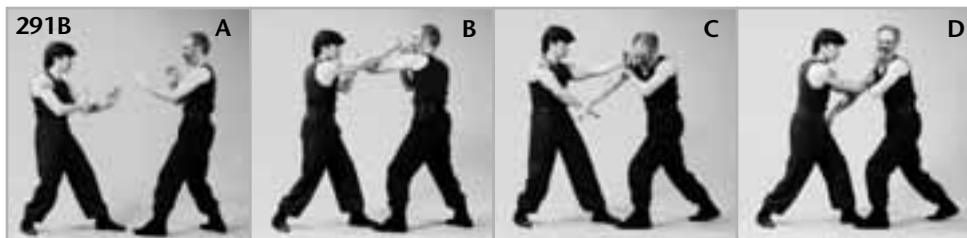
### San Sau—Practical Applications

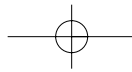
**Fig. 291**—As has been seen many times throughout this book series, the *Tan Da* motion (photo A), the first of three main Complex Attack origins, is a fast, economical way to “Break Timing” by launching the return fire on the same line during a block rather than after it. This classic example of Simultaneous Attack and Defense is characteristic of the Wing Chun system. Proper utilization of the Complex Attack principle of *Tan Da* requires that the trainee have a full understanding of Yin/Yang concepts, as he capitalizes on the “positive” and “negative” sides of the Power Arc created by torquing footwork. *Tan Da* is shown here used as a block (series B), a “Takeover trap” (series C) and as a *Gwot Sau* carry to open the line after the opponent blocks a punching attempt (series D).



291A

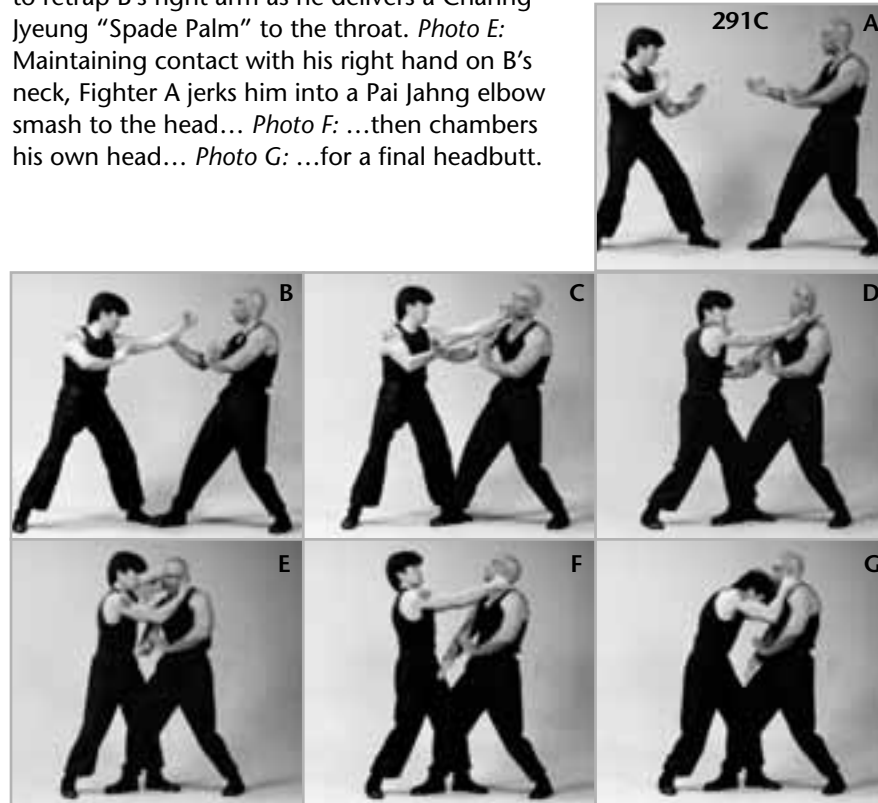
**291B**—*Photo A:* Fighters are in a Closed relationship. *Photo B:* Fighter A uses *Tan Da* to stop B’s jab. Note that although in the conservative logic of Wing Chun, it is normally considered unwise to move forward when blocking a jab, it is possible to step forward with *Tan Da* due to the fact that you are also counterpunching. Forward-moving footwork would serve no useful purpose with a block alone, and would in fact be counterproductive, as it could only improve the chances of being hit. *Photo C:* Seeing the opening created by A’s high-line punch, Fighter B attempts a *Chop Kuen* to the body, which is countered by A’s *Gahng Da*. *Photo D:* Fighter A finishes with a retrap/punch.



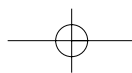


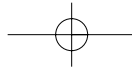
**Close Range Combat Wing Chun: Volume Three**

**291C**—*Photo A:* Fighters face each other in an Open relationship. *Photo B:* Fighter B stops A's jab with a right Pock Sau. *Photo C:* Fighter A then uses his own right hand to clear B's right hand off his left arm as he steps in with Toh Ma Ta Da. *Photo D:* A then brings the spent punching hand down and back to retrap B's right arm as he delivers a Chahng Jyeung "Spade Palm" to the throat. *Photo E:* Maintaining contact with his right hand on B's neck, Fighter A jerks him into a Pai Jahng elbow smash to the head... *Photo F:* ...then chambers his own head... *Photo G:* ...for a final headbutt.

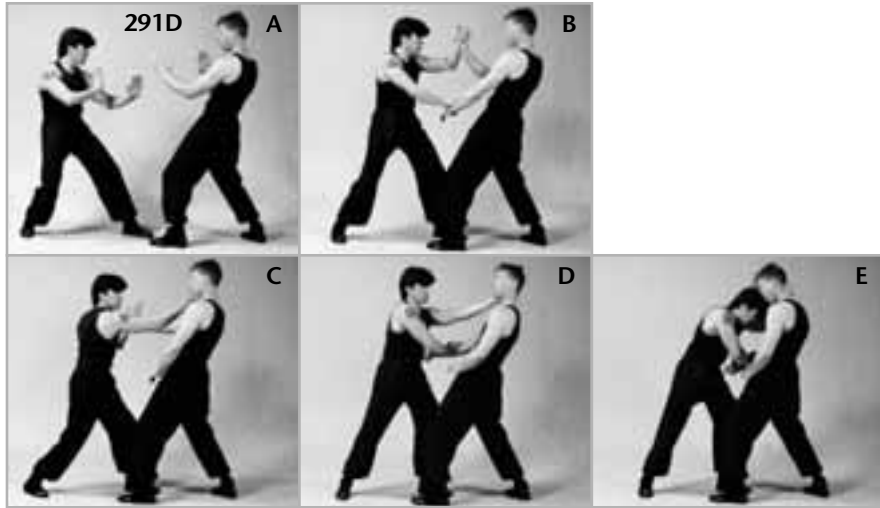


**291D**—*Photo A:* Fighters face each other in a Closed left relationship. *Photo B:* Fighter A attempts to "break center" with Pock Da, but B stops the punch with his own right Pock Sau. *Photo C:* Sensing that B will not release his Pock Sau grip, Fighter A converts his blocked left punch into Tan Sau, which is used here in a Gwot Sau application to carry B's hand to the outside, creating an opening for A's next punch. *Photo D:* Retrap/Chahng Jyeung. *Photo E:* Converting the "Spade Palm" strike to a neck trap, Fighter A headbutts the opponent.

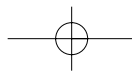
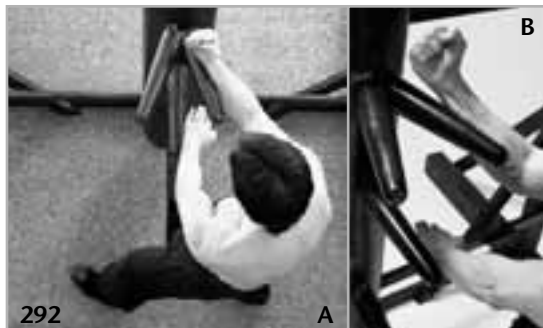


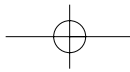


San Sau—Practical Applications



**Fig. 292**—Gahng Da, the second of three Complex Attack Origins, in Application. As can be seen here, the concept of Simultaneous Attack and Defense applies equally to Complex Motions that occupy both the high and low lines, blocking on one while attacking on the other. One Gahng Da application was seen in fig. 291B, where Fighter A blocked B's second low punching attempt after stopping the jab with Tan Da on the high line. Another is seen here in series B, used against a mid-level Chau Kuen Drilling Punch.





Close Range Combat Wing Chun: Volume Three



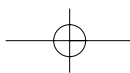
292A—Gahng Da with the Rattan Ring.

292B—*Photo A:* Fighters are in a Closed ready position. *Photo B:* Fighter A stops B's lead Hook with Woo/Pock Sau. *Photo C:* As Fighter B continues in with a rear uppercut to the body, A uses Gahng Da to simultaneously attack and defend.



**Fig. 293**—The Center-to-Front Syeung Ma footwork illustrates to the trainee the exact position of the feet in relation to the Centerline when advancing the stance, as is clearly seen in the overhead view. This concept was illustrated by Diagram P of the Ma Boh essay in Volume I. In an application of the Syeung Ma Boang Sau principle from the Dummy form, Fighter A here uses a forward/outward step to advance his position while adding Yang power to his leading arm (photos A and B), and continues to advance throughout the sequence.

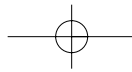
293A—*Photo A:* Fighters ready. *Photo B:* Fighter A takes a small outward/forward step to close the gap as he blocks B's jab using Boang Sau. Note that this step is taken to improve Facing, add power to the block *and* to move away from the punch. *Photo C:* Advancing a bit more with his leading leg, Fighter A grabs B's blocked arm as he circles his left hand from Boang Sau to a Fun Sau chop to the throat. *Photo D:* Whipping the Fun Sau hand directly back to take over the trapping duty with Huen Sau at B's inner elbow, Fighter A advances again as he drives Hay Jahng up the middle. *Photo E:* After the elbow scores, Fighter A slips his left arm under B's right, then places his palm on B's right shoulder from behind. He then lays his own right palm on top of his own left to complete the shoulder envelopment that pulls B into



### San Sau—Practical Applications

a Tai Sut knee strike to the body. *Photo F:* Keeping the shoulder trapped, Fighter A kicks B's inner rear knee without putting his foot down between motions. *Photo G:* Still keeping the shoulder trapped with his left hand, Fighter A releases the right trap and uses his falling weight to add power to a downward-twisting Chum Jahng attack to the spine. *Photo H:* Maintaining the left shoulder trap as a fulcrum, Fighter A grabs B's right arm with his own right Lon Sau and twists his body to break the arm behind B's back in an application of the Choh Ma Pai Jahng seen in Movements 11, 33 and 35 of the Chum Kiu form. *Photo I:* Fighter A then releases his right grip and throws his right arm around B's neck to begin... *Photo J:* ...the standing "Guillotine" choke. Note that A grabs the outer heel of his own right hand to add leverage to the choke.





### Close Range Combat Wing Chun: Volume Three

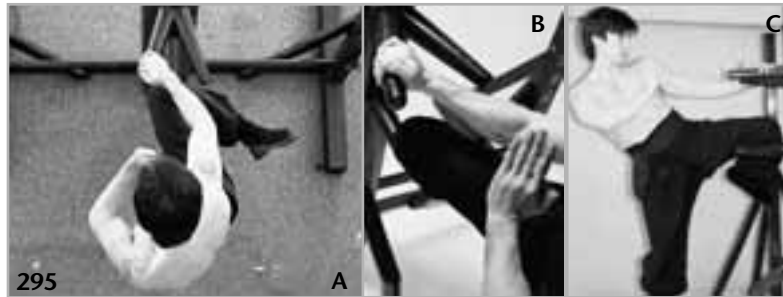


**Fig. 294**—When executed with a simultaneous forward thrust of the extended lead guarding hand to exclude the opponent’s punch from either the inside or the outside (as shown here), a “Nailing” Straight Kick uses his own forward momentum, which has been redirected to the outside, against him. Note the position of the Woo Sau hand near the inner elbow of the Biu Joang arm.

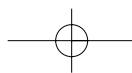


**294A**

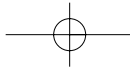
**Fig. 295**—Fook Gyeuk, the head of the third kicking “family,” uses the shin or knee to defend against angular kicks as seen in series A, or as an attack as in series B and C. The Gwai Sut Downward-arcing Knee Strike uses a whip of the knee with Fook Gyeuk structure in an attacking mode.



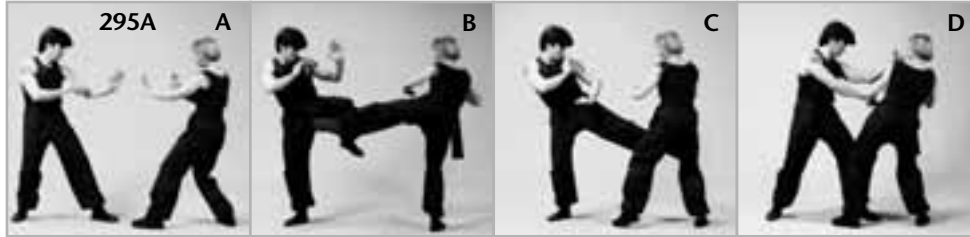
**295A**—Photo A: Fighters are in a Closed relationship. Photo B: Fighter A stops B’s lead Round Kick using Fook Sut. Photo C: Without putting his foot down after the block, Fighter A attacks the inside of B’s base knee with a “shadow-less” Moh Ying Wahng Gyeuk. Photo D: Plant/Trap/Hit.



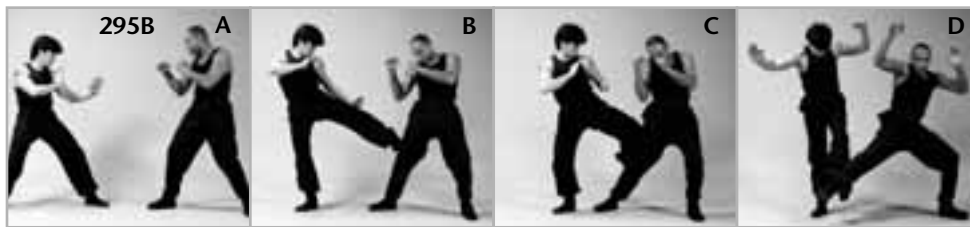




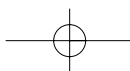
### San Sau—Practical Applications



**295B**—*Photo A:* Fighters face off in an Open ready position. *Photo B:* Fighter A skips in to attack the back of B’s thigh with a Teo Loy Tiu Gyeuk Jumping Round Kick. *Photo C:* Without putting his foot down between motions, Fighter A skips in and snaps his heel inward to close the knee, adding the power of the shortened-lever to the downward-arcing Gwai Sut knee drop that lands painfully on B’s upper thigh near the hip. *Photo D:* Still without putting the foot down, Fighter A swings his left instep down and in to kick B’s leg out from under him.

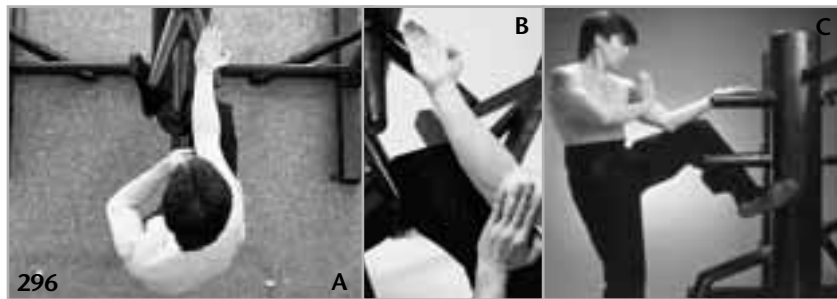


**295C**—Another Gwai Sut application is seen here, as Fighter A skips directly into a knee attack to B’s hip/thigh area.

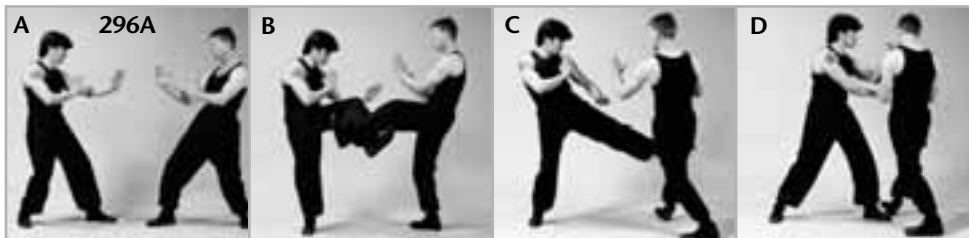


Close Range Combat Wing Chun: Volume Three

**Fig. 296—Tan Sau/Boang Gyeuk.** This motion formally introduces the Wing Leg Deflection the leg-blocking counterpart of Boang Sau. Boang Gyeuk is commonly used to deflect straightline kicks with a forward/upward/inward drilling motion of the shin. In series A, Fighter A uses this angular outer shin muscle leg block to catch the opponent mid-kick with an upward/outward/forward action that clears the low line. Series C and D illustrates a similar application of the Boang Gyeuk motion from two perspectives as Fighter A “scoops” the opponent’s attacking leg upward and inward from the outside. In the Chee Don Gyeuk Single Sticky Foot cycle seen in series 296D, Boang Gyeuk is used to stop two types of Straight Kick: one delivered without prior Bridge Contact (photo B) and one that originates from a position where the suspended leg of both partners are in contact (photo D). More can be learned about this leg blocking motion by reading the Wing Chun Leg Defense essay of Volume II.

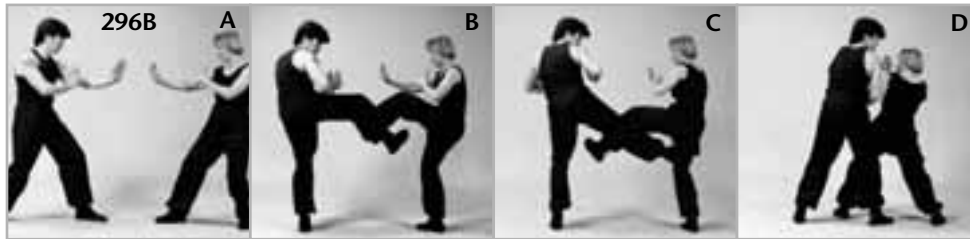


**296A—Photo A:** Fighters are in an Open ready position. **Photo B:** When Fighter B attacks with Jing Gyeuk off the rear leg, Fighter A uses an upward, inward Boang Gyeuk Wing Leg to deflect the kick. **Photo C:** Without putting his foot down after the block, Fighter A attacks B’s base leg with Moh Ying Wahng Gyeuk as he falls backwards. **Photo D:** Plant/Trap/Hit.

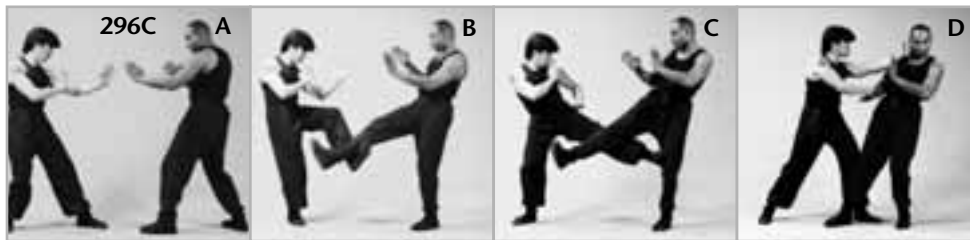


San Sau—Practical Applications

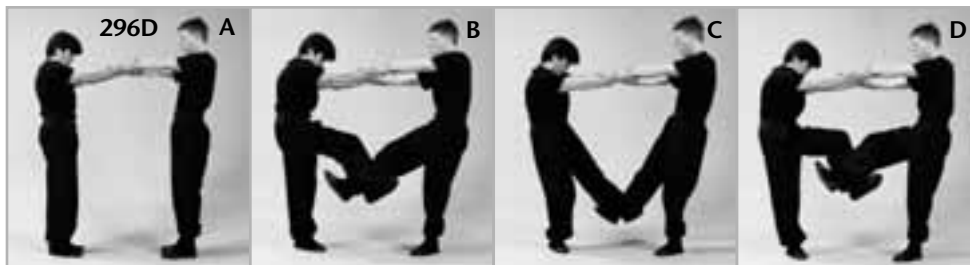
**296B**—*Photo A:* Fighters are again in an Open ready position. *Photo B:* When Fighter B attacks with Jing Gyeuk off the rear leg, Fighter A uses another upward, inward Boang Gyeuk to deflect the kick, this time using his own rear leg. *Photo C:* Without putting his foot down after the block, Fighter A attacks B’s base leg with Moh Ying Wahng Gyeuk. *Photo D:* Plant/Trap/Hit.



**296C**—*Photo A:* Fighters are in a Closed ready position. *Photo B:* Fighter B again uses a rear Jing Gyeuk, which A blocks from the outside with a lead left Boang Gyeuk. *Photo C:* Without putting his foot down after the block, Fighter A attacks B’s base leg with a “shadowless” Side Kick. *Photo D:* Fighter A Plants, traps and punches.



**296D**—Boang Gyeuk is used in two ways in the Single Sticky Foot cycle—executed from positions both with and without prior (leg) Bridge Contact.



Close Range Combat Wing Chun: Volume Three

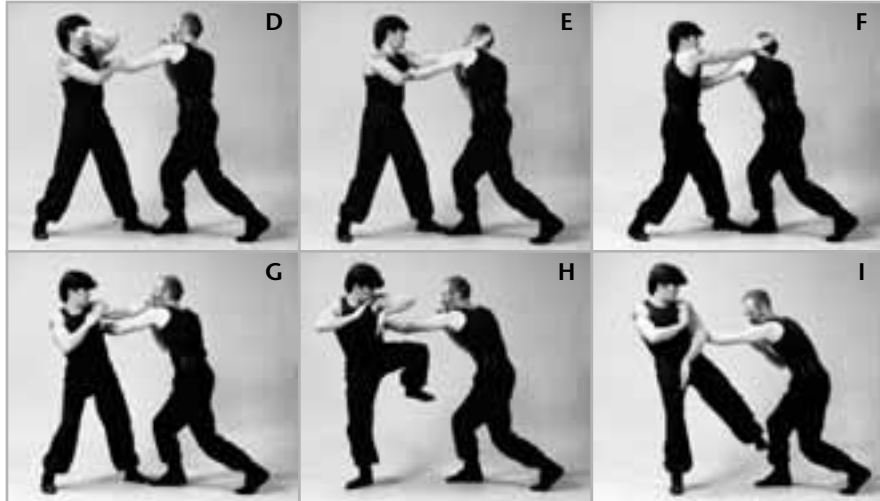


**Fig. 297**—Chai Wahng Gyeuk, the “Scraping” Sidekick, in application. Chai Wahng Gyeuk introduces the last of the eight kicking principles of Wing Chun. It is used with protective Wing Arm structure in series A to stomp the knee and then run down the shin of Fighter B’s lead leg after a successful hand technique. Series B illustrates the Scraping Sidekick in another application where the front of the opponent’s shin is attacked as Fighter A descends after scoring with a Side Kick.

**297A**—Photo A: Fighters are in an Open ready position. Photo B: Fighter A stops the jab using Boang Sau. Photo C: As B’s cross is extended, Fighter A uses a wheel-like motion to slap the punch as he begins to circle the left hand... Photo D: ...and continues the whipping motion... Photo E: ...of an Iron Palm Tan Sau used as a strike to the side of B’s neck. Photo F: After the strike, Fighter A drops his still-extended left arm to clamp B’s left arm under it as he delivers a second Long Bridge Iron Palm slap to the ear. Photo G: With a sharp pivot of the hip for power, Fighter A strikes B’s other ear with another Long Bridge Iron Palm slap with the left palm from its previous low-line position. Photo H: Retracting his striking arm to be used for added momentum, Fighter A chambers his left leg... Photo I: ...for a Chai Wahng Gyeuk Scraping Side Kick. Note that in this case, the hand was used to add extra power into the kick by drilling the arm down to Dai Boang Sau position and completing that motion a split-second before the kick finishes scraping down the leg. This action helps put additional bodyweight into the kick, and is the opposite of the usual Plant/Trap/Hit concept of using the descending momentum of the leg to add power to a hand technique after a kick.

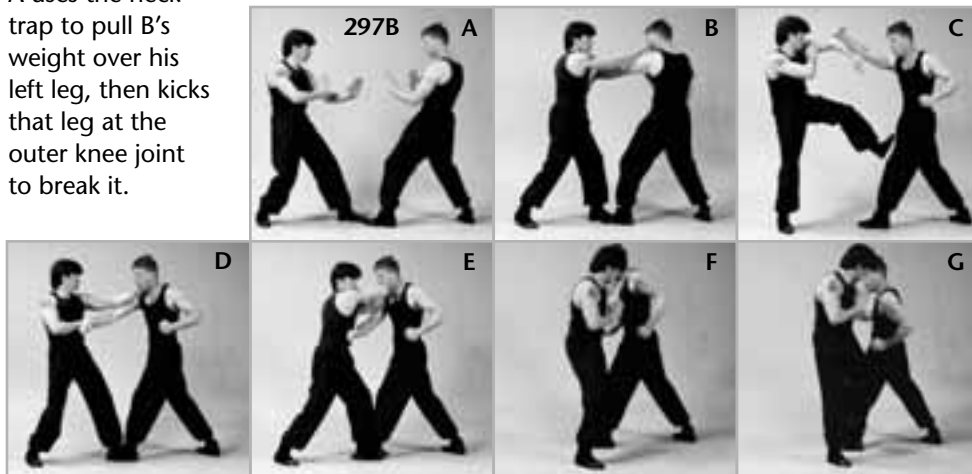


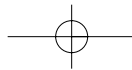
San Sau—Practical Applications



**297B**—*Photo A:* Fighters are facing each other in a Closed ready position. *Photo B:* Fighter A stops B's jab using Tan Da. *Photo C:* As B throws the cross, A defends with Boang Sau/Wahng Gyeuk. *Photo D:* Fighter A puts his foot down to the outside as he circles his hands into Lop Sau Chahng Jyeung. *Photo E:* Converting the "Spade Palm" to a neck trap, Fighter A pulls B into a Pai Jahng elbow smash to the face... *Photo F:* ...then, keeping the neck trap, steps forward and to the right with his rear right leg... *Photo G:* ...and circles his left leg into Huen Wahng Gyeuk to the outer left knee. Note that

A uses the neck trap to pull B's weight over his left leg, then kicks that leg at the outer knee joint to break it.

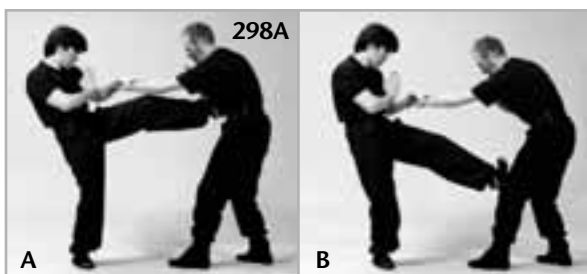




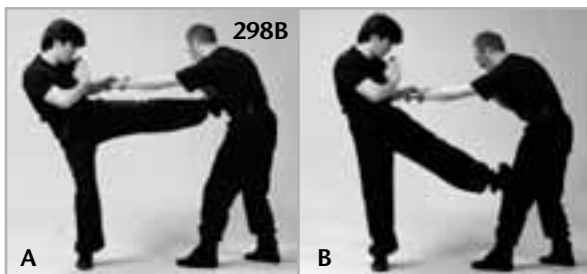
### Close Range Combat Wing Chun: Volume Three



**Fig. 298**—The simultaneous double Inward Jerk/Nailing Front Kick, shown from above, illustrates the principle of pulling the opponent into a kick. This principle is applied in many ways, three of which are seen here, where Fighter A uses a Lop Sau grab to jerk the opponent into Front Kick and Side Kick attacks at various levels.

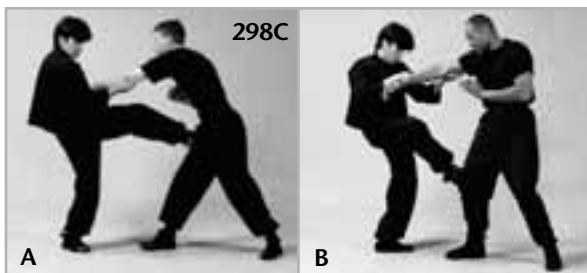


**298A**—Photo A: Fighter A pulls B into a Front Kick to the mid-section. Photo B: Since he hasn't changed kicking structure, Fighter A changes levels for his second Jing Gyeuk attack.



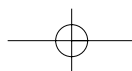
**298B**—Photo A: Fighter A again pulls B into a kick, this time a Side Kick to the body. Photo B: Because he is using another Side Kick, Fighter A again uses a change of levels for additional kick power. Pulling the opponent into a kick also helps increase power and prevents the opponent from moving

back to evade or absorb the kick. It also allows the Wing Chun fighter to continue the attack as he cannot be thrown back out of range by the kick's impact.



**298C**—Lai Sau/Jing Gyeuk, discussed previously in fig. 284C, uses the principle of pulling the opponent into a kick to borrow his power and prevent him from falling backward to absorb any of the impact. Pulling the opponent into a kick also allows the Wing

Chun man to retrap and strike in a Plant/Trap/Hit motion on the way down.



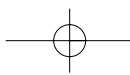
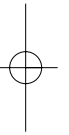
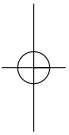
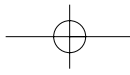
### San Sau—Practical Applications



*Fig. 299—Similarly, the upward lift/downward stomp of Syeung Pau Jyeung/Chai Sut Dai Gyeuk can be applied directly to push the opponent's arms or body upward while kicking downward with a splitting action. Its principle, however, is the underlying concept of many other Complex Kicking Attacks that use a two-way splitting action to manipulate the arms or body upward*

*while kicking downward. Photos A and B illustrate one such technique, as Fighter A deflects the punch inward with Pock Sau while focusing his kick power downward to the leg an action that stretches his opponent in two directions and capitalizes on the misdirected punch power that raises his bodyweight upward to be met head-on by a kick. The same principle is at work in photo C, but this time a counterpunch is added to the slap block/kick combination.*

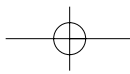






# “YUT DING FOT”





### Close Range Combat Wing Chun: Volume Three

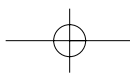
---

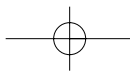
As the reader has no doubt by now come to realize, the number 108 holds some significance in Wing Chun Gung Fu, with each of its six forms being made up of 108 individual motion patterns. As the Siu Leem Tau proverb goes, “*Jiu Sick Yut Ling Bot, Sut Yoang But Hoy Ga,*” meaning, “There are one hundred and eight motions, all practical and real.”

The serious student of Gung Fu may wonder why this particular number features so prominently not only in Wing Chun, but also in nearly every Chinese martial art system. For example, most of the traditional forms of many Tai Chi Chuan styles are also made up of exactly 108 movements. This fascination with the number 108 permeates many layers of Chinese culture, including religion and science, and is even considered a lucky number by gamblers, due to the similarity of its Cantonese pronunciation, *Yut Ling Bot*, to the catchphrase “*Yut Ding Fot,*” which means “Definite Success,” or “Can’t Lose.”

The root of the association of the number 108 with bravery, purity or success can be traced back to the fact that early Chinese astronomers based a complex system of lunar mathematics on a certain set of stars they had discovered which numbered one hundred and eight. The number itself, being divisible by three, another significant number to the Chinese, has all the mathematical properties and permutations that come with being a multiple of three. The possibilities are intriguing to the mathematical mind. If each number by which 108 is divisible is written in series as follows: **1 2 3 4 6 9 12 18 27 36 54 108** many interesting correlations can be seen. For example if the sequence of numbers from 6 to 36 are added together, they total 108. The first two numbers (1 and 2) added together make the third (3). From there it will be found that many numerical coincidences exist within that sequence. The second and third (2 and 3) multiplied make the fifth (6) and the third and fifth (3 and 6) when added make the sixth (9) and when multiplied make the seventh (18). Numerous other such relationships between these figures can be found.

To the ancients, the remarkable properties of this number may have inspired them to believe it to possess some form of power, which in turn would bring luck and prosperity when used properly. To the western mind, this might seem a bit farfetched, but even in today’s modern society in the Far East and Southeast Asia, the Westerner will find the culture steeped in religion and superstition in which numbers play a large part. In many temples, such as the *Syeung Lum Jee* in Singapore, the tower bell at that Shaolin Temple is sounded exactly 108 times each day to signify the 108 sins committed by man. 108 figurines depicting various forms of Boddhisattva as can also be seen adorning the walls of the Lohan Hall there.

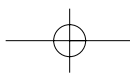
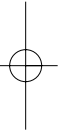
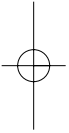


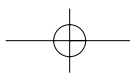
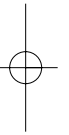
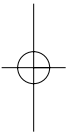
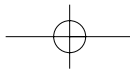


## “Yut Ding Fot”

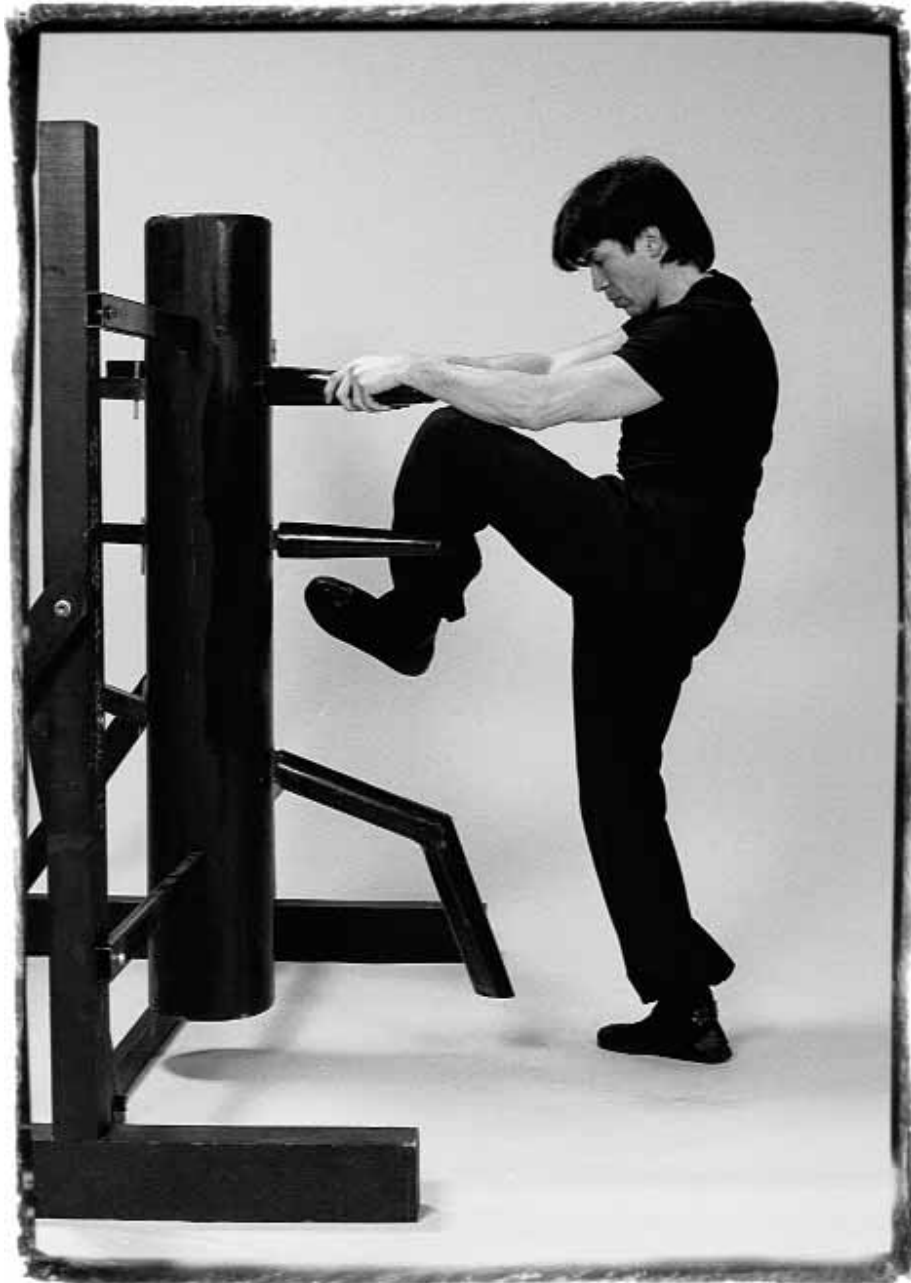
In a more superstitious vein, many Chinese people have “favorite numbers” which are based on the similarity of their pronunciation to certain lucky phrases. For example, the number 118, or *Yut Yut Bot* as it is known in Cantonese, is thought to sound similar to “*Yut Yut Fot*,” or “Success every day.” Another such lucky number, 328, is favored by shop owners for its similarity in pronunciation to *Som Yee Fot*, meaning “Prosperous business.” Conversely, the number 4 is a homophone for “death” in Chinese, and so is a very unpopular number to have, for example, as an address. In fact, this number-based superstition is very similar to the Western concept of “Lucky 7” and the negative aspects sometimes associated with the number 13.

Many other such numbers exist, but the king of all lucky numbers to the Chinese remains “*Yut Ding Fot*”—“Definite Success.”



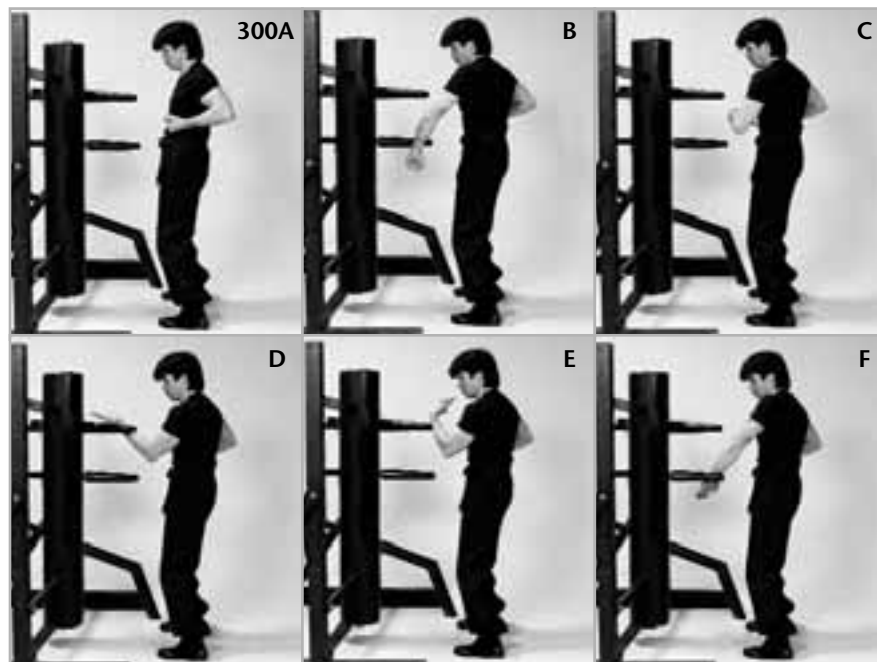


# WOODEN DUMMY DRILLS

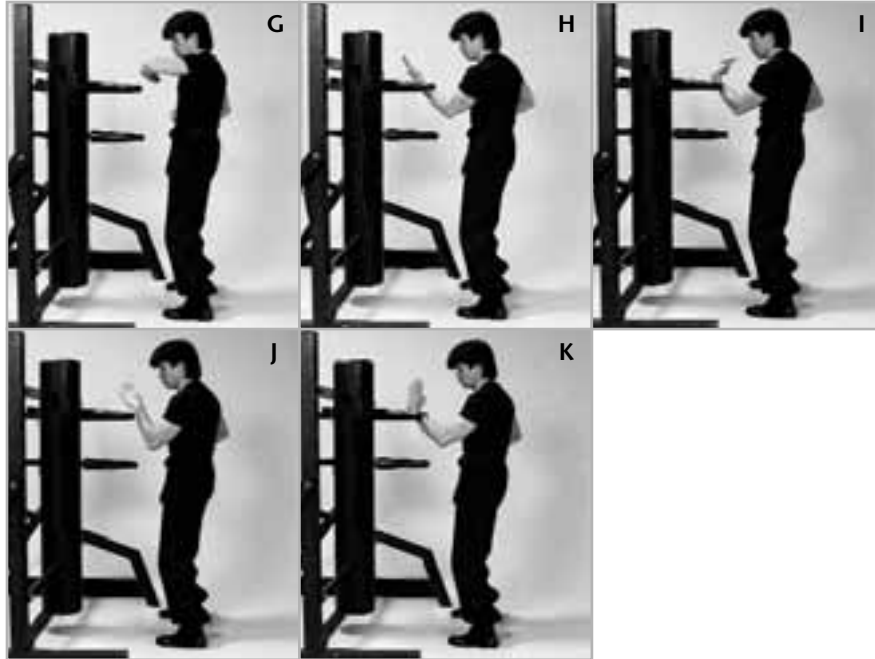


Close Range Combat Wing Chun: Volume Three

**Fig. 300**—Gock Ng Sing. Beginning in “Yee” Jee Keem Yeung Ma position, facing the Dummy at the correct distance on the Semicircle (photo A), execute a left Inside Gahng Sau (photo B) with the fist closed. Contact with the low Dummy arm should be made at the wrist in the spot where your watch face would be. Next, open the left hand and, with the wrist sharply bent, turn it palm-up with the fingers pointing back toward yourself (photo C). In a counter-clockwise circular whipping motion that unloads the wrist, bring the hand up between the upper Dummy arms to strike the inner left Dummy arm with Tan Sau (photo D). At the completion of the motion, the back of the hand and wrist should form a Natural Hand Hook, exerting downward/forward/outward pressure. Next, snap the left wrist inward, closing the last three fingers and pinching the thumb and index finger together (photo E). Circle the arm down to Gahng Sau, bringing the hand near to, but not touching the right side of the chest, unloading the chambered wrist and hand at the end (photo F). Keeping the palm turned away from yourself, bring the hand up and slightly to the right of the Centerline (photo G) to begin a counter-clockwise circle of the hand to Jom Sau, which strikes the inner right Dummy arm (photo H). Snapping the wrist toward yourself with the same three-fingers closed/two-pinched Huen Sau structure (photo I), circle the wrist (photo J) into Woo Sau (photo K), making contact at the inner left Dummy arm. Repeat this sequence on the opposite side. This drill was shown with a partner in fig. 121 of Volume I of this series.



Wooden Dummy Drills



**Fig. 301—Tan Da/Gahng Da.** Starting from double Pau Sau position (photo A), snap the left wrist inward with the palm down on the Centerline as you drop the right fist palm-up to the outside right (photo B) to begin an Outside Whip punch. Pivot the stance to the left as the Tan Sau makes contact at the inner left Dummy arm, and the inner forearm of the punching arm contacts the outer right Dummy arm (photo C). Note that, although the fist does not make actual contact with the surface of the Dummy trunk, the resistance created by the inner forearm contact of the punching arm has the same recoil effect on that arm as fist contact would have had, but without damaging the fist. Next, open the right fist and snap the wrist downward (photo D) to begin a circling motion (photo E) that chambers the wrist and whips the left fist outside for the next Tan Da, which is executed in time with a stance pivot to the right (photo F). Open the left fist and snap the hand inward (photo G) to chamber for a left-pivoting Gahng Da (photo H), again “including” the right Dummy arm with inner forearm contact that substitutes for fist impact. Next, open the right fist and snap it inward (photo I) and bring the left fist palm-up and to the outside left (photo J) to load up for a right-pivoting Gahng Da (photo K). The Tan Da/Gahng Da sequence is shown in application in photos L–N.

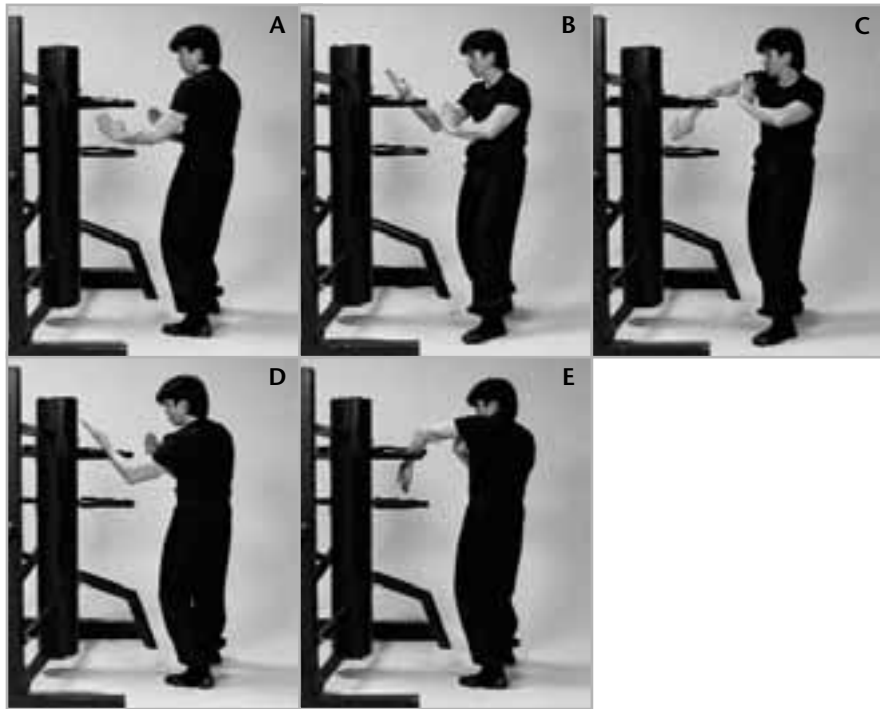
### Close Range Combat Wing Chun: Volume Three

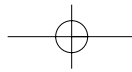




## Wooden Dummy Drills

**Fig. 302**—Jom/Boang/Jom. Starting from a right Choh Ma position on the Semi-circle (photo A), pivot to the left with a right Jom Sau that makes contact at the outer right Dummy arm (photo B). Next, without moving the stance and using a “jack-knife” motion of the arm, raise the right elbow and open the arm outward and upward into Boang Sau position (photo C). To begin the other side, pivot to the right with a left Jom Sau to the outer left Dummy arm (photo D). Then, with another “jack-knife”-like retraction and opening of the left arm, bring the forearm up between the Dummy arms to strike the lower inside of the right Dummy arm with Boang Sau (photo E).

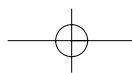




## Close Range Combat Wing Chun: Volume Three

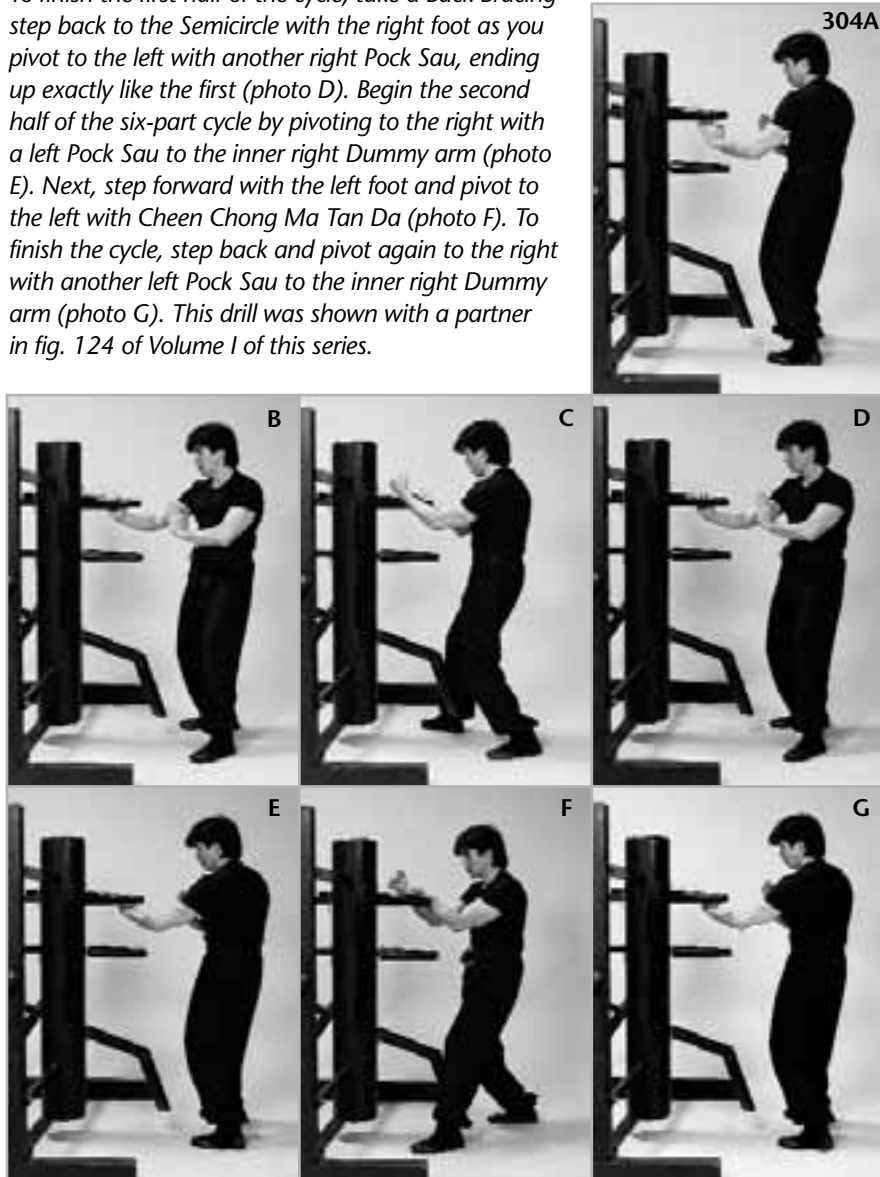
### Yut Fook Yee Drills

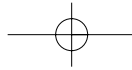
**Fig. 303—Pock, Tan Da, Pock Straight Punch Drill.** Starting from a right Choh Ma position on the Semicircle (photo A), pivot to the left with a right Pock Sau that contacts the inner left Dummy arm from the inside (photo B). Then pivot to the right with Tan Da, making contact with the inner left forearm on the outer left Dummy arm instead of punching the Dummy (photo C). To finish the first half of the cycle, pivot again to the left with another right Pock Sau, exactly like the first (photo D). Begin the second half of the six-part cycle by pivoting to the right with a left Pock Sau to the inner right Dummy arm (photo E). Next, pivot to the left with Tan Da, making contact at the inner left and outer right Dummy arms (photo F). To finish the cycle, pivot again to the right with another left Pock Sau to the inner right Dummy arm (photo G). This drill was shown with a partner in fig. 123 of Volume I of this series.



### Wooden Dummy Drills

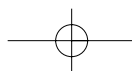
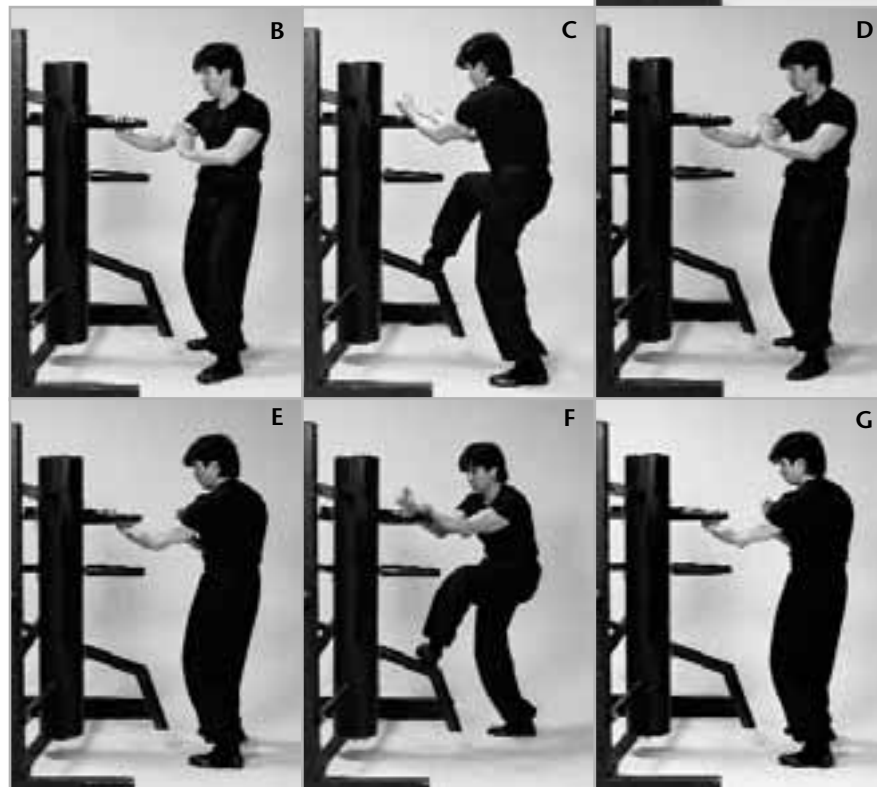
**Fig. 304**—Pock, Tan Da, Pock Straight Punch Drill with Bracing. Starting from a right Choh Ma position on the Semicircle (photo A), pivot to the left with a right Pock Sau that contacts the inner left Dummy arm from the inside (photo B). Then step with the right foot as you pivot to the right with a Front Bracing Tan Da, making contact with the inner left forearm on the outer left Dummy arm (photo C). To finish the first half of the cycle, take a Back Bracing step back to the Semicircle with the right foot as you pivot to the left with another right Pock Sau, ending up exactly like the first (photo D). Begin the second half of the six-part cycle by pivoting to the right with a left Pock Sau to the inner right Dummy arm (photo E). Next, step forward with the left foot and pivot to the left with Cheen Chong Ma Tan Da (photo F). To finish the cycle, step back and pivot again to the right with another left Pock Sau to the inner right Dummy arm (photo G). This drill was shown with a partner in fig. 124 of Volume I of this series.





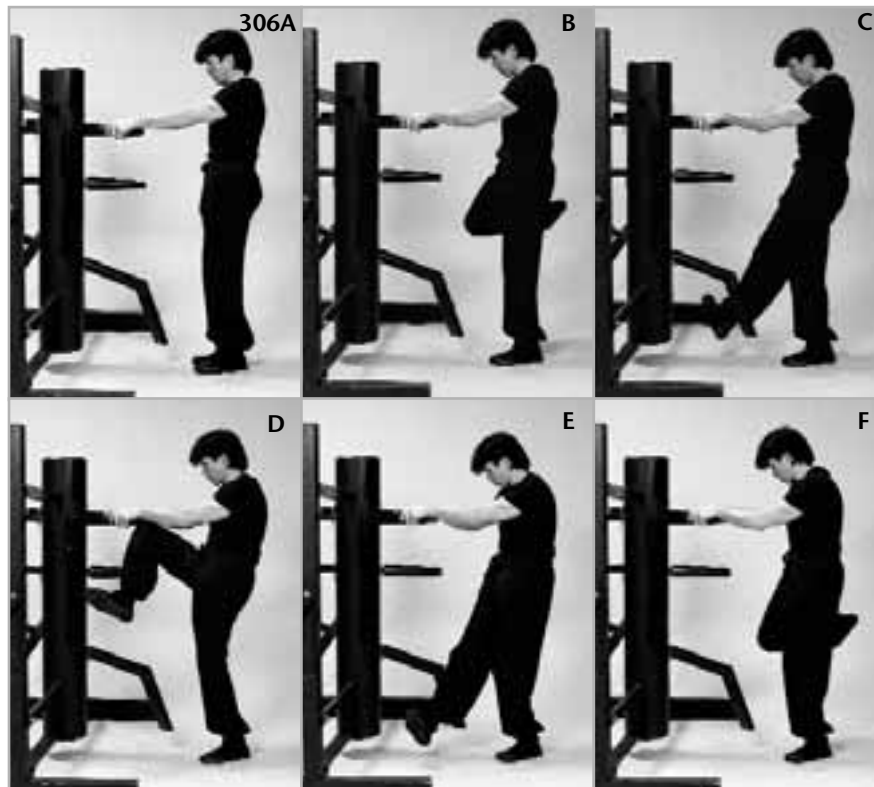
### Close Range Combat Wing Chun: Volume Three

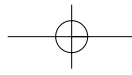
**Fig. 305**—Pock, Tan Da, Pock Straight Punch Drill with Kick. Again starting from a right Choh Ma position on the Semicircle (photo A), pivot to the left with a right Pock Sau (photo B). Step slightly to the left on the Semicircle with the left foot and strike the Dummy with Tan Da on the high line as you stomp the Dummy leg with Jing Gyeuk (photo C). Unlike actual combat, where the hands will slightly precede the foot, the hand and foot contact occur simultaneously when training on the Dummy. To finish the first half of the cycle, plant the kicking foot as you pivot again to the left with another right Pock Sau, exactly like the first (photo D). Begin the second half of the cycle by pivoting to the right with a left Pock Sau (photo E). Next, step slightly to the right on the Semicircle with the right foot and pivot to the left with Tan Da as you kick the Dummy leg (photo F). To finish the cycle, put your kicking foot down and pivot again to the right with a left Pock Sau (photo G). This drill was shown with a partner in fig. 125 of Volume I of this series.



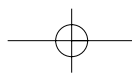
Wooden Dummy Drills

**Fig. 306—Gahng Gyeuk.** The exercise begins with the trainee facing the Dummy with the feet together, grabbing the two upper Dummy arms with the arms locked out at shoulder-level (photo A). The trainee swings his right leg outward and upward (photo B) to chamber for the first motion, then extends a forward/inward Gahng Gyeuk to the Centerline with the right leg, making contact at the lower inner shin on the right side of the Dummy leg (photo C). Without putting the foot down, the trainee circles his shin to the outside, raising the knee to diaphragm-level as the upper/outer shin makes contact with the left side of the low Dummy arm in Tan Gyeuk structure, knee pointing outward (photo D). The leg then snaps downward to full extension in Ngoy Jut Gyeuk structure, making contact with the left side of the Dummy leg at the rear low center of the calf, near the ankle (photo E). Still without putting the right foot down and remaining in Dook Lop Ma position, the trainee moves the calf and foot in a counter-clockwise circle back to Gahng Gyeuk position, using the knee as a pivotal point (photos F and G). The cycle is then repeated so that the legs have made contact a total of six times (photos H and I) before the right foot is put down (photo J) and the pattern is repeated on the other leg (photos K–S). This drill was shown with a partner in fig. 224 of Volume II of this series.

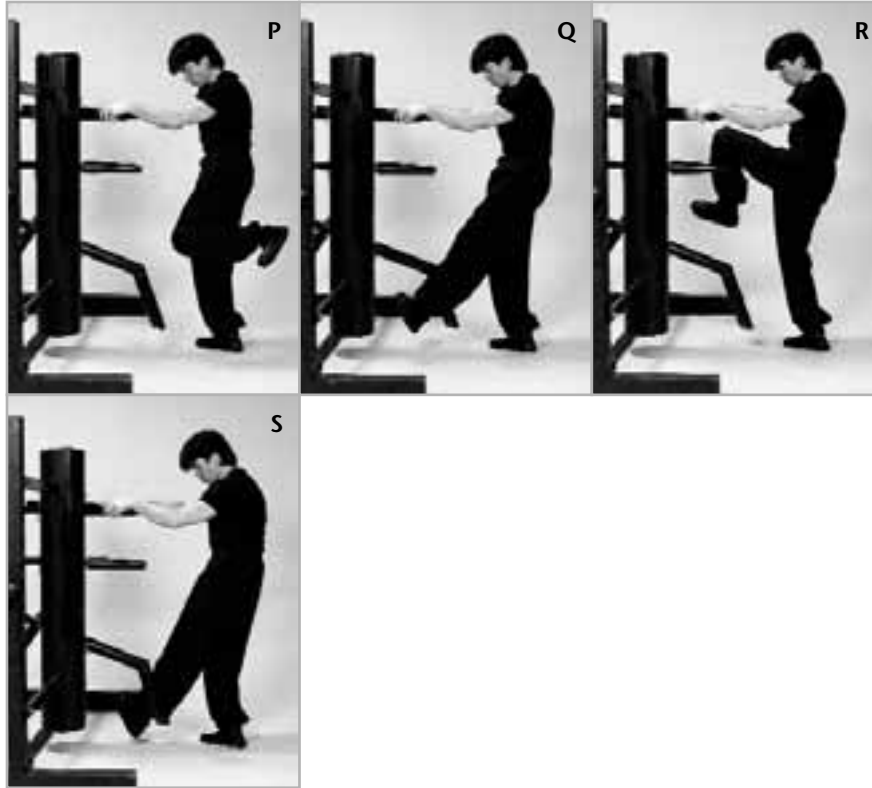




Close Range Combat Wing Chun: Volume Three

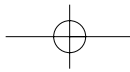


Wooden Dummy Drills

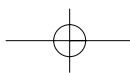


**Fig. 307**—Moh Ying Gyeuk. The exercise also begins with the trainee facing the Dummy with the feet together, grabbing the two upper Dummy arms at shoulder-level (photo A). Raise the left knee to strike the underside of the low Dummy arm with Tai Sut (photo B). Without putting the foot down between motions, kick the Dummy on the Centerline in the area between the low arm and the leg with Moh Ying Deng Jing Gyeuk (photo C). Next, pivoting on the heel of the base foot, turn the hip and twist the foot into an “invisible” Moh Ying Wahng Gyeuk (photo D). Using the second form of Moh Ying Gyeuk, the Jumpswitch, make a mid-air switch from the left leg to the right Tai Sut (photos E and F). Then execute a right “shadowless” Front Kick (photo G), followed by a Side Kick (photos H and I), still without putting the foot down. Another Front Kick can be added to the sequence on both sides as well (photo J).





Close Range Combat Wing Chun: Volume Three







### Close Range Combat Wing Chun: Volume Three



*Teet Sa Jyeung*, or “Iron Sand Palm,” is a skill developed by many styles of Chinese Gung Fu which have their roots in the Shaolin Temple. According to ancient writings, Shaolin monks practiced an early form of Iron Palm training by first soaking the hands in water of gradually increasing temperatures and then drying them by shaking them in the air while directing Chi to the fingertips. This was in conjunction with another form of training in which the hands were repeatedly thrust into a basin filled with a mixture of dried black and green peas or sand.

In Wing Chun Iron Palm training, each area of the hand is conditioned by slapping, grabbing, poking, chopping and punching the surface of a canvas bag filled with beans, beans and sand or sand alone, depending on the individual trainee’s development. When executed properly, this conditioning does not damage the hands, arms or body in any way, nor does it cause any significant change in the natural appearance of the hands. It can, however, enable the trainee to make his hands as hard as iron when desired, hence the name.

#### **Types of Iron Palm Training**

Although various schools of Chinese Gung Fu differ in their methods of Iron Palm development, there are two main types of *Teet Sa Jyeung* training—Direct and Indirect. “Direct Training” means making direct contact with the peas, beans or sand, and can be classified as *Yang* (External or Hard) in nature. “Indirect Training” involves the use of a canvas sheet between the peas, beans or sand and the surface of the trainee’s hand. The canvas acts as a sort of cushion between the hard surface of the granules and the hand or elbow. This method follows the *Yin*, or Internal, principle and is superior to the hard method. Wing Chun, being an Internal art with equal emphasis being placed on both the hard and soft aspects, adheres to the latter.

### EQUIPMENT NEEDED

In order to develop the Iron Palm, the trainee will need the following items:

- 1) Unmounted sandbag
- 2) Iron Palm table
- 3) Wall-mounted Sandbag
- 4) Training Liniment (*Leen Goang Jau*)

Each will be discussed here.

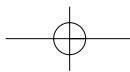
1) **Sand Bag**—The Sandbag (*Sa Bau*) used for Wing Chun Iron Palm training is approximately one foot square, four to five inches thick when filled, and made of a tough resilient fabric (usually canvas). Depending on the level of the trainee, the *Sa Bau* can be filled with a mixture of dried green and black peas, available through most Asian grocers, an even blend of peas and sand, or simply sand alone. If peas or beans are used, once they have been pulverized after an extended period of training, they should be replaced with a mixture of peas and sand, gradually increasing the percentage of sand with each replacement of the filling until nothing but sand fills the bag.

The main sandbag used in Iron Palm training is placed on a table and hit with a sequence of ten strikes designed to condition all parts of the hand and elbow used in Wing Chun striking. A similar sequence can be performed on the wall-mounted sandbag normally used in all Wing Chun schools for regular punching drills and other striking exercises.

2) **The Iron Palm training Table**—Any sturdy waist- to chest-level table will suffice for Iron Palm training, however, the best results are obtained by using a table with a slightly sloping top surface to create the optimum angle for contact of each Iron Palm strike. A simple, easy-to-build, yet effective table can be constructed from the type of angle iron that can be purchased from most hardware stores. Plans to build this table can be found at the end of *The Ten Iron Hand Motions* essay. The measurements given on those plans will suit a trainee of average height, but are easily adjusted to individual preference.

3) **The Wall-mounted Sandbag**—The same sandbag described earlier can be used for Iron Palm training as well as standard punching and kicking drills. It should be mounted on safely rounded hooks through grommeted holes in the corners of the bag against a heavy brick or concrete wall. Alternatively, if no such wall is available to the trainee, the vertical support uprights of the Mook Yan Joang can be used.

4) **Leen Goang Jau**—One of the most important aspects of Teet Sa Jyeung training is the proper use of medication in conjunction with correct technique. To this end, the Wing Chun trainee must always apply a generous amount of herbal liniment to the hands and elbows before and

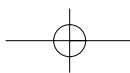
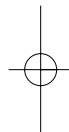
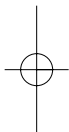


### **Close Range Combat Wing Chun: Volume Three**

---

after striking the sandbag using the ten Iron Palm hand formations. This medication is vital in the prevention of injury and the strengthening of the skin, bone, tendons and muscles of the hand and arm, and will be the subject of a subsequent heading of this essay.

Using the correct equipment with proper technique and medication can bring about substantial Iron Palm development in less than one year's time, depending on the frequency and regularity of training.



# EFFECTS OF IRON PALM TRAINING

Traditionally, Teet Sa Jyeung training has been shrouded by a veil of mystery and secrecy, with many legends of nearly miraculous feats of killing animals without leaving any external signs of damage, yet leaving their internal organs badly damaged. Other legends tell of various masters that could smash at will any individual brick or tile selected in a stack without damaging any of the other pieces in that stack by simply slapping downward with an open palm. These stories are not to be disregarded.

Although board and brick breaking can be an accurate gauge of Iron Palm development, the ultimate test of Teet Sa Jyeung skill is the effect of a strike on a human being. The damage that can be inflicted by a relaxed, heavy-handed slap, chop or punch can only be guessed unless the need for such tactics arise in an actual combat situation, in which case the results are devastating. Speaking from personal experience, the author can assure that having developed the Iron Palm skills can make the difference between a quick victory and a long, drawn-out fight.

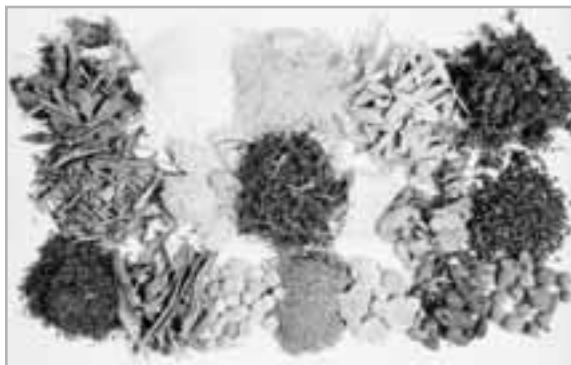
## Leen Goang Jau

Due to the potentially damaging effects of striking a tightly packed sandbag, it is vital to the trainee to apply medication known as *Leen Goang Jau*, or “Power Training Wine,” to the hands before and after an Iron Palm session. Striking the hard, abrasive surface of the sandbag without proper medication poses the risks to the trainee of bruising and disrupted blood circulation. If carried on for extended periods, Iron Palm training without medication can result in severe injury to the hands, arms and even the internal organs.

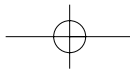
The formula seen on the opposite page for the blend of Leen Goang Jau used by the author should be mixed with some form of consumable alcohol such as rice wine, brandy or whiskey, although it is *never* to be taken internally under any circumstances. The ingredients for making this formula, shown in individual piles at far right below the prescription, can be obtained through any Chinese pharmacy. The pharmacist will also be able to recommend the best wine to mix it with. It is very important that an alcohol base is used in the making of Leen Goang Jau; alcohol is rapidly absorbed through the pores and into the muscle tissue, carrying with it the herbs. After carrying the medication deep into the hands, the alcohol then quickly evaporates, leaving the herbs of the liniment to perform their function. Besides this advantage, alcohol-based Leen Goang Jau helps to relieve pain and bruising.

Close Range Combat Wing Chun: Volume Three

Fig. 308—This prescription for the Leen Goang Jau formula can be filled at any Chinese herbalist shop, many of which are to be found in the Chinatown areas of most major cities.



铁沙掌方  
 川乌 川乌 南星 蛇床子 半夏  
 百部 红花 川椒 狼毒 龙骨  
 透骨草 海浮石 地骨皮 紫花  
 地丁 木通 青盐 硫黄  
 花椒皮



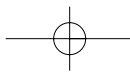
## Effects of Iron Palm Training

---

Although an oil-based medication will carry the herbs into the hand, it takes a longer period to evaporate and is less effective. Vinegar-based medication should not be used as, over extended periods, it causes the bones to become brittle and subject to breakage upon hard contact. Using a water-based liniment causes pain in the hands.

After a period of training with proper medication, the effects of the Leen Goang Jau are absorbed into the muscle tissue of the hands and the trainee will no longer suffer pain and bruising, even after grueling sessions that would leave an untrained hand raw and bleeding. In fact, after a few months of this training, the hands begin to develop a type of “itching” or tingling during sandbag punching that encourages the trainee to punch even harder without fear of damaging the hand.

As mentioned earlier, the hands should also be soaked in medicine after training to soothe the bones and tendons as well as to toughen the skin of the hands. This toughening prevents further injury and allows the trainee to develop his Iron Palm skills more quickly. Although medicating the hands might at first seem unnecessary to a young, strong trainee, the Iron Palm practitioner should heed the fact that much of the damage done to the tiny blood vessels of the hand by training without Leen Goang Jau may not manifest itself until many years after the initial damage is done. This damage usually comes in the form of an uncontrollable shaking of the hands as well as other involuntary muscle spasms. As the main point of all Gung Fu training is self defense and development, which encompasses the health and well being, it is counterproductive and contradictory to intentionally risk damaging the body through the very training performed for its benefit.



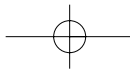
Close Range Combat Wing Chun: Volume Three

Fig. 309—This prescription is for Teet Da Jau can be filled by any Chinese herbalist.



忘食跌打药粉  
 澤蘭五小 川芎八小 川红花八小 冰片二小  
 王虎骨刃 淮牛七刃 骨碎補刃 虎仁刃  
 白芷五小 金蝎廿条 班秋虫廿条 川续断刃  
 防风刃 血山枝刃 正西归尾刃 衣香附刃  
 正末药五小 正大田七18刃 北细辛五小 廣木香五小  
 沉香五小 正乳香五小 正血竭五小  
 共23味为末



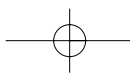
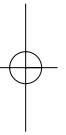
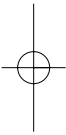


# THE IRON PALM TRAINING SEQUENCE

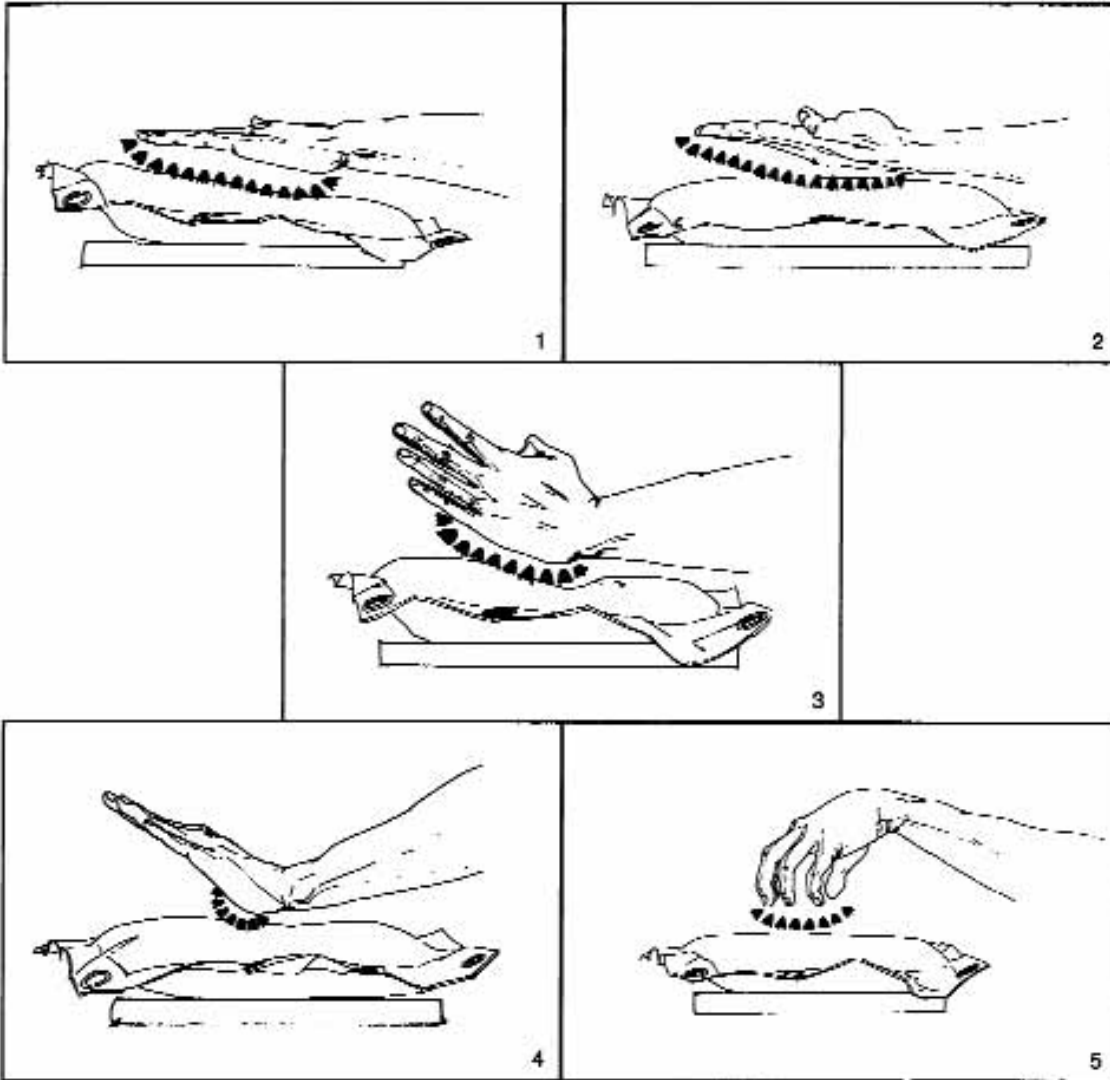
Before beginning the Teet Sa Jyeung training sequence, the student should either submerge the hands in a small basin filled with Leen Goang Jau or should apply a generous amount of the liniment to the hands and elbows. After a short period of allowing the alcohol to carry the herbs into the hands, the trainee is ready to begin the Iron Palm sequence. Select a quiet location away from any potential distraction. This is to allow full concentration on the task at hand and the ability to use the mind to direct the Chi properly. Lack of concentration will obstruct the flow of Chi and the directing of power, resulting in a wasted effort.

Once the proper setting is selected, the trainee should take a moment to concentrate on his goals for Iron Palm development and to achieve a frame of mind conducive to the attainment of those goals. Mental preparation is a key factor in achieving higher skill levels.

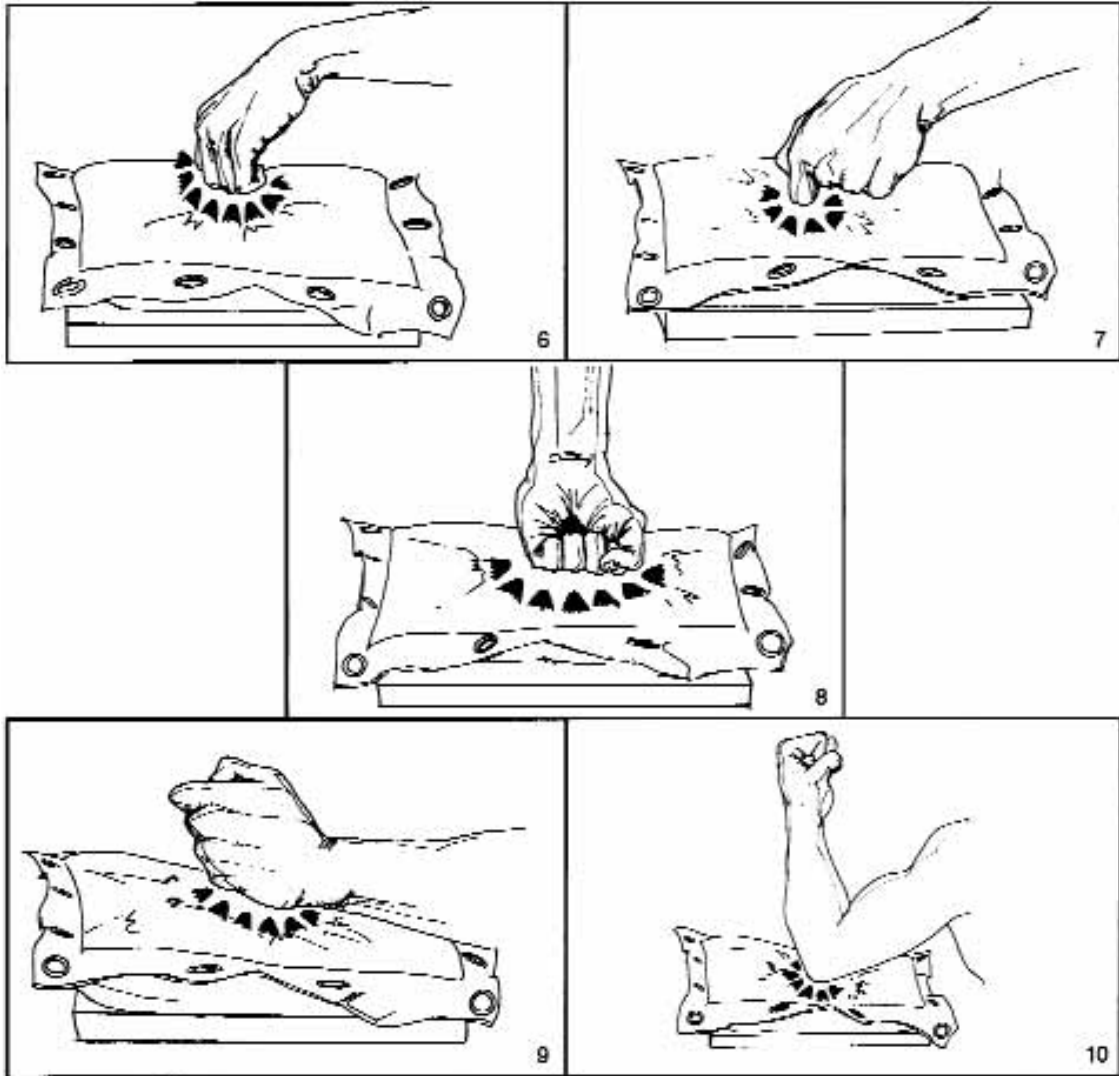
The entire sequence of ten hand positions can be performed in either a kneeling position or standing before the Iron Palm table in “Yee” Jee Keem Yeung Ma position. The sandbag should be between waist- and chest-level so that the palm, backhand, knuckles and elbow can make contact with its sloping surface at an angle, which allows proper bone alignment and correct structure in the various strikes of the sequence.

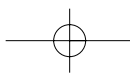
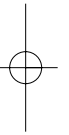
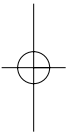
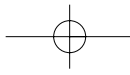


Close Range Combat Wing Chun: Volume Three



### The Iron Palm Training Sequence





# THE TEN IRON HAND MOTIONS

Within the Wing Chun Iron Palm pattern, there are ten different hand formations used to strike the bag. Each position has a different striking surface, and therefore trains the entire palm, backhand and palm edge as well as the inside, outside and tips of the fingers. In addition, all the knuckles of the fist, the first knuckles of the fingers, and the elbow points are toughened and conditioned by these open- and closed-handed blows. The ten Iron Hand motions are:

1. Downward Slap
2. Backhand Slap (Tan Sau)
3. Downward Chop (Chum Sau)
4. Palm Heel Snap (Jing Jyeung)
5. Downward Fingertip Poke
6. Ginger Fist Knock (Gyeong Jee Kuen)
7. "Phoenix-Eye" Punch (Foong Ngon Kuen)
8. Undercut Punch
9. Hammer Fist (Chuo Kuen)
10. Downward Elbow Butt (Chum Jahng)

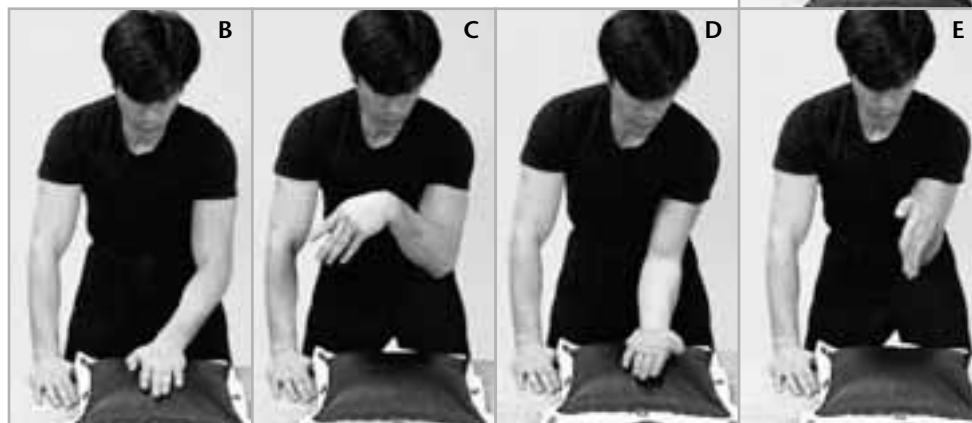
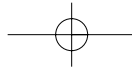
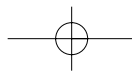
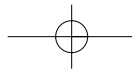


Fig. 310—Analysis of the 10 hand formations.



Close Range Combat Wing Chun: Volume Three





### The Ten Iron Hand Motions



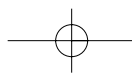
**Downward Slap**—To begin the Iron Palm sequence, raise the hand to chest-level, bending the wrist to chamber the palm in a level position (photo A). Keep the shoulder and arm relaxed, and allow the hand to slap down freely on the bag. At the completion of the motion, the wrist should be fully unloaded from the chambered position with the fingers allowed to spread naturally (photo B).

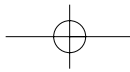


**Backhand Slap**—After completing the downward slap, raise the palm again to chest-level with the wrist bent and the hand snapped inward (photo C). Using the elbow to whip the hand downward, bring the backhand down on the bag with a relaxed flip of the wrist, making the hand “heavy” (photo D).



**Downward Chop**—Turning the hand thumb-up, raise it to chest-level as the wrist chambers upward in Ngoy Jut Sau structure (photo E). Unload the wrist with a sharp snap, chopping downward on the bag (photo F).





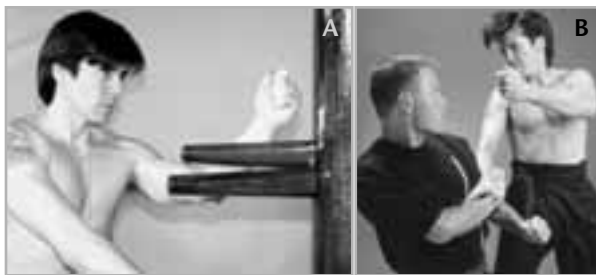
### Close Range Combat Wing Chun: Volume Three



**Palm Heel Snap**—Again raising the hand to chest-level with an upward bend of the wrist (photo G), snap the palm heel downward with a sharp unloading of the wrist that brings the fingertips up off the surface of the bag as the heel digs in (photo H).

**Fingertip Poke**—Reload the wrist as it is brought back to chest-level (photo I). With a sharp downward whip of the hand, strike the bag with the tips of all five fingers (photo J).

**Ginger Fist Knock**—Without moving the arm too far upward, snap the wrist backward as the hand closes to a half-formed fist (photo K). Keep the wrist loose and strike downward on the bag with a knocking motion of the first knuckles of the fingers. The thumb should be held tightly against the outside of the index knuckle to support the fist structure (photo L).

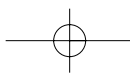


**“Phoenix-Eye” Punch**—Beginning with an inside-whipping circle of the fist and forearm (photos M and N) bring the fist down on the bag with the index knuckle supported by the thumb and protruding out from the fist so that it strikes the bag first before the entire

fist bores into the bag, digging the index knuckle in deeper than the other knuckles (photo O).



**Undercut Punch**—Keeping the elbow near the body, turn the fist upward as it begins to circle downward and to the outside of the bag in an outside-whipping motion (photo P). Continue circling upward as the fist makes a sudden inward twist before dropping down on the bag with the elbow raising directly above it to support the structure of the punch by keeping the





## The Ten Iron Hand Motions

bones of the hand, wrist and forearm in line (photo Q). At the completion of the Undercut Punch, the thumb should be wrapped across the front face of the fist.

**Hammer Fist**—Raise the punching hand toward the opposite shoulder and begin an inside whipping motion of the fist by quickly bringing the elbow down and in near the body (photo R). The shortened arc of the elbow whips the hand downward as the thumb moves to the inside of the index knuckle, supporting the structure of the fist as it makes contact with the bag (photo S).

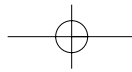


**Downward Elbow Butt**—Raise the arm, placing the elbow directly above the bag as the hand opens at head-level with the palm facing inward (photo T). Sharply twist the wrist as you bring the elbow down on the bag with a forward lean (photo U). In more advanced stages of Iron Palm training, the fist should be clenched and twisted inward at the moment of impact to add Juen Ging Whirlpool Energy to the strike.

These ten strikes can be practiced in a sequence, alternating from one hand to the other, or any one or combination of the strikes can be repeated in series. Training should stop if the skin of the knuckles is broken as it is important that the hand is not damaged and is given at least a day to rest before another session. As the hand becomes accustomed to the training, the length of the sessions can increase to up to 108 repetitions of each position on both sides.

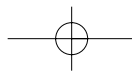
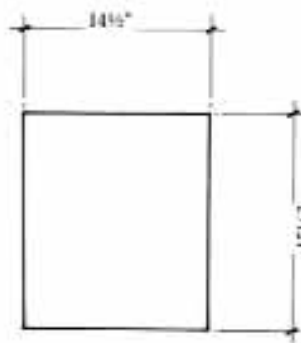
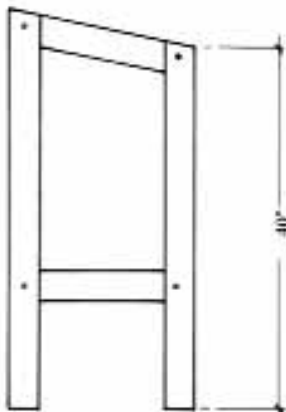
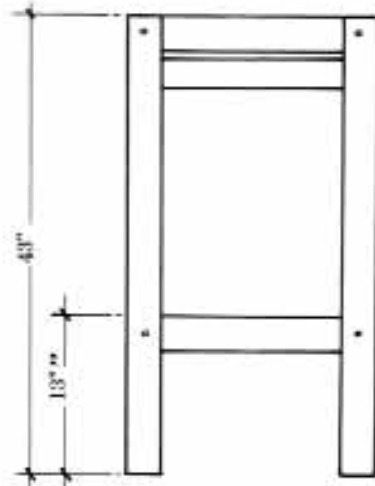


After training, Leen Goang Jau should be reapplied and the hands should not be washed for at least an hour afterward to prevent moisture from entering the pores and causing pain in the bones of the hand.



Close Range Combat Wing Chun: Volume Three

*Iron Palm Training Table Plans*



# ACKNOWLEDGEMENTS

*The author would like to extend his gratitude to the following people, without whose help the production of these books would not have been possible:*

Sue Arbogast (CRCA VT)—Layout, editorial, proofreading and organization  
Don Berry (CRCA MD)—Proofreading  
Victor Botes (CRCA Capetown, South Africa)—Proofreading  
Jose Fraguas—Editorial and photography  
Patrick Gross—Book design and layout  
Bert Hill (CRCA MD)—Layout, editorial, proofreading and organization  
Jaimee Itagaki—Photography  
Wayne Jackson (CRCA MD)—Layout, editorial, proofreading and organization  
Mark Komuro—Technical and artistic assistance  
Joyce Low Tay Tin—Chinese translations  
Mike Pologruto (CRCA VT)—Proofreading  
Sam Sanguedolce (CRCA PA)—Proofreading  
John Soet—Layout, editorial, proofreading and organization  
Patrick Tan Kok Seng—Illustrations  
Tan Teck Sing—Chinese calligraphy

*The partners and demonstrators of drills and combat techniques were:*

Richard Alaniz  
Susan Arbogast—Chief Instructor—CRCA VT  
Vito Armenise—Chief Instructor—CRCA Italy  
Ken Bannon—CRCA PA  
Fabio Bevilacqua—Taranto, Italy  
Gavin Blackburn—Chief Instructor—CRCA UK  
Dr. Bruce Chow—CRCA CA  
Vincenzo DiVirgilio—CRCA Bari, Italy  
Jerry Ford—CRCA PA  
Bert Hill—CRCA MD  
Jeff Imada  
Wayne Jackson—Chief Instructor—CRCA Maryland  
Nicola Massa—CRCA Santa Margherita Liguria, Italy  
Rick McGhee—Chief Instructor—CRCA Virginia  
Mike Pologruto—CRCA VT  
Bo Randall Sorensen—CRCA Hassleholm, Sweden  
Rave Winiels—CRCA Malmö, Sweden  
Harry Wong  
Mick Yates—CRCA UK

### Close Range Combat Wing Chun: Volume Three

---

*I would also like to thank “Judo” Gene LeBell, Sifu Daniel Lee, Ms Bea Wong and Mr. Curtis Wong.*

*Lastly, to my instructors, Sifu George Yau Chu, Sifu Ted Wong Kam Ming and all others who have so generously imparted their knowledge to me over the years—I respectfully salute you!*



