

CNC-Machining Center

The Compact solution

OPTIMAT
BHC 250

OPTIMAT BHC 250 The economical entry level with an automatic tool changer - flexible, efficient

High quality and reliability based on more than 50 years of experience are reflected in each detail of every WEEKE machining center. High technology in the factory in Herzebrock-Clarholz (Germany/ Westphalia) guarantees our customers the highest precision in every respect of the machine. All individual components are based on the latest designs and developments, and are used throughout the HOMAG group.

We continue with further development of our machines based on the daily experiences of our customers. As a result, we can offer you CNC solutions which remain flexible and expandable for the future.

„If you want to be successful, you must accept the other's point of view and must consider the things with his eyes.“
(Henry Ford)

So, what are you waiting for?
Secure your competitive advantage by investing today while others only think about it tomorrow.

WEEKE – Your partner for the future.
Member of the HOMAG-Group
Certified by DIN EN ISO 9001



Tooling possibility



Horizontal boring

el CNC machine ient, compact and space-saving.



*Tool change
magazine, 5-positions*



Tool change



Tool change magazine in function

OPTIMAT BHC 250 – Made by WEEKE

Flexibility is our strength

„The customer is top priority“

In order to satisfy each customer today you must be able to fulfill many different requests. You also need to react with flexibility towards the market and its trends. With this in mind the BHC250 was developed for the small to medium sized shop. It is the perfect CNC starting solution.

With minimal floor space required and the capabilities of the 5-position tool changer this is a machining center that makes your purchase decision easy.

The biggest advantage of this machine is its cost to benefit ratio. Check it out yourself and see!

Flexibility in processing all kinds of shapes and materials efficiently even with low batch sizes, gives you the capability to handle all of your orders in an economic way. The OPTIMAT BHC 250 - It is your advantage against your competition!

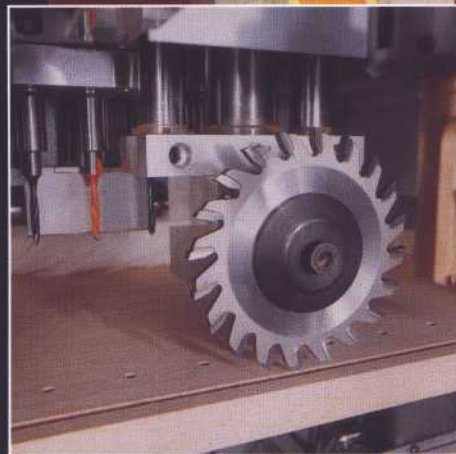

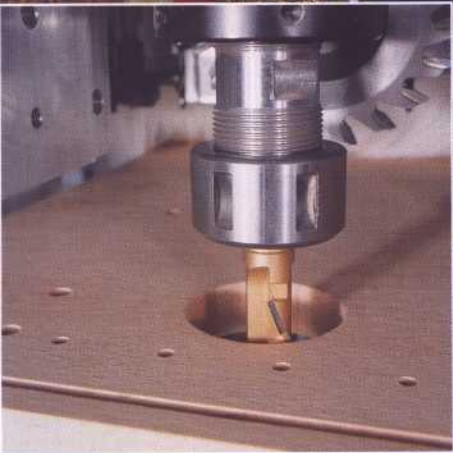
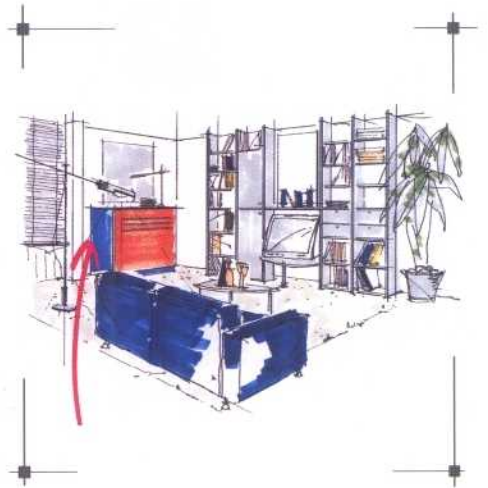
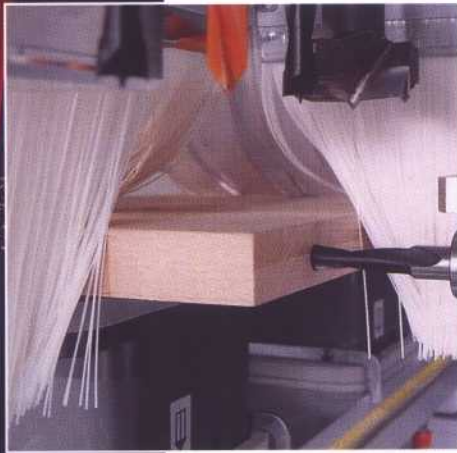
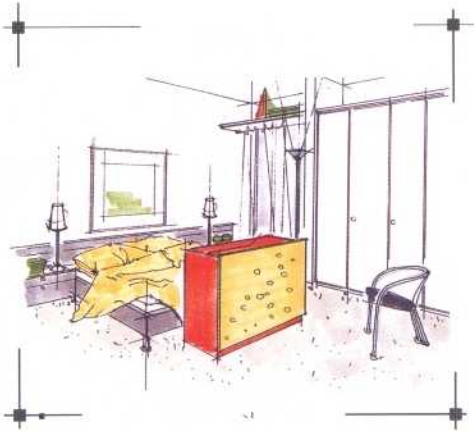

Innovation in Part Hold-Down Technology Free Positioning Of The Vacuum Pods – The Cons

The clamping of the workpieces is one of the most critical issues for the quality of CNC-manufacturing. The combination of machine stability, quality tooling and effective clamping guarantees a quality product coming off the machine.

These facts we realized and developed the console table with free and easy positioning vacuum pods. Our vacuum system gives you high flexibility in order to clamp your workpiece.

The following technical features illustrate this flexibility:

- The side stops can be moved via hand lever valves - no limit in the workpiece length
- A strong vacuum pump, but also electronic vacuum control systems guarantee a strong clamping of the workpiece - manufacturing reliability even for spongy materials and exotic forms
- Scales and indices on the benches and vacuum pods are helpful for heavy workpieces - operating reliability and fast tool change
- Strong stops (d=20mm) guarantee an accurate positioning for heavy workpieces - manufacturing reliability.
- The rubber of the vacuum pods can be changed easily - low wearing - and spare parts costs.
- Up to 4 vacuum pods can be positioned on the workpiece console - high flexibility
- The vacuum pods for narrow workpieces can be positioned length- and crosswise - high flexibility

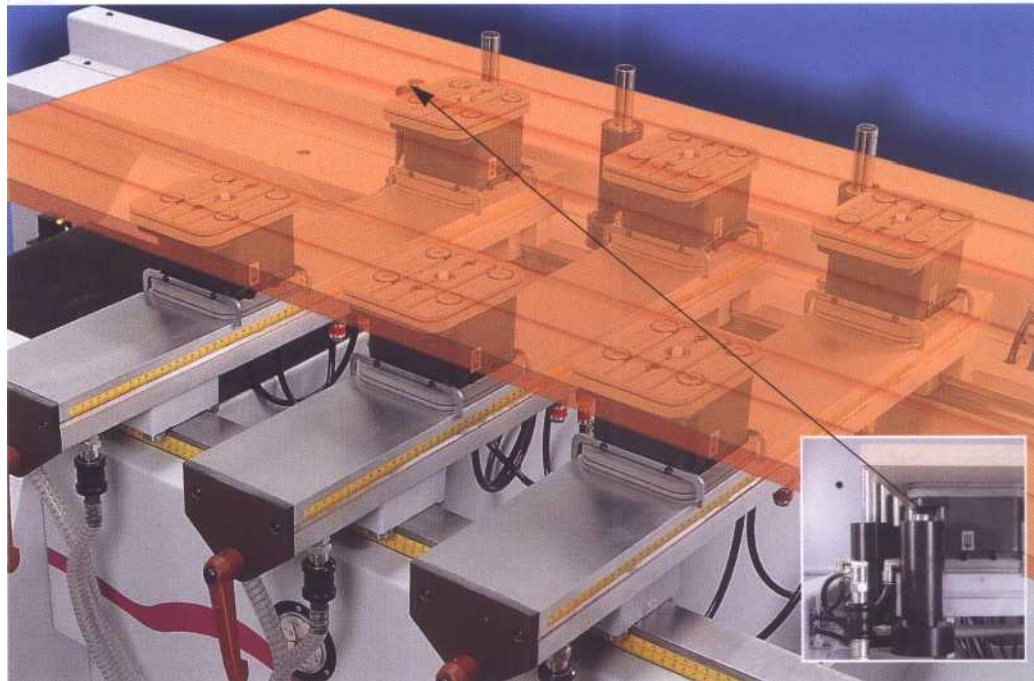

Moveable side stops

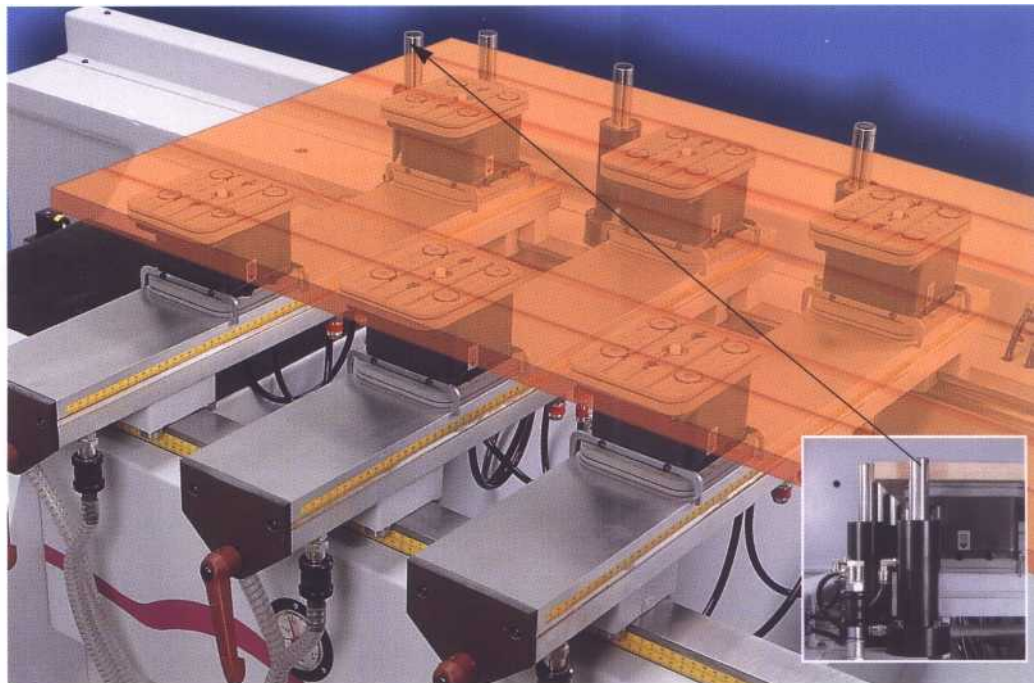

Strong vacuum pump

e & Easy ole Table

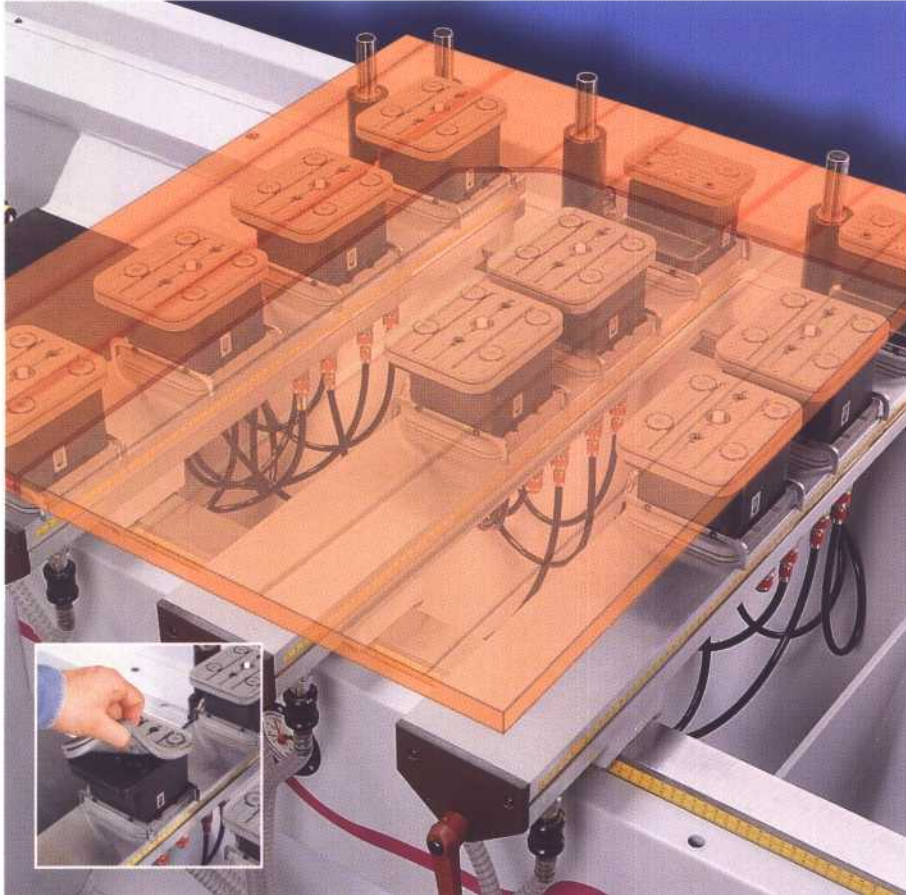

Free po-itr

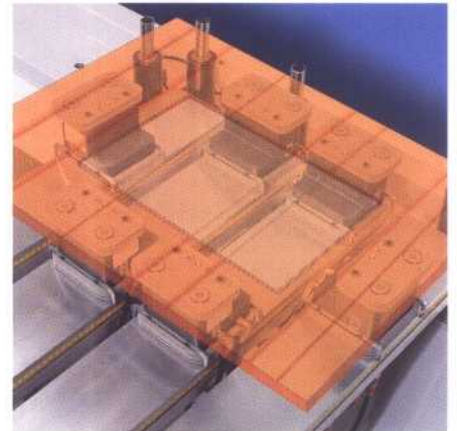

Positioning length- and crosswise

Up to 4 vacuum pods on each bench



Solid stops

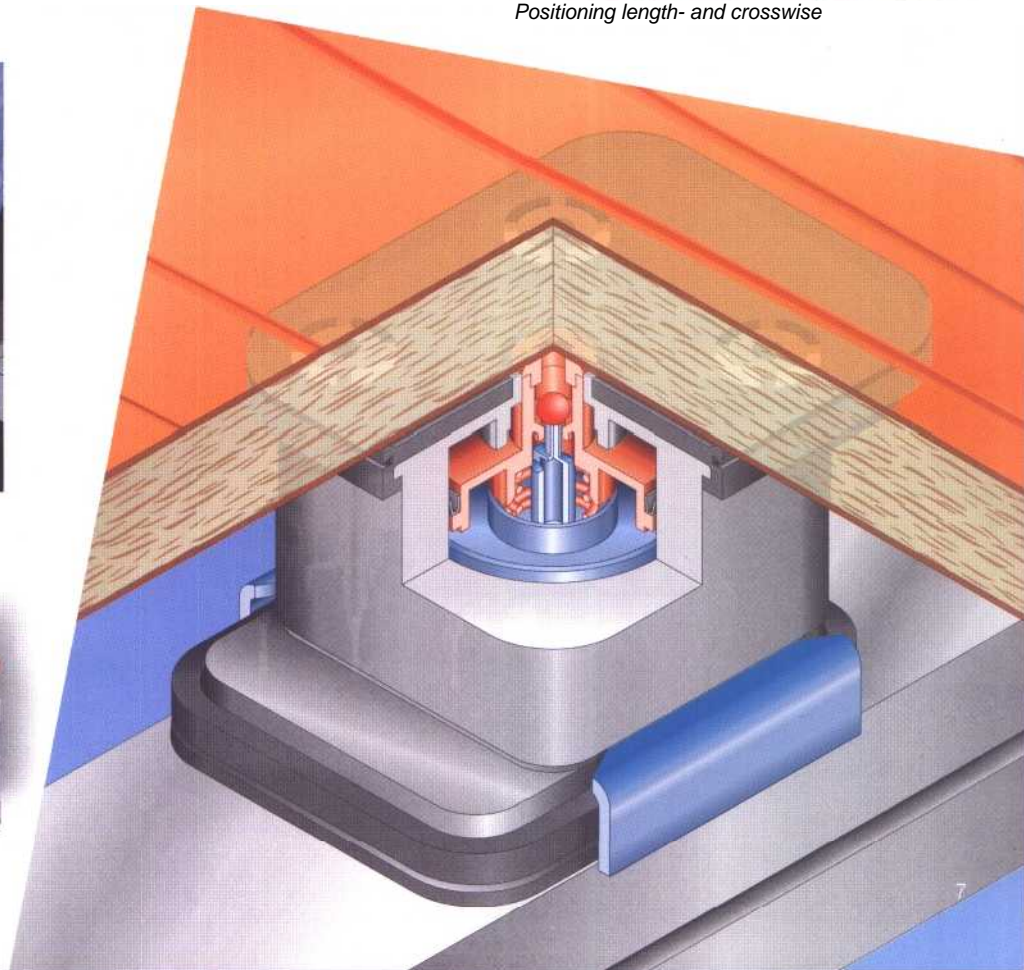
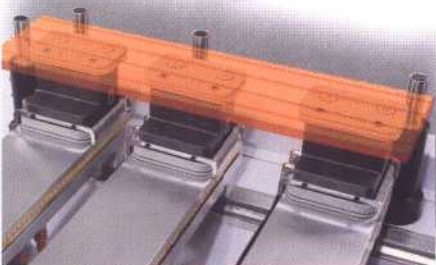

OPTIMAT BHC 250

Flexible, just like your daily business

A lot of different side walls, boards and doors with different surfaces determine the everyday life in your shop. The OPTIMAT BHC250 is especially designed for these demands and has been optimized with the new 5-position tool changer for your demands.

Complete manufacturing - all in one:

- Construction - and shelf hole boring in all variations
- Hinge drilling and boring for special hardware
- Excenter boring for detachable carcass connections
- Routing of contours, joining of several molded workpieces
- Cut-outs and pocket routing

These are only some applications for the OPTIMAT.

The OPTIMAT BHC 250 does not only save running costs, it also spares your nerves.

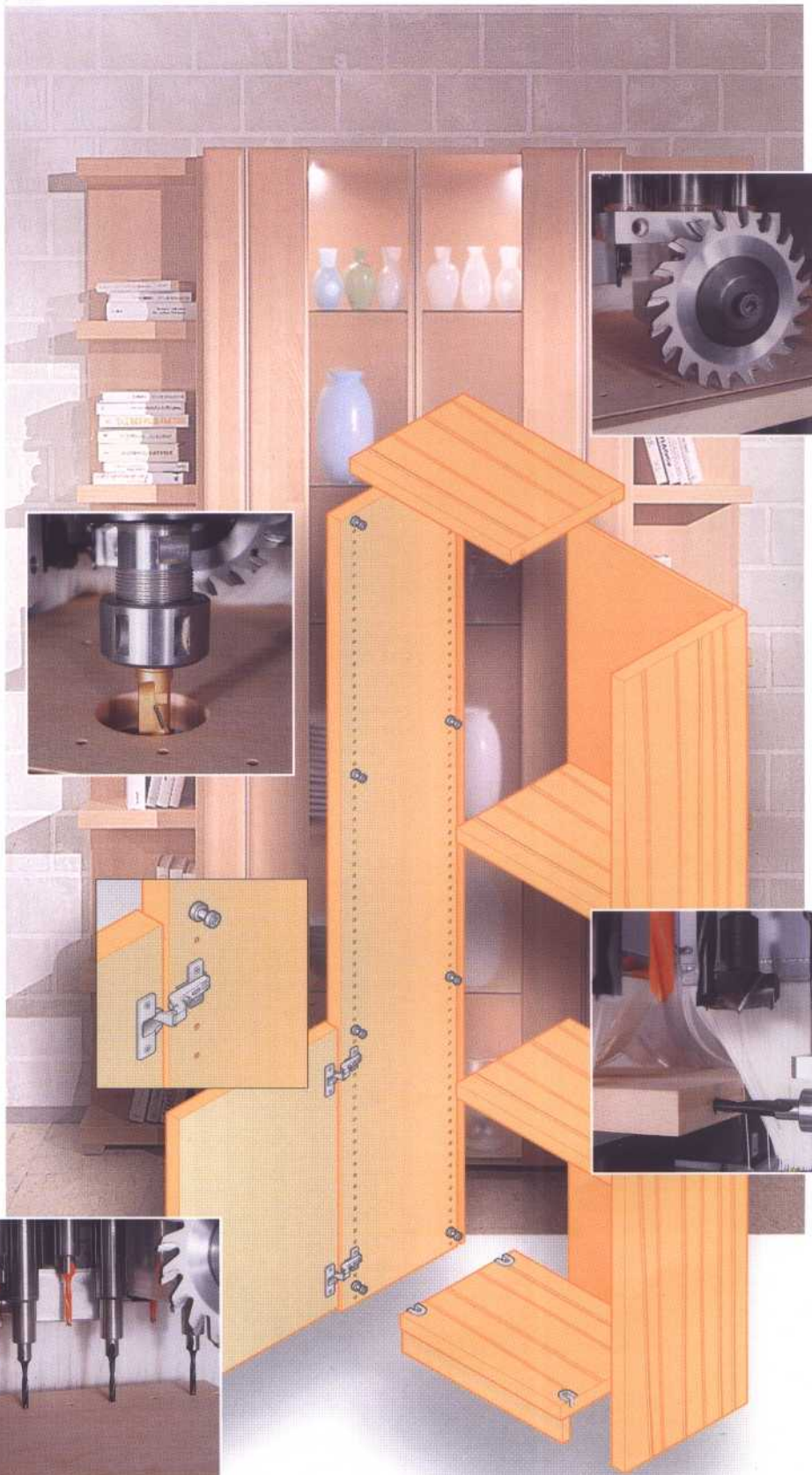
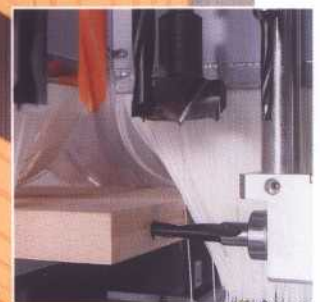
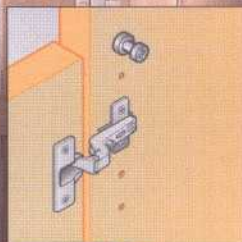

Highlights in Hardware and Software



The WoodWOP and the Homatic 2000 system is developed in close cooperation with you and our specialists.

Short cycle times are in our days a must. Any profit is realized by a fast and safe programming. Easy handling and high reliability you know already from your standard machines are

The Interface between Man and Machine has been realized by WEEKE with a PC-System and the Microsoft Windows® world many years ago. Easy handling of the machine in the daily business is the result of this solution - you are moving in a confidential world. You know this world already from your home it provides safety and confidence.

With WoodWOP you are going to program your success.

WOP = Workshop - Orientated - Programming

With WoodWOP you do not program the machine ans its movements but the panel and its processes.

The integration of your assemble machine in to your existing computer network and your barcode system are only few of many options. The control is already prepared for internet - or do you still receive drawings from architects by national post?

Numerous successful projects with well known manufacturers and suppliers of branch programs do not leave any wishes open in the CAD/CAM rang.

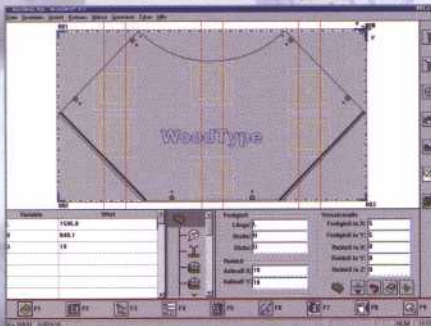
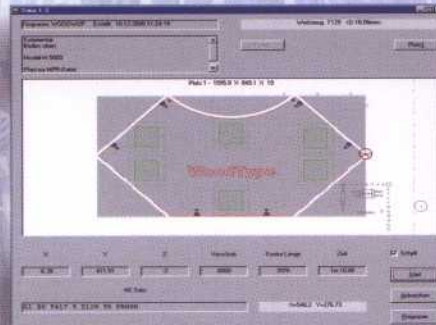

realized by the WoodWOP surface. Parametric programming and the possibility of component technique together with your know-how will lead to a maximum of productivity.

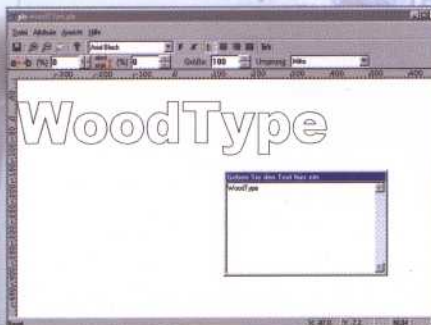

OPTIMAT BHC 250 Two configurations – each with their own possibilities



With our experience and high standards of design and construction it is our highest goal to offer you the "solutions"

which help you to grow in the market and in particular to position yourself for growth in the future.

Tooling possibility OPTIMAT BHC 250

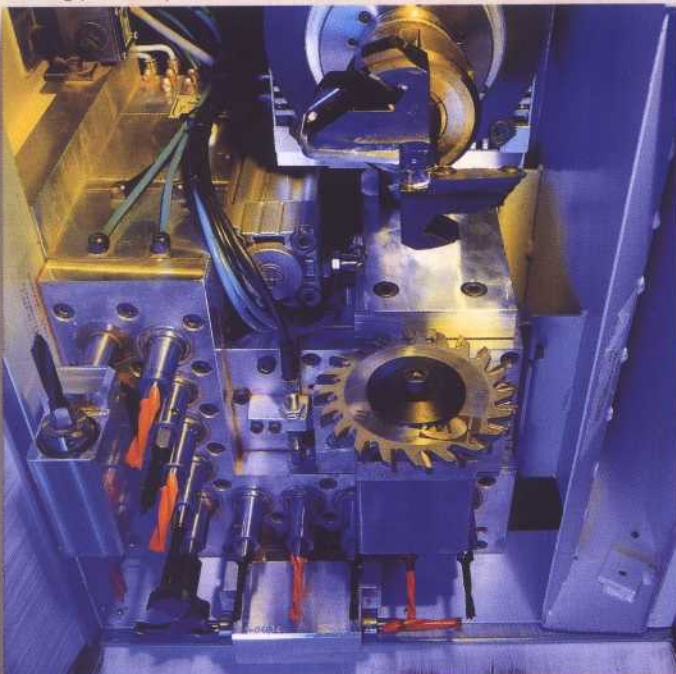

Tool change

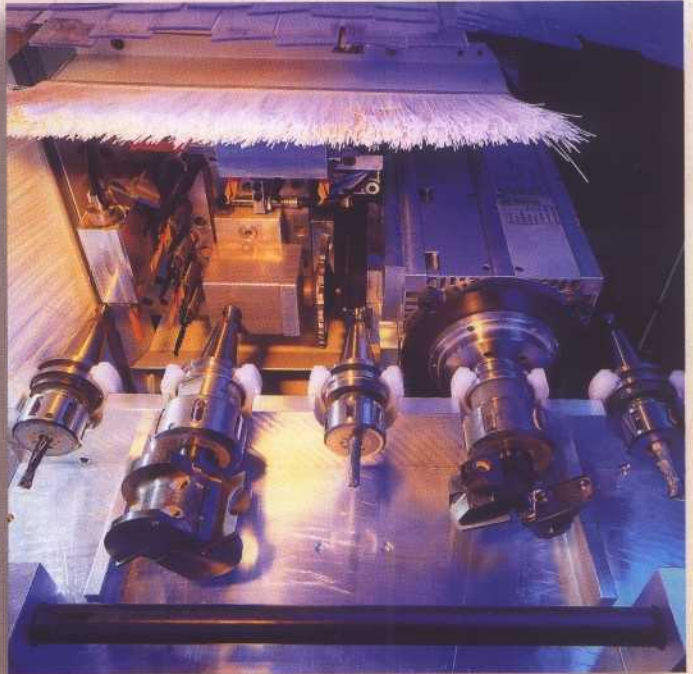

The right solution: For us, each customer determines their own requirements

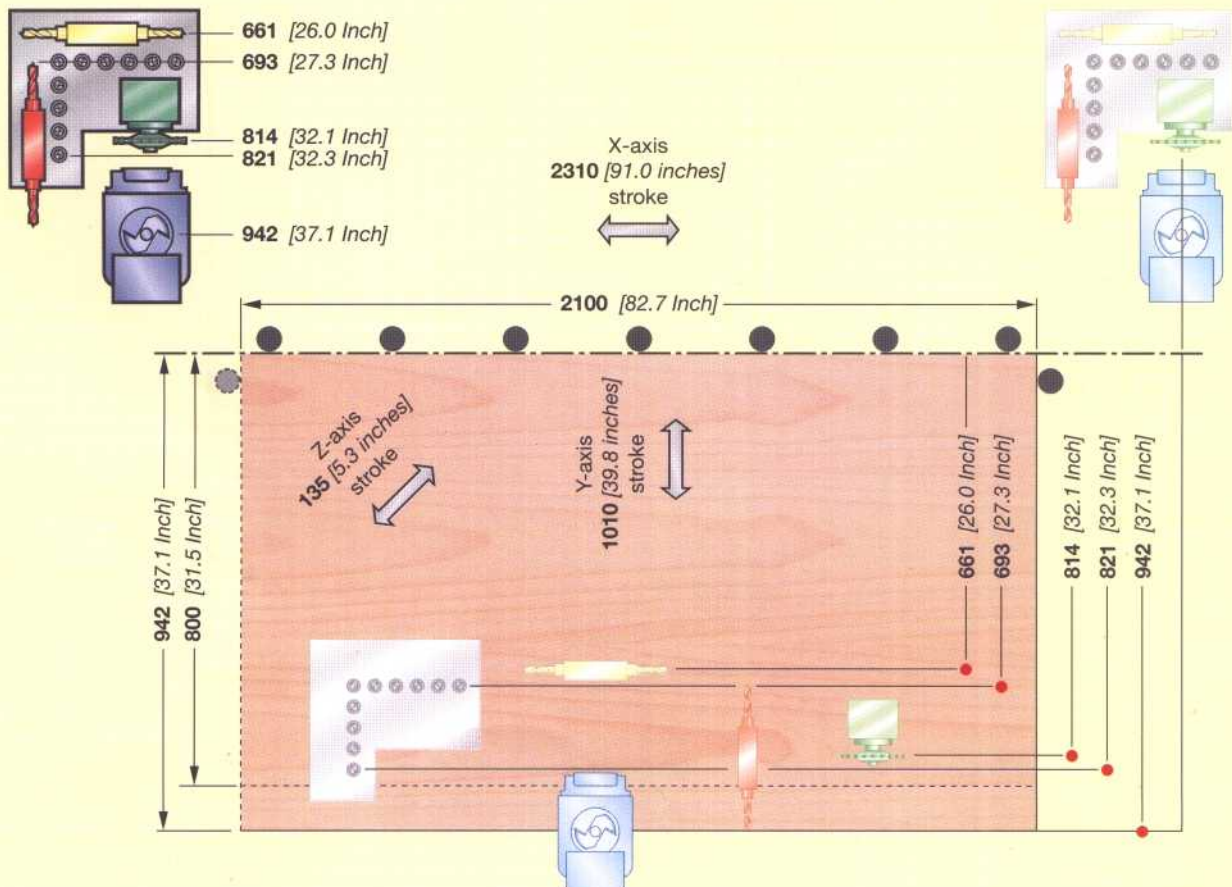
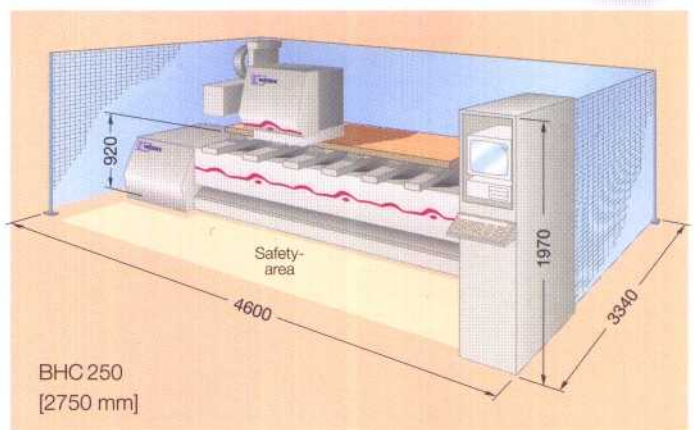
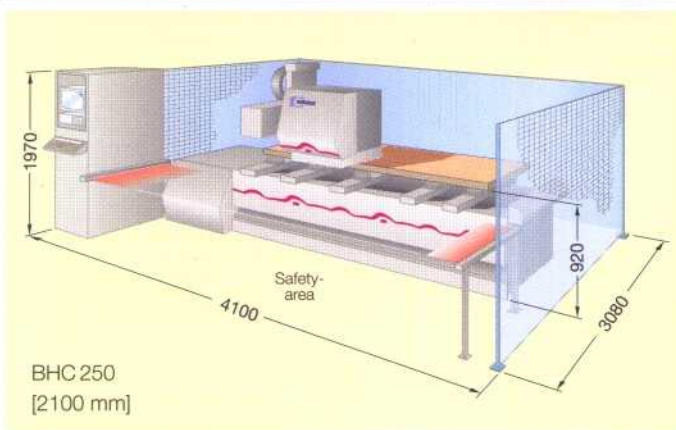
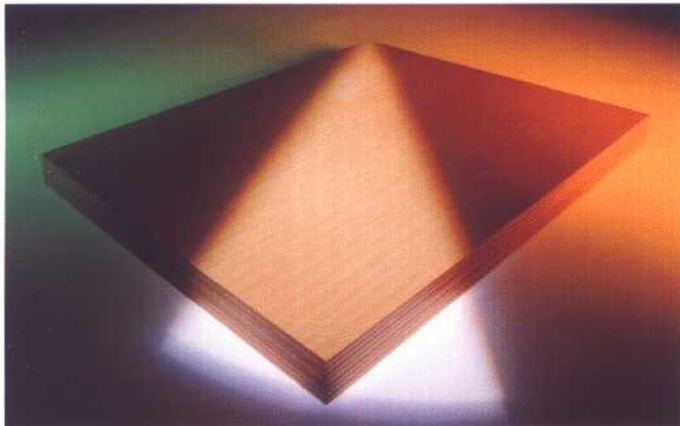

TECHNICAL DATA

BHC 250

Travel range of the Z-axis	mm	135
✓ Workpiece thickness max.	mm	50
	mm	50 - 70.*
Driving system of the axis		digital
Positioning precision of the axes	mm	0.03
✓ Traverse rate X - Y - Z	m/min	60/50/20
Compressed-air supply	Zoll	R 1/2
✓ Compressed air	bar	7
Power of the vacuum pump	m ³ /h	ab 40
✓ Central suction connector	mm	Ø 160
Suction air speed	m/min	min. 28
Pressure drop	PA	min. 2000
Total suction power	m ³ /h	min. 2027
✓ Electrical connecting power	kW	8 - 12
Total machine weight:		
✓ Working length 2100 mm	kg	ca. 2700
Working length 2750 mm	kg	ca. 3100

* using the corresponding tool lengths or clamping devices.

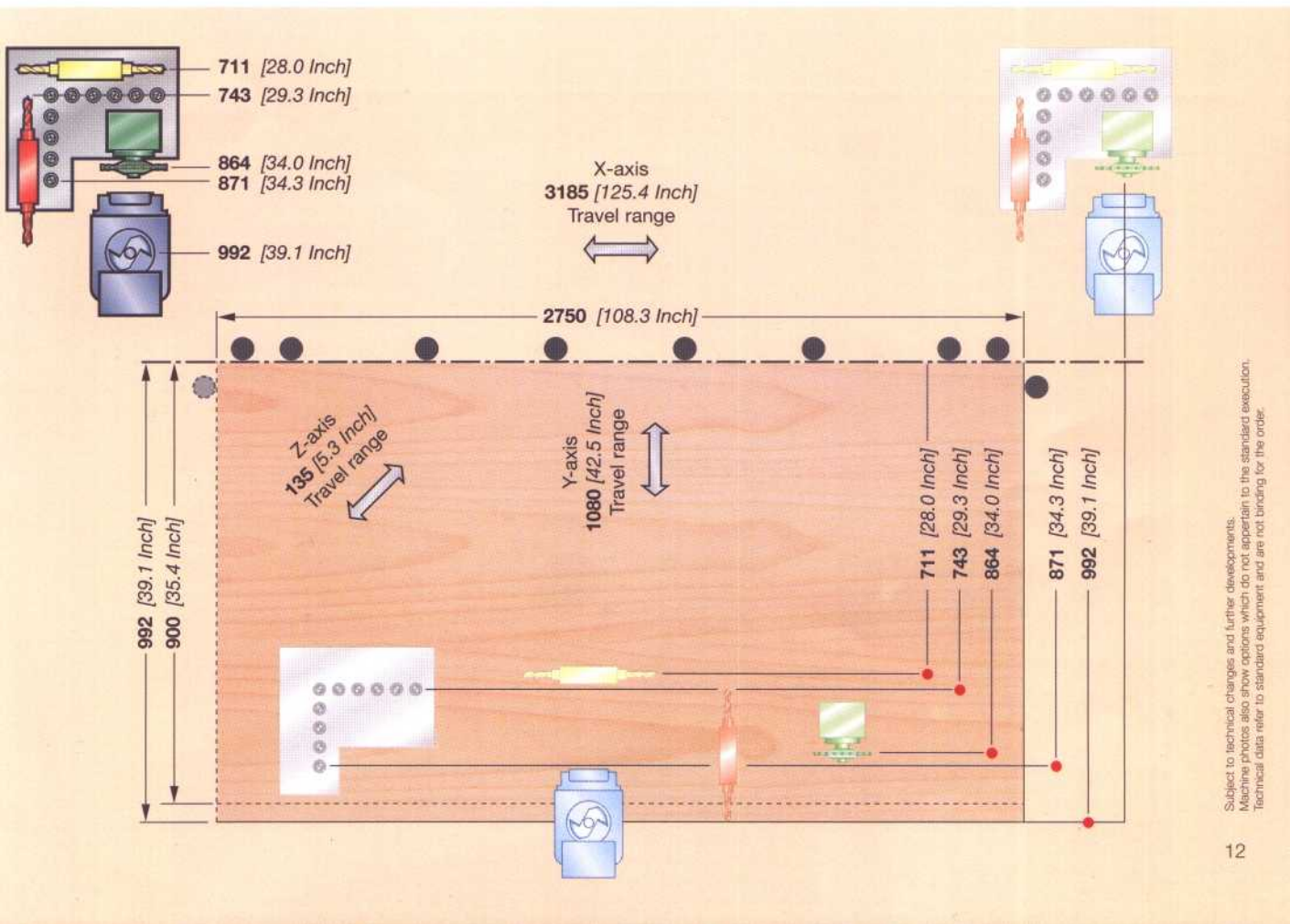

Subject to technical changes and further developments.
Machine photos also show options which do not pertain to the standard execution.
Technical data refer to standard equipment and are not binding for the order.



Production



Sales



Scope of service

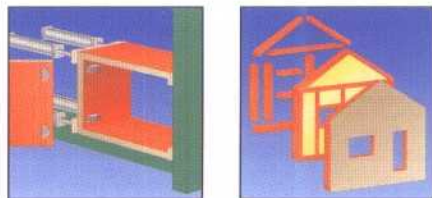

Your contact person:



WEEKE Bohrsysteme GmbH
 Benzstraße 10-16
 33442 Herzebrock-Clarholz
 Phone: +49-52 45-4 45-0
 Telefax: +49-52 45-4 45-139
 E-Mail: info@weeke.de
<http://www.weeke.de>