



CODEX[®]

User Manual – Rev C

Akoya Biosciences, Inc. CODEX® User Manual

Revision C, December 2020

© 2020 by Akoya Biosciences, Inc. CODEX® is a trademark of Akoya Biosciences, Inc. All other trademarks are the property of their respective holders. ALL RIGHTS RESERVED. DUPLICATION AND/OR REPRODUCTION OF ALL OR ANY PORTION OF THIS DOCUMENTATION WITHOUT THE EXPRESS WRITTEN CONSENT OF AKOYA BIOSCIENCES, INC. IS STRICTLY FORBIDDEN.

DISCLAIMER: TO THE EXTENT ALLOWED BY LAW, AKOYA BIOSCIENCES, INC. AND/OR ITS AFFILIATE(S) WILL NOT BE LIABLE FOR SPECIAL, INCIDENTAL, INDIRECT, PUNITIVE, MULTIPLE, OR CONSEQUENTIAL DAMAGES IN CONNECTION WITH OR ARISING FROM THIS DOCUMENT, INCLUDING YOUR USE OF IT.

FOR RESEARCH USE ONLY. NOT FOR USE IN DIAGNOSTIC PROCEDURES.

THE CONTENTS OF THIS DOCUMENT ARE COVERED UNDER NDA.

This Protocol is based on current knowledge of the process and is subject to change.

Diagrams and pictures are for illustration only and might differ from actual implementation.

Table of Contents

CHAPTER 1. CODEX® SOLUTION	7
1.1 CODEX® REAGENTS AND CONSUMABLES	8
1.1.1 Materials Supplied	8
1.1.2 Materials Not Supplied	10
1.2 CODEX® INSTRUMENT	14
1.2.1 Performance Specifications	15
1.2.2 Instrument Requirements	15
1.3 CODEX® SOFTWARE SUITE	15
1.3.1 CODEX® Instrument Manager (CIM)	15
1.3.2 CODEX® Processor	15
1.3.3 CODEX® Multiplex Analysis Viewer (MAV)	15
1.4 SAFETY	15
1.4.1 DMSO	16
1.4.2 Acetone, Ethanol, Methanol, and Paraformaldehyde	16
1.4.3 Instrumentation	16
CHAPTER 2. CODEX® OVERVIEW	17
2.1 CODEX® NOMENCLATURE	18
2.2 CODEX® TECHNOLOGY	19
2.3 CODEX® EXPERIMENTAL DESIGN	19
2.4 PROCEDURAL OVERVIEW	21
2.5 USER GUIDE OVERVIEW	24
CHAPTER 3. COVERSIP PREPARATION AND TISSUE SECTIONING	25
3.1 POLY-L-LYSINE COVERSIP PREPARATION	25
3.1.1 Incubating Coverslips	25
3.1.2 Washing and Storing Coverslips	27
3.2 FRESH-FROZEN TISSUE SECTIONING	28
3.3 FFPE TISSUE SECTIONING	29
CHAPTER 4. ANTIBODY CONJUGATION	31
4.1 CONJUGATING ANTIBODIES	32
4.1.1 Assign a CODEX® Barcode to each antibody that will be conjugated	36
4.1.2 Block non-specific binding of antibody to MWCO filter	36
4.1.3 Measure and calculate protein concentration	36
4.1.4 Concentrate purified antibody solution	36
4.1.5 Initiate antibody reduction	36
4.1.6 Buffer Exchange of the Antibody Solution	37
4.1.7 Prepare CODEX® Barcode Solution	37
4.1.8 Set Up Antibody Conjugation Reaction	37
4.1.9 Purify CODEX® Antibody Conjugates	37

4.1.10 Collect CODEX® Antibody Solution _____	38
4.2 VALIDATING CUSTOM-CONJUGATED ANTIBODIES (VIA GEL ELECTROPHORESIS)	38
4.2.1 Sample Preparation _____	39
4.2.2 Gel Setup _____	39
4.2.3 Gel Visualization _____	39
CHAPTER 5. TISSUE STAINING _____	41
5.1 FRESH-FROZEN TISSUE PRE-STAINING	42
5.1.1 Plate configuration _____	45
5.1.2 Tissue Retrieval _____	46
5.1.3 Acetone Incubation _____	46
5.1.4 Tissue Drying _____	46
5.1.5 Tissue Hydration _____	47
5.1.6 Fix Tissue _____	47
5.1.7 Wash the tissue _____	47
5.1.8 Equilibrate Tissue in Staining Buffer _____	47
5.2 FRESH-FROZEN TISSUE STAINING.....	48
5.2.1 Understanding Antibody Dilution _____	48
5.2.2 Preparation of the Antibody Cocktail Solution _____	48
5.2.3 Tissue Staining _____	49
5.3 FRESH-FROZEN TISSUE POST-STAINING	49
5.3.1 Wash Tissue _____	52
5.3.2 Fix Tissue _____	53
5.3.3 Wash Tissue _____	53
5.3.4 Ice-cold Methanol Incubation _____	53
5.3.5 Wash Tissue _____	54
5.3.6 Fix Tissue _____	54
5.3.7 Wash Tissue _____	55
5.3.8 Store Tissue _____	55
5.4 FFPE TISSUE PRE-STAINING.....	55
5.4.1 Tissue Pre-treatment _____	60
5.4.2 Tissue Deparaffinization and Hydration _____	60
5.4.3 Antigen Retrieval _____	61
5.4.4 Wash Tissue _____	62
5.4.5 Equilibrate Tissue in Staining Buffer _____	62
5.5 FFPE TISSUE STAINING	62
5.5.1 Understanding Antibody Dilution _____	62
5.5.2 Preparation of the Antibody Cocktail Solution _____	63
5.5.3 Tissue Staining _____	63

5.6	FFPE TISSUE POST-STAINING	64
5.6.1	Wash Tissue _____	66
5.6.2	Fix Tissue _____	66
5.6.3	Wash Tissues _____	67
5.6.4	Ice-cold Methanol Incubation _____	67
5.6.5	Wash Tissue _____	67
5.6.6	Fix Tissue _____	68
5.6.7	Wash Tissue _____	69
5.6.8	Store Tissue _____	69
CHAPTER 6. MANUAL VALIDATION OF CUSTOM-CONJUGATED ANTIBODIES VIA TISSUE STAINING _____		71
6.1	EXPERIMENTAL DESIGN	72
6.1.1	Tissue Selection _____	72
6.1.2	Designing Manual Validation Experiments _____	72
6.1.3	Multicycle Experiments _____	73
6.2	MANUAL ADDITION OF CODEX® REPORTERS AND COVERSIP MOUNTING	74
6.2.1	Prepare Screening Buffer _____	75
6.2.2	Prepare 1x CODEX Buffer _____	76
6.2.3	Prepare Reporter Stock Solution _____	76
6.2.4	Prepare Reporter Master Mix _____	77
6.2.5	Incubate Sample Coverslip(s) with CODEX® Reporters _____	77
6.2.6	Wash Tissue _____	79
6.2.7	Mount Tissue _____	79
6.3	VISUALIZATION AND ANALYSIS OF MANUAL VALIDATION IMAGES	80
6.3.1	Qualitative Analysis _____	80
6.3.2	Quantitative Analysis _____	81
CHAPTER 7. PREPARING CODEX® REPORTERS _____		83
7.1	CONFIGURATION OF CODEX® CYCLES	83
7.1.1	Cycle Reporter Configuration _____	84
7.1.2	Plate Cycle Configuration _____	84
7.1.3	Blank Cycles _____	85
7.2	CODEX® REPORTER PLATE PREPARATION	86
7.2.1	Prepare the Reporter Stock Solution _____	86
7.2.2	Prepare the Reporter Master Mix for each cycle _____	87
7.2.3	Create the Reporter 96-well Plate _____	87
CHAPTER 8. USE OF THE CODEX® INSTRUMENT _____		89
8.1	OVERVIEW OF CODEX® EXPERIMENTS	90
8.2	SET UP THE CODEX® INSTRUMENT FOR A CODEX® RUN	91

8.2.1 Equilibrate Samples and Reagents to RT _____	92
8.2.2 Prepare 1x CODEX® Buffer _____	92
8.2.3. Pre-Run Clean Instrument Wash (Optional) _____	92
8.2.4 Start Experiment Setup _____	93
8.2.5 Instrument Setup with Wizard _____	94
8.2.6 Sample Preparation: Nuclear Staining _____	96
8.2.7 Microscope Setup and Pre-check _____	97
8.2.8 Clear Tissue Protocol (Optional) _____	98
8.2.9 Post-Run Clean Instrument Wash _____	99
APPENDIX A: PLATE CONFIGURATIONS _____	101
For 3 Tissue Samples: _____	101
For 4-6 Tissue Samples: _____	103
APPENDIX B: TITRATION OF CODEX® ANTIBODIES _____	107
APPENDIX C: MOUNTING THE COVERSIP ON A SLIDE _____	108
Required Materials _____	108
Tissue Pre-Treatment and Staining _____	108
Coverslip Mounting _____	108
APPENDIX D: STAGE ASSEMBLY AND PLACEMENT INTO MICROSCOPE _____	110
Instructions for Stage Plate V1 with TWO gaskets: _____	110
Instructions for Stage Plate V2 with ONE gasket: _____	113
Instructions on the correct placement of the Spill Guard/Leak Detector system and the Stage Plate within a Keyence Microscope: _____	114

Chapter 1. CODEX® Solution

1.1	CODEX® REAGENTS AND CONSUMABLES	8
1.2	CODEX® INSTRUMENT	14
1.3	CODEX® SOFTWARE SUITE	15
1.4	SAFETY	15

The CODEX® solution is comprised of specially formulated biologics and reagents, a companion fluidics instrument compatible with standard fluorescence microscopes, and a suite of software solutions.

The combination of these components enables the collection and analysis of multiparametric, single-cell resolution imaging data.

This user guide gives a comprehensive overview of the CODEX® technology and covers in detail the following:

- CODEX® Instrument
- CODEX® Reagents and Consumables
- CODEX® Workflow

The CODEX® run Quick Reference Cards (QRCs) specific to the microscope in use are to be consulted for instructions regarding the use of the companion fluorescence microscope and the software.

The QRCs can be found on our Akoya support page. Please see akoyabio.com for more information.

1.1 CODEX® Reagents and Consumables

1.1.1 Materials Supplied

CODEX® Staining Kit (PN# 7000008)

This kit contains buffers and reagents to perform tissue stains with CODEX® Antibodies tagged with a Barcode.

Each kit contains reagents for 10 tissue samples.

CODEX® Staining Kit (PN# 7000008)		
Contents	Storage	Related Protocols
Hydration Buffer	4°C	Tissue Staining
Staining Buffer		
Storage Buffer		
N Blocker		
J Blocker		
G Blocker	-20°C	
S Blocker		
Fixative Reagent		

CODEX® Conjugation Kit (PN: 7000009)

This kit contains the CODEX® reagents required for custom conjugation of non-inventoried antibodies with the CODEX® Barcodes to run a CODEX® experiment.

Each kit contains enough reagents for 10 conjugations (antibodies not included).

CODEX® Conjugation Kit (PN# 7000009)		
Contents	Storage	Related Protocols
Reduction Solution 1	-20°C	Antibody Conjugation
Filter Blocking Solution	4°C	
Reduction Solution 2		
Conjugation Solution		
Purification Solution		
Antibody Storage Solution		

CODEX® À la carte Items

Presented below are single order items that are used during Tissue Sectioning, Tissue Staining, Reporter Plate Preparation, and CODEX® runs.

CODEX® À la carte items			
Contents	PN#	Storage	Related Protocols
10X CODEX® Buffer	7000001	Room Temperature (RT)	Tissue Staining Reporter Plate Preparation Use of CODEX® Instrument
CODEX® Gaskets	7000010		Use of CODEX® Instrument
Coverslips	7000005		Tissue Sectioning Tissue Staining Use of CODEX® Instrument
96 well plates	7000006		Use of CODEX® Instrument
96 well plate seals	7000007		Reporter Plate Preparation
CODEX® Coverslip Storage Box	7000013		Coverslip Preparation Tissue Sectioning
CODEX® Assay Reagent	7000002	-20°C, and 4°C after the first thaw	Tissue Staining
Nuclear Stain	7000003		Reporter Plate Preparation Use of CODEX® Instrument

CODEX® Reagents

This category comprises of CODEX® Antibodies, Reporters, and Barcodes. An updated list of available products can be found on our website: akoyabio.com.

Please refer to CODEX® nomenclature in [Chapter 2](#) for information on the design and structure of CODEX® reagents.

CODEX® Reagents		
Contents	Storage	Related Protocols
CODEX® Antibodies	4°C	Tissue Staining
CODEX® Barcodes	-20°C	Antibody Conjugation
CODEX® Reporters	-20°C, and 4°C after the first thaw	Reporter Plate Preparation Use of CODEX® Instrument Validation of Custom-Conjugated Antibodies

1.1.2 Materials Not Supplied

Required for entire CODEX® workflow

Type	Item	Vendor	PN#	Chapters
Glassware	Glass beaker (0.5 L)	Customer choice	---	poly-L-lysine coated coverslip preparation
	6 X Glass beakers (50 mL)	Customer choice	---	Tissue Staining
Consumables	Buffer reservoirs - 4 Required. No substitutions.	Beckman Coulter	BK372790	Use of CODEX® Instrument (1 set included with instrument)
	Buffer reservoir tray - Required. No substitutions.	Beckman Coulter	BK372795	Use of CODEX® Instrument (1 set included with instrument)
	Plastic wrap	Customer choice	---	poly-L-lysine coated coverslip preparation
	Plastic petri dish	Customer choice	---	poly-L-lysine coated coverslip preparation
	Bent-tip tweezers (Highly recommended)	Fine Science Tools	11251-33	Tissue Sectioning Tissue Staining Use of CODEX® Instrument
	6-Well TC Plates - Does not need to be tissue cultured treated	VWR	10861-554	Tissue Staining Validation of Custom-Conjugated Antibodies
	1 mL, 1.5 mL, 2 mL tubes	Customer choice	---	Tissue Staining Use of CODEX® Instrument
	Amber 1.5 mL tubes	Customer choice	---	CODEX® Reporter Preparation Use of CODEX® Instrument
	Serological Pipet	Customer choice	---	Tissue Sectioning Tissue Staining Use of CODEX® Instrument
	5, 15, 50 mL conical tubes	Customer choice	---	Tissue Staining
	Aerosol Spray	Customer choice	---	Tissue Sectioning
	Disposable Filter Units	Nalgene™ Rapid-Flow™ (Recommended)	156-4020	Use of CODEX® Instrument

	Compressed Air Duster	Customer choice	---	Use of CODEX® Instrument
	Kimwipes	Customer choice	---	Use of CODEX® Instrument
Biologics/ reagents	16% Paraformaldehyde	Electron Microscopy Sciences (Recommended)	15710	Tissue Staining
	1X PBS	Life Technologies	14190144	Antibody Conjugation Tissue Staining
	Poly-L-lysine 0.1%	Sigma-Aldrich	P8920	Coverslip preparation
	Nuclease-Free Water	Thermo Fisher Scientific	AM9938	Reporter Plate Preparation
	Fluoromount-G™ (optional)	Thermo Fisher Scientific	00-4958-02	Validation of Custom-Conjugated Antibodies
	ddH ₂ O or Milli-Q® H ₂ O	Customer choice	---	Use of CODEX® Instrument Antibody Conjugation
	Methanol	Sigma-Aldrich	34860-1L-R	Tissue Staining
	DMSO - ACS reagent, ≥99.9%	Sigma-Aldrich	472301-4L	Validation of Custom-Conjugated Antibodies Use of CODEX® Instrument
Instrumentation	UPS (Recommended)	APC Back-UPS Pro 1500	BR1500G	Use of CODEX® Instrument
	Vacuum Pump	Customer Choice	---	Validation of Custom-Conjugated Antibodies
	Fume Hood (Highly Recommended)	Customer Choice	---	Tissue Staining Waste Collection

Required for Fresh-frozen Tissue Sections

Type	Item	Vendor	PN#	Chapters
Glassware	Glass Beakers 50mL	Customer choice	---	Tissue Staining
Consumables	Drierite Adsorbents	Fisher Scientific	23-116582	Tissue Staining
Solvents	Acetone	Sigma-Aldrich	650501-1L	Tissue Staining
Instrumentation	Cryostat	Customer choice	---	Tissue Sectioning

Required for Formalin-Fixed Paraffin-Embedded (FFPE) Tissue Sections

Type	Item	Vendor	PN#	Chapters
Consumables	Aluminum Foil	Customer choice	---	Antigen retrieval
	50 mL Pyrex Beakers (one per each staining rack)	Customer choice	---	Antigen retrieval
	Coverslip staining rack	Electron Microscopy Science	72240	Tissue Staining
	10 Solvent-resistant Containers with lids	EZ-Quick Slide Staining Set, IHC World	IW-2510	Tissue Staining
Solvents	10x Citrate Buffer, pH=6.0 0.1M	Sigma	C9999-1000ML	Tissue Staining
	Tris-EDTA, pH = 9.0 (optional, only required by specific clones)	Customer choice	---	Tissue Staining
	Ethanol or Reagent Alcohol	Sigma Aldrich	79317-16GA-PB	Tissue Staining
	Histo-Choice Clearing 1x	VWR	H103-4L	Tissue Staining
Equipment	Heating Plate	Customer choice	---	Tissue Staining
	Microtome	Customer choice	---	Tissue Sectioning
	Pressure Cooker	Customer choice	---	Tissue Staining
	Water Bath (40°C)	Customer choice	---	Tissue Sectioning

Required for Conjugation

Type	Item	Vendor	PN#	Chapters
Consumables	50kDa MWCO filter - No size substitutions (25kDa and 100kDA result in failure)	EMD Millipore	UFC505096	Antibody Conjugation
	Screw-top 1.7 mL or 2 mL tubes	Customer choice	---	Antibody Conjugation
	Parafilm	Customer choice	---	Validation of Custom-Conjugated Antibodies
Biologics/reagents	Purified antibodies	Customer choice	---	Antibody Conjugation
	NuPAGE™ LDS Sample Buffer (14X)	Thermo Fisher Scientific	NP0008	Validation of Custom-Conjugated Antibodies
	NuPAGE™ Sample Reducing Agent (10X)	Thermo Fisher Scientific	NP0009	Validation of Custom-Conjugated Antibodies
	NuPAGE™ 4-12% Bis-Tris Protein Gels	Thermo Fisher Scientific	NP0321BOX	Validation of Custom-Conjugated Antibodies
	Novex™ Sharp Pre-Stained Protein Standard 3.5-260 kDa	Thermo Fisher Scientific	LC5800	Validation of Custom-Conjugated Antibodies
	Novex™ SimplyBlue™ SafeStain	Thermo Fisher Scientific	LC6065	Validation of Custom-Conjugated Antibodies
	NuPAGE™ MOPS SDS Running Buffer (20X)	Thermo Fisher Scientific	NP0001	Validation of Custom-Conjugated Antibodies
Instrumentation	Centrifuge	Customer choice	---	Antibody Conjugation
	XCell SureLock™ Mini-Cell Electrophoresis System	Customer choice	---	Validation of Custom-Conjugated Antibodies
	95°C dry bath	Customer Choice	---	Validation of Custom-Conjugated Antibodies
	Nanodrop	Customer Choice	---	Antibody Conjugation

	Shaker (optional)	Customer Choice	---	Validation of Custom-Conjugated Antibodies
	Microwave (optional)	Customer Choice	---	Validation of Custom-Conjugated Antibodies

1.2 CODEX® Instrument

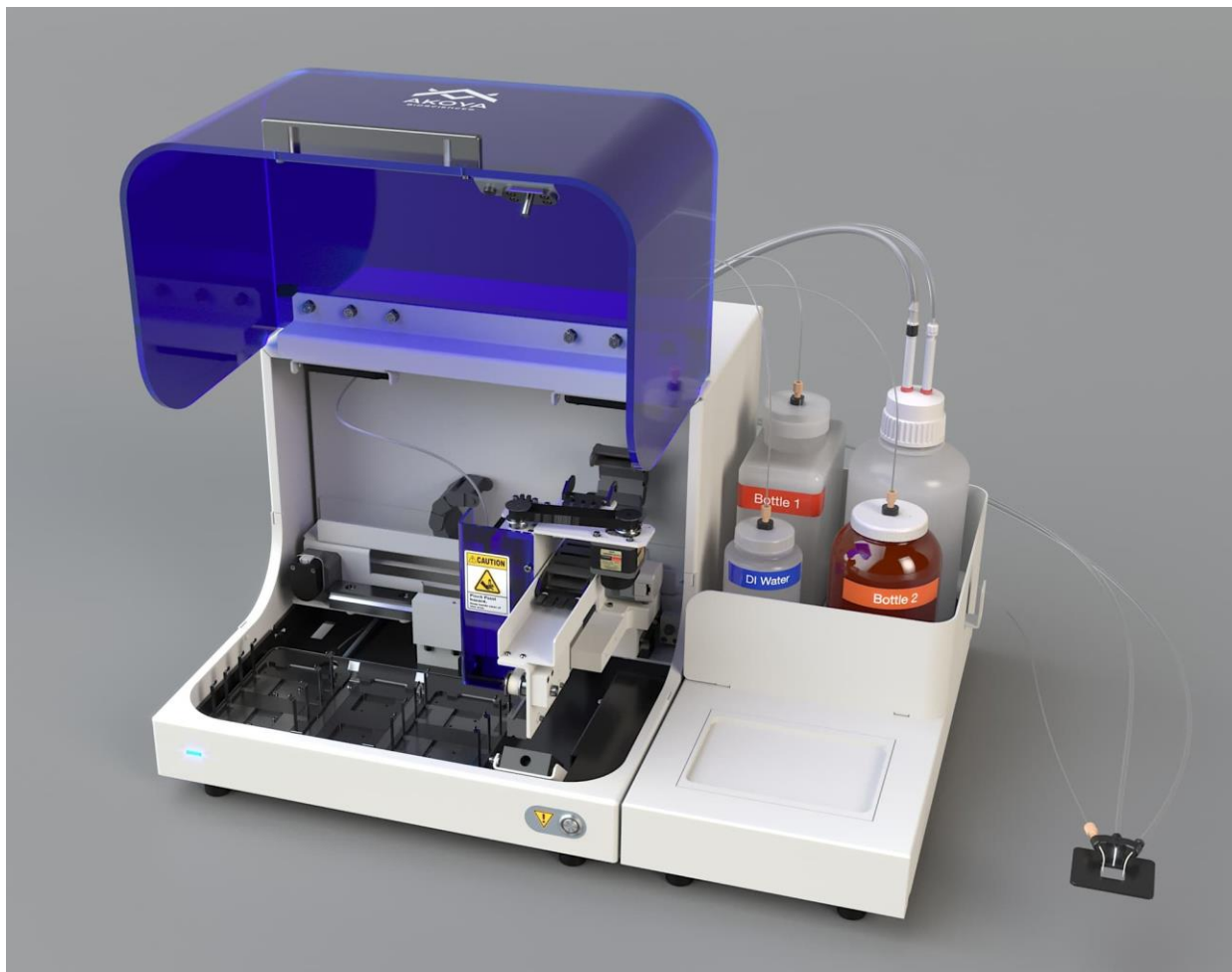

The CODEX® Instrument performs all fluidic operations required for a CODEX® multicycle run. It is equipped with:

- 4 bottles: 1x CODEX® Buffer Bottle, a Vacuum/Waste Bottle, a DMSO Bottle, and a Water Bottle
- 4 removable reservoirs
- Buffer Tray for 4 reservoirs
- One Stage Insert designed to fit a specific microscope model holding the tissue sample. The Stage Insert is equipped with 3 ports connected to the following: A (Aspiration), E (Emergency vacuum) and D (Dispense) lines
- One holder for a 96-well plate
- A Robotic Cannula

The CODEX® Instrument performs gentle washes and incubations of the tissue sample with different buffers and reagent mixtures during a CODEX® run. It is directed by the CODEX® Instrument Manager (CIM) software, which

also controls the microscope software. Fluidics and imaging of the tissue sample are conducted sequentially during a CODEX® run.

1.2.1 Performance Specifications

Imageable areas are dependent on the microscope, the camera, and objective lens used with the CODEX® system. More information can be found on our CODEX® support page: please see akoyabio.com.

Imageable tissue thickness: $\leq 10 \mu\text{m}$

Maximum fluidics capacity: Up to 35 cycles

1.2.2 Instrument Requirements

Operating temperature: 20°C - 24°C

Humidity: 20% – 80%, noncondensing

Input voltage: 100-240VAC ~ 2A 50/60 Hz

1.3 CODEX® Software Suite

CODEX® makes use of a Software Suite which comprises of three different programs. This Suite is intended to provide a comprehensive solution to user needs, ranging from data acquisition to image processing and to analysis of cytometric data.

The CODEX® Software Suite has a unique architecture designed for modular use. Users can use part of it (for example for data acquisition and processing) and use other commercial or custom-written software for image analysis or single-cell data analysis.

1.3.1 CODEX® Instrument Manager (CIM)

The CODEX® Instrument Manager is necessary to perform CODEX® runs. It controls the fluidics of the CODEX® Instrument, the integration and synchronization with microscopes, data formatting, and data transfer.

1.3.2 CODEX® Processor

The CODEX® Processor is used for image processing of CODEX data including cell segmentation, drift compensation, background subtraction, cropping and stitching, cycle alignment, generation of FCS files containing cytometric data, etc.

1.3.3 CODEX® Multiplex Analysis Viewer (MAV)

The CODEX® Multiplex Analysis Viewer is a FIJI plug-in tool that enables the visualization and analysis of CODEX® images, segmented cells, and their biomarker signals. It also allows for gating and clustering of single cells through an unsupervised clustering algorithm for single-cell multidimensional data.

1.4 Safety

Always read the information provided in the reagents' Safety Data Sheets (SDSs). Dispose of materials used in accordance with federal, state, and local regulations. Wear personal protective equipment when appropriate (such as gloves, safety glasses, and protective clothing). CODEX® makes use of the following organic solvents and

solutions: dimethyl sulfoxide (DMSO), acetone (for FF tissues only), methanol, ethanol (for FFPE tissues only) and paraformaldehyde solution.

1.4.1 DMSO

- DMSO is readily absorbed through the skin, and it has the potential to carry toxic materials or materials of unknown toxicity into the body.
- Follow manufacturer's instructions for proper storage, handling, cleaning, and disposal.

1.4.2 Acetone, Ethanol, Methanol, and Paraformaldehyde

- Acetone, ethanol, methanol, and paraformaldehyde are used in [Chapter 5](#).
- Acetone, ethanol, and methanol are highly flammable, vaporize readily, and are classified as inhalation irritants.
- Follow manufacturers' instructions for proper storage, handling, cleaning, and disposal.
- It is recommended that you use all organic solvents and paraformaldehyde solutions in a fume hood and immediately dispose of them after use.

1.4.3 Instrumentation

- The CODEX® Instrument has moving parts. Do not attempt to open the door when the instrument is running.
- If the instrument is not used as per Akoya Biosciences' instructions, the protection provided with the equipment can be revoked. Please operate the instrument as indicated in [Chapter 8](#), the CODEX® run QRCs, and outlined in the CODEX® Instrument Manager software notes. Refer to our support page for details. See akoyabio.com for more information.
- Ensure appropriate electrical supply is available. For safe operation of the instrument:
 - Plug the system into a properly grounded receptacle with adequate current supply.
 - Ensure the electrical supply is of suitable voltage.
 - Never operate the instrument with the ground disconnected. Grounding continuity is required for the safe operation of the instrument.
- Before and after each run and every two weeks, follow the instructions presented in the Maintenance section outlined in the CODEX® Instrument Manager software notes. Refer to our support page for details.
- Akoya Biosciences will provide repair and maintenance services.
- Do not remove CODEX® Instrument protective covers. If you remove the instrument's protective panels or disable interlock devices, you may be exposed to serious hazards including but not limited to, severe electrical shock, laser exposure, crushing, or chemical exposure.

Additional information about biohazard guidelines is available at <http://www.cdc.gov>.

Chapter 2. CODEX® Overview

2.1	CODEX® NOMENCLATURE	18
2.2	CODEX® TECHNOLOGY.....	19
2.3	CODEX® EXPERIMENTAL DESIGN	19
2.4	PROCEDURAL OVERVIEW	21
2.5	USER GUIDE OVERVIEW	24

CODEX® (CO-Detection by indEXing) technology provides a platform to perform spatially resolved, highly multiplexed biomarker analysis in both fresh-frozen (FF) and formalin-fixed paraffin-embedded (FFPE) tissue sections. CODEX® is an end-to-end solution - from tissue staining to image acquisition, data quantification and analysis.

This chapter gives a brief overview of the entire CODEX® workflow. The subsequent chapters will focus on guiding the user through protocols to utilize the entire CODEX® technology.

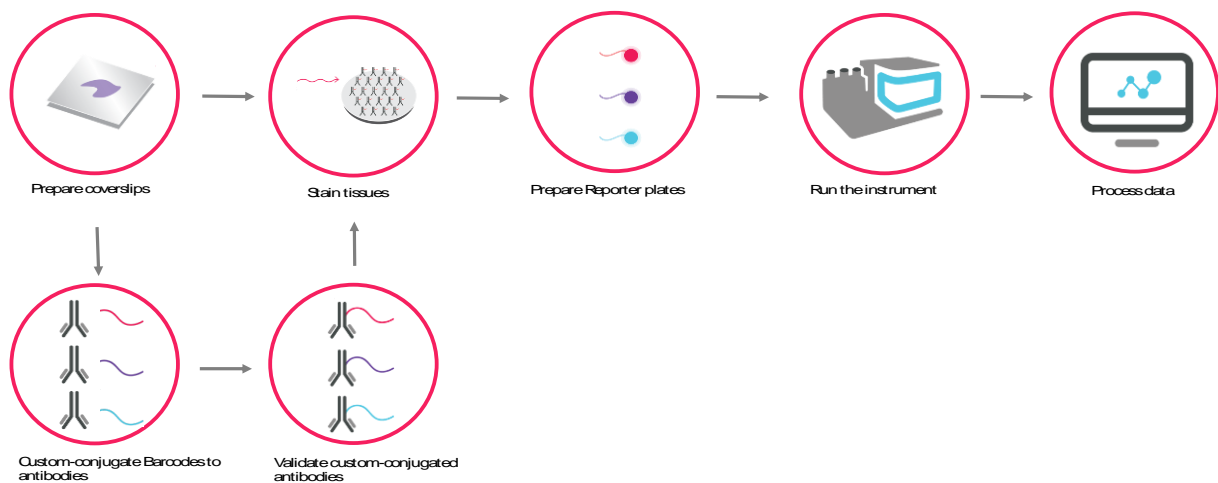

2.1 CODEX® Nomenclature

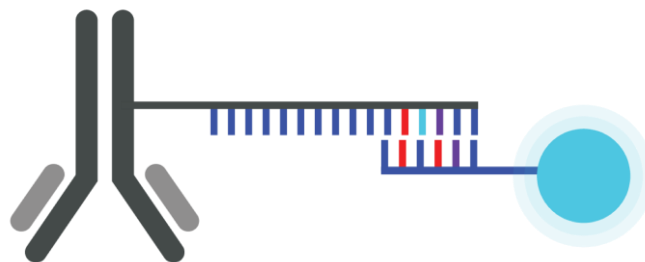

The multiplexing capability of CODEX® technology is based on the proprietary CODEX® barcoding system. Each CODEX® antibody is conjugated to a unique oligonucleotide sequence, referred to as the CODEX® Barcode. Each CODEX® Barcode, in turn, is complementary to a unique CODEX® Reporter. A CODEX® Reporter is comprised of a fluorescent dye and a short oligonucleotide.

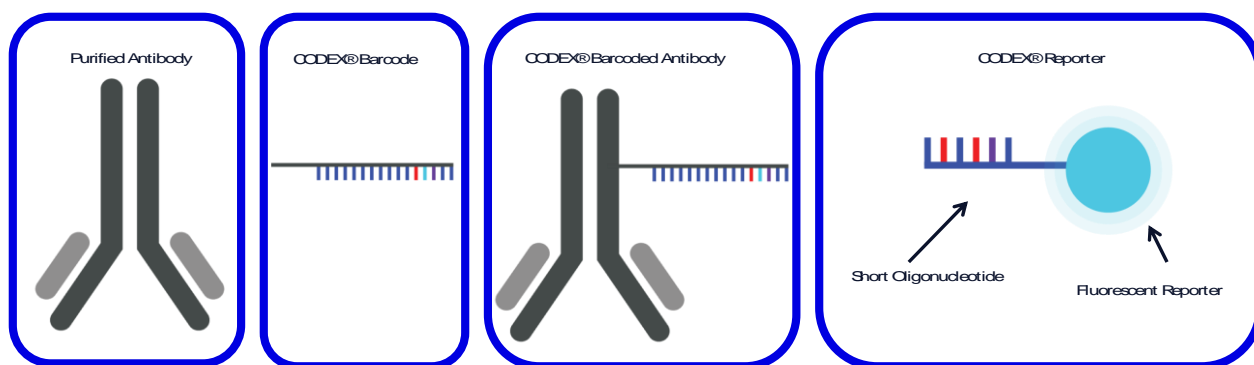

Product	Definition	Naming structure	Abbreviation	Example
CODEX® Antibody	Successfully validated antibody conjugated to a CODEX® Barcode	Antibody - Barcode	Ab-BXxxx	CD4-BX018
CODEX® Barcode	An oligonucleotide that can be custom-conjugated to antibodies of interest	Barcode	BXxxx	BX001
CODEX® Reporter	Fluorophore conjugated to an oligonucleotide that can hybridize with a specific complementary CODEX® Barcode	Fluorophore – Reporter	Dye-RXxxx	AF750-RX003

2.2 CODEX® Technology

CODEX® technology makes use of reversible hybridization between the CODEX® Barcodes and complementary CODEX® Reporters to sequentially reveal dozens of CODEX® Antibodies.

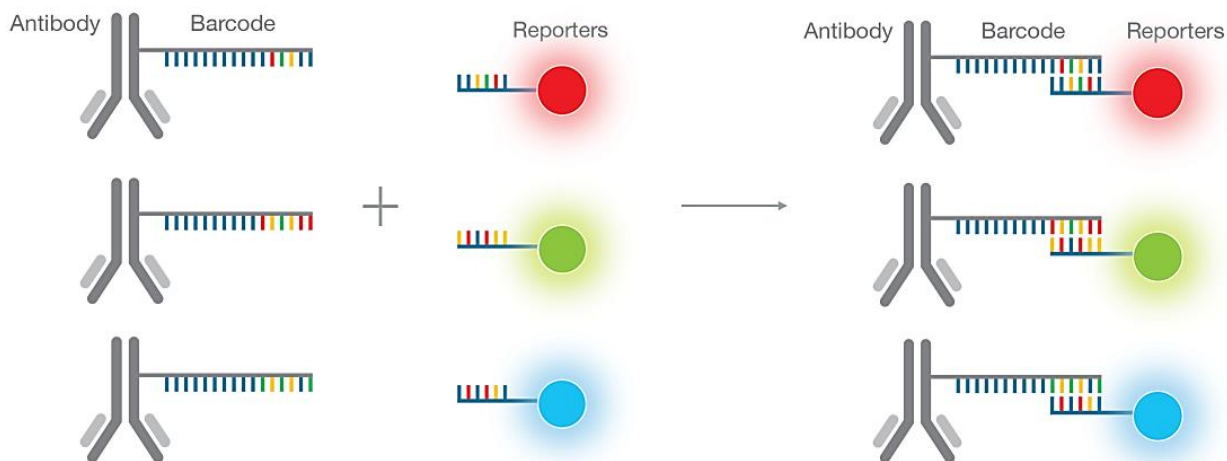

Fluorescently labeled CODEX® Reporters enable highly specific detection of complementary CODEX® Barcodes and their corresponding antibodies. The use of spectrally distinct fluorophores hybridized to each barcode allows precise signal detection in up to three distinct fluorescence channels per cycle.

2.3 CODEX® Experimental Design

In CODEX® experiments, a tissue section is stained manually by multiple CODEX® Antibodies simultaneously. After staining, a CODEX® run is performed on the stained tissue section using a standard epifluorescence microscope interfaced with a CODEX® Instrument.

A CODEX® run is a fully automated process executed by the CODEX® Instrument Manager software. CODEX® Reporters are dispensed onto the tissue by the CODEX® Instrument and revealed via fluorescence microscopy. CODEX® multicycle runs are comprised of multiple cycles: in each cycle, the reporters reveal up to three markers of interest (and DAPI) simultaneously, the tissue is imaged in each spectrally distinct fluorescence channel, and then the reporters are removed from the tissue by a gentle isothermal wash. The repetition of these cycles using different reporters allow for the visualization of a full CODEX® antibody panel in a single experiment and on the same area of tissue.

The CODEX® technology uses a proprietary chemistry which preserves both tissue morphology and the CODEX® antibody staining throughout a CODEX® experiment. Users can purchase CODEX® inventoried antibodies or customize their panel by conjugating purified antibodies to CODEX® Barcodes (refer to [Chapter 4](#)).

The schematics below illustrate the procedures for CODEX® Antibody staining and CODEX® multicycle runs.

A) Single Staining Step: a panel of CODEX® Antibodies is used to stain a tissue section in a single step.

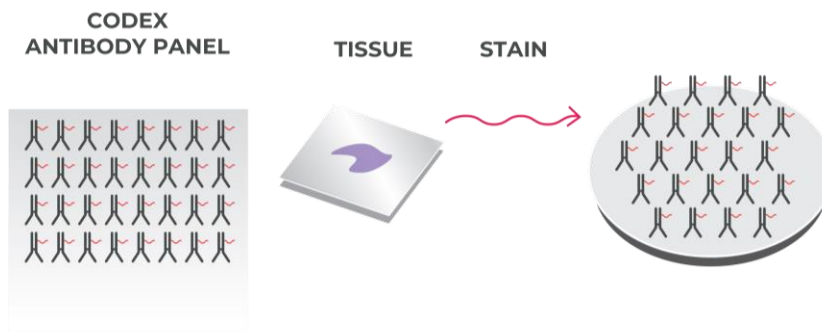

B) CODEX® Multicycle Runs (Reveal-Image-Remove-Repeat)

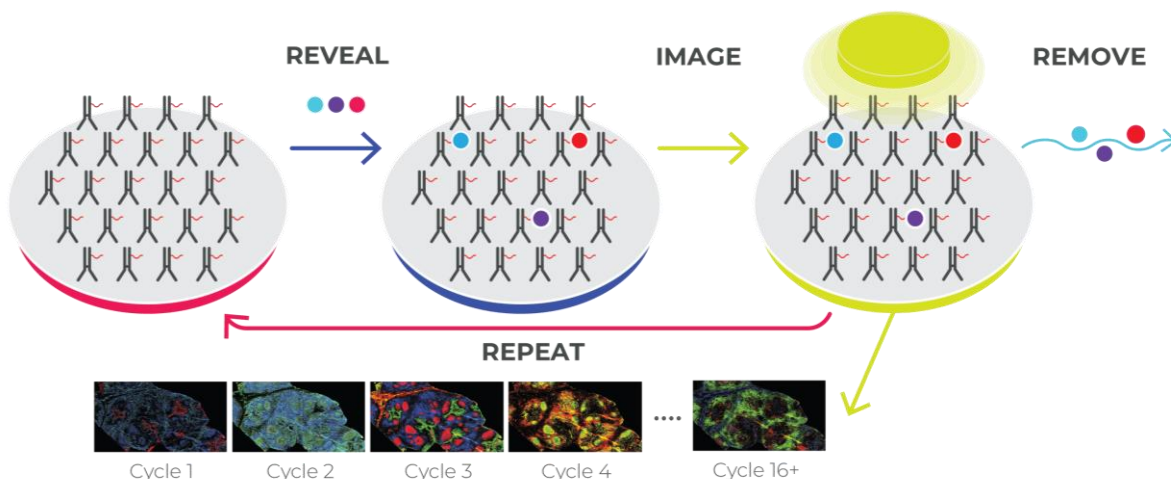

The CODEX® Workflow: the CODEX® Instrument performs consecutive cycles of dispensing reporters, acquiring images, and removing reporters:

- Reveal: Up to 3 CODEX® Reporters are dispensed onto the antibody stained tissue by the CODEX® Instrument and allowed to incubate.
- CODEX® Reporters hybridize to complementary barcodes conjugated to target antibodies.
- Image: The tissue is imaged by the user's microscope which is integrated to the CODEX® Instrument.
- Remove: A gentle isothermal wash is performed to remove the Reporters.

After the execution of a CODEX® multicycle experiment, acquired images are processed and stitched with the following options: background subtraction, deconvolution, extended depth of field, shading correction, t-SNE calculation, and a diagnostic output. Processed images are then analyzed using cell segmentation, an analysis software that identifies single cells and quantifies the fluorescence profile for each biomarker of interest. Cytometric data with spatial information is generated in FCS and CSV file formats.

NOTE

Datasets generated by the CODEX® Processor can be analyzed using the CODEX® Multiplex Analysis Viewer (MAV) or third-party image analysis pipelines.

2.4 Procedural Overview

1. Incubate CODEX® coverslips with poly-L-lysine, and adhere tissue sections to these coverslips.
2. Design a CODEX® Antibody panel. Antibody panels are customizable and can include both commercially available inventoried CODEX® Antibodies, as well as custom-conjugated antibodies. For instructions on how to conjugate CODEX® Barcodes to antibodies of interest, please refer to [Chapter 4](#). When designing the panel, verify that each antibody is conjugated to a unique barcode; barcodes may not be duplicated within a panel.
3. Stain the tissue with the CODEX® antibody panel.
4. Prepare the CODEX® Reporter plate. Reporters complementary to the Barcodes used in the antibody panel are organized into groups of up to three spectrally distinct Reporters. Each group of Reporters, in addition to DAPI, are placed into separate wells of a 96-well plate. Each of these groups comprises one cycle and will be dispensed onto the tissue during separate CODEX® cycles. Below is an example of a panel designed for 4 cycles. Please note: there are two blank cycles— one in the beginning and one at the end which will be used for downstream image processing. Please refer to help.codex.bio for guidelines on exposure time settings as these can vary.

	CODEX® Antibody	Reporter	Antibody Dilution	Volume of Antibody (µL)	Dye channel	Cycle
1	None	None	-	-	ATTO550	1
2	None	None	-	-	Cy5	1
3	None	None	-	-	AF750	1
4	CD44-BX005	Atto 550-RX005	1:200	1	ATTO550	2
5	CD107a-BX006	Cy5-RX006	1:200	1	Cy5	2
6	CD20-BX007	AF750-RX007	1:200	1	AF750	2
7	CD8-BX026	Atto 550-RX026	1:200	1	ATTO550	3
8	CD45-BX021	Cy5-RX021	1:200	1	Cy5	3
9	PanCK- BX019	AF750-RX019	1:200	1	AF750	3
10	None	None	-	-	ATTO550	4
11	None	None	-	-	Cy5	4
12	None	None	-	-	AF750	4

NOTE

A nuclear stain (DAPI) will be included in each cycle.

5. Prepare the CODEX® Instrument by loading 1x CODEX® Buffer, ddH₂O, and DMSO into designated bottles. Place the 96-well plate containing CODEX® Reporters and four clean reservoirs into the CODEX® Instrument.
6. Define the microscope and CODEX® Instrument Manager (CIM) software settings for the CODEX® multicycle run.
7. Follow instructional prompts in the CODEX® CIM software. A blank coverslip will be used on the instrument initially.

8. After preparing and priming the instrument, load the stained tissue section into the stage insert assembly.
9. Perform nuclear staining, focus the microscope on the tissue section and select the region(s) of interest.
10. Initiate the CODEX® multicycle run.
11. After the CODEX® multicycle run is complete, remove the tissue and clean the CODEX® Instrument.
12. Transfer acquired data via the CODEX® Instrument Manager from the acquisition computer to the user's processing computer for data processing. The processed data can then be visualized and downstream analysis can be performed using the CODEX® Multiplex Analysis Viewer (MAV).

Schematic Overview of the CODEX® Procedures

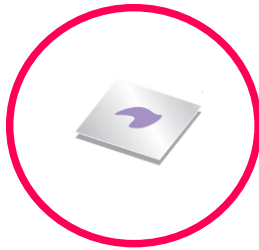

Chapter 3: Poly-L-Lysine treatment of coverslips and Tissue Sectioning

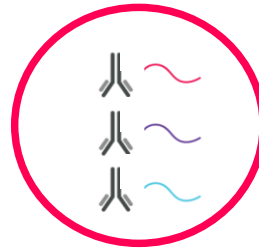

Chapter 4: Conjugate Purified Antibodies (optional)

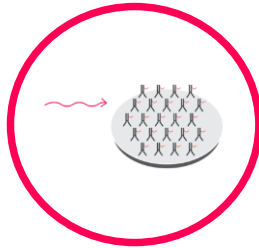

Chapter 5: Tissue Staining with Antibody Panel

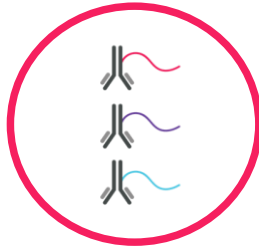

Chapter 6: Custom - Conjugated Antibodies Validation

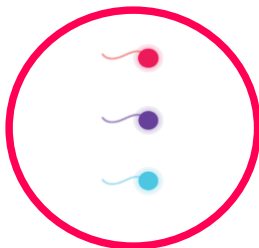

Chapter 7: CODEX® Reporter Plate Preparation

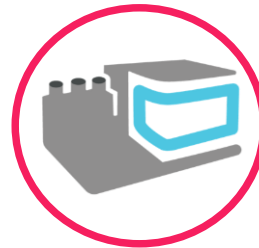

Chapter 8: CODEX® Run



Help.CODEX.bio: Data Processing and Analysis

- CODEX® Processor: Drift Compensation, Background subtraction, Deconvolution, Cropping and Stitching, Segmentation, etc
- CODEX® Multiplex Analysis Viewer: Visualization and analysis of processed data

2.5 User Guide Overview

CHAPTER	TITLE
3	Coverslip Preparation and Tissue Sectioning
4	Antibody Conjugation
5	Tissue Staining
6	Manual Validation of Custom-Conjugated Antibodies via Tissue Staining
7	Preparing CODEX® Reporters
8	Use of the CODEX® Instrument
APPENDIX A	Plate Configurations
APPENDIX B	Titration of CODEX® Antibodies
APPENDIX C	Mounting the Coverslip on a Slide
APPENDIX D	Stage Assembly and Placement into Microscope

Chapter 3: The CODEX® experiment requires that tissue sections are adhered to poly-L-lysine-coated coverslips. This chapter outlines the preparation of poly-L-lysine coated coverslips and provides guidelines on CODEX®-specific tissue sectioning procedures. This chapter must be completed before proceeding with Chapter 5.

Chapter 4: Third-party antibodies of interest can be conjugated to CODEX® Barcodes using the CODEX® Conjugation Kit. This chapter outlines custom-conjugation and quality control procedures for custom-conjugated antibodies. Note: This chapter is optional if your panel only consists of commercially available CODEX® antibodies.

Chapter 5: Tissue sections adhered to poly-L-lysine coated coverslips are stained with CODEX® Antibodies. This chapter outlines how to stain and prepare tissue sections for CODEX® experiments.

Chapter 6: Custom-conjugated antibodies need to be validated to confirm that the conjugation procedure was successful, and the antigen-binding properties of the antibody are intact. This chapter explains how to perform antibody validation, manually apply Reporters to a tissue, and how to mount a coverlip to a slide for manual detection.

Chapter 7: CODEX® experiments require the use of CODEX® Reporters. Reporters are organized into cycles, combined with Reporter Stock Solution and added into separate wells of a 96-well plate. This plate is placed inside the CODEX® Instrument prior to a CODEX® run. This chapter describes how to configure reporters into cycles, prepare Reporter Stock Solution and prepare the CODEX® Reporter plate for use in the CODEX® Instrument.

Chapter 8: The CODEX® Instrument Manager (CIM) software controls the CODEX® Instrument. This software also integrates with the microscope's native software for imaging. This chapter describes the steps involved in setting up the CODEX® multicycle run.

Appendix: Appendix sections offer additional information on supplemental materials and experimental operations critical to the success of CODEX® experiments.

Additional documents: Additional technical details and documents can be found on the CODEX® support page – please see akoyabio.com.

Chapter 3. Coverslip Preparation and Tissue Sectioning

3.1	POLY-L-LYSINE COVERSIP PREPARATION.....	25
3.2	FRESH-FROZEN TISSUE SECTIONING.....	28
3.3	FFPE TISSUE SECTIONING	29

This chapter outlines the techniques for preparation and storage of tissue samples for CODEX® experiments. These steps must be completed prior to starting the CODEX® workflow.

For CODEX® experiments, fresh-frozen or FFPE tissues are sectioned and directly adhered onto poly-L-lysine-coated coverslips. Using microscope slides, uncoated coverslips, and/or tissue preparation techniques that deviate from this protocol are not compatible with the CODEX® platform.

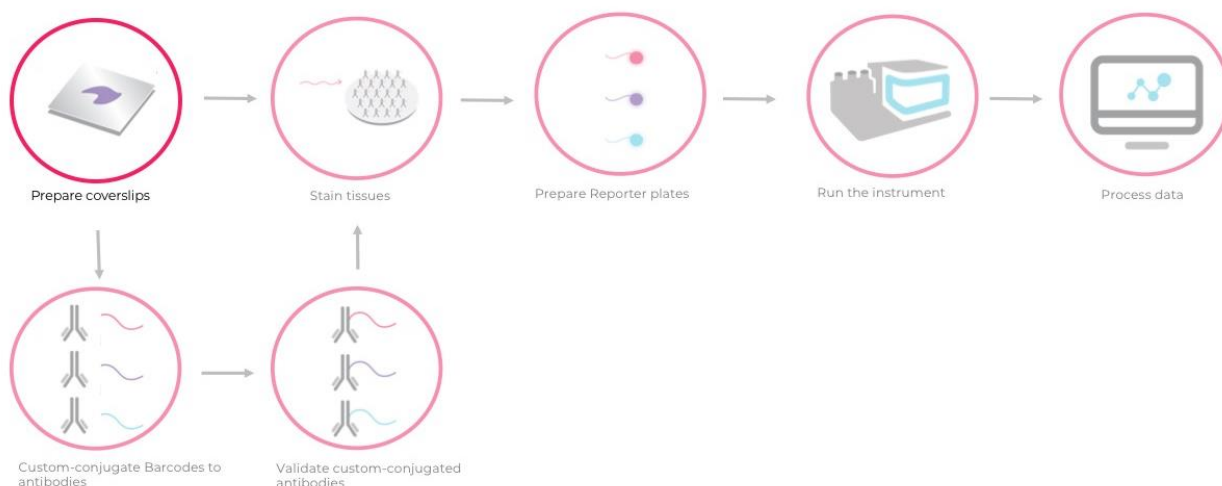

3.1 Poly-L-Lysine Coverslip Preparation

This first section describes the process of coating the coverslips with poly-L-lysine. Tissue sections must be mounted to coated coverslips to maintain adherence of the tissue to the coverslip which is essential for running the CODEX® Instrument. The uncoated coverslips (22mm x 22 mm, #1.5) should be purchased from akoyabio.com.

3.1.1 Incubating Coverslips

Guidelines

Preparation and storage period:

- Please work with the recommended coverslips from Akoya Biosciences. Other brands of coverslips may be too fragile or inaccurately sized and can easily break during CODEX® experiments.
- The preparation of poly-L-lysine coated coverslips requires a minimum incubation of 12 hours. It is recommended that coverslips are treated with poly-L-lysine at least 2 days prior to tissue sectioning.
- The coverslips can be incubated in poly-L-lysine for a maximum of 1 week.
- Poly-L-lysine-coated coverslips must be used within 2 months.

Pre-Experiment Preparation

Kit Contents	PN #	Kit	Storage
Coverslips	7000005	À la carte	RT
CODEX® Coverslip Storage Box	7000013	À la carte	RT

Materials NOT included in Kit

- 0.1% poly-L-lysine solution
- Glass beaker (0.5 L)
- Parafilm

Incubating Coverslips

- Remove the coverslips from the box.
- Gently place coverslips at the bottom of the glass beaker.
- Slowly swirl the beaker to spread the stacks of coverslips across the bottom of the beaker.
- Add enough poly-L-lysine solution to the beaker to ensure that all coverslips are fully covered with solution. If coating a whole box of coverslips, typically 70 mL of poly-L-lysine solution will be sufficient for covering all coverslips.
- Mix the solution and coverslips by rotating the beaker at a 45° angle for 1 minute, ensuring that all coverslips are fully immersed in the solution. Use a pipette tip to remove any air bubbles and coverslips that are stuck together.

NOTE

Coverslips should be dispersed to maximize the surface area of each coverslip exposed to the solution. Minimize the number of coverslips sticking and overlapping with one another.

- Cover the beaker with parafilm to prevent evaporation.
- Leave coverslips in the poly-L-lysine solution for a minimum of 12 hours and up to one week at room temperature (RT).

INCUBATE

Minimum 12-hour incubation at RT

STOPPING POINT

Leave coverslips in poly-L-lysine solution for a minimum of 12 hours and up to one week at RT

3.1.2 Washing and Storing Coverslips

Guidelines

Coverslips

- To prevent removal of poly-L-lysine, do not soak in water for >1 minute during each washing step.
- Dried poly-L-lysine coated coverslips can be stored for up to 2 months at RT.

Reagents

- Milli-Q® ultrapure water (Type 1) or double-distilled H₂O should be used. Deionized H₂O is not recommended.

Pre-Experiment Preparation

Materials NOT included in Kit

- Lint-free drying surface or paper towels
- ddH₂O
- Petri dish or similar container

Washing Coverslips

- a. Slowly pour the poly-L-lysine solution into the proper waste disposal container.
- b. Fill the beaker containing the coverslips to half volume with ddH₂O.
- c. Swirl the contents to mix the solution.
- d. Let the beaker and coverslips sit for 30 seconds.
- e. Slowly pour off the water into the sink.
- f. Repeat steps b – e, for a total of 5-7 washes.
- g. Place two sets of paper towels on the benchtop.
- h. Remove the coverslips from the beaker and place them in a single layer on top of the drying surface or a first set of paper towels. Ensure coverslips do not stick together as they will not properly dry.

NOTE

Coverslips can be removed from the beaker in batches.

- i. Let the coverslips dry for several hours.
- j. If needed for complete drying, invert each coverslip. Dry the reverse side on the drying surface or a second set of paper towels.
- k. Leave the coverslips on the drying surface or paper towels to dry overnight.
- l. When the coverslips are completely dry, the poly-L-lysine-coated coverslips can be stored in a petri dish or similar container.

STOPPING POINT

Place poly-L-lysine coated coverslips in a petri dish for storage for up to 2 months.

3.2 Fresh-Frozen Tissue Sectioning

Fresh-frozen tissue sections are mounted directly onto poly-L-lysine-coated coverslips. Appropriate preparation and storage of tissue sections are critical to ensure sample integrity. The instructions provided in this manual are specific to the CODEX® workflow, and they are not intended to be a comprehensive guide for tissue processing. Further guidance on tissue processing of fresh-frozen samples can be found on our website, "[Guidelines: Tissue processing – Best practices](#)" at akoyabio.com.

Guidelines

Tissue Sections

- Tissue sections adhered to poly-L-lysine-coated coverslips can be stored at -80°C for up to 6 months before staining.
- It is critical that tissue thickness does not exceed 10 µm as this can affect the autofocusing capabilities of the microscope.
- For best results, tissue sections should be completely adhered to the coverslip without folds or tears.
- To ensure that tissue sections are not damaged, it is critical that the tissue coverslips are not stacked on top of one another.

Pre-Experiment Preparation

Materials Included in Kit

- CODEX® Coverslip Storage box, 7000013

Materials NOT Included in Kit

- Poly-L-Lysine-coated coverslips prepared in section 3.1.
- Fresh-frozen tissue block of interest
- Compressed/canned air duster
- Dry ice
- Polystyrene container for Dry ice
- Cryostat for tissue sectioning
- Blade for tissue sectioning (we recommend 63069-LP Low Profile Microtome Feather® Blade by Electron Microscopy Sciences)

Prepare Cryostat Chamber

Standard cryostats with temperature control are recommended for tissue sectioning. Most tissues are sectioned in temperatures ranging from -15°C to -25°C. The exact temperature is unique to each tissue type and should be determined according to standard sectioning procedures.

Fresh-Frozen Tissues - Sectioning Instructions

- a. Set the cryostat chamber to tissue-specific temperature range.
- b. Place the CODEX® Coverslip Storage box in the cryostat chamber to equilibrate to the cryostat temperature.
- c. Once the cryostat reaches the programmed temperature, transfer the tissue from the -80°C freezer to the cryostat using a container filled with dry ice.
- d. Use compressed air to remove dust and lint from the coverslips before use.
- e. Place the prepared poly-L-lysine-coated coverslips in the cryostat chamber to equilibrate temperature for 20-30 seconds.
- f. Section the tissue at a thickness of 5-10 µm.

CRITICAL

Do not exceed 10 µm as this will affect the autofocusing capabilities of the microscope.

Avoid folds and tears in the tissue, as these artifacts will affect image quality and data analysis.

- g. Gently place the tissue section in the center of the coverslip.
- h. Adhere the tissue section to the coverslip by placing a gloved finger underneath the coverslip for 1-2 seconds.

CRITICAL

Do not keep your finger on the coverslip for longer than the minimum time necessary to melt the OCT.

NOTE

The directed heat transfer should melt the OCT, thereby ensuring tissue adherence.
Chemical fixation of the tissue will take place during the staining protocol.

- i. Place the mounted coverslip in a single slot of the CODEX® Coverslip Storage box.
- j. Repeat steps f - i for each tissue section.
- k. Once complete, cover the CODEX® Coverslip Storage box with the lid.
- l. Place the box of mounted coverslips on dry ice for transport to a -80°C freezer.

STOPPING POINT

If prepared and stored properly, samples can be stored at -80°C for up to six months. Limit exposure to changes in temperature and keep storage box upright and secure as to minimize movement of coverslips.

NOTE

Tissue processing and sectioning are critical steps and need to be performed by trained users. Resources for tissue processing best practice procedures can be found on our website, "Guidelines: [Tissue processing – Best practices](#)" at [akoyabio.com](#)

3.3 FFPE Tissue Sectioning

FFPE tissue sections are mounted onto poly-L-lysine-coated coverslips. Preparation and storage of tissue sections are critical for sample integrity. The instructions outlined in this manual are specific to the CODEX® workflow, and are not intended to be a comprehensive guide on tissue processing. Further guidance on tissue processing for FFPE samples can be found in "[Guidelines: Tissue processing – Best practices](#)" at [akoyabio.com](#)

Guidelines

Tissues

- FFPE tissues sectioned onto poly-L-lysine-coated coverslips can be stored at 4° C for up to six months
- It is critical not to exceed a thickness of 10 µm as this may disrupt the autofocusing capabilities of the microscope.
- For best results, the tissue should be completely adhered to the coverslip with minimal tears or folds.
- To ensure that tissue sections are not damaged, it is critical that the tissue coverslips are stored properly and not stacked on top of one another.

Pre-Experiment Preparation

Materials Included in Kit

- Coverslip storage box , Product Number 7000013

Materials NOT Included in Kit

- Poly-L-lysine-coated coverslips prepared in section 3.1 of the User Manual

- Compressed/canned air duster
- FFPE tissue block
- Microtome for tissue sectioning
- Blade for tissue sectioning (we recommend using 63069-LP Low Profile Microtome Feather® Blade by Electron Microscopy Sciences)
- 40°C water bath
- An angled slide holder for laying and drying the coverslips after adhering tissue sections (recommended but optional)
- Tissue storage box

Prepare Microtome

Prepare the Microtome for use at RT following the standard operating procedures of the instrument.

FFPE Tissues - Sectioning Instructions

- a. Prepare a water bath at 40°C and place it next to the microtome.
- b. Prepare a clean, dry surface for placing the coated coverslips next to the microtome.
- c. Use compressed air to remove dust and lint from the coverslip prior to use.
- d. Place the poly-L-lysine-coated coverslips next to the microtome.
- e. Insert a new blade for sectioning each new block, or as paraffin accumulates on the blade.
- f. Section the tissue at a thickness of 5-10 µm.

CRITICAL

Do not exceed 10 µm as this can disrupt the autofocusing capabilities of the microscope. Avoid folds and tears as these artifacts will affect image quality and data analysis.

- g. Place the sectioned tissue in the water bath for a few seconds to allow the tissue to flatten out.
- h. Once the tissue is completely flat and devoid of folds or wrinkles, using forceps, quickly place a poly-L-lysine-coated coverslip in the water bath and gently move it towards the tissue. Doing so, the tissue will lay on the coverslip as it is moved out of the water bath.

NOTE

Make sure that the tissue section is placed in the center of the coverslip.

- i. Put the coverslip on a clean surface (with the tissue facing up) or on the angled slide holder and let it dry overnight at RT.
- j. Repeat steps f - i for each tissue section.
- k. When the sections are dry, place each tissue coverslip in a single slot of the storage box, and cover the storage box with the lid.

NOTE

If stored properly, samples can be stored at 4°C for up to six months. Store box in a secure location, kept upright as to minimize movement of coverslips.

STOPPING POINT

The box of mounted coverslips can be kept at 4°C for up to 6 months.

NOTE

Tissue processing and sectioning are critical processes and need to be performed by trained users. Resources for best practice procedures and recommendations for avoiding artifacts can be found in "[Guidelines: Tissue processing – Best practices](#)" at akoyabio.com

Chapter 4. Antibody Conjugation

4.1 CONJUGATING ANTIBODIES 32
 4.2 VALIDATING CUSTOM-CONJUGATED ANTIBODIES (VIA GEL ELECTROPHORESIS)..... 38

This chapter outlines how to custom-conjugate third-party, non-inventoried, purified antibodies to CODEX® Barcodes. The conjugation allows converting clones of interest into antibodies tagged with CODEX® Barcodes that can then be used in CODEX® multicycle experiments.

NOTE Please refer to Akoya's CODEX® Screened Antibody List for clones that have been successfully conjugated and have shown positive and specific staining patterns in relevant tissue samples. These purified clones are commercially available from other antibody vendors and require conjugation by the end user.

CODEX® Antibodies purchased from Akoya are already tagged with CODEX® Barcodes. Therefore, conjugation is not necessary and this chapter can be skipped.

The protocol takes approximately 4.5 hours from start to finish. There are two incubation steps: one for 30 minutes and another for 2 hours.

The success of the conjugation can be verified via gel electrophoresis, which is used as quality control. Please note that this step requires additional equipment and materials not included in the CODEX® Conjugation Kit.

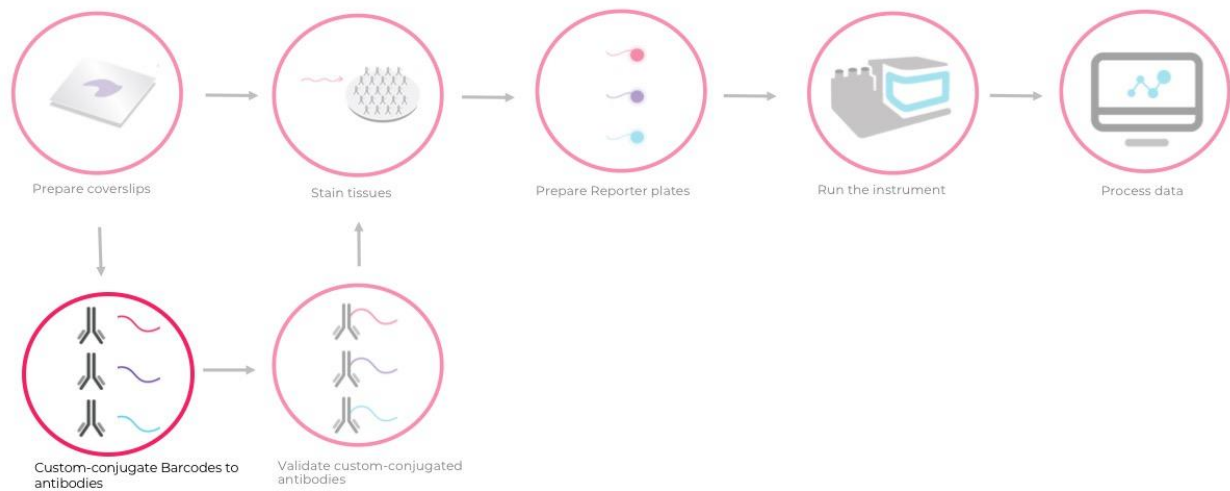

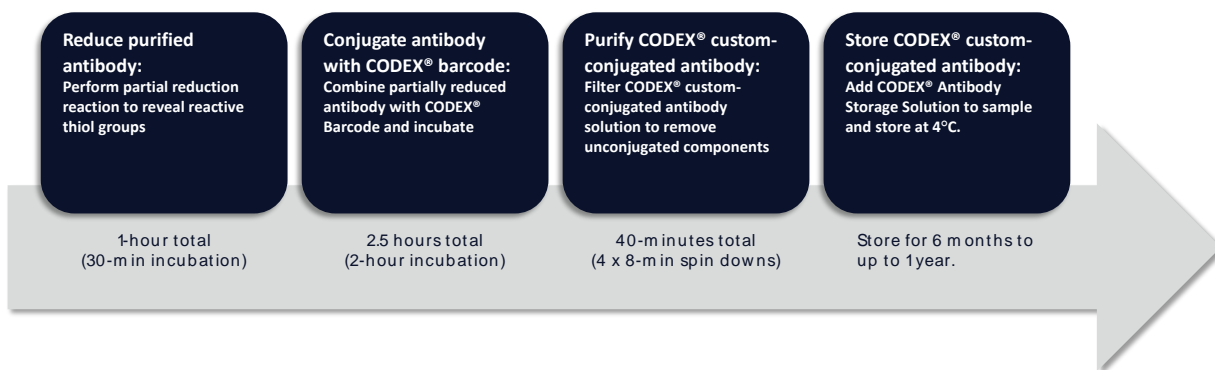

Conjugation overview: A sample of purified antibody (not provided by Akoya) is treated with a reducing agent. During the conjugation reaction, the reduced moieties of the purified antibody reacts with a CODEX® Barcode to form a covalent bond. The conjugated antibody is then purified and stored for future use.

4.1 Conjugating Antibodies

Guidelines

Assigning CODEX® Barcodes to Antibodies

- Identify and validate unconjugated antibody clone. Prior to conjugation with CODEX® Barcodes, it is critical to identify the best-suited antibody clone and verify positive staining using the unconjugated/purified antibody clone in the tissue of interest. Please refer to Akoya's CODEX® Screened Antibody List for clones that have been successfully conjugated and have shown positive staining patterns in relevant tissue samples. Optional: At this point, you may also consider assessing the specificity of the purified antibody clone. This can be done by staining with the antibody clone and a positive and negative counterstain when possible.
- Assess quantities of reagents. The CODEX® Conjugation Kit contains reagents sufficient for 10 conjugation reactions, each using 50 µg of purified antibody per reaction.
- Purchase CODEX® Barcodes and CODEX® Reporters. Each Barcode corresponds to a specific Reporter and, consequently, to a well-defined and spectrally-distinct fluorescence channel. Each unique barcode can only be used for a single antibody in any CODEX® panel.
- Consider antigen abundance and fluorescence channel sensitivity when selecting barcodes for conjugation. Less abundant antigens produce lower-intensity signals and perform better if conjugated to CODEX® Barcodes assigned to fluorescence channels with low autofluorescence. The corresponding reporter dyes are Cy5 and ATTO550 for fresh-frozen tissues and Cy5 for FFPE. For antibodies targeting highly expressed antigens, we recommend using CODEX® Barcodes corresponding to AF488 for fresh-frozen tissues, and ATTO550 and AF750 for FFPE tissues. These channels are recommended for highly expressed antigens due to the possibility of high autofluorescence (AF488 for fresh-frozen and ATTO550 for FFPE) and due to varying camera quantum efficiency (AF750). For FFPE samples, we recommend conjugating antibodies to Barcodes corresponding to AF750 only after having performed a preliminary conjugation on a different channel, for example, Cy5. This extra step is recommended because camera sensitivities tend to decrease approaching the Near Infrared Region (NIR), and only after ensuring a strong signal in a different channel should the marker be expected to work well for AF750.

Users can follow the scheme below for assigning CODEX® Barcodes to antibodies of interest.

ANTIGEN	TYPE OF TISSUE	CODEX® REPORTER
LESS ABUNDANT	FF	<ul style="list-style-type: none"> • CY5 • ATTO550
	FFPE	<ul style="list-style-type: none"> • CY5
MORE ABUNDANT	FF	<ul style="list-style-type: none"> • AF488
	FFPE	<ul style="list-style-type: none"> • ATTO550 • AF750*

*After preliminary screening

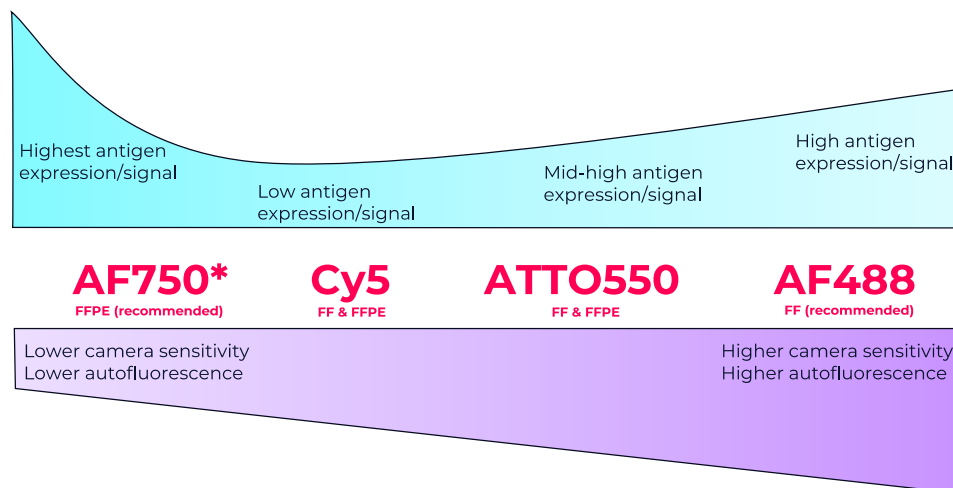

*Since AF750 dye is in the Near IR region, low camera sensitivity may cause conjugations to appear as a failure although another channel will show successful conjugation. As such, we suggest doing preliminary screening on a different channel to confirm successful conjugation of a particular antibody clone and then conjugating more abundant antigens/ stronger antibody signal intensity to this channel.

Using Purified Antibodies

- **Purchase pre-purified antibodies.** When selecting clones for conjugation to CODEX® Barcodes, we recommend purchasing purified antibodies, in PBS or a similar buffer, free of carrier proteins and other chemicals. Otherwise, purification is necessary. Many vendors may also allow you to purchase a “custom-formulation” free of carrier proteins if requested.

- **Purify before conjugation if necessary.** If purified clones are not commercially available, a purification process must be performed before conjugation. Carriers like BSA, Gelatin, Glycerol, etc. must be removed prior to conjugation. The presence of sodium azide does not interfere with conjugation and does not need to be removed.
- **Quantify antibodies accurately.** Be sure to measure the concentration of commercial antibodies using a NanoDrop or similar instrument. This is important for calculating the amount of antibody to use for conjugation.

NOTE

The success of custom conjugation is highly dependent on the ratios of antibody to barcode. Often, the concentrations labeled on the antibody tubes are not accurate.

Antibody filtration

The purified antibody is added to the top of a 50 kDa Molecular Weight Cut-Off (MWCO) filter. Centrifugation steps are performed, resulting in concentrated antibody solution in the filter unit and flow-through in the bottom of the tube. Flow-through solution should be discarded after each step as instructed. A 50 kDa MWCO filter must be used. Use of filters other than 50 kDa MWCO will likely result in poor purification, poor conjugation, and/or loss of tagged antibody.

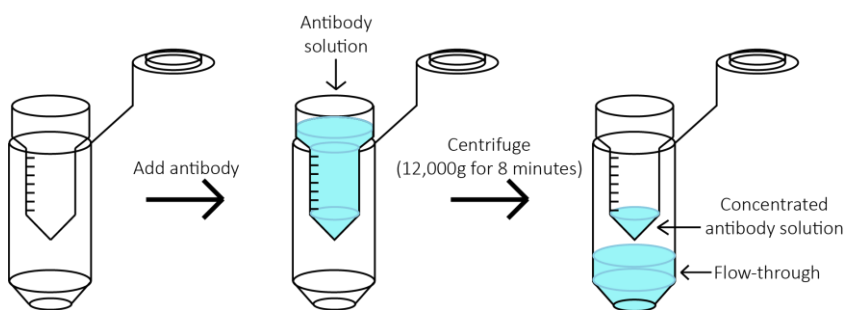

Pre-Experiment Preparation

Materials Included in Kit

CODEX® Conjugation Kit contents	Stored at	Notes
Retrieve before beginning the experiment		
Reduction Solution 1	-20°C	Single use tubes. Do NOT re-use after thawing once. Each tube has enough reagent for up to 3 conjugations. Any remaining reagent should be discarded.
Reduction Solution 2	4°C	
Filter Blocking Solution	4°C	
Retrieve after 30-min incubation for step 4.1.5		
Conjugation Solution	4°C	
CODEX® Barcodes (individual purchase)	-20°C	Individual purchase, not included in CODEX® conjugation Kit.
Retrieve after 2-hour incubation for step 4.1.8		
Purification Solution	4°C	
Antibody Storage Solution	4°C	

Materials NOT Included in Kit

Biologics:

- Purified antibody(s)

Consumables:

- 50 kDa MWCO filter
- 1.5 mL screw-top sterile tube(s)
- Nuclease-free molecular biology grade water
- PBS
- 0.2 mL PCR tubes (for Quality Check, Section 4.2)
- Bucket of ice for antibodies

Instrumentation:

- Centrifuge for 1.5 mL tubes
- NanoDrop™ spectrophotometer
- Vortex (Optional)

4.1.1 Assign a CODEX® Barcode to each antibody that will be conjugated

- a. Label a 50 kDa MWCO filter for each antibody to be conjugated.

4.1.2 Block non-specific binding of antibody to MWCO filter

- a. Add 500 µL of Filter Blocking Solution to the top of each 50 kDa MWCO filter.
- b. Spin down at 12,000g for 2 min.
- c. Remove all liquid on the top of the column, as well as the flow-through solution. Use a micropipette if desired.

4.1.3 Measure and calculate protein concentration

- a. Set up a NanoDrop™ spectrophotometer, or similar instrument, for absorbance readings. Use pre-set IgG settings.
- b. Calculate the volume of solution that corresponds to 50 µg of antibody.

4.1.4 Concentrate purified antibody solution

- a. Add the volume corresponding to 50 µg of the antibody volume calculated in 4.1.3 to each 50 kDa MWCO filter. If the volume is less than 100 µL, adjust the volume to 100 µL by adding 1x PBS.
- b. Spin down tubes at 12,000 g for 8 min.
- c. During the centrifugation, prepare Antibody Reduction Master Mix as described in 4.1.5.
- d. Discard flow-through.

4.1.5 Initiate antibody reduction

- a. Prepare the Antibody Reduction Master Mix based on the number of antibodies to be conjugated. One tube of Reduction Solution 1 can be used for up to 3 conjugation reactions.

Number of Conjugations	1	2	3	4	5	6	7	8
Reduction Solution 1 [µL]	6.6	13.2	19.8	26.4	33	39.6	46.2	52.8
Reduction Solution 2 [µL]	275	550	825	1100	1375	1650	1925	2200
Total [µL]	281.6	563.2	844.8	1126.4	1378	1689.6	1971.2	2252.8

NOTE

Thawed aliquots of Reduction Solution 1 should NOT be reused.

- b. Add 260 µL of the Antibody Reduction Master Mix to the top of each filter unit.
- c. Briefly, vortex solution in filter units for 2-3 seconds to mix
- d. Incubate the tube at RT for 30 min.

**CRITICAL
INCUBATION**

30-minute incubation. It is critical NOT to exceed 30 min. Exceeding 30 min will result in irreversible damage to antibodies and a failed conjugation.

4.1.6 Buffer Exchange of the Antibody Solution

- After the 30-minute incubation has completed, spin down the tubes at 12,000g for 8 min.
- Discard the flow-through solution.
- Add 450 µL of Conjugation Solution to the top of each column.
- Spin down at 12,000g for 8 min.
- During centrifugation, prepare CODEX® Barcode Solution in 4.1.7.

4.1.7 Prepare CODEX® Barcode Solution

NOTE

Each Barcode is used once for every 50 µg of antibody.

**CRITICAL
INCUBATION**

After retrieving barcodes, do not spend more time than necessary on protocol steps as Barcode integrity can start to degrade. We recommend conjugating no more than 6 Barcodes at a time for this reason.

- Add 10 µL of Nuclease-free molecular biology grade water to each lyophilized Barcode container.
- Add 210 µL of Conjugation Solution to each suspended Barcode.
- Pipette up and down to dissolve all the lyophilized material.
- Mix by gentle pipetting. Set aside.

4.1.8 Set Up Antibody Conjugation Reaction

- After the spin has completed in step 4.1.6 e, discard the flow-through.
- Add the respective CODEX® Barcode Solution created in step 4.1.7 to the top of each filter.
- Close the lid and vortex the solution for 2-3 seconds to mix.
- Incubate the antibody conjugation reaction for 2 hours at RT.

INCUBATE

2-hour incubation at RT.

4.1.9 Purify CODEX® Antibody Conjugates

- After the 2-hour incubation, remove a 5 µL aliquot of the purified solution into a new 0.2 mL PCR tube for validation of conjugation (Section 4.2).

NOTE

Do not skip step 4.1.9a. Once a conjugated antibody is placed in Antibody Storage Solution, a gel cannot be run on the sample to verify conjugation.

- Spin down the remainder of the solution at 12,000g for 8 min.
- Discard the flow-through solution.
- Add 450 µL of Purification Solution to the top of each column.
- Spin down at 12,000g for 8 min.
- Repeat steps c – e two more times for a total of three purifications.

- g. After the third centrifugation, discard the flow-through solution.
- h. The filter will contain the conjugated antibody solution.

4.1.10 Collect CODEX® Antibody Solution

- a. For each antibody, label a new outer tube that can hold filter units with the corresponding antibody name.
- b. If desired, cut the lid off of the tube to minimize damage during centrifugation.
- c. Add 100 µL of Antibody Storage Solution to each filter unit.
- d. After it is labeled, place the new empty tube upside-down on top of the filter.
- e. Invert the filter unit for collection into the new collection tube.
- f. Spin solution down at 3,000g for 2 min. The final volume in the tube should be about 120 µL.

STOPPING POINT

Transfer the solution to a sterile, screw-top tube for storage at 4°C for up to 1 year.

After antibody conjugation, do not use these antibodies for tissue staining for at least 2 days. If used for staining sooner, you may observe high levels of background nuclear staining.

4.2 Validating Custom-Conjugated Antibodies (via Gel Electrophoresis)

Verifying the Success of Conjugation

Protein gel electrophoresis can be performed to verify the success of the antibody conjugation reaction. Please note that this procedure only assesses the success of the chemical reaction used for barcode-antibody conjugation. Antibody validation is considered complete only after verifying staining in tissue samples. Please refer to Chapter 6 for guidelines on this procedure.

Heavy chains of conjugated antibodies will show higher molecular weights than their unconjugated counterparts. This comparison can be done by loading a protein gel using the following components:

- 5 µL of each conjugated antibody from section 4.1.9a.
- 1 µg (usually corresponding to 2 µL) of unconjugated antibody to be used as control.
- A protein ladder to be used as a molecular weight standard.

Pre-Experiment Preparation

Materials NOT Included in Kit

Use the reagents and protein gel of choice. In the present example, we used the following items:

- NuPAGE™ LDS Sample Buffer (4X) (Thermo Fisher Scientific, cat. # NP0008)
- NuPAGE™ Sample Reducing Agent (10X) (Thermo Fisher Scientific, cat. # NP0009)
- NuPAGE™ 4-12% Bis-Tris Protein Gels (Thermo Fisher Scientific, cat. # NP0321BOX)
- Novex™ Sharp Pre-Stained Protein Standard (Thermo Fisher Scientific, cat. # LC5800) - 3.5-260 kDa
- XCell SureLock™ Mini-Cell Electrophoresis System (Thermo Fisher Scientific, cat. # EI001 and related)
- NuPAGE™ MOPS SDS Running Buffer (20X) (Thermo Fisher Scientific, cat. # NP0001)
- Novex™ SimplyBlue™ SafeStain (Thermo Fisher Scientific, cat. # LC6065)
- ddH₂O
- Nuclease-free water

Instrumentation:

- 95°C dry bath
- Shaker
- Microwave

4.2.1 Sample Preparation

- a. Dilute each of the conjugated antibodies and the unconjugated antibody control to a final volume of 13 μL with nuclease-free water.
- b. Add 5 μL of NuPAGE™ LDS Sample Buffer (4X) (NP0008) or an analogous product to each sample tube.
- c. Add 2 μL of NuPAGE™ Sample Reducing Agent (10X) (NP0009) or an analogous reducing agent to each sample tube.
- d. Denature all samples at 95°C in a dry bath for 10 min.

4.2.2 Gel Setup

- a. Prepare enough volume of buffer for running the gel. In our example, we prepared 800 mL of 1x NuPAGE™ MOPS SDS Running Buffer by diluting 40 mL of NuPAGE™ MOPS SDS Running Buffer (20X) in 760 mL of ddH₂O.
- b. Prepare the gel and place it in the tank following manufacturer instructions.
- c. Pour the buffer in the gel tank making sure that the liquid fully covers the gel.
- d. Load one well with the protein standard to determine molecular weight.
- e. Load a second well with 20 μL of the denatured control unconjugated antibody solution.
- f. Load each of the remaining wells with 20 μL of the denatured conjugated antibody solution.
- g. Run the gel at 200 V for 30-40 min until completion.
- h. Turn off the current when the protein standard appears at the end of the gel.

4.2.3 Gel Visualization

- a. Remove the gel from the plastic cassette.
- b. Gently transfer the gel into a microwavable container filled with ddH₂O.
- c. Microwave the gel until the first bubbles form.
- d. Stain the gel with Novex SimplyBlue™ SafeStain (LC6065) or an analogous product according to manufacturer's instructions.
- e. Microwave the gel again until the first bubbles form.
- f. Place the gel in the shaker for 10 min.

- g. Wash the gel with ddH₂O and leave it on the shaker until bands are visible. More microwaving steps can be added to accelerate this process or it can be left overnight on a shaker. Additionally, it is important to change the water.

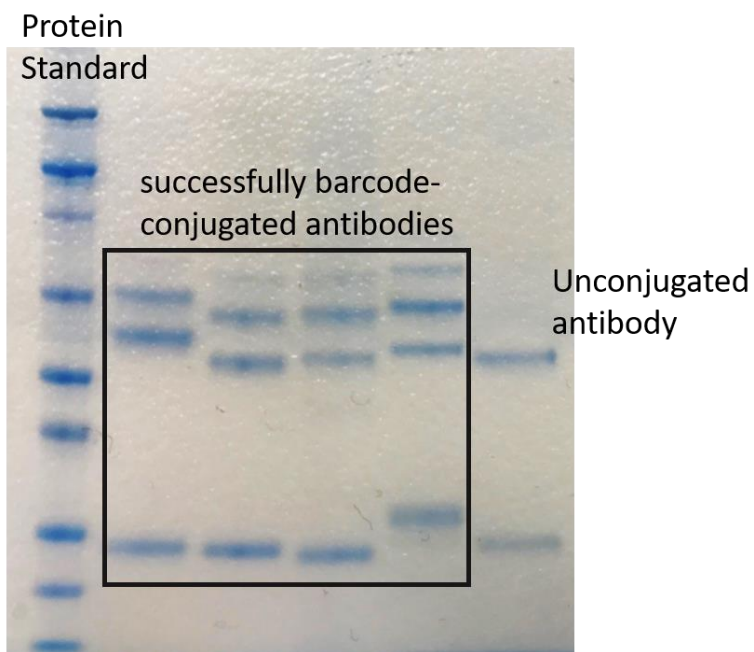

From left to right: the first column shows the protein standard, columns from the second to the fifth show bands of successfully barcode-conjugated antibodies. The last column shows the heavy and light chain bands from a control, unconjugated antibody.

NOTE

Microwaving steps are optional. They are used to accelerate the gel readout.

NOTE

Antibody validation is only complete after tissue staining. This procedure is described in [Chapter 6](#).

NOTE

Wait at least 2 days before using newly conjugated antibodies for tissue staining. Otherwise, you may experience high levels of background nuclear staining.

Chapter 5. Tissue Staining

5.1 FRESH-FROZEN TISSUE PRE-STAINING	42
5.2 FRESH-FROZEN TISSUE STAINING	48
5.3 FRESH-FROZEN TISSUE POST-STAINING.....	49
5.4 FFPE TISSUE PRE-STAINING	55
5.5 FFPE TISSUE STAINING	62
5.6 FFPE TISSUE POST-STAINING	64

This section describes the process of staining tissue sections with CODEX® Antibodies.

Tissues must be mounted on to poly-L-lysine coated coverslips, as outlined in [Chapter 3](#), prior to tissue staining. Buffers and reagents required to perform tissue staining are provided in the CODEX® Staining Kit.

Tissues are stained with the entire antibody panel at once. This can be entirely made of commercial CODEX® Antibodies, custom-conjugated antibodies (purified antibodies conjugated to CODEX® Barcodes following the protocol in [Chapter 4](#)), or a combination of both. It is critical that each CODEX® Barcode is used only once in the antibody panel. Tissues are stained with an Antibody Cocktail Solution comprised of CODEX® Blocking Buffer and the panel of CODEX® Antibodies.

The entire staining process will take approximately 5.5 hours for fresh-frozen tissue sections and 7 hours for FFPE tissues. This time includes a 3-hour incubation step. Do not exceed or shorten this incubation time.

CODEX® staining also has to be performed for validation of custom-conjugated antibodies using a manual validation protocol that does not use the CODEX® Instrument. In this case, refer to [Chapter 6](#) before performing tissue staining.

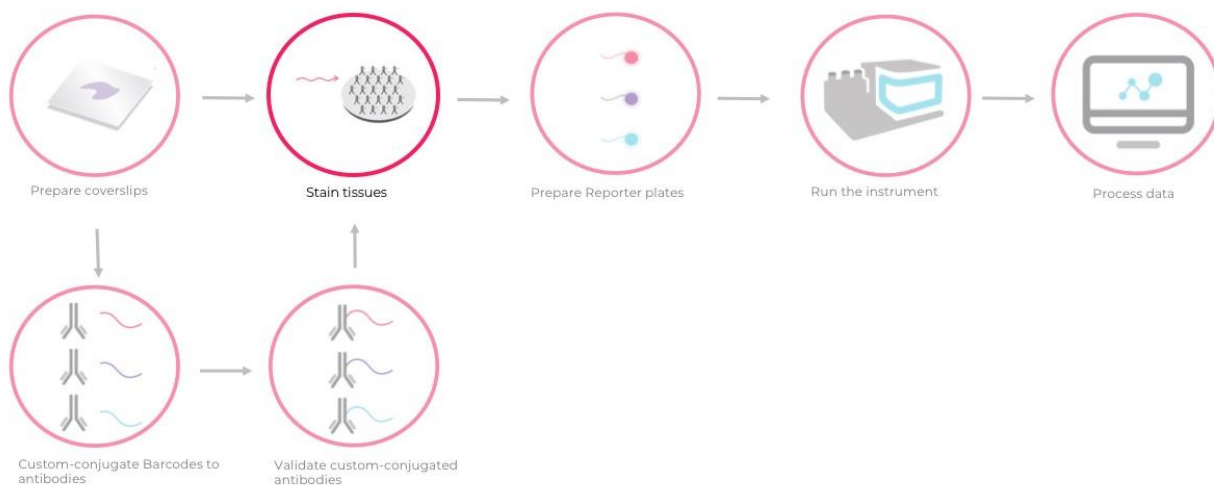

Timeline for fresh-frozen tissues:

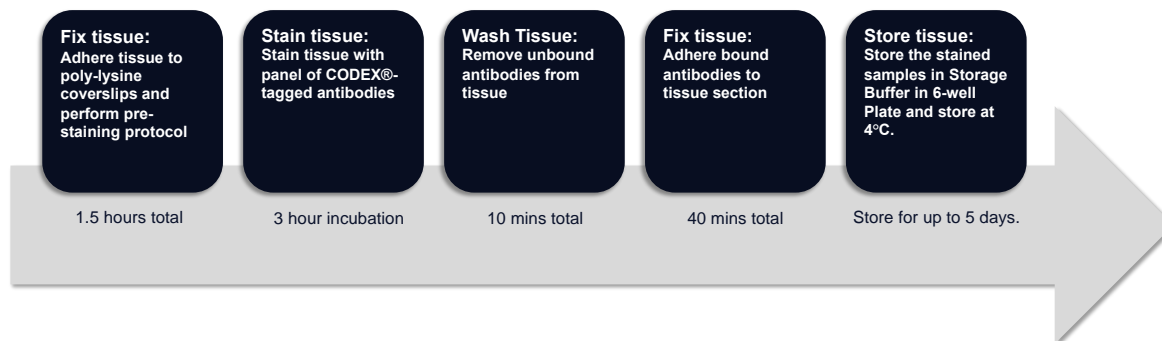

Staining workflow overview for FFPE tissues:

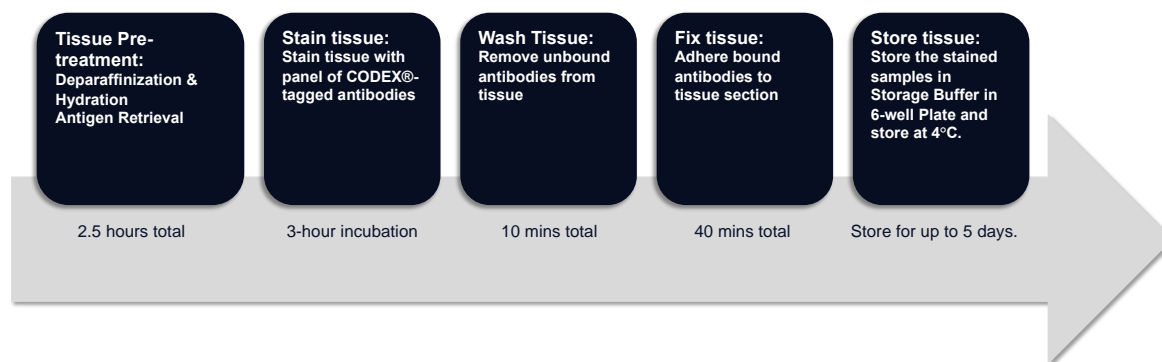

5.1 Fresh-frozen Tissue Pre-Staining

This section describes the preparation of fresh-frozen tissues for staining with CODEX® Antibodies. When working with freshly conjugated antibodies (as described in [Chapter 4](#)), we recommend waiting at least two days before using the antibodies for tissue staining.

CRITICAL

Allow the Hydration, Staining and Storage Buffers to equilibrate to room temperature before using. Prepare all plates and consumables ahead of time to prevent sample degradation.

Guidelines

Terminology

- In the protocol, the term “sample coverslip(s)” refers to tissue sections mounted onto poly-L-lysine-coated coverslips.

Sample coverslip handling:

- It is imperative to avoid tissue drying by minimizing tissue exposure to air. Tissue drying is detrimental to staining quality.
- To avoid damaging the tissue, avoid dispensing liquid directly onto the tissue. Always pipette solutions on to the corner of the coverslips and allow the liquid to flow over the tissue.

- Coverslips should be handled using the recommended bent-tip tweezers. Take care when handling coverslips as they are fragile. As such, it is good practice to stain more than one sample coverslip with the same antibody panel as a backup.

Humidity Chamber Use

- During the 3-hour antibody incubation step, the sample coverslip is placed inside of a humidity chamber and covered with the antibody cocktail solution. The humidity chamber should be placed on a stable surface with minimal shaking or vibration. If the surface tension of the antibody cocktail solution covering the sample coverslip is disrupted, the tissue may dry out.
- When transferring samples between tissue culture plates and the humidity chamber, you can gently remove any excess liquid on the coverslip by dabbing the edge gently with a paper towel or Kimwipe.
- In some steps, liquids are dispensed onto sample coverslip(s) inside the humidity chamber. Always rinse the humidity chamber tray between uses to minimize cross-contamination.

Duration:

- Incubation times have been optimized for fixing or staining the tissue, ensuring the tissue does not dry. Do not exceed or shorten these recommended incubation times.

Safety

- Acetone, PFA, and methanol are toxic chemicals and should be handled following MSDS guidelines. Dispose of each in the designated hazardous waste immediately after use.

Tissue Culture (TC) Plates

- 6-well plates can be reused after rinsing with ddH₂O.
- Do not reuse plates without sufficiently rinsing out reagents.
- Do not reuse plates more than 5 times.

Pre-Experiment Preparation

Materials Included in Kit

Obtain now. Keep Blockers in an ice bucket. Allow Hydration and Staining Buffers to equilibrate to room temperature.

Contents	Kit	Storage
Hydration Buffer	CODEX® Staining Kit	4°C
Staining Buffer		
N Blocker		
J Blocker		
G Blocker		-20°C
S Blocker		

Obtain immediately before use in section 5.2 and place on ice.

Contents	Storage
CODEX® Antibodies	4°C
Custom-Conjugated Antibodies	4°C

Storage Buffer and Fixative Reagent will be used in Section 5.3.

Materials NOT Included in Kit

Solvents:

- Acetone. Dispense right before use (10 mL per sample).
- Cold methanol (stored at 4C). Dispense right before use (5 mL per sample).

Chemicals/Buffers:

- 16% paraformaldehyde (PFA) (we recommend: Electron Microscopy Sciences, PN# 15710)

Plastic consumables/tools:

- 6-well plate
- Bent-tip tweezers
- Humidity chamber
- Drierite absorbent beads
- 1.5 mL Eppendorf tubes
- 50 mL conical tube
- 50 mL glass beakers, 1 beaker per tissue for use with Acetone in step 5.1.3
- Ice bucket

Laboratory Equipment

- The use of a fume hood is highly recommended for steps involving the use of acetone and PFA.

Prepare Humidity Chamber

- Locate an empty pipette tip box with a lid and removable tray, or similar container.
- Wet a paper towel and place it at the bottom of the pipette box under the tray.
- Fill the pipette box with enough ddH₂O at the bottom to fully cover the paper towel (approximately 1-2 cm deep).
- Rinse and dry the pipette tip tray before placing it back in the box.
- Label different positions in the tray if working with multiple sample coverslips.
- Cover with the lid.

Prepare Drierite Absorbent Beads

- Locate an empty pipette tip box with a lid or similar container.
- Immediately prior to obtaining samples in step 5.1.2, fill the bottom with Drierite absorbent beads (approximately 1-2 cm deep).
- Cover with lid.

Determine Antibodies to Constitute the Antibody Cocktail in Fresh-frozen Samples

If antibodies have just been custom-conjugated as described in [Chapter 4](#), wait at least 2 days before using them for tissue staining or high nuclear background staining may be observed.

When preparing the Antibody Cocktail Solution, make sure to factor in the number of antibodies and volume per antibody. The total volume of antibodies will be subtracted to determine the Antibody Stock Solution used per sample coverslip.

- The total volume of the staining solution made for each coverslip is 200ul, and 190ul will be applied to each sample coverslip.
- If the dilution factor for an antibody is 1:200, the amount of antibody used per sample coverslip will be 1 μ L.

- For commercial CODEX® Antibodies, recommended dilution factors are reported in the antibody dilutions document.
- To determine the volume of CODEX® Blocking Buffer per sample, determine the Total Volume of Antibodies (depends on the total number of CODEX® Antibodies) and subtract it from Total Volume Per Tissue of the antibody cocktail (200 µL).
- If you are staining several samples at the same time, you should make a stock solution accordingly.

(Total Volume Per Tissue) – (Total Volume of Antibodies) = CODEX® Blocking Buffer Volume

# of antibodies	Volume of each antibody (µL)	Total volume of antibodies (µL)	Volume of CODEX Blocking Buffer (µL)
24	1	24	176
8	1	8	192
8	2	16	184

NOTE

For custom-conjugated antibodies, the volume of antibody solution used to stain any tissue needs to be determined by titration. Refer to [Appendix B: “Titration of CODEX® Antibodies”](#) for details and instructions.

Example 1:

If 24 CODEX® Antibodies are used to stain a single tissue, with 1 µL of each antibody to be added for a total of 24 µL of antibodies, 176 µL of CODEX® Blocking Buffer should be used.

$$200 \mu\text{L} - 24 \mu\text{L} = 176 \mu\text{L}$$

Example 2:

If 8 CODEX® Antibodies are used to stain a single tissue with 1 µL of each antibody to be added for a total of 8 µL of antibodies, 192 µL of CODEX® Blocking Buffer should be used.

$$200 \mu\text{L} - 8 \mu\text{L} = 192 \mu\text{L}$$

Example 3:

If 8 CODEX® Antibodies are used to stain a single tissue with 2 µL of each antibody to be added for a total of 16 µL of antibodies, 184 µL of CODEX® Blocking Buffer should be used.

$$200 \mu\text{L} - 16 \mu\text{L} = 184 \mu\text{L}$$

5.1.1 Plate configuration

Plate Configuration for Fresh-Frozen Samples

During the following steps, sample coverslip(s) will be incubated in various CODEX® reagents in 6-well plates and the humidity chamber. For efficient tissue staining, prepare and label 6-well plates ahead of time. Example configurations for CODEX® reagents in 6-well plates are listed below for 2 sample coverslips. More configurations can be found in Appendix A.

- Fill designated wells with 5 mL of Hydration Buffer and Staining Buffer.
- Wait until step 5.1.5 to prepare and dispense 5 mL of Pre-Staining Fixing Solution.

Plate Configuration 5.1 for two samples

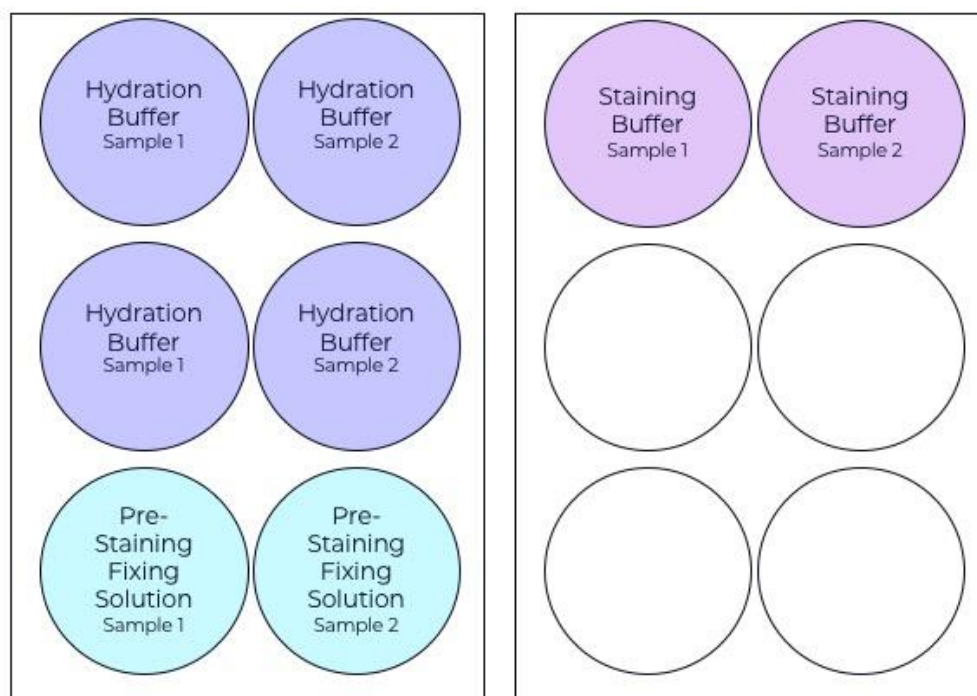

NOTE

Configuration 5.1.1 is for two samples. See [Appendix A: Plate Configurations](#) for more samples.

5.1.2 Tissue Retrieval

CRITICAL

The orientation of the tissue must be identified and tracked throughout the experiment.

- Prepare 10 mL of acetone in a 50 mL beaker for each sample coverslip. For example, for 8 sample coverslips, label and prepare 8 beakers with 10 mL acetone in each beaker.
- With a prepared box of 1-2 cm Drierite beads in hand, obtain sample coverslips from -80°C freezer.
- Determine which side of the coverslip(s) the tissue is located by gently scraping the corner of OCT layer.
- Place the coverslips in the box directly on top of the Drierite beads with the tissue facing up. Close the lid and wait for 2 minutes.

5.1.3 Acetone Incubation

- Remove the sample coverslip(s) from the Drierite beads, and place in the corresponding beaker containing acetone with the tissue side facing up.
- Incubate for 10 min.

INCUBATE

10 min incubation

5.1.4 Tissue Drying

- Remove the sample coverslip(s) from the acetone.
- Place the sample coverslip(s) on the humidity chamber tray with tissue facing up.
- Let the sample coverslip(s) sit in the chamber for 2 min.

NOTE Immediately dispose of acetone in the proper waste container.

5.1.5 Tissue Hydration

- Immerse each sample coverslip into the first well of Hydration Buffer 2-3 times to ensure removal of acetone from the top and bottom of the coverslip.
- Incubate for 2 min.
- Place each sample coverslip(s) into a second well containing 5 mL of Hydration Buffer.
- Incubate for another 2 mins for a total of 2 washes.
- Prepare the Pre-Staining Fixing Solution as described in step 5.1.6 during incubation.

5.1.6 Fix Tissue

- Prepare the Pre-Staining Fixing Solution in a conical tube.

Pre-Staining Fixing Solution	2 Samples	4 Samples	6 Samples	8 Samples	10 Samples
16% PFA [mL]	1	2	3	4	5
Hydration Buffer [mL]	9	18	27	36	45
Total Volume [mL]	10	20	30	40	50

NOTE The Pre-Staining Fixing Solution is 1 part 16% PFA solution in 9 parts of Hydration Buffer at 1:9 (v/v) for a final concentration of 1.6% PFA. Stock PFA must be 16%.

- Add 5 mL of Pre-Staining Fixing Solution to one TC well per sample.
- Add the sample coverslip(s) to the well(s) containing Pre-Staining Fixing Solution.
- Incubate for 10 min at RT.

INCUBATE 10 min incubation

5.1.7 Wash the tissue

- Remove the sample coverslip(s) from the Pre-Staining Fixing Solution and place them in the well(s) containing Hydration Buffer used from the tissue hydration steps.
- Lift and immerse the sample coverslip 2-3 times to make sure that the Pre-staining Fixing Solution is completely removed from both the top and the bottom of the coverslips.
- Quickly move sample coverslip(s) to the second well containing Hydration Buffer used in the tissue hydration steps.

5.1.8 Equilibrate Tissue in Staining Buffer

- Move sample coverslip(s) to well(s) containing Staining Buffer.
- Equilibrate sample coverslip(s) for 20-30 mins.
- Prepare Antibody Cocktail (Section 5.2) during equilibration.

INCUBATE 20-30 min incubation

NOTE Sample coverslips can stay in the Staining Buffer for a maximum time of 30 min prior to antibody staining.

5.2 Fresh-Frozen Tissue Staining

5.2.1 Understanding Antibody Dilution

Each CODEX® Antibody is aliquoted with a specific dilution factor to offer the best staining performance in control tissues. In some cases, antibodies may have to be re-titrated to optimize for specific tissues of interest. We recommend starting with the dilution factor indicated on the antibody dilution document. Consider the dilution factors indicated for the species (human or mouse) and tissue type (fresh-frozen or FFPE) being tested. The total volume of the staining solution per tissue sample is the sum of the volume of each antibody and the CODEX® Blocking Buffer, equaling 200 μ L.

You can refer to the following examples to verify how to achieve the correct dilution factor:

Dilution Factor:	1:200	1:500
Antibody Volume per sample coverslip (μ L):	1.0	0.4*
Total Volume of Antibody Cocktail per Sample Coverslip (μ L):	200.0	200.0

If the dilution factor of the antibody of interest is 1:200, 1 μ L of antibody is required in the total volume of 200 μ L of antibody cocktail.

If the dilution factor of the antibody of interest is 1:500, 0.4 μ L of antibody is required in the total volume of 200 μ L of antibody cocktail.

* We do not recommend pipetting less than 1 μ L. If the volume pipetted will be less than 1 μ L, we recommend making a stock solution first.

5.2.2 Preparation of the Antibody Cocktail Solution

- Remove selected antibodies from 4°C and keep them on ice until use. Spin down the tubes to collect any liquid from caps.
- Prepare a stock solution of CODEX® Blocking Buffer to be used for the Antibody Cocktail(s).
- Label one tube for each unique Antibody Cocktail Solution.

CODEX® Blocking Buffer Components

CODEX® Reagent	2 Samples	4 Samples	6 Samples	8 Samples	10 Samples
Staining Buffer [μ L]	362	724	1086.0	1448	1810
N Blocker [μ L]	9.5	19	28.5	38	47.5
G Blocker [μ L]	9.5	19	28.5	38	47.5
J Blocker [μ L]	9.5	19	28.5	38	47.5
S Blocker [μ L]	9.5	19	28.5	38	47.5

Total [μL]	400	800	1200	1600	2000
-------------------------	-----	-----	------	------	------

NOTE

Prepare CODEX® Blocking Buffer just before staining -- no earlier than one hour before. Keep on ice until ready to use.

- d. Add CODEX® Blocking Buffer to each of the tubes designated for Antibody Cocktail Solution(s). The volume of CODEX® Blocking Buffer to be prepared for each sample coverslip can vary depending on the number and volume of antibodies used. The final volume of the Antibody Cocktail Staining Solution is 200 μL per tissue. Refer to the antibody datasheet for the recommended dilution factor.

CRITICAL

The volume of CODEX® Blocking Buffer should be greater than 60% of the total antibody cocktail solution. Otherwise, blocking may not be sufficient.

- e. Add the appropriate volume of each CODEX® Antibody to the Antibody Cocktail Solution.
- f. Pipette to mix, or vortex gently.
- g. Briefly spin down the tube(s).

5.2.3 Tissue Staining

CRITICAL

Each sample coverslip should be removed from its well containing Staining Buffer and stained one at a time to avoid drying of the tissue.

- a. Draw up 190ul of the Antibody Cocktail into a pipette. Set aside.
- b. Remove sample coverslip from the well containing Staining Buffer and place it on the tray of the humidity chamber.
- c. Quickly dispense the 190 μL of the Antibody Cocktail to the top corner of the sample coverslip. Ensure that the liquid covers the entire tissue. Be careful not to pipette the solution directly on the tissue, and minimize bubbles.
- d. Repeat steps a and b for each sample.
- e. Place the lid on the humidity chamber.
- f. Incubate for 3 hours at RT
- g. After 3 hours, proceed immediately to section 5.3. It may be helpful to prepare the initial solutions from section 5.3. before the end of this 3-hour Incubation.

INCUBATE

3 hour incubation

NOTE

If performing a manual validation experiment for antibody validation ([Chapter 6](#)), a 2 hour incubation is sufficient.

CRITICAL

The humidity chamber must be placed on a stable surface free of vibrations. If anything disturbs the surface tension of the staining droplet on the coverslip, the tissue may dry out.

5.3 Fresh-Frozen Tissue Post-Staining

The following steps are performed to remove unbound antibodies and fix the bound antibodies to tissues.

CRITICAL

It is critical to prepare all reagents and consumables ahead of time to prevent degradation of the sample(s).

Pre-Experiment Preparation

Materials Included in Kit

Obtain now:

Item	Kit	Storage Location
Staining Buffer	CODEX® Staining Kit (P/N #7000008)	4°C
Storage Buffer		

Thaw immediately before use in section 5.3.6

Item	Kit	Storage Location
Fixative Reagent 1 tube for every 5 tissues (Single-Use)	CODEX® Staining Kit (P/N #7000008)	-20°C

Materials NOT Included in Kit

Solvents:

- Refrigerated Methanol, 5 mL per sample. Keep at 4°C until use in step 5.3.4.

Chemicals/Buffers:

- 16% paraformaldehyde (PFA, we recommend 16% PFA from Electron Microscopy Sciences, PN# 15710)
- 1X PBS

Plastic consumables/tools:

- 6-well plates
- Bent-tip tweezers
- 1.5 mL Eppendorf tubes
- 50 mL conical tube

Prepare Ice Bucket

Prepare enough buckets of ice to hold all the TC well plates needed for the methanol plate configuration below. Each TC well plate can hold up to 6 samples.

Plate Configuration for Fresh-Frozen Samples

In this section, the sample coverslip(s) will be transferred from the solvents to CODEX® buffers in 6-well plates. Subsequently, they will be transferred to the humidity chamber and finally to a 6-well plate containing Storage Buffer for storage at 4°C. Prepare and label 6-well plates ahead of time.

- For each sample, fill 2 wells with 5 mL of Staining Buffer. For each sample, fill 3 wells with 5 mL of 1x PBS. These wells will be used 3 times in steps 5.3.3, 5.3.5 and 5.3.7.
- Wells designated for Post-Staining Fixing Solution, Methanol and Storage Buffer need to be filled with 5 mL of the corresponding solution immediately before use.
- The 6-well plate containing Storage Buffer will be used for tissue storage and should be labeled accordingly with the sample ID.

Plate Configuration 5.3.

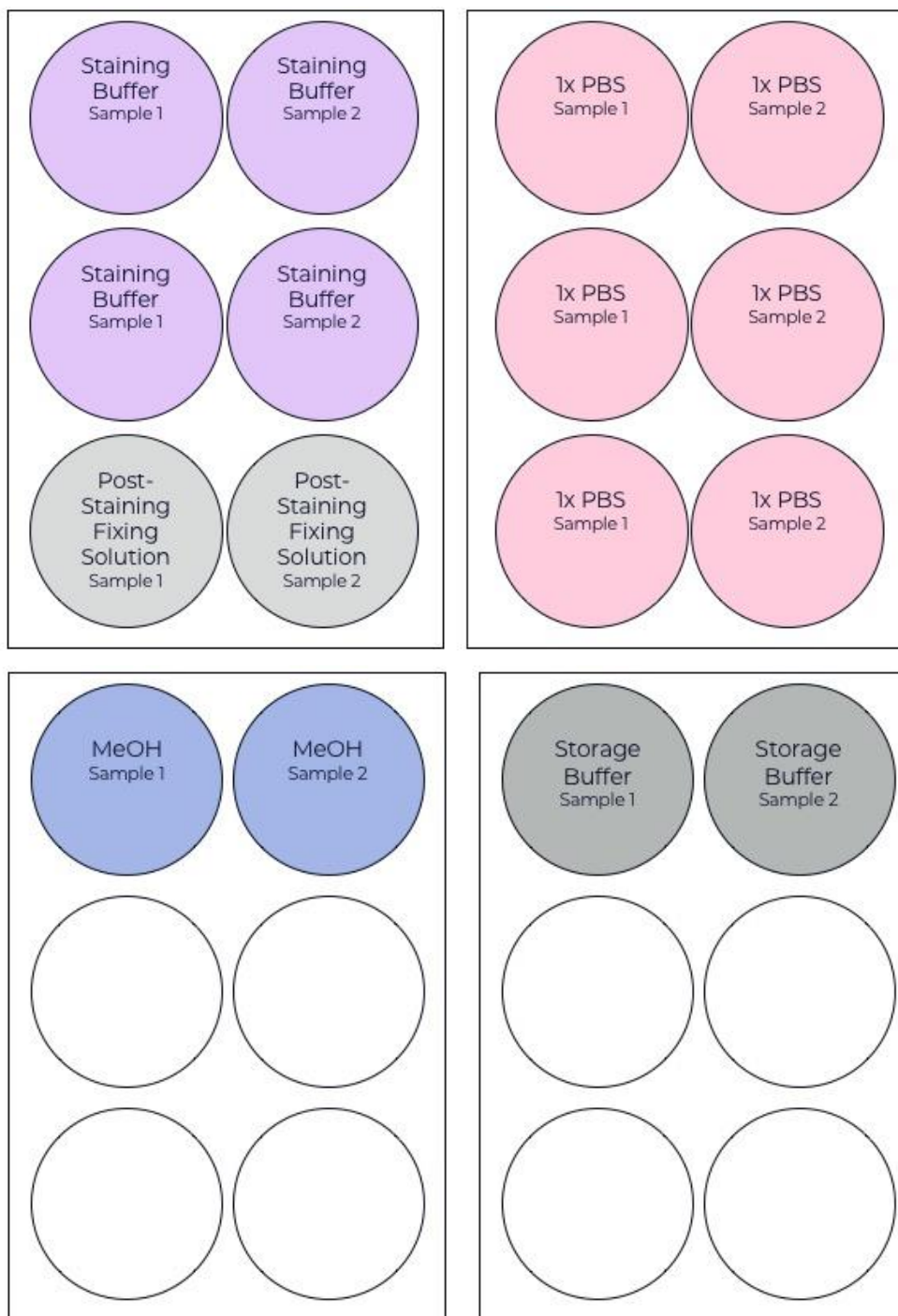

NOTE

The configuration above is for 2 samples. See [Appendix A Plate Configurations](#) when working with more samples.

5.3.1 Wash Tissue

- a. Following the 3 hour antibody incubation, place sample coverslip(s) in the first well(s) containing Staining Buffer according to the selected plate configuration. Lift and immerse sample coverslip(s) 2 to 3 times to ensure the removal of the Antibody Cocktail from both sides of the coverslip(s).

- b. Incubate for 2 min.
- c. Place sample coverslip(s) in the second well(s) containing Staining Buffer. Incubate for another 2 mins for a total of 2 washes.

5.3.2 Fix Tissue

- a. Prepare the Post-Staining Fixing Solution

Post-Staining Fixing Solution	2 Samples	4 Samples	6 Samples	8 Samples	10 Samples
16% PFA [mL]	1	2	3	4	5
Storage Buffer [mL]	9	18	27	36	45
Total Volume [mL]	10	20	30	40	50

NOTE

The Post-Staining Fixing Solution is 1 part 16% PFA solution in 9 parts Storage Buffer at a 1:9 (v/v).

- b. For each sample add 5 mL of Post-Staining Fixing Solution to the designated TC well.
- c. Place the sample coverslip(s) in the well(s) containing Post-Staining Fixing Solution.
- d. Incubate for 10 min at RT.

INCUBATE

10 min incubation at RT

NOTE

During the 10 min incubation, prepare the methanol and ice-cold 6-well plate for step 5.3.4

5.3.3 Wash Tissue

- a. Prepare 3 wells of 1x PBS per sample coverslip.
- b. Remove sample coverslip(s) from the well containing Post-Staining Fixing Solution.
- c. Place sample coverslip(s) in the first well(s) containing 1x PBS. Lift and immerse the sample coverslip 2-3 times to ensure the Fixing Solution is removed from the top and bottom of the coverslip.
- d. Immediately move the sample coverslip(s) to the second well containing 1x PBS. Lift and immerse the sample coverslip 2-3 times.
- e. Immediately move the sample coverslip(s) to the third well containing 1x PBS for a total of 3 washes. Lift and immerse the sample coverslip 2-3 times.

5.3.4 Ice-cold Methanol Incubation

- a. Place a new 6-well plate on ice.
- b. Retrieve methanol from the refrigerator (4°C) and pipette methanol up and down 3 times to equilibrate the serological pipette tip to the cold temperature of methanol.
- c. Add 5 mL of cold (~4°C) methanol to one well per sample keeping the 6-well plate on ice.
- d. Remove the sample coverslip(s) from the well(s) containing 1x PBS and place them in the well(s) containing ice-cold methanol.
- e. Incubate on ice for 5 mins.

INCUBATE

5 min incubation on ice.

5.3.5 Wash Tissue

- a. Place the 6-well plate containing the previously used 1x PBS next to the ice bucket and the methanol tray containing the sample coverslip(s).

CRITICAL

Methanol dries tissue faster than other buffers. Move quickly to prevent sample degradation.

- b. Quickly transfer the sample coverslip(s) from methanol to the first corresponding 1x PBS well(s).
- c. Ensure the coverslip is fully immersed in PBS as methanol drying may cause the coverslip to float. Lift and immerse the sample coverslip 2-3 times to ensure methanol is removed from the bottom of the coverslip as well as the top.
- d. Transfer the sample coverslip(s) to the second 1x PBS well. Lift and immerse the sample coverslip 2-3 times.
- e. Transfer the sample coverslip(s) to the third 1x PBS well for a total of 3 washes. Lift and immerse the sample coverslip 2-3 times.

5.3.6 Fix Tissue

- a. Rinse and dry the humidity chamber's tray if this has not already been done.
- b. Add 1 mL of 1x PBS to an Eppendorf tube for every 5 samples that are being prepared.
- c. Retrieve one aliquot of CODEX® Fixative Reagent tube from storage in -20°C freezer (one tube for every 5 samples). Each tube should contain 20 uL of reagent. Cut each tube selected for use from the tube strip. Do not thaw the entire strip.

NOTE

Do not remove Fixative Reagent ahead of time. Let it melt quickly between gloved fingers. Each tube is for single use; do not re-freeze.

- d. Briefly spin down the Fixative Reagent to collect any liquid from the cap.
- e. Prepare the Final Fixative Solution by diluting the 20 µL of the CODEX® Fixative Reagent in 1 mL of 1x PBS.

Final Fixative Solution	1-5 Samples	6-10 Samples
1x PBS	1000 µL	2000 µL
Fixative Reagent	20 µL	40 µL

- f. Mix thoroughly or vortex the solution.
- g. Draw up 200 µL of the Final Fixative Solution into a pipette. Set aside.
- h. Remove the sample coverslip(s) from the well(s) and place it (them) on the tray of the humidity chamber.
- i. Add 200 µL of Final Fixative Solution to the top corner of the sample coverslip(s). Cover the entire section with reagent and remove all bubbles on the tissue. Do not pipette the solution directly onto the tissue.
- j. Repeat steps g-i for all coverslips.
- k. Place lid on Humidity Chamber and incubate for 20 min.

INCUBATE

20 min incubation

5.3.7 Wash Tissue

- Remove the sample coverslip(s) from the humidity chamber and place in the first well containing 1x PBS. Lift and immerse the sample coverslip 2-3 times to ensure Fixative Solution is removed.
- Move the sample coverslip(s) to the second well containing 1x PBS. Lift and immerse the sample coverslip 2-3 times.
- Move the sample coverslip(s) to the third well containing 1x PBS for a total of 3 washes. Lift and immerse the sample coverslip 2-3 times.

5.3.8 Store Tissue

- Label a new TC 6-well plate and pipette 5 mL of Storage Buffer into one well per sample coverslip.
- Place the sample coverslip(s) in corresponding well(s) with the tissue facing up.
- Seal the TC plate(s) around the edges with parafilm (optional).

STOPPING POINT

Tissues can be:

Used directly to run a CODEX® Experiment

Used directly for the validation of antibody conjugation (Chapter 6)

For best results, store at 4°C for up to 5 days.

5.4 FFPE Tissue Pre-Staining

This section describes the FFPE tissue preparation for staining with CODEX® Antibodies. The procedure described here includes standard hydration and antigen retrieval processes. If antibodies have been custom-conjugated as described in [Chapter 4](#), wait at least 2 days before using them for tissue staining. Otherwise high levels of nuclear background may be observed.

Guidelines

Terminology

In the protocol, the term “sample coverslip(s)” refers to tissue sections adhered to poly-L-lysine-coated coverslips.

Sample Coverslip Handling

- It is imperative to avoid tissue drying by minimizing tissue exposure to air. Tissue drying is detrimental to staining quality.
- To avoid damaging the tissue, avoid dispensing liquid directly onto the tissue. Always pipette solutions on to the corner of the coverslips and allow the liquid to flow over the tissue.
- Coverslips should be handled using the recommended bent-tip tweezers. Take care when handling coverslips as they are fragile. As such, it is good practice to stain more than one sample coverslip with the same antibody panel as a backup.

Humidity Chamber Use

- During the 3 hour antibody incubation step, the sample coverslip is placed inside of a humidity chamber and covered with the antibody cocktail solution. The humidity chamber should be placed on a stable surface with minimal shaking or vibration. If the surface tension of the antibody cocktail solution covering the sample coverslip is disrupted, the tissue may dry out.
- When transferring samples between tissue culture plates and the humidity chamber, you can gently remove any excess liquid on the coverslip by dabbing the edge gently with a paper towel or Kimwipe.
- In some steps, liquids are dispensed onto sample coverslip(s) inside the humidity chamber. Always rinse the humidity chamber tray between uses to minimize cross-contamination.

Duration:

- Incubation times have been optimized for fixing and staining the tissue, ensuring the tissue does not dry out. Do not exceed or shorten these recommended incubation timings.

Safety

- Acetone, PFA, and methanol are toxic chemicals and should be handled follow MSDS guidelines.; Dispose of each in the designated hazardous waste immediately after use.

Tissue Culture Plates

- 6-well plates can be reused after rinsing with ddH₂O.
- Do not reuse plates without washing.
- Do not reuse plates more than 5 times.

Pre-Experiment Preparation

Materials Included in Kit

Obtain now. Keep blockers in an ice bucket. Allow Hydration and Staining Buffers to equilibrate to room temperature.

Contents	Kit	Storage
Hydration Buffer	CODEX® Staining Kit (PN # 7000008)	4°C
Staining Buffer		
N Blocker		
J Blocker		
G Blocker		-20°C
S Blocker		

Obtain immediately before use in section 5.5 and place on ice.

Contents	Storage
CODEX® Antibodies	4°C
Custom-Conjugated Antibodies	4°C

Storage Buffer and Fixative Reagent will be used in Section 5.6.

Materials NOT Included in Kit

Solvents:

- Ethanol or Reagent Alcohol (Sigma Aldrich, PN# 79317-16GA-PB)
- 1x HistoChoice Clearing Agent(VWR, PN# H103-4L)

Chemicals/buffers:

- 10x Citrate solution, pH 6.0 (Sigma Aldrich, PN# C9999-1000ML) or Tris-EDTA, pH9.0 (Sigma-Aldrich Ref: SRE0063)
- 16% paraformaldehyde (PFA) (we recommend: Electron Microscopy Sciences, PN# 15710)

Consumables/tools:

- 6-well plates

- Bent-tip tweezers
- 1.5 mL Eppendorf tubes
- 50 mL conical tube
- Coverslip staining rack (we recommend PN# 72240, Electron Microscopy Science)
- 50 mL Pyrex beaker(s), one per coverslip staining rack
- 10 solvent-resistant containers with lids (we recommend EZ-Quick Slide Staining Set, PN# IW-2510, IHC World)
- Aluminum foil

Required Laboratory Equipment

- Heating plate
- Pressure cooker
- Fume hood

Prepare Humidity Chamber

- Locate an empty pipette tip box with a lid or similar container.
- Wet a paper towel and place it at the bottom of the pipette box.
- Fill the pipette box with enough ddH₂O at the bottom to fully cover the paper towel (approximately 1-2 cm deep).
- Rinse and dry the pipette tip tray before placing it back in the box.
- Label different positions in the tray if working with multiple sample coverslips.
- Cover with the lid.

Determine Antibodies to Constitute the Antibody Cocktail for FFPE Samples

If antibodies have just been custom-conjugated as described in [Chapter 4](#), wait at least 2 days before using them for tissue staining or high nuclear background staining may be observed.

When preparing the Antibody Cocktail Solution, make sure to factor in the number of antibodies and volume per antibody. The total volume of antibodies will be subtracted to determine the Antibody Stock Solution used per sample coverslip.

- The volume of the staining solution applied to one sample coverslip is 200 µL.
- If the recommended dilution factor for an antibody is 1:200, the amount of antibody used per sample coverslip is 1 µL.
- For commercial CODEX® Antibodies, recommended dilution factors are reported in the antibody dilution document.
- To determine the volume of CODEX® Blocking Buffer per sample, determine the Total Antibody Volume (depends on the total number of CODEX® Antibodies) and subtract it from Total Volume Per Tissue of the antibody cocktail (200 µL).
- If you are staining several samples at the same time, you should make a stock solution accordingly.

(Total Volume Per Tissue) – (Total Antibody Volume) = CODEX® Blocking Buffer Volume

# of antibodies	Volume of each antibody (µL)	Total volume of antibodies (µL)	Volume of CODEX Blocking Buffer (µL)
24	1	24	176
8	1	8	192
8	2	16	184

NOTE

For custom-conjugated antibodies, the volume of antibody solution used to stain any tissue needs to be determined by titration. Refer to [Appendix B: "Titration of CODEX® Antibodies"](#) for details and instructions.

Example 1:

If 24 CODEX® Antibodies are used to stain a single tissue, with 1 µL of each antibody to be added for a total of 24 µL, 176 µL volume of CODEX® Blocking Buffer should be used.

$$200 \mu\text{L} - 24 \mu\text{L} = 176 \mu\text{L}$$

Example 2:

If 8 CODEX® Antibodies are used to stain a single tissue with 1 µL of each antibody to be added for a total of 8 µL, 192 µL volume of CODEX® Blocking Buffer should be used.

$$200 \mu\text{L} - 8 \mu\text{L} = 192 \mu\text{L}$$

Example 3:

If 8 CODEX® Antibodies are used to stain a single tissue with 2 µL of each antibody to be added for a total of 16 µL, 184 µL volume of CODEX® Blocking Buffer should be used.

$$200 \mu\text{L} - 16\mu\text{L} = 184 \mu\text{L}$$

CRITICAL

Blocking Buffer should constitute at least 60% of the total volume of the Antibody Cocktail. Otherwise, blocking may not be sufficient.

Prepare Solvents for Tissue Deparaffinization and Hydration

- a. Organic solvents can be used for approximately 25 tissue coverslips or up to two weeks before they should be changed. Monitor volumes as alcohol will evaporate over time. Dispose of used solvents in dedicated waste containers following institutional protocols.

CRITICAL

It is highly recommended to perform this procedure under a fume hood as organic solvents are highly volatile.

- b. Depending on the container used for the incubation of tissues in the solvent series, determine the volume required to make sure that the coverslip staining rack is fully submerged in the liquid.
- c. Prepare containers containing the required volume of the following solvents:
 1. HistoChoice Clearing Agent
 2. HistoChoice Clearing Agent
 3. 100% Ethanol/Reagent Alcohol
 4. 100% Ethanol/Reagent Alcohol
 5. 90% Ethanol/Reagent Alcohol
 6. 70% Ethanol/Reagent Alcohol
 7. 50% Ethanol/Reagent Alcohol
 8. 30% Ethanol/Reagent Alcohol
 9. ddH₂O
 10. ddH₂O

Plate Configuration for FFPE Samples

In section 5.4.4, to be performed after standard procedures for tissue hydration and antigen retrieval, sample coverslip(s) are transferred to CODEX® buffers in 6-well plates and then to the humidity chamber. For efficient

tissue staining, prepare TC well plates ahead of time. Listed below are configurations for CODEX® buffers in TC well plates for 2 sample coverslips. Fill each designated well with 5 mL of Hydration Buffer and Staining Buffer

Plate configuration 5.4 for two samples

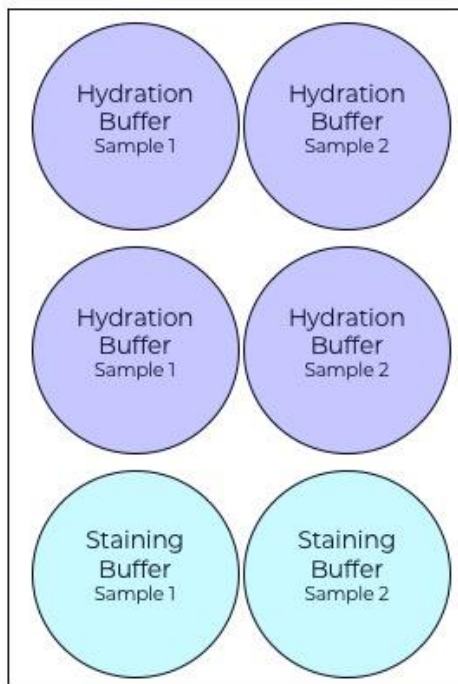

NOTE

The configuration above is for 2 samples. See [Appendix A Plate Configurations](#) for more samples.

Tissue Pre-Treatment and Antibody Staining

FFPE tissues must undergo deparaffinization, rehydration, and antigen retrieval before antibody labeling. In this protocol, Akoya-recommended procedures for FFPE tissue pre-treatment are provided.

5.4.1 Tissue Pre-treatment

- Heat sample coverslip(s) on hot plate at 55°C with tissue facing up for 20-25 minutes to bake the tissue.

INCUBATE

20-25 min incubation.

- Place the sample coverslip(s) on the coverslip staining rack.
- Wait 5 mins to allow the tissue(s) to cool down.

5.4.2 Tissue Deparaffinization and Hydration

Start the deparaffinization process by placing the sample coverslip(s) in the following solvent series. For best result, use a staining rack that can hold up to five coverslips. Ensure that the sample coverslip(s) are completely submerged in the solvents. Move the rack(s) gently to make sure the liquid in the space between coverslips is exchanged. Seal the container with a lid during incubation to reduce solvent evaporation.

NOTE

It is highly recommended that you perform this procedure under a fume hood. Organic solvents are toxic and highly volatile.

- a. Immerse the staining rack in the container containing the following reagents for 5min each:
 1. HistoChoice Clearing Agent
 2. HistoChoice Clearing Agent
 3. 100% Ethanol/Reagent Alcohol
 4. 100% Ethanol/Reagent Alcohol
 5. 90% Ethanol/Reagent Alcohol
 6. 70% Ethanol/Reagent Alcohol
 7. 50% Ethanol/Reagent Alcohol
 8. 30% Ethanol/Reagent Alcohol
 9. ddH₂O
 10. ddH₂O

5.4.3 Antigen Retrieval

- a. In a Pyrex beaker, prepare a 1x citrate buffer (0.01 M). If using a 10x concentrate of Citrate Buffer, dilute 10x (0.1 M) Citrate buffer in ddH₂O. The volume of the final 1x Citrate solution will depend on the number and size of the container(s) used to immerse the tissue rack(s). Usually, 40 mL is enough solution for a 50 mL beaker.

Alternative Buffer (Optional)

Some clones may require antigen retrieval in Tris-EDTA Buffer instead of Citrate. In this case, Tris-EDTA Buffer Solution, pH = 9.0 from Sigma-Aldrich (Ref: SRE0063) is recommended. The recommended Tris-EDTA antigen retrieval conditions include a 20-minute incubation at high pressure in a pressure cooker.

Note: Most commercial CODEX® Antibodies work with both Citrate and EDTA retrieval methods. If an antibody requires one or the other retrieval methods specifically, it is critical to ensure that the rest of the panel is compatible with the antigen retrieval method selected.

- b. Immerse the staining rack(s) in the beaker(s) containing the 1x Citrate buffer and wrap it with aluminum foil to ensure the best sealing possible.

NOTE

Wrapping with aluminum foil will prevent the vapor from the pressure cooker from entering the beaker

- c. Fill the pressure cooker with water approximately halfway up the height of the beaker. Place the covered beaker in the pressure cooker and operate following the pressure cooker instructions.
- d. Set the pressure cooker to the high-pressure protocol and let the tissue incubate for 20 min.

INCUBATE

20 min incubation in the Pressure Cooker

- e. After the incubation in the Pressure cooker, release the pressure and carefully remove the rack from the pressure cooker and equilibrate to RT for approximately 10 min.

INCUBATE 10 min incubation at RT

- f. When the citrate solution is no longer cloudy, take the staining rack from the beaker and quickly immerse it in a beaker/container filled with ddH₂O and leave it to incubate for 2 minutes at RT.
- g. Place the staining rack in a second beaker/container filled with ddH₂O and incubate for 2 minutes.

5.4.4 Wash Tissue

- a. Remove the sample coverslip(s) from the water container and place them in the well(s) containing Hydration Buffer. Immerse the sample coverslip 2-3 times.
- b. Let the sample coverslip(s) incubate for 2 min.
- c. Move sample coverslip(s) to the second well containing Hydration Buffer.
- d. Incubate for an additional two minutes for a total of two washes.

5.4.5 Equilibrate Tissue in Staining Buffer

- a. Move sample coverslip(s) to well(s) containing Staining Buffer.
- b. Equilibrate sample coverslip(s) for 20-30 min.
- c. Prepare Antibody Cocktail (for Section 5.5) during equilibration.

INCUBATE 20-30 min incubation

NOTE Tissues can stay in this solution for a maximum time of 30 mins before antibody staining

5.5 FFPE Tissue Staining

5.5.1 Understanding Antibody Dilution

Each CODEX® Antibody is optimized to a specific dilution factor to offer the best staining performance in control tissues. However, some antibodies may need to be re-titrated to optimize the conditions specific to the tissue of interest. We recommend starting with the dilution factor indicated on the antibody dilution document. Dilution factors indicated for the species (human or mouse) and tissue type (fresh-frozen or FFPE) being tested should also be considered. The total volume of the staining solution per tissue sample is the sum of the volume of each antibody and the staining buffer, equaling 200 µL.

Refer to the following example to verify how to achieve the correct dilution factor:

Dilution Factor	1:200	1:500
Antibody volume per sample coverslip	1 µL	0.4 µL
Total volume of antibody cocktail per sample coverslip	200 µL	200 µL

If the dilution factor of the antibody of interest is 1:200, 1 µL of antibody is required in the total volume of 200 µL of antibody cocktail.

If the dilution factor of the antibody of interest is 1:500, 0.4 µL of antibody is required in the total volume of 200 µL of antibody cocktail.

We do not recommend pipetting less than 1 μL . If the volume pipetted will be less than 1 μL , we recommend making a stock solution first.

5.5.2 Preparation of the Antibody Cocktail Solution

- Remove selected antibodies from 4°C and keep them on ice until use. Spin down the tubes to collect any liquid from caps.
- Prepare a stock solution of CODEX® Blocking Buffer to be used for the Antibody Cocktail(s).
- Label one tube for each unique Antibody Cocktail Solution.

CODEX® Blocking Buffer Components

CODEX® Blocking Buffer	2 Samples	4 Samples	6 Samples	8 Samples	10 Samples
Staining Buffer [μL]	362	724	1086	1448	1810
N Blocker [μL]	9.5	19	28.5	38	47.5
G Blocker [μL]	9.5	19	28.5	38	47.5
J Blocker [μL]	9.5	19	28.5	38	47.5
S Blocker [μL]	9.5	19	28.5	38	47.5
Total [μL]	400	800	1200	1600	2000

NOTE

Prepare CODEX® Blocking Buffer just before staining -- no earlier than one hour before. Keep on ice until ready to use.

- Add CODEX® Blocking Buffer to each of the tubes designated for Antibody Cocktail Solution(s). The volume of CODEX® Blocking Buffer to be prepared for each sample coverslip can vary depending on the titer and corresponding volume of each antibody. The final volume of the Antibody Cocktail Staining Solution is a total of 200 μL per tissue. Refer to the antibody datasheet for the recommended dilution factor.

CRITICAL

The volume of CODEX® Blocking Buffer should be greater than 60% of the total antibody cocktail solution. Otherwise, sufficient blocking may not occur.

- Add the appropriate volume of each CODEX® Antibody to the Antibody Cocktail Solution.
- Pipette to mix, or vortex gently.
- Briefly spin down the tube(s).

5.5.3 Tissue Staining

CRITICAL

Each sample coverslip should be removed from its well containing Staining Buffer and stained one at a time to avoid drying of the tissue.

- Draw up 190 μL of the Antibody Cocktail into the pipette and set aside.
- Remove sample coverslip from the well containing Staining Buffer and place it on the tray of the humidity chamber.

- c. Quickly dispense 190 μ L of the Antibody Cocktail to the top corner of the sample coverslip. Ensure that the liquid covers the entire tissue. Be careful not to pipette the solution directly on the tissue, and minimize bubbles.
- d. Repeat steps a-c for each sample.
- e. Place the lid on the humidity chamber.
- f. Incubate for 3 hours at RT.
- g. After 3 hours, proceed immediately to section 5.6. It may be helpful to prepare the initial solutions from section 5.6. before the end of this 3 hour Incubation.

INCUBATE 3 hour incubation

NOTE If performing a manual validation experiment for antibody validation ([Chapter 6](#)), a 2 hour incubation is sufficient.

CRITICAL The humidity chamber must be placed on a stable surface free of vibrations. If anything disturbs the surface tension of the staining droplet on the coverslip, the tissue may dry out.

5.6 FFPE Tissue Post-Staining

The following steps are done to remove unbound antibodies and fix bound antibodies to tissues.

CRITICAL It is critical to prepare all reagents and consumables ahead of time to prevent degradation of the sample(s).

Pre-Experiment Preparation

Materials Included in Kit

Obtain now:

Item	Kit	Storage Location
Staining Buffer	CODEX® Staining Kit (PN #7000008)	4°C
Storage Buffer		

Thaw immediately before use in section 5.6.6

Item	Kit	Storage Location
Fixative Reagent 1 tube every 5 tissues (Single-Use)	CODEX® Staining Kit (PN #7000008)	-20°C

Materials NOT Included in Kit

Solvents:

- Refrigerated methanol, 5 mL per sample. Keep at 4°C until use in step 5.6.4.

Chemicals/Buffers:

- 16% paraformaldehyde (PFA, we recommend 16% PFA from Electron Microscopy Sciences, PN# 15710)
- 1xPBS

Plastic consumables/tools:

- 6-well plates
- Bent-tip tweezers
- 1.5 mL Eppendorf tubes
- 50 mL conical tube

Prepare Ice Bucket

Prepare enough buckets of ice to hold all the TC well plates needed for the methanol plate configuration below. Each TC well plate can hold up to 6 samples.

Plate Configuration for FFPE Samples

In this section, the sample coverslip(s) will be transferred from the solvents to CODEX® buffers in 6-well plates. They will then be transferred to the humidity chamber, and finally to a 6-well plate containing Storage Buffer for storage at 4°C. Prepare and label 6-well plates ahead of time.

- For each sample, fill 2 wells with 5 mL of Staining Buffer.
- For each sample, fill 3 wells with 5 mL of 1x PBS.
- Wells designated for Post-Staining Fixing Solution, methanol and Storage Buffer should be filled with 5 mL of the corresponding solution immediately before use.
- The 6-well plate containing Storage Buffer will be used for tissue storage and should be labeled accordingly with the sample ID.

Plate Configuration 5.6

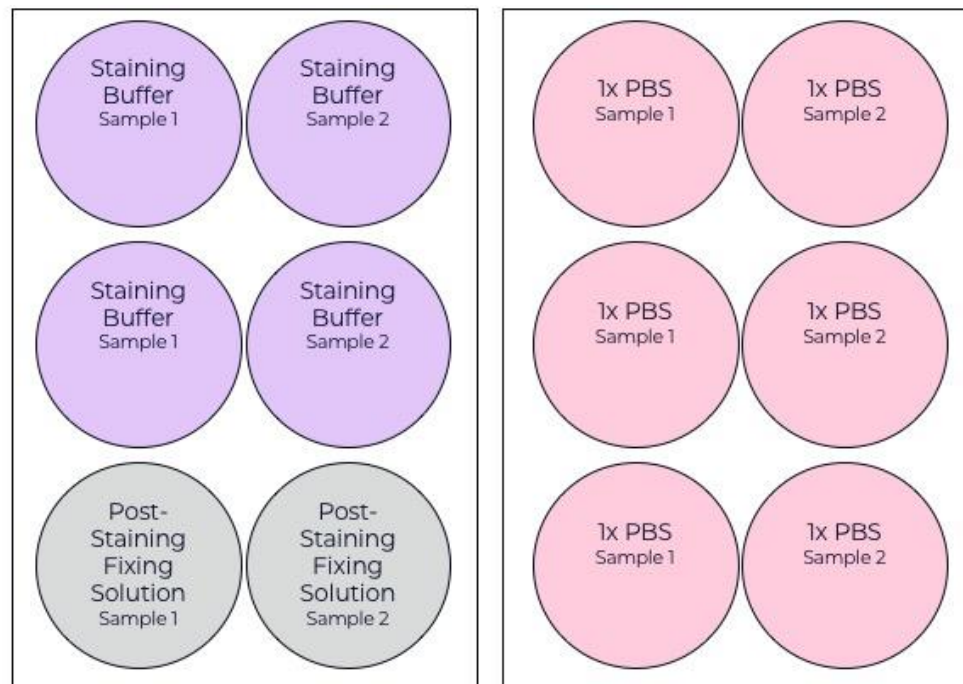

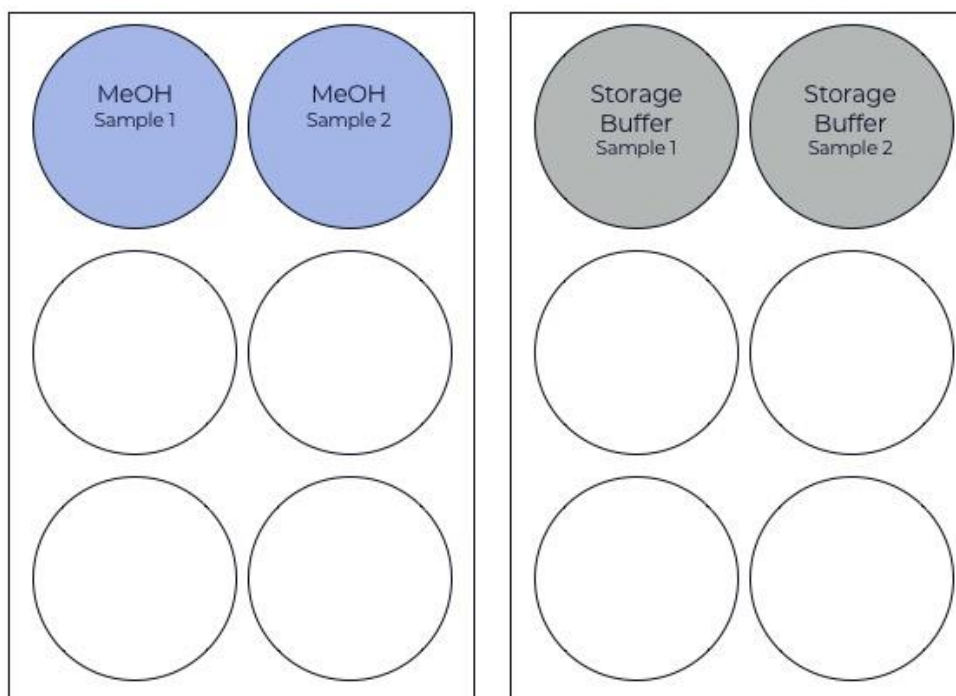
NOTE

The configuration above is for 2 samples. See [Appendix A Plate Configurations](#) when working with more samples.

5.6.1 Wash Tissue

- Following the 3 hour antibody incubation, place sample coverslip(s) in the first well(s) containing Staining Buffer according to the selected plate configuration. Lift and immerse sample coverslip(s) 2 to 3 times to ensure the removal of the Antibody Cocktail from both sides of the coverslip(s).
- Incubate for 2 min.
- Place sample coverslips in the second well(s) containing Staining Buffer.
- Incubate for another 2 mins for a total of 2 washes.

5.6.2 Fix Tissue

- Prepare the Post-Staining Fixing Solution

Post-Staining Fixing Solution	2 Samples	4 Samples	6 Samples	8 Samples	10 Samples
16% PFA [mL]	1	2	3	4	5
Storage Buffer [mL]	9	18	27	36	45
Total Volume [mL]	10	20	30	40	50

NOTE

The Post-Staining Fixing Solution is 1 part 16% PFA solution in 9 parts Storage Buffer at a 1:9(v/v).

- b. For each sample, add 5 mL of Post-Staining Fixing Solution to the designated TC well.
- c. Place the coverslip(s) in the well(s) containing Post-Staining Fixing Solution.
- d. Incubate at RT for 10 min.

INCUBATE 10 min incubation at RT

NOTE During the 10 min incubation, prepare the methanol and ice-cold 6-well plate for step 5.6.4.

5.6.3 Wash Tissues

- a. Prepare 3 wells of 1x PBS per sample coverslip.
- b. Remove sample coverslip(s) from the well containing Post-Staining Fixing Solution.
- c. Place sample coverslip(s) in the first well containing 1x PBS. Lift and immerse the sample coverslip 2-3 times to ensure the Fixing Solution is removed from the top and bottom of the coverslip.
- d. Immediately move the sample coverslip(s) to the second well containing 1x PBS. Lift and immerse the sample coverslip 2-3 times.
- e. Immediately move the sample coverslip(s) to the third well containing 1x PBS for a total of 3 washes. Lift and immerse the sample coverslip 2-3 times.

5.6.4 Ice-cold Methanol Incubation

- a. Place a new 6-well plate on ice.
- b. Retrieve methanol from the refrigerator (4°C) and pipette methanol up and down 3 times to equilibrate the serological pipette tip to the cold temperature of methanol.
- c. Add 5 mL of cold (~4°C) methanol to one well per sample keeping the 6-well plate on ice.
- d. Remove the sample coverslip(s) from the well(s) containing 1x PBS and place them in the well(s) containing ice-cold methanol.
- e. Incubate on ice for 5 mins.

INCUBATE 5 min incubation

5.6.5 Wash Tissue

- a. Place the 6-well plate containing the previously used 1x PBS next to the ice bucket and the methanol tray containing the sample coverslip(s).

CRITICAL Methanol dries tissue faster than other buffers. Move quickly to prevent sample degradation.

- b. Quickly transfer the sample coverslip(s) from methanol to the first corresponding 1x PBS well(s).
- c. Ensure the coverslip is fully immersed in PBS as methanol drying may cause the coverslip to float. Lift and immerse the sample coverslip 2-3 times to ensure methanol is removed from the bottom of the coverslip as well as the top.
- d. Transfer the sample coverslip(s) to the second 1x PBS well. Lift and immerse the sample coverslip 2-3 times.

- e. Transfer the sample coverslip(s) to the third 1x PBS well for a total of 3 washes. Lift and immerse the sample coverslip 2-3 times.

5.6.6 Fix Tissue

- a. Rinse and dry the humidity chamber's tray if this has not already been done.
- b. Add 1 mL of 1x PBS to an Eppendorf tube for every 5 samples that are being prepared.
- c. Retrieve one aliquot of CODEX® Fixative Reagent tube from storage in -20°C freezer (one tube for every 5 samples). Each tube should contain 20 μ L of reagent. Cut each tube selected for use from the tube strip. Do not thaw the entire strip.

NOTE

Do not remove Fixative Reagent ahead of time. Let it melt quickly between gloved fingers. Each tube is for single use; do not re-freeze.

- d. Quickly spin down the thawed Fixative Reagent to collect liquid from the cap.
- e. Prepare the Final Fixative Solution by diluting the 20 μ L of the CODEX® Fixative Reagent in 1 mL of 1x PBS.

Final Fixative Solution	1-5 Samples	6-10 Samples
1x PBS	1000 μ L	2000 μ L
Fixative Reagent	20 μ L	40 μ L

- f. Mix thoroughly or vortex the solution.
- g. Draw up 200 μ L of the Final Fixative Solution into the pipette and set aside.
- h. Remove one sample coverslip(s) from the well and place it on the tray of the humidity chamber.
- i. Add 200 μ L of Final Fixative Solution to the top corner of the sample coverslip(s). Ensure that the entire tissue is covered in fixative solution and remove any bubbles. To avoid damage to the tissue, do not to pipette the solution directly over tissue.
- j. Repeat steps g-i for all coverslips.
- k. Place the lid on the humidity chamber and incubate for 20 min.

INCUBATE 20 min incubation

5.6.7 Wash Tissue

- a. Remove the sample coverslip(s) from the humidity chamber and place in the first well containing previously used 1x PBS. Lift and immerse the sample coverslip 2-3 times.
- b. Move the sample coverslip(s) to the second well containing 1x PBS. Lift and immerse the sample coverslip 2-3 times.
- c. Move the sample coverslip(s) to the third well containing 1x PBS for a total of 3 washes. Lift and immerse the sample coverslip 2-3 times.

5.6.8 Store Tissue

- a. Label a new TC 6-well plate(s) and pipette 5 mL of Storage Buffer Into one well per sample coverslip.
- b. Place the sample coverslip(s) in the corresponding well(s) with the tissue facing up.
- c. Seal the TC plate(s) by wrapping the edges with parafilm (optional).

STOPPING POINT

Tissues can be:

Used directly to run a CODEX® Experiment

Used directly for the validation of antibody conjugation ([Chapter 6](#))

For best results, store at 4°C for up to 5 days.

Chapter 6. Manual Validation of Custom-Conjugated Antibodies via Tissue Staining

6.1 EXPERIMENTAL DESIGN	72
6.2 MANUAL ADDITION OF CODEX® REPORTERS AND COVERSLIP MOUNTING	74
6.3 VISUALIZATION AND ANALYSIS OF MANUAL VALIDATION IMAGES	80

This document offers guidelines on how to conduct the validation of custom-conjugated antibodies via manual tissue staining and mounting onto a microscope slide. We recommend that users also verify the success of the antibody conjugation to CODEX® Barcodes via gel electrophoresis, as illustrated in [Section 4.2](#). Additionally, please refer to [“Guidelines: Antibody Screening and Custom Conjugation – Tips and Guidelines”](#) on our Help page at akoyabio.com.

Validation of CODEX® Antibodies is to be considered complete only once the staining has been verified by performing both a manual validation experiment and a CODEX® multicycle run. This two-fold control allows the users to verify 1) that the antibody is functional post-conjugation, 2) that the binding efficiency is not influenced by the presence of the multiple antibodies in highly multiplexed experiments and 3) verify the staining during a CODEX® run.

Before starting validation experiments, consider titrating CODEX® custom-conjugated antibodies to determine optimal staining conditions and establish the workflow in advance. The titration of CODEX® Antibodies is described in [Appendix B](#) of the User Manual, and it can be performed before, after, or in manual validation experiments. If the titration is done afterward, and the optimal antibody concentration results are different than the concentration used for validation, validation experiments should be repeated at the new antibody concentration. It is best practice to perform a titration for every new batch of conjugated material.

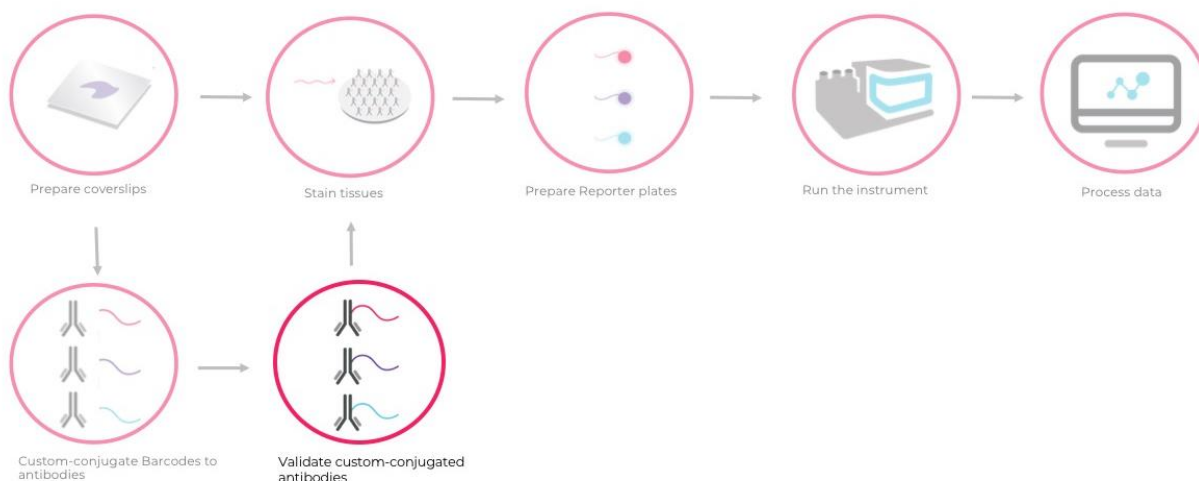

6.1 Experimental Design

6.1.1 Tissue Selection

Before starting the validation of custom-conjugated CODEX® Antibodies, we recommend identifying a positive tissue block for staining by performing standard immunohistochemistry or immunofluorescence. For rare markers, we also recommend identifying a negative tissue for staining –a tissue block that does NOT express the target antigen of interest (or expresses it at a very low level).

NOTE

Representative unstained tissue sections should be imaged in each fluorescent channel prior to staining with CODEX® Antibodies to exclude highly autofluorescent samples/regions. Follow the instructions reported in the “[Guidelines: Investigation of Autofluorescence – Best Practices](#)” at akoyabio.com to exclude autofluorescent samples/regions from use in antibody validation.

6.1.2 Designing Manual Validation Experiments

We recommend performing each manual validation experiment on three tissue sections from the same tissue block following the Staining Scheme for Antibody Validation (see table below). Tissues should be stained with up to 3 antibodies with distinct fluorescent dyes and manually mounted onto a slide for observation under a microscope.

This procedure assesses the specificity of a CODEX® conjugated antibody by comparing its staining with those of two control primary antibodies. The control antibodies can be standard fluorescent dye-tagged antibodies or previously validated CODEX® Antibodies.

Control antibodies have the function of 1) co-stain (positive control) and 2) counter-stain (negative control), and must be combined with a reporter that emits in different fluorescent channels with respect to the CODEX®-tagged antibody, and each other.

As mentioned previously, the validation is best performed using three tissue sections from the same block and staining each one according to the scheme reported in the tables below. Some examples of appropriate co- and counterstains for commonly used antibodies are also reported in the following table.

Staining Scheme for Antibody Validation using 3 tissue sections (preferably from the same block):

Channel	Tissue 1	Tissue 2	Tissue 3
	CODEX® stain only	CODEX® stain with co-stain (positive control)	CODEX® stain with counter-stain (negative control)
DAPI Channel	Nuclear stain	Nuclear stain	Nuclear stain
2 nd Fluorescent Channel	CODEX® conjugated antibody for validation	CODEX® conjugated antibody for validation	CODEX® conjugated antibody for validation
3 rd or 4 th Fluorescent Channel	None	Control antibody targeting a different antigen expressed by the same phenotype or cell population	Control antibody targeting an antigen expressed by a distinct phenotype or cell population.

Example of positive and negative controls for commonly used CODEX® Antibodies:

CODEX® Antibodies	Standard Fluorescence Antibodies	
	Positive Control	Negative Control
Anti-CD4	Anti-CD3	Anti-CD20
Anti-CD8	Anti-CD3	Anti-CD20
Anti-CD11c	Anti-CD14 or Anti-CD11b	Anti-E Cadherin

Once the validation scheme is designed, proceed to tissue staining following the protocols for fresh-frozen (Sections: 5.1 - 5.3) or FFPE tissues (Sections: 5.4 - 5.6) reported in [Chapter 5](#) of the User Manual.

If standard fluorescent dye-tagged antibodies are used for co- and counterstains, these should be added to the Antibody Cocktail Solution at the concentration indicated by the manufacturer.

The incubation times for Manual Antibody Validation (non-multicycle experiments), described in [Chapter 5](#) for fresh-frozen and FFPE tissues can be reduced to 2 hours.

Once section 5.3 (for fresh-frozen) or 5.6 (for FFPE) is complete, proceed to the Manual Addition of CODEX® Reporters and Coverslip Mounting in section 6.2.

6.1.3 Multicycle Experiments

In order to ensure that the staining is unaltered by the experimental conditions of a CODEX® run, it is critical to validate the custom-conjugated antibodies using a multicycle experiment. Here are the steps:

- a. Perform a standard CODEX® run using the optimal concentration of the CODEX® conjugated antibody under manual validation and the optimal exposure time based on validation experiments. Follow Chapters 5-7 of the user manual and the Microscope Quick Reference Cards for instructions. Please note that for a full CODEX® multicycle run, antibody concentrations and exposure times may need to be further optimized.
- b. Evaluate the quality of the staining and the Signal-to-Noise Ratio (SNR) by comparing with the results obtained in manual validation experiments.

6.2 Manual Addition of CODEX® Reporters and Coverslip Mounting

This section describes how to add reporters in validation experiments manually, and how to prepare tissues for up to 3-plex plus DAPI fluorescence imaging via coverslip mounting. This procedure is sometimes also done to establish the best antibody concentration for a specific tissue type (antibody titration); if this is the case, please refer to Appendix B for details.

Pre-Experiment Preparation

Materials Included in Kits

Item	Kit	Storage Location	Use at
10xCODEX® Buffer (PN # 7000001)	À la carte	RT	RT
Assay Reagent (PN # 7000002)		-20°C, and 4°C after the first thaw	Place on Ice until use
Nuclear Stain (PN # 7000003)			
Reporters	Corresponding to CODEX® Barcodes		

Materials NOT Included in Kit

Solvents:

- DMSO

Chemicals/Buffers:

- ddH₂O
- Nuclease-free water

Consumables/tools:

- 6-well TC plate
- Bent-tip tweezers
- Parafilm
- Lab tape
- Microscope slide
- Nail polish
- Aluminum foil to cover dyed tissue(s)
- Amber Eppendorf tubes
- Bucket of ice
- Fluoromount-G™ (optional)

6.2.1 Prepare Screening Buffer

- a. Prepare Screening Buffer in a glass beaker

Buffer Components	2 Samples	4 Samples	6 Samples	8 Samples	10 Samples	12 Samples
10x CODEX® Buffer [mL]	3.5	7	10.5	14	17.5	21
Nuclease-Free Water [mL]	24.5	49	73.5	101.5	122.5	147
DMSO [mL]	7	14	21	28	35	42
Total [mL]	35	70	105	140	175	210

- b. Gently swirl to mix.

NOTE

The Screening Buffer should be prepared fresh before each experiment and should NOT be reused from a previous preparation.

- c. This process is exothermic. Allow the Screening Buffer to equilibrate to RT for up to 20 min prior to use.
 d. Once the buffer reaches RT, then pipette 5 mL of Screening Buffer into 3 TC wells per sample coverslip(s).

Example of a 6-well plate configuration for 2 sample coverslips.

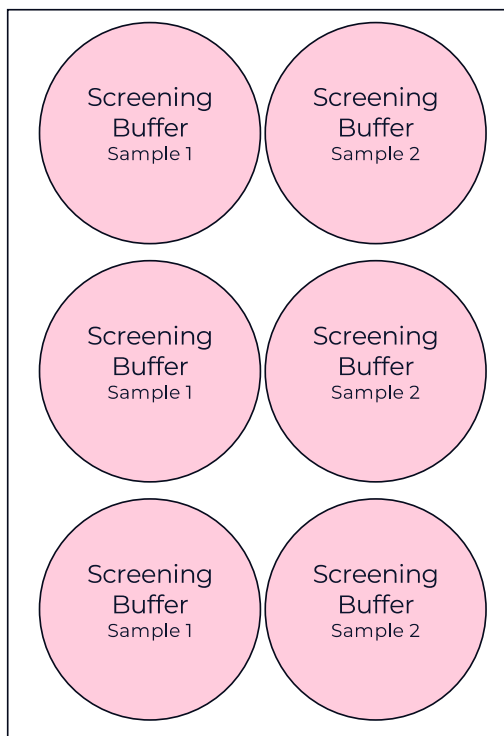

- a. Place the sample coverslip(s) in the first designated well containing Screening Buffer.
 b. Move the sample coverslip(s) to the second well containing Screening Buffer.
 c. Move the sample coverslip(s) to the third well containing Screening Buffer.

CRITICAL

Sample coverslip(s) can be left in Screening Buffer for a maximum time of 15 min.

6.2.2 Prepare 1x CODEX Buffer

- a. Dilute 10x CODEX® Buffer to 1x CODEX® Buffer using ddH₂O. Generate a total volume of 1x CODEX® Buffer that is enough for making the Reporter Stock Solution and for washing the tissue sections in step 6.2.6e. Consider that each sample coverslip is washed in ~5 mL of 1x CODEX® Buffer for the washing step in 6.2.6e and that 1x CODEX® Buffer may be used for coverslip mounting in step 6.2.7c.

1x CODEX® Buffer	Number sample coverslips					
	2	4	6	8	10	12
ddH ₂ O [mL]	9	18	27	36	45	54
10x CODEX® Buffer [mL]	1	2	3	4	5	6
Total Volume [mL]	10	20	30	40	50	60

- b. Pipette ~5 mL of 1x CODEX® Buffer into one well of a TC 6-well plate per sample coverslip(s) and set aside until step 6.2.6e.

6.2.3 Prepare Reporter Stock Solution

- a. Determine if you are making a Reporter Stock Solution with or without Nuclear Stain. Prepare the corresponding volume depending on the number of sample coverslip(s) being screened. If you are using a mounting medium which does not contain DAPI, use the first table. If you are using a mounting medium which contains DAPI, use the second table.

Reporter Stock Solution (with Nuclear Stain)	Number sample coverslips					
	2	4	6	8	10	12
Screening Buffer [μL]	189	379	569	758	948	1138
Assay Reagent [μL]	10	20	30	40	50	60
Nuclear Stain [μL]	1	1	1	2	2	2
Total [μL]	200	400	600	800	1000	1200

Reporter Stock Solution (with no Nuclear Stain)	Number sample coverslips					
	2	4	6	8	10	12
Screening Buffer [μL]	190	380	570	760	950	1140
Assay Reagent [μL]	10	20	30	40	50	60
Total [μL]	200	400	600	800	1000	1200

6.2.4 Prepare Reporter Master Mix

- Put CODEX® Reporter tubes in an ice bucket before use.
- Briefly spin down the Reporter tubes using a benchtop centrifuge.
- Label an amber tube for each unique Reporter Master Mix that will be deposited onto the tissue. The final volume of the Reporter Master Mix is 100 μL per sample coverslip.
- Add Reporter Stock Solution to the labeled tube(s). The volume of Reporter Stock Solution will depend on the number of total Reporters (up to 3) and corresponding number of sample coverslip(s) being stained, as shown in the table below.

Number of sample coverslips	Reporters per coverslip		
	1	2	3
1 sample coverslip	97.5 μL	95.0 μL	92.5 μL
2 sample coverslips	195.0 μL	190.0 μL	185.0 μL
3 sample coverslips	292.5 μL	285.0 μL	277.5 μL

- Add 2.5 μL of each Reporter per sample coverslip, by collecting fluid from the top of the solution, to the Reporter Stock Solution to create the Reporter Master Mix .

Number of sample coverslips	Volume of each Reporter per sample coverslip
1 sample coverslip	2.5 μL
2 sample coverslip	5.0 μL
3 sample coverslip	7.5 μL
4 sample coverslip	10.0 μL

- Keep the Reporter Master Mix on ice.
- Gently pipette to mix. Do not vortex Reporters after they've been combined.

6.2.5 Incubate Sample Coverslip(s) with CODEX® Reporters

- Tape a piece of parafilm to a clean benchtop (as shown in the image below).
- Carefully pipette 95 μL of Reporter Master Mix onto the surface of the parafilm for each sample coverslip. Take care to avoid bubble formation.

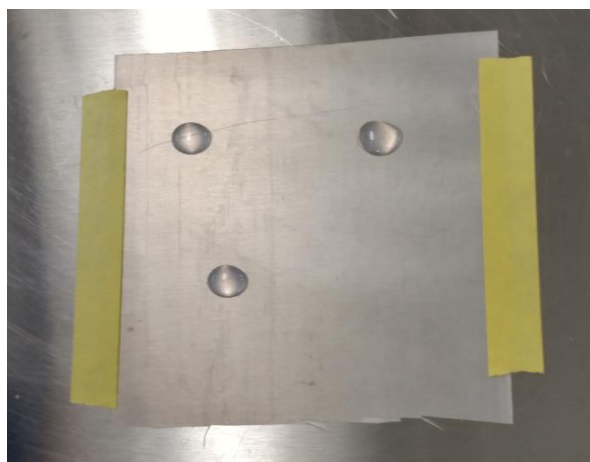

- c. Remove the sample coverslip(s) from the well(s) containing Screening Buffer.
- d. Invert the sample coverslip(s) so that the tissue is facing down and will touch the droplet.
- e. Carefully place each coverslip on top of the corresponding droplet of Reporter Master Mix.

NOTE

Place sample coverslip down by gently placing one edge of coverslip first and then slowly placing the rest of coverslip on top of the liquid. Take care not to crack the coverslip.

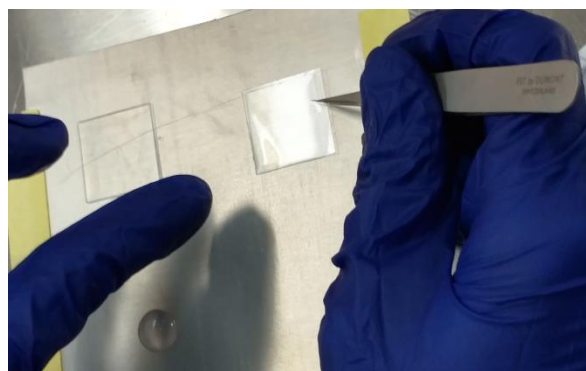

- f. Cover samples to prevent light exposure.
- g. Incubate for 5 min.
- h. Change gloves.

INCUBATE

5 min incubation

- i. During the incubation, prepare 6-well plates for the washing step 6.2.6. Refer to the plate map below and pipet 5 mL of buffer per well. The same Screening Buffer from before may be used.

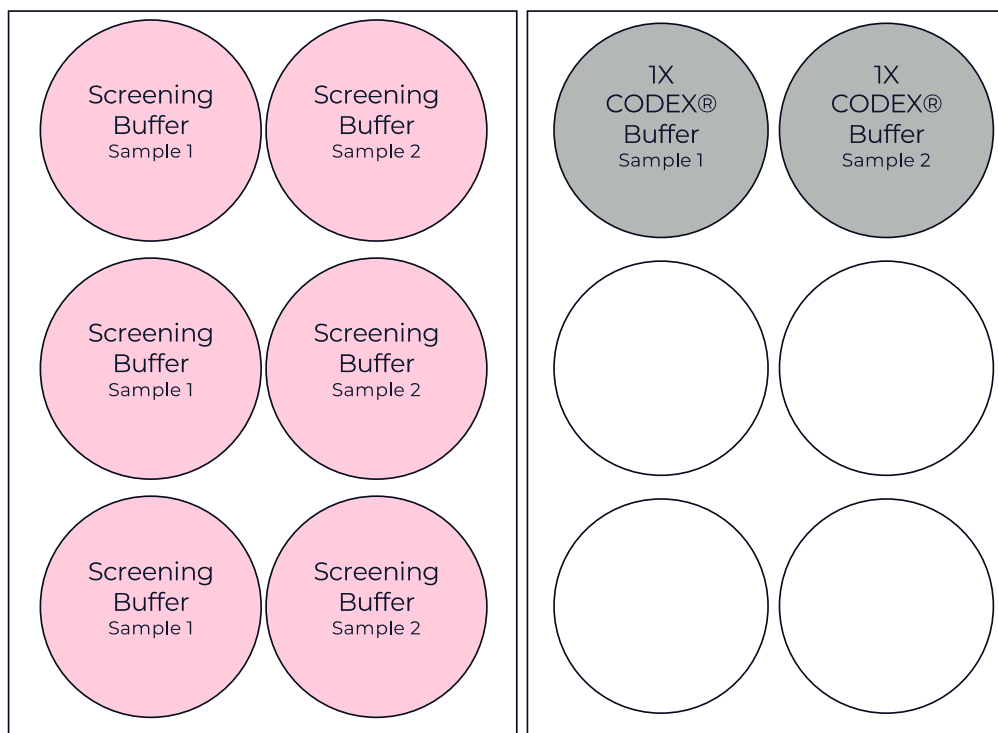

6.2.6 Wash Tissue

- a. Carefully lift coverslip and invert such that the tissue side is facing up.

CRITICAL

Make sure to invert the sample coverslip such that the tissue side is facing up.

- b. Place sample coverslip(s) into the first well containing Screening Buffer. Lift and Immerse 2-3 times.
- c. Place sample coverslip(s) into the second well containing Screening Buffer. Lift and Immerse 2-3 times.
- d. Place sample coverslip(s) into the third well containing Screening Buffer for a total of three washes. Lift and Immerse 2-3 times.
- e. Place sample coverslip(s) into well(s) containing 1x CODEX® Buffer.

6.2.7 Mount Tissue

Detailed instructions can also be found in Appendix C.

- a. Prepare and label one microscope slide per sample coverslip.
- b. For mounting solution either use a product such as Fluoromount-G™ or 1x CODEX® Buffer.
- c. Add ~10 µL of the mounting solution to each microscope slide.
- d. Take the sample coverslip(s) out of the Screening Buffer.
- e. Invert the sample coverslip(s).
- f. Gently place the sample coverslip on top of the microscope slide, making sure that the tissue side is in direct contact with the microscope slide (tissue facing downwards).

NOTE

Take care to prevent air bubbles from forming. If bubbles form, remove the tissue from the mount, immerse it again in 1x CODEX® Buffer and repeat this procedure on a new microscope slide.

- g. Gently apply vacuum to the edges of the sample coverslip to aspirate excess liquid.

CRITICAL

Be careful not to aspirate liquid from under the coverslip. Do not dry out the tissue.

- h. When coverslip is gently tapped with tweezers and does not move, enough liquid has been removed.
i. Cover edges with a sealant such as a nail polish.
j. The sealant can take ~5-7 min to dry.

NOTE

If there is buffer on top of the coverslip, the sealant will spread over the coverslip. This can be removed by dabbing acetone on the sealant. Take care not to break the edges of the seal.

- k. After the sealant has dried, wet a Kimwipe tissue with water to remove salt crystals from the top of the sample coverslip. The presence of salt on the coverslip is caused by the evaporation of the buffers used for the washing procedure.

6.3 Visualization and Analysis of Manual Validation Images

Make sure to use the same fluorescence microscope that will be used in CODEX® runs using analogous settings (i.e., exposure times, filter cubes, camera settings, lamp/LED intensity, etc.)

Use the nuclear staining (DAPI channel) to focus on the tissue section before acquiring fluorescence images of the antibodies.

Images of the CODEX® Antibodies under validation must be captured using the same conditions for all three tissue samples for comparison purposes. Multiple images at different exposure times can be taken for all tissue sections for optimization purposes, refer to help.codex.bio for detailed instructions on optimization of exposure times. Results will be used for both qualitative and quantitative analysis.

6.3.1 Qualitative Analysis

Qualitative analysis is performed to ensure the staining of the CODEX® conjugated antibody reflects the expression of the selected biomarker. From a qualitative point of view, staining is considered satisfactory when:

- The signal of the antibody being validated overlaps with its co-stain (or positive counterstain) as expected.
- The signal does not overlap with the negative counterstain.

Carefully evaluate the degree of superposition between the different staining; obtained results should be consistent with the expression pattern expected for the investigated biomarkers. Representative fluorescence images of a successful validation experiment are shown in the figure below.

CD8 in FFPE Human Tonsil
Negative counterstain

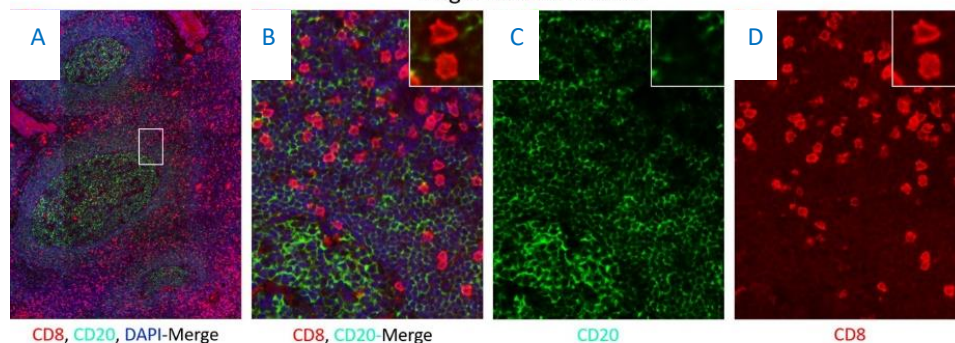

Positive counterstain

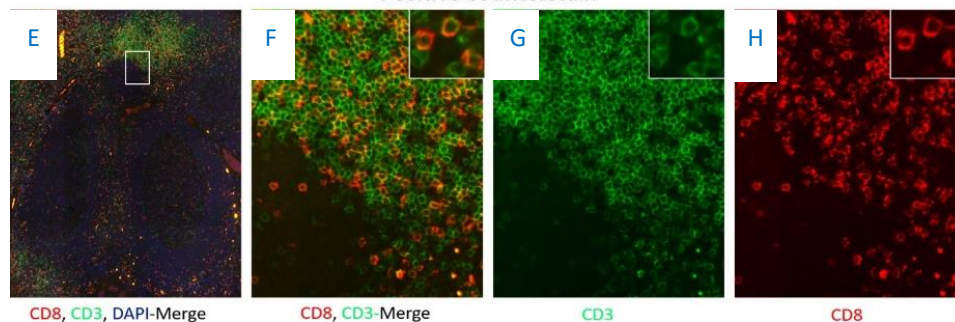

Fluorescence microscopy images of two of the three tissue sections of an FFPE human tonsil used for validation of a CODEX[®] conjugated antibody anti-CD8. CODEX[®] conjugated anti-CD20 and anti-CD3 emitting in different channels have been selected as counter-stain and co-stain, respectively. Images in the top row (A-D) show the lack of overlap between the CODEX[®] conjugated anti-CD8 signal and the counter-stain signal. The bottom row (E-H) shows the superposition of CD8 and CD3 staining in cytotoxic T-cells.

6.3.2 Quantitative Analysis

This analysis calculates the mean Signal to Noise Ratio (SNR) given by the staining of the CODEX[®] Antibody. Signal and noise (background level) values can be quantified through FIJI or any other analysis platform of choice.

For guidance on how to use FIJI for SNR determination, please refer to help.codex.bio. This procedure needs to be performed for each of the three tissue sections so that obtained SNRs can be averaged. The mean SNR should be higher than the minimum threshold value established by the user. This value strongly depends on the imaging conditions, the reporter dye, the tissue quality, etc. and needs to be determined case by case. Generally, we recommend that validated CODEX[®] Antibodies give a mean SNR higher than 2-2.5.

Chapter 7. Preparing CODEX® Reporters

7.1 CONFIGURATION OF CODEX® CYCLES 83
 7.2 CODEX® REPORTER PLATE PREPARATION 86

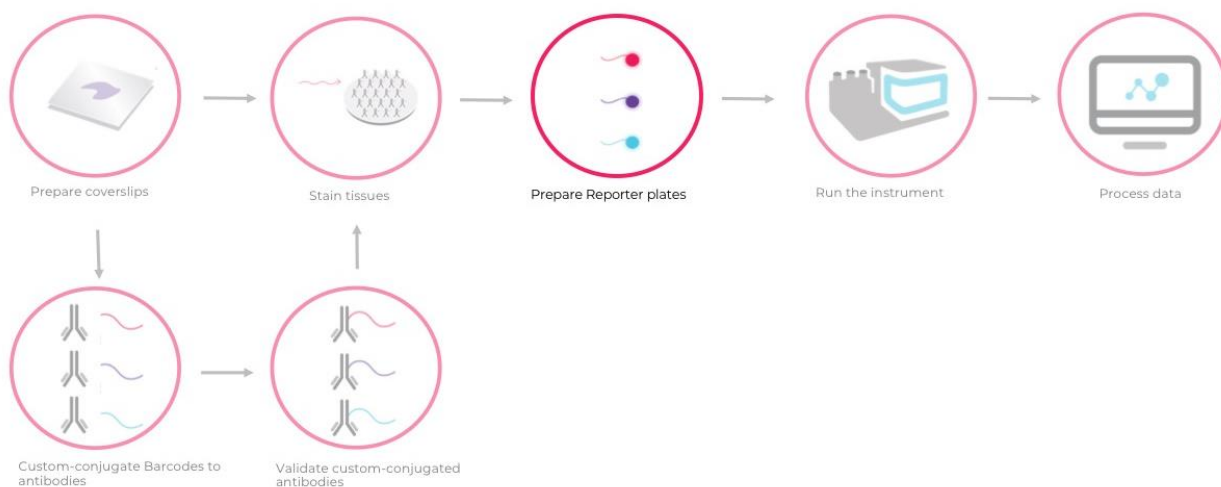

This section describes how to prepare and organize the CODEX® Reporters revealed in a CODEX® Multicycle run. A Reporter is comprised of a fluorescent dye conjugated to a CODEX® oligonucleotide sequence complementary to one specific antibody barcode. As part of the Reporter plate preparation, unique Reporters are grouped together in mixtures of up to three spectrally distinct dyes and will also be combined with a nuclear stain. Each of these mixtures is called a Reporter Master Mix and is placed in one well of a 96-well plate. Each well corresponds to one CODEX® cycle.

During each cycle, the CODEX® Instrument withdraws Reporter Master Mix from one well on the 96-well plate to dispense onto the sample prior to image acquisition. The cycle ends with the removal of the Reporters from the tissue sample.

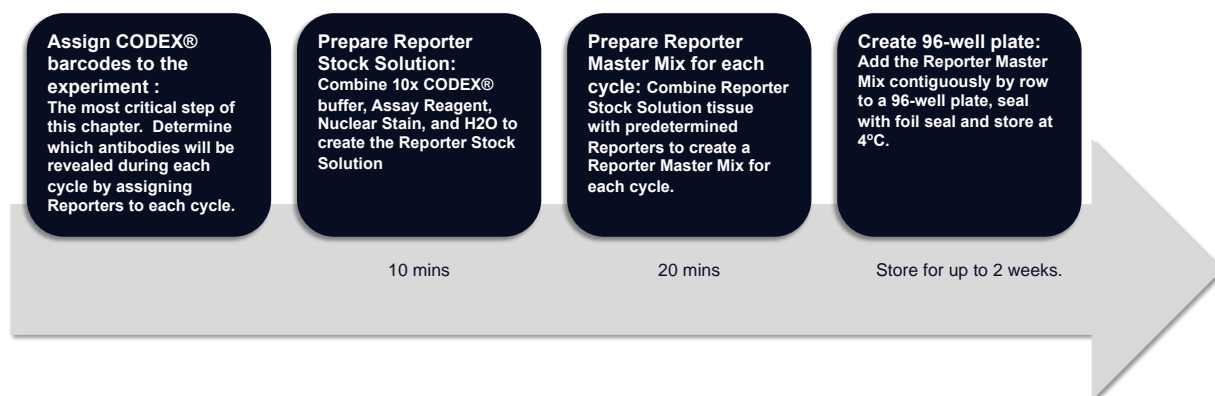

7.1 Configuration of CODEX® Cycles

A CODEX® run requires the preparation of a Reporter Master Mix for every cycle. Each Reporter Master Mix will be placed in a separate well of a 96-well plate.

CRITICAL

Make sure that Reporters belonging to the same cycle are paired to different fluorescent dyes. If two reporters are paired with the same dye in a cycle, they will be revealed at the same time in one fluorescence channel, making it impossible to discriminate the signal coming from the corresponding two biomarkers.

NOTE

Plan the reporters to be revealed in each cycle ahead of time. (Refer to Section 2.4 for experimental setup)

It is important that the complete multicycle is designed before performing the antibody staining and the preparation of the 96-well plate. The 96-well plate can be prepared up to 2 weeks ahead of the experimental run and must be stored with a seal at 4°C until it is time to start the run. The plate set-up will reflect the cycle order for the CODEX® Multicycle run.

7.1.1 Cycle Reporter Configuration

Each CODEX®-tagged Antibody will have a Barcode (BX###), that is complementary to a specific Reporter (RX###). For example, Barcode BX001 corresponds to Reporter RX001. For all custom-conjugated antibodies, conjugations must be performed prior to this step.

- To set up the plate, first list every CODEX® Antibody and its corresponding Reporter. Ensure that each antibody has a unique Barcode that is not shared with any other antibody in the Multicycle panel.
- Assign each antibody to a cycle number, ensuring that a given dye/channel is used only once in each cycle. This process is critical to guarantee the true signal of the obtained fluorescence images concerning a specific biomarker and will determine the final number of cycles. Each cycle can have one or two Reporters instead of three, if necessary.
- The acquisition of 2 blank cycles (with Nuclear Stain and without any Reporter) is recommended for the evaluation of the level of autofluorescence in the three fluorescence channels. These blank cycles are also necessary for post-imaging background subtraction using the CODEX® Processor.

Cycle #	AF488 Reporter	Atto550 Reporter	Cy5 Reporter
1	blank	blank	blank
2	RX001	RX002	RX003
3	RX004	RX005	RX006
4	blank	blank	blank

7.1.2 Plate Cycle Configuration

Once all Reporters are assigned to a cycle number, cycles can be associated to specific wells following an order from left to right (1-12) and from top to bottom (Row A – Row H).

During the CODEX® run, in each cycle, the instrument withdraws the Reporter Master Mix from one well of the 96-well plate. The 96-well plate containing the Reporters must be prepared following the example in the figure below.

Please note that the CODEX® Instrument Manager allows skipping some wells if necessary, and starting from a different well than A1. If a well has been contaminated, the user can simply skip it during the CODEX® run.

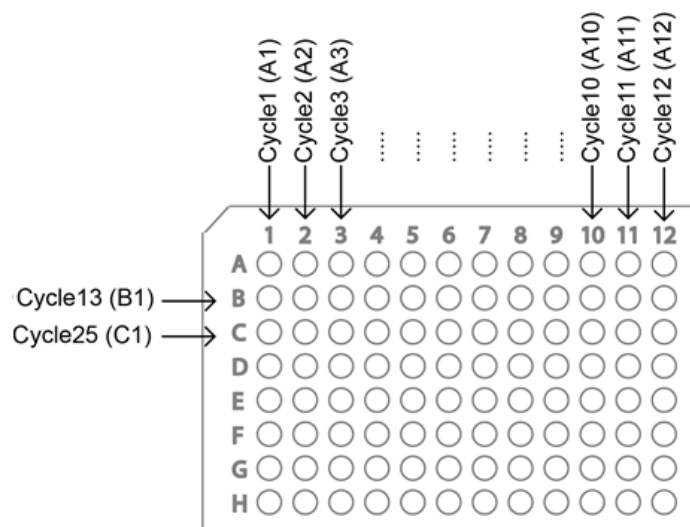

An example of the configuration of a 96-well plate is shown above: Well A1 contains the solution for cycle 1, well A2 contains the solution for cycle 2, and so on. A multicycle CODEX® run can start from any well on the plate and wells can be skipped, as long as this information is included in the CODEX® Instrument Manager software interface before starting the experiment. Refer to [Chapter 8](#) for information regarding the CODEX® Instrument Manager software.

7.1.3 Blank Cycles

Blank images are recorded in 3 fluorescence channels at the beginning and at the end of a CODEX® Multicycle run (the Nuclear Stain will still be deposited as this will be used for autofocusing). Blank cycles are used for subtracting background signal during downstream processing.

For running these controls, we recommend adding 2 blank cycles to the total cycle number: one that is performed at the beginning and one at the end of the CODEX® run. This means that aliquots of the Reporter Stock Solution (with Nuclear Stain but without any Reporters) will be dispensed to the first and the last well of the 96-well plate used in the CODEX® run. The user determines the location of the first well, and that of the last well is determined by the number of cycles and the number of skipped wells.

7.2 CODEX® Reporter Plate Preparation

Guidelines

- Akoya 96-well plates must be used for Reporter plate preparation. Alternative plates may not have the proper dimensions that are programmed into the CIM software.
- Akoya foil seals must be used for sealing the prepared plates. Alternative seals may stick to the instrument during the aspiration steps.
- Reporter plates can be created up to 2 weeks in advance.
- Prepared Reporter plates should be sealed and stored at 4°C.

Pre-Experiment Preparation

Materials Included in Kit

Item	Storage Location	Use at
96-Well Plates (PN# 7000006)	RT	RT
96-well Plate Foil Seals (PN# 7000007)		
10x CODEX® Buffer (PN# 7000001)		
Assay Reagent (PN# 7000002)	-20°C, and 4°C after the first thaw	Place on Ice
Nuclear Stain (PN# 7000003)		
Reporters		

Materials NOT Included in Kit

- Nuclease-free water
- Amber 1.5 mL tubes
- A 15 mL tube covered with foil
- A bucket of ice

7.2.1 Prepare the Reporter Stock Solution

- Prepare the Reporter Stock Solution based on the total number of cycles for the experiment in an amber 1.5 mL tube or a 15 mL tube covered with foil.

Reporter Stock Solution	Cycles/Wells			
	5	10	15	20
Nuclease free water [μL]	1220	2440	3660	4880
10x CODEX® Buffer [μL]	150	300	450	600
Assay Reagent [μL]	125	250	375	500
Nuclear Stain [μL]	5	10	15	20
Total [μL]	1500	3000	4500	6000

- After adding all reagents, mix by gently inverting the Reporter Stock Solution tube a few times.

NOTE

Prevent the formation of bubbles. Do not shake or vortex the solution vigorously.

7.2.2 Prepare the Reporter Master Mix for each cycle

- For each cycle, label an amber 1.5 mL tube with the associated cycle number or well number (for example, "A1").
- Add the Reporter Stock Solution to each amber tube. The volume of Stock Solution will vary depending on whether 1, 2, or 3 Reporters will be revealed as well as if more than 1 plate is being prepared.

Reporter Stock Solution, Volume [μL]				
# of Plates	3 Reporters per cycle	2 Reporters per cycle	1 Reporter per cycle	Blank cycle
1	235	240	245	250
2	470	480	490	500
3	705	720	735	750

- Put Reporters in an ice bucket before use.
- Briefly spin tubes down using a benchtop centrifuge.
- Add 5 μL of each Reporter to its corresponding amber tube

Number of Reporters per amber tube	Total volume of all Reporters per amber tube
1	5 μL
2	10 μL
3	15 μL

- Mix the contents of the tube by gently pipetting up and down or gently inverting the tube.

NOTE

Minimize the number of bubbles generated during this process. Do not shake or vortex the solution vigorously.

- Repeat steps a-f for every cycle.

7.2.3 Create the Reporter 96-well Plate

- Once all tubes have been prepared, obtain the 96-well plate.
- Pipette 245 μL of Reporter Master Mix from each tube into its corresponding well on the 96-well plate.

CRITICAL

Use caution when pipetting into the plate; do not touch, drip, or pipette into wells other than the corresponding designated one. Any cross-contamination will alter the staining profile. Do not use wells that have been contaminated.

- Keep the filled wells in the dark to protect fluorescent dyes from photobleaching.

- d. Remove the adhesive layer from a foil plate seal.
- e. Cover the entire plate and do not move or tear the foil once it has adhered to the plate.
- f. To ensure optimal sealing, carefully press down on top of each filled well.
- g. Once the 96-well Reporter plate is prepared, the Template of the CODEX® Experiment can be setup. For your reference, complete a table listing the imaging conditions (concentrations of the Reporter-antibody pairs revealed in each CODEX® cycle (Refer to [Chapter 2.4](#)). We recommend performing this step in advance; instructions on how to fill in the Experimental Template in the software can be found in [Chapter 8](#).

CRITICAL

Take caution if reusing a 96-well plate for an additional CODEX® run. It is best to cover the unused wells with the foil seal in order to keep them dust-free for the next run. Do not disturb the foil seal that is covering the used wells to avoid contamination. Do not cover wells to be pierced by the instrument with more than 1 layer of a foil seal

**STOPPING
POINT**

CODEX® 96-well Reporter plate can be:
Used directly to run a CODEX® Experiment
Stored at 4°C for up to two weeks

Chapter 8. Use of the CODEX® Instrument

8.1 OVERVIEW OF CODEX® EXPERIMENTS 90
 8.2 SET UP THE CODEX® INSTRUMENT FOR A CODEX® RUN 91

This section outlines the setup of the CODEX® Instrument for running a CODEX® Multicycle experiment. [Chapters 3, 5, and 7](#) must be completed before proceeding with this chapter.

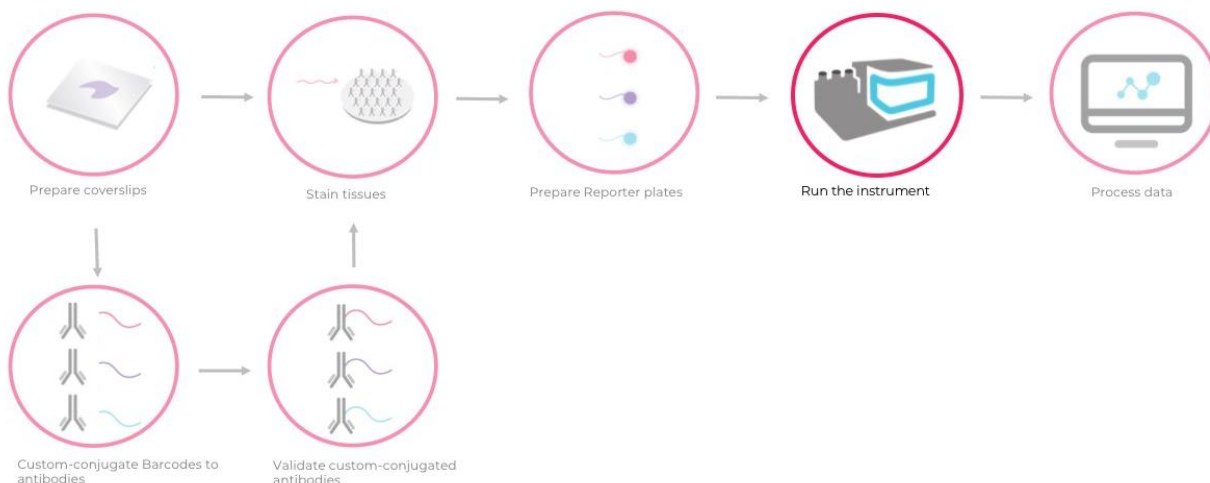

This chapter details the following:

1. Setting up the run and use of the CODEX® Instrument Manager (CIM) software for running a CODEX® experiment
2. Post-run instrument cleaning and maintenance

The CODEX® Instrument Manager (CIM) must already be installed and functional; refer to the CODEX® Instrument Manager online manual (help.codex.bio) for installation guidelines and an introduction to the CIM purpose and functions.

The instructions provided in the online CIM manual need to be integrated with those provided in the online microscope settings and QRCs (help.codex.bio), which contain guidelines specific to the microscope model in use.

The general workflow of a CODEX® Multicycle run is illustrated below:

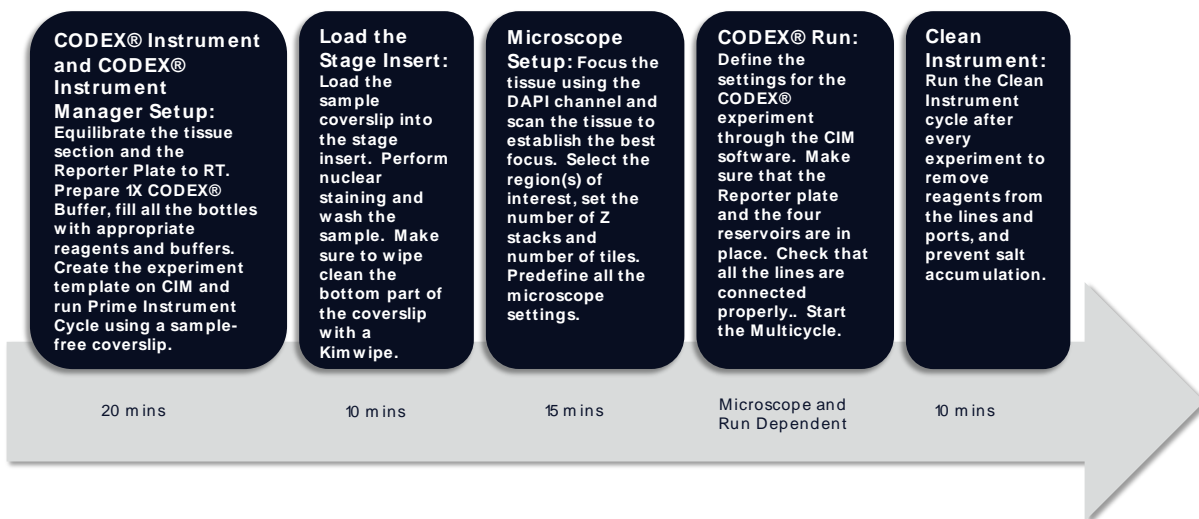

8.1 Overview of CODEX® experiments

In a CODEX® experiment, mixtures of Reporters are sequentially dispensed onto a tissue section stained with CODEX® Antibodies. After each incubation of CODEX® Reporters, the tissue is imaged in 4 fluorescence channels followed by a gentle wash to dehybridize and remove the Reporters.

The tissue staining protocols are outlined in [Chapter 5](#) and the 96-well Reporter plate preparation is outlined in [Chapter 7](#). The total preparation time (materials, instrument, software) of a CODEX® Run is approximately 45 min to 1 hour. The following formula estimates the run time of CODEX® experiments:

$$\text{CODEX® Run Time} = (\text{Fluidics Time (30 min)} + \text{Imaging Time}) \times (\text{number of Cycles})$$

The total fluidics time is approximately 30 minutes per cycle, while the imaging time is dependent on several factors involving the microscope in use and imaging conditions, such as the number of Z stacks, size of the tissue area being imaged, and number of imaged regions.

CRITICAL

It is critical to perform the 'Prime Instrument' protocol before every run and to clean the CODEX® Instrument using the 'Clean Instrument' protocol after every run.

Pre-Experiment Preparation

Materials included in Kit

Item	Kit	Storage Temperature
2 CODEX® Gaskets (PN# 7000010)	À la carte	RT
Nuclear Stain (PN# 7000003)		-20°C, and then 4°C after the first thaw
10x CODEX® Buffer (PN# 7000001)		RT
22x22 mm Glass coverslips (PN# 7000005)		
Stage insert assembly	CODEX® Instrument	

Materials NOT included in Kit

- DMSO
- ddH₂O
- Squeeze bottle for water (recommended)
- 2 mL tubes
- Compressed air duster
- Bent-tip tweezers
- Ice bucket
- Kimwipes
- Bent-tip forceps
- Additional buffer reservoirs
- Sterile disposable filter unit (Recommended: Nalgene™ Rapid-Flow™ Sterile Disposable Filter Units with SFCA Membrane PN# 156-4020)
- Vacuum pump (for filtering)

8.2 Set up the CODEX® Instrument for a CODEX® Run

The CODEX® Instrument Manager includes an Experiment Start Wizard to guide the user through setting up buffers, priming the instrument, performing nuclear staining and the microscope setup. It will also perform fluidics and microscope setting pre-checks. Once the pre-checks are passed, the user can start the run.

Procedure overview:

Instrument Preparation before starting Wizard:

- [8.2.1 Equilibrate samples and reagents to RT](#) – to be done at least 15 minutes before CODEX® run setup.
- [8.2.2 Prepare the 1x CODEX® Buffer](#) – Dilute and filter 10x CODEX® Buffer
- 8.2.3. Pre-Run Clean Instrument Wash (Optional)
- [8.2.4 Start Experiment Setup](#) - Input the experiment information into the template. This can be done ahead of time and saved.

Instrument Preparation guided by the Experiment Start Wizard:

- [8.2.5 Instrument Set Up with Wizard](#) – Load DMSO, filtered 1x CODEX Buffer, and water
- [Prime the Instrument](#) – 6-7 min

- [8.2.6 Sample Preparation: Nuclear Staining](#) – when prompted by the wizard
 - Sample coverslip loading – 2 min
 - Nuclear Staining – 5 min
- [8.2.7 Microscope Setup and Pre-check](#) – 10-30 min Instrument pre-run steps:
 - If applicable, remove the sample coverslip and save in Storage buffer at 4°C for a future run
- [8.2.8 Clear Tissue Protocol \(Optional\)](#) – to remove any hybridized reporters if a run is stopped.
- [8.2.9 Post-Run Clean Instrument Wash](#) – Always wash lines after every run.

8.2.1 Equilibrate Samples and Reagents to RT

- a. Obtain from 4°C:
 - The sealed, pre-loaded 96-well Reporter plate containing the Reporter Master Mix solutions prepared in [Chapter 7](#)
 - The antibody-stained tissue section(s) adhered to the poly-L-lysine coated coverslip prepared in [Chapter 5](#)
- b. Allow equilibrating at RT for 15 minutes before setting up the instrument. Failure to do so may impact data quality.
- c. Ensure reservoirs are cleaned and dried if used from a previous run.

NOTE

For optimal performance, the pre-loaded 96-well Reporter plate and the tissue sample must be equilibrated to RT before starting the CODEX® run.

8.2.2 Prepare 1x CODEX® Buffer

- a. In a clean glass beaker (or similar container), dilute 10x CODEX® Buffer with ddH₂O to make 1x CODEX® Buffer.
- b. Filter 1x CODEX® Buffer using a filter unit connected to a vacuum pump.
- c. Set aside ~5 mL of filtered 1x CODEX® Buffer for performing the Nuclear Staining procedure.
- d. Set aside an additional ~10 mL of filtered 1x CODEX® Buffer for soaking the gaskets.
- e. Place the rest of the filtered 1x CODEX® Buffer in the CODEX® Buffer Bottle, labeled Bottle 1. The total bottle capacity is 2L.
- f. Fill the amber glass bottle labeled Bottle 2 with DMSO. This bottle capacity is 1L.

8.2.3. Pre-Run Clean Instrument Wash (Optional)

It is recommended to perform this procedure immediately before every CODEX® run to clear any residual buffers and DMSO from the fluidic lines and maintain optimal instrument performance. Refer to help.codex.bio for further maintenance instructions.

- a. Load Stage assembly with a blank coverslip.
Please refer to [Appendix D](#) for instructions on loading a coverslip and setting up the CODEX Stage assembly.

NOTE

At this point, the tissue sample is not yet loaded into the Stage assembly.

- b. Make sure the Water Bottle contains at least 20 mL of ddH₂O, and the Waste bottle is sufficiently empty.
- c. Ensure that all caps on the corresponding bottles, including the waste bottle, are firmly closed. Failure to do so can cause vacuum failure and fluids to overflow on the sample well.

NOTE

When attaching or removing bottles from the CODEX® Instrument, turn the bottles and keep the caps still. Turning the caps will result in twisting the lines.

- d. Place the Stage assembly on the dedicated holder or an empty pipette tip box.
- e. Do NOT place the Stage assembly within the microscope yet
- f. Launch the CODEX® Instrument Manager (CIM) Software
- g. Run the 'Clean Instrument Wash' protocol from the Maintenance tab. It will take about 7 min to complete.

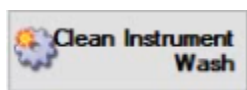

8.2.4 Start Experiment Setup

- a. Once the 'Clean Instrument Wash' protocol is complete, select the Experiment tab to prepare and start the run.

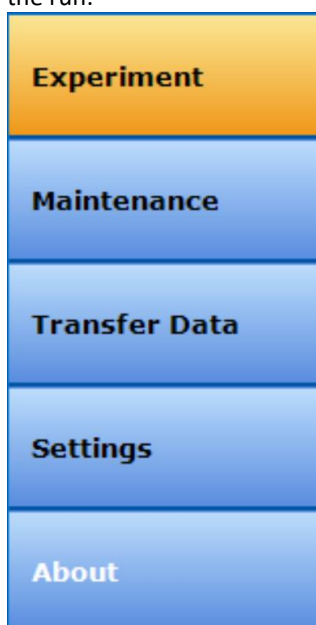

- b. Select 'New Template' to create a new template for inputting experimental settings.



- c. Input the Project and Experiment name.

Project	<input type="text" value="Project1"/>
Experiment	<input type="text" value="Experiment1"/>

- d. Change the Start Cycle Well and #Cycles to reflect the Reporters location in the 96-well Reporter plate prepared in [Chapter 7](#).

Start Cycle Well	#Cycles
<input type="text" value="A1"/>	<input type="text" value="12"/>

- e. Click on 'Channel Assignment'.

Channel Assignment

- f. Assign the proper fluorescence channels to the four channels designated for the CODEX® run. Two common configurations are presented below:

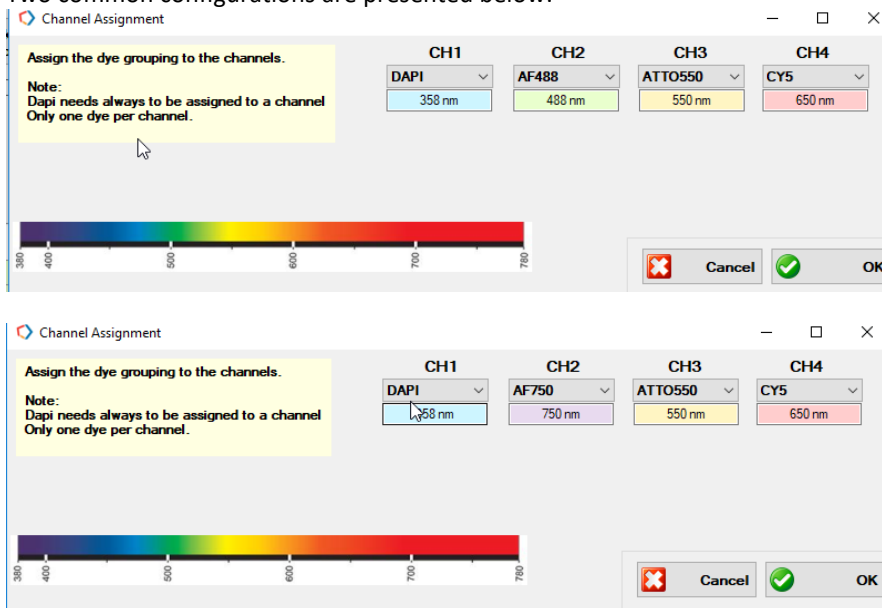

- g. Within the table, for each cycle, enter the Marker Name, Exposure time, and Class. Refer to help.codex.bio for exposure time recommendations.
- h. Depending on the microscope, select the number of Z-Stacks for the image. You can click the Z-Stack Info for further instructions.

Z-Stack Planes

- i. Enter the Operator Name.

Operator

- j. Click 'Save Template' or 'Template Save As' to save the experimental settings if desired. 'Template Save As' can be used to avoid overwriting previous settings.

8.2.5 Instrument Setup with Wizard

The Experiment Start Wizard walks through each of the steps needed to run the CODEX® Instrument. If part of the setup has been completed previously, for example, 'Prime Instrument', these steps can be skipped.

NOTE

At this point, the sample is not yet loaded into the Stage assembly. The CODEX® Instrument needs to be primed first with a blank coverslip or old sample coverslip before loading the sample.

- a. Click 'Start Experiment'. The Experiment Start Wizard starts automatically.

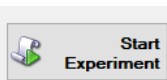

- b. The initial pop-up will describe each of the steps used in the Wizard. Read the overview, then click 'Next'.

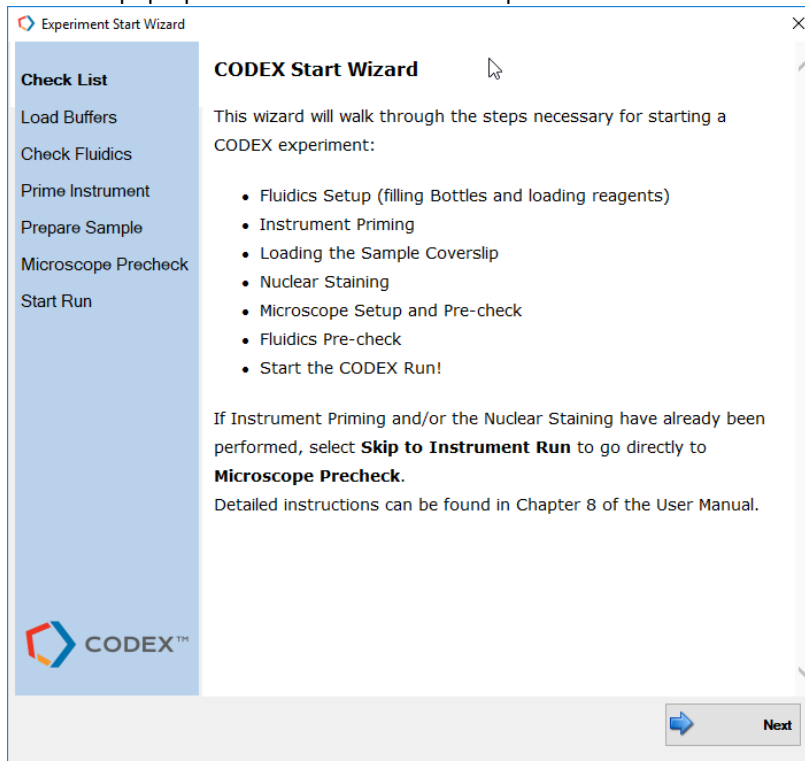

- c. Load the Buffers:
- i. Empty the Waste Bottle of the CODEX® Instrument into the appropriate hazardous waste container.
 - ii. Make sure that the 4 buffer reservoirs located inside the CODEX® Instrument are empty and clean.
 - iii. Fill the water bottle with ddH₂O (approximately 500 mL).
 - iv. Fill the amber glass bottle with DMSO, or load it with sufficient volume for the number of CODEX® cycles to be performed (approximately 35 mL per cycle).
 - v. Fill Bottle 1 with sufficient volume of diluted 1x CODEX® buffer from section 8.2.2 (approximately 50 mL per cycle).
 - vi. Ensure that all caps on the corresponding bottles, including the waste bottle, are firmly closed. Failure to do so can cause vacuum failure and fluids to overflow on the sample well.

NOTE

When attaching or removing bottles from the CODEX® Instrument, turn the bottles and keep the caps still. Turning the caps will result in twisting the lines.

- d. Prepare the Stage assembly for priming the instrument (refer to [Appendix D](#) for stage assembly instructions).
 - i. Soak gasket(s) for ~1 min in filtered 1x CODEX® Buffer.
 - ii. Insert a blank coverslip in the Stage assembly with gaskets as described in [Appendix D](#).
 - iii. Place the Stage assembly on the dedicated holder or an empty pipette tip box.
 - iv. Do NOT place the Stage assembly within the microscope yet.
- e. Click 'Next'.

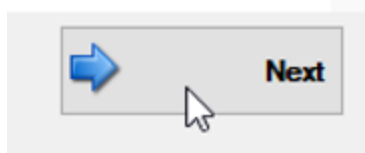

- f. The following screen prompts for checking the fluidics.

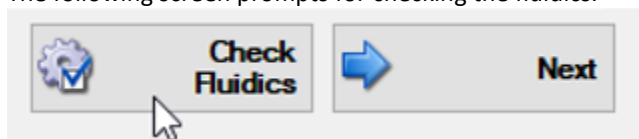

- g. Click 'Check Fluidics'. At this step, each bottle is weighed to determine if there is sufficient volume of reagents for the entire run, and enough capacity in the waste bottle.
- h. Next, the wizard prompts the user to perform the 'Prime Instrument' protocol. Priming the instrument ensures all the lines have the correct buffers and do not have residual water from a wash cycle. This only needs to be performed once before each Run.

- i. When prompted, click 'Prime Instrument'

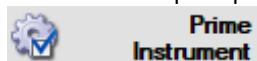

- ii. During the priming procedure, check for leaks from the lines of the Stage insert.
- i. The Wizard then proceeds to the nuclear staining step.

8.2.6 Sample Preparation: Nuclear Staining

The tissue sample must have nuclear staining to enable focusing on the tissue during the microscope setup. This enables the selection and setting of Regions in the microscope software.

Required Materials:

- 1x CODEX® Buffer
- Nuclear Stain
- 1.5 mL tube
- Stage assembly
- Gasket(s) soaked in filtered 1x CODEX® Buffer

Nuclear Stain Solution [1:1500]	
1x CODEX® Buffer [μL]	1500
Nuclear Stain [μL]	1

- Load the tissue sample on the Stage insert assembly by following instructions in [Appendix D](#).
- Obtain the Nuclear Stain and put it on ice.
- Obtain filtered 1x CODEX® Buffer prepared in Section 8.2.2.
- Label a separate 1.5 mL tube as Nuclear Stain Solution.
- Prepare a fresh 1:1500 solution of Nuclear Stain in 1x CODEX® Buffer. Protect the solution from light to avoid photobleaching.
- If solution is present, carefully remove it from the sample well using a P1000 micropipette. You can also directly pipet the Nuclear Stain Solution after loading the sample coverslip if done quickly.
- Pipette 700 μL of the Nuclear Stain Solution into the corner of the sample well and protect the sample from light.

NOTE Avoid pipetting directly on the tissue.

- Click 'Wait & Wash Tissue'. The instrument performs a 3-min incubation before washing the sample well.

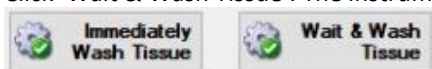

INCUBATE 3-min incubation

- Alternatively, time the 3-min incubation using a timer and, after 3 min, click 'Immediately Wash Tissue' to remove the Nuclear Stain solution.
- The wizard continues with prompts for Microscope Setup.

8.2.7 Microscope Setup and Pre-check

After performing the nuclear staining, you will be prompted to perform the Microscope Setup and Pre-check. For details on specific microscope setup, see the corresponding Microscope QRC (Quick Reference Card - available on help.codex.bio).

- Start the Microscope software and perform the initial setup following the instructions of the Microscope-specific QRC.
- Place the Stage assembly into the microscope.
- Set up filter sets for the CODEX® run on the microscope so that they are consistent with the fluorescence 'Channel Assignment' in the CIM Experimental Setup.
- Select the DAPI channel and focus on the tissue sample.
- Select imaging region(s).
- Select the Z pitch and the number of Z planes so that they are consistent with the CIM Experimental Setup.
- Designate the folder path for where images during the run will be saved within the microscope software.
- Once complete, click 'Microscope Pre-check'. This step checks that each of the settings and the information the CODEX® software selects during Imaging is correct.

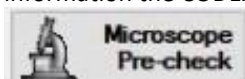

- Once complete, click 'Start' to begin the run.

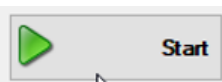

- j. Double-check the instrument setup and click 'Close' to start the run

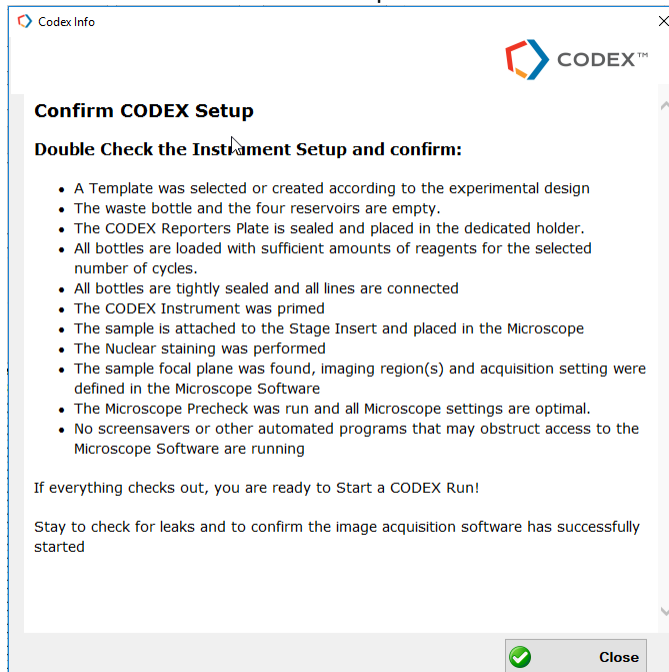

CRITICAL

The CODEX® run and any other protocol can be interrupted using the STOP button. It is recommended to immediately run the Clear Tissue Protocol ([section 8.2.8](#)) if the run was interrupted.

Please note that starting a new protocol after having interrupted a previous protocol is likely to cause overflow on the Stage insert assembly. After interrupting any protocol, remove the Stage insert assembly from the microscope and substitute the tissue sample with a dummy coverslip, then run 'Prime Instrument'.

8.2.8 Clear Tissue Protocol (Optional)

If the experiment run was interrupted for any reason and it is possible that reporters are still on the sample, they must be cleared from the sample while still connected to the CODEX® Instrument in order to reuse the sample coverslip. If the tissue is not needed for future runs, proceed directly to the next step.

- Remove the Stage insert from the microscope and place in the dedicated holder or a pipette box, making sure the tissue section remains hydrated during this operation.
- Make sure that the two reservoirs towards the back are empty.
- Select the Maintenance Tab.
- Click 'Clear Tissue'. This procedure removes from the tissue any residual CODEX® Reporters. Then proceed to the next section 8.2.9.



NOTE

Remove the tissue section from the Stage as soon as possible if it needs to be preserved for future studies. Place the tissue in Storage Buffer at 4°C without letting it dry during the transfer.

8.2.9 Post-Run Clean Instrument Wash

You must perform this procedure immediately after every CODEX® run to maintain instrument performance. Refer to help.codex.bio for further maintenance Instructions.

- a. Remove the Stage insert assembly from the microscope and place it in the dedicated holder.
- b. If the tissue section has been removed, load the Stage assembly with a blank coverslip.
- c. Please note that if the tissue section remains loaded in the Stage during this washing procedure, it will not be reusable for further studies.
- d. Make sure the Water Bottle contains at least 20 mL of ddH₂O.
- e. Run 'Clean Instrument Wash' from the Maintenance Tab, it will take about 7 min to complete.

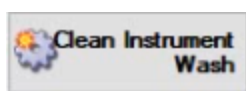

- f. Remove the 96-well Reporter plate and empty and rinse the used reservoirs.
- g. Close the door of the CODEX® Instrument.

NOTE

DMSO is present in all reservoirs and the waste bottle. Dispose of liquids properly.

- h. Close the CIM software.
- i. Turn off the CODEX® Instrument.
- j. Close the microscope software interface.
- k. Turn off the microscope.

CRITICAL

The deck surface should only be cleaned using water and ethanol. Other solvents will contaminate and damage the instrument.

Appendix A: Plate configurations

Plate Configurations for Tissue Staining

[Chapter 5](#) has multiple 6-well tissue culture plate configurations. Examples for layouts for more than 2 samples are shown below.

For 3 Tissue Samples:

Pre-Staining Plates

Configuration 5.1 – For fresh-frozen samples only

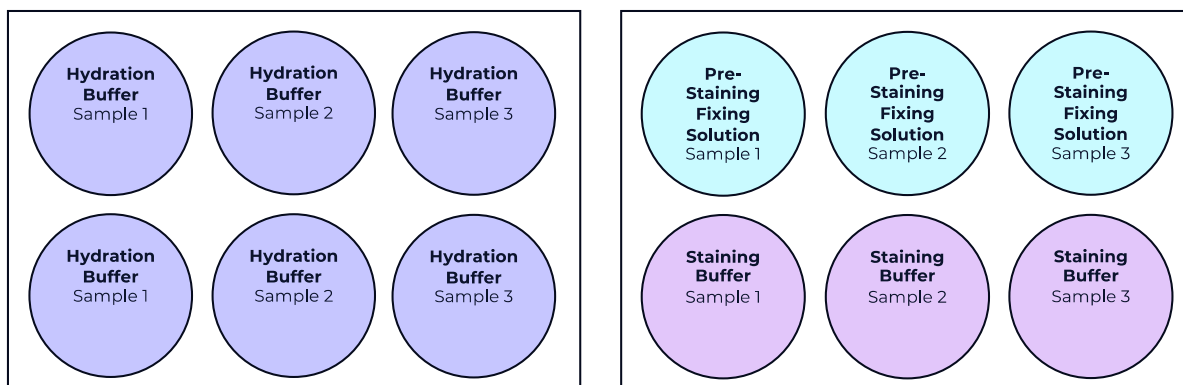

Configuration 5.4 - For FFPE samples only

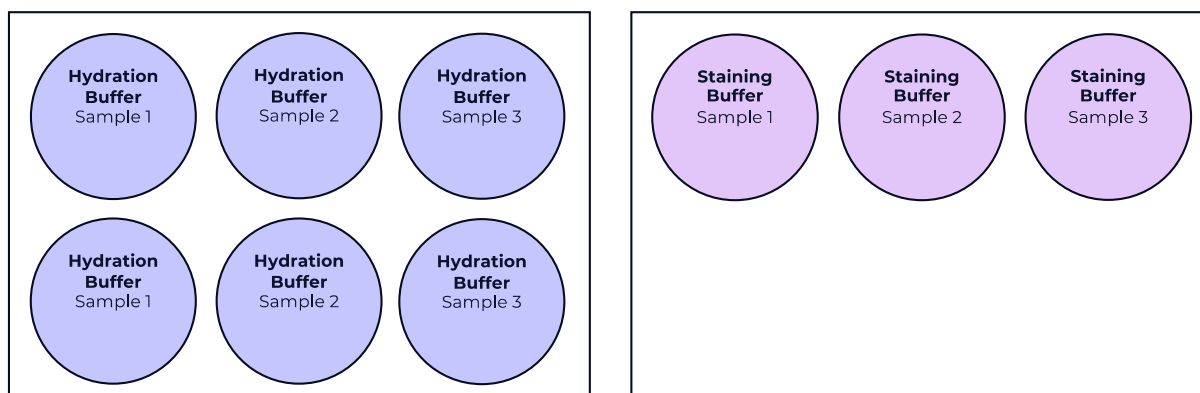

Post-Staining Plates

Configuration 5.3 **AND** 5.6 – For fresh-frozen **AND** FFPE tissues

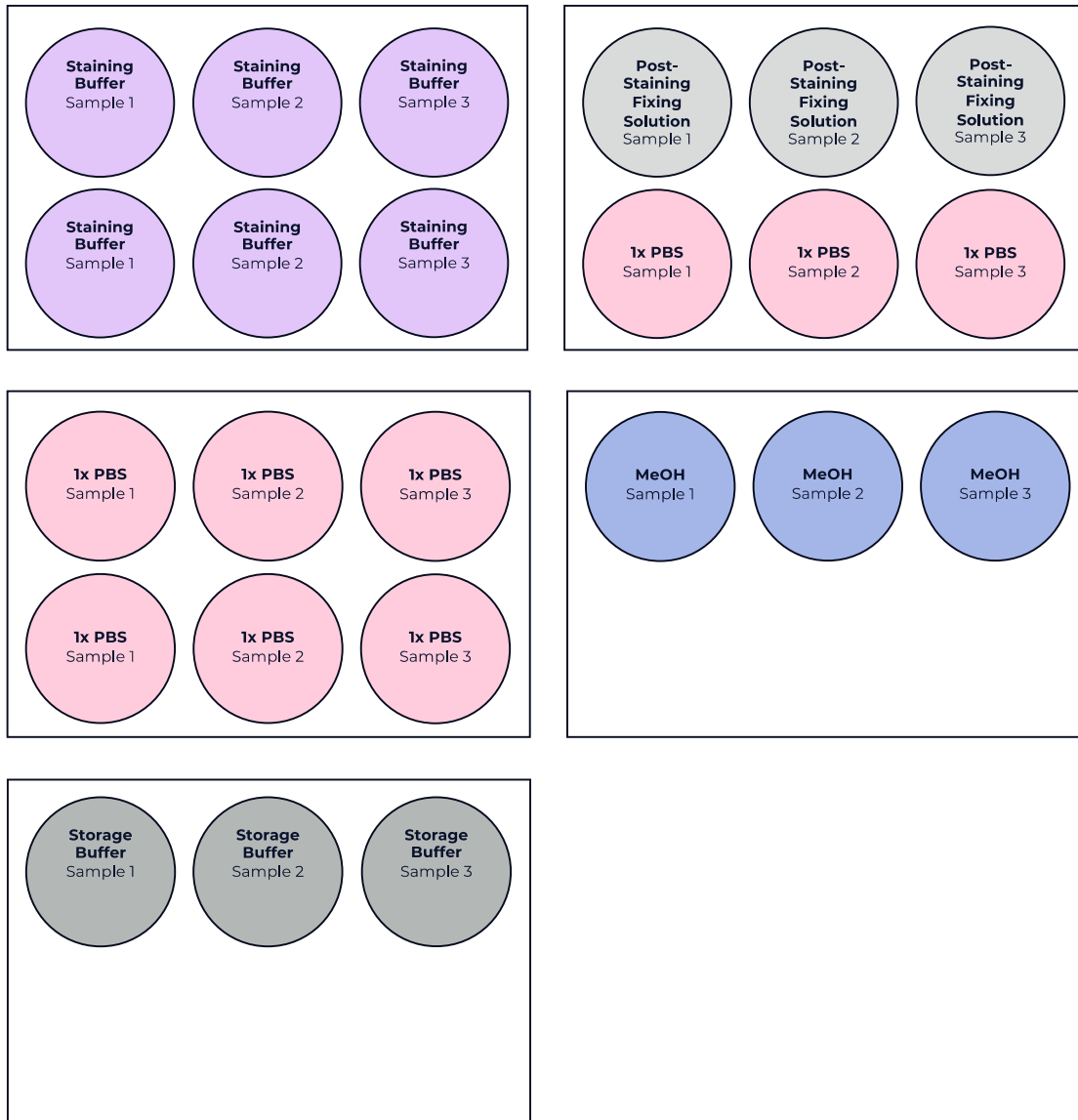

For 4-6 Tissue Samples:

Pre-Staining Plates

Configuration 5.1 – for fresh-frozen samples only

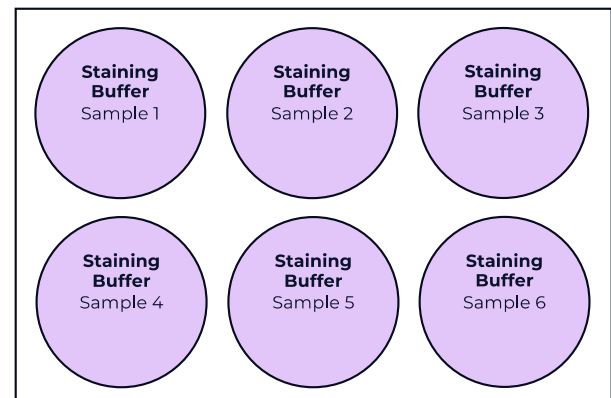
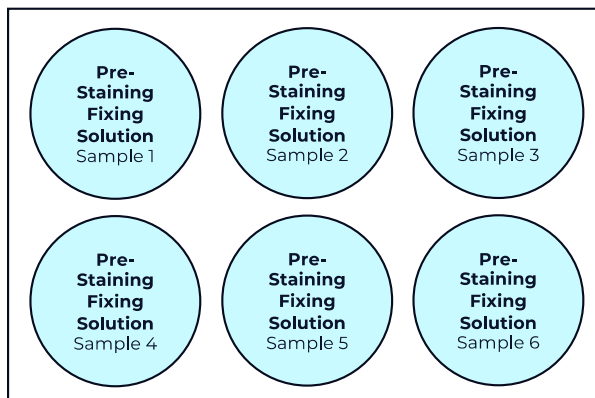
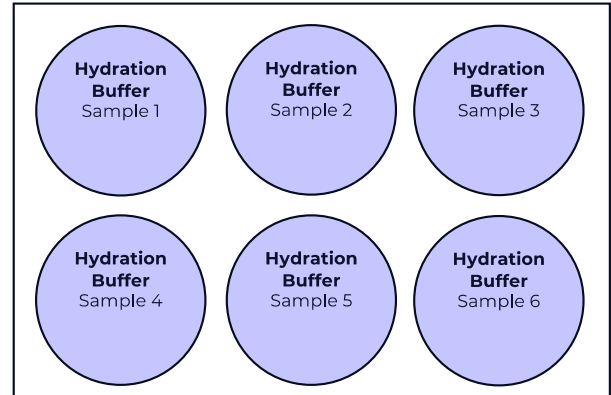
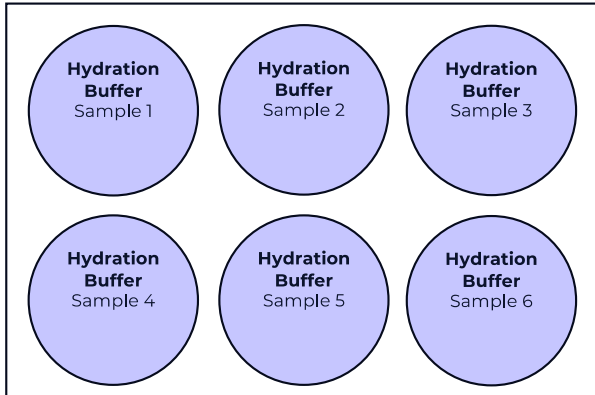

Configuration 5.4 - for FFPE samples only

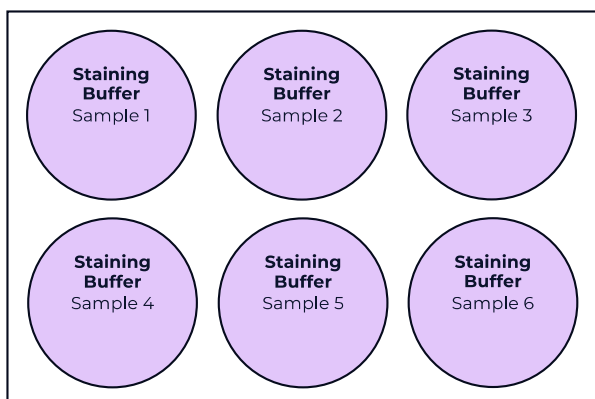
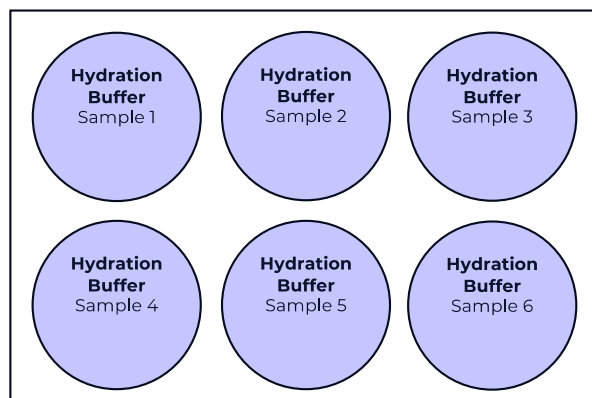
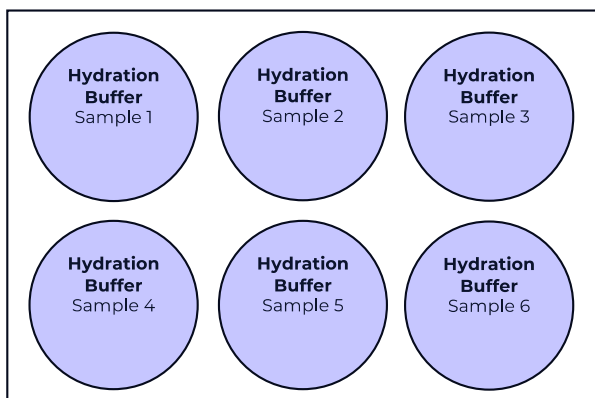

Post-Staining Plates

Configuration 5.3 **AND** 5.6 – For fresh-frozen **AND** FFPE tissues

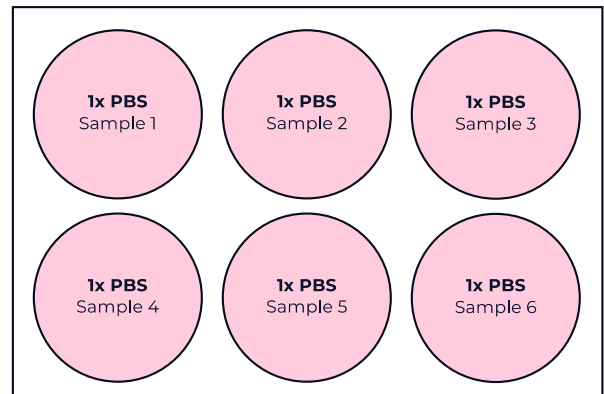
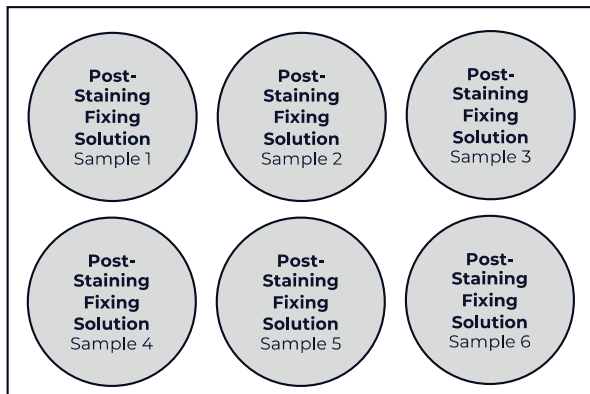
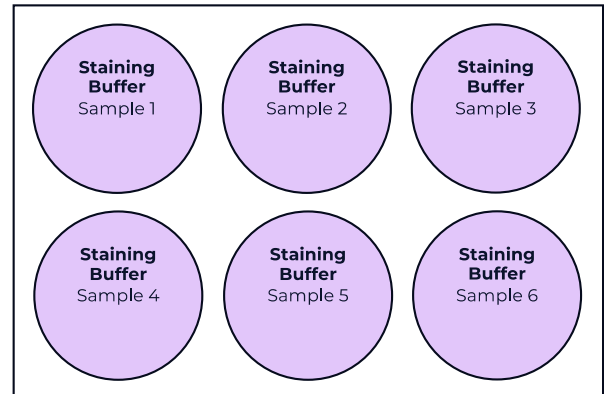
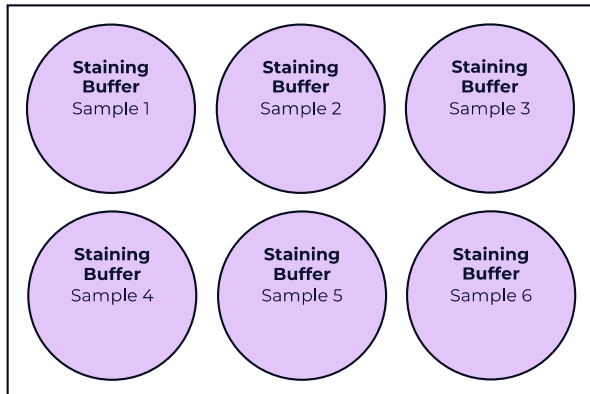

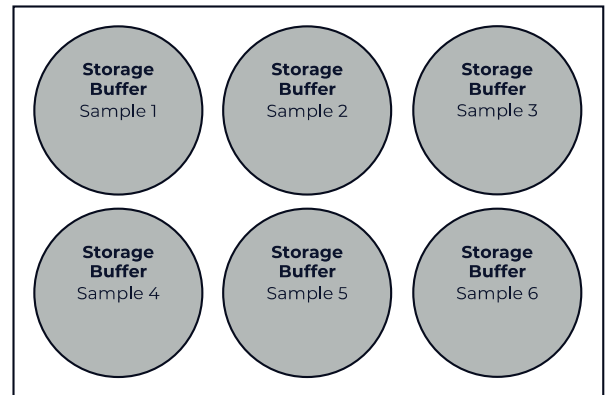
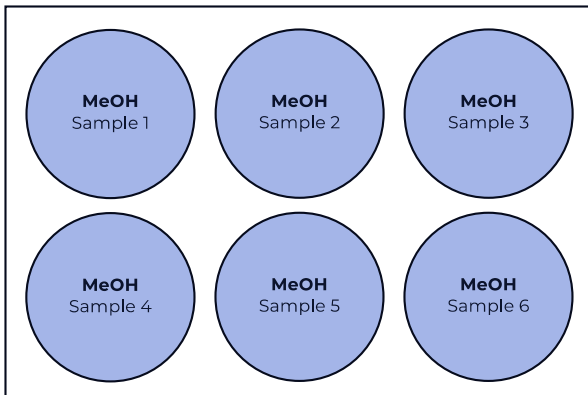
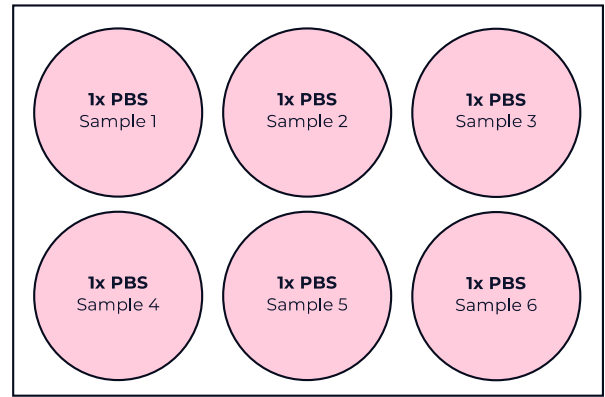
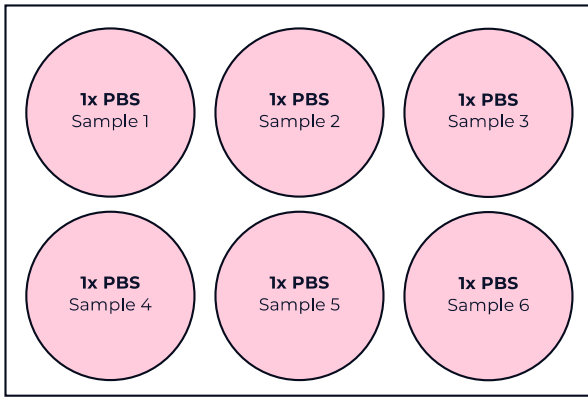

Appendix B: Titration of CODEX® Antibodies

This section offers instructions on how to perform a titration of CODEX® Antibodies on fresh-frozen or FFPE tissue sections.

General Considerations

The antigen-binding efficiency of primary antibodies depends on their intrinsic affinity towards the targeted epitope as well as on the selectivity of the recognition. Some antibodies might show some degree of non-specific absorption, giving rise to artifacts or an increase in the background signal.

Since three different fluorescent dyes are used to detect the antibodies in CODEX® experiments, It Is Important to keep in mind that the quantum yield of the reporter-dyes and the efficiency of fluorescence detection play a crucial role in antibody signal detection.

To achieve optimal staining, it is best practice to establish the optimal amount of CODEX® Antibody by titration. Low antibody concentrations can cause incomplete staining, while high concentrations could cause non-specific absorption. The optimal amount of antibody for a CODEX® experiment is achieved when a balance is met between all the phenomena influencing the staining results. The optimal concentration may vary between sample types and tissues.

For custom-conjugated antibodies, antibody titrations can be performed along with antibody validation. Images may also be acquired using different exposure times for each antibody concentration tested to determine the best imaging conditions. We recommend that exposure times in a multicycle experiment are kept as similar to other markers in the same channel as possible for optimal background subtraction during processing, and that antibody concentration is titrated in an attempt to achieve this. Instructions for the optimization of the exposure times can be found on our support page: help.codex.bio.

Procedure

- a. Select at least two tissue sections (refer to [“Guidelines: Investigation of Autofluorescence – Best Practices”](#); located at akoyabio.com).
- b. Perform the pre-staining procedures specific for fresh-frozen (FF) or FFPE tissue sections reported in [Chapter 5](#).
- c. Prepare several antibody cocktail solutions equivalent to the number of prepared tissue sections, each one containing a different concentration of the investigated antibody.
- d. Recommended starting antibody dilution factors for custom-conjugated antibodies are: for FF - 1:250; for FFPE - 1:50. If this procedure is performed in the context of antibody validation by single-staining experiments, add the co- and the counter-stain to the antibody cocktail solutions following the instructions reported in [Chapter 6](#).
- e. For inventoried antibodies, we recommend starting with the recommended dilution factor; please keep in mind that the optimal concentration may vary by tissue type.
- f. Perform the operations described in [Chapter 6](#) for adding CODEX® Reporters, tissue mounting, visualization and analysis. Details on tissue mounting can also be found in Appendix C.
- g. The best antibody concentration is the lowest one that gives optimal staining intensity and the highest Signal to Noise Ratio (SNR).

Appendix C: Mounting the coverslip on a slide

Required Materials

Sample	Fresh-frozen or FFPE tissue adhered onto a poly-L-lysine coverslip
Chemicals	Molecular biology grade water 10x CODEX® Buffer Mounting medium: Fluoromount-G™(with or without DAPI) <ul style="list-style-type: none"> • 1x CODEX® Buffer can be used as substitute if imaging is done immediately Nuclear Stain (if needed)
Tools/Consumables:	Bent-tip tweezers Tissue-culture 6-well plate(s) Transparent nail polish Microscope slide(s) 1.5 mL Eppendorf amber tube 50 mL conical tube(s)
Lab Equipment:	Vacuum pump

Tissue Pre-Treatment and Staining

This section may vary based on the selected tissue type.

When working with fresh-frozen tissue sections:

- Perform the tissue pre-treatment from step 5.1 to completion of step 5.3 of the User Manual before proceeding with the following section of this protocol.

When working with FFPE tissue sections:

- Perform the tissue pre-treatment from step 5.4 to the completion of step 5.6 of the User Manual before proceeding with the following section of this protocol.

Coverslip Mounting

Dilute 10x CODEX® Buffer to 1x with molecular biology grade water in a conical tube. Consider that every tissue section needs ~6 mL of 1x CODEX® Buffer.

- Equilibrate tissue(s) to 1x CODEX® Buffer by placing it (them) in a well of a TC 6-well plate with 5 mL of 1x CODEX® Buffer for 2 min.

Mount the tissue coverslip(s) using 10 µL of Fluoromount-G™ (preferred) or 1x CODEX® Buffer on a microscope slide following the instructions and corresponding images below:

1. Cut the end of a 20 μ L pipette tip to allow pipetting of the viscous liquid if using Fluoromount-G™. Obtain 10 μ L of Fluoromount-G™ or 1x CODEX® Buffer and dispense it at the center of a microscope slide (see Figure a).
2. Using Bent-tip tweezers, slowly slide the tissue coverslip on the mounting media, making sure that the tissue is facing towards the microscope slide. If air bubbles are present, gently press them with tweezers to remove them (see Figure b).
3. Use a vacuum to gently clean the sides of the coverslip(s) from mounting media (see Figure c). Be careful not to excessively aspirate the liquid from underneath the coverslip. Allow this to dry for a few minutes.
4. Carefully seal the sides of the coverslip with nail polish to guarantee full adhesion to the microscope slide. Let it dry in the dark (see Figure d).

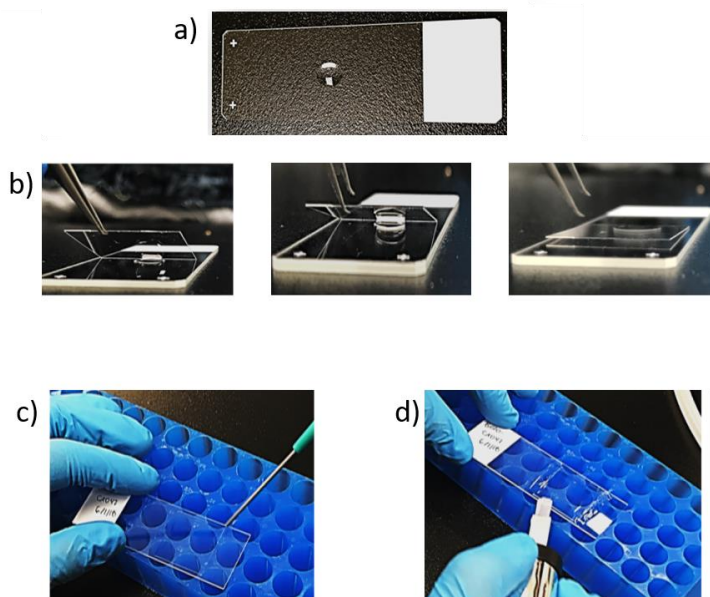

Appendix D: Stage Assembly and Placement into Microscope

The CODEX® Stage Assembly comprises of a microscope-specific CODEX® Stage Plate in addition to a Stage Insert that is placed onto the Stage Plate. This assembly is then placed into the microscope. Two gaskets are needed when loading a coverslip onto the Stage Insert assembly when using the Stage Plate V1. In contrast, only 1 gasket is needed when loading a coverslip using Stage Plate V2.

NOTE

If using Stage Plate V2, please see separate instructions below

Stage Plate V1 requires 2 gaskets. Use of a single gasket with Stage Plate V1 can result in a leak.

To identify if you have a Stage Plate V2, look for the engraving on the bottom side of the stage plate.

Please use an empty coverslip for cleaning and priming of the instrument. Only use the stained sample coverslip for the experimental run beginning at step 8.2.6.

Instructions for Stage Plate V1 with TWO gaskets:

- a. Turn the two knobs at the top of the stage plate to remove the Stage Insert connected with the fluidics lines.
- b. Remove an old coverslip using forceps to push the corners of the gasket towards the center. This releases the seal between the coverslip and gasket.

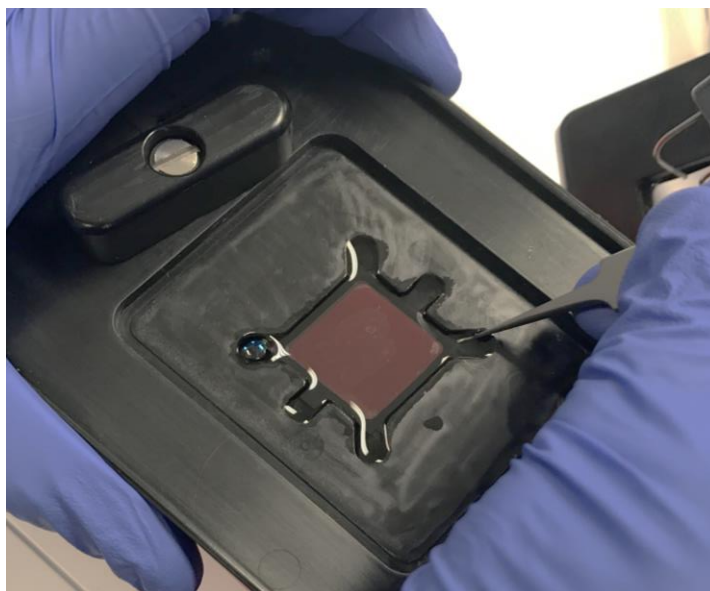

- c. Gently remove the coverslip using the forceps.
- d. If the coverslip breaks, carefully remove all the glass pieces and wash the Stage Insert assembly (bottom part and the insert with the fluidic ports) with ddH₂O. Replace the gasket if this occurs.
- e. Soak the gaskets for the CODEX® Run in filtered 1x CODEX® Buffer for ~1 min. If the gaskets appear to be structurally damaged, replace them with new gaskets.

- f. Rinse the Stage Insert assembly with ddH₂O.
- g. Dry and clean both the Stage Insert and the Stage Plate using a compressed air duster.
- h. Place the first gasket soaked in filtered 1x CODEX[®] Buffer inside the square well at the center of the Stage Plate V1.

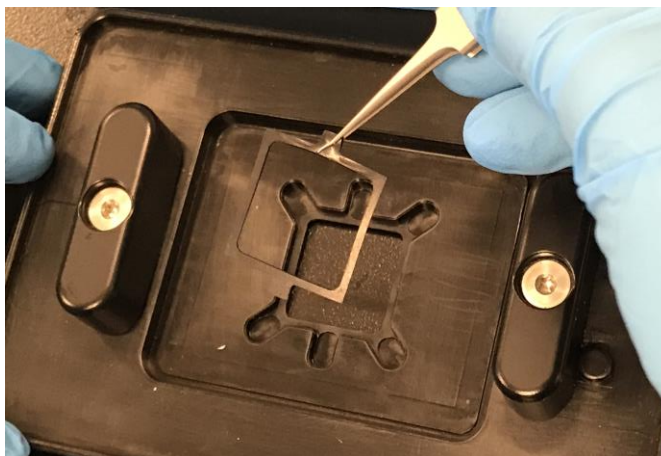

- i. Gently tap the gasket with forceps to make sure it adheres to the Stage Plate surface.

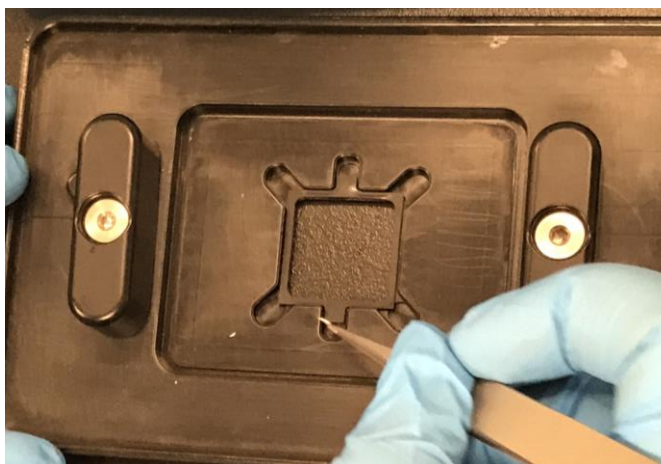

- j. Gently place the sample coverslip on top of the gasket. Make sure the coverslip is level and flat, and that the tissue side is facing upwards.

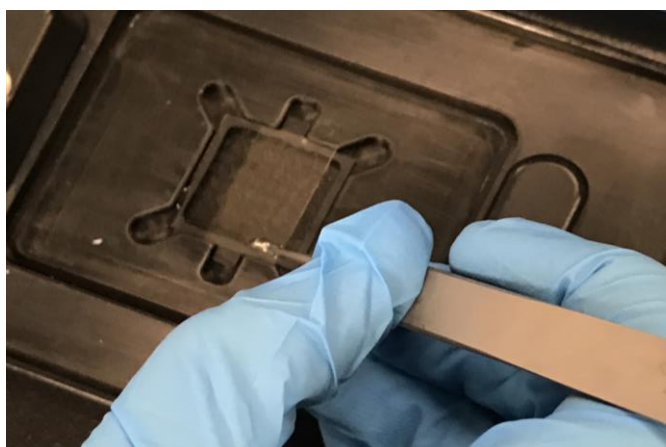

- k. Quickly and gently tap the coverslip edges with forceps to make sure the coverslip adheres to the gasket.
- l. Quickly place the second gasket on top of the sample coverslip.

- m. Quickly place the Stage Insert on top of the second gasket.
- n. Carefully lock the Stage assembly in place by completely turning the levers of the Stage Plate as shown by the red arrows:



- o. If loading a sample, gently pipette 700 μ L of filtered 1x CODEX[®] Buffer (or nuclear stain) onto a corner of the sample well.
- p. Wet a Kimwipe with ddH₂O and wipe the bottom of the sample coverslip to remove any buffers or salts.
- q. Using a new, dry Kimwipe, wipe the bottom of the sample coverslip to dry.
- r. Ensure that the fluidics lines to the Stage Insert are attached, making sure the proper lines are connected with the appropriate corresponding ports.

NOTE

If possible, avoid having the dispense and the aspiration ports placed directly above the tissue specimen.

Instructions for Stage Plate V2 with ONE gasket:

- a. Turn the two knobs at the top of the stage plate v2 to remove the Stage Insert connected with the fluidics lines
- b. Remove an old coverslip using forceps. If the gasket and coverslip stick to the stage insert after being taken off, using a pair of forceps gently move the tabs of the gasket back and forth to release the seal between the coverslip and gasket. Tip : Introducing 1 X CODEX buffer with a pipette helps in releasing this vacuum seal.
- c. Gently remove the coverslip using the forceps.
- d. If the coverslip breaks, carefully remove all the glass pieces and wash the Stage Insert assembly (bottom part and the insert with the fluidic ports) with ddH2O. Replace the gasket if this occurs.
- e. Soak the gasket for the CODEX® run in filtered 1x CODEX® Buffer for ~1 min. If the gasket appears to be structurally damaged, replace it with a new gasket.
- f. Rinse the Stage Insert assembly with ddH2O.
- g. Dry and clean both the Stage Insert and the Stage Plate v2 using a compressed air duster. Make sure the stage plate and the stage insert are clear of any debris
- h. Gently place the sample coverslip (tissue-side facing up) directly into the sample holder or square well at the center of the Stage Plate V2. Make sure the coverslip is perfectly inserted.
- i. Place the first and only gasket on top of the sample coverslip. Note: the gasket has to be soaked in 1x CODEX buffer prior to use.
- j. Finally, place the stage insert on top of the gasket.
- k. Carefully lock the stage insert assembly in place by completely turning the levers of the Stage Plate
- l. Before placing the Stage assembly within the microscope, using a new Kimwipe, make sure to clean the bottom of the sample coverslip to dry.
- m. If loading a sample, gently pipette 700 µL of filtered 1x CODEX® Buffer (or nuclear stain) onto a corner of the sample well.
- n. Wet a Kimwipe with ddH2O and wipe the bottom of the sample coverslip to remove any buffers or salts.
- o. Using a new, dry Kimwipe, wipe the bottom of the sample coverslip to dry.
- p. Ensure that the fluidics lines to the Stage Insert are attached, making sure the proper lines are connected with the appropriate corresponding ports.

NOTE

A single gasket is used with the Stage Plate V2. Use of two gaskets with Stage Plate V2 will cause the coverslip to break

NOTE

If possible, avoid having the dispense and the aspiration ports placed directly above the tissue specimen.

Instructions on the correct placement of the Spill Guard/Leak Detector system and the Stage Plate within a Keyence Microscope:

NOTE

The pictures presented in the instructions below were taken with the following set up: Keyence microscope to the left and the CODEX® Instrument to the right.

1. The picture here shows the correct orientation of the spill guard when placed in the Keyence microscope. Make sure the spill guard is locked in place without much movement. To place it correctly – the two screws (arrows) have to be loosened and removed, the stage holder removed, and then the spill guard slid in at an angle. Place back the stage holder and screw it in place.

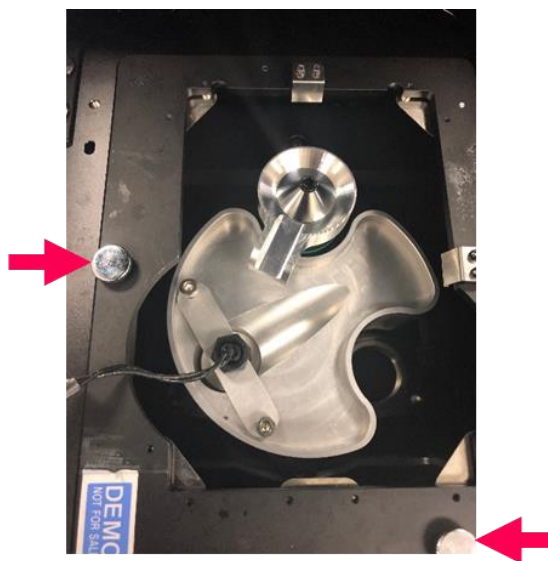

2. The Stage plate sits on the top in an orientation such that the little hole (arrow) is located on the bottom left corner. If any leak occurs, this orientation allows the liquid to drip into the spill guard and allows for leak detection. Please note that the tubing will also be on the left, which allows the tubing to be in place without any kinks.

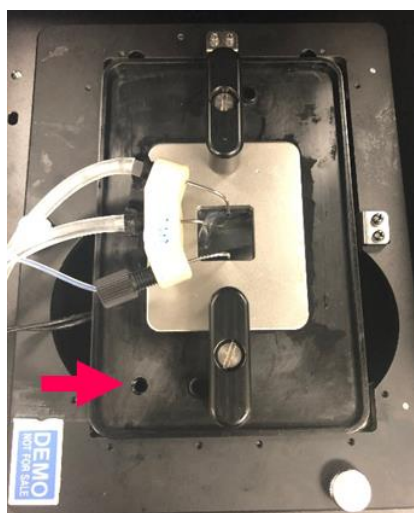

3. Here is a side view image when the stage is correctly placed. Please note the placement of the tubes and the leak detector wiring.

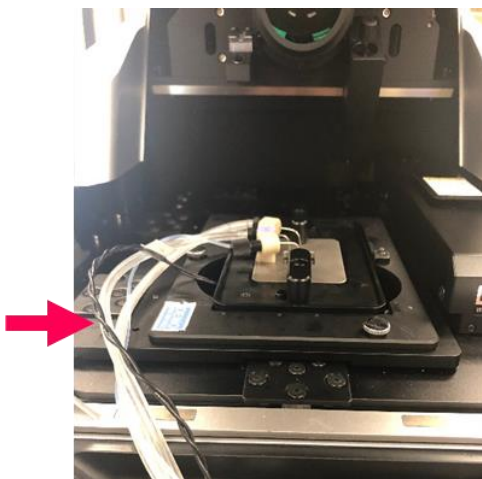

4. Make sure to make room for the tubing by removing the little cassette from the Keyence microscope lid (arrow pointing to the gap created by removing the cassette).



5. Picture of Keyence when closed and ready for the run. Please note the placement of tubing and the leak detector wire. (This is the configuration when the CODEX® Instrument is to the right).

