

High-Performance and Fuel-Efficient
Common Rail Systems by Liebherr

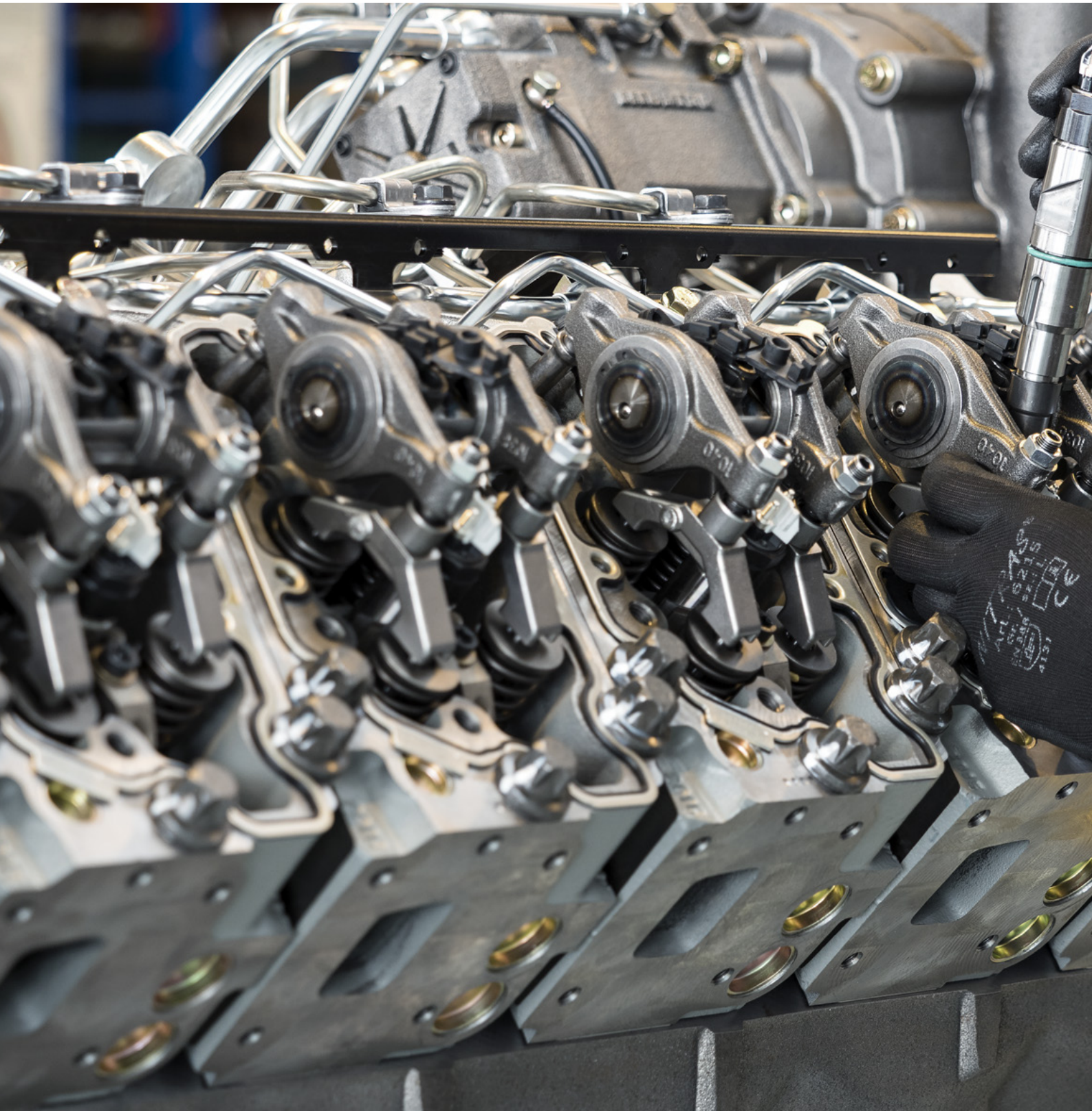

LIEBHERR

Common Rail Systems by Liebherr





The operational spectrum of Liebherr Common Rail systems covers inroad and onroad machines as well as stationary applications and includes the medium and heavy duty ranges. The highly flexible system is equally reliable for series inline and V-engines and supports compliance with applicable and future emissions standards. These include the offroad standards USA EPA CARB Tier 4, 97/68 EC Stage IIIA, Stage IV and Stage V, as well as the onroad standards Euro V and Euro VI. The injection technology developed in-house has already demonstrated its success in nearly 400 engine variants, in diesel engines made by the Liebherr Group as well as in units from other manufacturers.

Advantages

Liebherr's great engineering and system expertise as well as its high degree of vertical integration provide high flexibility in integration of Common Rail systems in various engine variants. Decades of experience in the development and production of diesel engines for

the harshest environmental conditions ensure the ultimate high-performance and reliability of injection systems over a long service life. Precision multiple injection at pressures up to 2,200 bar guarantees low emissions and low fuel consumption.

Ultimate high-performance

Optimal fuel efficiency for your engine

Comprehensive quality assurance

For lifetime reliability

Engineering expertise

State-of-the art methods for stable power and high load capacity

System solutions

Your partner for complete integration

Precision parts from in-house production

Flexibility for every customer requirement

Ultimate high-performance

Liebherr Common Rail systems not only deliver a high injection pressure of 2,200 bar, but also stable multiple injection per combustion cycle. Therefore, it is possible to minimise

soot particles and NOx emissions already inside the engine. The most complete fuel combustion possible ensures maximum energy use, which thereby reduces fuel use.

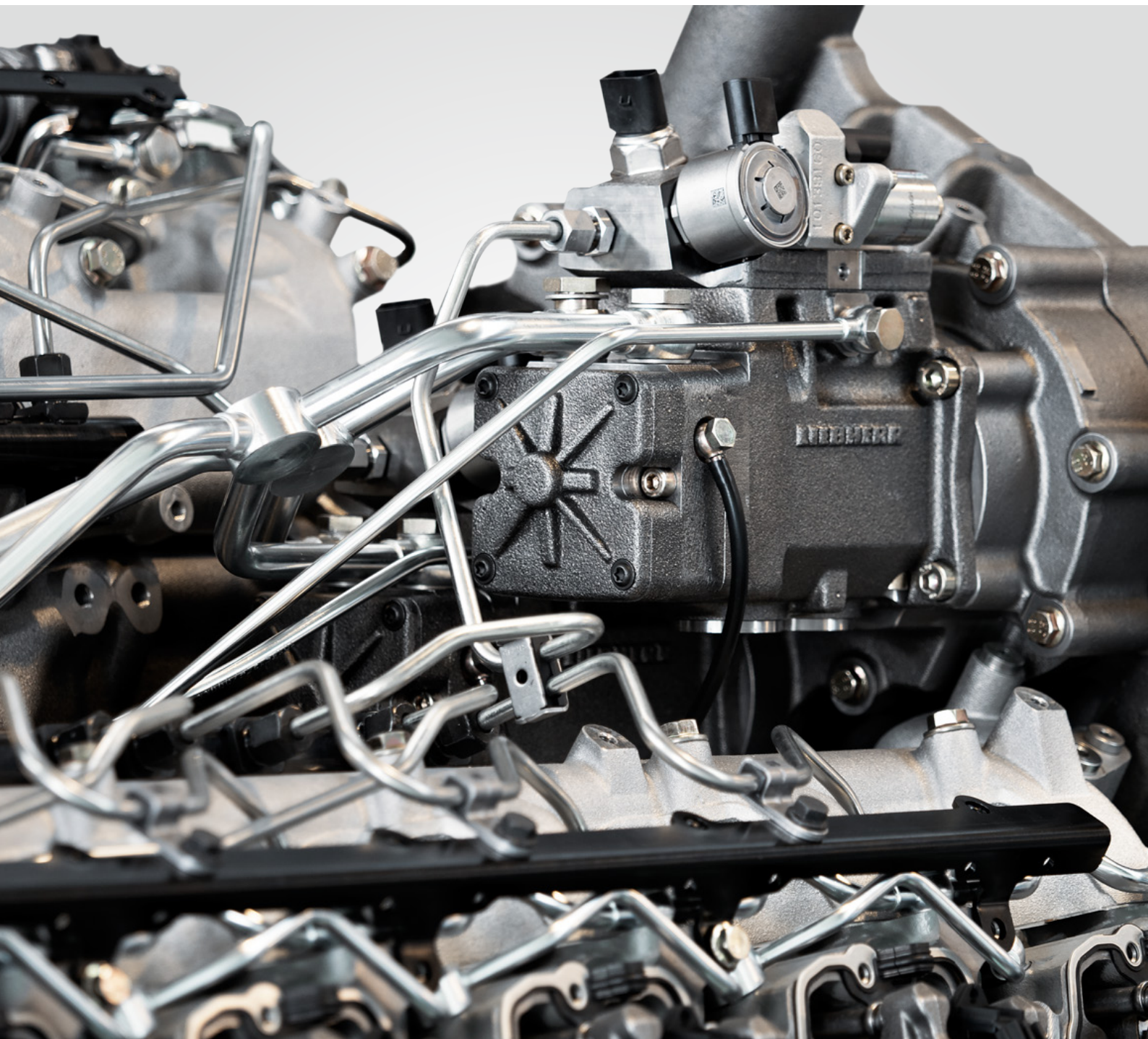

Optimal fuel efficiency for your engines

High degree of efficiency

Efficient energy conversion from the high pressure generation up to the injection pressure is decisive for a high degree of efficiency of the injection system. Liebherr uses many design measures to connect the injector nozzles throttle-free, if possible, to the high pressure pipe system, for example hole filters.

Stable multi-point injection

With multiple injection, pre-injection is very important for quiet engine operation, the main injection is important for optimal power development and maximum torque, and post-injection is important for reduction of emissions.

The 3-way servo valve ensures that the injection spray is established moderately. Finally, the injection process is completed by closing the nozzle needle very quickly. This results in a very clear boundary for the individual injections and a precisely measured fuel amount – both of which are decisive factors for an optimal combustion process, low fuel consumption and minimum raw emissions.

Minimum switching leakage

Liebherr injectors are set apart by their very small amount of switching leakage. In the case of system injectors for engines with a capacity of up to 2 litres per cylinder, at full load it is a maximum of 30 ml/min. This provides the following advantages:

- higher degree of efficiency and therefore lower fuel consumption
- lower leakage temperatures, therefore lower cooling requirements
- good tolerance of various fuel qualities
- optimal preconditions for start-stop operation – as the system pressure is still maintained when the engine is shut off, restarting is accelerated

3-way servo valve

The injector has an additional hydraulic intermediate valve with which the nozzle needle can be closed very quickly and, independently of that, can be opened with adjustable speed.

Quantity engine characteristic map

At pressures from 200 to 2,200 bar, the quantity characteristic curves of the Liebherr injectors excel by very high linearity, i.e. uniform injection amounts.

Injection rates

The chart shows the fuel supply during the injection process at various opening speeds of the servo valve depending on a set pressure of between 200 and 2,200 bar. Closing takes place independently.

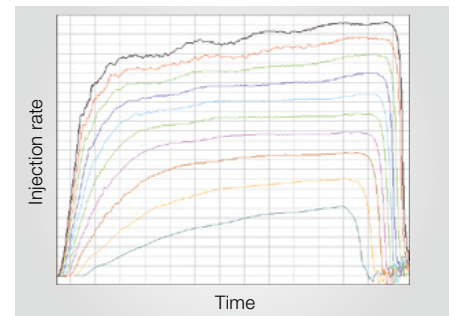
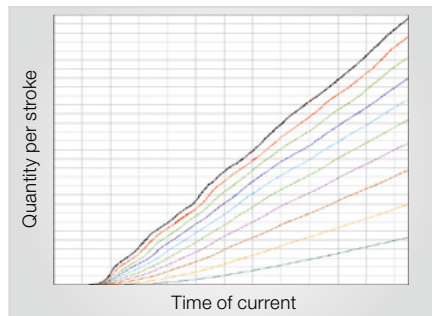

Engineering expertise

Simultaneous engineering concepts are used in development of the Liebherr injection system. Modern development tools such as the Finite Element Method (FEM) and Computational Fluid Dynamics analysis (CFD) contribute towards the con-

stant optimisation of the system and its modules. This enables Liebherr to provide its customers with a reliable state-of-the-art complete system.



State-of-the art methods for stable power and high load capacity

Product validation

All components in Liebherr Common Rail systems are subject to a thorough and comprehensive validation program. This is oriented on excellent system reliability and availability under demanding environmental conditions, as well as towards a long product service life.

It contains advanced models for damage modelling that use accelerated testing in endurance tests, mechanical strength tests, temperature tests and environmental tests to reproduce the ageing process of components.

Sophisticated statistical data analyses are used to ensure that the selected samples are representative for all components.

Field trials are also a key element of the validation process. They are primarily used for verifying simulations of the underlying data and accordingly modifying the validation tests.

Engineering methods

Many components of a fuel injection system are subjected to cyclic loads. When testing with FEM, particular emphasis is placed on determining and then optimising fatigue resistance.

All Common Rail system components are also inspected intensively by calculation engineers with CFD analyses to model flow effects inside components and incorporate the findings in the design.

Development test bench

Liebherr Common Rail systems are subject to comprehensive endurance tests on special test benches during development. Accelerated testing examines the ageing process of the system and single components.

Finite Element Method (FEM)

The FEM design not only determines fatigue resistance, but stress and deformation are also inspected under operating and peak loads, and component geometries are adapted accordingly.

CFD simulation

CFD analyses made minimisation of the effect of cavitation erosion on nozzle needles and nozzles possible; cavitation erosion results from the very high flow speeds.

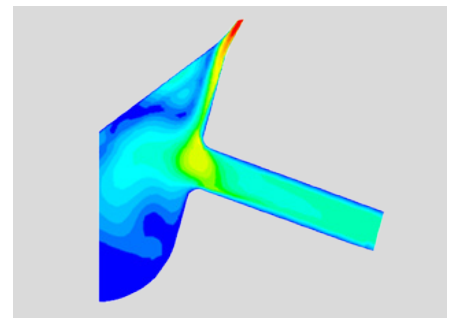
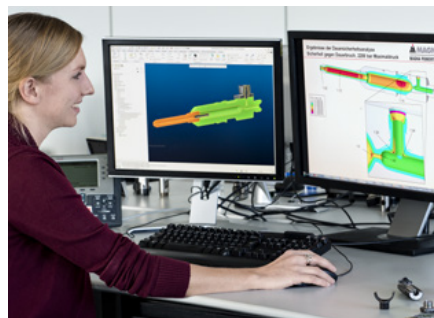
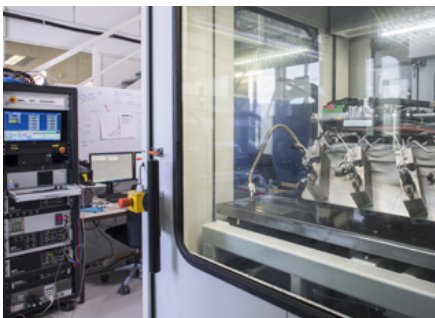

Precision parts from in-house production

Liebherr Common Rail and engine management systems are developed and manufactured at three sites in Switzerland and Germany. Whilst engine control units are produced in

Lindau, Deggendorf is the competence centre for production of micro-precision parts. The assembly lines for injectors and high pressure pumps are in Bulle, Switzerland.



Flexibility for every customer requirement

Micro-precision manufacturing

The geometry of the nozzle hole and its process-reliable manufacturing are especially important for the required fine fuel nebulisation. Therefore Liebherr has introduced Electrical Discharge Machining (EDM) and Hydro Erosive Grinding (HEG) manufacturing processes at a dedicated micro-precision manufacturing site.

Assembly in a clean room

Extreme care is necessary during assembly to ensure the functional capability of the high-precision parts in the Common Rail system. The parts must be absolutely dust and oil-free, therefore they are cleaned in four separate washing cycles. High pressure pump, high pressure connector and injector components are assembled in a class 7 clean room after acclimatisation to ensure absolute precision during assembly.

Assembly monitoring

On the assembly line, which is configured for series production and largely automated, all manual process steps are monitored by the system technology. Operating errors are practically eliminated by the intelligent quality management system (Poka Yoke).

High parts availability

Large investments in modern production and test facilities enable fast start-up times for series production. For maximum flexibility, the latest knowledge about material flow and other process sequences were taken into account when constructing the facilities. High parts availability provides the foundation for optimum customer support.

Electrical Discharge Machining

To ensure it can reliably maintain tolerances of a few μm , Liebherr uses the electrical discharge machining process based on spark erosion in the production of injector components.

Hydro Erosive Grinding

At its Deggendorf site, Liebherr has many years of experience with hydro erosive grinding. It is used primarily to round injector nozzle holes and exactly set the flow rate.

Injector assembly

The injectors assembled in the clean room are subjected to various tests as early as during assembly, for checking fitted O-rings for example.

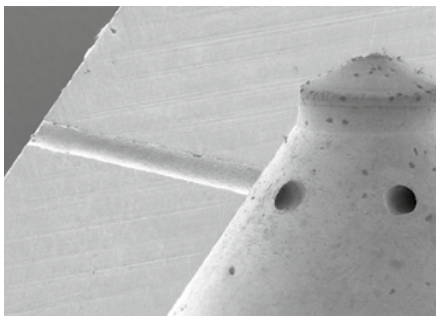

Comprehensive quality assurance

Uncompromising quality assurance is indispensable for the high reliability and availability of fuel injection systems. Liebherr uses an up-to-date computer-assisted quality management system (CAQ system) that is implemented as early

as the production creation process and covers the entire product life cycle. Efficient test benches, often specially developed for Liebherr, are used in testing the high precision components.

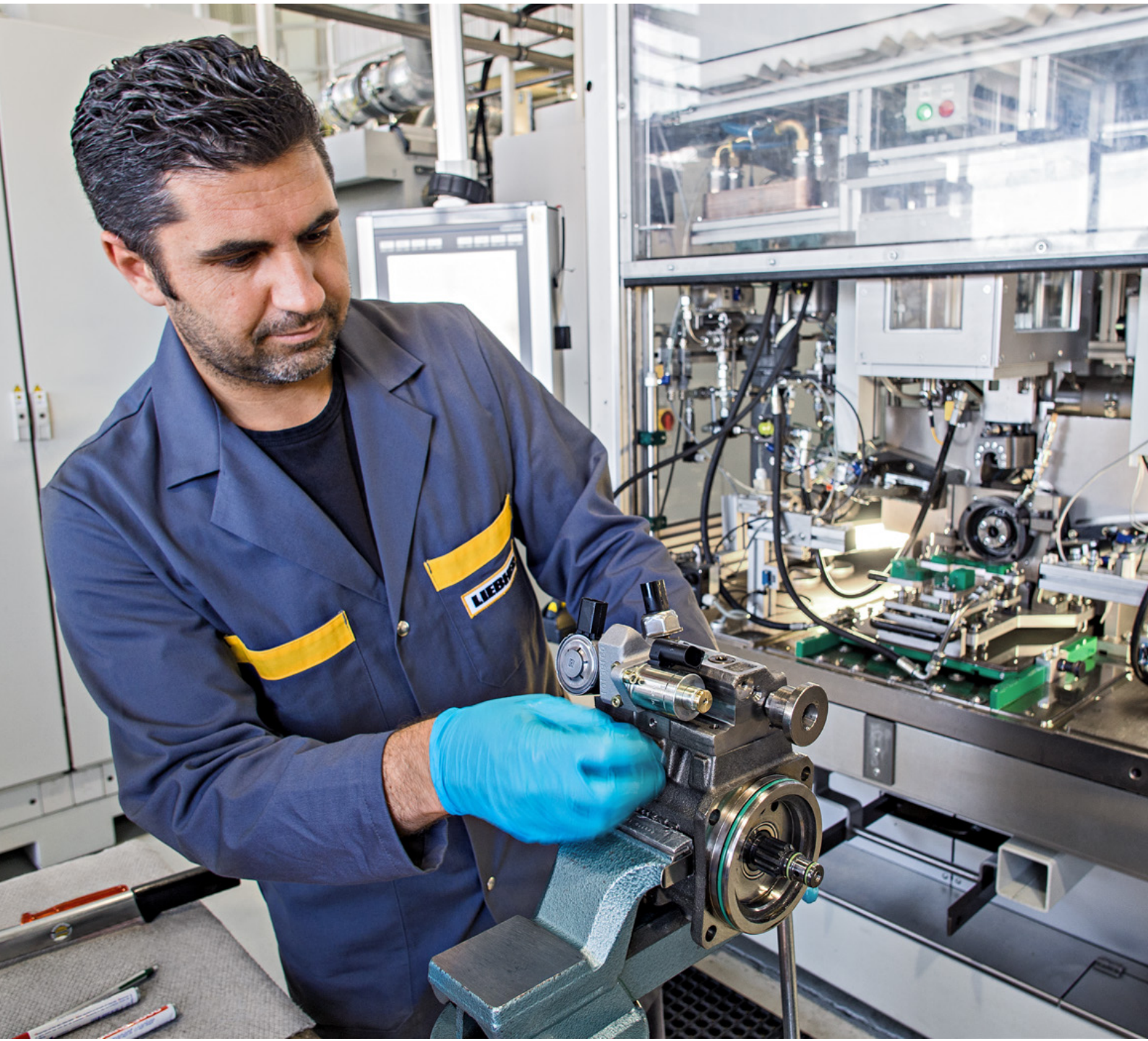

Lifetime reliability

Comprehensive controls on incoming material

In the incoming goods department, all purchased parts of the Common Rail fuel injection system are checked for their highest quality with the aid of highly modern measurement instruments. These include, for example, 3D coordinate measuring devices, roughness and contour measuring systems as well as an optical surface scanner.

Series testing

Before delivering the fuel injection systems, the high pressure pumps, injectors and high pressure connectors are tested 100% for functional and service life-relevant quality features, such as flow rate, torque or leakage. The Data Matrix Code (DMC) is used to track the assembled parts and assign them to the corresponding system components

Leak test bench

Injectors, pressure pipe connections and high pressure pumps are subjected to a leak test on the leak test bench at multiple stages up to 2,200 bar. This ensures there is no leakage to the outside or within the system on the high-pressure sealing surfaces.

Highest quality standards

Quality assurance is certified according to DIN EN ISO 9001 / 2008 and complies with VDA standards (reliability control group). The Bulle site will be certified according to ISO TS 16949 in 2016, the Deggendorf site from 2017. Statistical assessments, FMEA (failure mode and effects analyses) and CIP (Continuous Improvement Processes) are examples of a consistent process philosophy.

Spray pattern test bench

With the aid of a camera, the test bench measures the geometry of the spray pattern of the injector. Due to the very high speed of the injection process this places high demands on the measurement system as well as on the synchronisation of the measurement and control loop.



Injector leak test

With the aid of a camera system, the leak tightness of the nozzle and nozzle needle is checked. In the process, the camera records any drop formation on the nozzle which is subjected to high pressure.



Geometry measurements

Modern measurement instruments are used to measure the geometry of the Liebherr Common Rail system parts. The photo shows the evaluation of the round surface of the control valve.

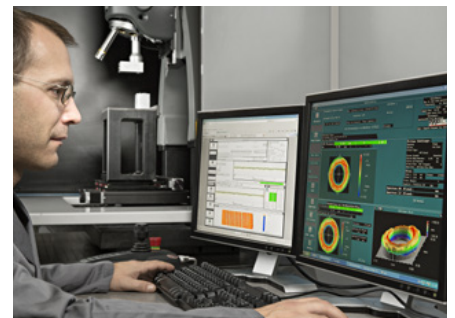

System solutions

Liebherr delivers complete injection systems consisting of a high pressure pump, high pressure connectors, injectors and electronic control unit (ECU). Professional application engi-

neers support engine manufacturers in the integration of hydraulic and electronic components in their units. In doing so, they draw on decades of experience with applications.

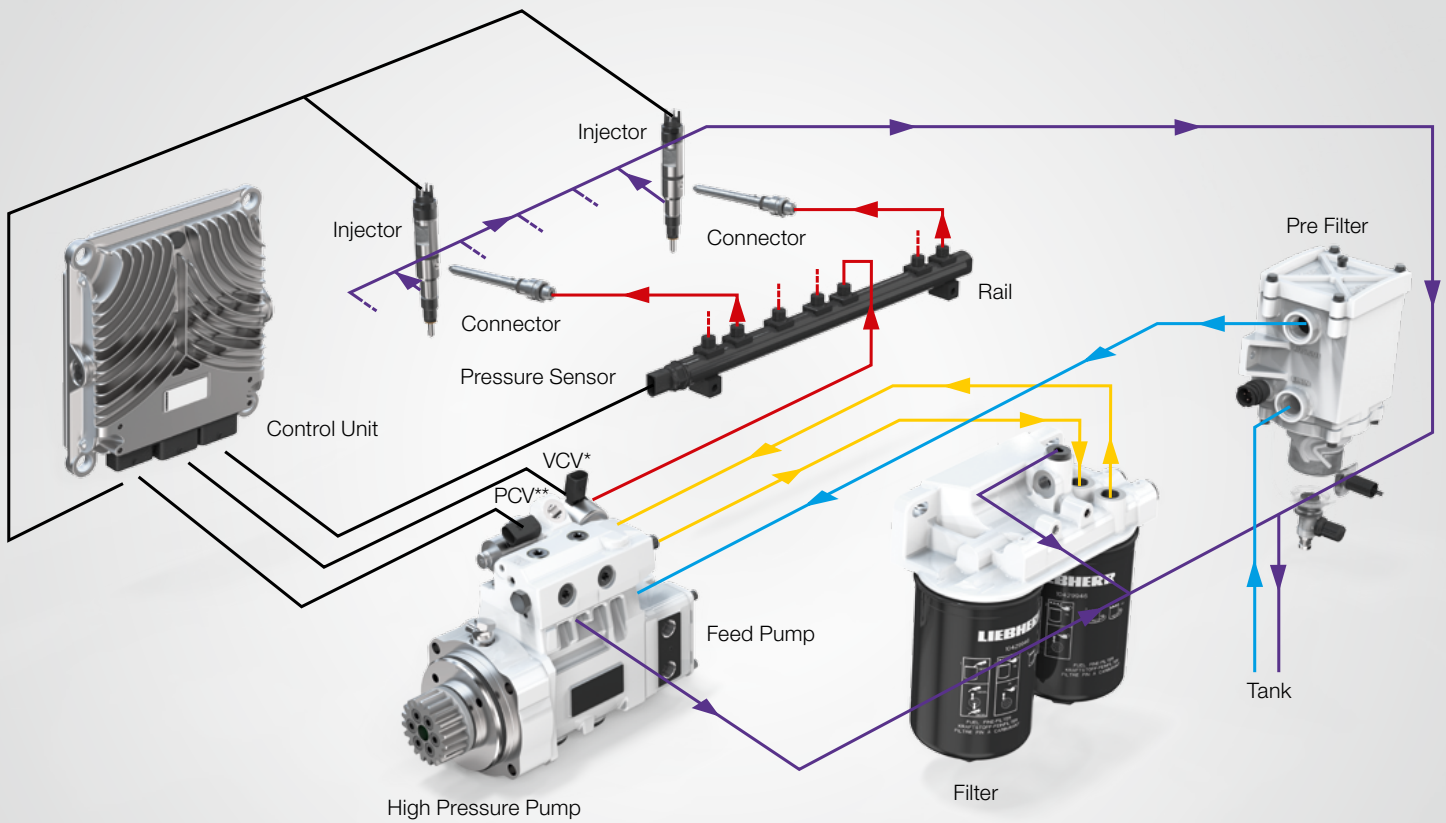

- Low pressure
- Pressure after prepump
- High pressure
- Low return pressure
- Electronic control

*Volume Control Valve **Pressure Control Valve

Your partner for complete integration

System integration

Intelligent system integration is the link between mechanical, hydraulic and electronic components; it ensures the perfect interplay and correct design of the complete system. The injection system is optimised for different emissions standards, low consumption or the highest engine performance according to the requirement. For every customer the required injection and pressure control functions are defined, the necessary diagnostics and correction algorithms are developed and an application-specific data set is provided and validated.

Product validation

All components are specifically designed for the highly dynamic loads in on- and off-highway uses. A detailed product validation plan is worked through in the development and application processes so that specific customer requirements are incorporated optimally. In addition to endurance testing with variable load profiles, this also includes various environmental tests. Series production is only authorised after the various validation phases have been successfully completed.

Optimal control and monitoring

Comprehensive functions and configuration options of the engine control unit ensure optimal control of the fuel injection system for reliable engine operation. The fuel injection timing and the fuel amount are calculated individually for each cylinder, so that the injector's solenoid valve can be correspondingly actuated. The control signal and number of injections are adapted to the requirements of each engine and application.

High pressure pump

A 2-cylinder in-line pump with an oil lubricated crankcase is used for engines with a capacity of up to 3 litres per cylinder. An active high-pressure valve provides protection against overpressure by absorbing undesired pressure peaks



Injector

Injectors with a solenoid-drive developed and manufactured in-house guarantee injection pressures of up to 2,200 bar and ensure extremely fine fuel spray.



Engine management

The engine control unit optimises injection start and duration in real-time. This makes the optimum management of fuel combustion possible in every operating point.



Common Rail System 11.2



For engines with a displacement up to 3 litres per cylinder

Liebherr has developed the 11.2 system for engines with a total output of 120 kW up to a maximum of 1,000 kW. The second generation of the Common Rail system 11.2 is available as a side-feed version as well as a top-feed installation. This means customers will have a suitable system for all common engine geometries and installation spaces. The 2-cylinder in-line pump with oil lubricated crankcase delivers 300 litres of fuel at 2,200 bar per hour. The injectors deliver

a maximum full load injection volume of 600 mg with reliable multiple injection. The nozzles can be adapted to the requisite engine performance from a broad flow rate range. The flow rate range is between 600 and 2,200 ml in 30 sec. This broad spectrum also makes it suitable for high performance engines.



Main features	CRS 11.2
System pressure	250–2,200 bar
Number of injections	5
Rate shape	Ramp/square
Hydraulic flow rate	600–2,200 ml/30 sec
Nozzle diameter	7 mm/9 mm
Max. injection quantity	430 mm ³ (370 mg)/700 mm ³ (600 mg)
Max. pump speed	4,000 rpm
Max. hydraulic flow (pump)	300 l/h
Displacement	2–3 l/cyl
Engine power/displacement	69 kW/cyl
Emissions compliance	EU Stage IIIb/EPA Tier 4f/EPA Tier 4i/EU Stage IV/Euro V/Euro VI
Control leakage/injector	< 40 ml/min at 2,200 bar
Injector configuration	Side feed/top feed
Engine control unit	ECU 2HD/ECU 3
Areas of application	Agriculture and forestry/Building construction and civil engineering/Decentralised energy systems/Maritime applications

Common Rail System 11.5

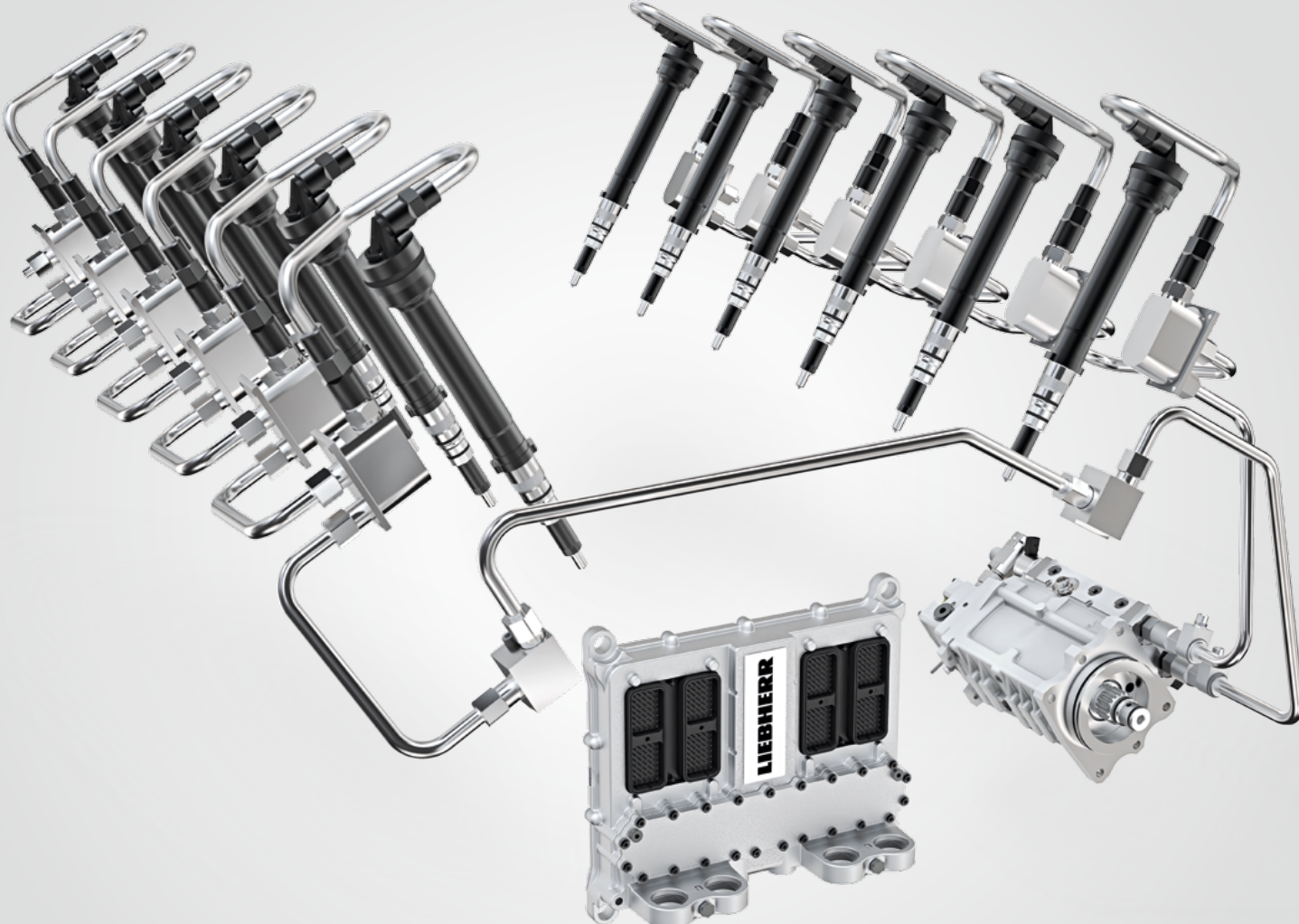

For engines with a displacement up to 6 litres per cylinder

Liebherr offers the 11.5 system for large engines with an output range between 1,000 kW and 5,000 kW. The injectors make a maximum injection quantity of 1,200 mm³ or 1,000 mg available per cycle, ensuring a reliable fuel supply to engines with a power output of up to 240 kW per cylinder. Two high pressure pumps are available – the 5-cylinder in-line

pump delivers 825 litres of fuel at 2,200 bar. Delivery is up to 900 litres per hour for the 6-cylinder pump. Both pumps are lubricated with oil instead of fuel. This makes the pump service life independent of the fuel quality.

Main features	CRS 11.5
System pressure	250–2,200 bar
Number of injections	3
Rate shape	ramp/square
Hydraulic flow rate	1600–4,000 ml/30 sec
Nozzle diameter	13 mm
Max. injection quantity	1,200 mm ³ (1.000 mg)
Max. pump speed	4,000 rpm
Max. hydraulic flow (pump)	825 l/h
Displacement	4–6 l/cyl
Engine power / displacement	240 kW/cyl
Emissions compliance	EPA Tier 2/IMO III/ TA Luft/EPA Tier 4f
Control leakage/injector	< 50 ml/min at 2,200 bar
Injector configuration	Top feed
Engine control unit	ECU 2HD/ECU 3
Areas of application	Building construction and civil engineering / Decentralised energy systems / Maritime applications / Mining / Railway



Injector S3 for the 11.5

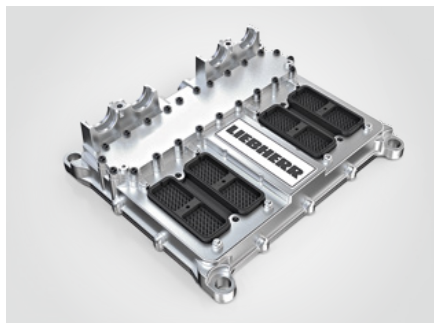

System engine control unit ECU 2HD

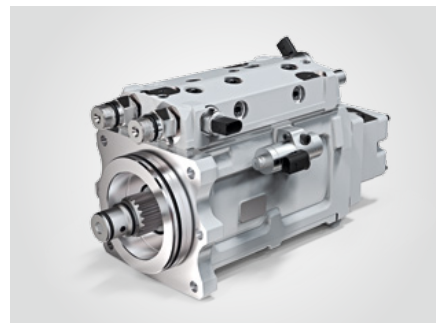

High pressure pump LCRP 11.5 with five pistons (6 pistons also possible)

Engine management

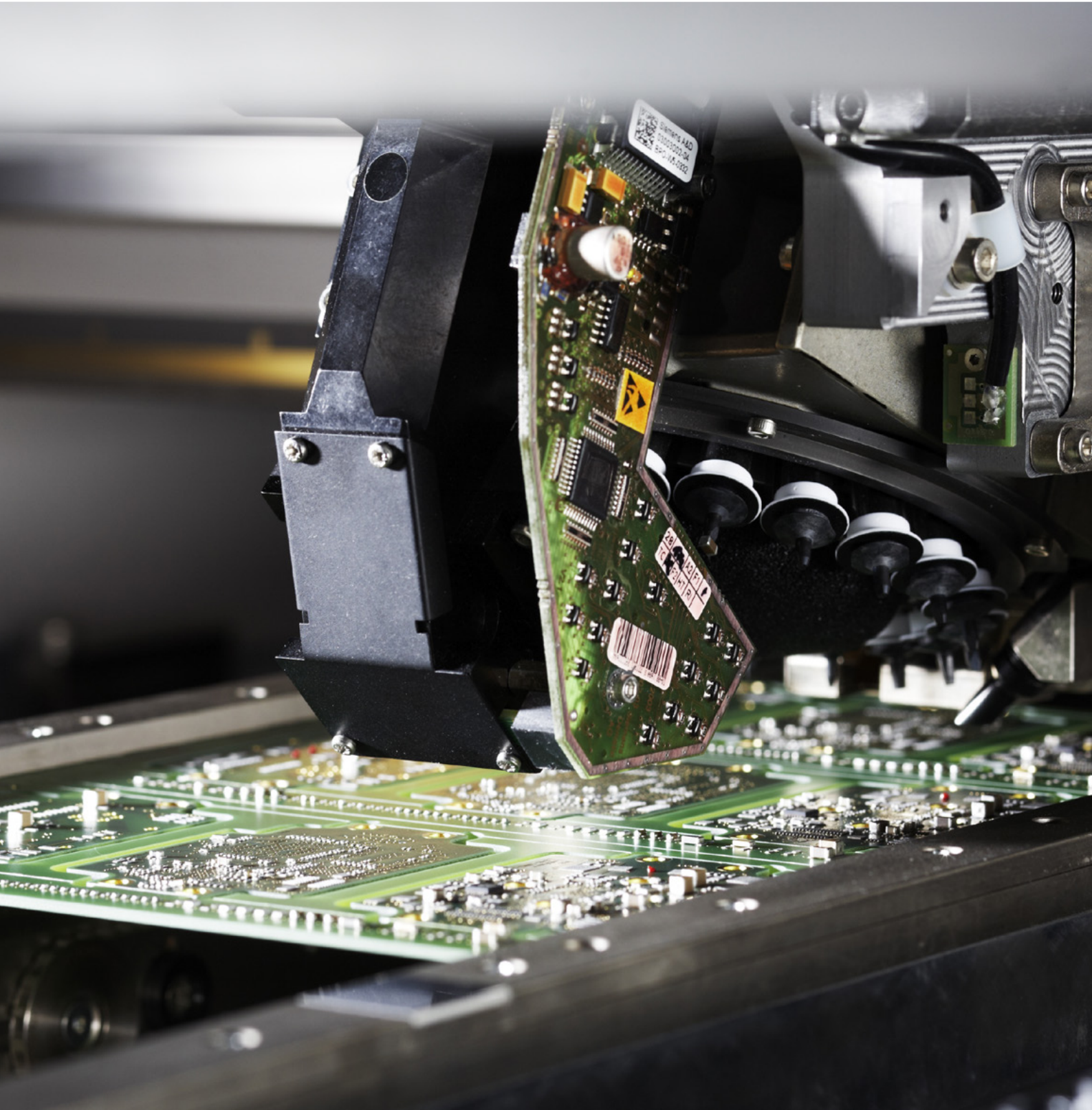

Optimal control of the main engine functions

Flexible system

The Liebherr engine management system records numerous physical engine variables for optimal control of the fuel injection system. The engine data is processed in the control unit using configurable mathematical models. This allows adjustment of the control system to different numbers of cylinders and displacements. On engines with a Liebherr exhaust aftertreatment system the ECU also regulates the necessary functions. In addition to the engine control unit, Liebherr also offers an application and diagnostics program to give optimal support to the applications engineer as well as the service employee.

ECU 3

- Platform for Euro V/VI and Stage IV/Tier 4 final
- Engine control unit for 4- and 6-cylinder engines
- High self-diagnosis
- Second internal shutdown path for power outputs
- Suitable for use in extreme environmental conditions
- Optimised cooling concept with air and optional fuel cooling
- Molex CMC connector
- IP6K9K protection class when connected

Continuous system monitoring

The 97/68 EC and USA EPA CARB emissions standards make continuous engine system monitoring possible. The engine controller from Liebherr is ideal for monitoring and controlling various exhaust aftertreatment systems such as particulate filter or SCR catalytic converter and exhaust gas recycling.

ECU 2HD

- Platform for Euro V/VI and Stage IV/Tier 4 final
- Engine control unit for engines with up to 12 cylinders
- Master/slave operation for engines with up to 20 cylinders
- High self-diagnosis
- Second internal shutdown path for power outputs
- Suitable for use in extreme environmental conditions
- Concept with air and optional fuel cooling
- Deutsch DRC connector
- IP6K9K protection class when connected or disconnected

ECU 3

The engine control unit ECU 3 was developed as an economic and functionally optimised engine control unit for 4- and 6-cylinder engines. It is designed for on- and offroad use and also controls the exhaust gas aftertreatment system.

ECU 2HD

The ECU 2HD engine control unit controls up to 12 injectors. Up to 20 injectors are possible in master-slave mode. It can be operated with and without fuel cooling.

Application /diagnostics program

With the application /diagnostics software developed by Liebherr, the engine parameters can be optimally adjusted to the application, and errors can be read out and analysed. The diagnostics software is efficient and easy to learn.

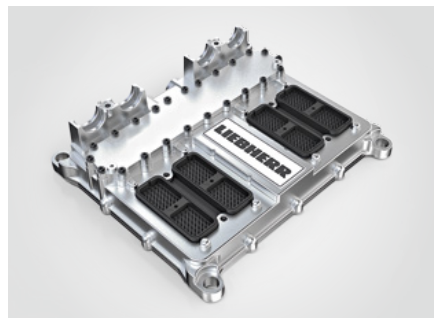

Examples of use for System 11.2



The Common Rail system 11.2 was developed primarily for off-road applications, but it is also suitable for heavy-duty on-road applications. It supports all current emissions standards and is optimised in particular for Euro V and VI as well as Stage IV and V.

It is extremely sturdy and reliable making it ideal for engines used in construction machinery and cranes, mining equipment, material handling, agricultural and forestry machinery and special vehicles. It is also very suitable for stationary applications such as gensets due to its high efficiency. With its two installation variants, top-feed and side-feed, the system is suitable for every engine geometry and available installation space.

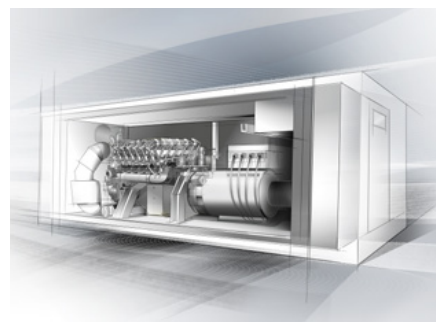
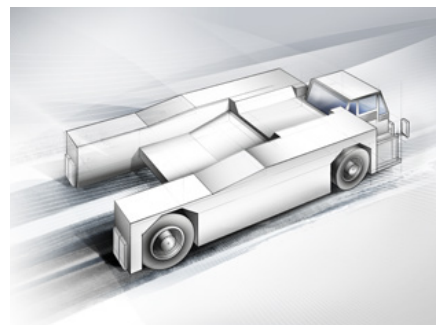
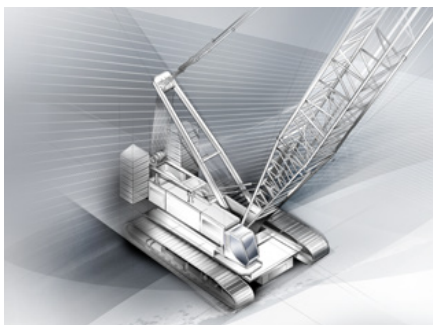

Examples of use for System 11.5

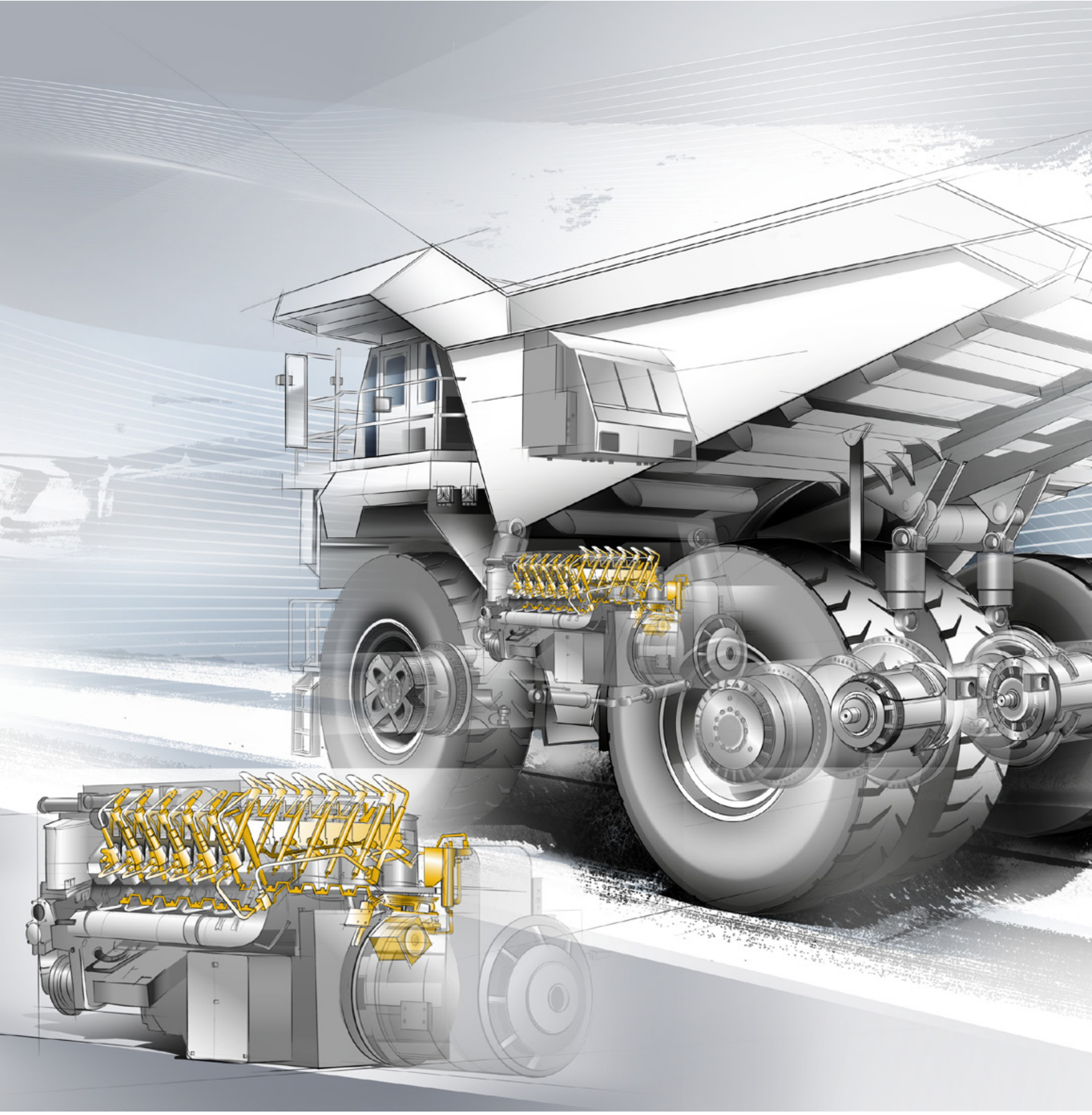

Customers can choose the Liebherr Common Rail system 11.5 for engines larger than 1,000 kW. Engines can be used equally for mobile applications, such as mining equipment, or in railway infrastructure vehicles, maritime applications and stationary applications such as gensets.

The high degree of system modularity gives customers great integration flexibility in various engines. It provides the multiple injection capability to ensure optimum operating values with regard to performance and consumption. System 11.5 is very robust and designed for a long service life and maintenance intervals. It is also fully electronic controlled and supports compliance with current and future emissions standards.

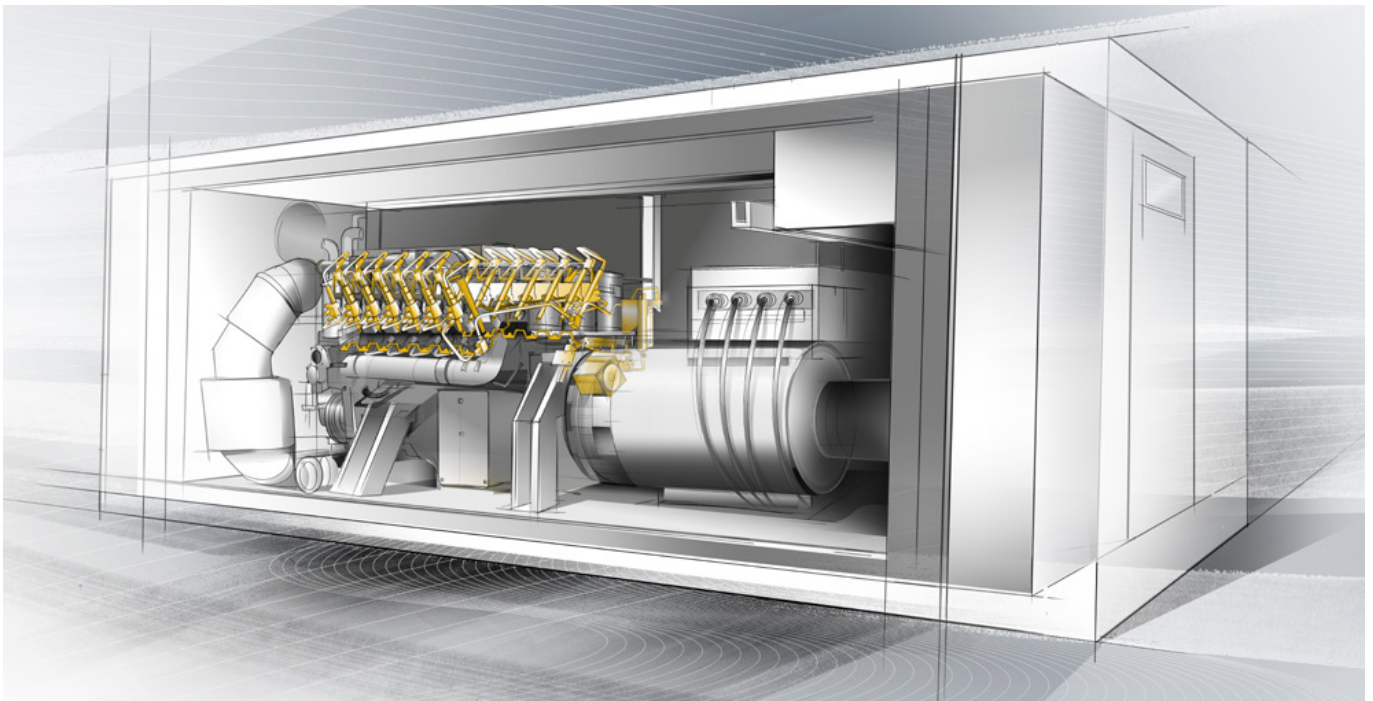
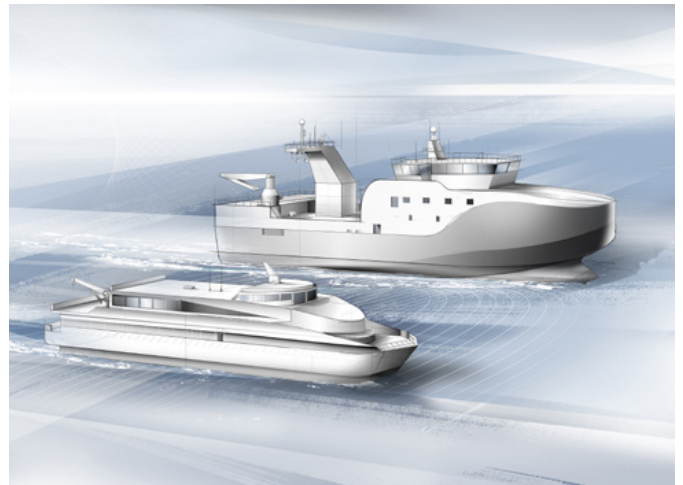

Liebherr Components

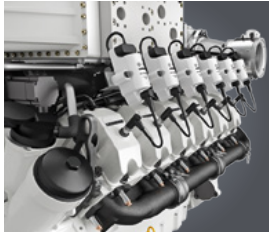

Diesel engines



Gas engines



Fuel injection systems



Axial piston hydraulics

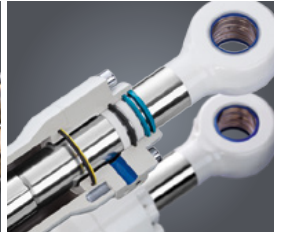

Hydraulic cylinders

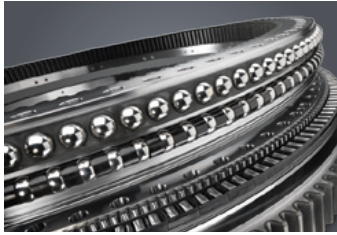

Large diameter bearings



Gearboxes and winches

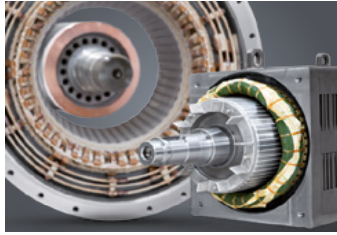

Electric machines



Remanufacturing



Display and operation units

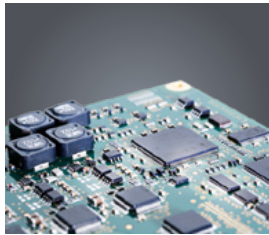

Control and regulation electronics



Power electronics



Switchgear



Software

From A to Z, the components division of the Liebherr Group offers a broad spectrum of solutions in the area of mechanical, hydraulic, electric and electronic drive system and control technology. The efficient components and systems are produced at a total of nine production sites around the world to the highest standards of quality. Central contact persons for all product lines are available

to customers outside the Liebherr Group at Liebherr-Components AG and the regional sales and distribution branches.

Liebherr is your partner for joint success: from the product idea to development, manufacture and commissioning right through to series production and remanufacturing.

www.liebherr.com

Sales worldwide
Liebherr-Components AG
 P.O. Box 222,
 CH-5415 Nussbaumen/AG
 ☎ +41 56 296 43 00
 E-Mail: info.cos@liebherr.com

Sales North America
Liebherr-Components North America Co.
 1465 Woodland Drive, Saline,
 MI 48176 USA
 ☎ +1 (734) 944 6334
 E-Mail: info.lcn@liebherr.com

Sales Russia
Liebherr-Rusland 000
 Office 2, Bolschoi Palaschewskij 13/2
 121104 Moscow, Russia
 ☎ +7 (495) 280 18 94
 E-Mail: info.components.lru@liebherr.com

Sales China
Liebherr Machinery Service (Shanghai) Co., Ltd.
 Building No. 1, 88 Ma Ji Road,
 200131, Shanghai Pilot Free Trade Zone, V.R. China
 ☎ +86 21 2893 8039
 E-Mail: components.china@liebherr.com