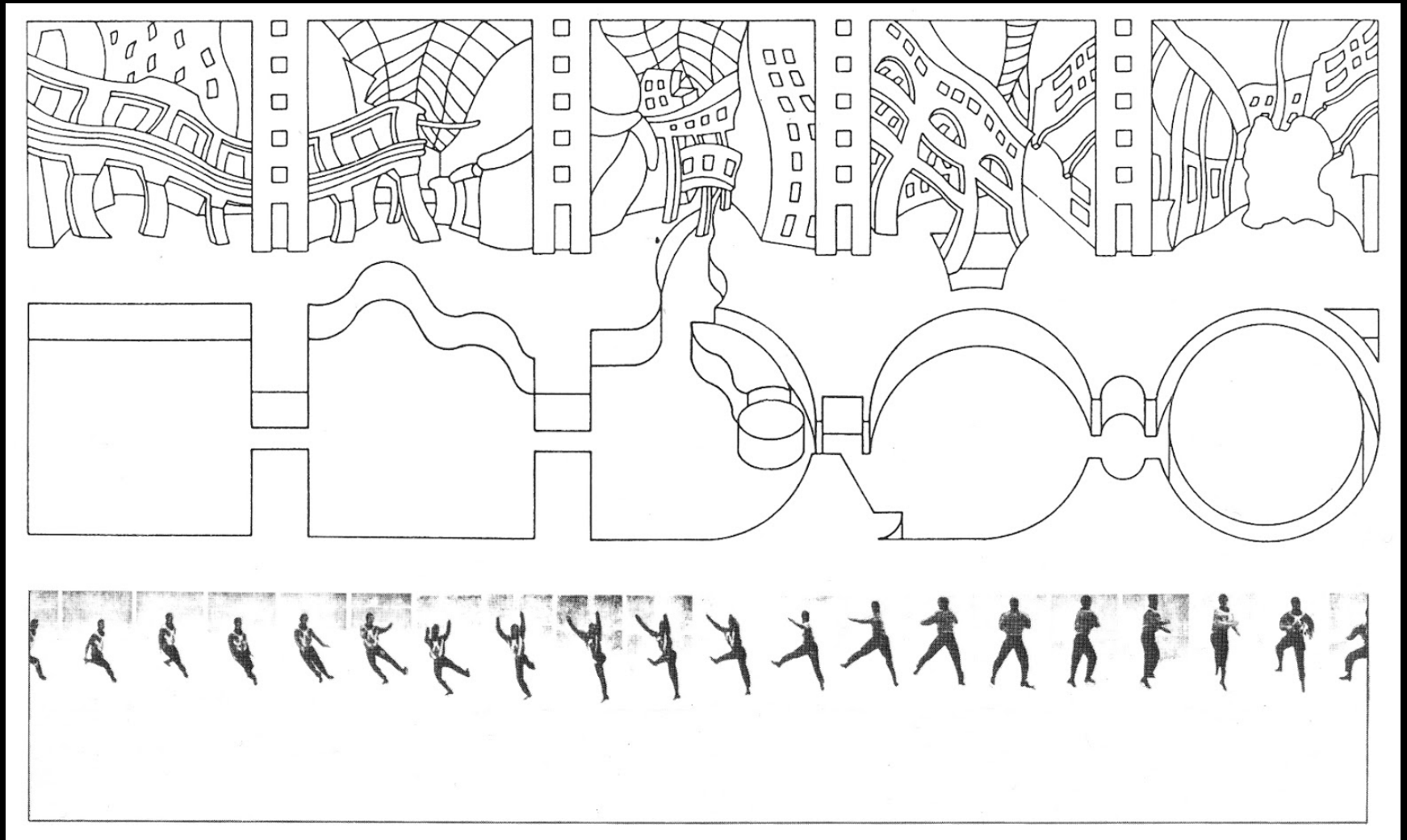


COMMUNICATING SEQUENCE

SEQUENCE



The Manhattan Transcripts _ Bernard Tschumi

SEQUENCE

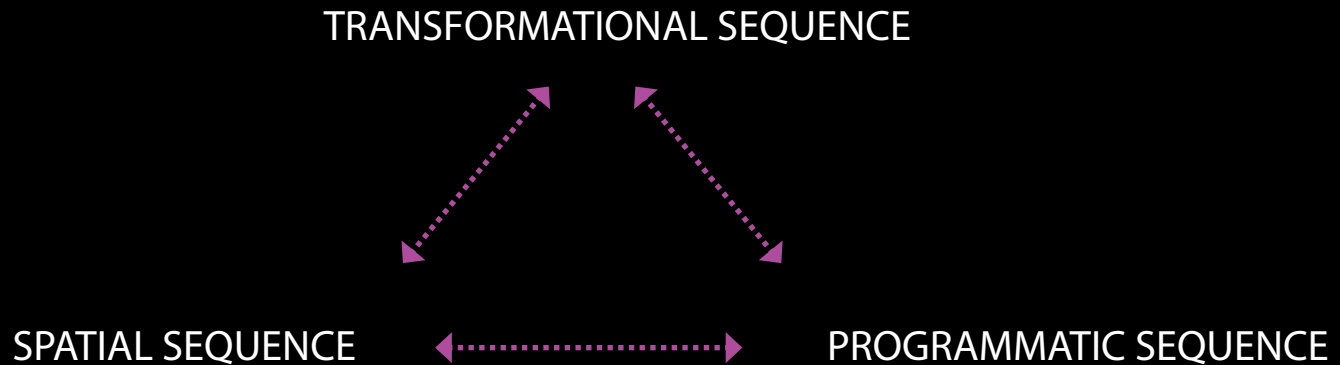
noun

: the order in which things happen or should happen

: a group of things that come one after the other

: a part of a movie, television show, etc., that deals with one subject, action, or idea

Merriam-Webster Online Dictionary



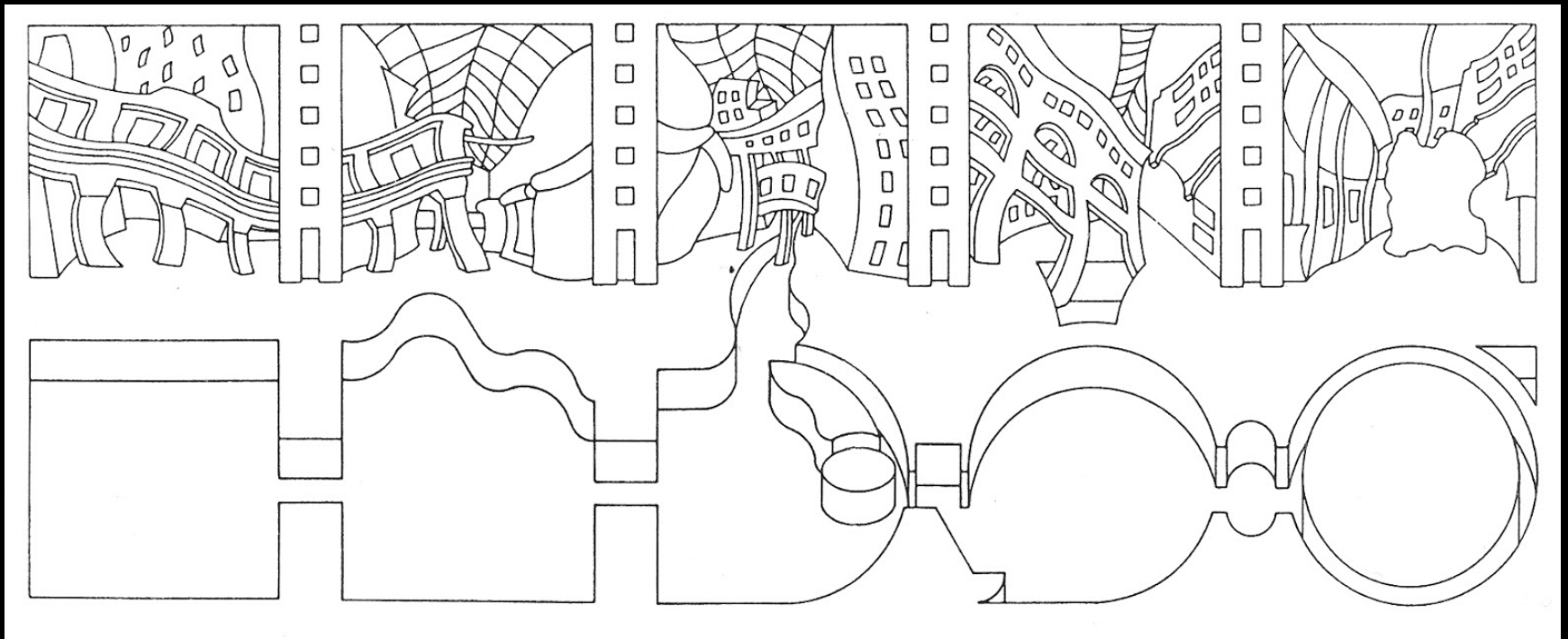
SPATIAL SEQUENCE

noun

: the juxtaposition, relationship, or organization of physical spaces

: an external relationship

Tschumi, Bernard. "Sequences". *Architecture and Disjunction*. 1994. Cambridge: MIT Press.



PROGRAMMATIC SEQUENCE

noun

: the juxtaposition, relationship, or organization of program, occurrences, activities, or events

: an external relationship

Tschumi, Bernard. "Sequences". *Architecture and Disjunction*. 1994. Cambridge: MIT Press.



TRANSFORMATIONAL SEQUENCE

noun

: relies on devices, procedures, operations, or rules of transformation

: an internal relationship

Tschumi, Bernard. "Sequences". *Architecture and Disjunction*. 1994. Cambridge: MIT Press.



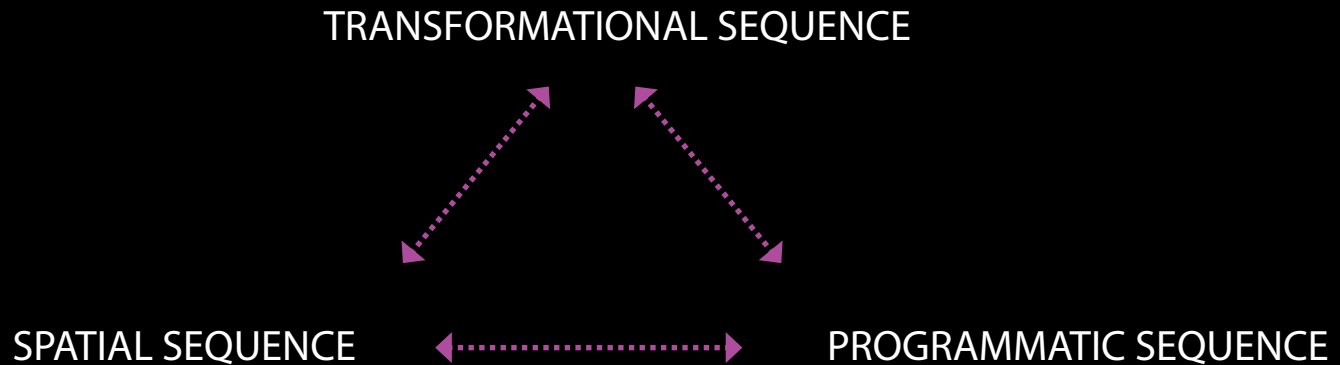
FRAME

noun

: a moment(s) in the sequence

: relates to Spatial, Programmatic, and Transformational Sequences

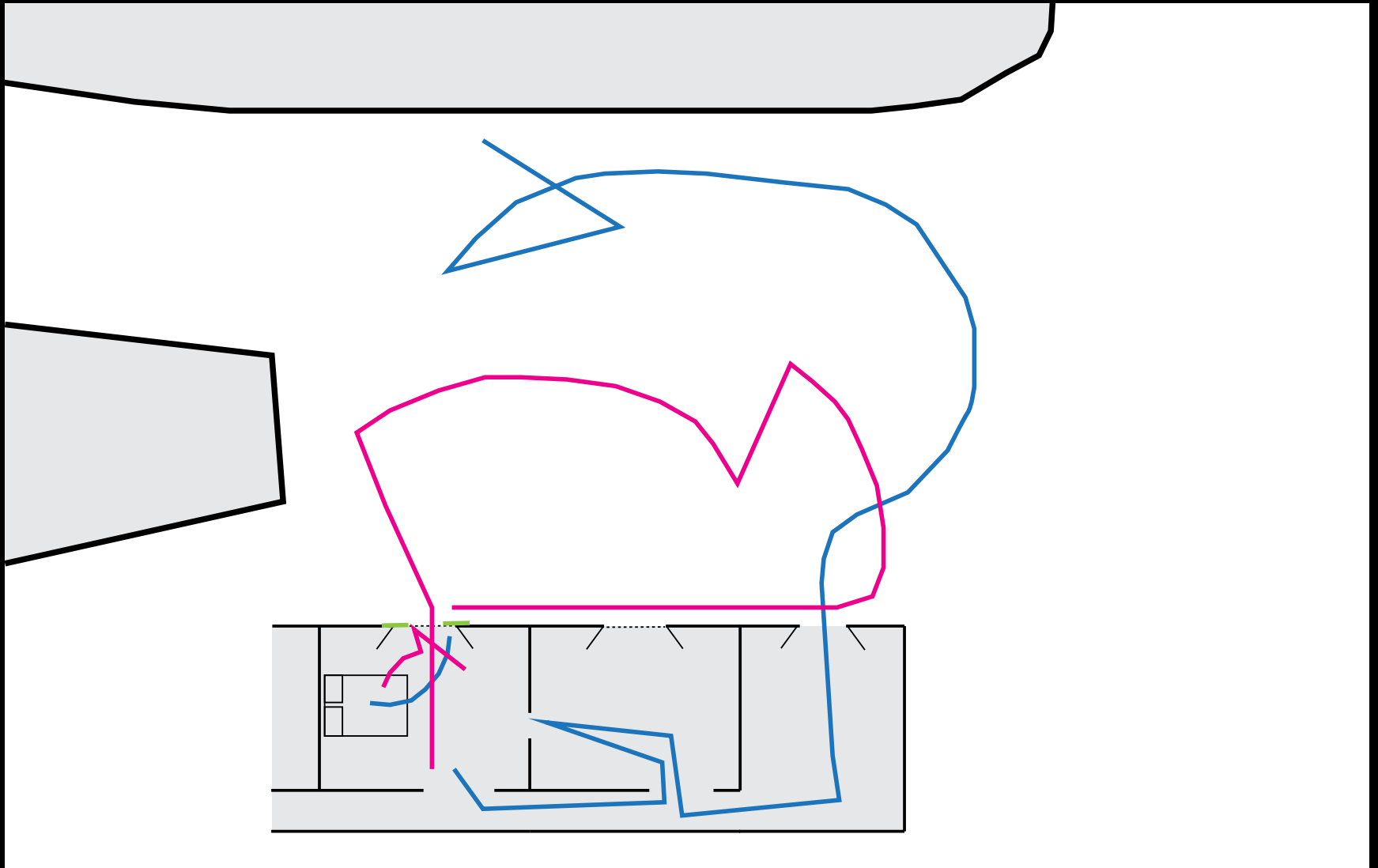
Tschumi, Bernard. "Sequences". *Architecture and Disjunction*. 1994. Cambridge: MIT Press.



THE PASSENGER BY MICHELANGELO ANTONIONI

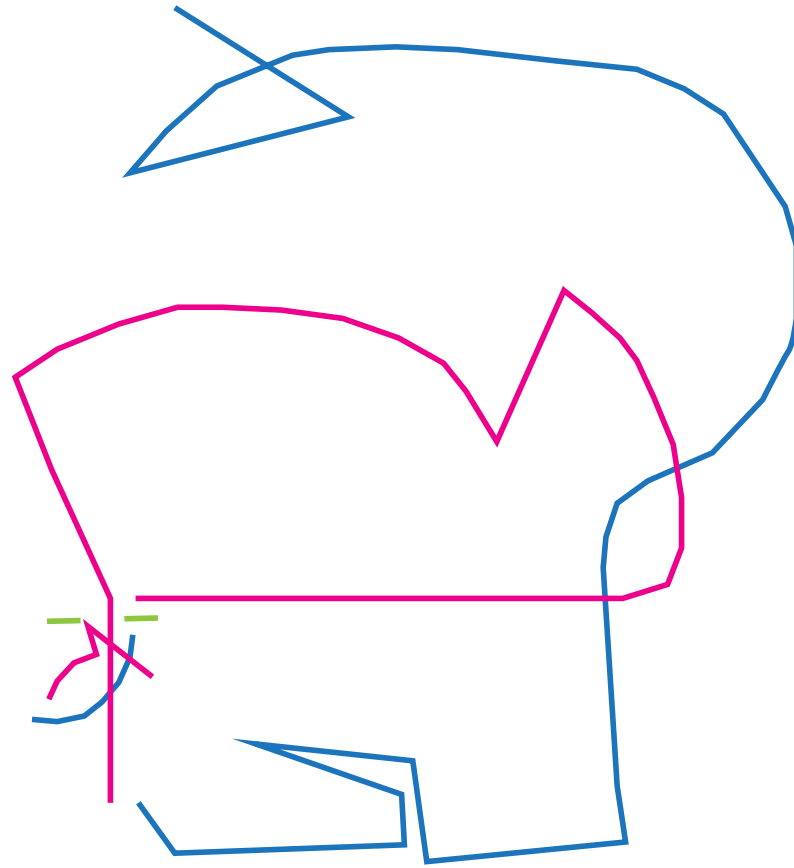


THE PASSENGER BY MICHELANGELO ANTONIONI



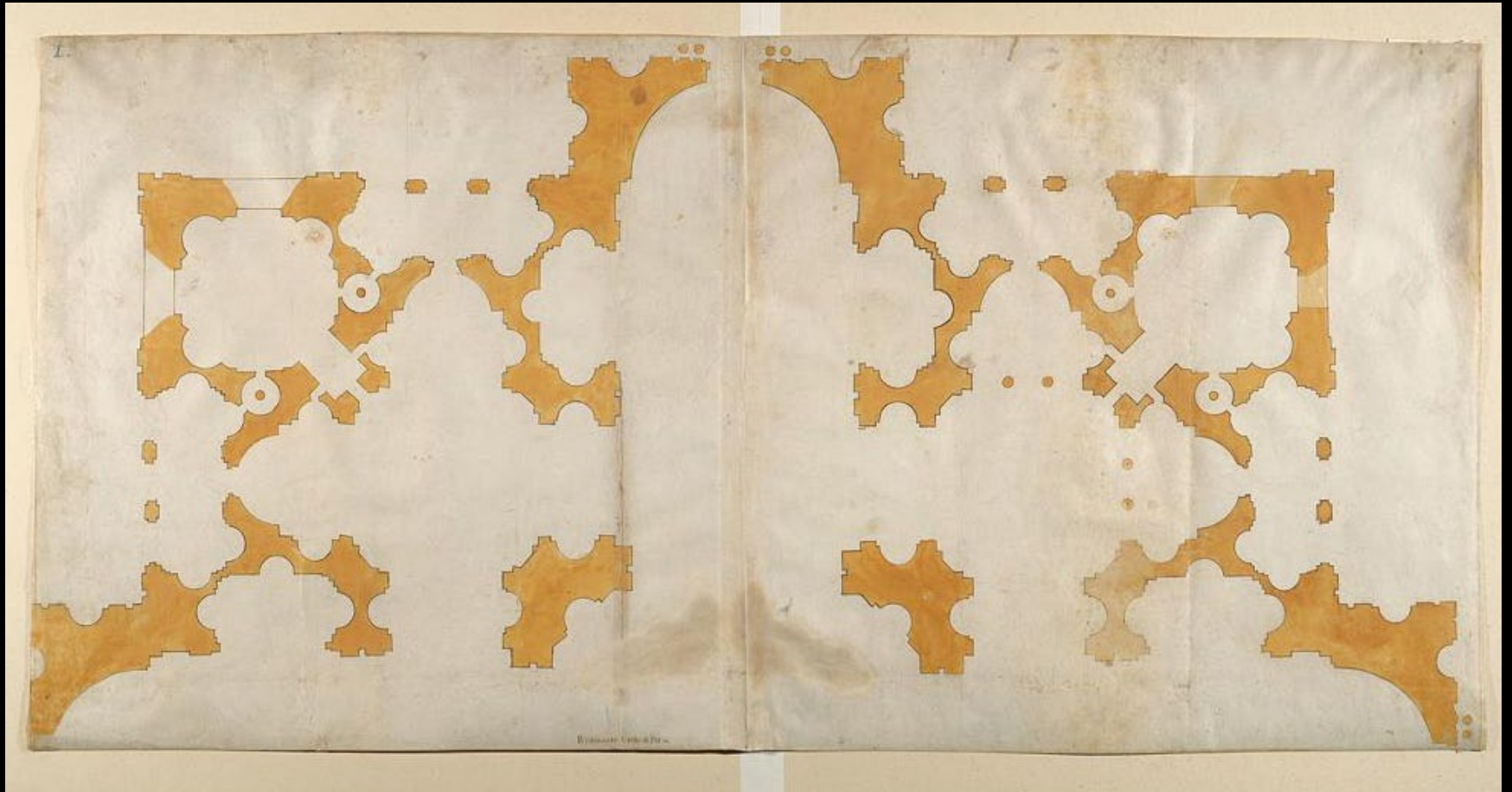
Spatial Sequence

THE PASSENGER BY MICHELANGELO ANTONIONI



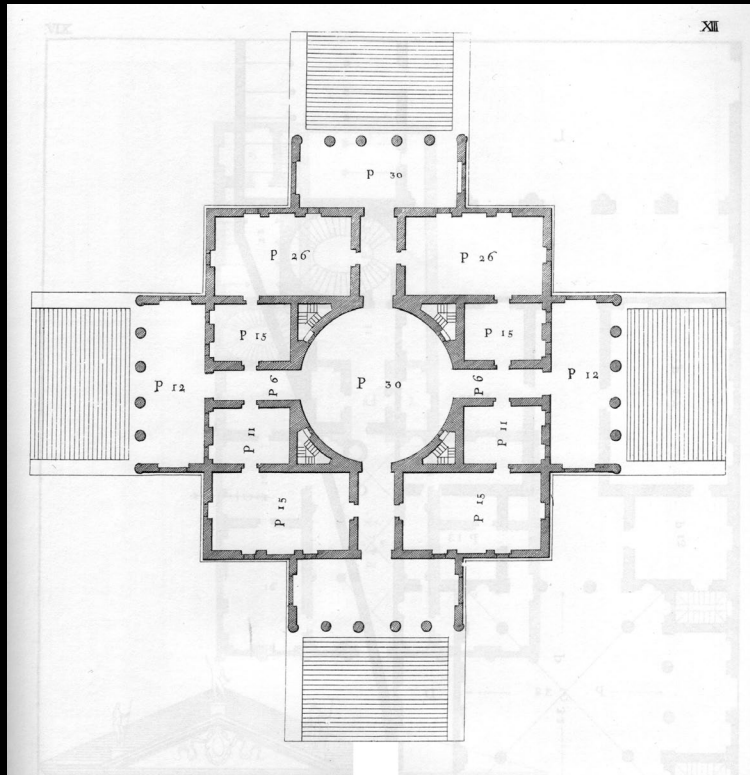
Programmatic Sequence

SPATIAL SEQUENCE

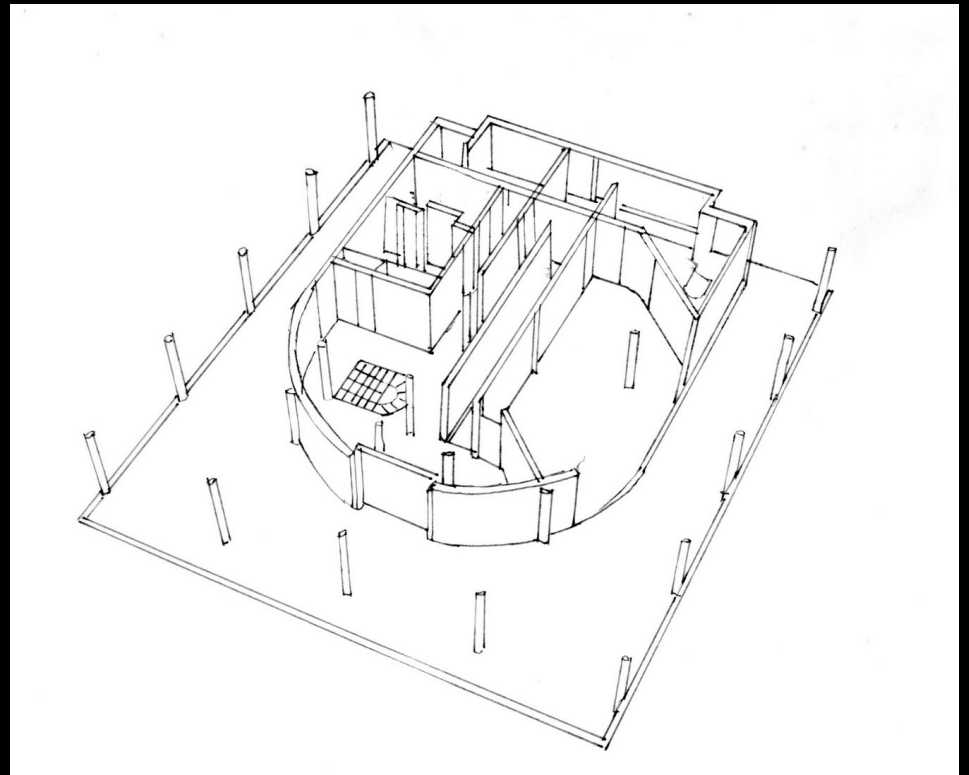


Precedents in Architectural History _ Plan of Saint Peter's _ Donato Bramante

SPATIAL SEQUENCE

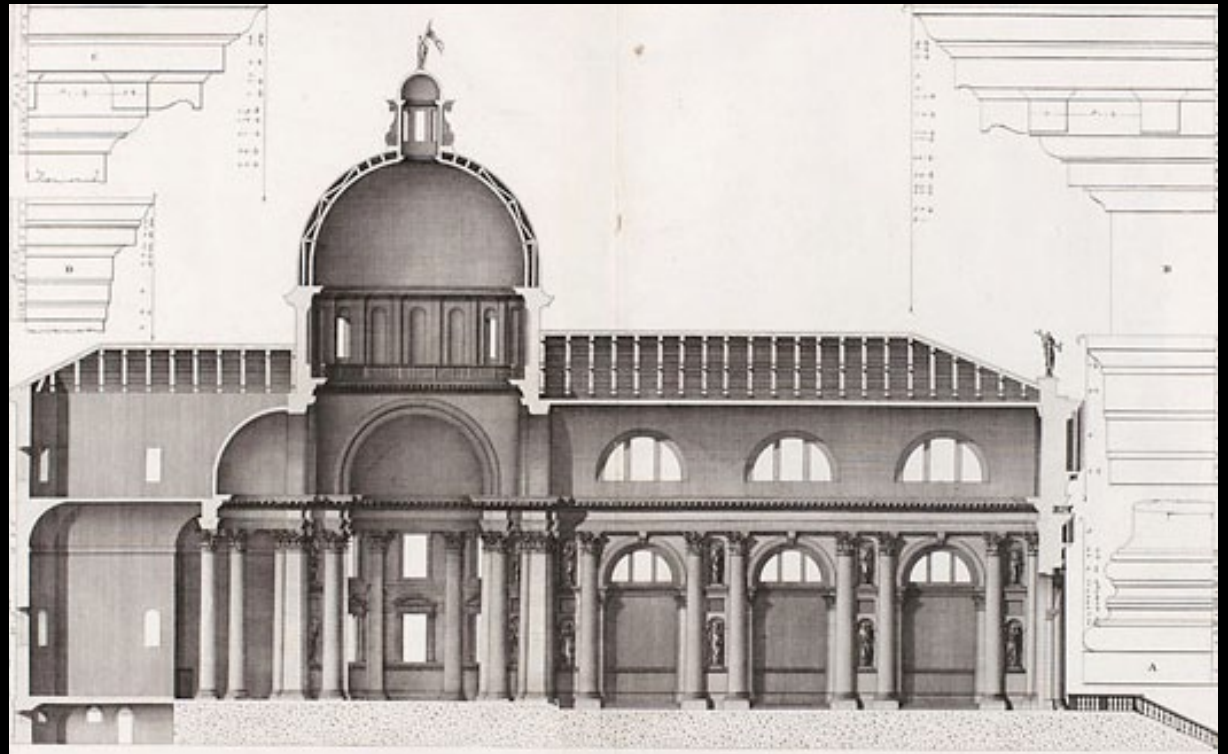
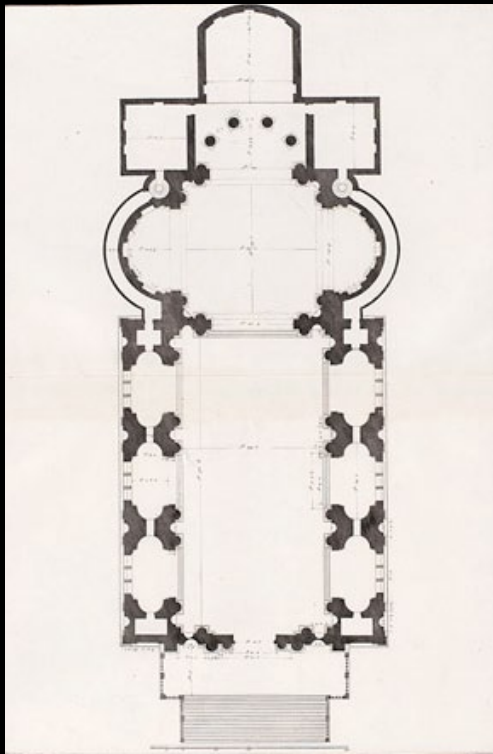


(left) Villa Rotunda _ Palladio



(right) Villa Savoye _ Le Corbusier

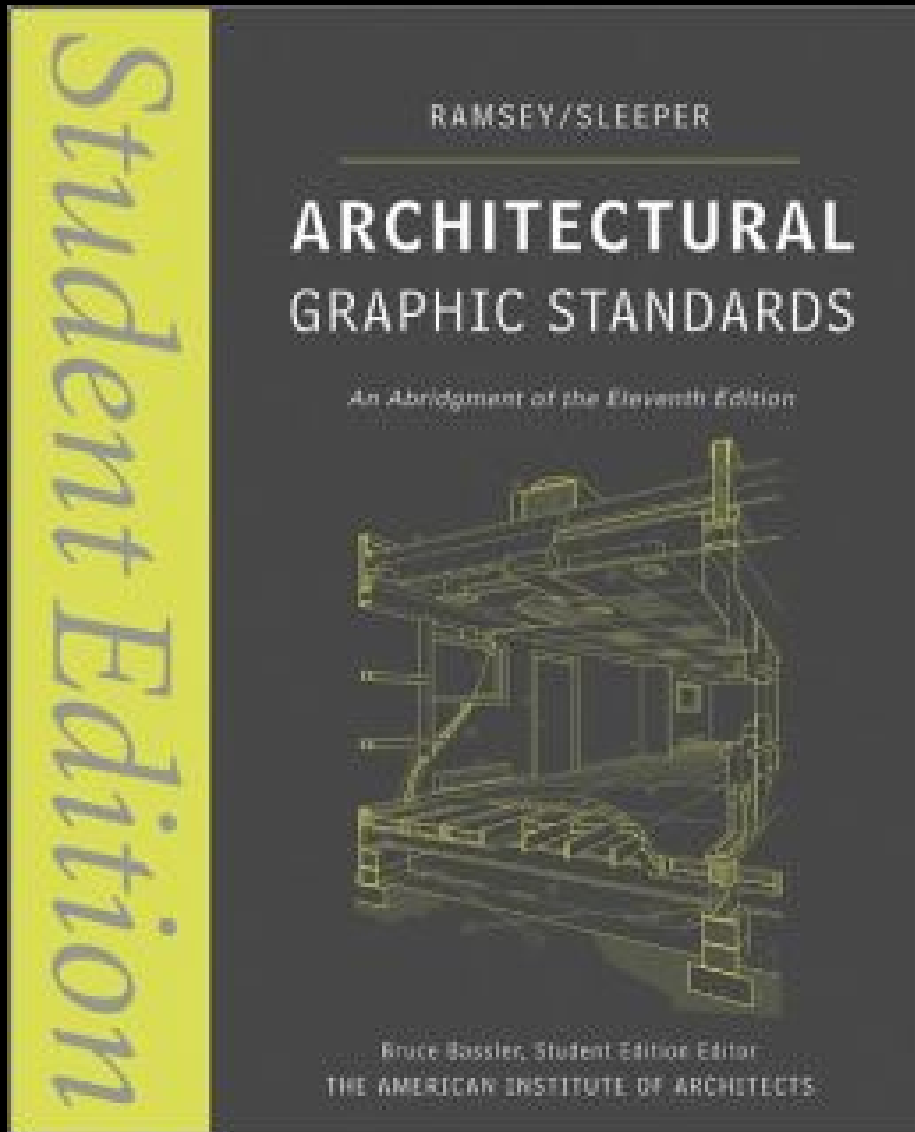
SPATIAL SEQUENCE



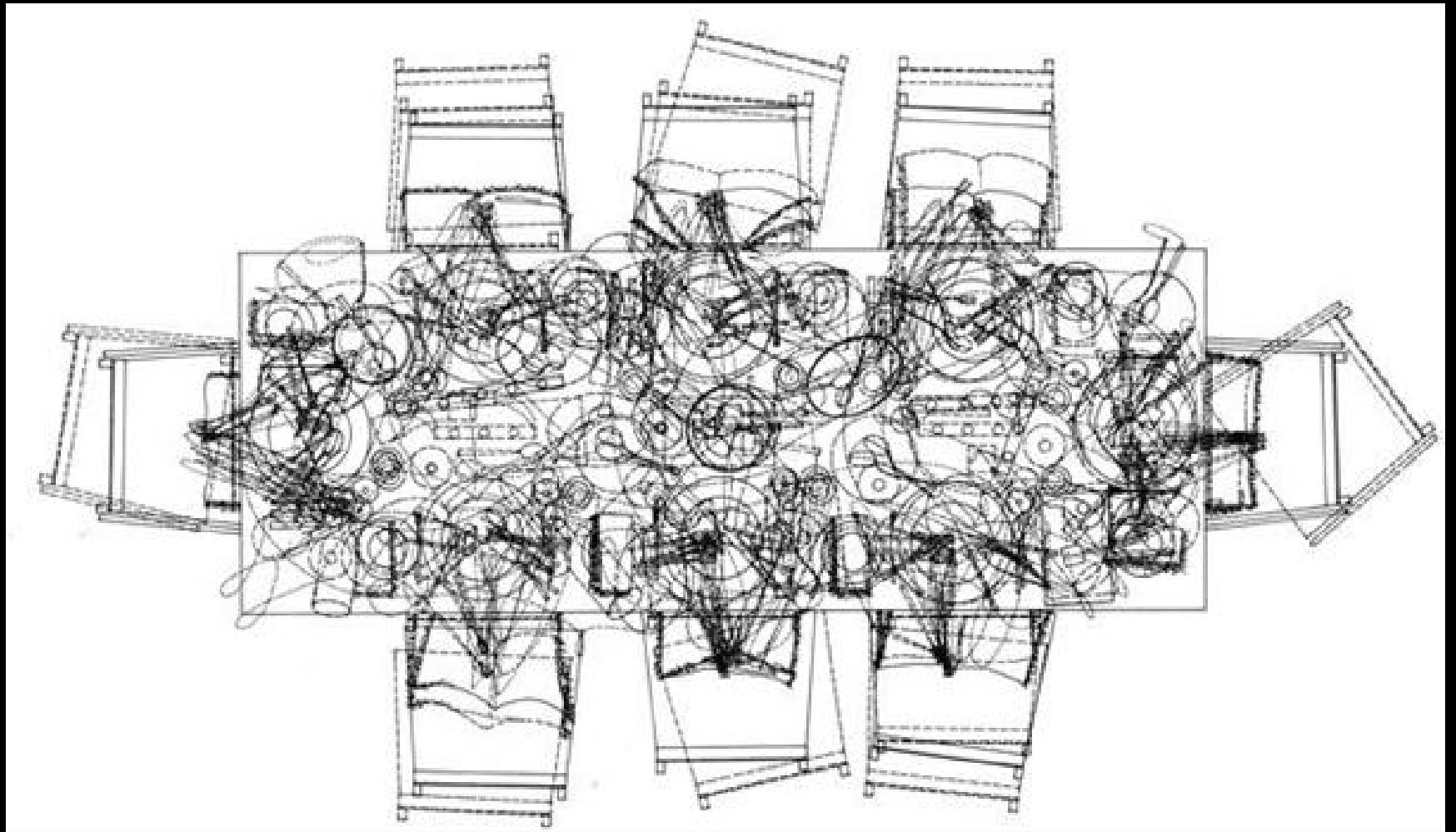
(left) Il Redentore plan _ Palladio

(right) Il Redentore section _ Scamozzi

SPATIAL SEQUENCE



PROGRAMMATIC SEQUENCE



PROGRAMMATIC SEQUENCE

INDIFFERENCE

: sequence of events and sequences of spaces are independent of one another

Tschumi, Bernard. "Sequences". *Architecture and Disjunction*. 1994. Cambridge: MIT Press.



Crown Hall _ Mies van der Rohe

PROGRAMMATIC SEQUENCE

RECIPROCITY

: Sequence of Events and Sequence of Spaces are totally interdependent and fully condition each other's existence

Tschumi, Bernard. "Sequences". *Architecture and Disjunction*. 1994. Cambridge: MIT Press.



Maison à Bordeaux _ Rem Koolhaas

PROGRAMMATIC SEQUENCE

CONFLICT

: Sequence of Events and Sequence of Spaces occasionally clash and contradict each other

Tschumi, Bernard. "Sequences". *Architecture and Disjunction*. 1994. Cambridge: MIT Press.



High Rise Cemetery in Mumbai

TRANSFORMATIONAL SEQUENCE



(left) String Model _ ARCH 251



(right) Paper Model _ Yoshinobu Miyamoto

THE FIVE OBSTRUCTIONS BY JORGEN LETH & LARS VON TRIER



THE FIVE OBSTRUCTIONS BY JORGEN LETH & LARS VON TRIER



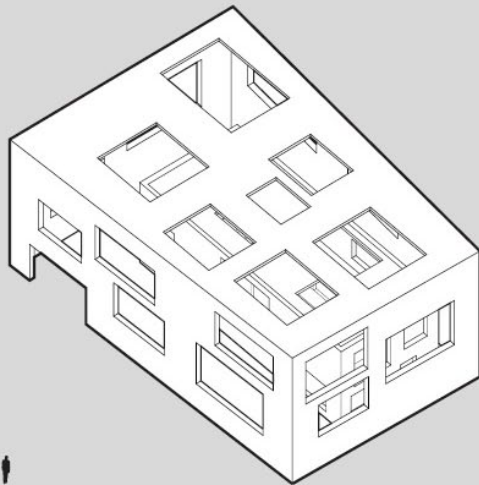
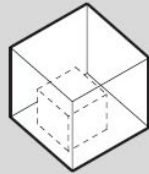
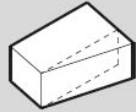
TRANSFORMATIONAL SEQUENCE

House N

Sou Fujimoto Architects

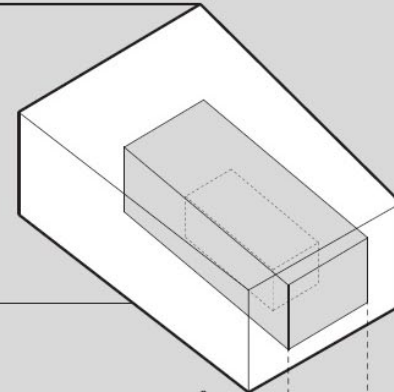


Photo by Iwan Baan

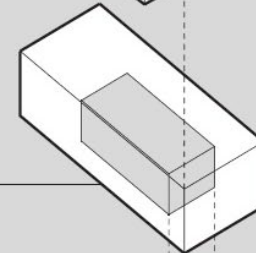


Expand + Nest

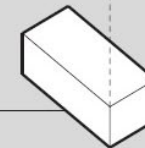
Nested Volumes



Garden | Entry | Kitchen



Bedroom | Tatami



Living | Dining

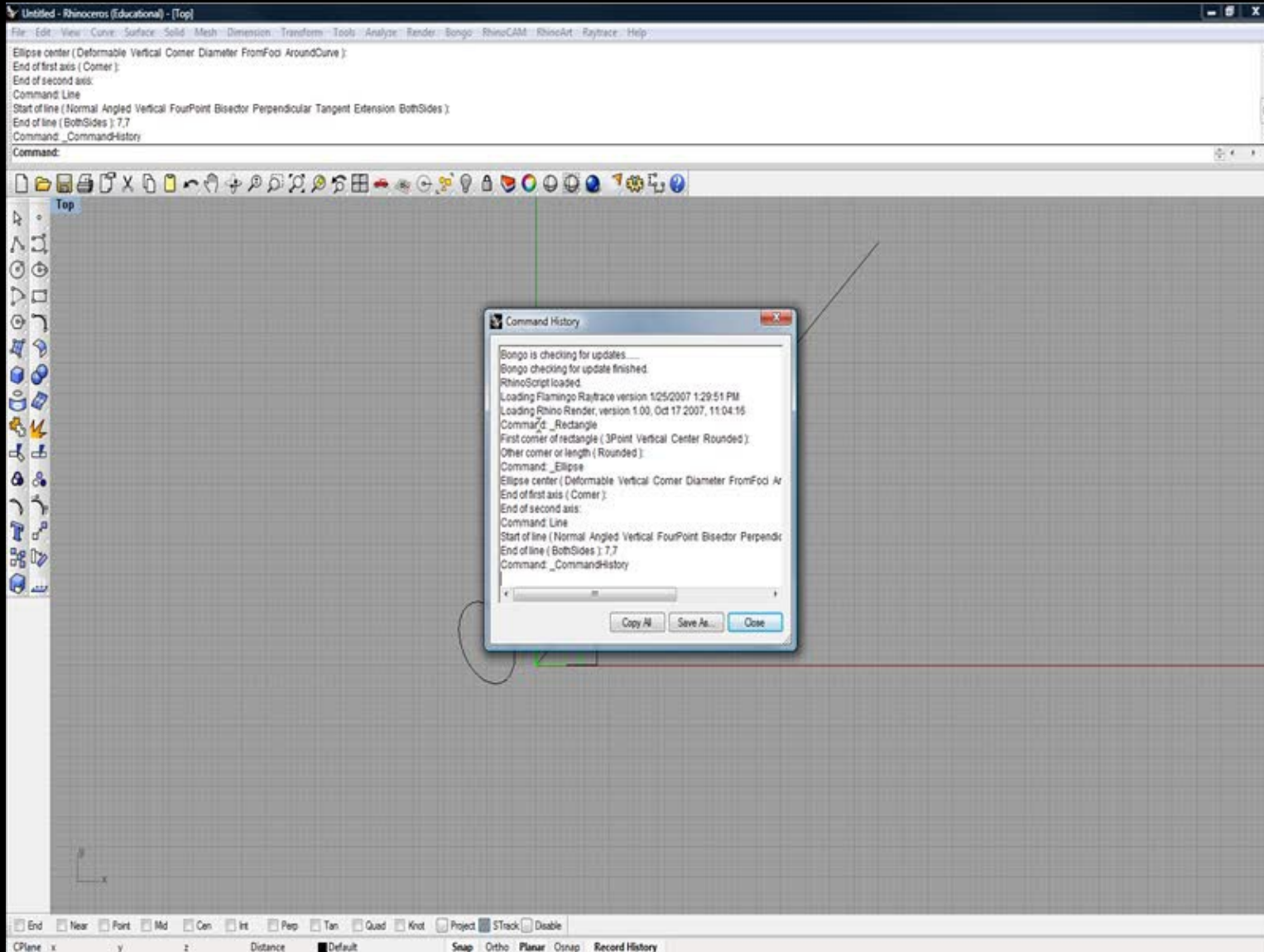
TRANSFORMATIONAL SEQUENCE

ANALOG - VERSUS - DIGITAL

TRANSFORMATIONAL SEQUENCE



TRANSFORMATIONAL SEQUENCE



TRANSFORMATIONAL SEQUENCE

WHY IS COMMUNICATING SEQUENCE IMPORTANT?

COMMUNICATING SEQUENCE

QUESTIONS?