

# Controller-based Automation

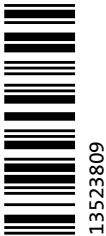

PROFINET® -----

Communication Manual EN



# Contents

---

<b>1</b>	<b>About this documentation</b>	<b>3</b>
1.1	Document history	5
1.2	Conventions used	6
1.3	Terminology used	7
1.4	Definition of the notes used	9
<b>2</b>	<b>Safety instructions</b>	<b>10</b>
<b>3</b>	<b>Controller-based Automation: Central motion control</b>	<b>12</b>
<b>4</b>	<b>The Lenze automation system with PROFINET</b>	<b>15</b>
4.1	Structure of the PROFINET system	16
4.2	Network topology	17
4.3	Field devices	18
4.4	PROFINET hardware for Lenze Controllers	19
4.5	Lenze Engineering tools	20
<b>5</b>	<b>Technical data</b>	<b>21</b>
5.1	Technical data of the MC-PND communication card	21
5.2	PROFINET connection	22
<b>6</b>	<b>Commissioning of the PROFINET</b>	<b>23</b>
6.1	Overview of the commissioning steps	23
6.2	The commissioning steps in detail	24
6.2.1	Planning the bus topology	24
6.2.2	Installing field devices	24
6.2.3	Create a project folder	25
6.2.4	Commission the field devices	25
6.2.5	Importing missing devices / device description files	26
6.2.6	Creating a PLC program with a target system (Logic)	27
6.2.7	Configuring the communication parameters	29
6.2.8	Creating a control configuration (adding field devices)	31
6.2.9	Configuring the I/O device	34
6.2.10	Logging in on the controller with the »PLC Designer«	34
<b>7</b>	<b>Mixed operation PROFINET with EtherCAT</b>	<b>35</b>
<b>8</b>	<b>Defining the cycle time of the PLC project</b>	<b>36</b>
8.1	Determining the task utilisation of the application	36
8.2	Optimising the system	38
<b>9</b>	<b>Diagnostics</b>	<b>39</b>
9.1	LED status displays of the MC-PND communication card	40
9.2	Diagnostics in the »PLC Designer«	41
<b>10</b>	<b>Parameter reference</b>	<b>42</b>
	<b>Index</b>	<b>44</b>
	Your opinion is important to us	46

# 1 About this documentation

---

## 1 About this documentation

This documentation ...

- contains detailed information about the commissioning, configuration, and diagnostics of the PROFINET® bus system as part of the Lenze automation system Controller-based Automation.
- is part of the "Controller-based Automation" manual collection. It consists of the following sets of documentation:

Documentation type	Subject
<b>Product catalogue</b>	Controller-based Automation (system overview, sample topologies) Lenze controllers (product information, technical data)
<b>System manuals</b>	Visualisation (system overview/sample topologies)
<b>Communication manuals Online helps</b>	Bus systems <ul style="list-style-type: none"><li>• Controller-based Automation EtherCAT®</li><li>• Controller-based Automation CANopen®</li><li>• Controller-based Automation PROFIBUS®</li><li>• Controller-based Automation PROFINET®</li></ul>
<b>Reference manuals Online helps</b>	Lenze Controllers: <ul style="list-style-type: none"><li>• Controller 3200 C</li><li>• Controller c300</li><li>• Controller p300</li><li>• Controller p500</li></ul>
<b>Software manuals Online helps</b>	Lenze Engineering Tools: <ul style="list-style-type: none"><li>• »PLC Designer« (programming)</li><li>• »Engineer« (parameter setting, configuration, diagnostics)</li><li>• »VisiWinNET® Smart« (visualisation)</li><li>• »Backup &amp; Restore« (backup, restore, update)</li></ul>

# 1 About this documentation

---

## More technical documentation for Lenze components

Further information on Lenze products which can be used in conjunction with Controller-based Automation can be found in the following sets of documentation:

Design / configuration / technical data	
<input type="checkbox"/>	<b>Product catalogues</b> <ul style="list-style-type: none"><li>• Controller-based Automation</li><li>• Controllers</li><li>• Inverter Drives/Servo Drives</li></ul>
Installation and wiring	
<input type="checkbox"/>	<b>Mounting instructions</b> <ul style="list-style-type: none"><li>• Controllers</li><li>• Communication cards (MC-xxx)</li><li>• I/O system 1000 (EPM-Sxxx)</li><li>• Inverter Drives/Servo Drives</li><li>• Communication modules</li></ul>
<input type="checkbox"/>	<b>Hardware manuals</b> <ul style="list-style-type: none"><li>• Inverter Drives/Servo Drives</li></ul>
Parameterisation / configuration / commissioning	
<input type="checkbox"/>	<b>Online help/reference manuals</b> <ul style="list-style-type: none"><li>• Controllers</li><li>• Inverter Drives/Servo Drives</li><li>• I/O system 1000 (EPM-Sxxx)</li></ul>
<input type="checkbox"/>	<b>Online help/communication manuals</b> <ul style="list-style-type: none"><li>• Bus systems</li><li>• Communication modules</li></ul>
Sample applications and templates	
<input type="checkbox"/>	<b>Online help / software manuals and reference manuals</b> <ul style="list-style-type: none"><li>• i700 application sample</li><li>• Application Samples 8400/9400</li><li>• FAST application template</li><li>• FAST technology modules</li></ul>

### Symbols:

-  Printed documentation
- PDF file / online help in the Lenze engineering tool



### Tip!

Current documentation and software updates with regard to Lenze products can be found in the download area at:

[www.lenze.com](http://www.lenze.com)

## Target group

This documentation is intended for persons who commission and maintain a Controller-based automation system by means of a Lenze Controller and the »PLC Designer« engineering tool.

## Information regarding the validity

The information provided in this documentation is valid for the Lenze automation system "Controller-based Automation" from release 3.0.

## Screenshots/application examples

All screenshots in this documentation are application examples. Depending on the firmware version of the field devices and the software version of the Engineering tools installed (e.g. »PLC Designer« ), screenshots in this documentation may differ from the representation on the screen.

# 1 About this documentation

## 1.1 Document history

---



### 1.1 Document history

Version			Description
1.6	11/2016	TD17	Update for the Lenze automation system "Controller-based Automation" 3.14 <ul style="list-style-type: none"><li>• PROFINET option for the c300 and p300 controllers</li><li>• Correction of the minimum cycle time: 2 ms (see <a href="#">Technical data of the MC-PND communication card (p 21)</a>)</li></ul>
1.5	10/2015	TD17	Update for the Lenze automation system "Controller-based Automation" 3.12 <ul style="list-style-type: none"><li>• <a href="#">Technical data of the MC-PND communication card (p 21)</a></li><li>• <a href="#">LED status displays of the MC-PND communication card (p 40)</a></li></ul>
1.4	05/2015	TD17	Update for the "Controller-based Automation" 3.10 Lenze automation system <ul style="list-style-type: none"><li>• Scaling (bytes) of the I/O data (see <a href="#">Technical data of the MC-PND communication card (p 21)</a>)</li></ul>
1.3	01/2015	TD17	Update for the Lenze automation system "Controller-based Automation" 3.9
1.2	04/2014	TD17	Update for the Lenze automation system "Controller-based Automation" 3.8
1.1	11/2013	TD17	Update for the Lenze automation system "Controller-based Automation" 3.6
1.0	03/2013	TD17	First edition

# 1 About this documentation

## 1.2 Conventions used



This documentation uses the following conventions to distinguish between different types of information:



Type of information	Highlighting	Examples/notes
Spelling of numbers		
Decimal	Normal spelling	Example: 1234
Decimal separator	Point	The decimal point is always used. For example: 1234.56
Hexadecimal	0x[0 ... 9, A ... F]	Example: 0x60F4
Binary • Nibble	0b[0, 1]	Example: '0b0110' Example: '0b0110.0100'
Text		
Program name	» «	PC software Example: Lenze »Engineer«
Window	<i>italics</i>	The <i>message window</i> ... / The <i>Options</i> dialog box ...
Variable names		Setting <i>bEnable</i> to TRUE...
Control element	<b>bold</b>	The <b>OK</b> button ... / The <b>Copy</b> command ... / The Properties tab ... / The <b>Name</b> input field ...
Sequence of menu commands		If several successive commands are required for executing a function, the individual commands are separated from each other by an arrow: Select the command <b>File → Open</b> to...
Shortcut	<b>&lt;bold&gt;</b>	Use <b>&lt;F1&gt;</b> to open the online help. If a key combination is required for a command, a "+" is placed between the key identifiers: With <b>&lt;Shift&gt;+&lt;ESC&gt;</b> ...
Program code	Courier	<b>IF</b> var1 < var2 <b>THEN</b> a = a + 1 <b>END IF</b>
Keyword	<b>Courier bold</b>	
Hyperlink	<u>underlined</u>	Optically highlighted reference to another topic. Can be activated with a mouse-click in this documentation.
Icons		
Page reference	 6	Optically highlighted reference to another page. Can be activated with a mouse-click in this documentation.
Step-by-step instructions		Step-by-step instructions are indicated by a pictograph.

# 1 About this documentation

## 1.3 Terminology used

### 1.3 Terminology used

Term	Meaning
CL-RPC	Connectionless Remote Procedure Call
Code	Parameter for parameterising or monitoring the field device. The term is also referred to as "index" in common usage.
Controllers	The Controller is the central component of the Lenze automation system which control the motion sequences by means of the application software. The Controller communicates with the field devices (inverters) via the fieldbus.
Engineering PC	The Engineering PC and the Engineering tools installed serve to configure and parameterise the system "Controller-based Automation". The Engineering PC communicates with the controller via Ethernet.
Engineering tools	Software solutions for easy engineering in all phases which serve to commission, configure, parameterise and diagnose the Lenze automation system. ▶ <a href="#">Lenze Engineering tools</a> (📖 20) Siemens software for programming and configuring Siemens SIMATIC S7 PLC: • »STEP7«
FAST	By default, the <b>Lenze FAST</b> application software is installed on the Lenze Controller in the " <b>FAST runtime</b> " version with " <b>FAST Motion</b> " for the central control of PLC applications.
Fieldbus node	Devices integrated in the bus system as, for instance, Controller and inverter
Field device	
GSDML file	A GSDML file described the properties of a field device. It is described with the XML-based language GSDML (General Station Description Markup Language).
I/O device	PROFINET slave
I/O master	PROFINET master The I/O master takes over the master function for data communication of the decentralised field devices. The I/O master is usually the communication interface of a PLC.
Inverters	Generic term for Lenze frequency inverters, servo inverters
PDO	Process Data Object
PLC	Programmable Logic Controller
RT over UDP	Real Time over User Datagram Protocol
PLC	Programmable Logic Controller (PLC)
Subcode	If a code contains several parameters, they are stored in "subcodes". In the documentation, the slash "/" is used as a separator between the code and the subcode (e.g. "C00118/3"). In everyday language, the term is also referred to as "subindex".
<b>Bus systems</b>	
CAN	CAN (Controller Area Network) is an asynchronous, serial fieldbus system.
	CANopen® is a communication protocol based on CAN. The Lenze system bus (CAN on board) operates with a subset of this communication protocol. CANopen® is a registered community trademark of the CAN user organisation CiA® (CAN in Automation e. V.).
	EtherCAT® ( <b>E</b> thernet for <b>C</b> ontroller and <b>A</b> utomation <b>T</b> echnology) is an Ethernet-based fieldbus system which fulfils the application profile for industrial real-time systems. EtherCAT® is a registered trademark and patented technology, licenced by Beckhoff Automation GmbH, Germany.
	Ethernet specifies the software (protocols) and hardware (cables, plugs, etc.) for wired data networks. In the form of "Industrial Ethernet", the Ethernet standard is used in industrial production systems. On the basis of IEEE 802.3, standard Ethernet is specified by the Institute of Electrical and Electronics Engineers (IEEE), USA.

Term	Meaning
	<p>EtherNet/IP™ (EtherNet Industrial Protocol) is an Ethernet-based fieldbus system that uses Common Industrial Protocol™ (CIP™) to exchange data. EtherNet/IP™ and Common Industrial Protocol™ (CIP™) are brand labels and patented technologies, licensed by the ODVA user organisation (Open DeviceNet Vendor Association), USA.</p>
	<p>PROFIBUS® (Process Field Bus) is a widely used fieldbus system for the automation of machines and production lines. PROFIBUS® is a registered trademark and patented technology licensed by the PROFIBUS &amp; PROFINET International (PI) user organisation.</p>
	<p>PROFINET® (Process Field Network) is a real-time capable fieldbus system based on Ethernet. PROFINET® is a registered trademark and patented technology licensed by the PROFIBUS &amp; PROFINET International user organisation (PI).</p>



# 1 About this documentation

## 1.4 Definition of the notes used

---

### 1.4 Definition of the notes used

The following signal words and symbols are used in this documentation to indicate dangers and important information:

#### Safety instructions

Layout of the safety instructions:



#### Pictograph and signal word!

(characterise the type and severity of danger)

#### Note

(describes the danger and gives information about how to prevent dangerous situations)

Pictograph	Signal word	Meaning
	Danger!	<b>Danger of personal injury through dangerous electrical voltage</b> Reference to an imminent danger that may result in death or serious personal injury if the corresponding measures are not taken.
	Danger!	<b>Danger of personal injury through a general source of danger</b> Reference to an imminent danger that may result in death or serious personal injury if the corresponding measures are not taken.
	Stop!	<b>Danger of property damage</b> Reference to a possible danger that may result in property damage if the corresponding measures are not taken.

#### Application notes

Pictograph	Signal word	Meaning
	Note!	Important note to ensure trouble-free operation
	Tip!	Useful tip for easy handling
		Reference to another document

### 2 Safety instructions

Please observe the safety instructions in this documentation when you want to commission an automation system or a plant with a Lenze Controller.



**The device documentation contains safety instructions which must be observed!**

Read the documentation supplied with the components of the automation system carefully before you start commissioning the Controller and the connected devices.



**Danger!**

**High electrical voltage**

Injury to persons caused by dangerous electrical voltage

**Possible consequences**

Death or severe injuries

**Protective measures**

Switch off the voltage supply before working on the components of the automation system.

After switching off the voltage supply, do not touch live device parts and power terminals immediately because capacitors may be charged.

Observe the corresponding information plates on the device.



**Danger!**

**Injury to persons**

Risk of injury is caused by ...

- unpredictable motor movements (e.g. unintended direction of rotation, too high velocities or jerky movement);
- impermissible operating states during the parameterisation while there is an active online connection to the device.

**Possible consequences**

Death or severe injuries

**Protective measures**

- If required, provide systems with installed inverters with additional monitoring and protective devices according to the safety regulations valid in each case (e.g. law on technical equipment, regulations for the prevention of accidents).
- During commissioning, maintain an adequate safety distance to the motor or the machine parts driven by the motor.



### **Stop!**

#### **Damage or destruction of machine parts**

Damage or destruction of machine parts can be caused by ...

- Short circuit or static discharges (ESD);
- unpredictable motor movements (e.g. unintended direction of rotation, too high velocities or jerky movement);
- impermissible operating states during the parameterisation while there is an active online connection to the device.

#### **Protective measures**

- Always switch off the voltage supply before working on the components of the automation system.
- Do not touch electronic components and contacts unless ESD measures were taken beforehand.
- If required, provide systems with installed inverters with additional monitoring and protective devices according to the safety regulations valid in each case (e.g. law on technical equipment, regulations for the prevention of accidents).

### 3 Controller-based Automation: Central motion control

The Lenze "Controller-based Automation" system serves to create complex automation solutions with central motion control. Here, the Controller is the control centre of the system.



#### Note!

In the Lenze automation system, no PROFINET master functionality is supported. In a PROFINET network, a Lenze Controller can only be driven as I/O device (slave), e.g. by a Siemens SIMATIC S7 PLC.

#### System structure of the Controller-based Automation

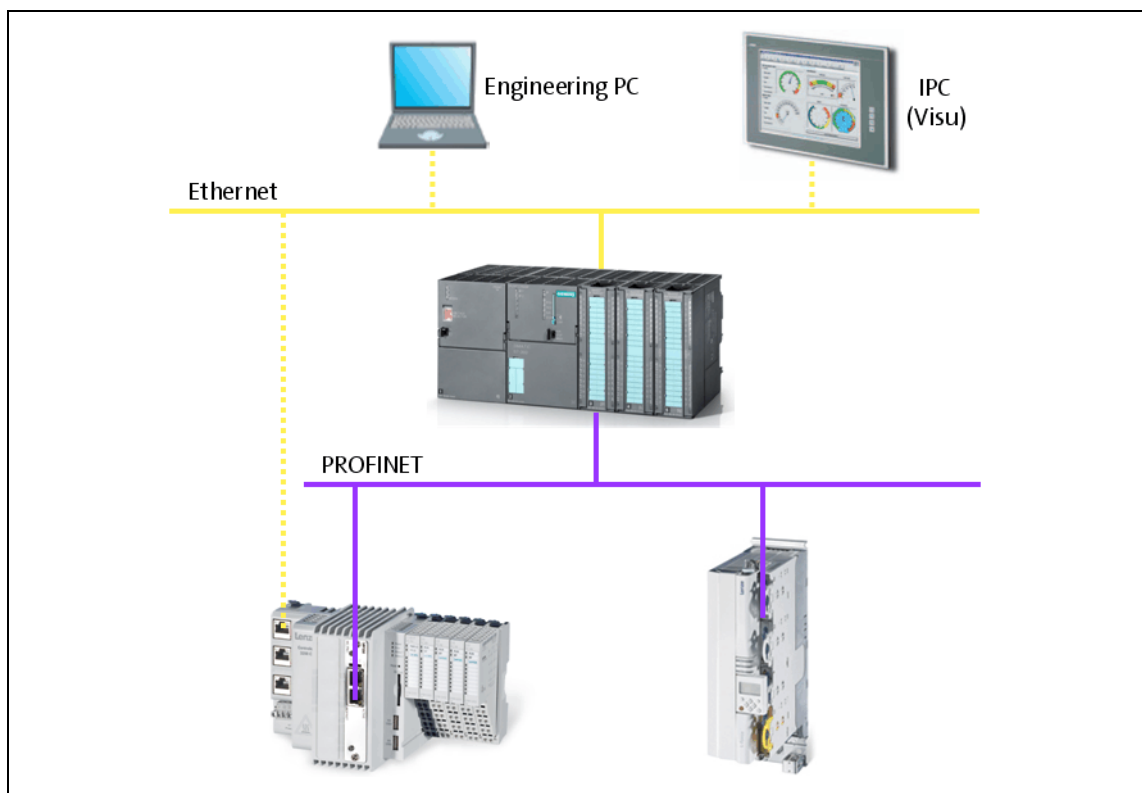

[3-1] **Example:** PROFINET with a Siemens SIMATIC S7 PLC (Lenze Controller 3221 C with I/O system 1000 and Servo Drive 9400 as I/O devices)

Lenze provides especially coordinated system components:

- Engineering software  
The [Lenze Engineering tools](#) (📖 20) on your Engineering PC (Windows® operating system ) serve to parameterise, configure and diagnose the system. The Engineering PC communicates with the Controller via Ethernet.  
The Lenze engineering tools are available for download at:  
[www.lenze.com](http://www.lenze.com) → **Download** → **Software Downloads**
- Controllers  
The Lenze Controller is available as Panel Controller with integrated touch display and as Cabinet Controller in control cabinet design.  
Cabinet Controllers provide a direct coupling of the I/O system 1000 via the integrated backplane bus.
- Bus systems  
EtherCAT is the standard "on-board" bus system of the Controller-based Automation. EtherCAT enables the control of all nodes on one common fieldbus.  
Optionally, CANopen, PROFIBUS and PROFINET can be used as extended topologies.  
With Controllers 3200 C and p500 it is also possible to use EtherNet/IP via the Ethernet interfaces.  
Controllers c300 and p300 are provided with an "on board" CANopen interface (in addition to EtherCAT).
- Inverter (e.g. Servo-Inverter i700)

### "Application software" of the Lenze Controllers

The "application software" of the Lenze Controllers enables the control and/or visualisation of motion sequences.

**FAST technology modules** provide for an easy development of a modular machine control in the »PLC Designer«.

The following "Application Software" versions are available:

- "FAST Runtime"  
The sequence control takes place (by logically combined control signals) in the Controller.  
The motion control takes place in the inverter.
- "FAST Motion"  
The sequence control and the motion control take place in the controller.  
The inverter merely serves as actuating drive.  
Motion applications make special demands on the cycle time and real-time capability of the bus system between the Controller and the subordinate fieldbus nodes. This is the case, for instance, if the nodes are to be traversed in a synchronised way or position setpoints are to be transferred.
- "Visualisation"  
The optional visualisation of the automation system can be used separately or additionally to "FAST Runtime" or "FAST Motion".  
For this purpose, an external monitor panel/display can be connected to the Cabinet Controller 3231 C/3241 C/3251 C.

#### Fieldbus communication

The Lenze controllers have different interfaces for fieldbus communication:

Range	Cabinet Controller		Panel Controller	
	c300	3200 C series	p300	p500
<b>Interfaces (on board)</b>				
Ethernet	1	2	1	2
EtherNet/IP	-		-	
EtherCAT	1 <sup>1)</sup>	1	1 <sup>1)</sup>	1
CANopen	1	-	1 <sup>2)</sup>	-
<b>Optional interfaces (communication cards)</b>				
CANopen MC-CAN2	-	●	-	● <sup>2)</sup>
PROFIBUS master MC-PBM	-	●	-	●
PROFIBUS slave MC-PBS	-	●	-	●
PROFINET device MC-PND	●	●	●	●
Ethernet MC-ETH	-	●	-	●
Serial interfaces MC-ISI	-	●	-	●

1) Only the master functionality is supported.

2) Up to release 3.9: "EL 100 CAN" driver / from release 3.10: "Lenze CAN driver"

#### Ethernet interface

The Ethernet interface serves to connect the Engineering PC or to create line topologies (no integrated switch for Controller c300/p300).

With Controllers 3200 C and p500, the Ethernet interfaces also provide for EtherNet/IP communication.

### 4 The Lenze automation system with PROFINET



#### Note!

- In the Lenze automation system, no PROFINET master functionality is supported. In a PROFINET network, a Lenze Controller can only be driven as I/O device (slave), e.g. by a Siemens SIMATIC S7 PLC.
- In the Lenze automation system, Logic field devices can be exclusively operated via PROFINET. Thus, as an I/O device, the Lenze Controller is a Logic field device.
- The Motion functionality is not supported when PROFINET is used. Always use EtherCAT to connect inverters to be controlled via the central motion functionality.
  - ▶ [Mixed operation PROFINET with EtherCAT](#) (📖 35)
- 

This chapter provides basic information about ...

- the structure of the Lenze automation system using the PROFINET bus system;
- the Lenze Engineering tools required for commissioning;
- the interaction of the components.

We recommend using PROFINET for the following applications:

- Equipment and extension of system parts that have already been automated with PROFINET before.
- Use of field devices that are not available for e.g. EtherCAT, CANopen or PROFIBUS.
- The combination of PROFINET with EtherCAT is possible.



#### Tip!

Detailed information about PROFINET can be found on the website of the PROFIBUS & PROFINET user organisation:

[www.profibus.com](http://www.profibus.com)

## 4.1 Structure of the PROFINET system

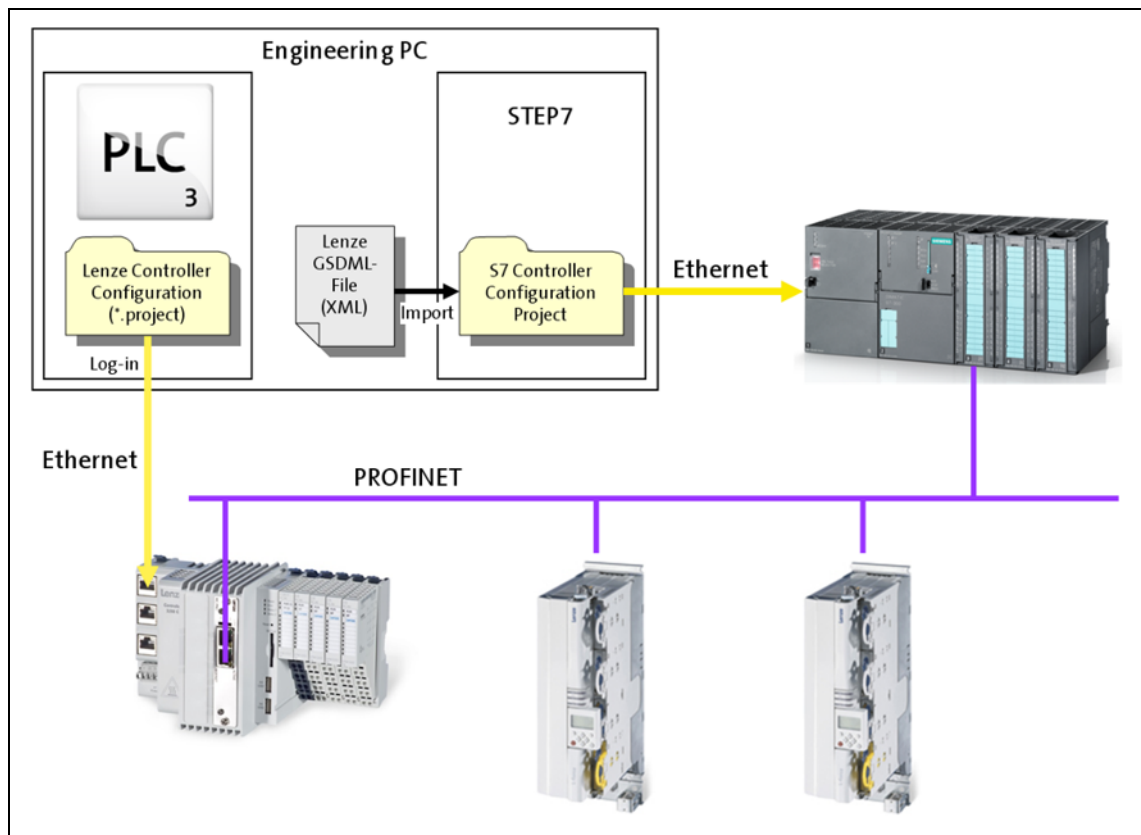

[4-1] **Example:** PROFINET configuration with a Siemens SIMATIC S7-PLC (Lenze Controller 3221 C with I/O system 1000 and Servo Drives 9400 as I/O devices)

Usually, field devices with PROFINET interface with an existing GSDML file can be used in a PROFINET network.

In the example (fig [4-1]), the Lenze Controller 3221 C together with the I/O system 1000 and two Servo Drives 9400 are driven as I/O devices by a Siemens SIMATIC S7 PLC.

The Lenze Controller is configured in the »PLC Designer« (see [Commissioning of the PROFINET \(23\)](#)). When you log in with the »PLC Designer«, the configuration data is loaded into the Lenze Controller via Ethernet.

In order to integrate a Lenze Controller or other Lenze field devices into a »STEP7« project use the GSDML file of the device to be integrated.

**Tip!**

GSDML files of the Lenze Controllers and of other Lenze devices are provided in the download area at:

[www.lenze.com](http://www.lenze.com)



## 4.2 Network topology

It is typical of PROFINET to have a rather free topology, the limiting factor of which is large message latencies due to e.g. switches connected in series.

PROFINET supports the following topologies:

### Line topology

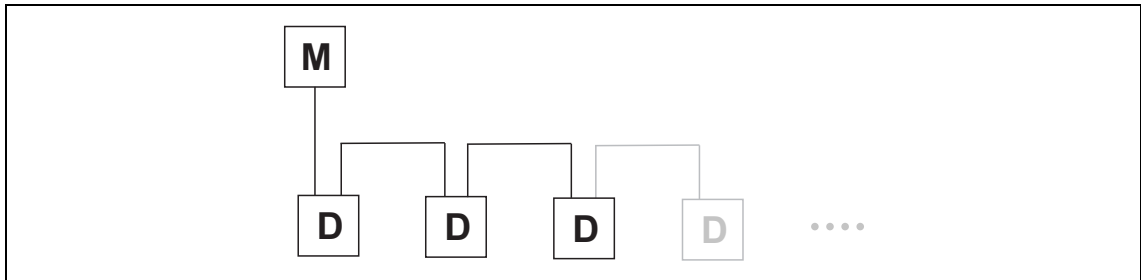

[4-2] Line topology (M = I/O master, D = I/O device)

### Star topology

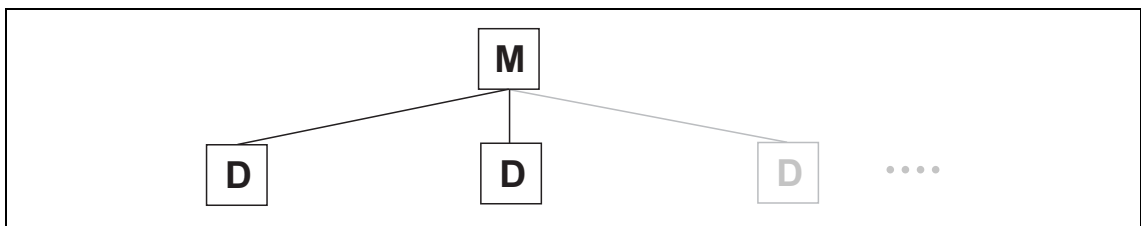

[4-3] Star topology (M = I/O master, D = I/O device)

### Tree topology

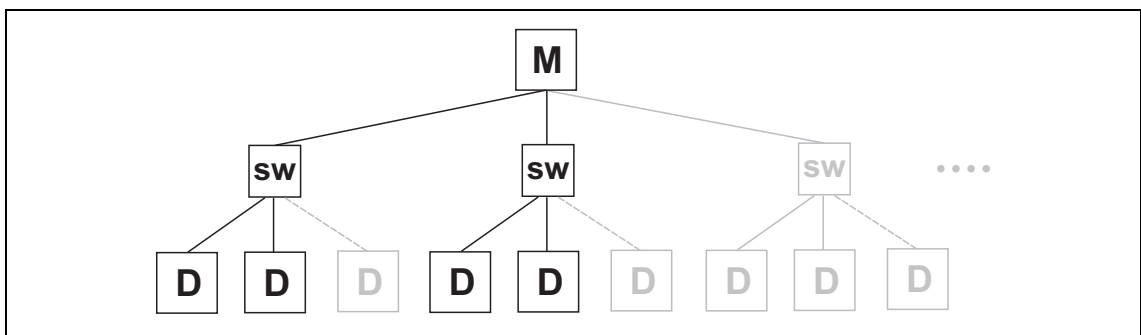

[4-4] Tree topology via switches (M = IO master, SW = switch, D = I/O device)

### 4.3 Field devices

The Lenze automation system supports the following PROFINET-capable Logic components:

Logic field devices	
<b>Controllers</b>	Cabinet Controller 32xx C
	Panel Controller p500
<b>Servo Drives 9400 1)</b>	HighLine
	HighLine with CiA402
	PLC
	regenerative power supply module commissioning guidelines
<b>Inverter Drives 8400 2)</b>	StateLine
	HighLine
	TopLine
<b>I/O system 1000</b>	EPM-Sxxx

1) With PROFINET communication module E94AYCER

2) With PROFINET communication module E84AYCER

Field devices of other manufacturers can be implemented if corresponding device descriptions are available.

## 4.4 PROFINET hardware for Lenze Controllers

### MC-PND communication card

The **MC-PND** communication card serves to connect the Lenze Controller as **I/O device (slave)** to a PROFINET network.

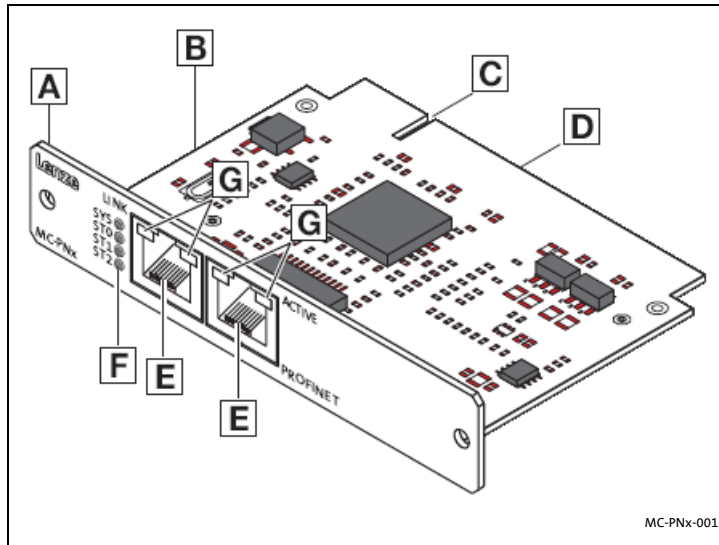

A Front panel

B Printed circuit board

C Coding

D Connection of Lenze Controller

E [PROFINET connection](#) (22)

F [LED status displays of the MC-PND](#)

G [communication card](#) (40)

[4-5] MC-PND communication card

► [Technical data of the MC-PND communication card](#) (21)

### Application

The MC-PND communication card is installed in the respective slot of the Lenze Controller.

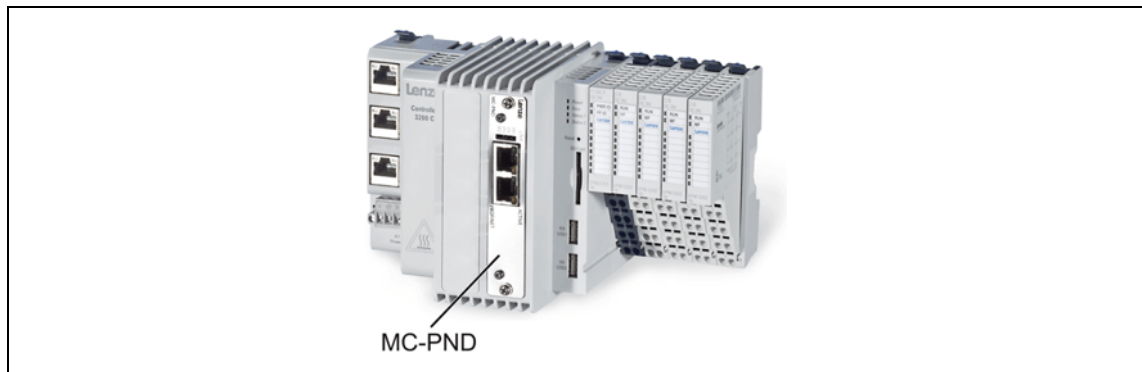

[4-6] **Example:** Lenze Controller 3221 C with MC-PND communication card

## 4.5 Lenze Engineering tools

The Lenze Engineering tools enable the configuration and operation of controller-based Lenze automation systems according to individual requirements.

Use the corresponding Engineering tool applicable to the field device.



### »EASY Navigator«

The »EASY Navigator« provides an overview of the Lenze Engineering software installed on the Engineering PC.

The Lenze Engineering software consists of the Engineering tools optimised for the respective application case.



The »EASY Navigator« ...

- simplifies orientation for selecting the suitable Engineering tool;
- allows for the simple start of the required Engineering tool (depending on the application):

What would you like to do?	Button	Engineering tool
<b>Programming</b> <ul style="list-style-type: none"> <li>• Parameterise the Lenze Controller</li> <li>• Parameterisation of the i700 servo inverter</li> <li>• Parameterise the I/O system 1000</li> </ul>		»PLC Designer«
<b>Inverter configuration</b> <ul style="list-style-type: none"> <li>• Projecting the automation/drive system</li> <li>• Parameterisation/configuration               <ul style="list-style-type: none"> <li>• Inverter Drives 8400, 8400 motec/protect</li> <li>• Servo Drives 9400</li> <li>• I/O system 1000</li> </ul> </li> </ul>		»Engineer«
<b>Visualisation</b> <ul style="list-style-type: none"> <li>• Visualising the automation system</li> <li>• Creating the user interface</li> </ul>		»VisiWinNET«
<b>Online diagnostics</b> Easy online diagnostics of Lenze Controllers and other Lenze field devices		»EASY Starter«
<b>Online parameterisation</b> <ul style="list-style-type: none"> <li>• Online parameterisation and commissioning</li> <li>• Direct online parameterisation when the online connection to the Lenze devices is active.</li> </ul>		»EASY Starter«

Further Engineering tools that are not called via the »EASY Navigator« are:

- »WebConfig« (web-based parameterisation, configuration, and online diagnostics)
- »IPC Backup & Restore« (data backup, data recovery).

# 5 Technical data

## 5.1 Technical data of the MC-PND communication card

---

# 5 Technical data

## 5.1 Technical data of the MC-PND communication card

Range	Values
Communication profile	PROFINET
Communication medium / cable type	S/FTP (Screened Foiled Twisted Pair, ISO/IEC 11801 or EN 50173), CAT5e Standard Ethernet (in accordance with IEEE 802.3), 100Base-TX (Fast Ethernet)
Network topology	Line, star and tree
Type within the network	PROFINET I/O device (slave)
Max. cable length	100 m between two stations
I/O data (PDO data)	<ul style="list-style-type: none"><li>• Max. 244 PDOs: Freely configurable, independent of its direction (In, Out, In/Out)</li><li>• Max. 1024 input bytes <u>and</u> max. 1024 output bytes</li><li>• Scaling:<ul style="list-style-type: none"><li>• Byte: 1, 2, 4, 8, 16, 32, 64, 128, 192, 256, 320, 384, 448, 512, 1024</li><li>• Word: 1, 2, 4, 8, 16, 32, 64, 128, 192, 256, 320, 384, 448, 512</li></ul></li><li>• The combination of I/O data in one slot is possible.</li></ul>
Communication type	PROFINET I/O, cyclic
Functions	<ul style="list-style-type: none"><li>• Transmission of cyclic process data</li><li>• Context Management via CL-RPC (Connectionless Remote Procedure Call) The Context Management Protocol is used for:<ul style="list-style-type: none"><li>• Connection establishment and termination</li><li>• Request for resources</li><li>• Exchange of configuration and diagnostic information</li><li>• Upload/Download of data records</li></ul></li><li>• Setpoint/actual value comparison of the PROFINET configuration</li></ul>
Special features in the Lenze automation system	Configuration in the »PLC Designer«: <ul style="list-style-type: none"><li>• No submodules</li><li>• Only one device instance is supported.</li></ul> <u>No support of ...</u> <ul style="list-style-type: none"><li>• acyclic read and write requests</li><li>• DCP (Discovery and basic Configuration Protocol)</li><li>• RTP (Real-Time Transport Protocol) over UDP (User Datagram Protocol)</li><li>• Multicast communication</li><li>• Process-/diagnostics alarms</li><li>• Generic diagnostics, channel diagnostics</li></ul>
Minimum cycle time	8 ms

## 5.2 PROFINET connection

PROFINET is connected via the RJ45 sockets.

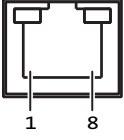
RJ45 socket	Pin	Assignment
 <p>MC-PNx-003</p>	1	Tx +
	2	Tx -
	3	Rx +
	4	Term1 1)
	5	Term1 1)
	6	Rx -
	7	Term2 2)
	8	Term2 2)

- 1) Bridged and terminate to PE via RC element.
- 2) Bridged and terminate to PE via RC element.



### Tip!

The PROFINET interfaces feature an auto MDIX function. This function adjusts the polarity of the RJ45 interfaces so that a connection is established irrespective of the polarity of the opposite PROFINET interface, and irrespective of the cable type used (standard patch cable or crossover cable).

# 6 Commissioning of the PROFINET

## 6.1 Overview of the commissioning steps

---

# 6 Commissioning of the PROFINET



### Note!

- In the Lenze automation system, no PROFINET master functionality is supported. In a PROFINET network, a Lenze Controller can only be driven as I/O device (slave), e.g. by a Siemens SIMATIC S7 PLC.
- In the Lenze automation system, Logic field devices can be exclusively operated via PROFINET. Thus, as an I/O device, the Lenze Controller is a Logic field device.
- The Motion functionality is not supported when PROFINET is used. Always use EtherCAT to connect inverters to be controlled via the central motion functionality.
  - ▶ [Mixed operation PROFINET with EtherCAT](#) (📖 35)

This chapter provides information on how to commission the Lenze automation system with PROFINET.

Depending on the field devices used, the following [Lenze Engineering tools](#) (📖 20) are required:

- »EASY Starter«
- »Engineer«
- »PLC Designer«

## 6.1 Overview of the commissioning steps

The main commissioning steps are listed in the following table.

Step	Activity	Software to be used
1.	<a href="#">Planning the bus topology</a> (📖 24)	
2.	<a href="#">Installing field devices</a> (📖 24)	
3.	<a href="#">Create a project folder</a> (📖 25)	
4.	<a href="#">Commission the field devices</a> (📖 25)	»Engineer«/»EASY Starter«
	If necessary, import the missing devices/device description files <a href="#">Importing missing devices / device description files</a> (📖 26)	»STEP7«
5th	<a href="#">Creating a PLC program with a target system (Logic)</a> (📖 27)	»PLC Designer«
6.	<a href="#">Configuring the communication parameters</a> (📖 29)	
6.	<a href="#">Creating a control configuration (adding field devices)</a> (📖 31)	
7.	<a href="#">Configuring the I/O device</a> (📖 34)	
8.	<a href="#">Logging in on the controller with the »PLC Designer«</a> (📖 34) With the log-in, the I/O device configuration is loaded into the controller.	

# 6 Commissioning of the PROFINET

## 6.2 The commissioning steps in detail

---

### 6.2 The commissioning steps in detail

In the following sections, the individual commissioning steps are described.

Follow the instructions of these sections step by step in order to commission your system.



More detailed information about how to work with the Lenze Engineering tools can be found in the corresponding manuals and online helps.

#### 6.2.1 Planning the bus topology

Before installing a PROFINET network, make a diagram of the network.



##### How to plan the bus topology for your configuration

1. Create an overview of the planned PROFINET network with all field devices to be integrated.
2. Start with the I/O master.
3. Add the other field devices (I/O devices) below.

#### 6.2.2 Installing field devices

For the installation of a field device, follow the mounting instructions for the respective device.



##### Mounting instructions of the field devices

Observe the safety instructions.



# 6 Commissioning of the PROFINET

## 6.2 The commissioning steps in detail

---

### 6.2.3 Create a project folder

Create a project folder on the Engineering PC.

Use this project folder to store the data generated in the following different project configuration steps:

- Project data created in the »Engineer« or »EASY Starter«
- The project file created in the »PLC Designer«



#### Tip!

Create a separate project folder for every PROFINET configuration and store the project files.

### 6.2.4 Commission the field devices

Parameterise the Lenze field devices connected to the PROFINET network by means of the »Engineer« or »EASY Starter«.

The PROFINET Lenze Controller is exclusively configured using the »PLC Designer«.

Other Lenze field devices receive their PROFINET configuration from the higher-level control (e.g. via the »STEP7« project of a Siemens SIMATIC S7 PLC). PROFINET settings, which might be made by »Engineer«/»EASY Starter«, will be overwritten.



#### Documentation of the Lenze field devices

Here you are provided with some detailed information relating to the commissioning of the Lenze field devices.



#### Tip!

We recommend to commission each field device individually and then integrate them into the PLC program.

### 6.2.5 Importing missing devices / device description files

A device description file contains the data of the fieldbus peripherals needed for the higher-level control. This file is required to programme the higher-level control (e.g. via the »STEP7« project of a Siemens SIMATIC S7 PLC).

With the »PLC Designer«, device descriptions for the following Lenze device series are installed as well:

- i700 servo inverter
- Servo Drives 9400
- Inverter Drives 8400
- I/O system 1000 (EPM-Sxxx)
- Fieldbus communication cards for Lenze Controllers (EtherCAT, CANopen, PROFIBUS, PROFINET)

In order to furthermore integrate missing devices or devices of other manufacturers, the corresponding device description files of the manufacturer are required.

In the »PLC Designer« you can import device description files of the \*.XML, \*.devdesc.XML, \*.EDS, \*.DCF, and \*.GSx type via the menu command **Tools → Device Repository...**

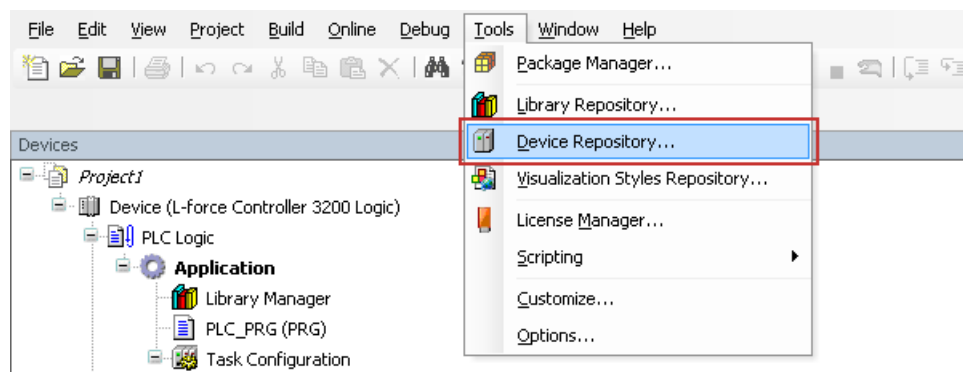

#### Tip!

Current device description files for Lenze devices can be found in the "Download" area at:

[www.lenze.com](http://www.lenze.com)

### 6.2.6 Creating a PLC program with a target system (Logic)

By means of the »PLC Designer« you can map the network topology in the control configuration.



#### Tip!

In the »PLC Designer«, PROFINET stations and stations of other fieldbus systems can be configured.

▶ [Mixed operation PROFINET with EtherCAT](#) (📖 35)



#### How to create a PLC program in »PLC Designer«

1. Use the menu command **File** → **New project** to create a new »PLC Designer« project.
2. Select "Standard project" in the New project **1** dialog box.

A "Standard project" simplifies the structure of a project in the »PLC Designer«; for instance, a device tree structure with a target system, PLC logic, etc. is provided.

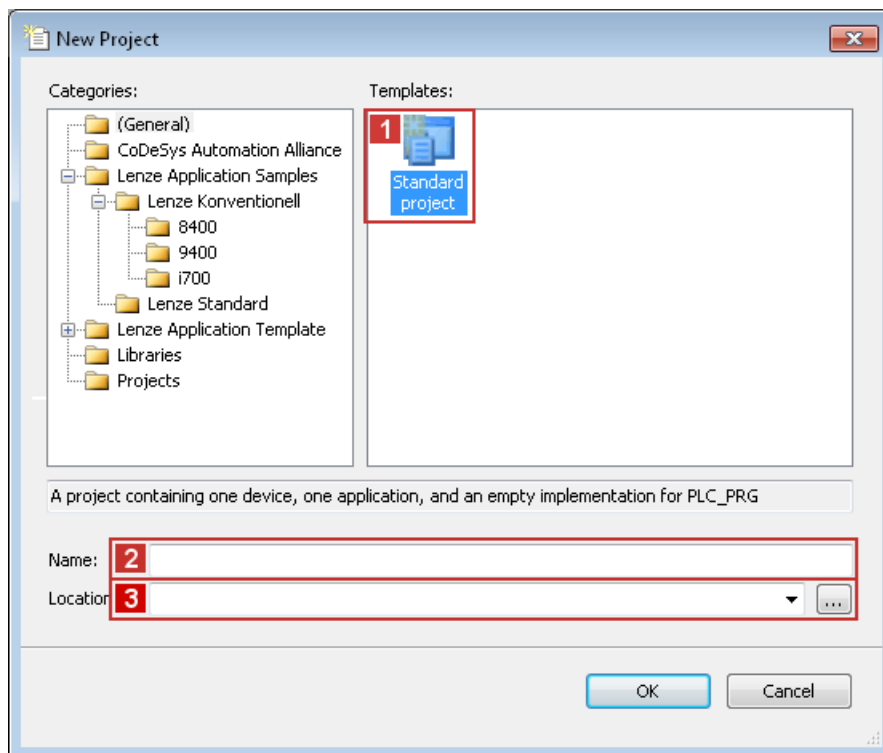

- Go to the **2** **Name** input field and enter a name for your »PLC Designer« project.
  - Select the previously created project folder as storage location in the **3** **Location** selection field. ▶ [Create a project folder](#) (📖 25)
3. Confirm the entries by clicking **OK**.

4. Go to the Standard project dialog window and select the target system in the **1 Controller type** selection field:

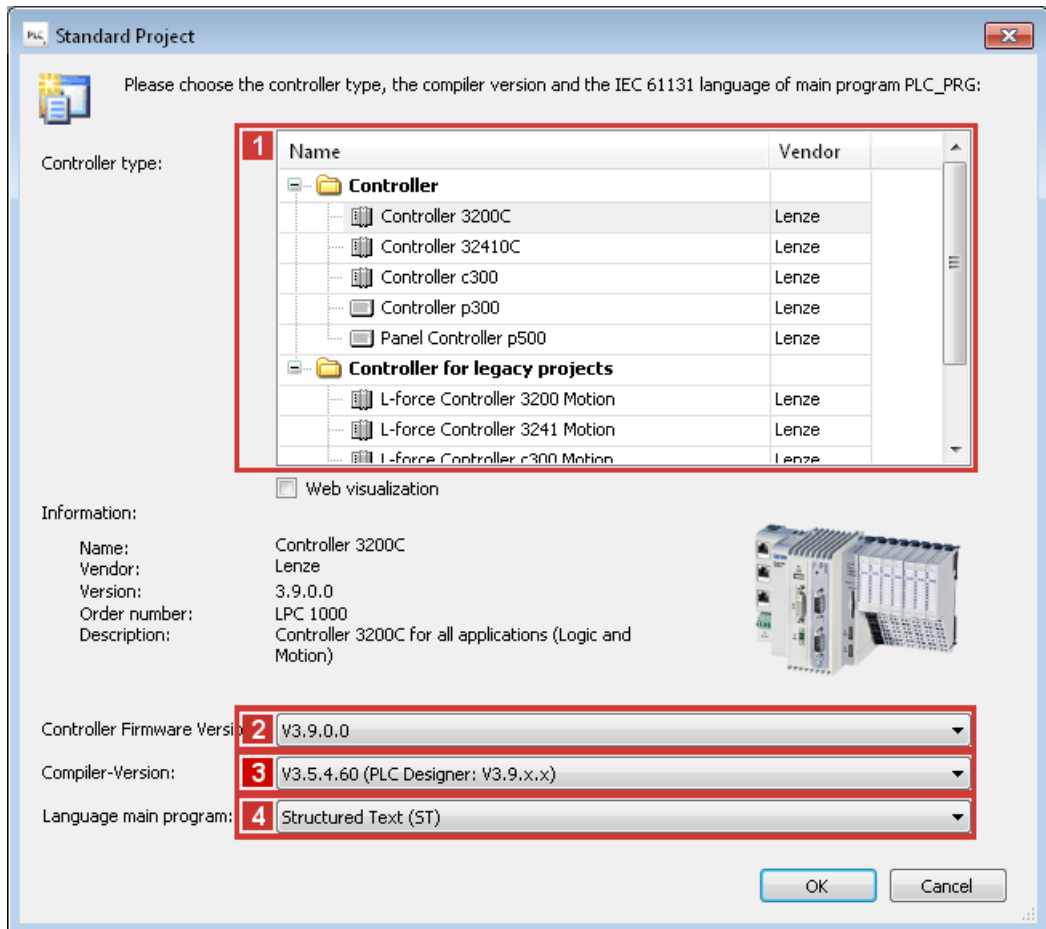

#### Further optional project settings

- 2** Selection of the Controller firmware version
  - 3** Selection of the compiler version
  - 4** Selection of the programming language:
    - Sequential function chart (AS)
    - Instruction list (AWL)
    - Continuous Function Chart (CFC)
    - Function block diagram (FUP)
    - Ladder diagram (KOP)
    - Structured text (ST)
5. Confirm the selection by clicking **OK**.

### 6.2.7 Configuring the communication parameters

Set the communication parameters to establish an online connection to the Lenze Controller later on.



**How to configure the communication parameters:**

1. Go to the **Communication settings** tab of the target system (device, Lenze Controller ...) and click the **1 Add gateway...** button.

Then go to the Gateway dialog box and enter the **2 IP address** of the controller. (By double-clicking the predefined value it can be overwritten.)

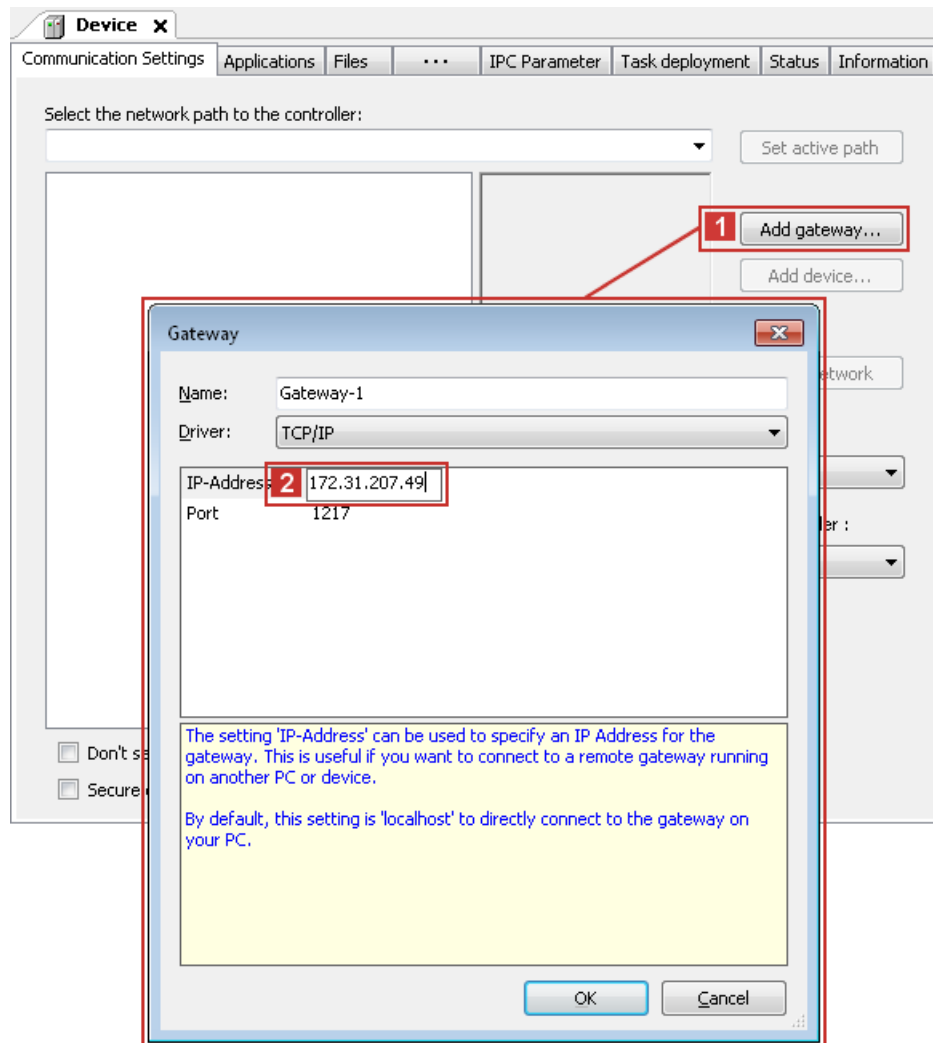

2. Confirm the entry by clicking **OK**.

3. Click the **Scan network** button.

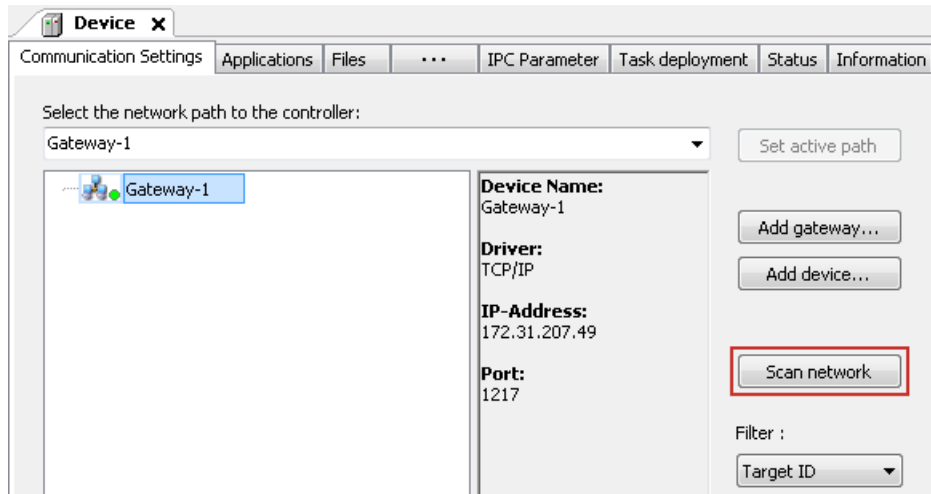

4. Select the suitable **1** controller for the IP address entered under 2. and activate it by means of the **2** **Set active path** button (or by double-click).

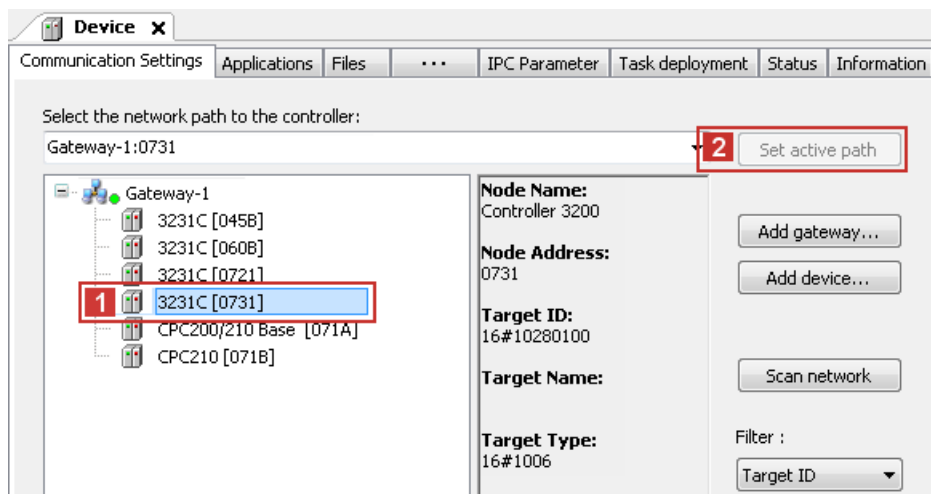

5. Now you can carry out the following actions using the »PLC Designer«:
  - ▶ [Logging in on the controller with the »PLC Designer«](#) (34)

6.2.8 Creating a control configuration (adding field devices)



**Note!**

The PROFINET Lenze Controller is exclusively configured using the »PLC Designer«. Other Lenze field devices receive their PROFINET configuration from the higher-level control (e.g. via the »STEP7« project of a Siemens SIMATIC S7 PLC).



**How to create the control configuration in the »PLC Designer«:**

1. Go to the context menu of the target system (device, Lenze Controller ...) and use the **1** Add device command to extend the control configuration by the **2** PROFINET I/O device.

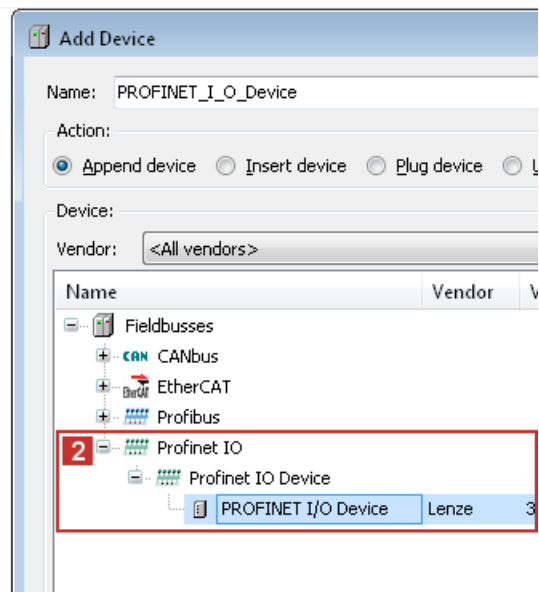
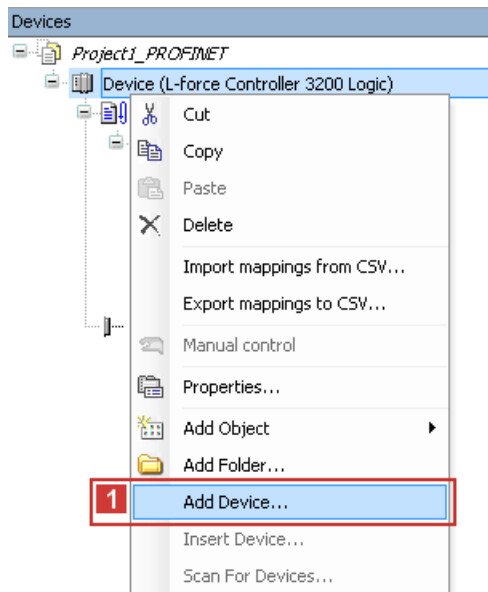

# 6 Commissioning of the PROFINET

## 6.2 The commissioning steps in detail

2. Name the inserted I/O device sensibly (e.g. "Drive\_vertical\_3221C\_1").

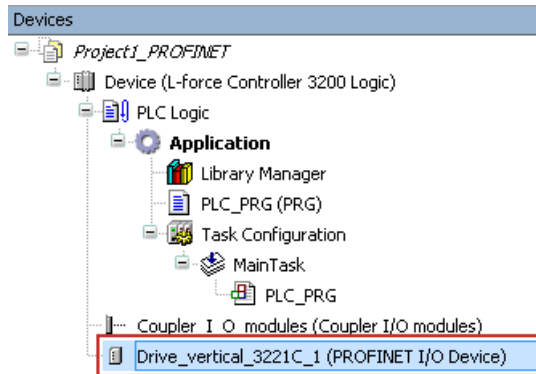

You can enter a name by clicking on the element.

The names must ...

- only contain the characters "A ... Z", "a ... z", "0 ... 9" or "\_";
- must not begin with a digit.

3. Execute the **Add device** command in the context menu of the I/O device.

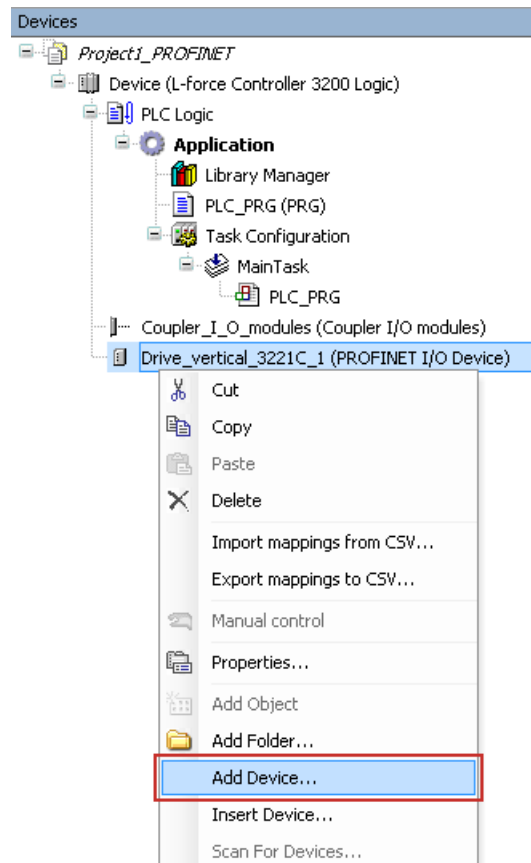



4. Select the **1** I/O modules to be used for the I/O device in the "Add device" dialog window and add it to the I/O device by using the **2** Add device button.



### Note!

The I/O modules defined by Lenze behave consistently.

If the value of a consistent module changes, the entire module is written on the bus in the same cycle.

In order to guarantee consistent data between master and slave, make sure that the master supports consistent modules as well.

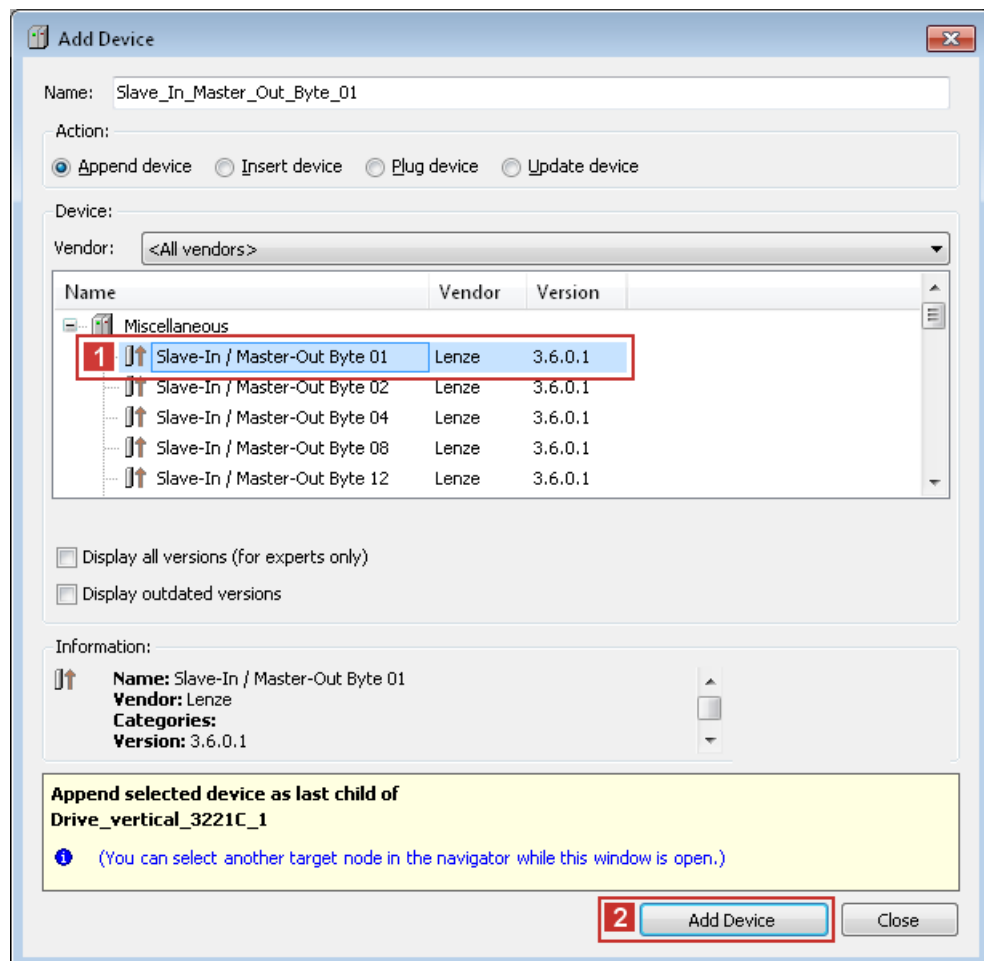

5. Repeat the steps 1. ... 4. for further Lenze Controllers connected to the PROFINET.

# 6 Commissioning of the PROFINET

## 6.2 The commissioning steps in detail

### 6.2.9 Configuring the I/O device

Set the IP address, subnet mask, gateway address and the station name of the I/O device in the **PNIO identification** tab.

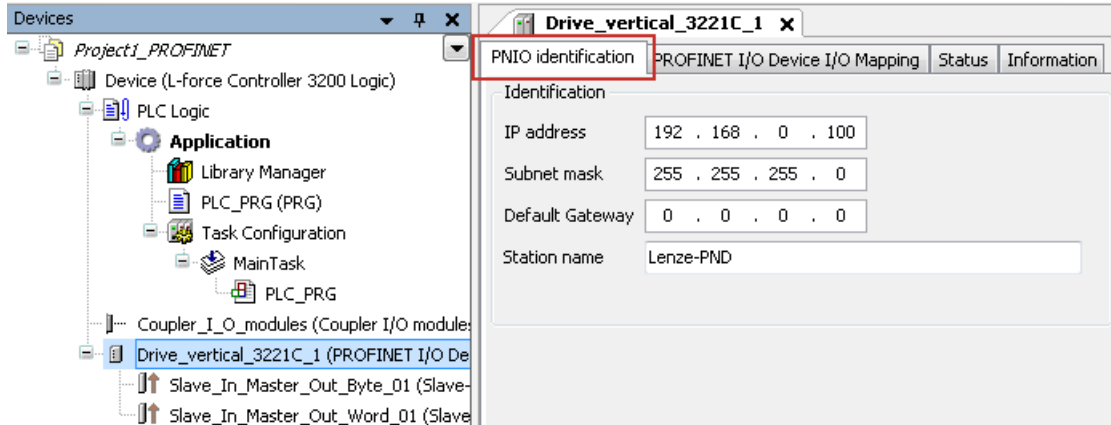

- Within the PROFINET network, the IP address of the I/O device has to be unambiguous.
- You do not have to set a baud rate as the I/O device automatically accepts the settings of the I/O master.

### 6.2.10 Logging in on the controller with the »PLC Designer«

Use the menu command **Online** → **Login** or **<Alt>+<F8>** to log in on the Lenze Controller.

With the log-in, the I/O device configuration is loaded into the controller. In this process, a configuration, if available, will be overwritten.

## 7 Mixed operation PROFINET with EtherCAT

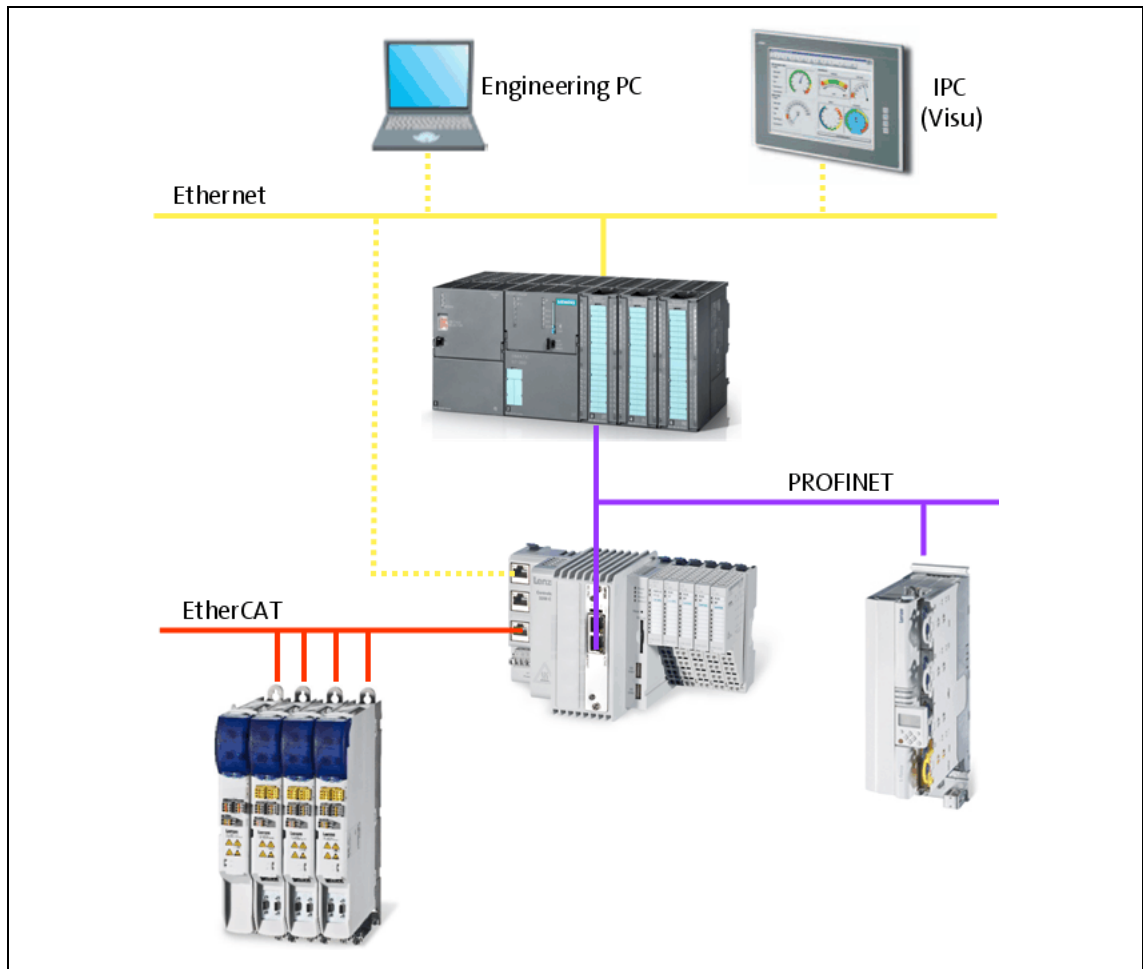

[7-1] Example: Mixed operation of PROFINET with EtherCAT on the Lenze Controller 3221 C

Within the Lenze Controller-based Automation, PROFINET can be used in parallel to the EtherCAT bus system. This is useful if not all devices are available for the same bus system or if EtherCAT is required in parallel to PROFINET.



### Controller-based Automation EtherCAT communication manual

Here you can find detailed information on how to commission EtherCAT components.

# 8 Defining the cycle time of the PLC project

## 8.1 Determining the task utilisation of the application

# 8 Defining the cycle time of the PLC project

In this chapter you'll learn how to ...

- [Determining the task utilisation of the application](#) (36);
- [Optimising the system](#) (38).

## 8.1 Determining the task utilisation of the application

In the online mode, the **Monitor** tab of the **Task Configuration** shows current status details and measurements of the cycles, cycle times, and jitters of the tasks contained.

The screenshot shows the 'Task Configuration' window in the 'Monitor' tab. The window displays a tree view of the PLC project structure, including the 'Application [stop]' and 'PND\_Task' components. Below the tree view, a table provides performance metrics for the 'PND\_Task'.

Task	Status	IEC-Cycle Count	Cycle Count	Last Cycle Time (µs)	Average Cycle Time (µs)	Max. Cycle Time (µs)	Min. Cycle Time (µs)
PND_Task	Valid	40789	46419	344	277	399	44

The values are updated in the same time interval as that used for monitoring the values from the controller.

If the cursor is on a task name field, the values displayed can be reset to 0 by the **Reset** context menu command (right-click the task name field).

**How to determine the task utilisation:**

**Initial situation:** A complete project, e.g. with a PROFINET task and 2 lower priority tasks has been created.

1. For a first measurement of the task utilisation, set the cycle times of all cyclic tasks available in the PLC system "high" (e.g. PROFINET task = 10 ms, all other cyclic tasks = 20 ms).
2. Use the menu command **Online → Login**, or log in on the Lenze Controller with **<Alt>+<F8>**.  
With the log-in, the I/O device configuration is loaded into the controller.
3. Reset the values displayed on the **Monitor** tab of the **Task Configuration** to 0 after the complete run-up of the system.  
Execute the **Reset** command from the context menu of the task name field.
4. Read the displayed maximum computing time of the task with the highest priority.  
In the illustration above, the max. cycle time of the PROFINET task is 399  $\mu$ s.  
The task cycle time does not have to be faster than the set PROFINET cycle time.

## 8.2 Optimising the system



### How to optimise the system:

1. Use the menu command **Online → Login**, or log in on the Lenze Controller with **<Alt>+<F8>**.  
With the log-in, the I/O device configuration is loaded into the controller.
2. Check the task processing times.
3. Optimising the cycle times:
  - If technologically required, the cycle times of the remaining tasks with lower priorities can be decreased.
  - Condition: No task with a low priority must assign more than 60 percent of the corresponding cycle time in its task utilisation.

## 9 Diagnostics

The PROFINET field devices, communication modules and the MC-PND communication card are provided with LED status displays for diagnostics.

Furthermore, the »PLC Designer« provides a function library for diagnosing PROFINET.



### Note!

#### Siemens »STEP7«: "Node blinking test"

SIEMENS »STEP7« provides a "node blinking test" which permits an optical verification of the physical connection between the Siemens S7-PLC and a PROFINET node (I/O device).

Here, both LEDs are blinking at the RJ45 socket of the I/O device.

In »STEP7« version 5.5, this function is defective and does not create the wanted result.



### Documentation of the field devices / PROFINET communication modules

Here you'll find some detailed information on the LED status displays of the field devices and communication modules.

**9.1 LED status displays of the MC-PND communication card**

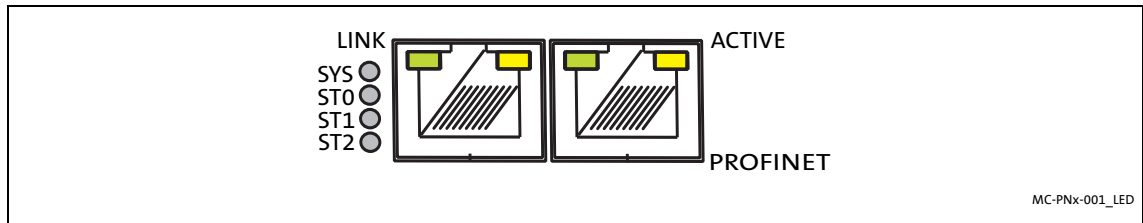

[9-1] LED status displays of the MC-PND communication card

LED	Colour	Status	Beschreibung
SYS	Green	On	Operating system is running
	Yellow	Blinking once per second (1 Hz)	Error during boot process
		On	Boot loader waits for boot process
	-	Off	No voltage supply or hardware is defective.
ST0	Red	On	System error: Watchdog timeout Channel, generic or extended diagnostics is available.
		Blinking once per second (1 Hz)	DCP signal is triggered via fieldbus.
		Off	No error
ST1	Red	On	No configuration or too slow physical connection or no physical connection
		Blinking 2 times per second (2 Hz)	No data exchange
		Off	No error
ST2	-	-	No function
Link	Green	On	Connection to Ethernet has been established.
		Off	No connection to Ethernet
Active	Yellow	Blinking	Device transmits/receives Ethernet frames



## 9.2 Diagnostics in the »PLC Designer«

Only if an online connection to the Lenze Controller has been established, the **Status** tab displays information on the **1 PROFINET status** and **2 I/O device statuses**:

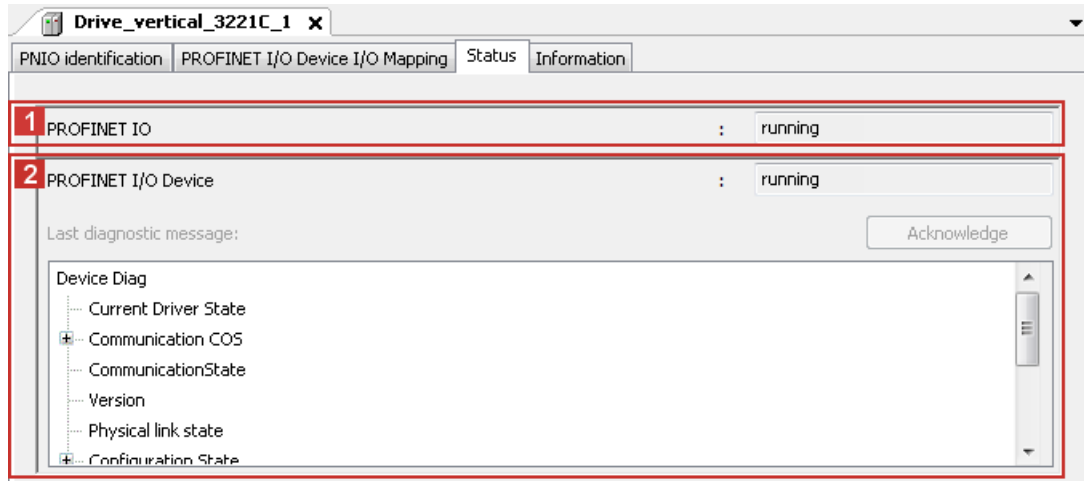

## 10 Parameter reference

This chapter complements the parameter list in the online help of the Lenze Controller by the parameters of the **MC-PND communication card**.

These parameters ...

- are for instance shown in the Lenze »WebConfig« (Engineering tool for web-based parameterisation);
- are listed in numerically ascending order.

### C1031

Parameter   Name: <b>C1031   Device: type key</b>	Data type: VISIBLE_STRING Index: 23544 = 0x5BF8
Identification of the card	
<input checked="" type="checkbox"/> Read access <input type="checkbox"/> Write access <input type="checkbox"/> CINH <input type="checkbox"/> PLC-STOP <input type="checkbox"/> No transfer	

### C1032

Parameter   Name: <b>C1032   Device: type version</b>	Data type: VISIBLE_STRING Index: 23543 = 0x5BF7
Version number of the card	
<input checked="" type="checkbox"/> Read access <input type="checkbox"/> Write access <input type="checkbox"/> CINH <input type="checkbox"/> PLC-STOP <input type="checkbox"/> No transfer	

### C1033

Parameter   Name: <b>C1033   Device: name</b>	Data type: VISIBLE_STRING Index: 23542 = 0x5BF6
Device name of the card	
<input checked="" type="checkbox"/> Read access <input type="checkbox"/> Write access <input type="checkbox"/> CINH <input type="checkbox"/> PLC-STOP <input type="checkbox"/> No transfer	

### C1034

Parameter   Name: <b>C1034   Device: software revision</b>	Data type: VISIBLE_STRING Index: 23541 = 0x5BF5
Software version of the card	
<input checked="" type="checkbox"/> Read access <input type="checkbox"/> Write access <input type="checkbox"/> CINH <input type="checkbox"/> PLC-STOP <input type="checkbox"/> No transfer	

### C1035

Parameter   Name: <b>C1035   Device: hardware revision</b>	Data type: VISIBLE_STRING Index: 23540 = 0x5BF4
Hardware version of the card	
<input checked="" type="checkbox"/> Read access <input type="checkbox"/> Write access <input type="checkbox"/> CINH <input type="checkbox"/> PLC-STOP <input type="checkbox"/> No transfer	

### C1036

Parameter   Name: <b>C1036   Device: serial number</b>	Data type: VISIBLE_STRING Index: 23539 = 0x5BF3
Serial number of the card	
<input checked="" type="checkbox"/> Read access <input type="checkbox"/> Write access <input type="checkbox"/> CINH <input type="checkbox"/> PLC-STOP <input type="checkbox"/> No transfer	

# 10 Parameter reference

---

## C1037

Parameter   Name: <b>C1037   Device: manufacturer</b>	Data type: VISIBLE_STRING Index: 23538 = 0x5BF2
Manufacturer of the card	
<input checked="" type="checkbox"/> Read access <input type="checkbox"/> Write access <input type="checkbox"/> CINH <input type="checkbox"/> PLC-STOP <input type="checkbox"/> No transfer	

## C1038

Parameter   Name: <b>C1038   Device: manufacturing date</b>	Data type: VISIBLE_STRING Index: 23537 = 0x5BF1
Manufacturing date of the card	
<input checked="" type="checkbox"/> Read access <input type="checkbox"/> Write access <input type="checkbox"/> CINH <input type="checkbox"/> PLC-STOP <input type="checkbox"/> No transfer	

## A

Adding devices [31](#)  
Adding field devices [31](#)  
Application notes [9](#)  
Application software of the Lenze Controllers [13](#)

## C

C1031 | Device: Identification [42](#)  
C1032 | Device: Version [42](#)  
C1033 | Device: Name [42](#)  
C1034 | Device: Software version [42](#)  
C1035 | Device: Hardware version [42](#)  
C1036 | Device: Serial number [42](#)  
C1037 | Device: Manufacturer [43](#)  
C1038 | Device: Manufacturing date [43](#)  
Cable length (max.) [21](#)  
Cable type [21](#)  
Codes [42](#)  
Commission the field devices [25](#)  
Commissioning of the PROFINET [23](#)  
Communication medium [21](#)  
Communication profile [21](#)  
Communication settings [29](#)  
Communication type [21](#)  
Configuring the communication parameters [29](#)  
Configuring the I/O device [34](#)  
Conventions used [6](#)  
Create a project folder [25](#)  
Creating a control configuration [31](#)  
Creating a PLC program with a target system (Logic) [27](#)  
Creating a target system (Logic) [27](#)  
Cycle time [21](#)

## D

Defining the cycle time of the PLC project [36](#)  
Determining the task utilisation of the application [36](#)  
Device  
  Hardware version (C1035) [42](#)  
  Identification (C1031) [42](#)  
  Manufacturer (C1037) [43](#)  
  Manufacturing date (C1038) [43](#)  
  Name (C1033) [42](#)  
  Serial number (C1036) [42](#)  
  Software version (C1034) [42](#)  
  Version (C1032) [42](#)  
Diagnostics [39](#)  
Diagnostics with the »PLC Designer« [41](#)

## E

EASY Navigator [20](#)  
E-mail to Lenze [46](#)  
Engineering software [20](#)  
Engineering tools [20](#)

## F

Feedback to Lenze [46](#)  
Field devices [18](#)  
Fieldbus communication (interfaces) [14](#)  
Functions of the MC-PND communication card [21](#)

## G

GSDML file for configuration [16](#)

## I

I/O data [21](#)  
Importing device description files [26](#)  
Importing missing devices [26](#)  
Installing field devices [24](#)  
Interfaces for fieldbus communication [14](#)

## L

Layout of the safety instructions [9](#)  
LED status displays of the MC-PND communication card [40](#)  
Lenze Engineering tools [20](#)  
Logging in on the controller [34](#)  
Logging in on the controller with the »PLC Designer« [34](#)

## M

MC-PND communication card [19](#)  
MC-PND communication card, LED status displays [40](#)  
MC-PND communication card, technical data [21](#)  
Mixed operation PROFINET with EtherCAT [35](#)

## N

Network topology [17](#), [21](#)

## O

Optimising the system [38](#)

## P

Parameter reference [42](#)  
PDO data [21](#)  
PNIO identification [34](#)  
PROFINET [15](#)  
PROFINET connection [22](#)  
PROFINET hardware for Lenze Controllers [19](#)  
PROFINET system (structure) [16](#)  
PROFINET with EtherCAT (mixed operation) [35](#)

# Index

---

## S

Safety instructions [9](#), [10](#)

Screenshots [4](#)

Software [20](#)

Special features of the MC-PND communication card [21](#)

Status [41](#)

Status displays of the MC-PND communication card [40](#)

Structure of the PROFINET system [16](#)

System structure of Controller-based Automation [12](#)

## T

Target group [4](#)

Task configuration [36](#)

Technical data [21](#)

Technical data of the MC-PND communication card [21](#)

Terms [7](#)

Type within the network [21](#)

# FEEDBACK



## Your opinion is important to us

These instructions were created to the best of our knowledge and belief to give you the best possible support for handling our product.

Perhaps we have not succeeded in achieving this objective in every respect. If you have suggestions for improvement, please e-mail us to:

[feedback-docu@lenze.com](mailto:feedback-docu@lenze.com)

Thank you very much for your support.

*Your Lenze documentation team*

Lenze Automation GmbH  
Postfach 10 13 52, 31763 Hameln  
Hans-Lenze-Straße 1, 31855 Aerzen  
GERMANY  
HR Hannover B 205381  
☎ +49 5154 82-0  
📠 +49 5154 82-2800  
✉ [lenze@lenze.com](mailto:lenze@lenze.com)  
🌐 [www.lenze.com](http://www.lenze.com)

#### **Service**

Lenze Service GmbH  
Breslauer Straße 3, 32699 Extertal  
GERMANY  
☎ 008000 24 46877 (24 h helpline)  
📠 +49 5154 82-1112  
✉ [service@lenze.com](mailto:service@lenze.com)