



Dow Building Solutions

Complete Solutions for Commercial Construction

Thermal, Air & Moisture Management for the Building Envelope





Installed in
over 20 million
buildings worldwide,
STYROFOAM™ Brand
XPS Foam Insulation
insulates over
20 billion ft², saving
over \$10 billion in
energy costs annually.

Designed to Perform

Since the introduction of STYROFOAM™ Brand Extruded Polystyrene (XPS) Foam Insulation more than 65 years ago, Dow Building Solutions has helped address all of these issues by employing a design philosophy focused on a variety of building envelope solutions that offer:

- **Durability & Sustainability** – High-performance building products from Dow are not only designed to perform a specific function, they are designed to last, thereby lowering greenhouse gas (GHG) emissions for the life of a building. This is key to sustainability and has been proven, over and over in real buildings under real-world conditions.
- **Innovation** – New products and integrated systems answer the continually changing needs of the construction industry. Dow's three-in-one THERMAX™ Wall System and the Ultra Wall Air Barrier System both meet continuous insulation requirements and offer a simplified solution to help reduce time and money for builders.
- **Comfort** – Insulation and sealant products from Dow manage air infiltration and moisture to reduce condensation and minimize mold and mildew formation.
- **Energy Efficiency** – Dow insulation, sealant and complementary products enhance the building envelope, reducing fuel consumption.
- **Building Science Expertise** – Our building envelope solutions are developed by engineers and scientists with leading building science expertise.

Finally, Dow has not lost sight of a constant concern – cost. Its building envelope solutions continue to be a smart investment.

Insulate to Make a Change for the Better

Insulating a building envelope not only enhances the building’s energy efficiency, it’s a cost-effective way to reduce GHG emissions.

According to this data, an investment in insulation has the most potential for generating positive economic returns over a building’s life cycle, while helping reduce GHG emissions. Starting first with the lowest marginal cost GHG abatement options – insulation improvements – can have an immediate positive impact on the environment, on the sustainability of buildings around the world and on the bottom line for businesses globally.

Research results are consistent with what Dow and the building industry have known for many years: **Building insulation is one of the best ways to reduce GHG emissions, save money and boost economic growth.**

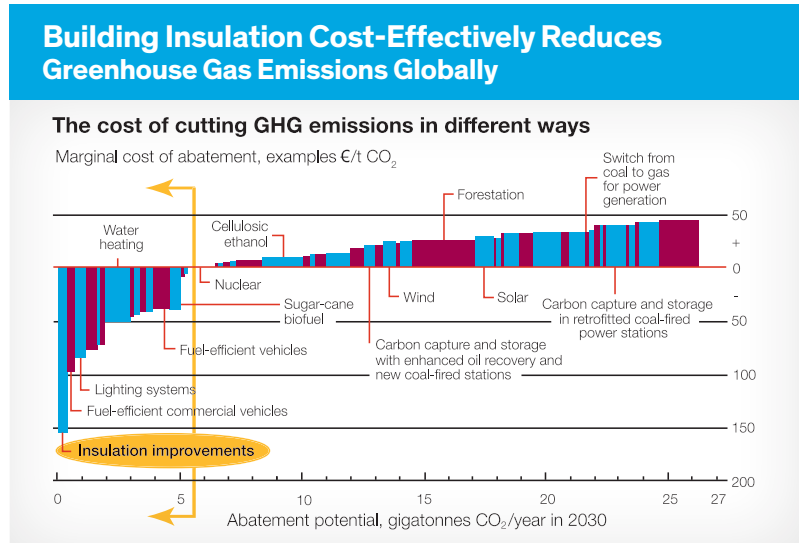

Source: Study conducted by McKinsey & Company, and Vattenfall

McKinsey & Company studied the costs of implementing various GHG abatement options. “Insulation improvements” is among the more economical measures at the left of the arrows that provide the fastest payback and should be implemented before doing any of the other measures. And as the graph shows, “insulation improvements” is by far the best measure in terms of a negative marginal cost. This graph represents only a few of the abatement options researched. For the graph in its entirety, visit www.mckinseyquarterly.com/A_cost_curve_for_greenhouse_gas_reduction_1911.

Meet LEED and Beyond

The U.S. Green Building Council’s Leadership in Energy and Environmental Design (LEED) system is a voluntary, consensus based standard that recognizes the life-cycle costing of construction. Through the LEED program, design professionals accumulate credits based on meeting criteria for the use of environmentally friendly, sustainable and energy-efficient products and systems.

The number of LEED certified federal building projects in the U.S. increased by more than 50 percent from 2011 to 2012* and the payback time from energy savings is continuing to decrease.

From the architect’s plan to the builder’s energy-efficiency mindset, Dow is ready to help turn the entire vision into a highly functional building with the owner’s bottom line and the global environment as top priorities.

For more information about LEED, visit www.usgbc.org.

*Source: <http://www.usgbc.org/articles/green-building-facts>

Buildings consume 40% of US energy and emit over 1/3 of US greenhouse gas emissions.
– USGBC

Leading Products

Energy-efficient Dow products may contribute to significant LEED credits in a wide range of commercial foundation/slab, roof and wall applications. Our brand-leading offering includes:

- STYROFOAM™ Brand Extruded Polystyrene Foam Insulation
- THERMAX™ Polyisocyanurate Insulation
- THERMAX™ Wall System
- STYROFOAM™ Brand Spray Polyurethane Foam (CM Series) Insulation
- FROTH-PAK™ Foam Insulation and FROTH-PAK™ Foam Sealant
- GREAT STUFF PRO™ Insulating Foam Sealants
- WEATHERMATE™ Straight Flashing
- INSTA STIK™ Quik Set Commercial Roofing Adhesive
- TILE BOND™ Roof Tile Adhesive
- Ultra Air Barrier Wall System

Walls

Interior and Exterior

With rigid foam insulation from Dow on the walls, your building can perform more efficiently. Both the **The Ultra Air Barrier Wall System** and **Thermax Wall System** meet ASTM E2357 wall assembly test and ASHRAE 90.1 for continuous insulation and air barriers. It passed ASTM E331 water leakage test and is an approved air barrier assembly by the Air Barrier Association of America (ABAA).

These products offer:

- Excellent long-term thermal performance
- Moisture resistance
- Ease of use
- Reusability in some situations

Note: Applicable codes may require a 15-minute thermal barrier between insulation and occupied space.

The Ultra Air Barrier Wall System

The Ultra Air Barrier Wall System featuring STYROFOAM™ Brand Ultra SL Insulation with shiplap edges and LIQUIDARMOR™ - CM Flashing and Sealant Tape, provides designers a simple solution for exceptional long-term thermal insulating performance and excellent air/vapor and moisture barrier capability in steel stud backup in one solution.

- Meets NFPA 285 requirements*
- Continuous insulation, air and water barrier – one system – brick & block and steel stud backup wall applications.
- Long-term insulating value
- Meets prescriptive option for air barriers as required in both ASHRAE 90.1 and IECC
- Tested in accordance with ASTM E2357 “Standard Test Method for Determining Air Leakage of Air Barrier Assemblies”
- Approved by the Air Barrier Association of America as an air barrier
- Passed ASTM E331 water leakage test

Product:

- STYROFOAM™ Brand Ultra SL Insulation
- LIQUIDARMOR™ - CM Flashing and Sealant

THERMAX™ Wall System

Install THERMAX XARMOR™(ci) Exterior Insulation over steel studs with sheathing joints and other thru-wall penetrations protected by LIQUIDARMOR™ - CM Flashing and Sealant. After closing in the building, create an effective air barrier by spraying STYROFOAM™ Brand SPF (CM Series) on the interior of the THERMAX XARMOR™(ci) Exterior Insulation in the stud cavity.

- Three-in-one construction for maximum design efficiency
- Integral, durable acrylic-coated aluminum facer provides drainage plane and water-resistive barrier
- Lightweight sheathing weighs just 12 lbs per board, speeding up the construction process
- Meets ASHRAE 90.1 prescriptive requirements for continuous insulation
- Patent pending continuous insulation system
- Has approved NFPA 285 behind various cladding including metal panel & composites, cementitious siding, brick, stucco, and terracotta.*

Products:

- THERMAX XARMOR™ (ci) Exterior Insulation
- LIQUIDARMOR™ - CM Flashing and Sealant
- STYROFOAM™ Brand Spray Polyurethane Foam† (SPF) (CM Series)

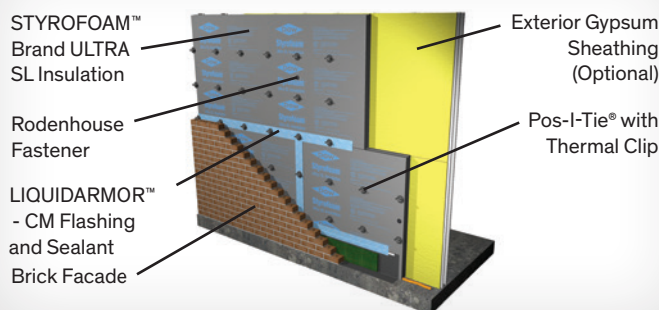

Ultra Wall Air Barrier System combines insulating power of STYROFOAM™ Brand Ultra SL Insulation and LIQUIDARMOR™ - CM Flashing and Sealant in one easy-to-install system that deliver continuous insulation performance and an air/vapor and moisture barrier

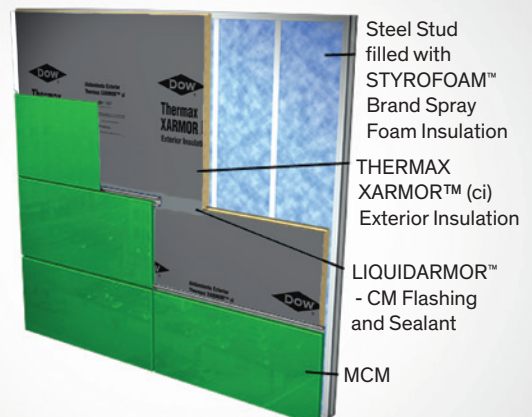

For more detailed installation information, contact your Dow representative or refer to the product literature.

*Meets NFPA 285 per Section 2603.5.5 of the building code. For specific assemblies see code report ESR 2142.

†STYROFOAM™ Brand Spray Polyurethane Foam should be installed by a trained SPF applicator wearing protective clothing, gloves, goggles and proper respiratory protection. Consult the instructions and Material Safety Data Sheets carefully before use.

Exterior Cavity Wall – Block Backed

The Ultra Air Barrier Wall System is a tested wall assembly for brick and block wall providing long-term continuous insulation and excellent air/vapor and moisture barrier properties in one system. The Ultra Air Barrier Wall System meets ASTM E2357 wall assembly test and ASHRAE 90.1 for continuous insulation and air barriers. It passed ASTM E331 water leakage test and is an approved air barrier assembly by the Air Barrier Association of America (ABAA).

- Meets NFPA 285 requirements**

Products:

- STYROFOAM™ Brand CAVITYMATE™ Ultra Insulation 15-3/4" or 16" width
- GREAT STUFF PRO™ Gaps & Cracks Insulating Foam Sealant*

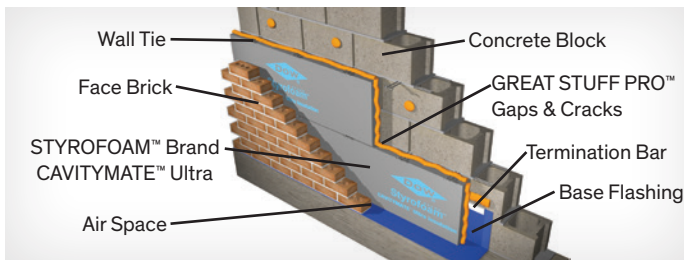

Ultra Wall Air Barrier System combines insulating power of STYROFOAM™ Brand CAVITYMATE™ Ultra Insulation and the exceptional air sealing capabilities of GREAT STUFF PRO™ Gaps & Cracks Insulating Foam Sealant in one easy-to-install system that deliver continuous insulation performance and an air/vapor and moisture barrier

Application:

Install insulation on the exterior of block-backed cavity walls.

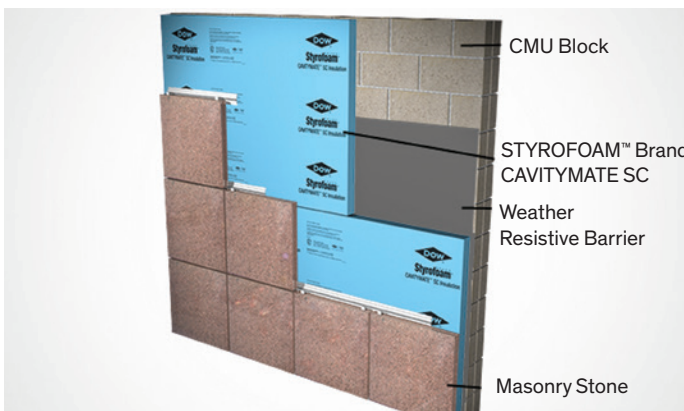

STYROFOAM™ Brand CAVITYMATE™ Insulation is designed specifically for moist cavity wall environments. Manufactured with distinct carbon block technology to absorb infrared radiation, STYROFOAM™ Brand CAVITYMATE™ Ultra Insulation has an R-value of 5.6 per inch - the highest of any polystyrene foam insulation and is available in 15 3/4" and 16" widths making it easy to fit between brick ties in cavity wall applications.

Metal Building

Products:

- THERMAX™ Metal Building Board
- THERMAX™ Heavy Duty
- THERMAX™ Light Duty
- THERMAX™ Sheathing

Application:

Install insulation between wall girts and metal siding.

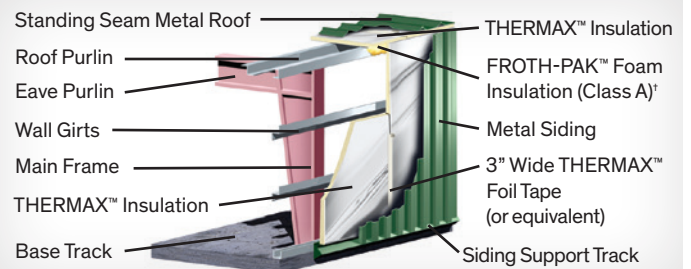

THERMAX™ Insulation products help safeguard pre-engineered metal buildings against thermal loss and moisture buildup. A variety of thicknesses and lengths up to 30' are available to meet specific design requirements.

*For air sealing the roof/wall juncture

Exterior Precast

Products:

- STYROFOAM™ Brand Square Edge Insulation
- ISOCAST™ R Insulation

Application:

Used in insulated precast, prestressed or tilt-up construction, rigid foam insulation products from Dow combine insulating capabilities with the added strength of concrete. The foam is sandwiched between two wythes of concrete and held together structurally by metal or nonconductive connectors.

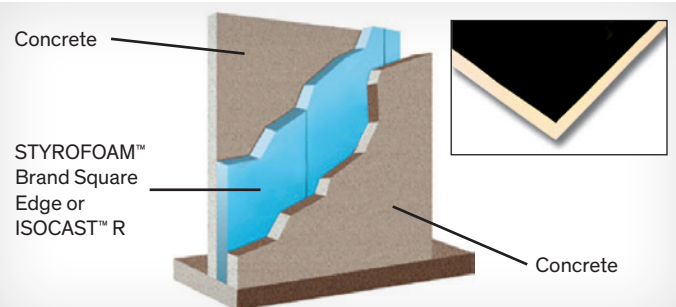

ISOCAST™ R Polyisocyanurate Insulation features a trilaminate aluminum/poly/kraft facer for strength and high R-value per inch in precast concrete walls.

For more detailed installation information, contact your Dow representative or refer to the product literature.

* Read label and MSDS carefully before use.

** Meets NFPA 285 per Section 2603.5.5 of the building code. For specific assemblies see code report ESR 2142.

Interior – Exposed Wall

Products:

- THERMAX™ White Finish
- THERMAX™ Light Duty
- THERMAX™ Heavy Duty

Application:

For best results, install against interior of structural wall with the Interlocking System joint closure. Ask your seller about other installation methods. Distinct, easy-to-clean facers of aluminum and/or acrylic-coated aluminum make THERMAX™ Polyisocyanurate Insulation ideal for exposed interior walls, adding durability and moisture control. With THERMAX™ Insulation, there is no need for drywall or gypsum board.

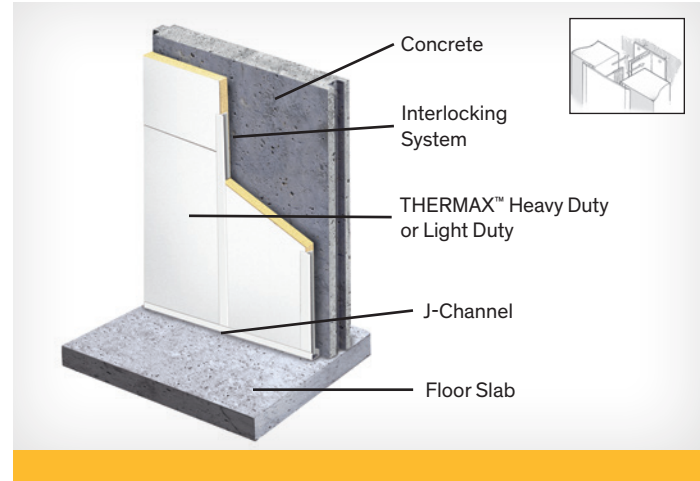

Interior – Concealed Wall

Products:

- STYROFOAM™ Brand Z-MATE™ Insulation
- STYROFOAM™ Brand Square Edge Insulation
- THERMAX™ Sheathing
- TUFF-R™ Commercial Insulation
- Super TUFF-R™ Commercial Insulation
- GREAT STUFF PRO™ Gaps & Cracks Insulating Foam Sealant*

Application:

Install rigid foam insulation between furring strips. Cover with an approved thermal barrier.

A bead of GREAT STUFF PRO™ Gaps & Cracks Insulating Foam Sealant helps to seal the wall/slab joint.

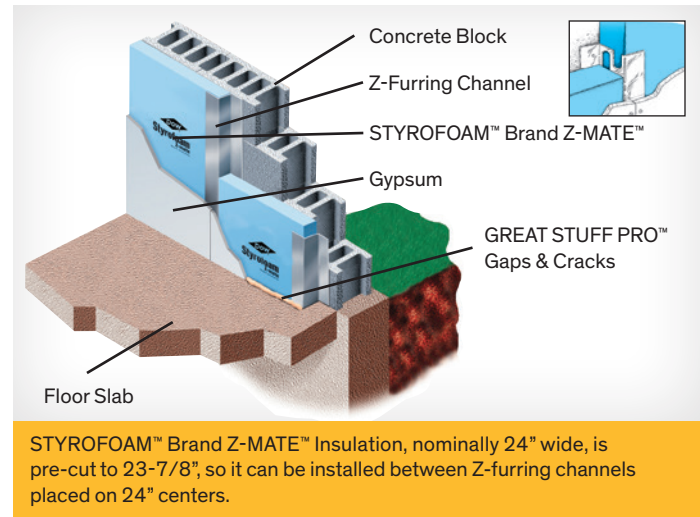

One- and Two-Component Polyurethane Foam Sealants^{††} for Air Sealing The Building Envelope

Products:

- FROTH-PAK™ Foam Insulation
- GREAT STUFF PRO™ Gaps & Cracks Insulating Foam Sealant
- GREAT STUFF PRO™ Window & Door Insulating Foam Sealant

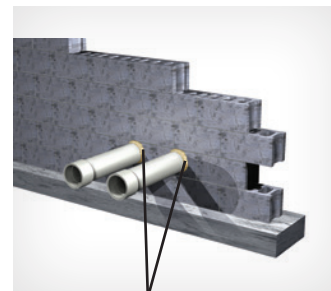

Our Insulating Foam Sealant options create an airtight and moisture-resistant seal and meet ASHRAE energy code requirements.

Foundations and Slabs

Above Grade and Below Grade

Rigid foam insulation products from Dow offer excellent insulation and moisture protection in foundation and slab applications. Extruded polystyrene foam insulation from Dow offers a combination of benefits for almost any application.

- Long-term thermal performance
- High compressive strength
- Ease of use
- Excellent moisture resistance
- Waterproofing protection

Foundations

Products:

- STYROFOAM™ Brand PERIMATE™ Insulation
- STYROFOAM™ Brand Square Edge Insulation
- STYROFOAM™ Brand Scoreboard Insulation
- DOW™ Protection Board III Insulation

Application:

Install extruded polystyrene foam insulation from Dow against the exterior foundation wall. When properly installed, the insulation resists moisture, so it offers more stable longterm R-value* in moist foundation applications.

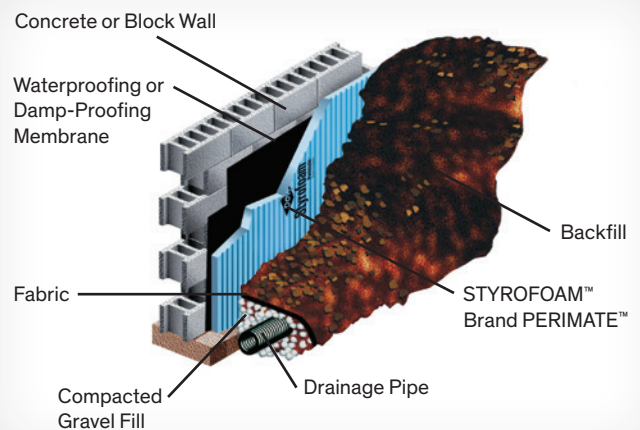

STYROFOAM™ Brand PERIMATE™ Insulation features drainage grooves to direct water away from the foundation, offering thermal insulation and drainage of subsurface soil in a single step.

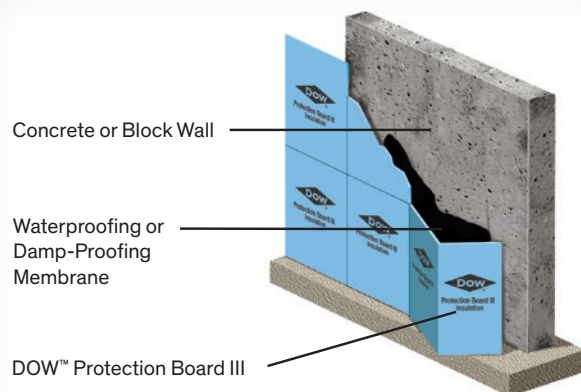

Fanfolded on 24" centers with plastic film on one side, DOW™ Protection Board III Insulation is durable yet easy to install and work with on the job site.

For additional information regarding DOW™ Protection Board III visit <http://www.adamsplasticsinc.com/>

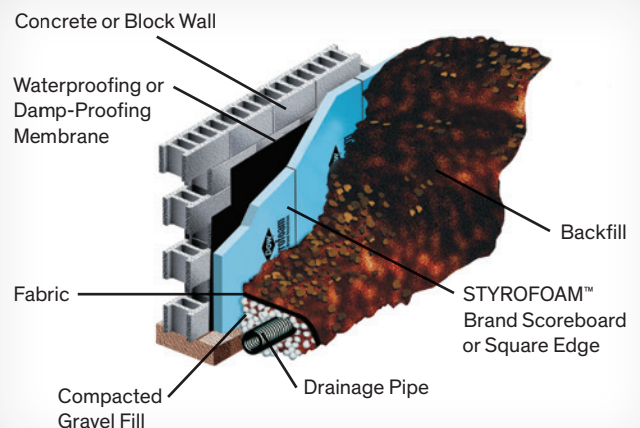

STYROFOAM™ Brand Square Edge Insulation and STYROFOAM™ Brand Scoreboard Insulation provide long-term thermal performance.

Radiant Floor – Under Slab

Products:

- STYROFOAM™ Brand Tongue and Groove Insulation
- STYROFOAM™ Brand Square Edge Insulation
- STYROFOAM™ Brand HIGHLOAD 40, 60 or 100 Insulation

Application:

Install STYROFOAM™ Brand Extruded Polystyrene Foam Insulation under the slab to help provide moisture protection and to prevent radiant floor heat from dissipating into the ground.

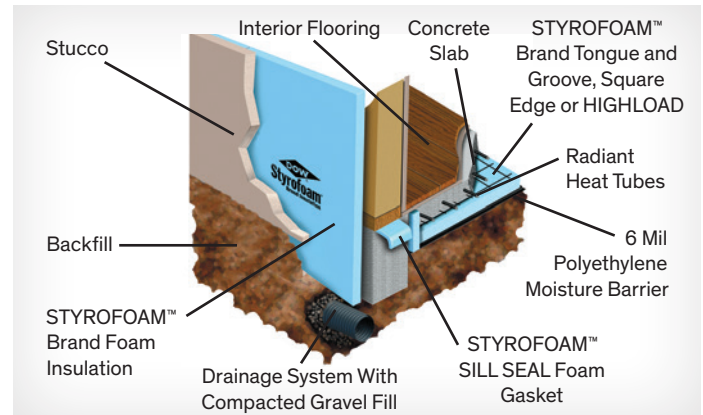

STYROFOAM™ Brand Extruded Polystyrene Foam Insulation offers excellent moisture resistance and insulating power in slab-on-grade radiant floor applications.

Radiant Floor – Over Deck/Subfloor

Products:

- STYROFOAM™ Brand Scoreboard Insulation
- STYROFOAM™ Brand Square Edge Insulation
- STYROFOAM™ Brand WALLMATE™ Insulation

Application:

Use in upper level floors in new construction or over the slab in a retrofit situation. Extruded polystyrene foam insulation from Dow helps direct radiant floor heat upward, into the room.

Consult local building code official for construction specifics.

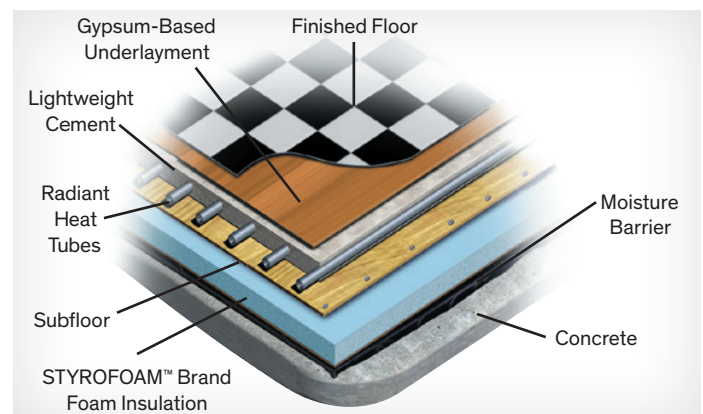

Assembly for new construction for an upper level floor or as a retrofit over existing slab. If no vapor retarder was installed under the existing slab, it is recommended to add one between the slab and the rigid foam insulation. A vapor retarder is not needed if the deck is a second-floor application.

Geotechnical

Products:

- STYROFOAM™ Brand HIGHLOAD 40, 60 or 100 Insulation
- STYROFOAM™ Brand Square Edge Insulation

Application:

Use wherever excellent load-bearing, insulating and moisture resistance capabilities are needed, including under building floor slabs; airport runways, taxiways and aprons; railroads; culverts; retaining walls; storage tank slabs; and swimming pools.

Lay STYROFOAM™ Brand Extruded Polystyrene Foam Insulation on top of leveled soil. Top with a gravel base and pavement or other surface. For low-temperature floors such as ice rinks, position insulation under the wearing slab.

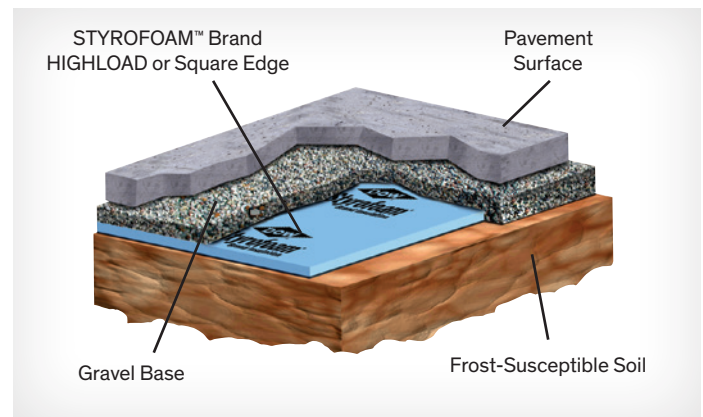

STYROFOAM™ Brand Extruded Polystyrene Foam Insulation offers excellent moisture resistance and insulating power in slab-on-grade radiant floor applications.

Roofs

Plaza and Protected Membrane

STYROFOAM™ Brand Extruded Polystyrene Foam Insulation offers exceptional performance in plaza and protected membrane roofing (PMR) applications.

- Excellent moisture resistance and stable long-term R-value
- Extends life of plaza or roof, providing protection from ultraviolet deterioration
- Protects membrane against weathering, physical abuse and damage
- Maintains membrane at a relatively constant temperature, minimizing effects of freeze-thaw cycling and excessive heat
- Reduces repair expenditures
- Easy removal and re-installation of ballast and insulation

Products:

- STYROFOAM™ Brand HIGHLOAD 40, 60 or 100 Insulation
- STYROFOAM™ Brand PLAZAMATE™ Insulation
- STYROFOAM™ Brand ROOFMATE™ Insulation
- STYROFOAM™ Brand Ribbed ROOFMATE™ Insulation

Application:

Install on top of the waterproofing membrane. Follow with approved fabric. For PMR construction, finish with a layer of crushed stone, gravel, pavers or green roof. For plaza decks where pedestrian or vehicular traffic is anticipated, cover fabric with gravel or pedestals for drainage, then top with pavers, poured concrete or other exterior topping.

- Year-round construction – roof is waterproofed first, then insulated
- Over forty years' proven performance
- Thermal warranties available from Dow; full system warranties available from membrane manufacturers

Membrane Field Temperature Test

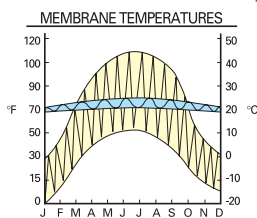

Membrane protection (PMR vs. conventional): Field studies have shown that a constant temperature can extend the life of the membrane. STYROFOAM™ Brand ROOFMATE™ Insulation products offer excellent temperature control.

- PMR (blue line) – the membrane temperature remains relatively constant
- Conventional roof (yellow line) – membrane temperature fluctuates widely

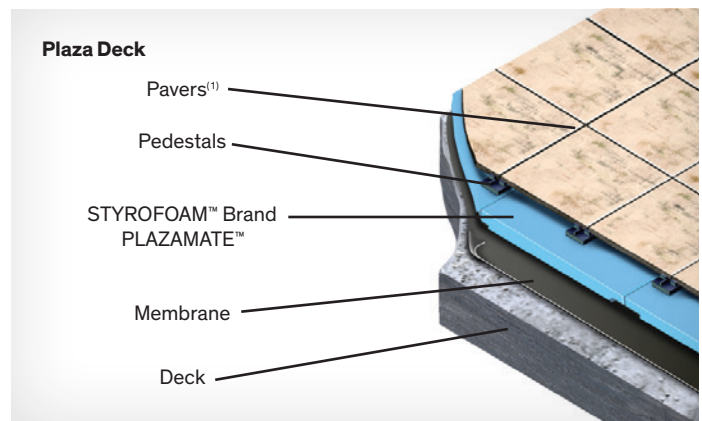
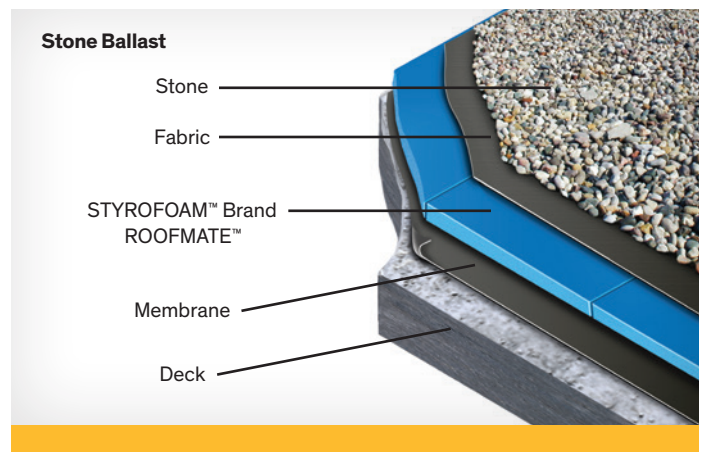

STYROFOAM™ Brand PLAZAMATE™ Insulation is designed to hold up under the heavy demands of plaza roof construction.

(1) Pavers require pedestals unless STYROFOAM™ Brand Ribbed ROOFMATE™ Insulation is used.

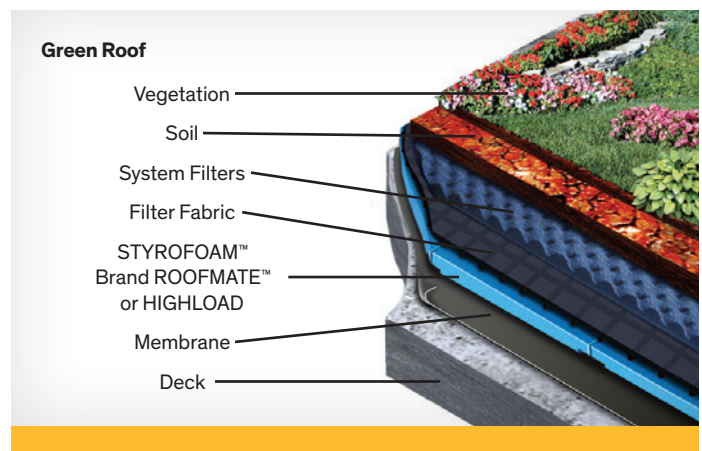

Conventional – Mechanically Attached, Ballasted And Fully Adhered

In conventional roofing applications, STYROFOAM™ Brand Extruded Polystyrene Foam Insulation products from Dow offer:

- Long-term R-value
- Moisture resistance
- High compressive strength for excellent durability and damage resistance
- Ease of use
- Planed surface for excellent bonding of adhesives (STYROFOAM™ Brand DECKMATE™ Plus FA Insulation)

STYROFOAM™ Brand Extruded Polystyrene Foam Insulation may be installed directly on metal decks according to Underwriters Laboratories Construction Nos. 260 and 440. Consult Dow and/or local building code for installation requirements.

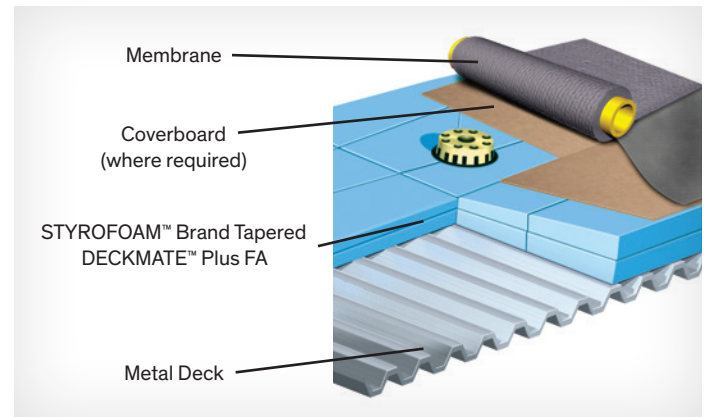

STYROFOAM™ Brand Tapered DECKMATE™ Plus FA Insulation provides a positive slope to improve roof drainage. Experienced custom fabricators provide exceptional job service. Consult Dow and/or local building code for installation requirements.

Products:

- STYROFOAM™ Brand DECKMATE™ Plus Insulation
- STYROFOAM™ Brand DECKMATE™ Plus FA Insulation
- STYROFOAM™ Brand Tapered DECKMATE™ Plus FA Insulation
- INSTA STIK™ Quik Set Commercial Roofing Adhesive

Application:

Install insulation directly on structural deck, including metal decking. Any application-appropriate roofing membrane may be used with rigid board insulation from Dow. Use INSTA STIK™ Quik Set Roofing Adhesive to adhere the insulation to the roofing deck and cover board without the need of fasteners that penetrate the roofing assembly.

In some cases a coverboard or slip sheet may be required between the insulation and the membrane for heat or chemical protection.

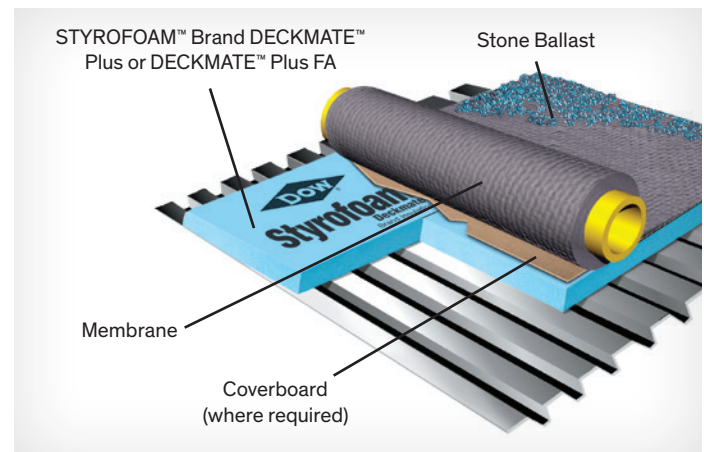

In the United States, a 50-year thermal warranty is available on STYROFOAM™ products 1.5 inches and greater. For thickness less than 1.5 inches, other warranties may apply. Warranties are available as described at www.dbswarranties.com.

Steep Slope

In steep slope roof construction, insulation and adhesive products from Dow offer high R-value, high compressive strength, durability and ease of use.

- For use on metal or wood decks
- Accept a variety of roofing materials, including shingles, slate, tile and metal membranes
- STYROFOAM™ Brand DECKMATE™ Plus Extruded Polystyrene Foam Insulation offers excellent moisture resistance
- In standing seam metal roofs, THERMAX™ Polyisocyanurate Insulation allows the use of lighter gauge decking (26 gauge instead of the typical 22 gauge) and open frame designs
- WEATHERMATE™ Straight Flashing at seams between insulation boards resists water intrusion under standing seam metal roofs

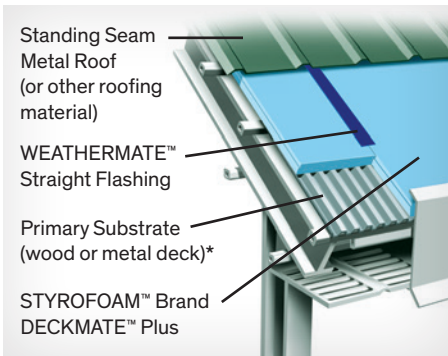

STYROFOAM™ Brand DECKMATE™ Plus Insulation provides excellent moisture resistance and high R-value in a lightweight board.

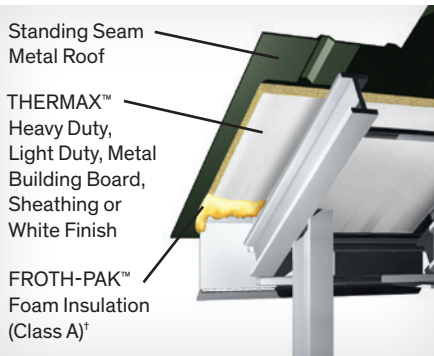

Use Class A rated THERMAX™ products in open frame designs, where the insulation boards may be left exposed to the interior. Tape top side of seams with WEATHERMATE™ Straight Flashing.

Products:

- STYROFOAM™ Brand DECKMATE™ Plus Insulation
- THERMAX™ Heavy Duty
- THERMAX™ Light Duty
- THERMAX™ Metal Building Board
- THERMAX™ Sheathing
- THERMAX™ White Finish
- WEATHERMATE™ Straight Flashing

Application:

Install insulation on clean, dry, structural roof deck. Cover with an underlayment where required. Finish with shingles, tile, slate, metal or other roofing material.

Available in 4", 6" and 9" widths, WEATHERMATE™ Straight Flashing combines a high-density polyethylene film facer with a butyl rubber adhesive for a strong mechanical and chemical bond to insulation and other building materials.

Roof Re-Cover Applications

STYROFOAM™ Brand RECOVERMATE™ CR Insulation is designed specially for roof re-cover applications:

- Resistant to the effects of moisture
- Excellent compressive retention
- Lightweight: easy to cut, handle, install and store
- Withstands temperatures to 165°F
- Chemical-resistant; useful for installation with plasticized membranes
- Fanfolded
- For light-colored membranes only

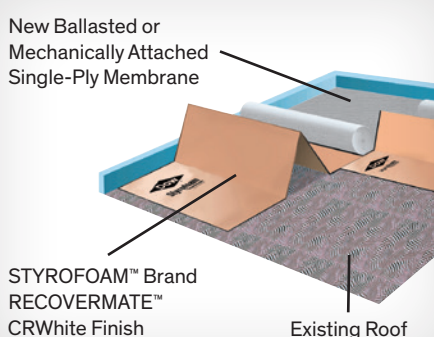

Use Class A rated THERMAX™ products in open frame designs, where the insulation boards may be left exposed to the interior. Tape top side of seams with WEATHERMATE™ Straight Flashing.

Products:

- STYROFOAM™ Brand RECOVERMATE™ CR Insulation

Application:

Install STYROFOAM™ Brand RECOVERMATE™ CR Insulation over entire surface of old roof, on top of existing membrane. Top with ballasted or mechanically attached sheet membrane.

For additional information on STYROFOAM™ Brand RECOVERMATE™ CR Insulation visit <http://www.adamsplasticsinc.com/>

One- And Two-Component Polyurethane Foam Products For Roofs

Polyurethane foam insulation, sealant and adhesive products from Dow deliver the high quality and reliability professionals require in a wide range of commercial roofing applications, including:

- Flat and low slope roofs
- Steep slope roofs
- Barrel and dome roofs
- Roof re-cover projects
- New and re-roof projects

Sealant

Products:

- FROTH-PAK™ Foam Sealant**

Application:

Use FROTH-PAK™ Foam Sealant to fill gaps or joints 4" or less. When properly applied, the spray forms an effective air sealant or insulation on most roofing materials. FROTH-PAK™ Foam Sealant is also useful in sealing the perimeter of the building between the roof deck and parapet.

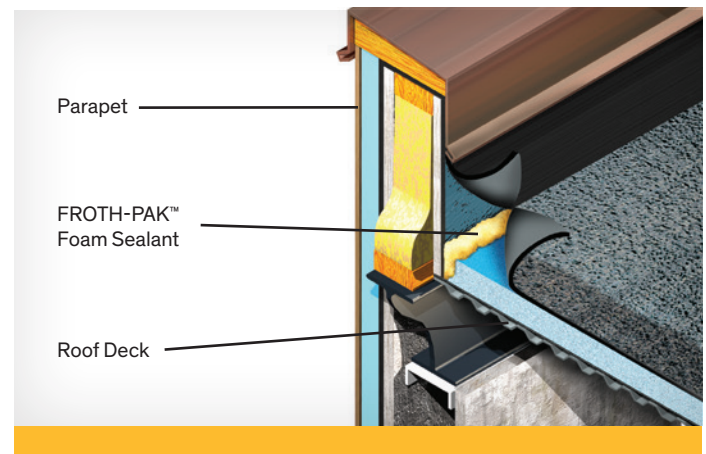

Adhesives

Products:

- INSTA STIK™ Quik Set Commercial Roofing Adhesive**
- TILE BOND™ Roof Tile Adhesive**

Application:

Polyurethane adhesive products from Dow provide a fast, efficient method for securing foam insulation boards or roof tiles to appropriate roof deck or substrate.

INSTA STIK™ Quik Set has a limited 10-year adhesion warranty when applied to compatible materials or substrates by an approved applicator. Limited 15- and 20- year adhesion warranties are available at additional cost. Certain conditions apply; see the appropriate warranty for details.

TILE BOND™, with its easy-to-use, self-contained dispensing equipment, is designed for use with low/flat, medium, high and two-piece barrel profiles. TILE BOND™ must be applied by an approved applicator to meet certain building code requirements. Consult local code authorities.

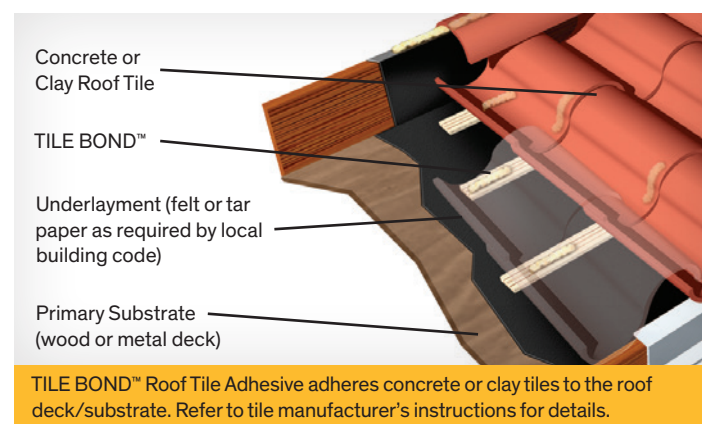
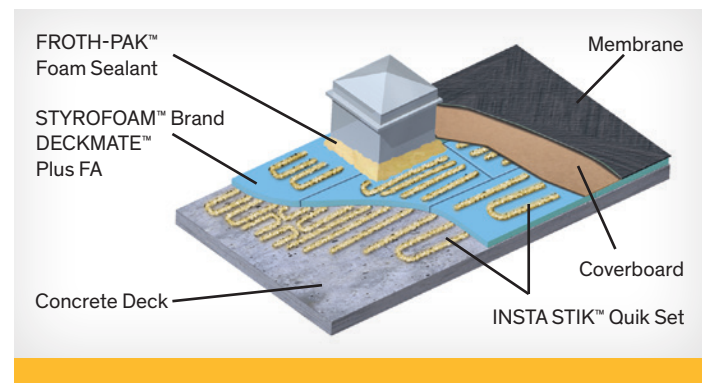

STYROFOAM™ Brand Extruded Polystyrene Foam Insulation

Physical Properties**	Thermal Resistance ^(1,2) aged R-value per inch @ 75°F mean temp	Compressive Strength (lb/in ²), min. ⁽³⁾	Flexural Strength (lb/in ²), min.	Water Absorption (% by volume), max.	Water Vapor Permeance ⁽⁴⁾ (perm), max.	Dimensional Stability (% linear change), max.	Coefficient of Linear Thermal Expansion (x10 ⁻⁵ in/in·°F)	Complies with ASTM C578, Type ⁽⁵⁾	Maximum Use Temperature (°F)	Flame Spread ⁽⁶⁾	Smoke Developed	Width (inches)	Length (inches)	Typical Thickness Range (inches)
ASTM Method	C518	D1621	C203	C272	E96	D2126				E84	E84			
CAVITYMATE™	5.0	15	40	0.3	1.5	2.0	3.5	X	165	15	165	16	96	1.0, 1.5, 2.0, 3.0
CAVITYMATE™ SC	5.0	15	40	0.3	1.5	2.0	3.5	X	165	15	165	48	96	1.0, 1.5, 2.0, 2.5
CAVITYMATE™ Plus	5.0	25	50	0.3	1.5	2.0	3.5	IV	165	15	165	16	96	1.0, 1.5, 2.0
CAVITYMATE™ Ultra	5.6	25	50	0.3	1.5	2.0	3.5	IV	165	0	155	15.75	96	1.75, 2.125, 2.5, 3.0
CAVITYMATE™ Ultra SL	5.6	25	50	0.3	1.5	2.0	3.5	IV	165	0	155	48	96	1.75, 2.125, 2.5, 3.0
DECKMATE™ Plus	5.0	25	50	0.3	1.5	2.0	3.5	IV	165	15	165	24 48	96 96	1.0, 1.5, 2.0, 2.5, 3.0, 4.0
DECKMATE™ Plus FA (Flat and Tapered)	5.0	25	50	0.3	1.5	2.0	3.5	IV	165	15	165	24	96	1.5, 2.0, 2.5, 3.0, 4.0 1/8", 1/4", 1/2" slopes
FREEZERMATE™	5.0	30	50	0.3	1.5	2.0	3.5	IV	165	15	165	24/48	96/96	2.0, 3.0
PERIMATE™	1.063" R-5.0 2.125" R-10.0	30	50	0.3	1.5	2.0	3.5	IV	165	15	165	24	96	1.063, 2.125
PLAZAMATE™	5.0	60	75	0.3	0.8	2.0	3.5	VII	165	15	165	24	96	2.0, 3.0
RECOVERMATE™ CR*	1.5 ⁽⁷⁾	15	-	0.3	1.5	2.0	3.5	-	165	10	200- 350	48	600	0.375
ROOFMATE™	5.0	40	60	0.3	1.0	2.0	3.5	VI	165	15	165	24	96	1.0, 1.5, 2.0, 2.5, 3.0, 3.5, 4.0
Ribbed ROOFMATE™	5.0	40 ⁽⁸⁾	60	0.3	1.0	2.0	3.5	VI	165	15	165	24	96	2.0
WALLMATE™	5.0	15	40	0.3	1.5	2.0	3.5	X	165	15	165	24	96	1.5, 2.0
Z-MATE™	5.0	15	40	0.3	1.5	2.0	3.5	X	165	15	165	24	96	1.5, 2.0
Protection Board III*	1.0 ⁽⁹⁾	8	-	0.2	1.5 ⁽⁹⁾	-	-	-	165	10	200- 350	48	600	0.25
HIGHLOAD 40	5.0	40	60	0.3	1.0	2.0	3.5	VI	165	15	165	24 48	96 96	2.0, 3.0
HIGHLOAD 60	5.0	60	75	0.3	0.8	2.0	3.5	VII	165	15	165	24	96	2.0, 3.0
HIGHLOAD 100	5.0	100	100	0.1	0.8	2.0	3.5	V	165	15	165	24	96	2.0
Scoreboard ⁽¹⁰⁾	5.0	25	50	0.3	1.5	2.0	3.5	IV	165	15	165	48	96	0.75, 1.0, 1.5, 2.0, 2.5, 3.0
Square Edge ⁽¹⁰⁾	5.0	25	50	0.3	1.5	2.0	3.5	IV	165	15	165	24 48	96 96	0.75, 1.0, 1.5, 2.0, 2.5, 3.0, 4.0
Tongue and Groove	5.0	25	50	0.3	1.5	2.0	3.5	IV	165	15	165	24 48	96 96	0.75, 1.0, 1.5, 2.0

(1) Values are consistent with the criteria of ASTM C578 and the requirements of the FTC R-value rule (16 CFR Part 460). A 15-year limited thermal warranty is available.
 (2) R means resistance to heat flow. The higher the R-value, the greater the insulating power. R-values are expressed in ft²·h·°F/Btu.
 (3) Vertical compressive strength is measured at 10% deformation (5% for STYROFOAM™ Brand PLAZAMATE™ Insulation and for STYROFOAM™ Brand HIGHLOAD 40, 60 and 100 Insulation) or at yield, whichever occurs first. Since STYROFOAM™ Brand Extruded Polystyrene Foam Insulation is a visco-elastic material, adequate design safety factors should be used to prevent long-term creep and fatigue deformation. For static loads, 3:1 is suggested. For dynamic loads, 5:1 is suggested.

(4) Water vapor permeance varies with product type and thickness. Values are based on the desiccant method, and they apply to insulation 1" in thickness. Thicker products have lower permeance.
 (5) Former Federal Specification HH-I-524C was cancelled in 1985 and replaced by ASTM Specification C578.
 (6) This numerical flame spread rating is not intended to reflect hazards presented by this or any other material under actual fire conditions.
 (7) For 3/8" thickness.
 (8) Recommended load (psf) including 5:1 design factor.
 (9) For 1/4" thickness; perm-inches.
 (10) If using product for Z-furring applications, contact your local Dow sales representative for exact product sizes.

Note: Not all products are available in all parts of the country. Other product sizes are available on a made-to-order basis. Contact your Dow representative with questions.

* For additional information visit <http://www.adamsplasticsinc.com/>

** These are typical physical properties. Not to be construed as sales specifications.

Dow Polyisocyanurate Insulation

Physical Properties**	Thermal Resistance ^(1,2)	Compressive Strength (lb/in ²), min., core foam	Flexural Strength (lb/in ²), typ. for 1" core foam	Water Absorption (% increase by volume, 2-hr. results), max., core foam	Water Vapor Permeance ⁽³⁾ (perm)	Complies with ASTM	Maximum Use Temperature (°F)	Flame Spread ⁽⁴⁾ , max., core foam	Smoke Developed, max., core foam	Width (inches)	Length (inches)	Typical Thickness Range (inches), core foam
ASTM Method	C518	D1621	C203	C209	E96	C1289		E84	E84			
ISOCAST™ R	6.5	25	40	0.1	<0.03	Type I Class 1 or 2 ⁽⁵⁾	190	55	<450	48	96	1.0, 1.5, 2.0
Super TUFF-R™ Commercial	6.5	25	40	0.1	<0.03	Type I Class 1 or 2 ⁽⁵⁾	190	55	<450	16 48 48	96 96 108	0.5, 0.75, 1.0, 1.5, 1.75, 2.0
THERMAX XARMOR™ (ci) Exterior Insulation	6.5	25	55	0.1	<0.03	Type I Class 2	250	25	<450	48 48	96 144	0.625, 1.0, 1.55, 2.0, 2.5, 3.0
THERMAX™ (ci) Exterior Insulation	6.5	25	55	0.1	<0.03	Type I Class 2	250	25	<450	48 48	96 144	0.625, 1.0, 1.55, 2.0
THERMAX™ Heavy Duty	6.5	25	55	0.1	<0.03	Type I Class 2	250	25	<450	48 48	96 120	1.0, 1.25, 1.55, 1.75, 2.0, 2.5, 3.0
THERMAX™ Light Duty	6.5	25	55	0.1	<0.03	Type I Class 2	250	25	<450	48 48	96 120	0.5, 0.75, 1.0, 1.25, 1.55, 1.75, 2.0, 2.5, 3.0
THERMAX™ Metal Building Board	6.5	25	55	0.1	<0.03	Type I Class 2	250	25	<450	48 48	96 120	0.5, 0.75, 1.0, 1.75, 2.0, 2.5, 3.0, 3.5, 4.0
THERMAX™ White Finish	6.5	25	55	0.1	<0.03	Type I Class 2	250	25	<450	48	108	0.5, 0.75, 1.0, 1.25, 1.5, 1.55, 1.75, 2.0
THERMAX™ Sheathing	6.5	25	40	0.1	<0.03	Type I Class 2	250	25	<450	48	96, 108, 120, 144	0.5, 0.75, 1.0, 1.5, 1.55, 2.0, 2.5, 3.0, 3.5, 4.0
TUFF-R™ Commercial	6.5	25	40	0.1	<0.03	Type I Class 1 or 2 ⁽⁵⁾	190	55	<450	48	96 108	1.0, 1.25, 1.50, 1.875, 2.0
TUFF-R™ (ci)	6.5	20	40	0.1	<0.04	Type I Class 2	190	25	<450	48	96 108	1.0, 1.55, 2.0, 3.2

- (1) Aged R-value per 1" @ 75°F mean temperature. R-values are expressed in ft²·h·°F/Btu.
- (2) R means resistance to heat flow. The higher the R-value, the greater the insulating power. R-values determined by ASTM C518 using the aging process in ASTM C1289 (90 days @ 140°F).
- (3) Water vapor permeance varies with product type and thickness. Values are based on the desiccant method, and they apply to insulation 1" in thickness. Thicker products have lower permeance.
- (4) These numerical flame spread ratings are not intended to reflect hazards presented by this or any other material under actual fire conditions.
- (5) Varies with thickness.
- (6) Dimensional Stability is for the thickness

Note: Not all products are available in all parts of the country. Other product sizes are available on a made-to-order basis. Custom lengths of THERMAX™ Insulation products are available for orders of 7,500 board feet or more. Contact your Dow representative with questions.

Dow Polyurethane Foam Insulation

Physical Properties**	Property (units)	Flexural Strength (lb/in ²), parallel	Thermal Resistance, R-value per inch, ft ² ·h·°F/Btu	Compressive Strength (lb/in ²), parallel	Shear Strength (lb/in ²), parallel	Apparent Core Density (lb/ft ³)	Water Absorption (5% by volume)	Water Vapor Permeance (perm) @ 1" Thick	Cure Time	Application Temperature (°F)	Sizes
ASTM Method		C203	C518	D1621	C273	D1622	D2842	E96			
FROTH-PAK™ Foam Insulation (CLASS A)		22.7	5.6 ⁽¹⁾	21.1	16.7	2.0	2.17	3.9	Tack-free ⁽²⁾ <1 min.	60-90	Selection of kit sizes and refill systems available
STYROFOAM™ SPF (CM Series) ⁽³⁾	2030	NA	6.0 ⁽⁴⁾	25	NA	2.5	Pass	2.2	NA	30-70 Ambient (30-60 Substrate)	55 gal drums (one ISO, one polyol)
	2045	NA	6.5 ⁽⁵⁾	21.7	NA	2.3	Pass	2.7	NA	45-95 Ambient (45-100 Substrate)	

- (1) Aged R-value: 90 days at 140°F. Initial R-value: 6.6.
- (2) Actual cure time will depend on temperature, foam thickness, specific nozzle used, etc.
- (3) Approved for use exclusively with the THERMAX™ Wall System.
- (4) Aged R-value: 90 days at 140°F.
- (5) Aged R-value: 180 days at room temperature.

** These are typical physical properties. Not to be construed as sales specifications.

Dow Polyurethane Foam Sealants and Adhesives

Product	Cure Time	Size	Yield ⁽¹⁾
FROTH-PAK™ Foam Sealant ^(2,3)	Tack-free <1 min.	Selection of kit sizes and refill systems available	12-620 bd ft Refill Systems 2,000-43,900 bd ft
GREAT STUFF PRO™ Gaps & Cracks ⁽⁴⁾	Tack-free within 6 mins, trim in 30; full cure 1 hour	24 oz can, reusable straw 24 oz can, gun 30 oz can, reusable straw 30 oz can, gun	775 ft ⁽⁵⁾ 970 ft ⁽⁵⁾ 995 ft ⁽⁵⁾ 1,450 ft ⁽⁵⁾
GREAT STUFF PRO™ Window & Door ⁽⁴⁾	Tack-free within 9 mins, trim 1 hour; full cure 12 hours	20 oz can, reusable straw 20 oz can, gun 24.5 oz can, reusable straw 24.5 oz can, gun	6-9 windows ⁽⁶⁾ 8-11 windows ⁽⁶⁾ 8-11 windows ⁽⁶⁾ 11-14 windows ⁽⁶⁾
INSTA STIK™ Quik Set	Tack-free 3-7 mins, depending on humidity	30 lb canister only (23 lb net chemical weight)	(refer to E-Z Estimating Guide, Form No. 179-05069)
TILE BOND™	Tack-free 5-15 mins	23 lb complete (canister with gun/hose assembly) 23 lb canister only 28 oz can with reusable straw	Up to 375 field tiles for 23 lb tank

(1) For estimated yields at other product sizes, bead sizes and conditions, contact your Dow representative or call 1-866-583-BLUE (2583).

(2) FROTH-PAK™ products are available in a selection of densities, formulations and sizes to meet a wide range of project specifications.

(3) Actual cure time will depend on temperature, foam thickness, the specific nozzle used, etc.

(4) Actual cure time will depend on temperature, relative humidity and size of foam bead.

(5) Estimated yield under ideal conditions based on gun foam, 3/8" bead.

(6) Estimated yield (gun foam) under ideal conditions for 36" x 60" window, 3/8" wide gap, 1" deep, 3/8" bead.

WEATHERMATE™ Straight Flashing

Property	Value
Water Vapor Transmission, ASTM E96, perm	<1
Application Temperature, °F, min.	20
UV Resistance, days 180	180
Size	4" x 100', 6" x 100', 9" x 100'

LIQUIDARMOR™ CM Sealant and Flashing

Liquid Properties		Cured Properties	
Form	Grey-blue, sprayable sealant	ASTM D412 Tensile Strength	105 psi
Volatiles Organic Compounds (VOC)	2.3 wt%	ASTM D412 Elongation at Break	450%
Density	11.4 lbs./gal.	ASTM E96 Water Vapor Transmission	4 perms
Total Solids	75%	Accelerated Weathering AC148, 45.2	Passes
Shelf Life	1.5 years	Nail Sealing Ability ASTM D1970/ AC148 Sec. 4.2	Passes

STYROFOAM™ SILL SEAL Foam Gasket

Nominal Thickness x Width	Roll Length
.25" x 3.5"	50'
.25" x 5.5"	50'



Proven Solutions for Sustainable Designs.

A recognized industry leader in energy-efficient solutions for more than 60 years, Dow is committed to developing innovative product solutions to help solve the world's energy and climate challenges.

To learn how to make your mark, call your Dow representative at 1-866-583-BLUE (2583) for more details, or visit www.dowbuildingsolutions.com.

The Dow Chemical Company

Dow Building Solutions
200 Larkin
Midland, MI 48674

Technical Information: 1-866-583-BLUE (2583)

Sales Information: 1-800-232-2436

www.dowbuildingsolutions.com



@DowBuilding



/DowBuildingSolutions

Illustrations are not intended to replace the need for design by appropriate professionals such as architects or engineers.

Dow has manufactured STYROFOAM™ Brand Extruded Polystyrene Foam Insulation for use in construction and specialty applications for more than 60 years. Its dense closed-cell structure gives STYROFOAM™ Brand Extruded Polystyrene Foam Insulation excellent moisture resistance, longterm thermal performance and compressive strength. STYROFOAM™ Brand Extruded Polystyrene Foam Insulation is reusable in many applications.

NOTICE: No freedom from infringement of any patent owned by Dow or others is to be inferred. Because use conditions and applicable laws may differ from one location to another and may change with time, Customer is responsible for determining whether products and the information in this document are appropriate for Customer's use and for ensuring that Customer's workplace and disposal practices are in compliance with applicable laws and other government enactments. The product shown in this literature may not be available for sale and/or available in all geographies where Dow is represented. The claims made may not have been approved for use in all countries. Dow assumes no obligation or liability for the information in this document. References to "Dow" or the "Company" mean the Dow legal entity selling the products to Customer unless otherwise expressly noted. NO WARRANTIES ARE GIVEN; ALL IMPLIED WARRANTIES OF MERCHANTABILITY OR FITNESS FOR A PARTICULAR PURPOSE ARE EXPRESSLY EXCLUDED.

STYROFOAM™ Brand Extruded Polystyrene Foam Insulation

CAUTION: This product is combustible. Protect from high heat sources. A protective barrier or thermal barrier may be required as specified in the appropriate building code. For more information, consult MSDS, call Dow at 1-866-583-BLUE (2583) or contact your local building inspector. In an emergency, call 1-989-636-4400 in the U.S. or 1-519-339-3711 in Canada.

Dow Polyisocyanurate Insulation

CAUTION: This product is combustible and shall only be used as specified by the local building code with respect to flame spread classification and to the use of a suitable thermal barrier. For more information, consult MSDS, call Dow at 1-866-583-BLUE (2583) or contact your local building inspector. In an emergency, call 1-989-636-4400.

WARNING: Rigid foam insulation does not constitute a working walkable surface or qualify as a fall protection product.

STYROFOAM™ Brand Spray Polyurethane Foam contains isocyanate, hydrofluorocarbon blowing agent and polyol. Read the instructions and Material Safety Data Sheets carefully before use. Wear protective clothing (including long sleeves), gloves, goggles and proper respiratory protection. Supplied air or an approved air-purifying respirator equipped with an organic vapor sorbent and a P100 particulate filter is required to maintain exposure levels below ACGIH, OSHA, WEEL or other applicable limits. Provide adequate ventilation. Contents under pressure. STYROFOAM™ Brand SPF should be installed by a trained SPF applicator.

FROTH-PAK™ Spray Polyurethane Foam contains isocyanate, hydrofluorocarbon blowing agent and polyol. Read the instructions and Material Safety Data Sheets carefully before use. Wear protective clothing (including long sleeves), gloves, goggles and safety glasses, and proper respiratory protection. Do not breathe vapor or mist. Use only with adequate ventilation. It is recommended that applicators and those working in the spray area wear respiratory protection. Increased ventilation significantly reduces the potential for isocyanate exposure, however, supplied air or an approved air-purifying respirator equipped with an organic vapor sorbent and a particulate filter may still be required to maintain exposure levels below ACGIH, OSHA, WEEL or other applicable limits. For situations where the atmospheric levels may exceed the level for which an air-purifying respirator is effective, use a positive-pressure, air-supplying respirator (air line or self-contained breathing apparatus). Spraying large amounts of foam indoors may require the use of a positive pressure, air-supplying respirator. Contents under pressure.

GREAT STUFF PRO™ Insulating Foam Sealants GREAT STUFF™, GREAT STUFF PRO™, ENERFOAM™ and ENERBOND™ sealant and adhesive products contain isocyanate and a flammable blowing agent. Read all instructions and (Material) Safety Data Sheet ((M)SDS), carefully before use. Eliminate all sources of ignition before use. Cover all skin. Wear long sleeves, gloves, and safety glasses or goggles. Not for use in aviation, or food/beverage contact, or as structural support in marine applications. Provide adequate ventilation or wear proper respiratory protection. Contents under pressure. Not to be used for filling closed cavities or voids such as behind walls and under tub surrounds; this improper use of the product could result in the accumulation of flammable vapors and/or uncured material. Failure to follow the warnings and instructions provided with the product, and/or all applicable rules and regulations, can result in injury or death.

CAUTION: When cured, these products are combustible and will burn if exposed to open flame or sparks from high-energy sources. Do not expose to temperatures above 240°F (116°C). For more information, consult MSDS, call Dow at 1-866-583-BLUE (2583) or contact your local building inspector. In an emergency, call 1-989-636-4400 in the U.S. or 1-519-339-3711 in Canada.

INSTASTIK™ Quik Set and TILE BOND™ adhesive products contain isocyanate and a hydrofluorocarbon blowing agent. Read the label and Material Safety Data Sheet carefully before use. Wear long sleeves, gloves, and goggles or safety glasses. Provide adequate ventilation or wear proper respiratory protection. Contents under pressure.

Building and/or construction practices unrelated to building materials could greatly affect moisture and the potential for mold formation. No material supplier including Dow can give assurance that mold will not develop in any specific system.