

# COMPUTER NUMERICAL CONTROL PROGRAMMING BASICS



*A Primer for the*  
**SkillsUSA/VICA**  
*Championships*



Steve Krar ■ Arthur Gill

---

---

***Distributed to educational administrators,  
instructors, students, and apprentices  
with the compliments of***

**INDUSTRIAL PRESS, INC.**

*publishers of*

**MACHINERY'S HANDBOOK**

*"The Bible of the Machine Trades"*

# **Computer Numerical Control Programming Basics**

Steve Krar ■ Arthur Gill

This book is not intended for sale under any circumstances.

**INDUSTRIAL PRESS INC.**

200 Madison Avenue, New York, NY 10016

# CONTENTS

<i>SECTION</i>	<i>PAGE</i>
Foreword	1
Preface	7
Cartesian Coordinate System	7
Machines Using CNC	9
Programming Systems	11
Point-to-Point or Continuous Path	13
Point-to-Point Positioning	14
Continuous Path (Contouring)	15
Interpolation	15
Programming Format	17
Programming for Positioning	23
Work Settings and Offsets	26
CNC Bench-Top Milling and Turning Centers	30
CNC Programming Hints — Milling	32
Milling and Drilling Programming	34
CNC Programming Hints – Turning	38
Fanuc Compatible Programming	39
Turning Programming	40

## Preface

The term *numerical control* is a widely accepted and commonly used term in the machine tool industry. Numerical control (NC) enables an operator to communicate with machine tools through a series of numbers and symbols.

NC which quickly became Computer Numerical Control (CNC) has brought tremendous changes to the metalworking industry. New machine tools in CNC have enabled industry to consistently produce parts to accuracies undreamed of only a few years ago. The same part can be reproduced to the same degree of accuracy any number of times if the CNC program has been properly prepared and the computer properly programmed. The operating commands which control the machine tool are executed automatically with amazing speed, accuracy, efficiency, and repeatability.

The ever-increasing use of CNC in industry has created a need for personnel who are knowledgeable about and capable of preparing the programs which guide the machine tools to produce parts to the required shape and accuracy. With this in mind, the authors have prepared this textbook to take the mystery out of CNC - to put it into a logical sequence and express it in simple language that everyone can understand. The preparation of a program is explained in a logical step-by-step procedure, with practical examples to guide the student.

## Cartesian Coordinate System

Almost everything that can be produced on a conventional machine tool can be produced on a computer numerical control machine tool, with its many advantages. The machine tool movements used in producing a product are of two basic types: *point-to-point* (straight-line movements) and *continuous path* (contouring movements).

The Cartesian, or rectangular, coordinate system was devised by the French mathematician and philosopher Rene' Descartes. With this system, any specific point can be described in mathematical

terms from any other point along three perpendicular axes. This concept fits machine tools perfectly since their construction is generally based on three axes of motion (X, Y, Z) plus an axis of rotation. On a plain vertical milling machine, the X axis is the horizontal movement (right or left) of the table, the Y axis is the table cross movement (toward or away from the column), and the Z axis is the vertical movement of the knee or the spindle. CNC systems rely heavily on the use of rectangular coordinates because the programmer can locate every point on a job precisely.

When points are located on a workpiece, two straight intersecting lines, one vertical and one horizontal, are used. These lines must be at right angles to each other, and the point where they cross is called the *origin*, or *zero point* (Fig. 1)

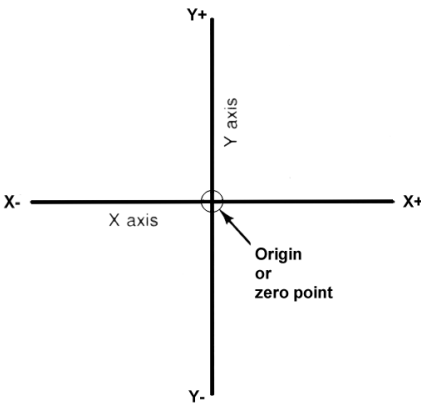

Fig. 1 Intersecting lines form right angles and establish the zero point (Allen-Bradley)

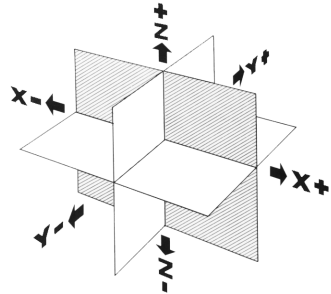

Fig. 2 The three-dimensional coordinate planes (axes) used in CNC. (The Superior Electric Company)

The three-dimensional coordinate planes are shown in Fig. 2. The X and Y planes (axes) are horizontal and represent horizontal machine table motions. The Z plane or axis represents the vertical tool motion. The plus (+) and minus (-) signs indicate the direction from the zero point (origin) along the axis of movement. The four quadrants formed when the XY axes cross are numbered in a counterclockwise direction (Fig. 3). All positions located in quadrant 1 would be positive (X+) and positive (Y+). In the second quadrant, all positions would be negative X (X-) and positive (Y+). In the third quadrant, all locations would be negative X (X-) and negative (Y-). In the fourth quadrant, all locations would be positive X (X+) and negative Y (Y-).

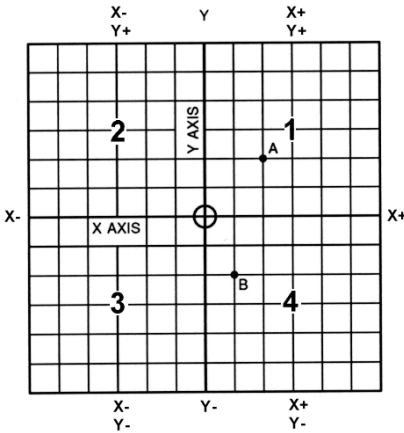

Fig. 3 The quadrants formed when the X and Y axes cross are used to accurately locate points from the XY zero, or origin, point. (Allen-Bradley)

In Fig. 3 , point A would be 2 units to the right of the Y axis and 2 units above the X axis. Assume that each unit equals 1.000. The location of point A would be X + 2.000 and Y + 2.000. For point B, the location would be X + 1.000 and Y - 2.000. In CNC programming it is not necessary to indicate plus (+) values since these are assumed. However, the minus (-) values must be indicated. For example, the locations of both A and B would be indicated as follows:

- A X2.000 Y2.000
- B X1.000 Y-2.000

## Machines Using CNC

Early machine tools were designed so that the operator was standing in front of the machine while operating the controls. This design is no longer necessary, since in CNC the operator no longer controls the machine tool movements. On conventional machine tools, only about 20 percent of the time was spent removing material. With the addition of electronic controls, actual time spent removing metal has increased to 80 percent and even higher. It has also reduced the amount of time required to bring the cutting tool into each machining position.

## Machine Types

### Lathe

The engine lathe, one of the most productive machine tools, has always been an efficient means of producing round parts (Fig. 4).

4). Most lathes are programmed on two axes.

- The X axis controls the cross motion of the cutting tool. Negative X (X-) moves the tool towards the spindle centerline; positive X moves the tool away from the spindle centerline.
- The Z axis controls the carriage travel toward or away from the headstock.

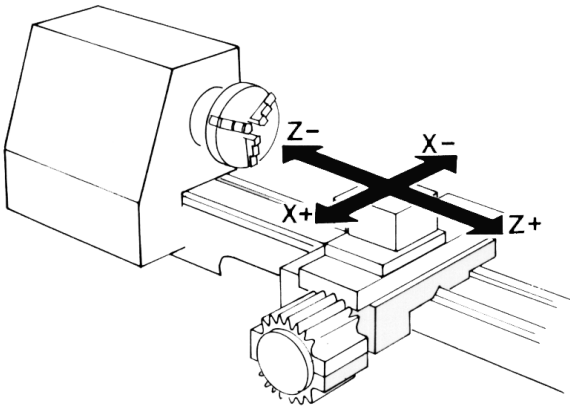

Fig. 4 The main axes of a lathe or turning center. (Emco Maier Corp)

### Milling Machine

The milling machine has always been one of the most versatile machine tools used in industry (Fig. 5). Operations such as milling, contouring, gear cutting, drilling, boring, and reaming are only a few of the many operations which can be performed on a milling machine. The milling machine can be programmed on three axes:

- The X axis controls the table movement left or right.
- The Y axis controls the table movement toward or away from the column.
- The Z axis controls the vertical (up or down) movement of the knee or spindle.

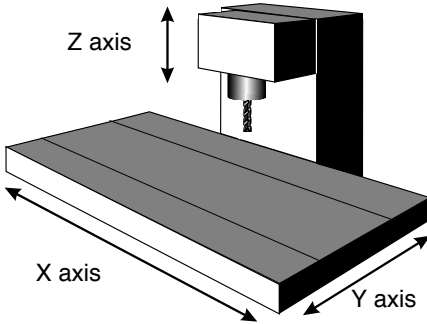
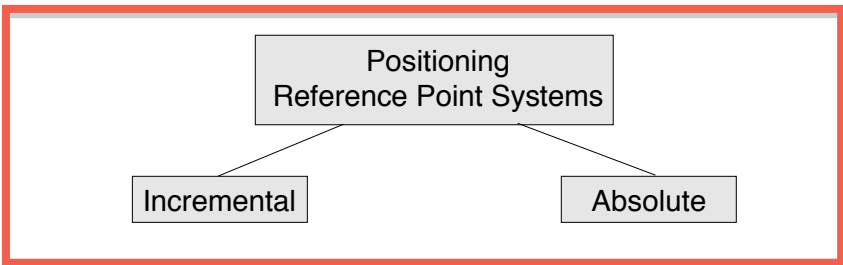

Fig. 5 The main axes of a vertical machining center. (Denford Inc.)

## Programming Systems

Two types of programming modes, the incremental system and the absolute system, are used for CNC. Both systems have applications in CNC programming, and no system is either right or wrong all the time. Most controls on machine tools today are capable of handling either incremental or absolute programming.



**Incremental program** locations are always given as the distance and direction from the immediately preceding point (Fig. 6). Command codes which tell the machine to move the table, spindle, and knee are explained here using a vertical milling machine as an example:



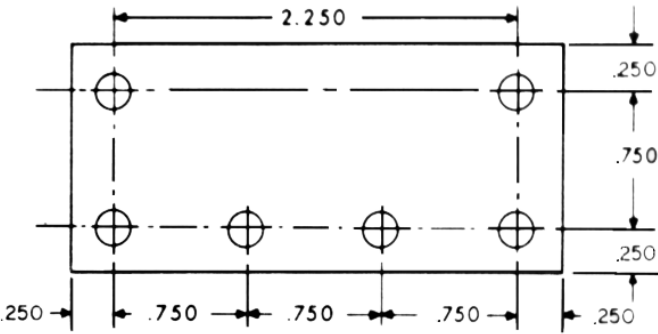

Fig. 6 A workpiece dimensioned in the incremental system mode. (Icon Corporation)

- A “X plus” (X+) command will cause the cutting tool to be located to the right of the last point.
- A “X minus” (X-) command will cause the cutting tool to be located to the left of the last point.
- A “Y plus” (Y+) command will cause the cutting tool to be located toward the column.
- A “Y minus” (Y-) will cause the cutting tool to be located away from the column.
- A “Z plus” (Z+) command will cause the cutting tool or spindle to move up or away from the workpiece.
- A “Z minus” (Z-) moves the cutting tool down or into the workpiece.

In incremental programming, the G91 command indicates to the computer and MCU (Machine Control Unit) that programming is in the incremental mode.

**Absolute program locations** are always given from a single fixed zero or origin point (Fig. 7). The zero or origin point may be a position on the machine table, such as the corner of the worktable or at any specific point on the workpiece. In absolute dimensioning and programming, each point or location on the workpiece is given as a certain distance from the zero or reference point.

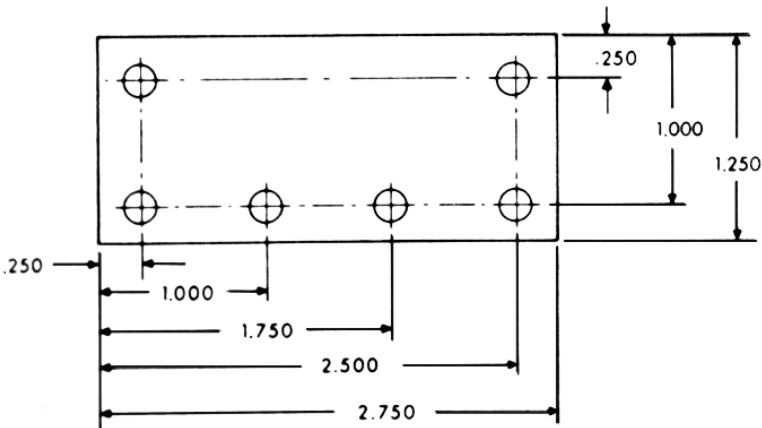

Fig. 7 A workpiece dimensioned in the absolute system mode. Note: All dimensions are given from a known point of reference. (Icon Corporation)

- A “X plus” (X+) command will cause the cutting tool to be located to the right of the zero or origin point.
- A “X minus” (X-) command will cause the cutting tool to be located to the left of the zero or origin point.
- A “Y plus” (Y+) command will cause the cutting tool to be located toward the column.
- A “Y minus” (Y-) command will cause the cutting tool to be located away from the column.

In absolute programming, the G90 command indicates to the computer and MCU that the programming is in the absolute mode.

## Point-to-Point or Continuous Path

CNC programming falls into two distinct categories (Fig. 8). The difference between the two categories was once very distinct. Now, however, most control units are able to handle both point-to-point and continuous path machining. A knowledge of both programming methods is necessary to understand what applications each has in CNC.

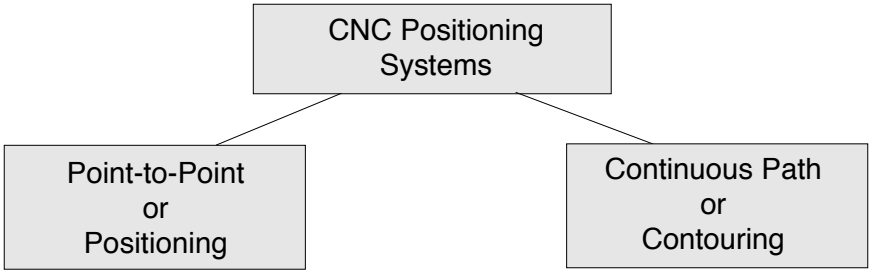

Fig. 8 Types of CNC positioning systems (Kelmar Associates)

## Point-to-Point Positioning

Point-to-point positioning is used when it is necessary to accurately locate the spindle, or the workpiece mounted on the machine table, at one or more specific locations to perform such operations as drilling, reaming, boring, tapping, and punching (Fig. 9). Point-to-point positioning is the process of positioning from one coordinate (XY) position or location to another, performing the machining operation, and continuing this pattern until all the operations have been completed at all programmed locations.

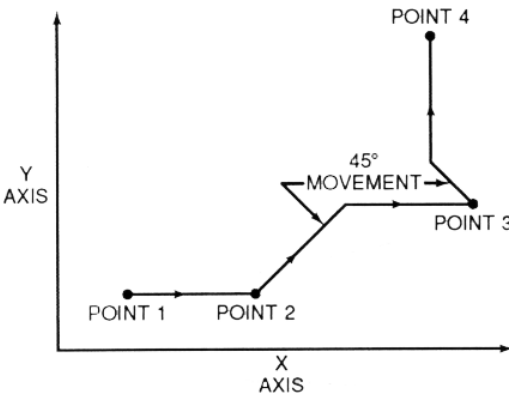

Fig. 9 The path followed by point-to-point positioning to reach various programmed points (machining locations) on the XY axis. (Kelmar Associates)

In Fig. 9 point 1 to point 2 is a straight line, and the machine moves only along the X axis; but points 2 and 3 require that motion along both the X and Y axes takes place. As the distance in the X direction is greater than in the Y direction, Y will reach its

position first, leaving X to travel in a straight line for the remaining distance. A similar motion takes place between points 3 and 4.

## Continuous Path (Contouring)

*Contouring, or continuous path machining, involves work such as that produced on a lathe or milling machine, where the cutting tool is in contact with the workpiece as it travels from one programmed point to the next. Continuous path positioning is the ability to control motions on two or more machine axes simultaneously to keep a constant cutter-workpiece relationship. The programmed information in the CNC program must accurately position the cutting tool from one point to the next and follow a predefined accurate path at a programmed feed rate in order to produce the form or contour required (Fig. 10)*

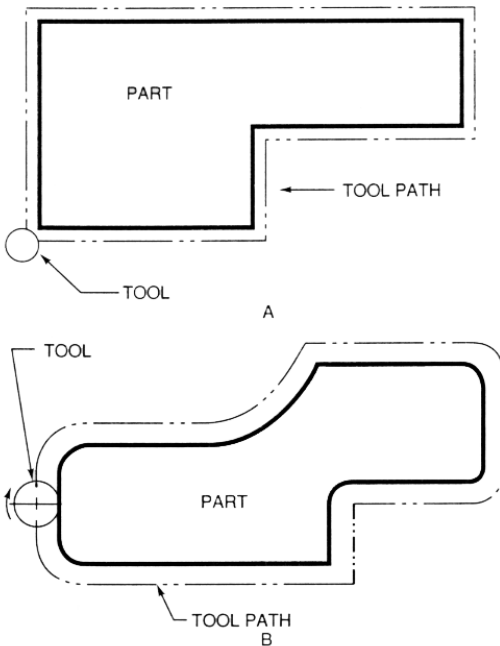

*Fig. 10 Types of contour machining (A) Simple contour; (B) complex contour (Allen Bradley)*

## Interpolation

The method by which contouring machine tools move from one programmed point to the next is called *interpolation*. This ability to

merge individual axis points into a predefined tool path is built into most of today's MCUs. **There are five methods of interpolation: linear, circular, helical, parabolic, and cubic.** All contouring controls provide linear interpolation, and most controls are capable of both linear and circular interpolation. **Helical, parabolic, and cubic interpolation are used by industries that manufacture parts which have complex shapes,** such as aerospace parts and dies for car bodies.

## Linear Interpolation

*Linear Interpolation* consists of any programmed points linked together by straight lines, whether the points are close together or far apart (Fig. 11). Curves can be produced with linear interpolation by breaking them into short, straight-line segments. This method has limitations, because a very large number of points would have to be programmed to describe the curve in order to produce a contour shape.

A contour programmed in linear interpolation requires the coordinate positions (XY positions in two-axis work) for the start and finish of each line segment. Therefore, the end point of one line or segment becomes the start point for the next segment, and so on, throughout the entire program.

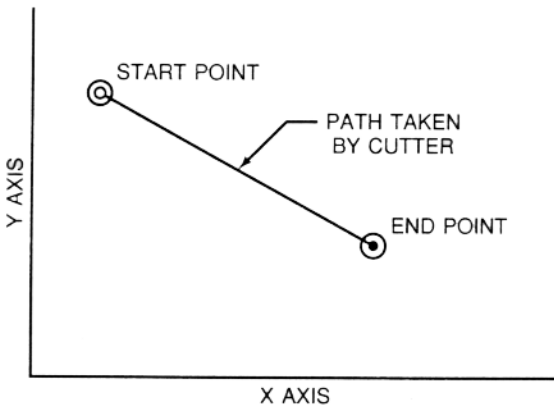

Fig. 11 An example of two-axis linear interpolation. (Kelmar Associates)

## Circular Interpolation

The development of MCUs capable of *circular interpolation* has greatly simplified the process of programming arcs and circles. To program an arc (Fig. 12), the MCU requires only the coordinate positions (the XY axes) of the circle center, the radius of the circle, the start point and end point of the arc being cut, and the direction in which the arc is to be cut (clockwise or counterclockwise) See Fig. 12. The information required may vary with different MCUs.

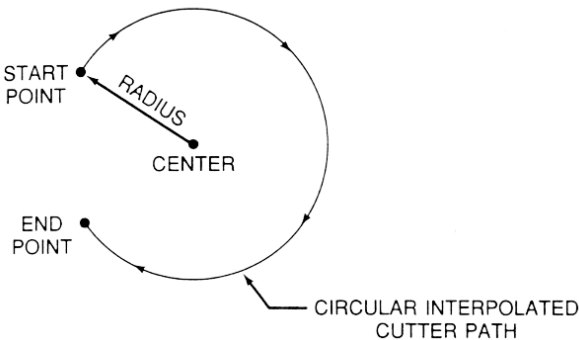

Fig. 12 For two-dimensional circular interpolation the MCU must be supplied with the XY axis, radius, start point, end point, and direction of cut. (Kelmar Associates)

## Programming Format

Word address is the most common programming format used for CNC programming systems. This format contains a large number of different codes (preparatory and miscellaneous) that transfers program information from the part print to machine servos, relays, micro-switches, etc., to manufacture a part. These codes, which conform to EIA (Electronic Industries Association) standards, are in a logical sequence called a *block of information*. Each block should contain enough information to perform one machining operation.

### Word Address Format

Every program for any part to be machined, must be put in a

format that the machine control unit can understand. The format used on any CNC machine is built in by the machine tool builder and is based on the type of control unit on the machine. **A variable-block format which uses words (letters) is most commonly used.** Each instruction word consists of an address character, such as X, Y, Z, G, M, or S. Numerical data follows this address character to identify a specific function such as the distance, feed rate, or speed value.

The address code G90 in a program, tells the control that all measurements are in the absolute mode. The code G91, tells the control that measurements are in the incremental mode.

## Codes

The most common codes used when programming CNC machines tools are *G-codes* (preparatory functions), and *M codes* (miscellaneous functions). Other codes such as F, S, D, and T are used for machine functions such as feed, speed, cutter diameter offset, tool number, etc.

G-codes are sometimes called cycle codes because they refer to some action occurring on the X, Y, and/or Z axis of a machine tool, Fig. 13.

The G-codes are grouped into categories such as Group 01, containing codes G00, G01, G02, G03. which cause some movement of the machine table or head. Group 03 includes either absolute or incremental programming, while Group 09 deals with canned cycles.

A G00 code rapidly positions the cutting tool while it is above the workpiece from one point to another point on a job. During the rapid traverse movement, either the X or Y axis can be moved individually or both axes can be moved at the same time. Although the rate of rapid travel varies from machine to machine, it ranges between 200 and 800 in./min (5 and 20 m/min).

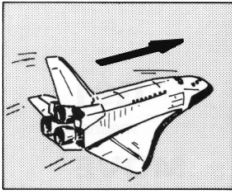

G00  
RAPID TRAVERSE

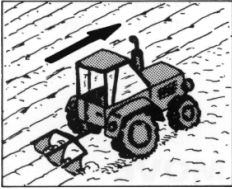
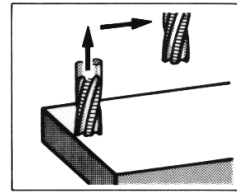

G01  
LINEAR INTERPOLATION  
(STRAIGHT LINE MOVEMENT)

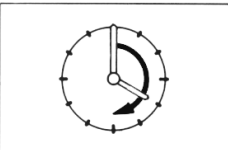
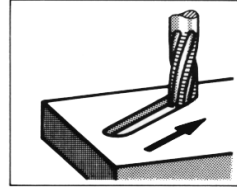

G02  
CIRCULAR INTERPOLATION  
(CLOCKWISE)

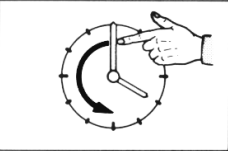
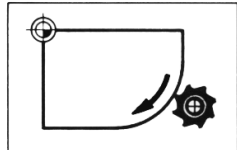

G03  
CIRCULAR INTERPOLATION  
(COUNTERCLOCKWISE)

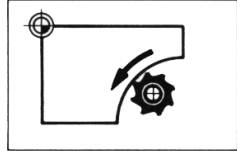

Fig. 13 The functions of a few common G-codes. (Deckel Maho, Inc.)

The G01, G02, and G03 codes move the axes at a controlled feedrate.

- G01 is used for straight-line movement (linear interpolation).
- G02 (clockwise) and G03 (counterclockwise) are used for arcs and circles (circular interpolation).



<u>Group</u>	<u>Code</u>	<u>Function</u>
01	G00	Rapid positioning
01	G01	Linear interpolation
01	G02	Circular interpolation clockwise (CW)
01	G03	Circular interpolation counterclockwise (CCW)
06	G20*	Inch input (in.)
06	G21*	Metric input (mm)
	G24	Radius programming (**)
00	G28	Return to reference point
00	G29	Return from reference point
	G32	Thread cutting (**)
07	G40	Cutter compensation cancel
07	G41	Cutter compensation left
07	G42	Cutter compensation right
08	G43	Tool length compensation positive (+) direction
08	G44	Tool length compensation minus (-) direction
08	G49	Tool length compensation cancel
	G84	Canned turning cycle (**)
03	G90	Absolute programming
03	G91	Incremental programming

(\*) - on some machines and controls, these may be G70 (inch) and G71 (metric)

(\*\*) - refers only to CNC lathes and turning centers.

*Fig. 14 Some of the most common G-codes used in CNC programming.*

**M or miscellaneous codes are used to either turn ON or OFF different functions which control certain machine tool operations, Fig. 15.**

M-codes are not grouped into categories, although several codes may control the same type of operations such as M03, M04, and M05 which control the machine tool spindle.

- M03 turns the spindle on clockwise
- M04 turns the spindle on counterclockwise
- M05 turns the spindle off

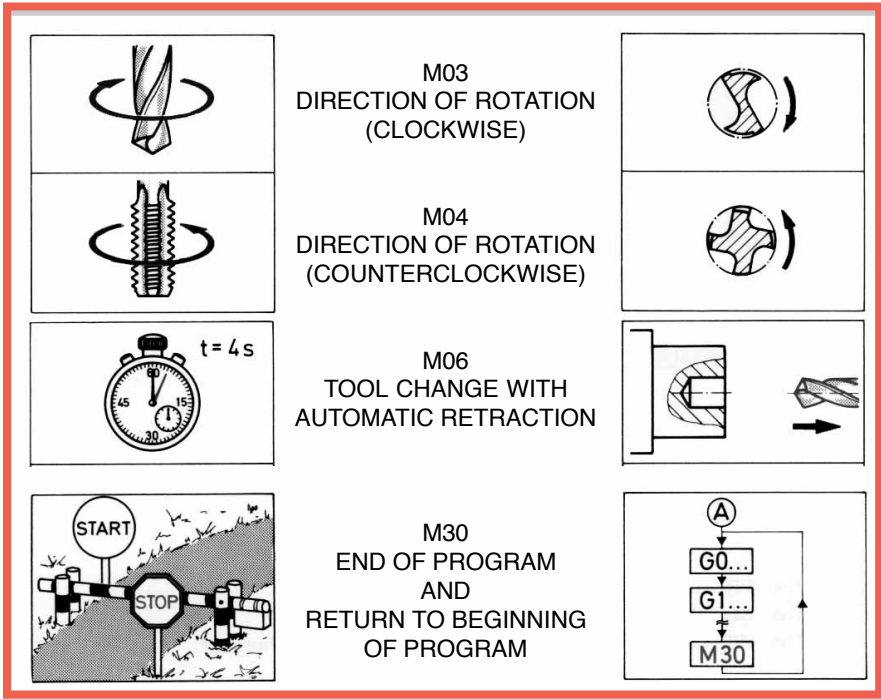

Fig. 15 The functions of a few common M-codes. (Deckel Maho, Inc.)

<u>Code</u>	<u>Function</u>
M00	Program stop
M02	End of program
M03	Spindle start (forward CW)
M04	Spindle start (reverse CCW)
M05	Spindle stop
M06	Tool change
M08	Coolant on
M09	Coolant off
M10	Chuck - clamping (**)
M11	Chuck - unclamping (**)
M12	Tailstock spindle out (**)
M13	Tailstock spindle in (**)
M17	Toolpost rotation normal (**)
M18	Toolpost rotation reverse (**)
M30	End of tape and rewind
M98	Transfer to subprogram
M99	End of subprogram

(\*\*) - refers only to CNC lathes and turning centers.

Fig. 16 Some of the most common M-codes used in CNC programming.

## Block of Information

CNC information is generally programmed in blocks of five words. Each word conforms to the EIA standards and they are written on a horizontal line. If five complete words are not included in each block, the machine control unit (MCU) will not recognize the information, therefore the control unit will not be activated.

Using the example shown in Fig. 17 , the five words are as follows:

<b>N001</b>	<b>represents the sequence number of the operation.</b>
G01	represents linear interpolation
X12345	will move the table 1.2345 in. in a positive direction along the X axis.
Y06789	will move the table 0.6789 in. along the Y axis.
M03	Spindle on CW.

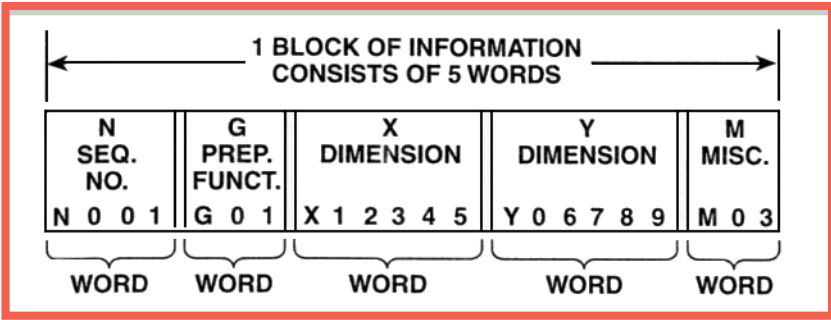

Fig. 17 A complete block of information consists of five words. (Kelmar Associates)

## Programming for Positioning

Before starting to program a job, it is important to become familiar with the part to be produced. From the engineering drawings, the programmer should be capable of planning the machining sequences required to produce the part. Visual concepts must be put into a written manuscript as the first step in developing a part program, Fig. 18. It is the part program that will be sent to the machine control unit by the computer, tape, diskette, or other input media.

The programmer must first establish a reference point for aligning the workpiece and the machine tool for programming purposes.

The manuscript must include this along with the types of cutting tools and work-holding devices required, and where they are to be located.

# From the drawing to the workpiece

1. Reading drawing



2. Programming

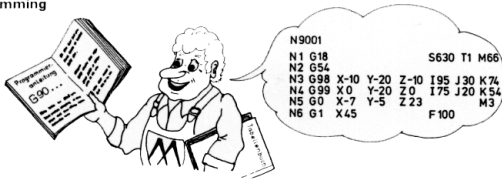

3. Inputting program



4. Manufacturing

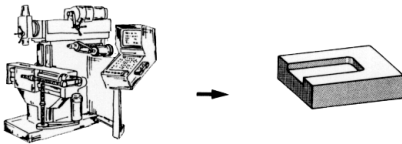

Fig. 18 The first step in producing a CNC program is to take the information from the print and produce a program manuscript. (Deckel Maho, Inc.)

## Dimensioning Guidelines

The system of rectangular coordinates is very important to the successful operation of CNC machines. Certain guidelines should be observed when dimensioning parts for CNC machining. The following guidelines will insure that the dimensioning language means exactly the same thing to the design engineer, the technician, the programmer, and the machine operator.

1. Define part surfaces from three perpendicular reference planes.
2. Establish reference planes along part surfaces which are parallel to the machine axes.
3. Dimension from a specific point on the part surface.

4. Dimension the part clearly so that its shape can be understood without making mathematical calculations or guesses.
5. Define the part so that a computer numerical control cutter path can be easily programmed.

## Machine Zero Point

The machine zero point can be set by three methods—by the operator, manually by a programmed absolute zero shift, or by work coordinates, to suit the holding fixture or the part to be machined.

MANUAL SETTING - The operator can use the MCU controls to locate the spindle over the desired part zero and then set the X and Y coordinate registers on the console to zero.

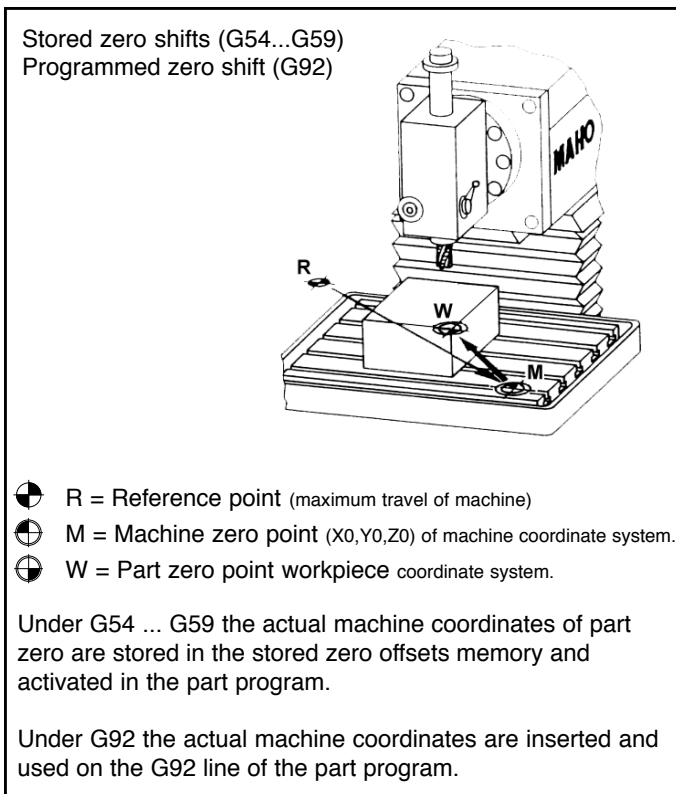

Fig. 19 The relationship between the part zero and the machine system of coordinates. (Deckel Maho, Inc.)

**ABSOLUTE ZERO SHIFT** - The absolute zero shift can change the position of the coordinate system by a command in the CNC program. The programmer first sends the machine spindle to home zero position by a G28 command in the program. Then another command (G92 for absolute zero shift) tells the MCU how far from the home zero location, the coordinate system origin is to be positioned, Fig. 19.

The sample commands may be as follows:

N1 G28 X0 Y0 Z0 (sends spindle to home zero position)  
N2 G92 X4.000 Y5.000 Z6.000 (the position the machine will reference as part zero)

## Work Settings and Offsets

All CNC machine tools require some form of work setting, tool setting, and offsets (compensation) to place the cutter and work in the proper relationship. Compensation allows the programmer to make adjustments for unexpected tooling and setup conditions.

## Work Coordinates

In absolute positioning, work coordinates are generally set on one edge or corner of a part and all programming is generally taken from this position. In Fig. 20, the part zero is used for all positioning for hole locations 1, 2, and 3.

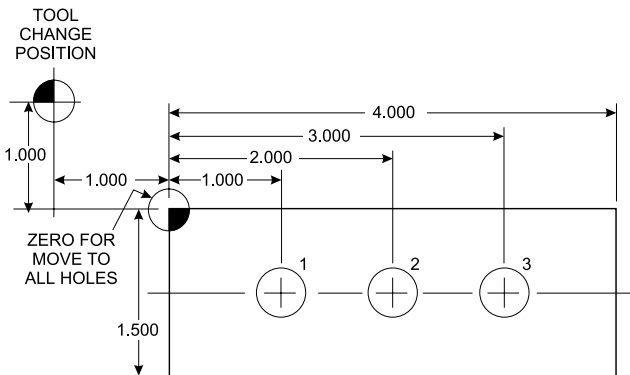

*Fig. 20 In absolute programming, all dimensions must be taken from the XY zero at the top left-hand corner of the part. (Kelmar Associates)*

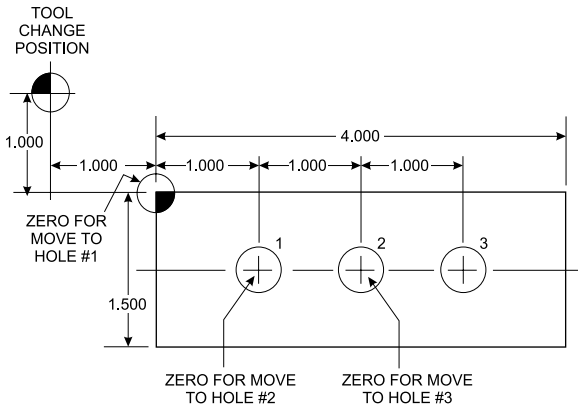

Fig. 21 In incremental programming, all dimensions are taken from the previous point. (Kelmar Associates)

In incremental positioning, the work coordinates change because each location is the zero point for the move to the next location, Fig. 21.

On some parts, it may be desirable to change from absolute to incremental, or vice versa, at certain points in the job. Inserting the G90 (absolute) or the G91 (incremental) command into the program at the point where the change is to be made can do this.

## R Plane or Gage Height

The word-address letter R refers to a partial retraction point in the Z axis to which the end of the cutter retracts above the work surface to allow safe table movement in the X Y axes. It is often called the rapid-traverse distance, gage height, retract or work plane. The R distance is a specific height or distance above the work surface and is generally .100 in. above the highest surface of the workpiece, Fig. 22, which is also known as gage height. Some manufacturers build a gage height distance of .100 in. into the MCU (machine control unit) and whenever the feed motion in the Z axis is called for, .100 in. will automatically be added to the depth programmed.

When setting up cutting tools, the operator generally places a .100 in. thick gage on top of the highest surface of the workpiece. Each tool is lowered until it just touches the gage surface and then its



length is recorded on the tool list. Once the gage height has been set, it is not generally necessary to add the .100 in. to any future depth dimensions since most MCUs do this automatically.

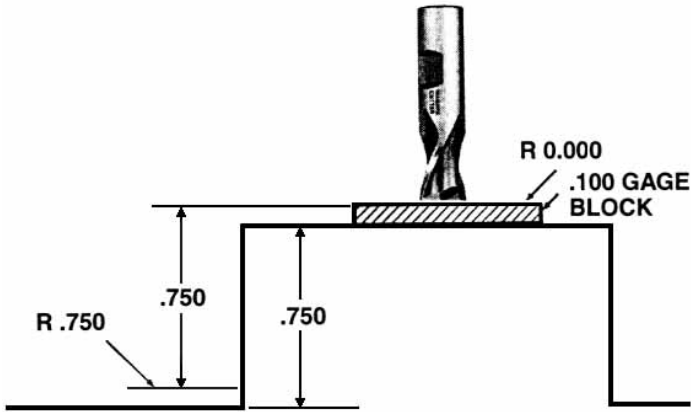

Fig. 22 Using a .100 in. gage block to set the gage height or R0 on the work surface. (Kelmar Associates)

## Cutter Diameter Compensation

Cutter diameter compensation (CDC) changes a milling cutter's programmed centerline path to compensate for small differences in cutter diameter. On most MCUs, it is effective for most cuts made using either linear or circular interpolation in the X-Y axis, but does not affect the programmed Z-axis moves. Usually compensation is in increments of .0001 in. up to +1.0000 in., and usually most controls have as many CDCs available as there are tool pockets in the tool storage matrix.

The advantage of the CDC feature is that it:

1. allows the use of cutters that have been sharpened to a smaller diameter.
2. permits the use of a larger or smaller tool already in the machine's storage matrix.
3. allows backing the tool away when roughing cuts are required due to excessive material present.

- permits compensation for unexpected tool or part deflection, if the deflection is constant throughout the programmed path.

The basic reference point of the machine tool is never at the cutting edge of a milling cutter, but at some point on its periphery. If a 1.000 in. diameter end mill is used to machine the edges of a workpiece, the programmer would have to keep a .500 in. offset from the work surface in order to cut the edges accurately, Fig. 23. The .500 offset represents the distance from the centerline of the cutter or machine spindle to the edge of the part. Whenever a part is being machined, the programmer must calculate an offset path, which is usually half the cutter diameter.

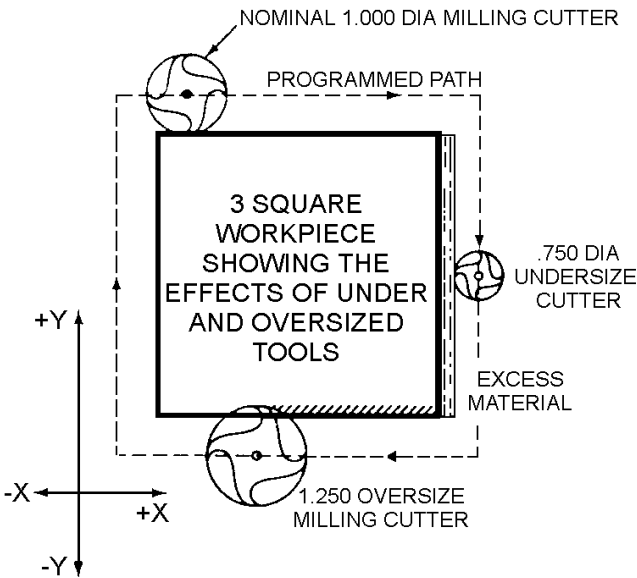

Fig. 23 Cutter-diameter compensation must be used when machining with various size cutters. (Kelmar Associates)

Modern MCUs, which have part surface programming, automatically calculate centerline offsets once the diameter of the cutter for each operation is programmed. Many MCUs have operator-entry capabilities which can compensate for differences in cutter diameters; therefore an oversize cutter, or one that has been sharpened, can be used as long as the compensation value for oversize or undersize cutters is entered.

# CNC Bench-Top Milling and Turning Centers

Bench-top teaching machines are well suited for teaching purposes because neither the student or the teacher are intimidated by the size or complexity of the machines. They are easy to program and perform machining operations similar to industrial machines with smaller workpiece and lighter cuts. Bench-top machines are relatively inexpensive and ideal for teaching basic CNC programming.

Vertical machining centers and turning centers are the most common CNC machines used in industry. For teaching purposes, two types of CNC Bench-Top machines, the lathe and the mill, will be used because they use the same basic programming features and the Fanuc compatible controls as industrial machines. Most of the G and M codes are the same for CNC Bench-top teaching machines and industrial machines. Since programming codes do vary slightly with manufacturers, it is always wise to consult the programming manual for each specific machine to avoid crashes or scrap work.

*Fig. 24 Novamill*

*A compact 3 axis CNC bench milling machine suitable for all levels of education and technical training. The Novamill is controlled via a standard keyboard or Desk-Top Tutor connected to a PC. An optional 6 station Automatic Tool Changer (ATC) is also available. (Denford Inc.)*







The 3-axes bench-top CNC vertical machining center (mill) with the Fanuc compatible controller, Fig. 24, is ideal for teaching the basics of CNC mill programming. It includes all important G and M codes, milling cycles, subroutines, etc. and can be programmed in inch or metric dimensions in both incremental and absolute programming. Some models are equipped with a graphics display that allows the operator to test-run the program on the computer screen without cutting a part. This is a safe way to check the accuracy of a program, to prevent crashes and scrap work, without actually running the machine.



*Fig. 25 Novaturn  
A compact 2 axis CNC bench turning center suitable for all levels of education and technical training. The Novaturn is controlled via a standard keyboard or Desk-Top Tutor connected to a PC.  
(Denford Inc.)*

The CNC Bench-Top turning center (lathe), Fig. 25 is excellent for teaching the basics of CNC lathe programming. It uses the same standard G and M codes as the larger machines, can be programmed in inch or metric dimensions in both absolute and incremental programming. Many teaching machines also are equipped with canned cycle processing and canned thread-cutting cycles. Some models are equipped with a graphic display that allows a student to simulate (test run) the cutting action of the CNC program on the computer screen without actually cutting a part on the machine. This allows the student to check the program for accuracy and make corrections which avoids machine crashes, damage, and scrap parts.

## CNC Programming Hints - MILLING

-  Machine reference point (maximum travel of machine)
-  Machine X Y zero point (could be tool change point)
-  Part X Y zero point (programming start point)
-  Indicates the tool change position. A G92 code will reset the axis register position coordinates to this position.

For a program to run on a machine, it must contain the following codes:

- M03 To start the spindle/cutter revolving.
- Sxxx The spindle speed code to set the r/min.
- Fxx The feed rate code to move the cutting tool or workpiece to the desired position.

### ANGLES:

The X Y coordinates of the start point and end point of the angular surface plus a feed rate (F) are required.

### Z CODES:

- A Z dimension raises the cutter above the work surface.
- A Z- dimension feeds the cutter into the work surface.
- Z.100 is the recommended retract distance above the work surface before a rapid move (G00) is made to another location.

### RADII / CONTOUR Requirements:

- The *start* point of the arc (XY coordinates)
- The *direction* of cutter travel (G02 or G03)
- The *end* point of the arc (XY coordinates)
- The *center* point of the arc (IJ coordinates) or the arc radius)

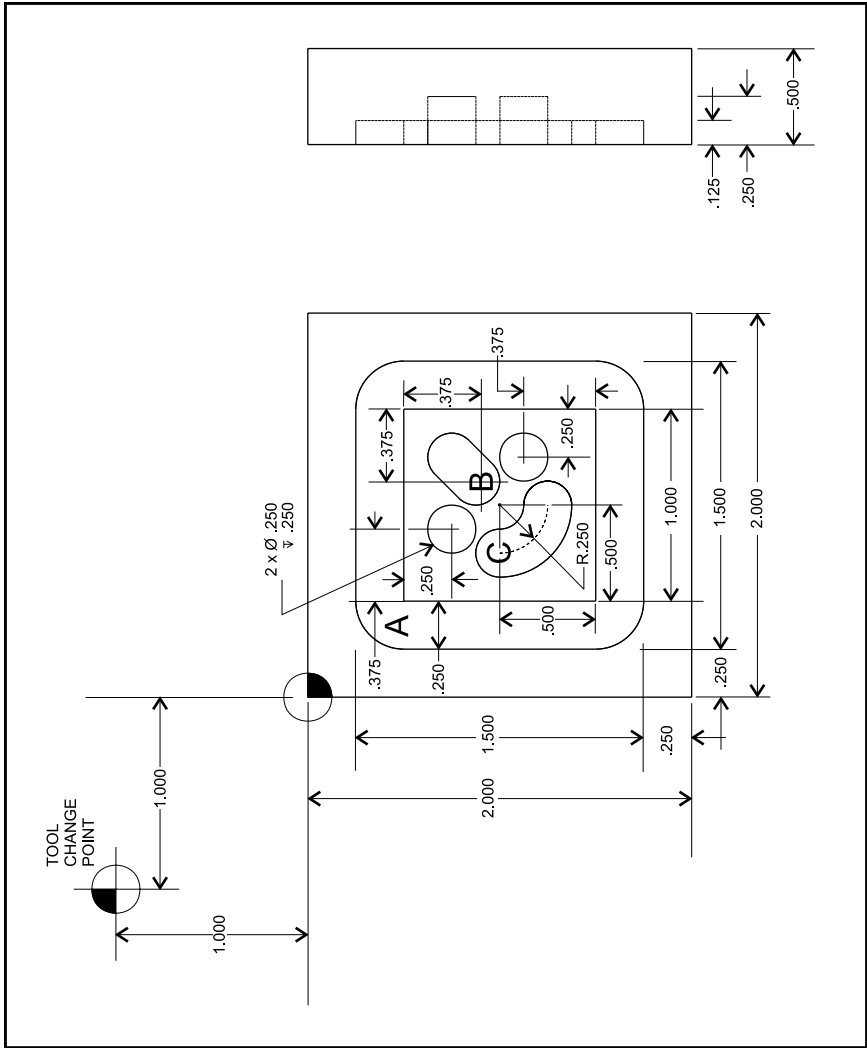

Fig. 26 A sample flat part used for CNC programming and machining (Kelmar Associates)

# Milling and Drilling Programming

## Program Notes: (Fig. 26)

- Program in the absolute mode starting at the tool change position at the top left corner of the print.
- The material is aluminum (300 CS), feedrate 10 in/min.
- The cutting tool is a .250 in. diameter high speed steel 2-flute end mill.
- Mill the 1 in. square slot.
- Drill the two .250 in. diameter holes, .250 in. deep.
- Mill the .250 in. wide angular slot, .125 in. deep.
- Mill the .250 in. wide circular groove, .125 in. deep.
- After the job is completed, return to the tool change position.

## Programming:

% (rewind stop code / parity check)  
2000 (program number)

### N5 G92 X-1.000 Y1.000 Z1.000

G92 programmed offset of reference point (tool change position)  
X-1.000 tool set at 1.000 to the left of the part.  
Y1.000 tool set at 1.000 above the top edge of the part.  
Z1.000 the end of the cutter is 1.000 above the top surface of the part.

### N10 G20 G90

G20 inch data input.  
G90 absolute programming mode.

### N15 M06 T01

M06 tool change command.  
T01 tool no. 1 (.250 diameter, 2-flute end mill).

### N20 S2000 M03

S2000 spindle speed set at 2000 r/min.  
M03 spindle on clockwise.

N25 G00 X0 Y0 Z.100

G00 rapid traverse rate to X0 Y0 at the top left corner of the part.  
Z.100 tool rapids down to within .100 of the work surface.

**Machining the square groove**

N30 X.375 Y-.375

tool rapids to position A.

N35 G01 Z-.125 F10

G01 linear interpolation.  
Z-.125 tool feeds .125 below the work surface.  
F10 feed rate set at 10 in./min.

N40 X1.625 Y-.375

X1.625 top groove cut to the right hand end.  
Y-.375 measurement did not change because it was set in block N30.

N45 Y-1.625

Y-1.625 right hand side of the groove cut.

N50 X.375

X.375 bottom groove cut to the left side.

N55 Y-.375

Y-.375 left-hand side of groove cut; this completes the groove.

N60 G00 Z.100

G00 rapid traverse mode.  
Z.100 tool rapids to .100 above work surface.

**Hole Drilling**

N65 G00 X.875 Y-.750

tool rapids to the top left hole location.



N70 G01 Z-.250 F10

tool feeds .250 into work at 10 in./min. to drill the first hole.

N75 G00 Z.100

tool rapids out of hole to .100 above work surface.

N80 X1.250 Y-1.125

tool rapids to second hole location.

N85 G01 Z-.250 F10

tool feeds .250 into work at 10 in./min. to drill the second hole.

N90 G00 Z.100

tool rapids out of hole to .100 above work surface.

**Machining the Angular Slot**

N95 X1.125 Y-.875 (location B)

tool rapids to the start of the angular slot.

N100 G01 Z-.125 F10

G01 linear interpolation.

Z-.125 tool feeds to .125 below the work surface.

F10 feed rate set at 10 in./min.

N105 X1.250 Y-.750

angular slot cut to top right corner.

N110 G00 Z.100

tool rapids to .100 above work surface.

**Machining the Circular Groove**

N115 X.750 Y-1.000 (location C)

tool rapids to start of circular groove.

N120 G01 Z-.125 F10

tool feeds to .125 below the work surface.

N125 G03 X1.000 Y-1.250 R.250

G03      circular interpolation counterclockwise  
X & Y      location of end of circular groove.  
R.250      radius of arc is .250.

N130 G00 Z.100

tool rapids to .100 above work surface.

N135 X-1.000 Y1.000

tool rapids back to tool change position.

N140 M05

M05      spindle turned off.

N145 M30

M30      end of program

## CNC Programming Hints - TURNING



Indicates the X Z 0 (zero) location which is the starting point for programming.



Indicates the tool-change position.

A G92 code will reset the axis register position coordinates to this position.

For a program to run on a machine, it must contain the following codes:

M03        To start the spindle/cutter revolving.  
Sxxx        The spindle speed code to set the r/min.  
Fxx        The feedrate code to move the cutting tool or workpiece to the desired position.

### TAPERS/BEVELS/ANGLES

- The X Z coordinates of the small diameter, the large diameter, and a feedrate must be programmed.
- Z moves the cutting tool longitudinally away from the end of the workpiece.
- Z- moves the cutting tool along the length of the workpiece towards the chuck (headstock).
- X moves the cutting tool away from the work diameter.
- X- moves the cutting tool into the work diameter.

# Fanuc Compatible Programming

The programming for the Fanuc compatible control is the one most commonly used in industry. Although many controls are similar to the Fanuc control, there are some differences. A few of the main differences are:

- 1.) The G28 code is used to set the programmed offset of the reference point.
- 2.) Codes are modal and do not have to be repeated in every sequence line.
- 3.) All dimensions are entered as decimals.

Using the part illustrated in Fig. 27 the programming for a Fanuc compatible control would be as follows:

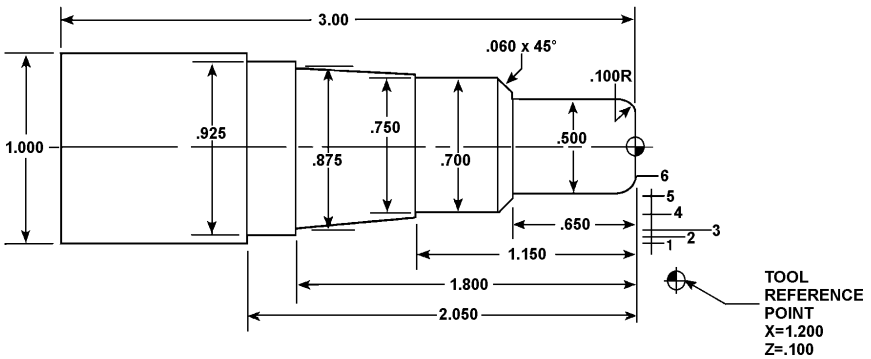

Fig. 27 A typical round part used for CNC programming and machining. (Kelmar Associates)

# Turning Programming

## Programming Sequence

% (rewind stop code/parity check)  
2001 (program number)

### N05 G20 G90 G40

G20 inch data input.  
G90 absolute positioning mode  
G40 cancels tool radius compensation.

### N10 G95 G96 S2000 M03

G95 feed rate per revolution.  
G96 constant feed rate.  
S2000 spindle speed set at 2000 r/min.  
M03 spindle ON clockwise.

### N15 T0202

tool number and offsets.

### N20 G00 X1.200 Z.100

G00 rapid traverse mode.  
X&Z tool reference or change point.  
X1.200 tool point .100 away from the outside diameter.  
Z.100 tool point .100 to the right of end of work.

## Rough Turning Cycle

### N25 G73 U.05 R.05

G73 rough turning cycle.  
U.05 .050 allowance on diameter for finish cut.  
R.05 tool nose radius.

### N30 G73 P35 Q95 U.025 W.005 F.008

P35 start block of rough contour cycle.  
Q95 end block of rough contour cycle.  
W.005 shoulder allowance for finish cut.  
F.008 feed rate at .008 per revolution.

N35 G00 X.300 Z.050

G00 rapid traverse mode.  
X.300 tool point at .300 diameter for start of .100 radius.  
Z.050 tool point .050 away from end of the part.

N40 G01 Z0

G01 linear interpolation (feed).  
Z0 tool point touching end of the work.

N45 G03 X.500 Z-.100 R.100

G03 circular interpolation (counterclockwise).  
X.500 largest diameter of radius.  
Z-100 end of radius on .500 diameter.  
R.100 size of the radius.

N50 G01 Z-.650

G01 linear interpolation.  
Z-.650 machines .500 diameter to .650 length.

N55 X.580

X.580 tool moves out to the small diameter of .060 x 45° bevel.

N60 X.700 Z-.710

X.700 large diameter of bevel.  
Z-.710 end distance of bevel.

N65 Z-1.150

Z-1.150 the .700 diameter cut to 1.150 length.

N70 X.750

X.750 cutting tool feeds out to .750 (small end of taper).

N75 X.875 Z-1.800 (cutting taper)

X.875 large end of taper.  
Z-1.800 length that taper is cut.

N80 X.925

X.925 tool feeds out (faces) to .925 diameter.

N85 Z-2.050

Z-2.050 the .925 diameter is cut to 2.050 length.

N90 X1.050

X1.050 the tool is fed out to .050 past the diameter of the part.

N95 G00 X1.200 Z.100 (tool back to tool reference point)

G00 rapid traverse mode.

X1.200 & Z.100 (reference point positions)

**Finish Turning**

N100 G72 P35 Q95 F.005

G72 finish turn cycle.

F.005 feed rate .005 per revolution.

N105 G00 X2.000 Z.500

G00 rapid traverse mode.

X2.000 & Z.500 machine home position.

N110 M30

M30 end of program

% Rewind code.