

CRS Pump Parts .com



USA



CANADA



INTL

Concrete Pump Parts & Accessories

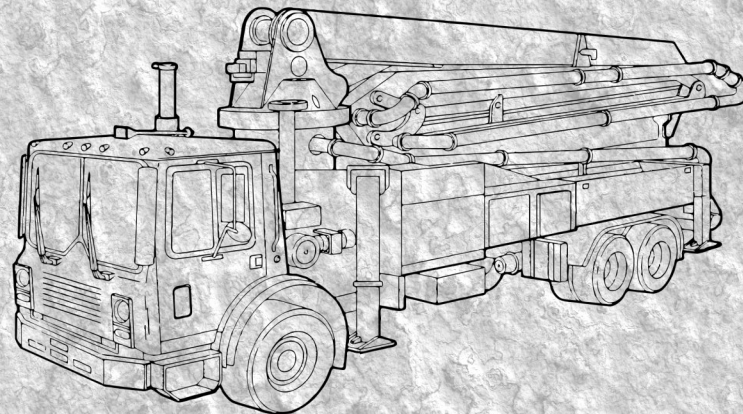

*Representing 35 Years of Experience
Manufacturing Quality Wear Parts,
European Made*

2nd Edition

Table of Contents

<u>Putzmeister</u>	<u>Page</u>
S-Tube	1-2
Back End	3
Agitator Shaft & Bearing	4
Wear Parts	5-6
<u>Schwing</u>	
Rock Valve Assembly	7-8
Outlet Assembly	9-10
Ram Flanges & Cylinder Seals	11
Wear Parts	12-13
Agitator Motor, Bearings & Paddles	14
Gate Valve	15
Siamese Hook Up	16
<u>Placing and Reducing Hose</u>	
Placing Hoses	17
Reducing Hoses	17
<u>Clamps and Gaskets</u>	
Clamps	18
Putzmeister Accessory Clamps	19
Schwing Accessory Clamps	19
Gaskets	20

Table of Contents

<u>Enviro-Systems</u>	<u>Page</u>
Pump Primer	21
Concrete Retarder	21
Concrete Remover	21
Concrete Sticking Prevention	21
Heavy Duty Truck Wash	21
<u>Elbows, Reducers & Pipes</u>	
Elbows	22
Putzmeister Elbows	22
Schwing Elbows	22
Reducers	23
Weld On Ends	23
Pipes	24
<u>Accessories</u>	
Nylon Safety Straps	25
Batteries and Chargers	25
Outrigger Pads	25
Hopper Vibrators	25
Cleanout Accessories	26
Water Pumps	26
E-Stop Control	26

S-Tube



S-Tube Hard Faced

U402866



Big Mouth S-Tube

U434023



Chrome Sleeve

U228383004



Drive Lever

U453455



Set Of Ball Cups (2pcs)

U275694005



Bearing Assy W/Oring Grooves

U027864009/3



Inner Sleeve W/Oring Grooves

U027782000/3



Shaft Bearing Seal Kit

U027864009SK

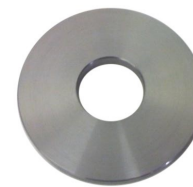

Washer

U410555MOD

S-Tube



Plunger Cylinder
160-60

U262840008

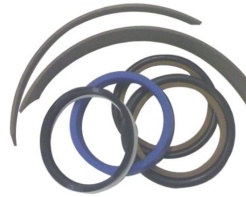

Plunger Cylinder
Seal Kit

U262840008SK

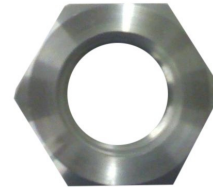

Hex Nut

U033718000



S-Tube Sweeper
Assembly

U220219008

Back End

 <p>Transition Elbow</p> <p>U242327004</p>	 <p>Elbow 6"ZX Male x ZX Female</p> <p>UA104003PHT</p>	 <p>Reducer 6"Met x 5"Met x 1200mm</p> <p>P6548RPMHPHT</p>
 <p>Bearing Ring</p> <p>U240391003</p>	 <p>Oring</p> <p>U069042009</p>	 <p>Holding Pin</p> <p>U262639002</p>
 <p>Wedge</p> <p>U426793</p>		

Agitator Shaft & Bearing



Mixer End Shaft
60mm

U275587002



Bearing Flange
60mm

U242573007



Seal 60mm

U242574006



DU Bushing
D60 60mm

U222484006



Oring
60mm

U043909003



Hydraulic Motor

U238130001



Center Agitator
Shaft

U243189005

Wear Parts



Wear Plate

U229488005



Wear Ring

U251031006



Thrust Ring

UA099011



Big Mouth
Wear Plate

U261122002



Big Mouth
Wear Ring

U261123001



Big Mouth
Thrust Ring

U269520004



Big Mouth
Intermediate Ring

U263330009



Solid Piston
DN230

U019003001



Band
230mm

U080672005

Wear Parts



Seal
230mm

U080373003



235 x 5 Oring

U043635005



M16 x 125 Bolt

U262287001



Lock Washer

U036509009

Rock Valve Assembly

Rock Valve
DN210

S10059467

Shaft New Mod
Rock

S10064073



Slewing Lever

S10018071

Safety Disc 30
Burnished

S10015401



Bolt for Shaft

S10001295



Bearing Bushing

S10018037



Bearing Bushing

S10018047



Sealing Cover

S10018035

Oring
95 x 8

S10016241

Rock Valve Assembly



Oring
70 x 8

S10017436



Tension Nut

S10043980



Setting Disc

S10017396



Cover

S10018073

Outlet Assembly



Outlet
14deg

S10026159



Oring
200 x 10

S10000602



Transition Elbow

S10017547



Oring
DN150

S10004761



Elbow
DN150

S10069521



Reducer
6" Fem x 5"Metric
x 1600mm
P6563RSMHT



Wedge

S10004709



Holding Pin

S10002386



Screw for
Holding Pin

S10018117

Outlet AssemblyWasher for
Holding Pin

S10001639

Hinge Bolt
Assembly

S10018123

Steel Hopper
Door

S10080782



Hopper Door Seal

S10035783

Hopper Door
Wedge Left

S10032789

Hopper Door
Wedge Right

S10032788

Ram Flanges & Cylinder Seals



Ram Flange 8"
DN200

S10161754



Ram Flange 9"
DN230

S10161634



Ram Flange 10"
DN250

S10161980



Differential
Cylinder Sealing
Gland Set
S10003421



Differential
Cylinder Scraper
S10002329

Wear Parts

Mounting Plate
180/200/230

S10074769



Mounting Plate
250

S10181938



Wear Plate 8"
DN200

S10074767



Wear Plate 9"
DN230

S10074768



Wear Plate 10"
DN250

S10166658



Pressure Spring
Belt
DN210
S10064472



Pressure Spring
Belt
DN220
S10181917



Pressure Spring
Belt
DN230
S10166975



Cutting Ring
DN210
S10063939

Wear Parts



Cutting Ring
DN220

S10181916



Cutting Ring
DN230

S10166890



Kidney Seal
DN180

S10029138



Kidney Plate
DN180

S10018046



Cover Lining
Hard Faced

S10018029

Agitator Motor, Bearings & Paddles



Agitator Motor

S10039180



Fixed Bearing Assembly

S10061073



Drive Bearing Assembly

S10061072



Agitator Bearing Seal

S10061076



Mod-Rock Paddle
AR400 Steel

S30311720



E-Rock Paddle
AR400 Steel

S10167219



Agitator Complete
Shaft w/ Paddles

S10052446

Gate Valve



Gate Valve Rod
8"

S10003037



Cup Body Pearl
8"

S10014012



Guide Sleeve

S10013830

Siamese Hook Up

Holding Bolt

S10002343



Lock Nut

S10009597



Wedge

S10006368



Pin

S10004756



Threaded Bolt

S10004711



Disc

S10014274

Placing & Reducing Hoses

Placing Hoses & Reducing Hoses



3" x 15ft, Textile
1000psi, HD Ends



4" x 15ft, Textile
1000psi, HD End-
Open End



4" x 15ft, Textile
1000psi, HD Ends



4" x 10ft, Wire
Braid, 1300psi
HD Ends



4" x 15ft, Wire
Braid, 1300psi
HD End
Open End



4" x 15ft, Wire
Braid, 1300psi
HD Ends



Reducing
148mm x 3" x 12ft
Textile, 85 Bar



Reducing
148mm x 4" x 12ft
Textile, 85 Bar

**Other Sizes
Available
Please Call
For Price
And Delivery**

Clamps & Gaskets

Clamps



Steel Clamp
Safety Pin



2" HD Clamp
Non-Adjustable



3" HD Clamp
Non-Adjustable
& Adjustable



4" HD Clamp
Non-Adjustable
& Adjustable



5" HD Clamp
Non-Adjustable
& Adjustable



5" M (148mm)
Snap Clamp

Clamps

- Heat Treated
- Manufactured from Low Carbon Steel
(High Carbon Steel More Susceptible to Cracking)
- Bore Machined
- Pins Welded, Not Clips
- Adjustable Threads Protected
- Attached Safety Label
- Pure Rubber Gasket Included

Clamps & Gaskets

Putzmeister Accessory Clamps



Putzmeister
Wedge Clamp
DN150
U240948003



Wedge
U240945009



Putzmeister
Screw Coupling
U027707001



Putzmeister Snap
Clamp Coupling
Two Bolt Mount
U239932004

Schwing Accessory Clamps



Schwing
Wedge Clamp
DN150
S10043559



Schwing Boom
Tip Coupling With
Flange
S10133242

Clamps & Gaskets

Gaskets



2" HD V-Style
Gasket



3" HD V-Style
Gasket

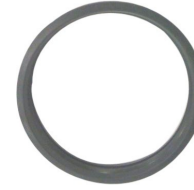

4" HD V-Style
Gasket

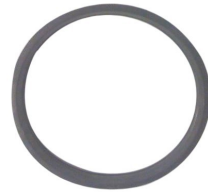

5" HD V-Style
Gasket



5"M (148mm)
V-Style Gasket



5"M (148mm)
Cavity-Style
Gasket

Gaskets

- Made from Pure Rubber
- Anti Oil Compound

Enviro-Systems



Pump Primer
Slick Willie 2
50-4oz Bags/Pail



Pump Primer
EZ Prime
50-2oz Packets/
Box



Pump Primer
Prime-A-Pac
18-32oz Bags/
Pail



Concrete Retarder
Slow Willie
20-16oz Bags/
Pail



Concrete Remover
Crete Buster
5Gal Container



Concrete Sticking Prevention
Willie Shield
5Gal Container



HD Truck Wash
Prime-A-Wash
5Gal Container

Elbows, Reducers & Pipes

Elbows

45° & 90° Elbows

- Heat Treated
- Made with Stronger Wearing High Manganese



5" M (148mm)
x 45 Deg



5" M (148mm)
x 90 Deg

"FAT BACK"

45° & 90° Elbows
Have up to 40%
Thicker Material
Than Competition



Putzmeister
15 Deg Elbow

U057598002



Putzmeister
20 Deg Elbow

U245484009



Putzmeister
30 Deg Elbow

U258935008



Schwing
14 Deg Elbow

S10009928



Schwing
32.5 Deg Elbow

S10035756

Elbows, Reducers & Pipes

Reducers



5”M - 4”HD x 36”
Hardened Steel
4”HD - 3”HD x 36”
Hardened Steel

Reducers

- Inside Hardened
- Outside Softer Material
(Outside Harder Material more Susceptible to Cracking)
- Ends are Flange Welded
- Handles are Welded to a Plate
- Outlet End has Increased Wall Thickness and Hardness

Weld On Ends



3” HD



4” HD



5” HD

Chrome Carbide Ends

- Two Stage Heat Treated
- Insert 40mm Wide, 63 HRC



5”M (148mm)



Chrome Carbide
5”M x 5mm



Chrome Carbide
5”M x 7mm

Elbows, Reducers & Pipes

Pipes

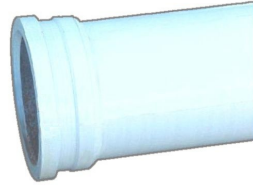

4"HD x 3Meter

Line Pipe



5"M x 3Meter
x 5mm

Ind Hardened
Boom Pipe



5" U-Bolt M16

Boom U-Bolt



5"M x 3Meter
x 7mm
Ind Hardened
Deck Pipe

Line Pipe

- **Manufactured from 1020 Steel**
- **Properly Welded HD Ends**
- **Metal ID Tag**

Boom and Deck Pipe

- **Manufactured from ST52 Plus Steel**
- **Inside Induction Hardened**
- **Chrome Carbide Insert Ends, 40mm Wide**
- **Smooth Transition from Pipe to End, No Step**
- **Metal ID Tag with Serial Number**
- **Boom Pipe 0.5mm Heavier Wall than Competition**
- **Boom Pipe Weight 49kg (108 lbs)**

Accessories



1" x 52" Nylon Safety Strap



1" x 82" Nylon Safety Strap



Ratchet Strap



Makita 9.6 Volt Battery



Makita Automotive Charger

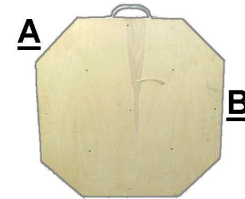

Treated Birch Plywood Pad
23½ x 23½ x 3"
A = 7½, B = 13"



Treated Birch Plywood Pad
23½ x 23½ x 3"
A = 4½, B = 17"



12 Volt Hopper Vibrator



24 Volt Hopper Vibrator

Accessories

Accessories



6" Soft Sponge
Clean Out Ball
• High Density
Foam



5" Hard Sponge
Clean Out Ball
• High Density
Foam



Sponge Clean
Out Cylinder



Hypro 1502C
Water Pump



Hypro 1502C
Water Pump
Repair Kit



Hypro 7560C
Water Pump



Hypro 7560C
Water Pump
Rebuild Kit



E-Stop Control

AKIT-1821-01

Terms & Conditions

Prices, Designs and Terms and Conditions of Sale are subject to change without notice.

All material is carefully counted and packed. Claims for corrections must be made within 10 days of receipt of goods. Our responsibility ceases when goods are delivered to carrier in good condition and its receipt is obtained. Carriers are responsible for goods lost, damaged or delayed in transit. For your own protection, have the transportation company's agent verify damages, shortages, or delays and note them on the freight bill over his signature.

Goods may not be returned without a RGA from a Component Repair & Supply salesperson. A minimum 20% restocking charge will apply to all goods returned.

CRS Warranty

We warrant each new product and repair made or distributed by us to be free from defects in material and workmanship, for a period of 3 months under normal service from date of delivery. Our obligation and liability under this warranty being expressly and exclusively limited to repairing, or at our option, replacing, free of charge at our factory.

Parts claimed to be defective and for which repair or replacement is desired shall be, if requested by us, returned transportation prepaid to our factory for inspection.

THIS WARRANTY IS IN LIEU OF ALL OTHER WARRANTIES, EXPRESSED OR IMPLIED, WHETHER STATUTORY OR OTHERWISE, INCLUDING BUT NOT LIMITED TO WARRANTIES OF MERCHANTABILITY AND FITNESS FOR ANY PARTICULAR PURPOSE, AND OUR OBLIGATION AND LIABILITY UNDER THIS WARRANTY SHALL NOT INCLUDE ANY TRANSPORTATION OR OTHER CHARGES OR THE COST OF INSTALLATION OR ANY LIABILITY FOR DIRECT, INDIRECT OR CONSEQUENTIAL DAMAGE OR DELAY RESULTING FROM THE DEFECT. Any operation beyond rated capacity or improper use or application or substitution of parts not approved by us or any alteration or repairs by others in such manner as, in our judgement, to affect the product materially and adversely shall void this warranty in any way, and no attempt, effort or promise to repair, either by us or by any representative at any time, shall change or extend this warranty in any way. THIS WARRANTY REPRESENTS THE FINAL AGREEMENT BY THE BUYER AND US TO ALL WARRANTIES, EXPRESSED OR IMPLIED, WHICH APPLY TO THE SALE AND OR REPAIR OF THE PRODUCTS DESCRIBED. IN NO EVENT SHALL COMPONENT REPAIR & SUPPLY BE LIABLE FOR ANY INCIDENTAL OR CONSEQUENTIAL DAMAGES, EVEN IF SUCH DAMAGES ARE DIRECT OR INDIRECT OF COMPONENT REPAIR & SUPPLY'S NEGLIGENCE. BUYER AGREES TO MAKE NO CLAIM AGAINST COMPONENT REPAIR & SUPPLY BASED ON NEGLIGENCE.

CRS Pump Parts .com CRS Pump Parts .com

CRS Pump Parts .com

CRS Pump Parts USA

59 Sanford Drive, Unit #4
Gorham, ME 04038

1 877 299 8591

207 856 2103 (ph)

207 856 2475 (fax)

Contact: Josh Stultz

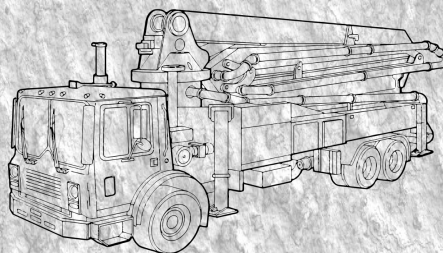

CRS Pump Parts Canada

2125B Route 128

Berry Mills, NB E1G-4K5

1 800 833 2739

506 857 2727 (ph)

506 857 1659 (fax)

Contact: Andy Stultz

CRS Pump Parts .com



CRS Pump Parts .com CRS Pump Parts .com