

TO: Holders of the Geometric Design Guide for Canadian Roads (1999)
FROM: Transportation Association of Canada
SUBJECT: December 2011 Updates to the Geometric Design Guide for Canadian Roads

Enclosed please find 94 new and/or revised pages for insertion into your copy of the *Geometric Design Guide for Canadian Roads*. Revisions in this package affect the following items:

Title Page – Part 1 and 2
Chapter 1.1 – Philosophy
Chapter 1.2 – Design Controls
Chapter 2.1 – Alignment and Lane Configuration
Chapter 2.2 – Cross Section Elements
Chapter 2.3 – Intersections
Chapter 3.1 – Roadside Safety

To update your Guide simply follow these instructions:

1. Remove the Title Page from Part 1 and Part 2 and insert the new Title Pages.
2. Remove pages 1.1.4.3 – 1.1.4.4 and replace with new pages 1.1.4.3 -1.1.4.4.
3. Remove pages 1.2.i -1.2.ii and replace with new pages 1.2.i -1.2.ii.
4. Remove pages 1.2.5.5 – 1.2.5.8 and insert new pages 1.2.5.5 – 1.2.5.10.
5. Remove pages 1.2.R.1 – 1.2.R.2 and replace with new pages 1.2.R.1 – 1.2.R.2.
6. Remove pages 2.1.i – 2.1.vi and replace with new pages 2.1.i – 2.1.vi.
7. Remove pages 2.1.2.3 – 2.1.2.10 and replace with new pages 2.1.2.3 – 2.1.2.10.
8. Remove pages 2.1.2.15 - 2.1.2.16 and replace with new pages 2.1.2.15 – 2.1.2.16.
9. Remove pages 2.1.3.9 – 2.1.3.16 and replace with new pages 2.1.3.9 – 2.1.3.16.
10. Remove pages 2.1.R.1 – 2.1.R.2 and replace with new page 2.1.R.1 – 2.1.R.2.
11. Remove pages 2.2.iii – 2.2.iv and replace with new pages 2.2.iii – 2.2.iv.
12. Remove pages 2.2.2.3 – 2.2.2.4 and replace with new pages 2.2.2.3 – 2.2.2.4.
13. Remove pages 2.2.4.3 -2.2.4.4 and replace with new pages 2.2.4.3 -2.2.4.4.
14. Remove pages 2.2.4.5 – 2.2.4.6 and replace with new pages 2.2.4.5 – 2.2.4.6.
15. Remove pages 2.2.10.7 – 2.2.10.8 and replace with new page 2.2.10.7 – 2.2.10.8.

... / 2

16. Remove pages 2.2.R.1 – 2.2.R.2 and replace with new pages 2.2.R.1 – 2.2.R.2.
17. Remove pages 2.3.i – 2.3.vi and replace with new pages 2.3.i – 2.3.vi.
18. Remove page 2.3.2.15 – 2.3.2.16 and replace with new pages 2.3.2.15 – 2.3.2.16.
19. Remove pages 2.3.3.3 – 2.3.3.18 and replace with new pages 2.3.3.3 – 2.3.3.20.
20. Remove pages 2.3.12.1 – 2.3.12.6 and replace with pages 2.3.12.1 – 2.3.12.6.
21. Remove pages 2.3.R.1 – 2.3.R.2 and replace with new pages 2.3.R.1 – 2.3.R.2.
22. Remove pages 3.1.6.3 – 3.1.6.6 and replace with new pages 3.1.6.3 – 3.1.6.6.
23. Remove pages 3.1.R.1 – 3.1.R.2 and replace with new pages 3.1.R.1 – 3.1.R.2.

Thank you for your attention. If you have any questions please do not hesitate to contact the TAC secretariat.

**Transportation
Association of
Canada**



**Geometric
Design
Guide for
Canadian
Roads**

Part 1

**September 1999
Updated December 2011**

The Transportation Association of Canada is a national association with a mission to promote the provision of safe, secure, efficient, effective and environmentally and financially sustainable transportation services in support of Canada's social and economic goals. The association is a neutral forum for gathering or exchanging ideas, information and knowledge on technical guidelines and best practices. In Canada as a whole, TAC has a primary focus on roadways and their strategic linkages and inter-relationships with other components of the transportation system. In urban areas, TAC's primary focus is on the movement of people, goods and services and its relationship with land use patterns.

L'ATC est une association d'envergure nationale dont la mission est de promouvoir la sécurité, la sûreté, l'efficacité, l'efficacités et le respect de l'environnement dans le cadre de la prestation de services financièrement durables de transport, le tout à l'appui des objectifs sociaux et économiques du Canada. L'ATC est une tribune neutre de collecte et d'échange d'idées, d'informations et de connaissances à l'appui de l'élaboration de lignes directrices techniques et de bonnes pratiques. À l'échelle du pays, l'Association s'intéresse principalement au secteur routier et à ses liens et interrelations stratégiques avec les autres composantes du réseau de transport. En milieu urbain, l'Association s'intéresse non seulement au transport des personnes et des marchandises, mais encore à la prestation de services à la collectivité et aux incidences de toutes ces activités sur les modèles d'aménagement du territoire.

In some senses, this Guide is no different from previous versions. It is intended to provide a framework for designers which promotes efficiency in design and construction, economy, and consistency and safety for the road user. This Guide, however, moves away from “standards” as the basis for achieving these goals, to introduce a new concept called the Design Domain. The intention is to provide designers with a greater opportunity to exercise their critical engineering judgement - with better information on which to base that judgement.

This change in approach has occurred in part because of the difficulty of applying the concept of “standards”, as they are thought of in other fields, to a process that necessarily requires the designer to exercise professional judgement and expertise in their application to road design. The transition has also come about because of the emergence of road safety research, which is bringing new data to bear on the road design task. This Guide provides designers with guidelines about the use of new data, where these are available. This is intended to enhance the designer’s ability to explicitly assess the safety impacts of design alternatives in the context of the impacts which such changes may have on other aspects of road performance including operations, the environment and the economics of construction.

This change of approach is also intended to provide greater flexibility to the designer in addressing issues of concern related to constrained, unusual, or sensitive design environments. Such flexibility provides a vehicle through which designers can respond more positively to the emerging design process referred to as Context Sensitive Design (CSD) or Context Sensitive Solutions (CSS). CSD/CSS is not a specific design technique. Rather, it is a design process that is highly collaborative in nature in which – at the outset of the design process and prior to any design being undertaken – public consultation may be used to help establish the desired functionality, nature, and character of the roadway from the point of view of all stakeholders. Once a consensus has been reached on this fundamental vision, the design process moves forward within this context; hence the reference to CSD or CSS.

The guidelines and design domains provided in this Guide are based on prevailing and predicted vehicle dimensions and performance, driver behaviour and performance, and current technologies. For instance, at this time, specific advice on the use of design flexibility within CSS or CSD processes is not addressed within the various sections of the Guide. However, as knowledge in these fields evolves, it is expected that the resulting guidelines will be revised and updated periodically, and that enhanced application heuristics will be provided to address particular design applications, including the exercise of design flexibility within CSS/CSD processes.

Changes in the design domains in this document over time in the future, or differences between these and previous “standards”, do not imply that roads designed on the basis of former “standards” are necessarily inadequate. Rather, the new design framework and approach can be expected to generate designs for new facilities and rehabilitation and reconstruction of existing facilities that more appropriately reflect evolving knowledge, as well as the changing view of society on the role of the roadway within our urban and rural communities.

It should be noted that gradual adoption of design dimensions based, for example, on collision experience or on the exercise of design flexibility within a CSD/CSS approach, may not have the same theoretical margins of safety under most operating conditions as traditional “standards” based on laws of physics. However, they will be more realistic, and may result in road designs that are less costly to construct, or provide a roadway that is more responsive to community and stakeholder needs.

This Guide places a much greater emphasis on the role of the designer in the design process. It requires more explicit analysis of the road safety impacts of various alternatives, and where possible suggests a basis on which to carry out such analysis. It places greater demands on the designer in terms of exercising skills, knowledge, and professional judgment. It emphasizes the responsibility of the designer to properly and fully inform those responsible for policies, which affect all aspects of cost effective road design, of the potential consequences of their decisions.

1.2 DESIGN CONTROLS

1.2.1	INTRODUCTION	1.2.1.1
1.2.2	HUMAN FACTORS	1.2.2.1
1.2.2.1	Expectancy	1.2.2.1
1.2.2.2	Reaction	1.2.2.1
1.2.2.3	Design Response	1.2.2.2
1.2.3	SPEED	1.2.3.1
1.2.3.1	Introduction	1.2.3.1
1.2.3.2	Desired Speed	1.2.3.1
1.2.3.3	Design Speed	1.2.3.2
1.2.3.4	Operating Speed	1.2.3.3
1.2.3.5	Running Speed	1.2.3.3
1.2.3.6	Posted Speed	1.2.3.4
1.2.3.7	Limitations of Design Speed Approach	1.2.3.5
1.2.3.8	Design Domain: Design Speed Selection	1.2.3.6
1.2.4	DESIGN VEHICLES	1.2.4.1
1.2.4.1	Introduction	1.2.4.1
1.2.4.2	Vehicle Classifications	1.2.4.1
1.2.4.3	Vehicle Characteristics	1.2.4.2
1.2.4.4	Vehicle Turning Paths	1.2.4.10
1.2.4.5	Selecting a Design Vehicle	1.2.4.10
1.2.5	SIGHT DISTANCE	1.2.5.1
1.2.5.1	Criteria Used in Calculating Sight Distance	1.2.5.1
1.2.5.2	Stopping Sight Distance	1.2.5.2
1.2.5.3	Passing Sight Distance	1.2.5.5
1.2.5.4	Decision Sight Distance	1.2.5.8
REFERENCES		1.2.R.1

Tables

Table 1.2.2.1	Perception and Reaction Time Design Domain	1.2.2.2
Table 1.2.4.1	Design Dimensions for Passenger Cars	1.2.4.2
Table 1.2.4.2	Design Dimensions for Commercial Vehicles	1.2.4.2
Table 1.2.4.3	Design Dimensions for Buses	1.2.4.3
Table 1.2.4.4	Minimum Design Turning Radii for Representative Trucks, for 180° Turns	1.2.4.3
Table 1.2.5.1	Object Height Design Domain	1.2.5.2
Table 1.2.5.2	Coefficient of Friction for Wet Pavements	1.2.5.3
Table 1.2.5.3	Stopping Sight Distance for Automobiles and Trucks with Antilock Braking Systems	1.2.5.4
Table 1.2.5.4	Stopping Sight Distances for Trucks with Conventional Braking Systems	1.2.5.5
Table 1.2.5.5	Minimum Passing Sight Distance - AASHTO (design) Methodology	1.2.5.6
Table 1.2.5.6	Minimum Passing Sight Distance - Manual of Uniform Traffic Control Devices for Canada (marking) Methodology	1.2.5.7
Table 1.2.5.7	Decision Sight Distance	1.2.5.9

Figures

Figure 1.2.3.1	Operating Speed Approach for Design of Two-lane, Two-way Roadways	1.2.3.9
Figure 1.2.4.1	Passenger Car (P) Dimensions	1.2.4.4
Figure 1.2.4.2	Light Single-Unit (LSU) Truck Dimensions	1.2.4.5
Figure 1.2.4.3	Medium Single-Unit (MSU) Truck Dimensions	1.2.4.5
Figure 1.2.4.4	Heavy Single-Unit (HSU) Truck Dimensions	1.2.4.6
Figure 1.2.4.5	WB-19 Tractor-Semitrailer Dimensions	1.2.4.6
Figure 1.2.4.6	WB-20 Tractor-Semitrailer Dimensions	1.2.4.7
Figure 1.2.4.7	A-Train Double (ATD) Dimensions	1.2.4.7
Figure 1.2.4.8	B-Train Double (BTD) Dimensions	1.2.4.8
Figure 1.2.4.9	Standard Single-Unit (B-12) Bus Dimensions	1.2.4.8
Figure 1.2.4.10	Articulated Bus (A-BUS) Dimensions	1.2.4.9
Figure 1.2.4.11	Intercity Bus (I-BUS) Dimensions	1.2.4.9
Figure 1.2.5.1	Elements of Passing Sight Distance	1.2.5.6
Figure 1.2.5.2	Required Passing Sight Distance for Passenger Cars & Trucks in Comparison with AASHTO Criteria	1.2.5.7

Table 1.2.5.4 Stopping Sight Distances for Trucks with Conventional Braking Systems

Design Speed (km/h)	Stopping Sight Distance (m)	
	from Table 1.2.5.3	for Trucks with Conventional Braking ⁸
40	45	60 - 70
50	60 - 65	85 - 110
60	75 - 85	105 - 130
70	95 - 110	135 - 180
80	115 - 140	155 - 210
90	130 - 170	190 - 265
100	160 - 210	235 - 330
110	180 - 250	260 - 360
120	200 - 290	Not Available
130	230 - 330	Not Available

for the effects of grade. It has been noted⁴ that many drivers, particularly those in automobiles, do not compensate completely (i.e. by acceleration or deceleration) for the changes in speed caused by grade. It is also noted⁴ that, in many cases, the sight distance available on downgrades is greater than on upgrades, which can help to provide the necessary corrections for grade.

1.2.5.3 Passing Sight Distance

Passing sight distance is used for rural two-lane roads to allow drivers to pass slower traffic by using the opposing lane. The driver of the passing vehicle must be able to see far enough ahead to complete the manoeuvre without interfering with traffic in the opposing lane. Drivers will occasionally pass slower vehicles without being able to see sufficient distance ahead, however to design for this type of driver behaviour would not result in adequate levels of service since more cautious drivers would not attempt to pass. Thus passing sight distance should be based on the length needed to complete a passing

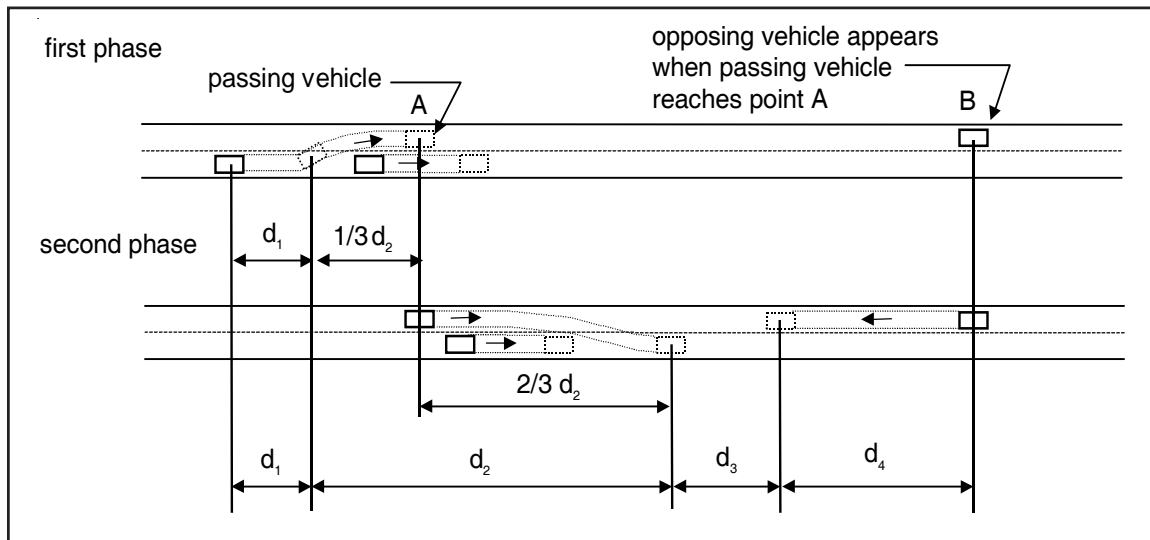
manoeuvre as shown in Figure 1.2.5.1, which divides the required sight distance into four elements.

- d_1 Initial manoeuvre distance. The initial manoeuvre period consists of a perception and reaction time and the time it takes for the passing driver to move the vehicle from a trailing position to a position of encroachment into the opposing lane of traffic.
- d_2 Distance travelled while the passing vehicle occupies the opposing lane.
- d_3 Clearance length. The distance between the opposing vehicle and the passing vehicle at the end of the passing vehicle's manoeuvre. Observed distances vary from 30 m to 90 m.
- d_4 Distance travelled by the opposing vehicle after being seen by the passing vehicle. The opposing vehicle is assumed to be travelling at the same speed as the passing vehicle, therefore this distance is equal to two thirds of d_2 .

Certain assumptions about driver behaviour are made when computing passing sight distance.

- The vehicle being passed travels at a uniform speed.
- The passing vehicle has reduced speed and trails the overtaken vehicle as it enters a passing section.
- The driver of the passing vehicle requires a short period of time to determine that there is a clear passing section ahead and begin the passing manoeuvre.
- Passing is accomplished under a delayed start and a hurried return to the original lane while facing traffic. The passing vehicle accelerates during the manoeuvre, to a speed 15 km/h higher than that of the passed vehicle.
- There will be a suitable distance between the vehicle completing the passing manoeuvre and the oncoming vehicles.

Figure 1.2.5.1 Elements of Passing Sight Distance²¹



Two methodologies exist to calculate Passing Sight Distance. The first (design) is based on the 1994 AASHTO methodology using an Eye Height of 1.05 m and an Object Height of 1.3 m

in conjunction with the design speed. It assumes that the driver can safely complete the pass if an oncoming vehicle appears at the end of Phase 1 ($d_1 + d_2/3$) in Figure 1.2.5.1. The second methodology (marking) is based on the Manual of Uniform Traffic Control Devices (MUTCD) for Canada³⁵ using an Eye Height and an Object Height of 1.15 m in conjunction with the higher of the operating (85th percentile) or posted speed and assumes that the driver can safely abort the passing maneuver if an oncoming vehicle appears at the end of Phase 1 ($d_1 + d_2/3$) in Figure 1.2.5.1. The MUTCD for Canada (marking) methodology results in substantially shorter passing sight distances for all speeds.³⁶

Table 1.2.5.5 Minimum Passing Sight Distance²¹ – AASHTO (design) Methodology

Design Speed (km/h)	Assumed Speeds (km/h)		Minimum Passing Sight Distance (m) (rounded)
	Passed Vehicle	Passing Vehicle	
30	29	44	220
40	36	51	290
50	44	59	350
60	51	66	410
70	59	74	490
80	65	80	550
90	73	88	610
100	79	94	680
110	85	100	730
120	91	106	800
130	97	112	860

The minimum passing sight distance equals the addition of d_1 through d_4 in Figure 1.2.5.1. Table 1.2.5.5 summarizes the minimum passing sight distances for the AASHTO (design) methodology, which utilizes design speed. Table 1.2.5.6 summarizes the minimum passing sight distances for the MUTCD for Canada (marking) methodology, which utilizes the higher of the operating or the posted speed. These distances are based on the models for a passenger car passing a passenger car. Designers should make allowances if there are a number of larger vehicles (e.g. LCVs) on the roadway.

The minimum passing sight distances based on the AASHTO (design) methodology were derived

Figure 1.2.5.2 Required Passing Sight Distance for Passenger Cars & Trucks⁵ in Comparison with AASHTO Criteria

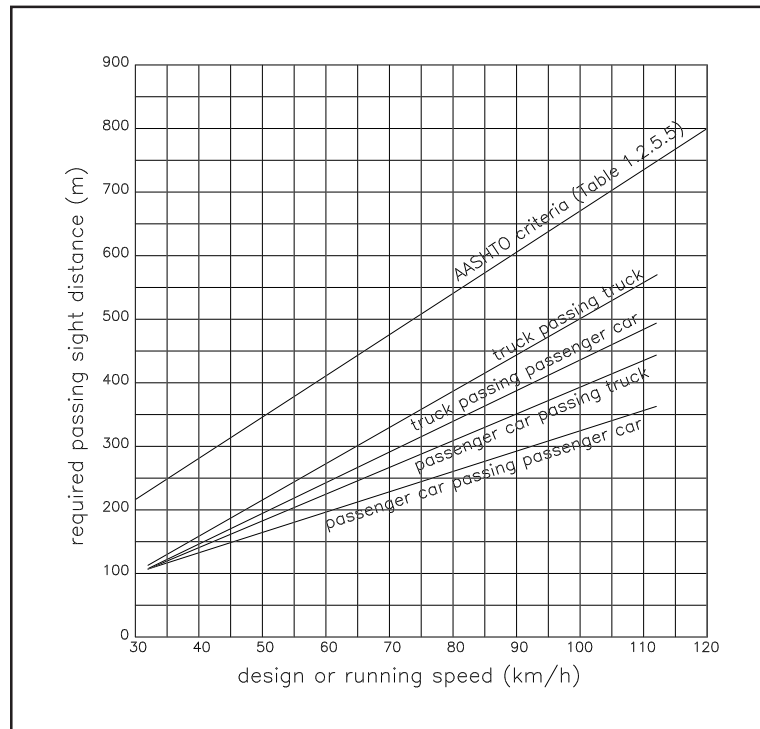


Table 1.2.5.6 Minimum Passing Sight Distance⁽³⁵⁾ – Manual of Uniform Traffic Control Devices for Canada (marking) Methodology

Higher of Operating or Posted Speed (km/h)	Minimum Passing Sight Distance (m) (rounded)
50	160
60	200
70	240
80	275
90	330
100	400
110	475
120	565

from field studies carried out between 1938 and 1941²¹. The derivation of the MUTCD (marking) methodology values is uncertain, but is believed to be based on the 1940 AASHTO policy on no-passing zones. This policy represents a subjective compromise between distances computed for flying passes and for delayed passes. As such, it does not represent any particular passing situation³⁷. Subsequent studies^{4,37} have shown the AASHTO values to be generally conservative for modern drivers and vehicles, but AASHTO has not reduced its minimum passing sight distances.

It has been suggested⁵ that required passing sight distance is successively longer for a passenger car passing a passenger car, a passenger car passing a truck, a truck passing a passenger car and a truck passing a truck, but that all of these required distances are less than those given as “minimums” by AASHTO (Table 1.2.5.5). A comparison of these requirements is shown on Figure 1.2.5.2, which reproduces results of modelling research⁵. In

presenting these results, the authors commented that:

“neither (their) models nor the current AASHTO.... models have any direct demonstrated relationship to the safety of passing manoeuvres on two-lane road. Such demonstrated safety relationships are needed before any change in passing..... criteria can be reasonably contemplated”.

In a review of research findings⁶, it was noted that collisions involving a passing manoeuvre amounted to only about 2% of all collisions on two-lane rural roads. However, the proportion of fatal and incapacitating collisions was found to be almost 6%. AASHTO findings⁴ suggest that significant numbers of drivers may avoid passing manoeuvres on two-lane roads, particularly where trucks are involved. However, drivers who refuse to pass another vehicle, even where adequate sight distance exists, may frustrate other, more confident drivers, who may then attempt unsafe passing manoeuvres.

To address the general lack of correlated data between collision occurrence and passing sight distance, the designer should seek opportunities to introduce passing lanes (see Chapter 2.1) on two-lane roads, particularly where the terrain limits sight distance. A report⁶ on a review and evaluation⁷ of research studies concluded that passing and climbing lane installations reduce collision rates by 25% compared to untreated two-lane sections. Such facilities also provide safer passing opportunities for drivers who are uncomfortable in using the opposing traffic lane and for those who are frustrated by them, particularly when few passing opportunities exist due to terrain or traffic volume.

1.2.5.4 Decision Sight Distance

Stopping sight distance allows alert, competent drivers to come to a quick stop under ordinary circumstances. This distance is usually

inadequate when drivers must make complex decisions, when information is difficult to find, when information is unusual or when unusual manoeuvres are required. Limiting the sight distance to the stopping sight distance may preclude drivers from performing unusual, evasive manoeuvres. Similarly, stopping sight distance may not provide drivers with enough visibility to allow them to piece together warning signals and then decide on a course of action. Because decision sight distance allows drivers to manoeuvre their vehicles or vary their operating speed rather than stop, decision sight distance is much greater than stopping sight distance for a given design speed.

Designers should use decision sight distance wherever information may be perceived incorrectly, decisions are required or where control actions are required. Some examples of where it could be desirable to provide decision sight distance are:

- complex interchanges and intersections
- locations where unusual or unexpected manoeuvres occur
- locations where significant changes to the roadway cross section are made
- areas where there are multiple demands on the driver's decision making capabilities from: road elements, traffic control devices, advertising, traffic, etc.
- construction zones

Table 1.2.5.7 shows the range of values for decision sight distance. The decision sight distance increases with the complexity of the evasive action that is taken by the driver and with the complexity of the surroundings.

The values for decision sight distance given in Table 1.2.5.7 have been developed from empirical data. When using these sight distances, the designer should consider eye and object heights appropriate for specific applications.

Table 1.2.5.7 Decision Sight Distance⁴

Design Speed (km/h)	Decision Sight Distance for Avoidance Manoeuvre (m)				
	A	B	C	D	E
50	75	160	145	160	200
60	95	205	175	205	235
70	125	250	200	240	275
80	155	300	230	275	315
90	185	360	275	320	360
100	225	415	315	365	405
110	265	455	335	390	435
120+	305	505	375	415	470

Notes: Avoidance Manoeuvre A: stop on rural roadway.
 Avoidance Manoeuvre B: stop on urban roadway.
 Avoidance Manoeuvre C: speed/path/direction change on rural roadway.
 Avoidance Manoeuvre D: speed/path/direction change on suburban roadway.
 Avoidance Manoeuvre E: speed/path/direction change on urban roadway.

REFERENCES

1. Hall, J.W. and Turner, D.S. Stopping Sight Distance: Can We See Where We Now Stand? in Transportation Research Record 1208, TRB, National Research Council, Washington, D.C., 1989.
2. Woods, D.L. Sensitivity Analysis of the Factors Affecting Roadway Vertical Curve Design. Presented at 68th Annual Meeting of TRB, January 1989.
3. Conceptions Routiers: Normes, Ouvrages, Routiers. Quebec Ministere des Transports, 1995.
4. A Policy on Geometric Design of Highways and Streets. AASHTO, Washington, D.C., 2001.
5. Harwood, D.W. and Glennon, J.C. Passing Sight Distance for Passenger Cars and Trucks, in Transportation Research Record 1208, TRB, National Research Council, Washington, D.C., 1989.
6. Sanderson, R.W. The Need for Cost-Effective Guidelines to Enhance Truck Safety. Presented to the Transportation Association of Canada Conference, 1996.
7. Passing Manoeuvres and Passing Lanes: Design, Operational & Safety Evaluations. ADI Limited for Transport Canada Safety Directorate, Ottawa, Ontario, 1989 (unpublished).
8. Harwood, D.W., Mason, J.M., Glauz, W.D., Kulakowski, B.T. and Fitzpatrick, K. Truck Characteristics for Use in Roadway Design and Operation. FHWA-RD-89-226 and 227, 1990.
9. Lamm, R., Choueiri, E.M., Hayward, J.C. and Paluri, A. Possible Design Procedure to Promote Design Consistency in Highway Geometric Design on Two-Lane Rural Roads, in Transportation Research Record 1195, TRB, National Research Council, Washington, D.C., 1988.
10. Lamm, R., Heger, R. and Eberhard, O. Operating Speed and Relation Design Backgrounds - Important Issues to be Regarded in Modern Highway Alignment Design, presented at the IRF World Meeting, Toronto, ON, 1997.
11. Alexander, G.J. and Lunenfeld, H., Driver Expectancy in Highway Design and Traffic Operations. Report No. FHWA-TO-86-1, Federal Highway Administration, US Department of Transportation, Washington, D.C., 1986.
12. Design Vehicle Dimensions for Use in Geometric Design, by Lea Associates for the Transportation Association of Canada, Ottawa, ON, 1996.
13. Fitzpatrick, K., Shamburger, B. and Fambro, D. Design Speed, Operating Speed and Posted Speed Survey, presented at Transportation Research Board meeting, Washington, D.C., 1996.
14. Krammes, R.A., Fitzpatrick, K., Blaschke, J.D. and Fambro, D. Speed - Understanding Design, Operating and Posted Speed. Report No. 1465-1, Texas Transportation Institute, 1996.
15. Garber, N.J. and Gadiraju, R. Factors Affecting Speed Variance and its Influence on Accidents, in Transportation Research Record 1213, TRB, National Research Council, Washington, D.C., 1989.
16. Gambard, J.M. and Louah, G. Vitesses Pratiques et Geometrie de la Route, SETRA, 1986.
17. Ogden, K.W. Safer Roads - A Guide to Road Safety Engineering, Ashgate Publishing Co., Brookfield, VT, 1996.
18. Olson, P. Forensic Aspects of Driver Perception and Response. Lawyers & Judges Publishing Company, Inc., Tucson, AZ, 1996.

19. Highway Capacity Manual. Special Report 209. Transportation Research Board, National Research Council, Washington, DC, 1994.
20. Krammes, R.A., Brackett, R.Q., Shafer, M.A., Ottesen, J.L., Anderson, I.B., Fink, K.L., Collins, K.M., Pendleton, O.J., Messer, C.J. Horizontal Alignment Design Consistency for Rural Two Lane Highways, FHWA-RD-94-034, 1993.
21. Prisk, C.W. Passing Practices on Rural Highways. Proceedings of the Highway Research Board, Vol. 21, 1941, in A Policy on Geometric Design of Highways and Streets. AASHTO, Washington, D.C., 1994.
22. Shelburne, T.E. and Sheppe, R.L. Skid Resistance Measurements of Virginia Pavements. Research Report No. 5-B. Highway Research Board, April 1948, in a Policy on Geometric Design of Highways and Streets. AASHTO, Washington, D.C., 1994.
23. Moyer, R.A. and Shupe, J.W. Roughness and Skid Resistance Measurements of Pavements in California. Bulletin 37. Highway Research Board, August 1951, in a Policy on Geometric Design of Highways and Streets. AASHTO, Washington, D.C., 1994.
24. Safety, Speed and Speed Management: A Canadian Review. IBI Group for Transport Canada, 1997.
25. Parker, M.R. Effects of Raising and Lowering Speed Limits on Selected Roadway Sections. FHWA-RD-92-084, Washington, D.C, 1997.
26. Synthesis of Safety Research Related to Speed and Speed Management. FHWARD-98-154, Washington, D.C., 1998.
27. Managing Speed: Review of Current Practice for Setting and Enforcing Speed Limits. Special Report 254, TRB, National Research Council, Washington, D.C., 1998.
28. Canadian Guide to 3R/4R. Transportation Association of Canada, Ottawa, 2001.
29. Highway Safety Design and Operations Guide. ASSHTO, Washington, D.C., 1997.
30. Context Sensitive Highway Design. ASCE, 1999.
31. Thinking Beyond the Pavement. AASHTO, 1998.
32. Flexibility in Highway Design. Federal Highway Administration. Washington, D.C., 1997.
33. Kassoff, H., Contextual Highway Design: Time to be Mainstreamed. ITE Journal, December 2001.
34. Beyond the Green Book. Transportation Research Board. Washington, D.C., 1987.
35. Manual of Uniform Traffic Control Devices for Canada. Transportation Association of Canada. February 2008.
36. Passing Sight Distance Design and Marking Study. Project No. T8080-04-0338. Intus Road Safety Engineering Inc. for Transport Canada, 2006.
37. National Cooperative Highway Program Report 605, "Passing Sight Distance Criteria", Transportation Research Board, Washington, D.C., 2008.

2.1 ALIGNMENT AND LANE CONFIGURATION

2.1.1	INTRODUCTION	2.1.1.1
2.1.2	HORIZONTAL ALIGNMENT	2.1.2.1
2.1.2.1	Overview	2.1.2.1
2.1.2.2	Circular Curves	2.1.2.2
2.1.2.3	Spiral Curves	2.1.2.20
2.1.2.4	Development of Superelevation	2.1.2.25
2.1.2.5	Lane Widening on Curves	2.1.2.29
2.1.2.6	Horizontal Alignment: Design Domain Additional Application Heuristics	2.1.2.36
2.1.2.7	Explicit Evaluation of Safety	2.1.2.44
2.1.3	VERTICAL ALIGNMENT	2.1.3.1
2.1.3.1	Overview	2.1.3.1
2.1.3.2	Grades	2.1.3.1
2.1.3.3	Vertical Curves	2.1.3.4
2.1.3.4	Sight Distance at Underpasses	2.1.3.9
2.1.3.5	Vertical Alignment: Design Domain Additional Application Heuristics	2.1.3.10
2.1.3.6	Explicit Evaluation of Safety	2.1.3.14
2.1.4	COORDINATION AND AESTHETICS	2.1.4.1
2.1.4.1	Introduction	2.1.4.1
2.1.4.2	Alignment Coordination: Technical Foundation	2.1.4.1
2.1.4.3	Alignment Coordination: Design Domain Application Heuristics	2.1.4.2
2.1.4.4	Alignment Coordination: Best Practices	2.1.4.3
2.1.5	CROSS-SLOPE	2.1.5.1
2.1.5.1	Introduction	2.1.5.1
2.1.5.2	Cross-Slopes and Traffic Operations: Application Heuristics	2.1.5.1
2.1.5.3	Cross-Slopes and Drainage	2.1.5.2
2.1.5.4	Cross-Slope Arrangements: Application Heuristics	2.1.5.3
2.1.5.5	Cross-Slope Changes: Application Heuristics	2.1.5.6
2.1.6	BASIC LANES AND LANE BALANCE	2.1.6.1
2.1.6.1	Basic Lanes	2.1.6.1
2.1.6.2	Lane Balance	2.1.6.2

2.1.6.3	Coordination of Lane Balance and Basic Lanes	2.1.6.2
2.1.6.4	Express Collector Systems: Best Practices	2.1.6.5
2.1.7	LANE AND ROUTE CONTINUITY AND WEAVING	2.1.7.1
2.1.7.1	Lane Continuity	2.1.7.1
2.1.7.2	Route Continuity	2.1.7.1
2.1.7.3	Weaving.....	2.1.7.4
2.1.8	TRUCK CLIMBING LANES	2.1.8.1
2.1.8.1	Introduction	2.1.8.1
2.1.8.2	Grades and Operations: Technical Foundation.....	2.1.8.1
2.1.8.3	Best Practices: Warrants	2.1.8.3
2.1.8.4	Application Heuristics	2.1.8.8
2.1.8.5	Explicit Evaluation of Safety	2.1.8.9
2.1.9	PASSING LANES	2.1.9.1
2.1.9.1	Introduction	2.1.9.1
2.1.9.2	Technical Foundation	2.1.9.1
2.1.9.3	Best Practices: Warrants	2.1.9.2
2.1.9.4	Application Heuristics	2.1.9.3
2.1.10	TRUCK ESCAPE RAMPS	2.1.10.1
2.1.10.1	Introduction	2.1.10.1
2.1.10.2	Best Practices: Warrants	2.1.10.3
2.1.10.3	Types: Best Practices	2.1.10.4
2.1.10.4	Location: Best Practices.....	2.1.10.5
2.1.10.5	Application Heuristics	2.1.10.6
2.1.10.6	Details of Bed: Design Elements.....	2.1.10.7
2.1.10.7	Signing, Delineation, Illumination, Maintenance	2.1.10.9
2.1.10.8	Explicit Evaluation of Safety	2.1.10.9
REFERENCES	2.1.R.1

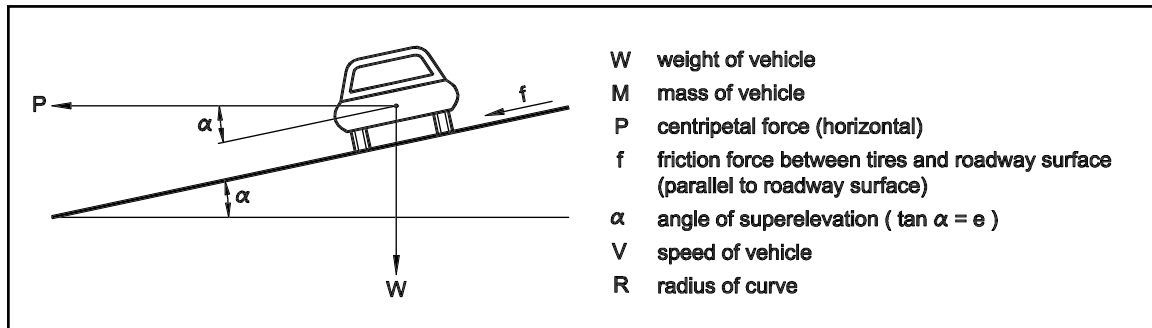
Tables

Table 2.1.2.1	Maximum Lateral Friction for Rural and High Speed Urban Design	2.1.2.7
Table 2.1.2.2	Maximum Lateral Friction for Low Speed Urban Design	2.1.2.7
Table 2.1.2.3	Minimum Radii for Limiting Values of e and f for Rural and High Speed Urban Roadways	2.1.2.8
Table 2.1.2.4	Minimum Radii For Urban Designs	2.1.2.9
Table 2.1.2.5	Superelevation and Minimum Spiral Parameters, $e_{\max} = 0.04$ m/m	2.1.2.12
Table 2.1.2.6	Superelevation and Minimum Spiral Parameters, $e_{\max} = 0.06$ m/m	2.1.2.13
Table 2.1.2.7	Superelevation and Minimum Spiral Parameters, $e_{\max} = 0.08$ m/m	2.1.2.14
Table 2.1.2.8	Superelevation Rate for Urban Design, $e_{\max} = 0.04$ m/m	2.1.2.18
Table 2.1.2.9	Superelevation Rate for Urban Design, $e_{\max} = 0.06$ m/m	2.1.2.19
Table 2.1.2.10	Calculated Stopping Sight Distance on Minimum Radius Curves	2.1.2.20
Table 2.1.2.11	Maximum Relative Slope Between Outer Edge of Pavement and Centreline of Two-Lane Roadways	2.1.2.23
Table 2.1.2.12	Length of Superelevation Runoff for Two-Lane Crowned Urban Roadways	2.1.2.26
Table 2.1.2.13	Length of Superelevation Runoff for Four-Lane, Undivided Crowned Urban Roadways, or Two-Lane Urban Roadways Without Crown	2.1.2.26
Table 2.1.2.14	Pavement Widening Values on Curves for Heavy SU Truck	2.1.2.33
Table 2.1.2.15	Pavement Widening Values on Curves for WB-20	2.1.2.33
Table 2.1.2.16	Pavement Widening Values on Curves for B-Train	2.1.2.34
Table 2.1.2.17	Required Lateral Clearance on Minimum Radius Curves	2.1.2.43
Table 2.1.3.1	Maximum Gradients	2.1.3.2
Table 2.1.3.2	K Factors to Provide Stopping Sight Distance on Crest Vertical Curves	2.1.3.6
Table 2.1.3.3	K Factors to Provide Passing Sight Distance on Crest Vertical Curves	2.1.3.7
Table 2.1.3.4	K Factors to Provide Minimum Stopping Sight Distance on Sag Vertical Curves	2.1.3.9
Table 2.1.5.1	Pavement Cross-Slope for Resurfacing	2.1.5.5
Table 2.1.5.2	Maximum Relative Slope Between Outer Edge of Pavement and Centreline of Two-Lane Roadway	2.1.5.6
Table 2.1.5.3	Design Values for Rate of Change of Cross-Slope for Single-Lane Turning Roads	2.1.5.6
Table 2.1.8.1	Lengths of Grade for 15 km/h Speed Reduction	2.1.8.7
Table 2.1.9.1	Typical Passing Lane Spacing	2.1.9.4
Table 2.1.10.1	Values for Rolling Resistance	2.1.10.2

Figures

Figure 2.1.2.1	Dynamics of Vehicle on Circular Curve	2.1.2.3
Figure 2.1.2.2	Overturning Moment on Circular Curve	2.1.2.5
Figure 2.1.2.3	Distribution of Superelevation and Lateral Friction	2.1.2.10
Figure 2.1.2.4	Relationship of Speed, Radius and Superelevation for Low Speed (<70 km/h) Urban Design	2.1.2.15
Figure 2.1.2.5	Alternative Method for Distribution of Superelevation and Lateral Friction	2.1.2.16
Figure 2.1.2.6	Friction Forces in Braking on Horizontal Curves	2.1.2.17
Figure 2.1.2.7	Basis for Spiral Parameter Design Values	2.1.2.22
Figure 2.1.2.8	Three Methods of Superelevation Development on Two-Lane Crowned Roadways	2.1.2.28
Figure 2.1.2.9	Three Methods of Superelevation Development on Divided Roadways	2.1.2.30
Figure 2.1.2.10	Relationship of Off-Tracking Components and Associated Formulae	2.1.2.32
Figure 2.1.2.11	Lateral Clearance for Range of Upper Values of Stopping Sight Distance	2.1.2.40
Figure 2.1.2.12	Lateral Clearance for Range of Lower Values of Stopping Sight Distance	2.1.2.41
Figure 2.1.2.13	Lateral Clearance for Passing Sight Distance	2.1.2.42
Figure 2.1.3.1	Sight Distance on Crest Vertical Curve	2.1.3.5
Figure 2.1.3.2	Stopping Sight Distance on Sag Vertical Curve	2.1.3.8
Figure 2.1.3.3	Sight Distance at Underpass	2.1.3.9
Figure 2.1.3.4	Airway Clearance	2.1.3.15
Figure 2.1.4.1	Examples of Good and Poor Alignment Coordination and Aesthetics	2.1.4.4
Figure 2.1.4.2	Examples of Good and Poor Alignment Coordination and Aesthetics	2.1.4.5
Figure 2.1.4.3	Examples of Good and Poor Alignment Coordination and Aesthetics	2.1.4.6
Figure 2.1.4.4	Examples of Good and Poor Alignment Coordination and Aesthetics	2.1.4.7
Figure 2.1.4.5	Examples of Good and Poor Alignment Coordination and Aesthetics	2.1.4.8
Figure 2.1.4.6	Examples of Good and Poor Alignment Coordination and Aesthetics	2.1.4.9
Figure 2.1.4.7	Examples of Good and Poor Alignment Coordination and Aesthetics	2.1.4.10
Figure 2.1.4.8	Examples of Good and Poor Alignment Coordination and Aesthetics	2.1.4.11
Figure 2.1.4.9	Examples of Good and Poor Alignment Coordination and Aesthetics	2.1.4.12
Figure 2.1.4.10	Examples of Good and Poor Alignment Coordination and Aesthetics	2.1.4.13

Figure 2.1.4.11	Examples of Good and Poor Alignment Coordination and Aesthetics	2.1.4.14
Figure 2.1.4.12	Examples of Good and Poor Alignment Coordination and Aesthetics	2.1.4.15
Figure 2.1.5.1	False Grading and Cross-Slopes	2.1.5.3
Figure 2.1.5.2	Application of Cross-Slope on Various Types of Roads	2.1.5.4
Figure 2.1.5.3	Maximum Algebraic Difference in Pavement Cross-Slope of Adjacent Traffic Lanes	2.1.5.7
Figure 2.1.6.1	Schematic of Basic Number of Lanes	2.1.6.1
Figure 2.1.6.2	Typical Examples of Lane Balance.....	2.1.6.3
Figure 2.1.6.3	Coordination of Lane Balance and Basic Lanes	2.1.6.4
Figure 2.1.6.4	Typical Express Collector System	2.1.6.6
Figure 2.1.7.1	Illustration of Route Continuity	2.1.7.2
Figure 2.1.7.2	Examples of Lane Continuity	2.1.7.3
Figure 2.1.7.3	Types of Weaving Sections	2.1.7.5
Figure 2.1.7.4	Solutions for Undesirable Weaving	2.1.7.6
Figure 2.1.7.5	Method of Measuring Weaving Lengths	2.1.7.7
Figure 2.1.8.1	Collision Involvement Rate for Trucks	2.1.8.2
Figure 2.1.8.2	Performance Curves For Heavy Trucks, 120 g/W, Decelerations & Accelerations	2.1.8.4
Figure 2.1.8.3	Performance Curves for Heavy Trucks, 180 g/W, Decelerations & Accelerations	2.1.8.5
Figure 2.1.8.4	Performance Curves for Heavy Trucks, 200 g/W, Decelerations & Accelerations	2.1.8.6
Figure 2.1.8.5	Climbing Lanes Overlapping on Crest Curve	2.1.8.10
Figure 2.1.8.6	Climbing Lane Design Example	2.1.8.11
Figure 2.1.9.1	Typical Passing Lane Layout	2.1.9.2
Figure 2.1.9.2	Typical Traffic Simulation Output of Percent Following and Correlation with Level of Service	2.1.9.4
Figure 2.1.9.3	Alternative Configurations for Passing Lanes	2.1.9.5
Figure 2.1.10.1	Forces Acting on Vehicle in Motion.....	2.1.10.2
Figure 2.1.10.2	Basic Types of Designs of Truck Escape Ramps	2.1.10.4
Figure 2.1.10.3	Typical Layout of Truck Escape Ramp	2.1.10.8
Figure 2.1.10.4	Typical Cross Section of Truck Escape Ramp	2.1.10.8

Figure 2.1.2.1 Dynamics of Vehicle on Circular Curve¹


f = the lateral friction force factor between the vehicle tire and the roadway pavement. Note that this friction is lateral or side friction and is different from the longitudinal friction factor used to determine stopping distance

V = speed of vehicle (km/h)

R = radius of curve (m)

- frequency of slow-moving vehicles
- maintenance

Normal maximum values used in Canada are 0.04 m/m, 0.06 m/m and 0.08 m/m depending on environment and the degree of surface icing that is likely to occur. In rural areas, higher values of maximum superelevation may be used in more favourable conditions, whereas in areas where surface icing occurs, lower values should be applied.

In a condition where $f = 0$, the entire resistance to centrifugal force is provided by superelevation. This might occur on a large radius curve with slow moving vehicles under icy conditions. If e , V and R are such that the pavement and tires cannot supply enough lateral friction, the vehicle will lose stability and start to skid.

Maximum Superelevation: Design Domain

Overview

The maximum rate of superelevation that can be applied in road design is controlled by a number of factors:

- climatic conditions (frequency of snow and icing)
- terrain (flat, rolling, or mountainous)
- type of environment (rural or urban)

Rural Areas: Design Domain Quantitative Aids

In rural areas a maximum superelevation rate of 0.06 m/m appears to be gaining more acceptance than a maximum superelevation of 0.08 m/m because:

1. Adoption of the 0.06 m/m maximum results in better horizontal alignment in cases where minimum radii are used. Use of the minimum radii based on 0.08 m/m maximum superelevation can result in sharp curves not consistent with driver expectations in a rural environment. Use of isolated sharp curves in a generally smooth rural alignment is not recommended.
2. Use of the 0.06 m/m maximum superelevation table is expected to improve operational characteristics for vehicles travelling at lower speeds during adverse

weather conditions, or for other reasons, while not adversely affecting higher speed vehicles. This is especially important for roads located where winter conditions prevail several months of the year.

3. The minimum horizontal radius should be compensated on steep downgrades to enhance road safety. On steep downgrades the minimum curve radius should be increased by 10% for each 1% increase in grade over 3%.

$$R (\text{min on grade})^* = R (\text{min}) (1 + (G-3)/10)$$

Where:

R (min) = values in Tables 2.1.2.5, 2.1.2.6, 2.1.2.7

G = grade (%)

R = radius (m)

Example: Design Speed = 100 km/h;
e=0.06; G=6%

e = pavement superelevation (m/m)

R (min) = 440 m (Table 2.1.2.6)

R (min)* = $440(1+(6-3)/10) = 572 \text{ m}$ or
570 m (rounded for design)

Urban Areas: Design Domain Quantitative Aids

In urban areas maximum superelevation values cover the range from 0.02 m/m to 0.08 m/m. Values commonly used for maximum superelevation are:

1. Locals - generally normal crown.
2. Collectors - used occasionally with maximum rates of 0.02 m/m or 0.04 m/m.
3. Minor arterials - 0.04 m/m to 0.06 m/m.
4. Major arterials - 0.06 m/m.
5. Expressways and freeways - 0.06 m/m to 0.08 m/m.
6. Interchange ramps - 0.06 m/m to 0.08 m/m.

Urban Areas: Design Domain Application Heuristics

1. In urban areas maximum superelevation values tend to be lower since vehicles travelling at slow speeds or moving away from a stopped position might experience side-slip on higher superelevation. Maximum superelevation in urban areas is typically 0.06 m/m.
2. A maximum superelevation rate of 0.04 m/m may also be used for an urban roadway system, and is appropriate where surface icing and interrupted flow is expected.
3. The maximum superelevation rates of 0.04 m/m and 0.06 m/m are generally applicable for design of new roads in the upper range of the classification system and where little or no physical constraints exist.
4. Superelevation is generally not applied on local roads.
5. On collector roads superelevation is used occasionally, and typically where beneficial in matching adjacent topography. Maximum superelevation rates in these cases are in the range of 0.02 m/m (reverse crown) to 0.04 m/m.
6. In some jurisdictions, higher superelevation values are used for ramps on urban freeways than on other urban roads to provide additional safety since freeway ramps, particularly off-ramps, tend to be over-driven more often and side-slip is less likely to occur since maintenance is better at these locations.
7. Superelevation rates in excess of 0.04 m/m are not recommended where curved alignments pass through existing or possible future intersection areas. In urban retrofit situations, it is often difficult or undesirable to provide any superelevation at all due to physical constraints. In these cases, the designer has to carefully assess the relationships of design speed, curvature, crossfall and lateral friction in choosing the optimum design solution.

8. Acceptable maximum superelevation rates are often established as a matter of policy and vary between jurisdictions based on local conditions. As an example, some jurisdictions use a maximum super-elevation rate of 0.08 m/m for higher classification roads such as expressways. In the interests of maintaining consistency in design in any particular area where the responsibility for roads is divided between jurisdictions, it is desirable to maintain consistent maximum superelevation. In selecting maximum superelevation, therefore, reference should be made to values used by other road authorities in the area.

Lateral Friction: Technical Foundation Element

The lateral friction factor f is the ratio of the lateral friction force and the component of the weight of the vehicle perpendicular to the pavement. This force is applied to the vehicle at the tires and is toward the centre of the curve producing radial acceleration. Figure 2.1.2.1 illustrates lateral friction.

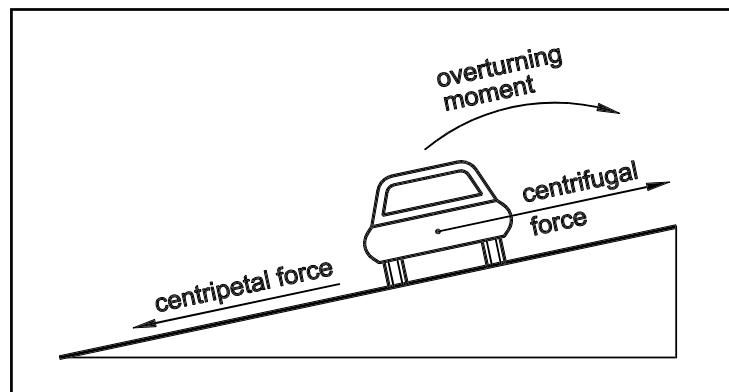
The upper limit of the friction factor is that at which skidding is about to occur. Because roadway curves are designed to avoid skidding conditions with a margin of safety, the lateral friction factors for design should be substantially less than the coefficient of friction of impending skid. This is because on a given curve some vehicles travelling at speeds in excess of design speed can be expected and some vehicles changing lanes and overtaking will be following a path of smaller radius than the control line.

The friction factor at which skidding is imminent depends on a number of factors, among which the most important are the speed of the vehicle, the type and condition of the roadway surface, and the type and condition of the tires. Different observers have recorded different maximum rates at the same speeds for similar composition pavements, and logically so, because of the inherent differences in pavement texture, weather conditions and tire condition. Wet or icy pavements will provide less friction than dry ones and the presence of oil, mud, tire rubber and grit will also reduce friction. General studies² show that the maximum lateral friction factors developed between new tires and wet concrete pavements range from about 0.5 at 30 km/h to approximately 0.35 at 100 km/h. For normal wet concrete pavement and smooth tires the value is about 0.35 at 70 km/h. In all cases the studies show a decrease in friction values for an increase in speed.

Curves are not designed on the basis of the maximum available lateral friction factor. The proportion of the lateral friction factor that is used with comfort and safety by the vast majority of drivers is the maximum value for design. Values that relate to pavements that are glazed, bleeding, or otherwise lacking in reasonable skid-resistant properties should not control design, because these conditions are avoidable and geometric design is based on acceptable surface conditions attainable at reasonable cost.

The centripetal force acting toward the centre of the circle at the roadway surface generates an equal centrifugal force acting on the vehicle at

Figure 2.1.2.2 Overturning Moment on Circular Curve¹



the centre of gravity outwards from the centre of the circle, illustrated in Figure 2.1.2.2. These two equal and opposite forces produce a moment which tends to overturn the vehicle.

In selecting maximum allowable lateral friction factors for design, one criterion is the point at which the overturning is sufficient to cause the driver to experience a feeling of discomfort and cause him to react instinctively to avoid higher speed. This happens at higher speeds when the centripetal force required to maintain the vehicle on the curve is supplied largely by lateral friction rather than superelevation and the driver experiences discomfort. The speed on a curve, at which discomfort due to the overturning moment is evident to the driver, can be accepted as a design control for the maximum allowable amount of side friction. At lower, non-uniform running speeds, which are typical in urban areas, drivers are more tolerant of discomfort, thus allowing an increased amount of lateral friction for use in design of horizontal curves.

The ball-bank indicator has in the past been widely used by research groups, local agencies and highway departments as a uniform measure for the point of discomfort to set safe speeds on curves. It consists of a steel ball in a sealed glass tube. The ball is free to roll except for the damping effect of the liquid in the tube. Its simplicity of construction and operation has led to widespread acceptance as a guide for determination of safe speeds. With such a device mounted in a vehicle in motion, the ball-bank reading at any time is indicative of the combined effect of the body roll angle, the centrifugal force angle, and the superelevation angle.

The centrifugal force developed as a vehicle travels at uniform speed on a curve causes the ball to roll out to a fixed angle position. A correction must be made for that portion of the force taken up in the small body roll angle.

In a series of tests³⁶ it was concluded that safe speeds on curves were indicated by ball-bank readings of 14° for speeds of 30 km/h or less, 12° for speeds of 40 km/h to 50 km/h and 10° for speeds of 55 km/h to 80 km/h. These ball-bank readings are indicative of lateral friction factors of 0.21, 0.18 and 0.15 respectively, for the test body roll angles and provide ample margin of safety against skidding.

From other tests², a maximum lateral friction factor of 0.16 for speeds up to 100 km/h was recommended. For higher speeds this factor was to be reduced on an incremental basis. Speed studies² on the Pennsylvania Turnpike led to a conclusion that the side friction factor should not exceed 0.10 for design speeds of 110 km/h and higher.

Recent research³⁵ suggests that the above-noted ball-bank readings should be increased to reflect current vehicle dynamics and improvements in tire technology. Ball-bank readings of 20° for speeds below 50 km/h, 16° for speeds of 50 to 65 km/h and 12° for speeds over 65 km/h would better reflect average curve speeds. It should be recognized that other factors affect and act to control driver speed at conditions of high friction demand. Swerving becomes perceptible, drift angle increases, and increased steering effort is required to avoid involuntary lane line violation. Under these conditions the cone of vision narrows and is accompanied by an increasing sense of concentration and intensity considered undesirable by most drivers. These factors are more apparent to a driver under open road conditions.

Where practical, the maximum friction factor values selected should be conservative for dry pavements and provide a margin of safety for operating on pavements that are wet. The need for providing skid-resistant pavement surfacing for these conditions cannot be over-emphasized because superimposed on the frictional demands dictated by roadway geometry are those often made by driving manoeuvres such as braking, sudden lane changes, and minor changes in direction within the lane. In these short term manoeuvres the discomfort threshold is not penetrated immediately and, consequently, high friction demand can exist but not be perceived in time for compensation by a comfortable speed reduction.

Lateral Friction: Design Domain Quantitative Aids¹

Lateral friction values adopted for rural and high speed urban design are given in Table 2.1.2.1.

It is generally recognized that on low speed (30 to 60 km/h) urban roads, drivers have developed a higher threshold of discomfort through

Table 2.1.2.1 Maximum Lateral Friction for Rural and High Speed Urban Design¹

Design Speed (km/h)	Maximum Lateral Friction for Rural and High Speed Urban Design
40	0.17
50	0.16
60	0.15
70	0.15
80	0.14
90	0.13
100	0.12
110	0.10
120	0.09
130	0.08

conditioning, and are willing to accept more lateral friction than in rural or high speed (≥ 70 km/h) urban conditions. The centripetal force producing radial acceleration is supplied largely by lateral friction and the values adopted for design of low speed urban streets are higher than those for rural and high speed urban conditions. They are based on a tolerable degree of discomfort and provide a reasonable margin of safety against skidding under normal driving conditions in the urban environments. Values are presented in Table 2.1.2.2.

Minimum Radius: Design Domain

Overview

The minimum allowable radius for any design speed depends on the maximum rate of superelevation and the lateral friction force that

can be developed between the pavement and vehicle tires. This relationship is expressed by:

$$R_{\min} = \frac{V^2}{127(e_{\max} + f_{\max})} \quad (2.1.2)$$

For rural and urban high speed superelevation applications there is generally reasonable opportunity to provide the desirable amount of superelevation. In rural areas the constraints are usually minimal, while on high speed urban roadways the designer has reasonable flexibility in establishing suitable superelevation. This is because in the design of new streets, particularly those with design speeds of 70 km/h or more and through generally undeveloped areas, the designer typically has greater flexibility in establishing suitable horizontal and vertical alignments and associated superelevation rates. Often it is possible to regrade adjacent properties to match superelevated sections, ensuring appropriate drainage patterns and intersection profiles.

Rural and High Speed Urban Applications: Design Domain Quantitative Aids

For rural and high speed urban applications the minimum radius is calculated using a maximum superelevation rate of either 0.04 m/m, 0.06 m/m or 0.08 m/m for a range of design speeds from 40 km/h to 130 km/h, and lateral friction factors from Table 2.1.2.1. These calculated values are shown in Table 2.1.2.3.

Low Speed Urban Applications: Design Domain Quantitative Aids

For low speed urban conditions and where a street is to be upgraded through a developed urban area, it is often not desirable or possible to utilize superelevation rates typical of high speed design as previously discussed. Design considerations other than driver discomfort may be important. Existing physical controls, right-of-way constraints, intersections, driveways, on-street parking, and economic considerations have a strong influence on design elements, including design speed and superelevation. In some cases, design speed may not be an initial design control, but rather a result of the other

Table 2.1.2.2 Maximum Lateral Friction for Low Speed Urban Design¹

Design Speed (km/h)	Maximum Lateral Friction for Low Speed Urban Design
30	0.31
40	0.25
50	0.21
60	0.18

Table 2.1.2.3 Minimum Radii for Limiting Values of e and f for Rural and High Speed Urban Roadways¹

Design Speed (km/h)	e_{max} (m/m)	Design Value for f	$e + f$	Minimum Radius (m) (calculated)	Minimum Radius for Design (m)
40	0.04	0.17	0.21	60	60
50	0.04	0.16	0.20	98	100
60	0.04	0.15	0.19	149	150
70	0.04	0.15	0.19	203	200
80	0.04	0.14	0.18	280	280
90	0.04	0.13	0.17	375	380
100	0.04	0.12	0.16	492	490
40	0.06	0.17	0.23	55	55
50	0.06	0.16	0.22	89	90
60	0.06	0.15	0.21	135	130
70	0.06	0.15	0.21	184	190
80	0.06	0.14	0.20	252	250
90	0.06	0.13	0.19	336	340
100	0.06	0.12	0.18	437	440
110	0.06	0.10	0.16	595	600
120	0.06	0.09	0.15	756	750
130	0.06	0.08	0.14	951	950
40	0.08	0.17	0.25	50	50
50	0.08	0.16	0.24	82	80
60	0.08	0.15	0.23	123	120
70	0.08	0.15	0.23	168	170
80	0.08	0.14	0.22	229	230
90	0.08	0.13	0.21	304	300
100	0.08	0.12	0.20	394	390
110	0.08	0.10	0.18	529	530
120	0.08	0.09	0.17	667	670
130	0.08	0.08	0.16	832	830

controls or considerations influencing the horizontal alignment and superelevation.

Moreover, in low speed urban conditions, drivers are accustomed to a greater level of discomfort while traversing curves. Hence, increased lateral friction factors resulting from lower superelevation rates or no superelevation at all, are permissible. In these cases, the maximum lateral friction factors as defined by Table 2.1.2.2 are used in calculating minimum radii.

To allow for the fact that in low speed urban designs various limits for maximum permissible superelevation may exist, the minimum radius is provided for a number of commonly used rates of superelevation.

Table 2.1.2.4 provides rounded design values for minimum radii for low speed urban design,

30 km/h to 60 km/h, normally representative of retrofit conditions. Minimum radii are stated for normal crown (-0.02 m/m, or adverse superelevation), reverse crown (0.02 m/m superelevation) and maximum superelevation rates of 0.04 and 0.06 m/m. Table 2.1.2.4 also provides a summary of the minimum radii for a range of high design speeds, 70 km/h to 100 km/h, associated with maximum superelevation values of 0.04 m/m and 0.06 m/m. The values are the same as the high speed urban values in Table 2.1.2.3.

Distribution of “e” and “f” Over a Range of Curves: Design Domain

Overview

There are a number of methods of distributing e and f over a range of curves flatter than the

Table 2.1.2.4 Minimum Radii for Urban Designs⁹

Design Speed (km/h)	Minimum Radius (m)					
	Crown Section				Superelevated Section	
	Normal ⁴ (-0.02 m/m)	Reverse ^{3,4} (+0.02 m/m)		Maximum Rate		
		$e_{max} + 0.04$	$e_{max} + 0.06$	+0.04 (m/m)	+0.06 (m/m)	
Low Speed ¹	30	420	30	40	20	20
	40	660	65	80	45	40
	50	950	115	135	80	75
	60	1290	185	220	130	120
High Speed ²	70	1680	290	330	200	190
	80	2130	400	450	280	250
	90	2620	530	600	380	340
	100	3180	690	770	490	440

- Notes:
1. Values for design speeds 30 to 60 km/h based on low speed design and maximum lateral friction coefficients in Table 2.1.2.2.
 2. Values for design speeds 70 to 100 km/h based on high speed design and maximum lateral friction coefficients in Table 2.1.2.1.
 3. Lateral friction coefficients distributed proportional to the inverse of radius, resulting in different minimum radius values at reverse crown for $e_{max} + 0.04$ and $e_{max} + 0.06$. The methodology of distributing "e" and "f" is described in more detail in the following section.
 4. To determine the minimum radius for normal and reverse crown, the (e+f) value must be obtained from the alternative method as discussed under Urban Roadways: Design Domain Quantitative Aids and illustrated in Figure 2.1.2.5.

minimum radius for a given design speed. The various methods are well documented in AASHTO². The choice of methods are the result of the latitude available to the designer in the distribution of superelevation (e) and lateral friction (f).

Rural & High Speed Urban Applications: Design Domain Technical Foundation

For rural and high speed urban roadways the method used for distributing e and f is referred to as "Method 5" in the AASHTO² publication. The form of distribution is based on the relationship shown in solid in Figure 2.1.2.3. As the radius decreases from 450 m to 80 m, the superelevation increases rapidly in the high radius vicinity to almost maximum superelevation in the middle range and less rapidly in the lower radius vicinity. Conversely the lateral friction factor increases slowly in the higher radius range and more rapidly in the smaller radius range. This reflects the relationship:

$$e + f = \frac{V^2}{127R} \quad (2.1.3)$$

in which for a given design speed, V is constant. For example, in Figure 2.1.2.3, for V = 50 km/h the expression becomes:

$$e + f = \frac{19.69}{R} \quad (2.1.4)$$

The distribution of e and f described above favours the overdriving characteristics that occur on flat to intermediate curves. Overdriving on such curves is ameliorated because superelevation provides nearly all centripetal force required if the vehicle is travelling at average running speed and considerable lateral friction is available for higher speeds. The distribution shown in Figure 2.1.2.3 represents a practical distribution over the range of radii.

An alternative distribution in which superelevation is not applied in the higher radius range is shown with a dashed line in Figure 2.1.2.3. Superelevation of 0.02 m/m is maintained until all available lateral friction is

Figure 2.1.2.3 Distribution of Superelevation and Lateral Friction¹

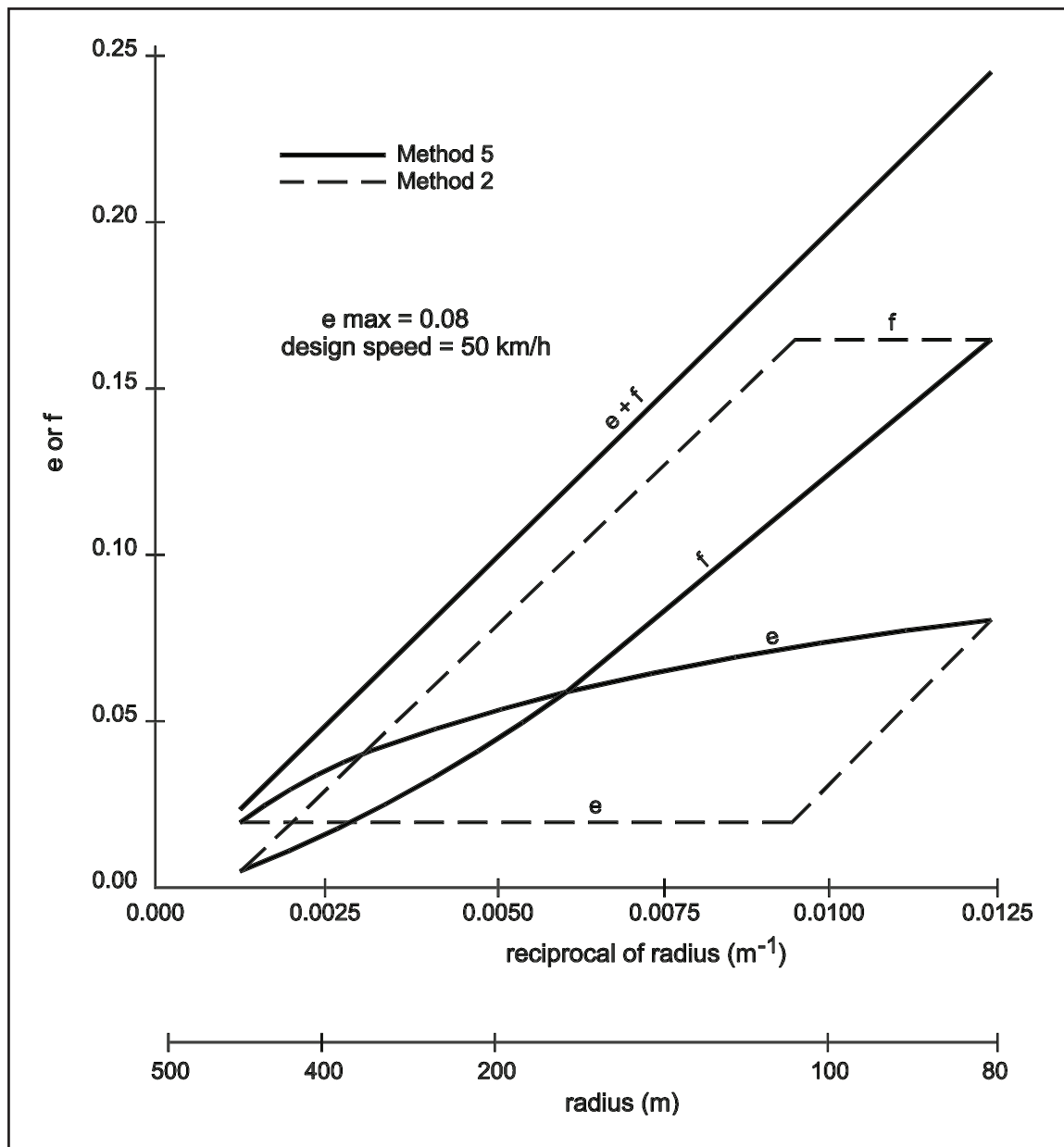


Figure 2.1.2.4 Relationship of Speed, Radius and Superelevation for Low Speed (<70 km/h) Urban Design¹

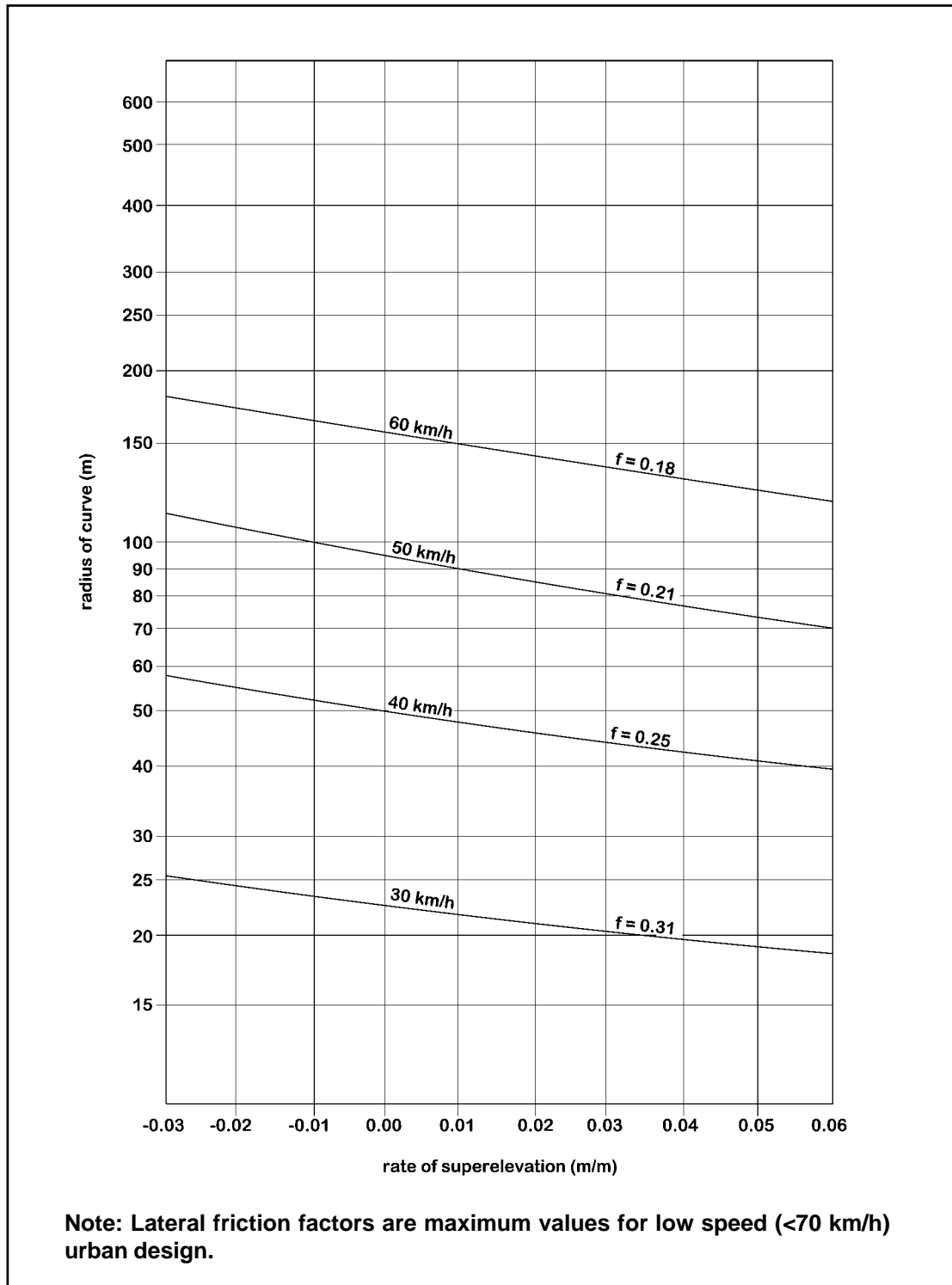


Figure 2.1.2.5 Alternative Method for Distribution of Superelevation and Lateral Friction⁹

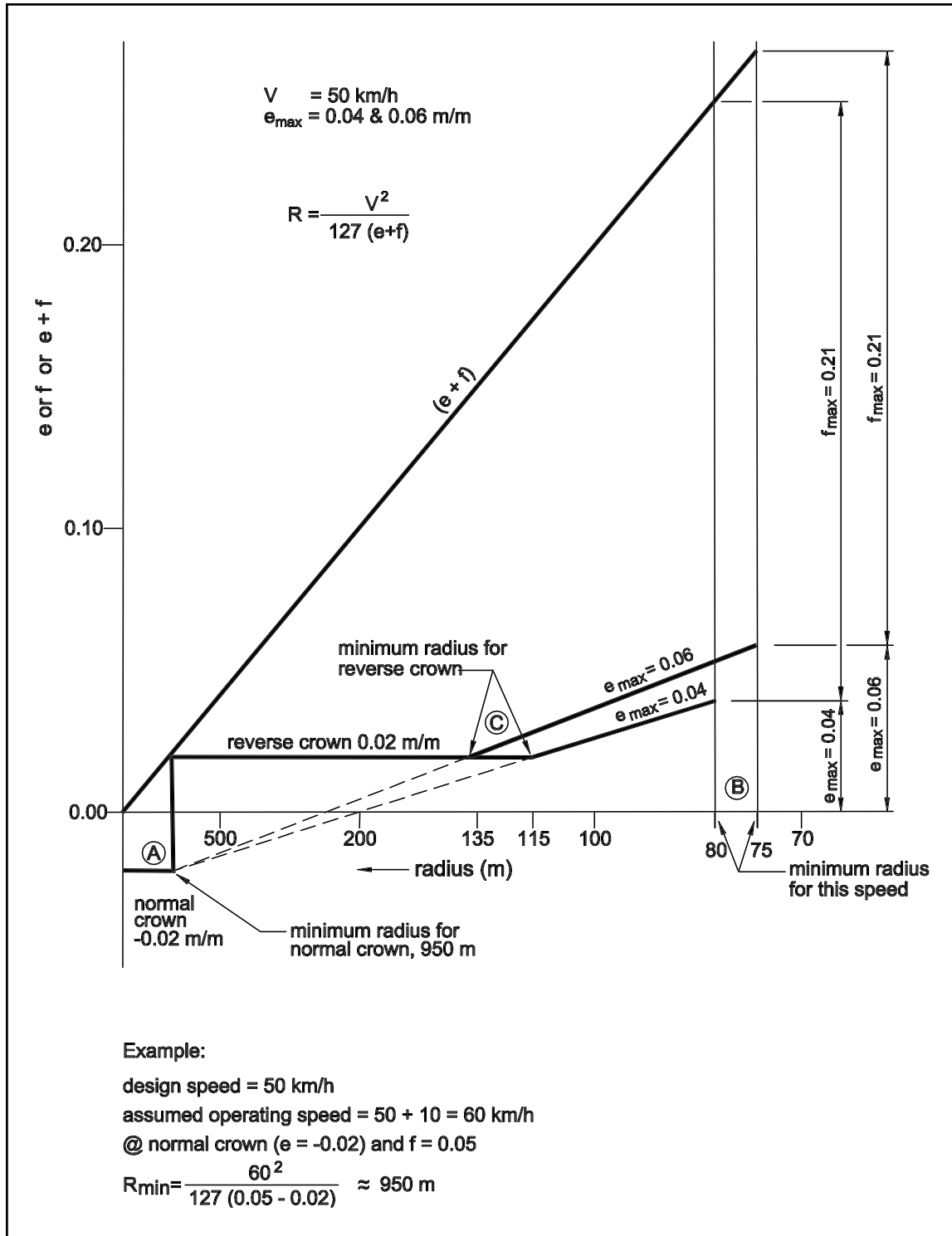


Table 2.1.3.4 K Factors to Provide Minimum Stopping Sight Distance on Sag Vertical Curves¹

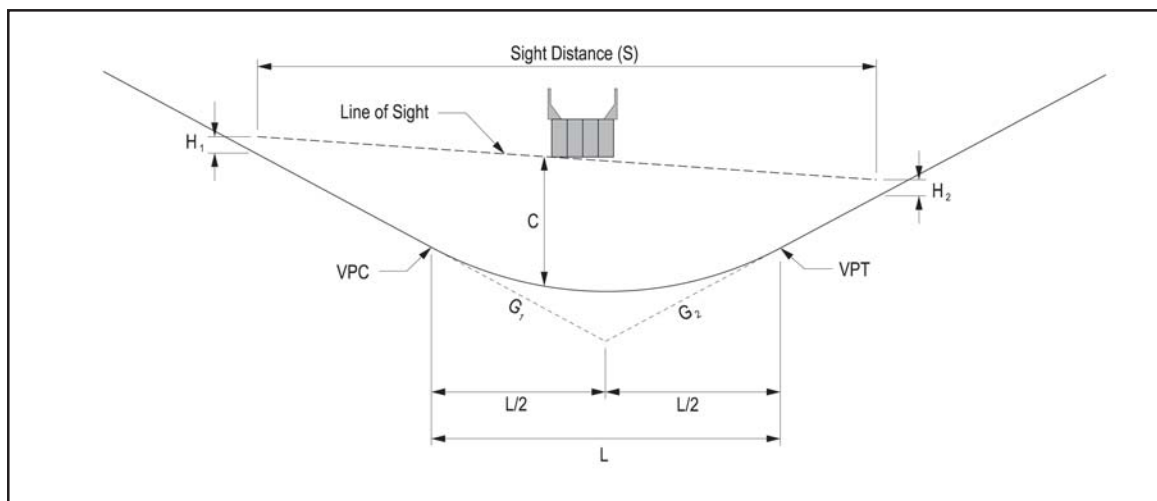
Design Speed (km/h)	Assumed Operating Speed (km/h)	Stopping Sight Distance (m)	Rate of Sag Vertical Curvature (K)			
			Headlight Control		Comfort Control	
			Calculated	Rounded	Calculated	Rounded
30	30	29.6	3.9	4	2.3	2
40	40	44.4	7.1	7	4.1	4
50	47-50	57.4-62.8	10.2-11.5	11-12	5.6-6.3	5-6
60	55-60	74.3-84.6	14.5-17.1	15-18	7.7-9.1	8-9
70	63-70	99.1-110.8	19.6-24.1	20-25	10.0-12.4	10-12
80	70-80	112.8-139.4	24.6-31.9	25-32	12.4-16.2	12-16
90	77-90	131.2-168.7	29.6-40.1	30-40	15.0-20.5	15-20
100	85-100	157.0-205.0	36.7-50.1	37-50	18.3-25.3	18-25
110	91-110	179.5-246.4	43.0-61.7	43-62	21.0-30.6	21-30
120	98-120	202.9-285.6	49.5-72.7	50-73	24.3-36.4	24-36
130	105-130	227.9-327.9	56.7-85.0	57-85	27.9-42.8	28-43

Values for sag curvature based on the comfort criterion are shown in Table 2.1.3.4.

These K values for sag curves are useful in urban situations such as underpasses where it is often necessary for property and access reasons to depart from original ground elevations for as short a distance as possible. Minimum values are normally exceeded where feasible, in consideration of possible power failures and other malfunctions to the street lighting systems. Designing sag vertical curves along curved roadways for decision sight distance is normally not feasible due to the inherent flat grades and resultant surface drainage problems.

2.1.3.4 Sight Distance at Underpasses

While not a frequent design problem, the sight distance at underpasses may be restricted due to the overpass structure or signs hanging below the bottom of the overpass structure restricting the line of sight. The sight distance through a grade separation should be equal to or greater than the minimum stopping sight distance. Figure 2.1.3.3 illustrates the sight distance from an eye height of h_1 to an object height of h_2 with an underpass clearance of C . Case 1 is for a sight distance greater than the length of the vertical curve ($S > L$) and Case 2 is for a sight

Figure 2.1.3.3 Sight Distance at Underpass


distance less than the length of the vertical curve (S<L):

Case 1 (S>L)

$$L = 2S - 800 * [C - (h_1 + h_2) / 2] / A \quad (2.1.29)$$

Where:

- L = length of vertical curve, m;
- S = sight distance, m;
- A = algebraic difference in grades, percent;
- C = vertical clearance, m;
- h₁ = height of eye, m;
- h₂ = height of object, m;

Case 2 (S<L)

$$L = A * S^2 / [800 * (C - (h_1 + h_2) / 2)] \quad (2.1.30)$$

Where:

- L = length of vertical curve, m;
- S = sight distance, m;
- A = algebraic difference in grades, percent;
- C = vertical clearance, m;
- h₁ = height of eye, m;
- h₂ = height of object, m;

Using an eye height of 2.4 m for a truck driver and an object height of 0.38 m for the tail lights of a vehicle, the following equations can be derived:

Case 1 (S>L)

$$L = 2S - [800 * (C - 1.39)] / A \quad (2.1.31)$$

Case 2 (S<L)

$$L = A * S^2 / [800 * (C - 1.39)] \quad (2.1.32)$$

These formulas are applicable to the typical situation where the structure is located over the centre of the vertical curve. Where it is not, the formulas may underestimate the length of the available sight distance.³⁸

2.1.3.5 Vertical Alignment: Design Domain Additional Application Heuristics

Vertical Alignment Principles: Application Heuristics

The following principles generally apply to both rural and urban roads. A differentiation between rural and urban is made in several instances where necessary for clarity.

1. On rural and high speed urban roads a smooth grade line with gradual changes, consistent with the class of road and the character of the terrain, is preferable to an alignment with numerous breaks and short lengths of grade. On lower speed curbed urban roadways drainage design often controls the grade design.
2. Vertical curves applied to small changes of gradient require K values significantly greater than the minimum as shown in Tables 2.1.3.2 and 2.1.3.4. The minimum length in metres should desirably not be less than the design speed in kilometres per hour. For example, if the design speed is 100 km/h, the vertical curve length is at least 100 m.
3. Vertical alignment, having a series of successive relatively sharp crest and sag curves creating a “roller coaster” or “hidden dip” type of profile is not recommended. Hidden dips can be a safety concern, particularly at night. Such profiles generally occur on relatively straight horizontal alignment where the roadway profile closely follows a rolling natural ground line. Such roadways are unpleasant aesthetically and more difficult to drive. This type of profile is avoided by the use of horizontal curves or by more gradual grades.
4. A broken back grade line (two vertical curves in the same direction separated by a short section of tangent grade) is not desirable, particularly in sags where a full view of the profile is possible. This effect is very noticeable on divided roadways with open median sections.

5. Curves of different K values adjacent to each other (either in the same direction or opposite directions) with no tangent between them are acceptable provided the required sight distances are met.
6. An at-grade intersection occurring on a roadway with moderate to steep grades, should desirably have reduced gradient through the intersection, desirably less than 3%. Such a profile change is beneficial for vehicles making turns and stops, and serves to reduce potential hazards.
7. In sections with curbs the minimum longitudinal grade is 0.5%. Within superelevated transition areas, it might sometimes be virtually impossible to provide this minimum grade. In such cases, the longitudinal grade length below 0.5% should be kept as short as possible. Additional information on minimum grades and drainage is provided in Subsection 2.1.3.2.
8. A superelevation transition occurring on a vertical curve requires special attention in order to ensure that the required minimum curvature is maintained across the entire width of pavement. The lane edge profile on the opposite side of the roadway from the control line may have sharper curvature due to the change in superelevation rate required by the superelevation transition. It is, therefore, necessary to check both edge profiles and to adjust the desired minimum vertical curvature.
9. Undulating grade lines, with substantial lengths of down grade, require careful review of operations. Such profiles permit heavy trucks to operate at higher overall speeds than is possible when an upgrade is not preceded by a down grade. However, this could encourage excessive speed of trucks with attendant conflicts with other traffic.
10. On long grades it may be preferable to place steepest grade at the bottom and decrease the grades near the top of the ascent or to break the sustained grade by short intervals of flatter grade instead of a uniform sustained grade that might be only slightly below the allowable maximum. This is particularly applicable to low design speed roads and streets².
11. To ensure a smooth grade line on high speed routes a minimum spacing of 300 m between vertical points of intersection is desirable.
12. The design of vertical alignment should not be carried out in isolation but should have a proper relationship with the horizontal alignment. This is discussed in Section 2.1.4.

Drainage: Application Heuristics

1. Where uncurbed sections are used and drainage is effected by side ditches, there is no limiting minimum value for gradient or limiting upper value for vertical curves.
2. On curbed sections where storm water drains longitudinally in gutters and is collected by catch basins, vertical alignment is affected by drainage requirements. Minimum gradients are discussed in Subsection 2.1.3.2.
3. The profile of existing or planned stormwater piping is an important consideration in setting urban roadway grades. Storm sewer pipes typically have minimum depths to prevent freezing. These requirements are considered in setting catchbasin elevations.
4. Where the storm sewer system is not sufficiently deep to drain the streets by gravity flow, lift stations are an alternative. However, lift stations are generally considered undesirable due to the high costs associated with installation, operation and maintenance. Malfunctions at the lift station during a rain storm can also have a major detrimental impact on the street system and the adjacent developments.
5. On flat crest and sag curves, storm water might run sufficiently slowly so as to spread onto the adjacent travelled lane. There is a level point at the crest of a vertical curve, but generally no difficulty with drainage on curbed pavements is experienced if the

curve is sharp enough so that the minimum gradient of 0.35% is reached at a point about 15 m from the crest. This corresponds to a K value of 43. Where a crest K value greater than 43 is used, additional facilities such as the application of more frequent catchbasins are required to assure proper pavement drainage near the crest of the curve.

6. For sag vertical curves the same criterion for crest curves applies, that is, the minimum grade of 0.35% is reached within 15 m of the level point. Sag vertical curves normally occur in fill sections. In general, sag curves should be avoided in cut sections since they require unusual and costly drainage treatments.
7. False grading the gutter to provide positive drainage is a common design technique and is described in more detail in Subsection 2.1.5.3.
8. Long spiral curves on low gradients could produce flat areas with correspondingly poor drainage, and are to be avoided.
9. Bridges on sag curves are to be avoided where possible, since bridges tend to freeze more readily and storm water tends to collect on sag curves.

Snow: Application Heuristics

1. Snow drifting on roadways in areas of heavy snow accumulation can become a serious hazard to traffic.
2. Where the prevailing wind during a snow fall is lateral, snow will tend to accumulate in cut sections and other areas of depression. In such cases, the effect can be significantly mitigated by designing the profile so as to avoid cut sections in favour of fill. It is desirable to set the profile 0.7 to 1.0 m above surrounding land.
3. Where this is not possible for other reasons, the back slopes need to be flattened to 7:1 or flatter to avoid drifting, and other features of the cross section such as the presence

of trees and other obstacles should be examined.

4. Roads with open terrain on the windward side are exposed to drifting snow resulting in possible whiteout conditions and large snowbanks from snow plowing. An alternative horizontal alignment which shelters a road from this exposure is preferred. Such shelter may be woodlands or topographical features. Scale model simulation of drifting snow may be utilized to relocate the optimum alignment.

Intersections and Driveways: Application Heuristics

1. Intersections are areas of conflict and potential hazard. Desirably, the grades of the intersecting roads allow drivers to recognize the necessary manoeuvres to proceed through the intersection with safety and with minimum interference between vehicles. To this end, gradients as low as practicable are preferable.
2. Combinations of grade lines that make vehicle control difficult are to be avoided at intersections. The vertical alignments through intersections should be designed in consideration of the stopping and starting actions required and to favour the principal traffic flows.
3. It is desirable to avoid substantial grade changes at intersections, but it is not always feasible. Adequate sight distance is required along both roads and across the corners.
4. At all intersections where there are Yield or Stop signs, the gradients of the intersecting roads are made as flat as practicable on those sections that are to be used as storage space for stopped vehicles. However, a 1% minimum gradient is desirable to allow for reduction in cross-slope without impairing drainage. Flattening roadway cross-slopes to about 1% is often useful in avoiding abrupt changes in grade where roadways intersect. This is discussed more fully in Chapter 2.3. Intersections controlled by signals or which

- might be at some future date, are generally flat.
5. Many vehicle operators are unable to judge the increase or decrease in stopping or acceleration distance necessary due to steep grades. Their normal deductions and reactions thus may be in error at a critical time. Accordingly, grades in excess of 3% on intersecting roadways are to be avoided, where possible.
 6. The grade and cross sections on the intersection legs are adjusted for a distance back from the intersection proper to provide a smooth junction and proper drainage. Normally the grade of the major road is carried through the intersection and that of the crossing road adjusted to it. This requires transition of the crown of the minor road to an inclined cross section at its junction with the major road. Changes from one cross-slope to another are gradual.
 7. Intersections of a minor road crossing a multilane divided road with a narrow median and superelevated curve are avoided whenever possible because of the difficulty in adjusting grades to provide a suitable crossing. Grades of separate turning roadways are designed to suit the cross-slopes and grades of the intersection legs.
 8. The vertical alignment of a new street is normally set in consideration of the grades of existing or possible future driveways. For local streets, strong consideration is given to adjusting the street profile to provide desirable driveway grades. For the higher street classifications, more emphasis is placed on the design characteristics of the roadway with less consideration to optimizing driveway grades. The cross-slope of a roadway is rarely adjusted to suit the elevations of a driveway, unless the driveway handles high traffic volumes, in which case the cross-slope adjustment guidelines applicable to intersection areas may be suitable.
 9. In retrofit situations, re-grading of private properties is often necessary to achieve appropriate vertical alignment conditions for both the street and the driveway.
- Vertical Clearances: Application Heuristics
- Roads**
1. Vertical clearance requirements vary between the Provinces and local jurisdictions.
 2. Vertical clearances for local roads and non-truck routes may be less than that required for the remainder of the road system.
 3. The minimum vertical clearance, as measured from the roadway surface to the underside of the structure is applicable to the entire roadway width, including the shoulders.
 4. Minimum vertical clearance for vehicular bridges is 5.0 m over travelled lanes and shoulders.
 5. When setting the profile for a roadway beneath a bridge structure, designers should consider increasing the vertical clearance by 100 to 200 mm above the minimum value to make provision for future overlays of the roadway surface.
 6. To account for truck trailers with long wheelbases, additional vertical clearance should be considered when minimum sag vertical curves are used for underpass roadways.
 7. On existing roads that are being resurfaced or reconstructed the minimum structure clearance is 4.5 m. Where only the minimum vertical clearance exists beneath a bridge structure and the roadway requires resurfacing, the surface is normally milled and replaced, rather than overlaid.
- Railways**
1. Minimum vertical clearance over railways is 6.858 m (22.5 feet) measured from base of rail.

2. The minimum vertical clearance where ballast lifts are contemplated is 7.163 m (23.5 feet) measured from base of rail elevation to the underside of the overpass structure.
3. In all cases, it is good practice to confirm the specific clearance requirements with the pertinent railway company, as well as with the appropriate Federal and Provincial agencies, before designs are finalized.

Overhead Utilities

1. The vertical clearance requirements for roadways crossing beneath overhead utilities vary with the different agencies. In the case of overhead power lines, the clearance varies with the voltage of the conductors. The clearance requirements in each case should be confirmed with the controlling agency.

Pedestrian Overpasses

1. Normally, the minimum vertical clearance for a pedestrian overpass structure is set at 5.3 m or 0.3 m greater than the clearance of any existing vehicular overpass structure along that same route. This lessens the chances of it being struck by a high load - an important consideration - since a pedestrian overpass, being a relatively light structure, is generally unable to absorb severe impact and is more likely to collapse in such an event. The increased vertical clearance reduces the probability of damage to the structure and improves the level of safety for pedestrians using the structure.

Bikeways and Sidewalks

1. For bikeways, the minimum vertical clearance provided is 2.5 m.
2. It is desirable to allow up to 3.6 m of vertical clearance in order to provide an enhanced design and permit access for typical service vehicles.
3. Similar vertical clearances are normally provided for sidewalks since cyclists may

occasionally use the sidewalk, even where not legally permitted.

4. If it can be clearly determined that cyclists will not use the pedestrian sidewalk, minimum clearances in accordance with the National or Provincial Building Codes could be employed.
5. Further information on sidewalks and bikeways is provided in Chapters 2.2, 3.3 and 3.4.

Waterways

1. Over non-navigable waterways, bridges and open footing culverts, the vertical clearance between the lowest point of the soffit and the design high water level shall be sufficient to prevent damage to the structure by the action of flow water, ice flows, ice jams or debris.
2. For navigable waterways, navigational clearance is dependent on the type of vessel using the waterway and should be determined individually.
3. Clearances should also conform to the requirements of the Navigable Waters Protection Act of Canada.

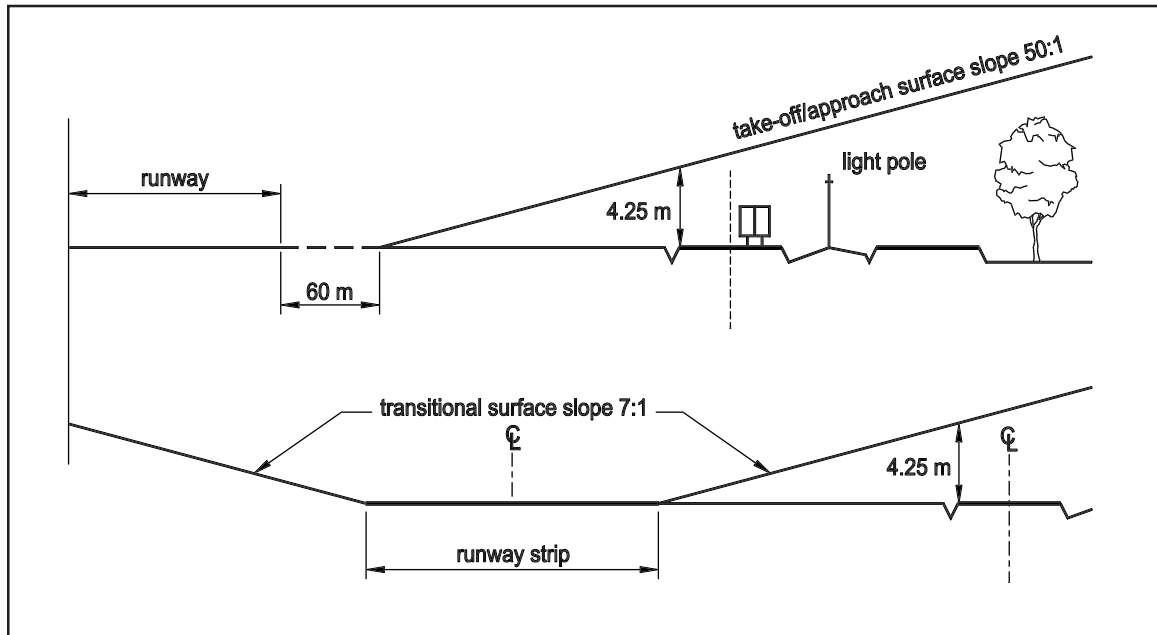
Airways

1. Vertical clearance to airways is as indicated in Figure 2.1.3.4.
2. Lighting poles should be contained within the clearance envelope.
3. The dimensions are for preliminary design. Specific dimensions should be approved by the designated Transport Canada representative.

2.1.3.6 Explicit Evaluation of Safety

General

Vertical alignment design has a significant impact on safety in areas where vehicles are required

Figure 2.1.3.4 Airway Clearance¹


to frequently stop and start. Excessive grades in intersection areas and at driveways can contribute significantly to collision frequencies during wet or icy conditions. Efforts are normally made to provide as flat a grade as practicable in these critical areas, while meeting the minimum slopes needed for adequate surface drainage.

Collision Frequency on Vertical Alignment

The following information on collision frequency is derived from a 1998 research paper²⁹.

The vertical profile of a road is likely to affect safety by various mechanisms. First, vehicles tend to slow down going up the grade and speed up going down the grade. Speed is known to affect collision severity. Thus on the up grade collisions tend to be less severe than on the down grade. Since down grade collisions tend to be more severe, a larger proportion of collisions tend to get reported. Thus, the severity and frequency of reporting collisions are affected by the grade. Second, road grades affect the diversity of speeds. This is thought by some to affect collision frequency. Third, road profile affects the available sight distance and gradient affects braking distance. All of these factors may affect collision frequency and severity. Finally,

grade determines the rate at which water drains from the pavement surface and this too may affect safety. The traditional belief was that safety-related design attention should focus on crest curves and sag curves. It turns out that while the vertical profile is an important determinant of the future safety of a road, sight distance at crest or sag curves is not as important as it seemed.

At present the quantitative understanding of how grade affects safety is imprecise. All studies using data from divided roads concluded that collision frequency increases with gradient on down grades. Some studies concluded that the same is true for up grades, while others concluded to the contrary. Estimates of the joint effect of grade on both directions of travel vary. It is suggested that the conservative Collision Modification Factor of 1.08 be used for all roads. That is, if the gradient of a road section is changed by Δg the collision frequency on that section changes by a factor of $1.08^{\Delta g}$. Thus, increasing the gradient from, say, 2.0% to 2.5%, is expected to increase collision frequency by a factor of $1.08^{0.5} = 1.04$.

Researchers looked for deterioration in safety on crests of vertical curves and found that for

sight distances longer than about 100 m there is no reason for concern except if an intersection or a similar features is near the crest where the sight distance is limited.

Professional literature often hints that there is an important interaction between grade and curvature. It is true that down grades cause an increase in collisions because of speed increases and it is also true that a small radius of horizontal curvature is a casual factor in collisions because of the large speed reduction

needed upon entry into the curve. The literature does not contain evidence that when there is a horizontal curve on a down grade, the collision frequency increases more than what is due to the sum of the separate down grade and the horizontal curvature effects. There is, however, an indication that when a right curve follows an up grade, there are unusually many collisions, perhaps due to sight distance limitations. There is also an indication that when a left curve follows a down grade, unusually many vehicles run off the road.

REFERENCES

1. TAC. Geometric Design Guide for Canadian Roads. Ottawa, 1986.
2. AASHTO. A Policy on Geometric Design of Roadways and Streets. Washington, D.C., 1994.
3. Ontario. Ministry of Transportation. Roadside Safety Manual. 1993.
4. B.C. Ministry of Transportation. Roadway Engineering Design Manual. 1995.
5. NCHRP. Truck Escape Ramps, Synthesis 178. TRB, Washington, D. C., 1992.
6. Saskatchewan. Department of Roadways and Transportation. Roadway Design Manual. 1998.
7. Alberta Transportation and Utilities. Alberta Roadway Geometric Design Guide. 1995.
8. Ontario. Ministry of Transportation. Geometric Design Standards for Ontario Roadways, 1994.
9. TAC. Urban Supplement to the Geometric Design Guide for Canadian Roads. Ottawa, 1995.
10. Zegeer, C.V. et al. Safety Effects of Geometric Improvements on Horizontal Curves. TRR 1356, TRB, Washington, D.C., 1992.
11. Eek, R.W., Lang, S.K. Roadway Design Standards to Accommodate Low Clearance Vehicles. TRR 1356, TRB, Washington, D.C., 1992.
12. Smith and Lam. Coordination of Horizontal and Vertical Alignment with Regard to Roadway Aesthetics. TRR 1445, TRB, Washington, D.C., 1994.
13. TRB. Recent Developments in Rural Road Design in Australia. TRR 1055, TRB, Washington, D.C., 1986.
14. Sanderson, R. W. "The Need for Cost Effective Guidelines to Enhance Truck Safety". Proceeding of the 1996 TAC Conference, Charlottetown, P.E.I.
15. Mak Engineering. Design Practise & Highway Aesthetics, Vancouver, B.C., 1994.
16. Mak Engineering. Relationship between Minimum Radius, Maximum Grade and Superelevation, Vancouver, B.C., 1995.
17. Australia. Austroads. Guide to the Geometric Design of Rural Roads, 1989.
18. Abdelwahab, W.E. and Morrall J. "Determination of the Need for and Location of Truck Escape Ramps". Proceedings of the 1996 TAC Conference, Charlottetown, P.E.I.
19. B.C. Ministry of Transportation and Highways. Slow Moving Vehicle Pullouts. Technical Bulletin DS97001., Victoria, B.C., 1997.
20. B.C. Ministry of Transportation and Highways. Climbing Lane Warrants & Design. Technical Bulletin DS97002., Victoria, B.C., 1997.
21. B.C. Ministry of Transportation and Highways. Passing Lane Warrants & Design. Technical Bulletin DS97003., 1997.
22. Morrall J., Miller E. Jr., Smith, G.A., Feuerstein J., Yazden F. "Planning and Design of Passing Lanes Using Simulation Model". Journal of Transportation Engineering. Vol. 121, No. 1, ASCE, Reston, VA, 1995.
23. Harwood D.W. Relationship Between Operational and Safety Considerations in Geometric Design Improvements. TRR 1512, TRB, Washington, D.C., 1995.
24. Morrall J. "An Inventory of Canadian Procedures for the Determination of the Need and Location of Passing Lanes and their Impact on the Level of Service on Two-

- Lane Highways” . Proceedings of the Third International Symposium on Highway Capacity, Road Directorate, Ministry of Transportation, Denmark, 1998.
25. Harwood, D.W. et al. Truck Characteristics for Use in Roadway Design and Operations. FHWA-RD-89-226 and 227, Washington, D.C., 1990.
 26. Harwood and St. John. Report No. FHWA-RD-85/028, Federal Highway Administration, Washington, D.C., 1985.
 27. Ontario. Ministry of Transportation and Communications. Development of Passing Lane Criteria, 1975.
 28. Hauer, E. “Literature Review and Analysis on Collision Rates on Horizontal Alignment”, University of Toronto, 1998.
 29. Hauer, E. “Literature Review and Analysis on Collision Rates on Vertical Alignment”. University of Toronto, 1998.
 30. Hauer, E. “Literature Review and Analysis on Collision Rates for Truck Climbing and Passing Lanes”. University of Toronto, 1998.
 31. Ontario. Ministry of Transportation and Communications, Highway Geometrics (Horizontal), SI (Metric). 1974.
 32. Harwood, D.W., Hoban, C.J., and Warren, D. “Effective Use of Passing Lanes on Two-Lane Highways”. TRB, Washington, D.C., 1988.
 33. TAC. Metric Curve Tables. Ottawa, 1977.
 34. TAC. Manual of Uniform Traffic Control Devices for Canada. Ottawa, 1998.
 35. Chowdury, M.A., et al. “Evaluation of Criteria for Setting Advisory Speeds on Curves”. TRB, Washington, D.C., 1998.
 36. Moyer and Berry [1940]. In AASHTO, A Policy on Geometric Design of Roadways and Streets. Washington, D.C., 1994.
 37. Glennon, J.C. “An Evaluation of Design Criteria for Operating Trucks Safely on Grades”. Highway Research Record 312. Texas Transportation Institute, Texas A&M University, 1970.
 38. Easa, S.M. Improved Sight Distance Model for Sag Vertical Curves with Overpasses, TRB 88th Annual Meeting, January, 2009.

Tables

Table 2.2.2.1	Lane Widths for Two-Lane Rural Roadways	2.2.2.1
Table 2.2.2.2	Lane Widths for Multilane Rural Roadways	2.2.2.1
Table 2.2.2.3	Through Lane Widths for Urban Roadways	2.2.2.2
Table 2.2.4.1	Shoulder Widths for Undivided Rural Roads (m)	2.2.4.2
Table 2.2.8.1	Guide for Lateral Spread of Surface Water Flow	2.2.8.2
Table 2.2.10.1	Horizontal Clearance at Bridges on Local and Collector Urban Roads	2.2.10.4
Table 2.2.10.2	Horizontal Clearance at Bridges on Rural Roads	2.2.10.6

Figures

Figure 2.2.1.1	Urban Street Cross Section Elements Nomenclature	2.2.1.4
Figure 2.2.1.2	Rural Roadway Cross Section Elements Nomenclature	2.2.1.5
Figure 2.2.2.1	Collision Modification Factor for Various Lane Widths and Traffic Levels versus Annual Average Daily Traffic	2.2.2.4
Figure 2.2.4.1	Usable Shoulders	2.2.4.1
Figure 2.2.4.2	Centreline Rumble Strips	2.2.4.5
Figure 2.2.4.3	Shoulder Rumble Strips	2.2.4.6
Figure 2.2.4.4	Shoulder Cross-Slope and Superelevation	2.2.4.7
Figure 2.2.4.5	Shoulder Rounding	2.2.4.8
Figure 2.2.4.6	Collision Modification Factor for Various Shoulder Widths versus Annual Average Daily Traffic	2.2.4.10
Figure 2.2.5.1	Freeway Medians	2.2.5.3
Figure 2.2.5.2	Arterial Medians	2.2.5.5
Figure 2.2.6.1	Typical Sidewalk, Boulevard and Border Dimensions	2.2.6.2
Figure 2.2.6.2	Sidewalk and Driveway Entrances	2.2.6.4
Figure 2.2.6.3	Sidewalk Requirements and Typical Dimensions	2.2.6.6
Figure 2.2.6.4	Sidewalk Ramps and Curb Cuts	2.2.6.9
Figure 2.2.7.1	Curb and Gutter Types	2.2.7.2
Figure 2.2.9.1	Effect of Slope on Snow Drifting	2.2.9.2
Figure 2.2.9.2	Snow Drifting Patterns for Alternative Median Barriers	2.2.9.3
Figure 2.2.10.1	Horizontal Clearance at Bridges on Urban Arterial Roads (Underpass)	2.2.10.2
Figure 2.2.10.2	Horizontal Clearance at Bridges on Urban Freeways (Underpass)	2.2.10.3
Figure 2.2.10.3	Horizontal Clearance on Bridges on Urban Arterial Roads (Overpass)	2.2.10.7
Figure 2.2.10.4	Horizontal Clearance at Bridges on Urban Freeways (Overpass)	2.2.10.8
Figure 2.2.10.5	Collision Rate versus Relative Bridge Width for Two-Lane Two-Way Rural Roads	2.2.10.10
Figure 2.2.11.1	Relationship between Frequency of Utility Pole Collisions and Pole Offset for Three Levels of Pole Density	2.2.11.2
Figure 2.2.11.2	Nomograph for Predicting Utility Pole Collision Rate	2.2.11.3
Figure 2.2.12.1	Staging of New Six-Lane Divided Arterial Street	2.2.12.3

Figure 2.2.12.2	Staging of a New Four-Lane Undivided Arterial Street	2.2.12.5
Figure 2.2.13.1	Typical Section - Public Lanes	2.2.13.1
Figure 2.2.13.2	Typical Section - Rural Local Undivided Road	2.2.13.2
Figure 2.2.13.3	Typical Section - Urban Local Undivided Road	2.2.13.3
Figure 2.2.13.4	Typical Section - Rural Collector Undivided Road	2.2.13.4
Figure 2.2.13.5	Typical Section - Urban Collector Undivided Road	2.2.13.5
Figure 2.2.13.6	Typical Section - Rural Collector Divided Road	2.2.13.6
Figure 2.2.13.7	Typical Section - Urban Collector Divided Road	2.2.13.7
Figure 2.2.13.8	Typical Section - Rural Arterial Undivided Road	2.2.13.8
Figure 2.2.13.9	Typical Section - Urban Arterial Undivided Road	2.2.13.9
Figure 2.2.13.10	Typical Section - Rural Arterial Divided Road	2.2.13.10
Figure 2.2.13.11	Typical Section - Urban Arterial Divided Road	2.2.13.11
Figure 2.2.13.12	Typical Section - Rural Expressways and Freeways	2.2.13.12
Figure 2.2.13.13	Typical Section - Urban Expressways and Freeways	2.2.13.13

2.2.2.2 Explicit Evaluation of Safety

Lane Widths

There are two links between safety and lane width.

1. The wider the lanes, the larger will be the average separation between vehicles operating in adjacent lanes. This may provide a larger buffer to adsorb the small random deviations of vehicles from their intended path. On roadways that are identical except for lane widths, drivers may tend to drive faster and follow the preceding vehicle more closely on the road that has wider lanes.³
2. A wider lane may provide more room for correction in near-collision circumstances. For example, a moment's inattention may lead a vehicle to drop off the edge onto a gravelled shoulder. In the same situation, if the driving lane was wider and the shoulder paved, the driver's brief moment of inattention may have less serious consequences.

While a great amount of empirical evidence about the relationship between lane width and safety has been accumulated over several decades, the bulk of available research pertains to two-lane rural roads. Little is known about the effect of lane width on multilane or urban roadways. The major difficulty faced by researchers in assessing the relationship between lane width and safety stems from the number of variables encountered in the statistical

data. These variables include lane width, shoulder width, type of shoulder surface, pavement edge drops and other factors. In general, it has been concluded that a wider lane will provide a greater level of safety than a narrower lane; however, the weight of empirical evidence indicates that there is little safety benefit to be derived by widening lanes beyond 3.3 m, and that widening beyond 3.7 m may be to the detriment of safety (except for widened lanes on curves and shy distances to curbs).

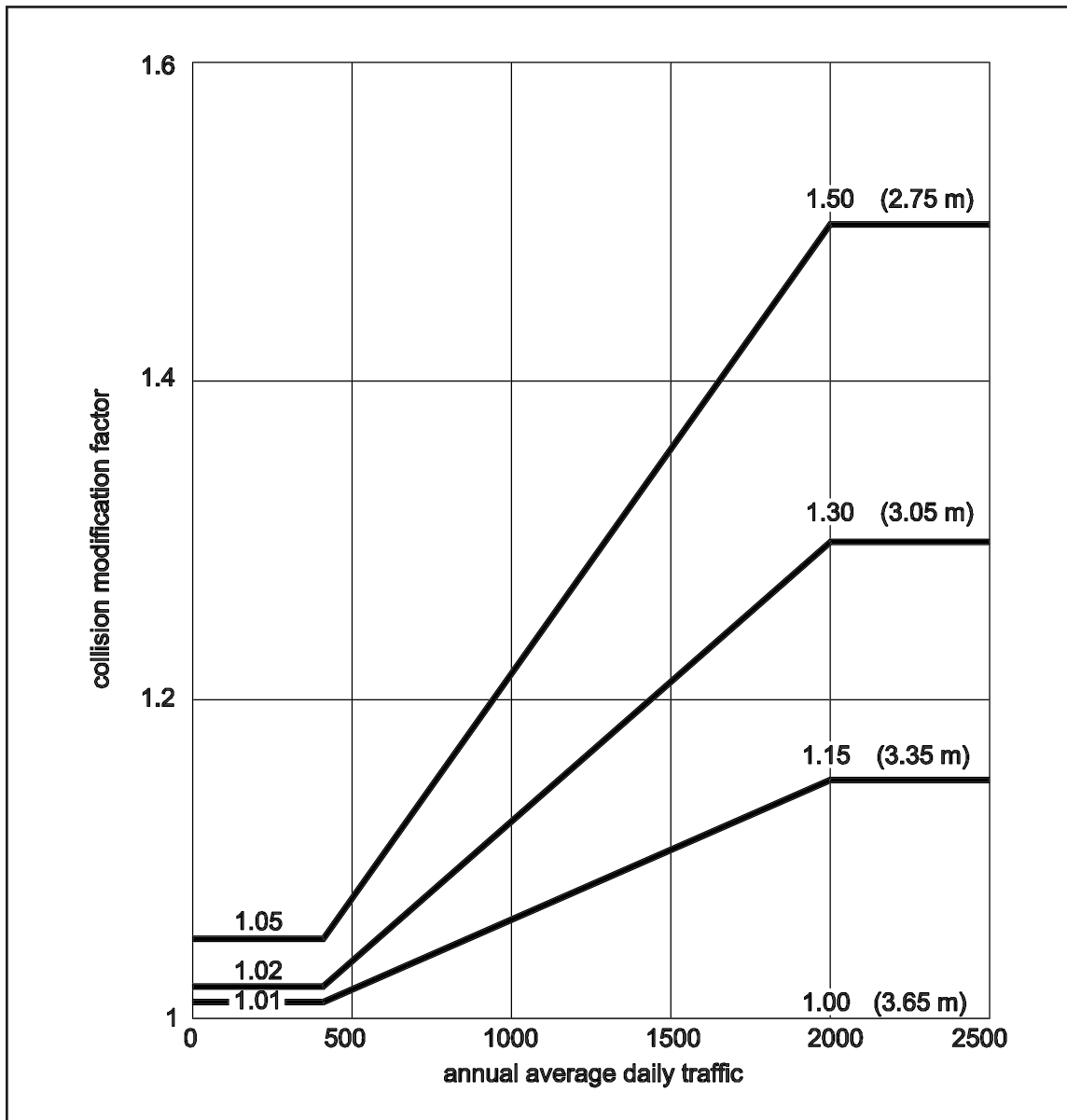
Figure 2.2.2.1 shows the relationship between opposite direction and single-vehicle collisions and lane width for given Annual Average Daily Traffic volume.

To illustrate the use of Figure 2.2.2.1, suppose the designer wishes to determine the effect of using 3.05 m lanes rather than 3.65 m lanes for a two-lane rural road. The Annual Average Daily Traffic (AADT) of the road is 1500 vehicles per day. The Collision Modification Factor (CMF) for a 3.65 m lane is 1.00, whereas the CMF for a 3.05 m lane equals $1.02 + (1.30 - 1.02)(1500 - 400)/(2000 - 400)$, or 1.21. This means that the designer could anticipate 21% more single vehicle or opposite direction incidents if 3.05 m lanes were used rather than 3.65 m lanes.

Centreline Rumble Strips: Best Practices^{19, 20}

On two-lane rural roadways and multi-lane urban and rural roadways, centreline rumble strips can be a cost-effective means to reduce head-on and opposite-direction sideswipe collisions. Refer to Figure 2.2.4.2 for typical dimensions of centreline rumble strips.

Figure 2.2.2.1 Collision Modification Factor for Various Lane Widths and Traffic Levels versus Annual Average Daily Traffic³



width reduction can help the designer to reach the appropriate decision.

6. Shoulder widths on bridge decks for various conditions are discussed in Section 2.2.10.
7. Shoulder widths are normally multiples of 0.5 m.

2.2.4.3 Surface Treatment of Shoulders: Best Practices

Delineating the Shoulder and the Travel Lane

It is important to make a clear distinction between travel lanes and shoulders so as not to encourage the use of a shoulder as a travel lane. During the night and in periods of inclement weather, the ability for the driver to differentiate between the travelled lanes and the shoulder enhances the safety of the roadway. Assisting the driver in this respect can be accomplished in a number of ways, including:

1. The use of pavement of a contrasting colour and/or texture on paved shoulders or the use of rumble strips. For example, the shoulder may be treated with a coarser surface than that of the travel lane, so that if a vehicle inadvertently leaves the lane and travels onto the shoulder, the change in tone of tire noise will alert the driver.
2. The use of pavement edge striping. This is an important and economical measure for delineating the shoulders, particularly where the shoulder is partially paved with the same material as the through travel lane.
3. Shoulders sometimes have a steeper cross-slope than the adjacent travel lane. This further assists the driver in distinguishing between the two.

Shoulder Material

In the selection of surface treatment of the shoulder, the designer must consider the impacts on the level of safety, drainage, and maintenance costs. Three types of shoulder treatments are available to the designer: paved, gravelled, and partially paved.

1. Gravelled shoulders provide a clear line of demarcation between the edge of travel lanes and the shoulder but require a higher level of maintenance.
2. Paved or sealed shoulders are safer than unpaved shoulders as they provide a greater recovery and manoeuvring area for motorists to take evasive action to avoid potential collisions or to reduce their severity. Paved shoulders also reduce the potential for vehicles that stray out of the driving lane to lose control in loose shoulder material.⁵
3. Partially paved shoulders that have a paved width of 0.8 m provide a stable surface to absorb minor deviations of vehicles straying from the travelled lanes.
4. The benefits of paved or sealed shoulders are generally greater for sections of roads on curve or on grade than on flat, tangential sections of roadway.

Pavement Edge Drops

Pavement edge drops (vertical discontinuities at the edge of the paved surface) should be avoided, particularly on the inside of horizontal curves. Trucks are particularly susceptible to roll-over at pavement edge drops because of their higher centre of gravity, compounded by the potential of load-shifting and the wider off-tracking of the rear wheels of the vehicle.

Shoulder Rumble Strips

Shoulder rumble strips are a cost-effective strategy to reduce single-vehicle run-off-road incidents. Shoulder rumble strips are often used to provide an audible and tactile warning to the driver that the vehicle has left the travelled lanes.

1. Continuous rumble strips on asphalt shoulders or regularly spaced rumble strips along extended sections of asphalt or concrete shoulders have been shown to reduce the rate of run-off-road incidents significantly.^{6,19}

2. On highways with extremely monotonous driving conditions, reductions in run-off-road collisions as high as 60% can be expected.^{2,7} Rumble strips on roadways having a high volume of bicyclist traffic can also serve as a buffer to keep the cyclist away from the painted shoulder line, provided that the shoulder is of sufficient width.
3. A shoulder rumble strip is a raised or grooved pattern in the pavement surface of the shoulder. The raised rumble strip is not as desirable as the grooved type because of snow clearing operations. Grooved rumble strips are indented into the pavement of the shoulder of the roadway. In summer, grooved rumble strips are self-cleaned by highway traffic. In winter, even covered with snow the shoulder rumble strips still produce an effective humming noise when traversed by errant vehicles.⁸
4. Rumble strips may be rolled into the shoulder surface during the installation of an asphalt pavement or overlay. A second method is to 'mill' the strip into the finished pavement. Although the cost of milled rumble strips is more expensive than the cost of rolled-in strips, milled-in rumble strips generally keep their intended shape during construction.⁹ Rolled-in strips have the additional limitation of making the compaction of the pavement more difficult. Milled-in rumble strips tend to produce a more effective rumbling noise and create more vibration for large trucks than the rolled-in type.⁸ Refer to Figure 2.2.4.3 for typical dimensions for shoulder rumble strips.

2.2.4.4 Shoulder Cross-Slopes: Best Practices

The difference in cross-slope between a shoulder and an adjacent travel lane can have an impact on safety. When the difference in cross-slope is significant, a disabled vehicle moving to the shoulder may experience serious sway causing the occupants discomfort and perhaps causing the driver to lose control; or

the driver, on recognizing the difference will reduce speed before moving to the shoulder, putting themselves and other roadway users in danger. A number of useful practices can help the road designer reduce the possibility of these situations from occurring.

1. On a tangent section the cross-slope on shoulders may be the same as or up to 0.03 m/m steeper than that of the adjacent travel lane.
2. On sections in which the normal crown is removed and reversed, the shoulder cross-slope is normally maintained as for the tangent section.
3. On superelevated sections, the cross-slope on the low side is normally the same as that of the adjacent travelled lane. On the high side two alternative treatments are in common use. Some authorities superelevate the shoulder to match that of the travel lanes, while others slope the shoulder away from the travel lane to prevent water runoff from the shoulder from flowing across them.
4. In the latter practice, excessive difference in slope at the common edge should be discouraged to minimize sway in a vehicle moving to the shoulder and to discourage reductions in speed before leaving the travelled lanes. A maximum algebraic difference in cross-slope of 0.08 m/m is used by some authorities.
5. The cross-slope of the shoulder relative to cross-slope of the travelled lanes is illustrated in Figure 2.2.4.4.

Additional information pertaining to cross slopes is provided in Chapter 2.1.

2.2.4.5 Shoulder Rounding: Best Practices

Shoulder rounding is a transition between the shoulder and the constant fill slope or cut side slope. It provides lateral support for the shoulder and also helps reduce the potential of errant vehicles leaving the roadway becoming

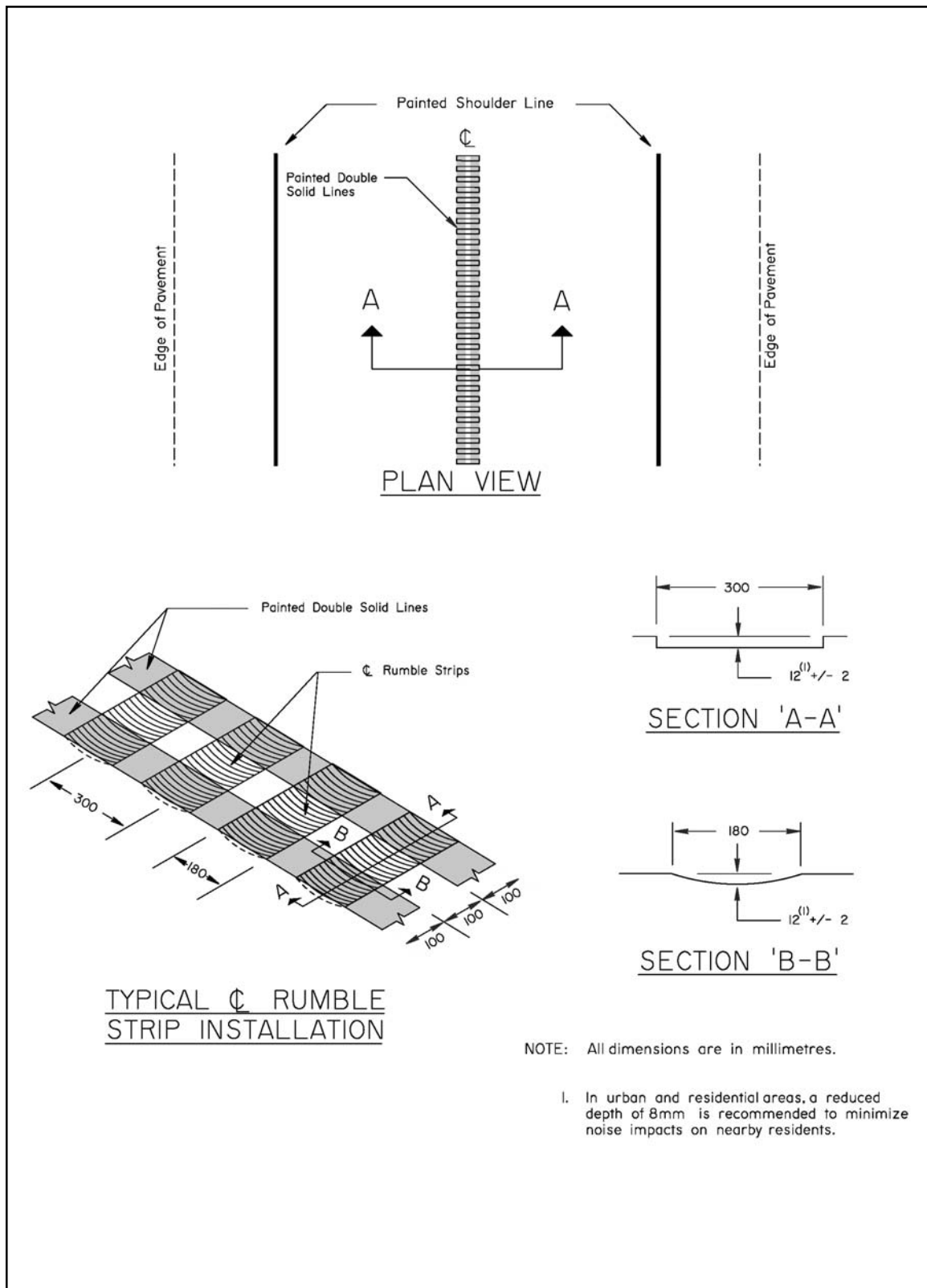
Figure 2.2.4.2 Centreline Rumble Strips²⁰


Figure 2.2.4.3 Shoulder Rumble Strips⁸

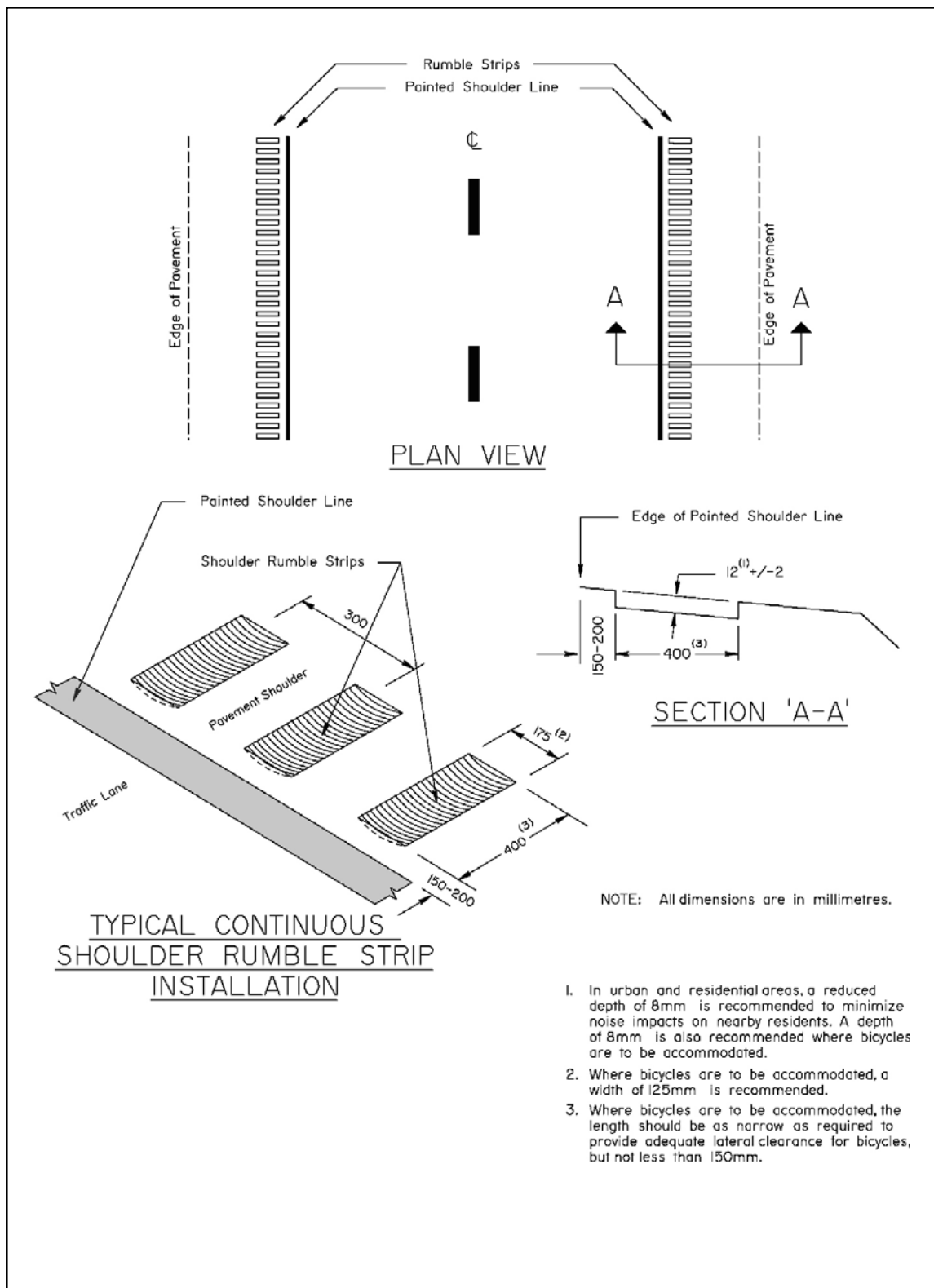


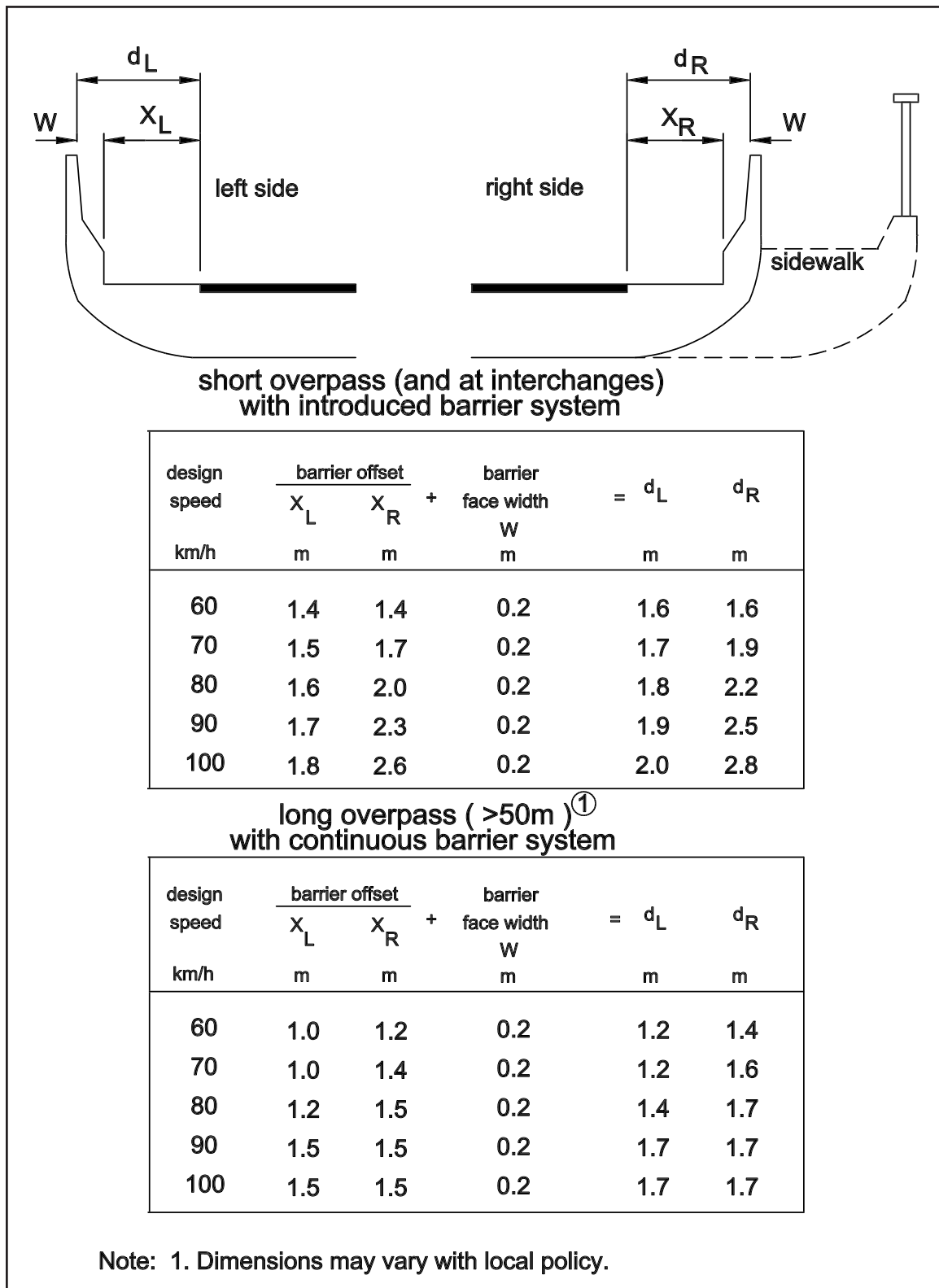
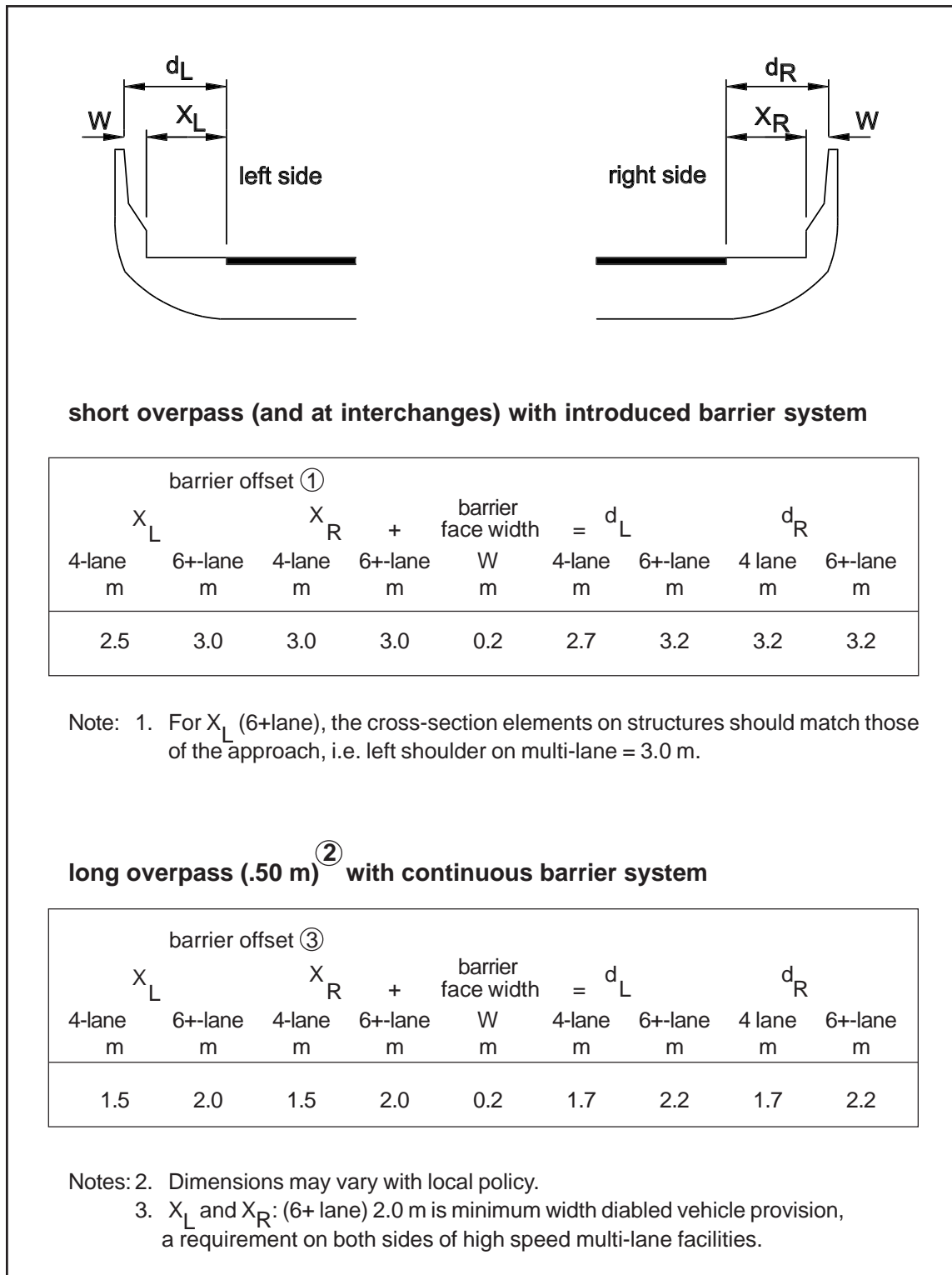
Figure 2.2.10.3 Horizontal Clearance on Bridges on Urban Arterial Roads (Overpass)


Figure 2.2.10.4 Horizontal Clearance on Bridges on Urban Freeways (Overpass)



REFERENCES

1. "Human Factors Research in Highway Safety", Transportation Research Circular 414, Transportation Research Board, Washington, D.C., 1993.
2. "Highway Capacity Manual, Special Report 209", Transportation Research Board, National Research Council, Washington, D.C., 1985.
3. Hauer, E. "Literature Review and Analysis on Lane Widths", University of Toronto, 1998.
4. American Association of State Highway and Transportation Officials, "A Policy on Geometric Design of Highways and Streets", Washington, D.C., 1994.
5. Ogden, K.W., Pearson, R.A., "Road and Traffic Factors in Truck Safety", Proceedings 16th Australian Road Research Board Conference, Part 4.
6. Harwood, D.W., "Use of Rumble Strips to Enhance Safety", Synthesis of Highway Practice 191, Transportation Research Board, Washington, D.C., 1993.
7. Hickey Jr., J.J., "Shoulder Rumble Strip Effectiveness: Drift-Off-Road Accident Reductions on the Pennsylvania Turnpike", Transportation Research Record No. 1573, Washington, D.C., 1997.
8. Alberta Transportation and Utilities, "A Review of Practices for Use of Rumble Strips on Alberta's Rural Highways", Technical Standards Branch, Edmonton, Alberta, 1998.
9. Khan, A.M. and Bacchus, A., "Economic Feasibility and Related Issues of Highway Shoulder Rumble Strips" Transportation Research Record 1498, Washington, D.C., 1995.
10. Hauer, E. "Literature Review and Analysis on Shoulder Widths", University of Toronto, 1998.
11. Knuiman, M.W., Council, F.M., and Reinfurt, D.W., "Association of Median Width and Highway Accident Rates", Transportation Research Record No. 1401, Washington, D.C., 1993.
12. Zeeger, C.V., and Council F.M., "Safety Effectiveness of Highway Design Features - Volume III - Cross sections", FHWA-RD-91-06, Federal Highway Administration, November 1992.
13. ITE Technical Council Committee 5-5, "Guidelines for Urban Major Street Design", Institute of Transportation Engineers, 1984.
14. Zeeger, C.V. and Parker, M.R., "Cost-Effectiveness of Countermeasures for Utility Pole Accidents", Report No. FHWA/RD-83, Federal Highway Administration, Washington, D.C., September 1983.
15. Turner, D.S., "Prediction of Bridge Accident Rates", Journal of Transportation Engineering, Vol. 110, No. 1, American Society of Civil Engineers, New York, NY, January 1984.
16. Mak, K.K., "Effect of Bridge Width on Highway Safety", State of the Art Report 6, Relationship Between Safety and Key Highway Features, Transportation Research Board, Washington, D.C., 1987.
17. Ogden, K.W., "Safer Roads: A Guide to Road Safety Engineering", Avery Technical, 1995.
18. Harwood, D.W., "Multi-lane Design Alternatives For Improving Suburban Highways" NCHRP Report 282, Transportation Research Board, National Research Council, Washington, D.C., 1986.
19. Best Practices for the Implementation of Shoulder and Centreline Rumble Strips, Transportation Association of Canada, 2001.
20. National Cooperative Highway Research Program Report 641, "Guidance for the Design and Application of Shoulder and Centreline Rumble Strips", Transportation Research Board, Washington, D.C., 2009.

**Transportation
Association of
Canada**



**Geometric
Design
Guide for
Canadian
Roads**

Part 2

**September 1999
Updated December 2011**

The Transportation Association of Canada is a national association with a mission to promote the provision of safe, secure, efficient, effective and environmentally and financially sustainable transportation services in support of Canada's social and economic goals. The association is a neutral forum for gathering or exchanging ideas, information and knowledge on technical guidelines and best practices. In Canada as a whole, TAC has a primary focus on roadways and their strategic linkages and inter-relationships with other components of the transportation system. In urban areas, TAC's primary focus is on the movement of people, goods and services and its relationship with land use patterns.

L'ATC est une association d'envergure nationale dont la mission est de promouvoir la sécurité, la sûreté, l'efficacité, l'efficacités et le respect de l'environnement dans le cadre de la prestation de services financièrement durables de transport, le tout à l'appui des objectifs sociaux et économiques du Canada. L'ATC est une tribune neutre de collecte et d'échange d'idées, d'informations et de connaissances à l'appui de l'élaboration de lignes directrices techniques et de bonnes pratiques. À l'échelle du pays, l'Association s'intéresse principalement au secteur routier et à ses liens et interrelations stratégiques avec les autres composantes du réseau de transport. En milieu urbain, l'Association s'intéresse non seulement au transport des personnes et des marchandises, mais encore à la prestation de services à la collectivité et aux incidences de toutes ces activités sur les modèles d'aménagement du territoire.

© Transportation Association of Canada, 1999
2323 St. Laurent Boulevard
Ottawa, Canada K1G 4J8
Tel. (613) 736-1350
Fax: (613) 736-1395
Web site: www.tac-atc.ca
ISBN 1-55187-131-9

2.3 INTERSECTIONS

2.3.1	INTRODUCTION	2.3.1.1
2.3.1.1	General	2.3.1.1
2.3.1.2	Definitions	2.3.1.1
2.3.1.3	Elements of Design	2.3.1.3
2.3.1.4	Traffic Manoeuvres and Conflicts	2.3.1.4
2.3.1.5	Traffic Control Measures	2.3.1.9
2.3.1.6	Safety Considerations	2.3.1.9
2.3.1.7	Intersection Spacing Considerations	2.3.1.11
2.3.1.8	Traffic Signal Spacing and Progression	2.3.1.15
2.3.1.9	Design Options for Urban Residential Areas	2.3.1.17
2.3.1.10	Intersection Layout for New and Retrofit Design	2.3.1.18
2.3.2	ALIGNMENT	2.3.2.1
2.3.2.1	Design Speed	2.3.2.1
2.3.2.2	Horizontal Alignment	2.3.2.1
2.3.2.3	Vertical Alignment and Cross-Slope	2.3.2.4
2.3.2.4	Combined Vertical and Horizontal Alignments	2.3.2.11
2.3.2.5	Reduced Superelevation Through Intersections	2.3.2.13
2.3.2.6	Realignments for Retrofit	2.3.2.16
2.3.3	SIGHT DISTANCE	2.3.3.1
2.3.3.1	General	2.3.3.1
2.3.3.2	Sight Triangle	2.3.3.1
2.3.3.3	Sight Distance Requirements for Specific Traffic Control Devices	2.3.3.4
2.3.3.4	Decision Sight Distance	2.3.3.12
2.3.3.5	Summary	2.3.3.16
2.3.3.6	Sight Distance at Bridge Structures	2.3.3.16
2.3.3.7	Sight Distance at Railway Crossings	2.3.3.19
2.3.4	SIMPLE INTERSECTIONS	2.3.4.1
2.3.4.1	General	2.3.4.1
2.3.4.2	Design Vehicle	2.3.4.4
2.3.4.3	Corner Radius Considerations and Design	2.3.4.4
2.3.4.4	Shoulders at Simple Intersections	2.3.4.10
2.3.5	FLARED INTERSECTIONS AND AUXILIARY LANES	2.3.5.1
2.3.5.1	General and Definitions	2.3.5.1
2.3.5.2	Guidelines for the Application of Right-Turn Taper and Bay Tapers with Auxiliary Lanes	2.3.5.2

2.3.5.3	Design Elements for Right-Turn Tapers Without Auxiliary Lanes	2.3.5.2
2.3.5.4	Design Elements for Right-Turn Tapers with Auxiliary Lanes	2.3.5.4
2.3.5.5	Effect of Grade	2.3.5.6
2.3.6	CHANNELIZATION	2.3.6.1
2.3.6.1	General and Definitions	2.3.6.1
2.3.6.2	Principles of Channelization	2.3.6.2
2.3.6.3	Guidelines for the Application of Channelization	2.3.6.3
2.3.6.4	Right-Turn Designs	2.3.6.3
2.3.6.5	Traffic Islands	2.3.6.5
2.3.7	TURNING ROADWAYS	2.3.7.1
2.3.7.1	General	2.3.7.1
2.3.7.2	Radii and Curvature for Turning Roadways	2.3.7.1
2.3.7.3	Turning Roadway Widths	2.3.7.2
2.3.7.4	Speed-Change Lanes and Tapers	2.3.7.2
2.3.7.5	Yield Taper at Minor Roadway	2.3.7.4
2.3.7.6	Method of Lane Drop for Dual Lane Right-Turning Roadway	2.3.7.4
2.3.8	LEFT-TURN LANES	2.3.8.1
2.3.8.1	General and Definitions	2.3.8.1
2.3.8.2	Guidelines for the Application of Left-Turn Lanes	2.3.8.1
2.3.8.3	Approach and Departure Tapers	2.3.8.1
2.3.8.4	Single Left-Turn Lane	2.3.8.3
2.3.8.5	Left-Turn Lanes for Four-Lane and Six-Lane Roadways	2.3.8.13
2.3.8.6	Multiple Left-Turn Lanes	2.3.8.15
2.3.8.7	Slot Left-Turn Lanes	2.3.8.22
2.3.8.8	Intersections on Curve	2.3.8.26
2.3.9	TRANSITION BETWEEN FOUR-LANE ROADWAY AND TWO-LANE ROADWAY AT INTERSECTIONS	2.3.9.1
2.3.9.1	Undivided Roadways	2.3.9.1
2.3.9.2	Divided Roadways	2.3.9.1
2.3.10	WIDENING THROUGH A SIGNALIZED INTERSECTION	2.3.10.1

2.3.11	MEDIAN OPENINGS	2.3.11.1
2.3.11.1	Use and Function	2.3.11.1
2.3.11.2	Elements of Design	2.3.11.1
2.3.11.3	U-Turns	2.3.11.2
2.3.11.4	Emergency and Maintenance Vehicle Crossings	2.3.11.2
2.3.12	ROUNDBABOUTS	2.3.12.1
2.3.12.1	Introduction	2.3.12.1
2.3.12.2	Roundabout Characteristics	2.3.12.1
2.3.12.3	Categories of Roundabouts	2.3.12.1
2.3.12.4	Typical Range of Geometric Parameters	2.3.12.3
2.3.12.5	Location/Application of Roundabouts	2.3.12.3
2.3.12.6	Geometry/Road Capacity	2.3.12.4
2.3.12.7	Safety Analysis	2.3.12.4
2.3.13	RAILWAY GRADE CROSSINGS	2.3.13.1
2.3.13.1	Introduction	2.3.13.1
2.3.13.2	Location of New Crossings	2.3.13.1
2.3.13.3	Vertical Alignment	2.3.13.3
2.3.13.4	Horizontal Alignment	2.3.13.3
2.3.13.5	Width of Crossing	2.3.13.3
2.3.13.6	Sight Distance at Railway Crossings	2.3.13.4
2.3.14	PEDESTRIAN CROSSINGS AT-GRADE	2.3.14.1
2.3.14.1	Intersection Crosswalks	2.3.14.1
2.3.14.2	Accommodation of Persons with Disabilities	2.3.14.1
REFERENCES	2.3.R.1

TABLES

Table 2.3.1.1	Desirable Spacing Between Signalized Intersections (m)	2.3.1.17
Table 2.3.2.1	Design Values for Rate of Change of Cross-Slope for Intersection Areas	2.3.2.16
Table 2.3.2.2	Opportunities for Retrofit	2.3.2.18
Table 2.3.3.1	Distance Travelled in 3.0 s	2.3.3.4
Table 2.3.3.2	Ratios of Acceleration Times on Grades	2.3.3.6
Table 2.3.3.2a	Time Gap for Turning Movements from Stop	2.3.3.11
Table 2.3.3.3	Minimum Property Requirements at 90° Intersections for Stop Control	2.3.3.13
Table 2.3.3.4	Summary Table for Design of Sight Distance at Intersections	2.3.3.15

Table 2.3.3.5	Sight Distance for Left Turns at Unsignalized Interchange Ramp Terminals	2.3.3.15
Table 2.3.4.1	Guidelines for Shoulder Treatment at Simple Rural Intersections	2.3.4.12
Table 2.3.5.1	Right-Turn Tapers Without Auxiliary Lanes	2.3.5.4
Table 2.3.5.2	Right-Turn Taper with Parallel Deceleration Lane Design	2.3.5.5
Table 2.3.5.3	Grade Factors for Deceleration Length	2.3.5.6
Table 2.3.7.1	Design Widths for Turning Roadways at Intersections	2.3.7.4
Table 2.3.8.1	Approach and Departure Taper Ratios and Lengths for Left Turns at Intersections	2.3.8.2
Table 2.3.8.2	Bay Tapers - Straight Line	2.3.8.5
Table 2.3.8.3	Bay Tapers - Symmetrical Reverse Curves	2.3.8.5
Table 2.3.9.1	Parallel Lane and Taper Lengths for Transition between Undivided Four-Lane Roadway and Two-Lane Roadway	2.3.9.1
Table 2.3.11.1	Minimum Median Widths for U-Turns	2.3.11.3
Table 2.3.12.1	Roundabout Categories	2.3.12.3
Table 2.3.12.2	Typical Range of Geometric Parameters	2.3.12.3
Table 2.3.12.3	Geometry/Capacity Relationships	2.3.12.3
Table 2.3.13.1	Allowable Difference Between Roadway Gradient and Railway Cross-Slope	2.3.13.3

Figures

Figure 2.3.1.1	Intersection Configurations	2.3.1.2
Figure 2.3.1.2	Typical Traffic Movements Within an Intersection and its Approach	2.3.1.5
Figure 2.3.1.3	Conflict Points and Collision Rates of Three- and Four-Legged Intersections	2.3.1.7
Figure 2.3.1.4	Conflict Areas at Intersections	2.3.1.8
Figure 2.3.1.5	Prohibiting or Discouraging Turns at Intersections	2.3.1.10
Figure 2.3.1.6	Cross Road Intersection Spacing Adjacent to Interchanges	2.3.1.13
Figure 2.3.1.7	Intersection Spacing / Channelization Treatment at Diamond Interchanges	2.3.1.14
Figure 2.3.1.8	Desirable Signal Spacing for Combinations of Cycle Length	2.3.1.16
Figure 2.3.1.9	Intersection Analysis Procedure	2.3.1.19
Figure 2.3.2.1	Examples of Realignment of Intersections	2.3.2.3
Figure 2.3.2.2	Fitting Minor Roadway Profiles to the Major Roadway Cross Section	2.3.2.5
Figure 2.3.2.3	Pavement Cross Sections, Typical Minor Roadway Profile Adjustment	2.3.2.6
Figure 2.3.2.4	Pavement Cross Sections, Adjustment of Cross-Slope	2.3.2.7
Figure 2.3.2.5	Cross-Slope Modification at Intersection of Two Roadways of Equal Classification	2.3.2.9
Figure 2.3.2.6	Pavement Cross Sections, Typical Adjustment of Profile and Cross-Slope at Two Roadways of Equal Classification	2.3.2.10

Figure 2.3.2.7	Combined Vertical and Horizontal Alignments of Intersections	2.3.2.12
Figure 2.3.2.8	Effect of Geometry on Intersection Collision Rates	2.3.2.14
Figure 2.3.2.9	Relationship of Speed, Radius and Superelevation Through Intersections	2.3.2.15
Figure 2.3.2.10	Shifts in Horizontal Alignment Across Intersections	2.3.2.19
Figure 2.3.3.1	Approach Sight Triangles	2.3.3.2
Figure 2.3.3.2	Departure Sight Triangles	2.3.3.3
Figure 2.3.3.3	Assumed Acceleration Curves (Acceleration From Stop Control on Minor Road)	2.3.3.7
Figure 2.3.3.4a	Sight Distance for Crossing Movements and Vehicles Turning Left across Passenger Vehicle approaching from the Left	2.3.3.8
Figure 2.3.3.4b	Sight Distance for Turning Movements with Vehicles approaching in the Intended Direction of Travel	2.3.3.9
Figure 2.3.3.5	Sight Distance and Visibility Triangle at 90° Intersections for Approaches with Stop Control	2.3.3.14
Figure 2.3.3.6	Decision Sight Distance	2.3.3.17
Figure 2.3.3.7	Measurement of Sight Distance at Ramp Terminals Adjacent to Overpass Structures	2.3.3.18
Figure 2.3.4.1	Simple Intersections	2.3.4.2
Figure 2.3.4.2	Intersections with Auxiliary Lanes for T-Intersections	2.3.4.3
Figure 2.3.4.3	Intersection with Auxiliary Lanes for Cross-Intersections	2.3.4.5
Figure 2.3.4.4	Edge of Pavement Design - Circular Curve	2.3.4.6
Figure 2.3.4.5	Edge of Pavement Design - Two-Centred Compound Curve	2.3.4.8
Figure 2.3.4.6	Edge of Pavement Design - Three-Centred Compound Curve	2.3.4.9
Figure 2.3.4.7	Shoulder Transition at Open Throat Intersections with Auxiliary Lanes	2.3.4.11
Figure 2.3.4.8	Gravel Shoulder Treatment at Simple Intersections	2.3.4.11
Figure 2.3.4.9	Paved Shoulder Treatment at Intersections	2.3.4.13
Figure 2.3.4.10	Shoulder Treatment with Concrete Curb and Gutter at Intersections	2.3.4.13
Figure 2.3.5.1	Typical Right-Turn Taper Lane Design at T-Intersections	2.3.5.3
Figure 2.3.5.2	Typical Right-Turn Taper Lane Design at Cross-Intersections	2.3.5.3
Figure 2.3.5.3	Right-Turn Taper with Parallel Deceleration Lane Design	2.3.5.5
Figure 2.3.6.1	Typical Right-Turn Designs	2.3.6.4
Figure 2.3.6.2	Directional Islands	2.3.6.6
Figure 2.3.6.3	Divisional Islands	2.3.6.7
Figure 2.3.6.4	Refuge Islands	2.3.6.7
Figure 2.3.6.5	Opposing Divisional Islands	2.3.6.8
Figure 2.3.6.6	Offset Divisional Islands	2.3.6.8
Figure 2.3.6.7	Curbed Islands - No Shoulder	2.3.6.11
Figure 2.3.6.8	Curbed Island - Outside Shoulder	2.3.6.12
Figure 2.3.7.1	Turning Roadway With Spirals	2.3.7.3
Figure 2.3.7.2	Yield Taper at Channelized Intersection, Major Roadway to Minor Roadway	2.3.7.5
Figure 2.3.7.3	Lane Drop, Dual Lane Right-Turning Roadway	2.3.7.6
Figure 2.3.8.1	Left-Turn Lane, Pictorial Description of Terms	2.3.8.2
Figure 2.3.8.2	Left-Turn Lanes at T-Intersections	2.3.8.4

Figure 2.3.8.3	Left-Turn Lane at Cross-Intersection	2.3.8.5
Figure 2.3.8.4	Left-Turn Lane and Taper with Symmetrical Reverse Curves	2.3.8.6
Figure 2.3.8.5	Left-Turn Lanes in Two Directions	2.3.8.8
Figure 2.3.8.6	Left-Turn Lane Designs Along Four-Lane Undivided Roadways, No Median	2.3.8.9
Figure 2.3.8.7	Introduced Raised Median	2.3.8.10
Figure 2.3.8.8	Turning Lane Design, Raised Median	2.3.8.12
Figure 2.3.8.9	Left-Turn Slip Around Design - Tangent Alignment	2.3.8.13
Figure 2.3.8.10	Painted Left-Turn Lanes, Four-Lane Undivided Roadway	2.3.8.14
Figure 2.3.8.11	Left-Turn Lane Design, Four-Lane Undivided Roadway T- Intersection	2.3.8.16
Figure 2.3.8.12	Opposing Left-Turn Lane Design, Four-Lane Undivided Roadway Cross Intersection	2.3.8.16
Figure 2.3.8.13	Turning Paths of Double Left-Turn Lanes	2.3.8.17
Figure 2.3.8.14	Double Left-Turn Lane Configurations	2.3.8.18
Figure 2.3.8.15	Triple Left-Turns	2.3.8.21
Figure 2.3.8.16	Typical Slot Left-Turn Lane Designs	2.3.8.23
Figure 2.3.8.17	Volume Warrant for Slot Left-Turn Lane	2.3.8.25
Figure 2.3.8.18	Intersections on Curve	2.3.8.27
Figure 2.3.9.1	Transition Between Undivided Four-Lane Roadway and Two-Lane Roadway Intersection	2.3.9.1
Figure 2.3.9.2	Transition between Four-Lane Divided and Two-Lane Roadway Merge	2.3.9.2
Figure 2.3.10.1	Widening Through a Signalized Intersection	2.3.10.2
Figure 2.3.12.1	Geometric Elements of a Roundabout	2.3.12.2
Figure 2.3.13.1	Restrictions on the Proximity of Intersections and Entranceways to Unrestricted Grade Crossing	2.3.13.2

Figure 2.3.2.9 Relationship of Speed, Radius and Superelevation Through Intersections

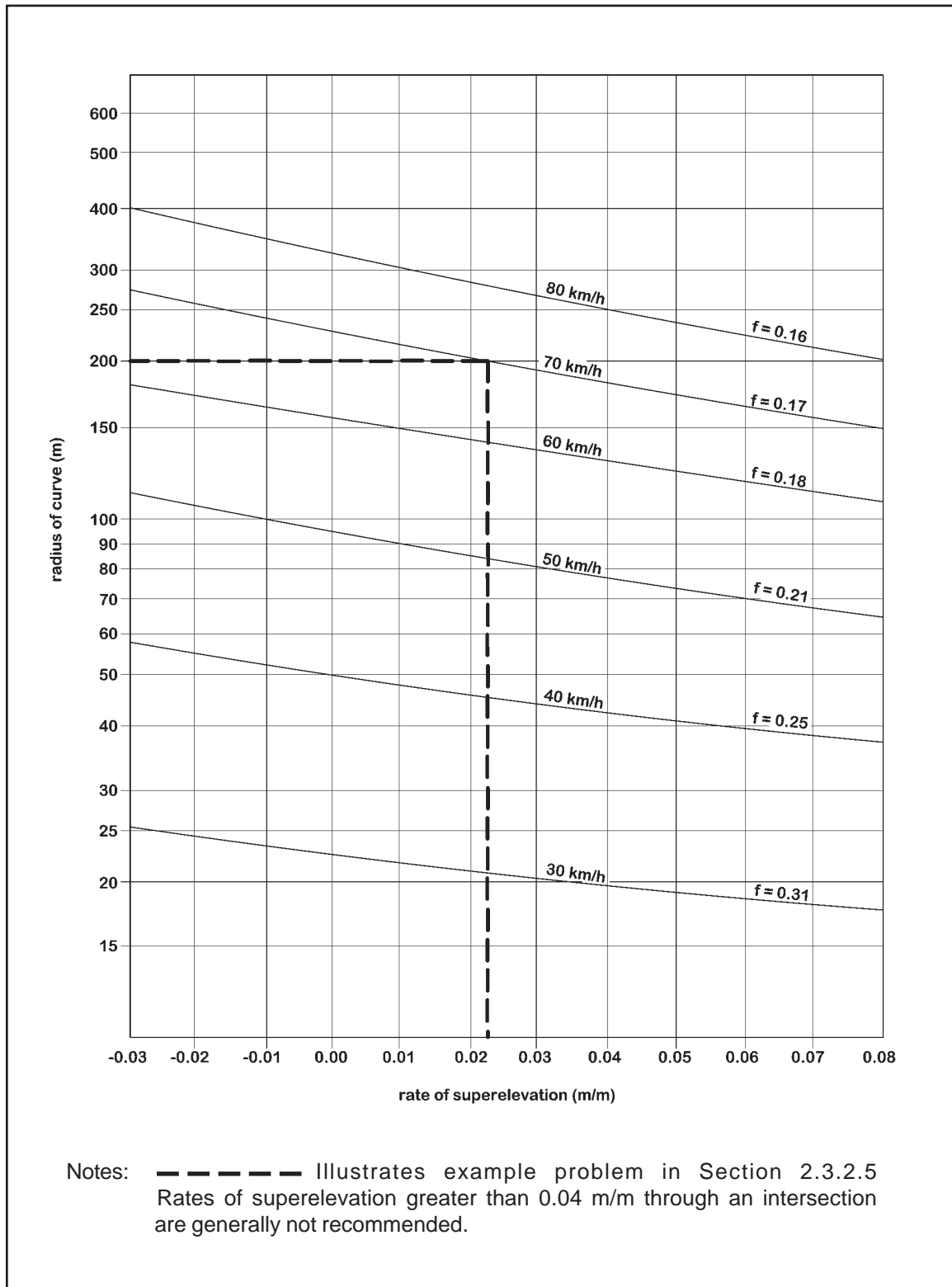


Table 2.3.2.1 Design Values for Rate of Change of Cross-Slope for Intersection Areas

Change in Rate of Superelevation	Design Speed (km/h)			
	< 40	40	50	> 50
m/m/40 m length	0.10	0.09	0.08	0.07
m/m/10 m length	0.03	0.022	0.020	0.016

There are physical and operational constraints that limit how and to what extent the through roadway pavement is transitioned from the superelevated section to normal crown at the intersections; the designer should determine the “best fit” that minimizes safety risks and local right of way impact at a reasonable cost based on the methods described in this section.

Too great a difference in cross-slope may cause vehicles travelling over the ridge formed between the through pavement and the auxiliary lane pavement downstream of the turning roadway to sway with possible hazard (see Subsection 2.3.2.3).

In some cases, such as the retrofitting of an intersection in a built-up area, the use of superelevation on a main line curve may not be possible due to existing physical controls, and retaining a normal crown may represent the optimum configuration. The selection of the most appropriate cross-slope or superelevation rate is based on the specific conditions at the intersection such as physical vertical controls and the principal traffic movements. In many cases it is advantageous to explore the opportunity to provide at least 0.02 m/m of superelevation (reverse crown) on the curved roadway to enhance the safe operation of through traffic.

Reducing or eliminating superelevation along main line curves through intersection areas and along turning roadways assists in providing reasonable operating conditions for turning vehicles. Drivers travelling through an intersection area typically reduce their speed due to the presence of a conflict zone. For this reason, reduced superelevation is generally not

detrimental to effective operation through the intersection.

2.3.2.6 Realignments for Retrofit

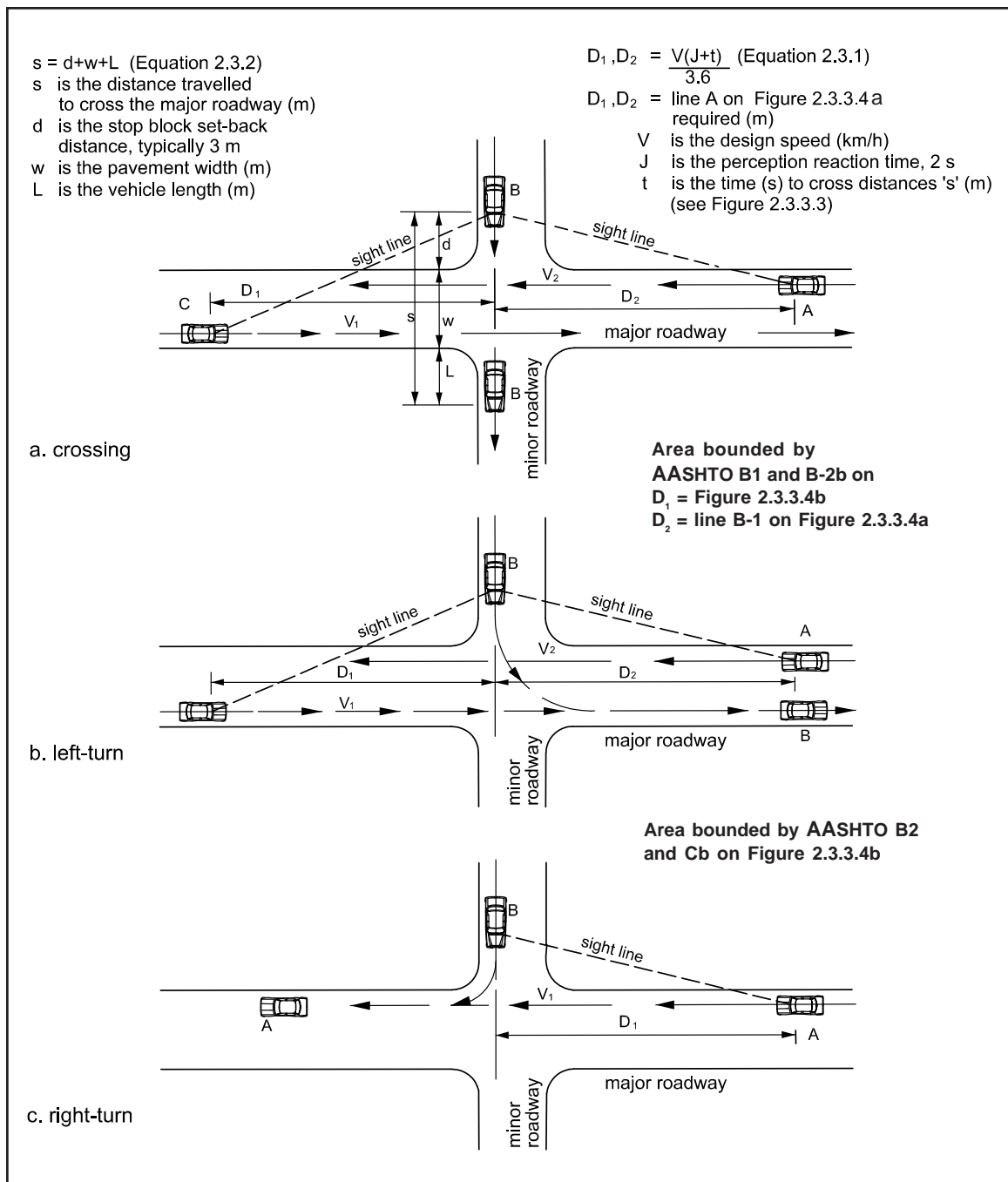
An existing urban intersection may undergo a retrofit for a variety of reasons including:

- elimination or reduction of a geometric condition(s) contributing to vehicular traffic or pedestrian safety problems
- increasing capacity by adding through or turning lanes and/or improved channelization

When an intersection retrofit is undertaken, the initial objective is generally to eliminate elements that cause unsafe operating conditions. Consideration is also given to upgrading all elements within current design domain. A detailed review of the collision history at the intersection is often beneficial in identifying geometric elements that may be contributing to undesirable operating conditions.

Examples of common types of intersection retrofitting related to operational concerns are as follows:

- improving intersection skew angles
- flattening or eliminating horizontal curves through or approaching the intersection
- regrading the intersection area or the approaches to improve sight lines
- adjusting the approach profiles to provide flatter grades where vehicles start and stop

Figure 2.3.3.2 Departure Sight Triangles


*In urban situations, the distance “d” may be governed by adjacent view obstructions.

Note: Sight line set-back distance is typically between 4.4 m and 5.4 m from the edge-of-traveled lane.

traffic control may be required to improve traffic operation.

2.3.3.3 Sight Distance Requirements for Specific Traffic Control Devices

No Control

Uncontrolled intersections are typically only used in urban areas under low-speed, low-volume conditions, such as, at the intersection of lightly travelled local roads or public lanes, where the following conditions exist:

- the total AADT for the intersection is 1000 -1500 vehicles (i.e. vehicles from both intersecting roadways)
- the safe approach speed (based on available stopping sight distance) is approximately equal to or greater than the 85 percentile speed or the speed limit whichever is less
- collision history indicates two or less right angle collisions per year¹

In general it is preferable to provide positive regulation of right of way at intersections. Where an intersection is not controlled by yield signs, stop signs, or signals, the driver on each intersection approach should, at a minimum, be able to perceive a potential conflict in sufficient time to alter the vehicle speed before reaching the intersection to avoid a collision. The approach sight triangle is illustrated on Figure 2.3.3.1, which also includes the geometric parameters of the sight triangle. A time of 3.0 s, which includes 2.0 s for perception and reaction and an additional 1.0 s to decelerate or accelerate to avoid collision, is the limiting condition in providing an appropriate sight triangle for the design of intersections with no control. The

distance travelled by the approaching vehicles at their assumed speeds set the limits of the sight triangle. Table 2.3.3.1 provides the rounded distances that vehicles travel during 3.0 s at various approach speeds. Intersections with no control operating at speeds higher than that shown in the table are not typical in both urban and rural areas.

Intersections with approach sight triangles with dimensions approximately equal to those indicated are not necessarily collision free. An unfamiliar driver may not realize the intersection is uncontrolled and may not proceed with caution. There is also potential for confusion when a driver on one roadway is confronted with a succession of vehicles on the intersecting roadway. Even where only one vehicle on each of the adjacent legs approaches an intersection, both vehicles may begin to slow down and reach the intersection at the same time. This occurrence, however, is slight because of the great number of speed change possibilities, the time available, and the normal decrease in speed as an intersection is approached under such conditions. In addition, a vehicle approaching an uncontrolled intersection must yield the right of way to vehicles approaching the intersection on the right. Where the minimum triangle described above cannot be provided, traffic control devices should be introduced to slow down or stop vehicles on one roadway even if both roadways are lightly travelled.

For uncontrolled crossings, drivers on both roadways should be able to see the intersection and the traffic on the intersecting roadway in sufficient time to stop before reaching the intersection. The safe stopping distances for intersection design are the same as those used for design in any other section of roadway. Chapter 1.2 provides stopping sight distance guidelines.

Table 2.3.3.1 Distance Travelled in 3.0 s

Speed (km/h)	15	20	25	30	35	40	45	50	55	60
Rounded Distance (m)	15	15	20	25	30	35	40	40	45	50

It is assumed that vehicles will seldom be required to stop at uncontrolled intersections. However, in the event that a vehicle has to stop, the sight distance requirements for departure would be the same as those shown for stop control.¹

Yield Control

In this design condition, the minor roadway is posted with a yield sign where it intersects the major roadway. Vehicles on the minor roadway controlled by a yield sign typically approach the controlled intersection at a reduced speed.

The yield control condition is most applicable to the intersection of a roadway with a local road, or, a local road with a collector under the following conditions:

- the total AADT entering the intersection is 1500 - 3000 vehicles (i.e. vehicles from both intersecting roadways)
- the approach speed (based on available stopping sight distance) is equal to or greater than 20 km/h
- a history indicates three or more right-angle collisions per year where there has been no previous control¹

The minimum approach sight triangle for a yield control intersection is established by determining the following:

- the minimum stopping sight distance at a reduced speed along the controlled minor roadway
- the minimum stopping sight distance along the uncontrolled roadway

Suggested speeds on the yield controlled approach are:

- urban conditions - 20 km/h
- rural conditions - 30 or 40 km/h

Again, it is preferable to provide for decision sight distance rather than stopping sight distance.

See Chapter 1.2 for the stopping sight distances relating to these speeds.¹

To account for the situation where a vehicle on the minor roadway is required to stop, the sight line for the departure from the minor roadway onto or across the major roadway is established in the same manner as for the stop control intersection as below in Stop Control.

Stop Control

For a stopped vehicle the departure sight distance is considered for each of the three basic manoeuvres that may occur at an intersection. Figure 2.3.3.2 illustrates the three possible manoeuvres. These manoeuvres are:

- to travel across the intersecting roadway by clearing traffic on both the left and right of the crossing vehicle without interfering with the passage of the through traffic
- to turn left onto the intersecting roadway by first clearing traffic approaching from the left, and then to accelerate to the normal running speed of the vehicles from the right, without interfering with the passage of the through traffic
- to turn right onto the intersecting roadway by entering the traffic stream approaching from the left and accelerate so as to not cause interference with the through traffic stream

a) Crossing Sight Distance

The sight distance for a crossing manoeuvre is based on the time it takes for the stopped vehicle to clear the intersection and the distance that a vehicle would travel along the major roadway at its design speed in that amount of time. As such, the required crossing time depends upon the perception and reaction time of the crossing driver, the vehicle acceleration time, the width of the major roadway, the length of the crossing vehicle and the speed of an approaching vehicle on the major roadway.

The required minimum departure sight distance along the major roadway is given by the expression:

$$D = \frac{V(J+t)}{3.6} \quad (2.3.1)$$

Where:

- D = minimum crossing sight distance along the major roadway from intersection (m)
- V = design speed of the major roadway (km/h)
- J = perception and reaction time of crossing driver (s)
- t = time (s) to cross the major roadway "s"

The time J is that needed for the driver to look in both directions along the major roadway, shift gears if necessary and prepare to start. Some of these operations are done simultaneously by many drivers, and some operations, such as shifting gears, may be done before looking up or down the roadway. Even though most drivers may require only a fraction of a second, a value of J should be used in design to represent the time taken by the slower driver. A value of 2.0 s is assumed.¹¹

The time t is given for a range of crossing distances, s, by the curves for four design vehicles in Figure 2.3.3.3.¹⁰ The crossing distance is computed using the formula:

$$s = d + w + L \quad (2.3.2)$$

Where:

- s = distance travelled during acceleration (m)
- d = distance from near edge of pavement to front of stopped vehicle (m), generally assumed to be 3.0 m
- w = width of pavement along the path of the crossing vehicle (m)

L = overall length of the crossing vehicle (m)

Empirical studies of minimum gaps required by drivers to enter or cross a moving traffic stream from a stopped position have shown that the average driver requires a six second (6 s) gap between vehicles in the moving stream. This value varies with the behaviour of local drivers, and is verified for the area in which the design is being taken. The value of (J + t) is not less than 6 s. Crossing sight distance is also provided on Figure 2.3.3.4 as Line A.

In the case of divided roadways, widths of median equal to or greater than the length of vehicle (L) enable the crossing to be made in two steps. The vehicle crosses the first pavement, stops within the protected area of the median opening, and then awaits an opportunity to complete the second crossing step. For divided roadways with medians less than L, the median width is included as part of the w value.

A correction for the effect of grade on acceleration time can be made by multiplying by a constant ratio to the time (t) as determined for level conditions. Ratios of the accelerating time on various grades to those on the level are shown in Table 2.3.3.2. The adjusted value of t can then be used to determine the minimum crossing sight distance.

Table 2.3.3.2 Ratios of Acceleration Times on Grades

Design Vehicle	Cross Road Grade, %				
	-4	-2	0	+2	+4
Passenger Car	0.7	0.9	1.0	1.1	1.3
Single Unit Truck	0.8	0.9	1.0	1.1	1.3
Tractor-Semitrailer	0.8	0.9	1.0	1.2	1.7

Figure 2.3.3.3 Assumed Acceleration Curves (Acceleration From Stop Control on Minor Road)¹⁰

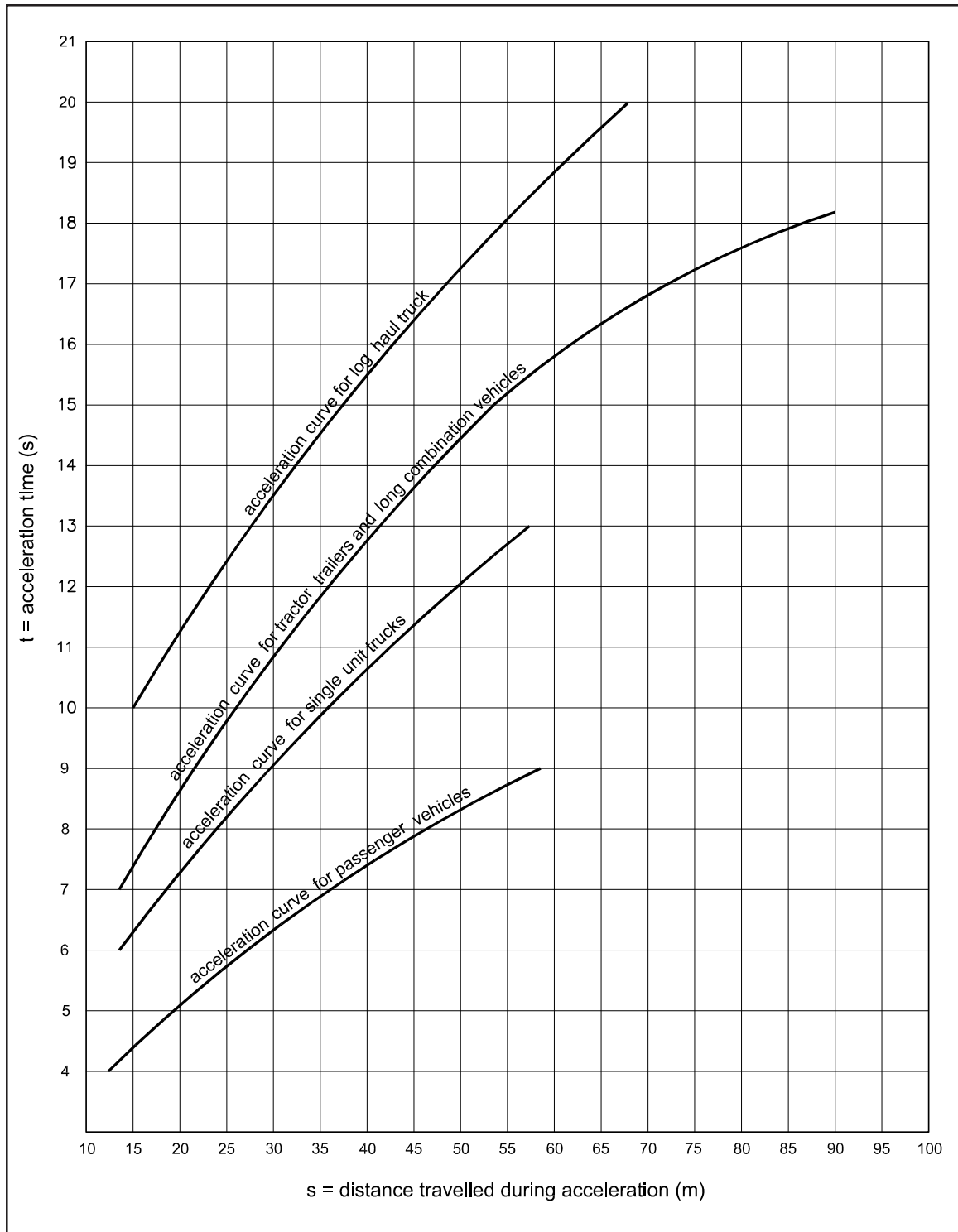


Figure 2.3.3.4a Sight Distance for Crossing Movements and Vehicles Turning Left across Passenger Vehicle approaching from the Left

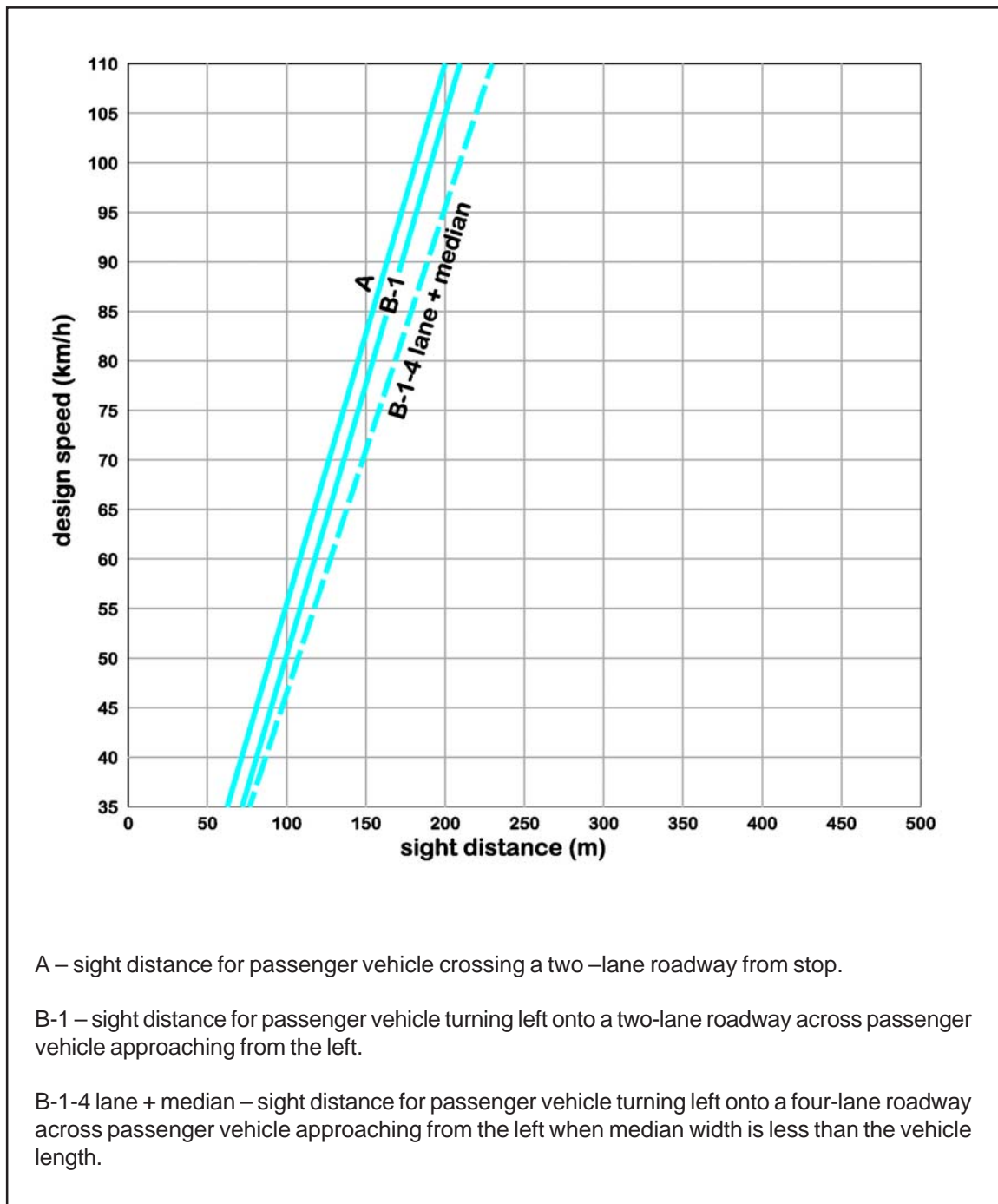
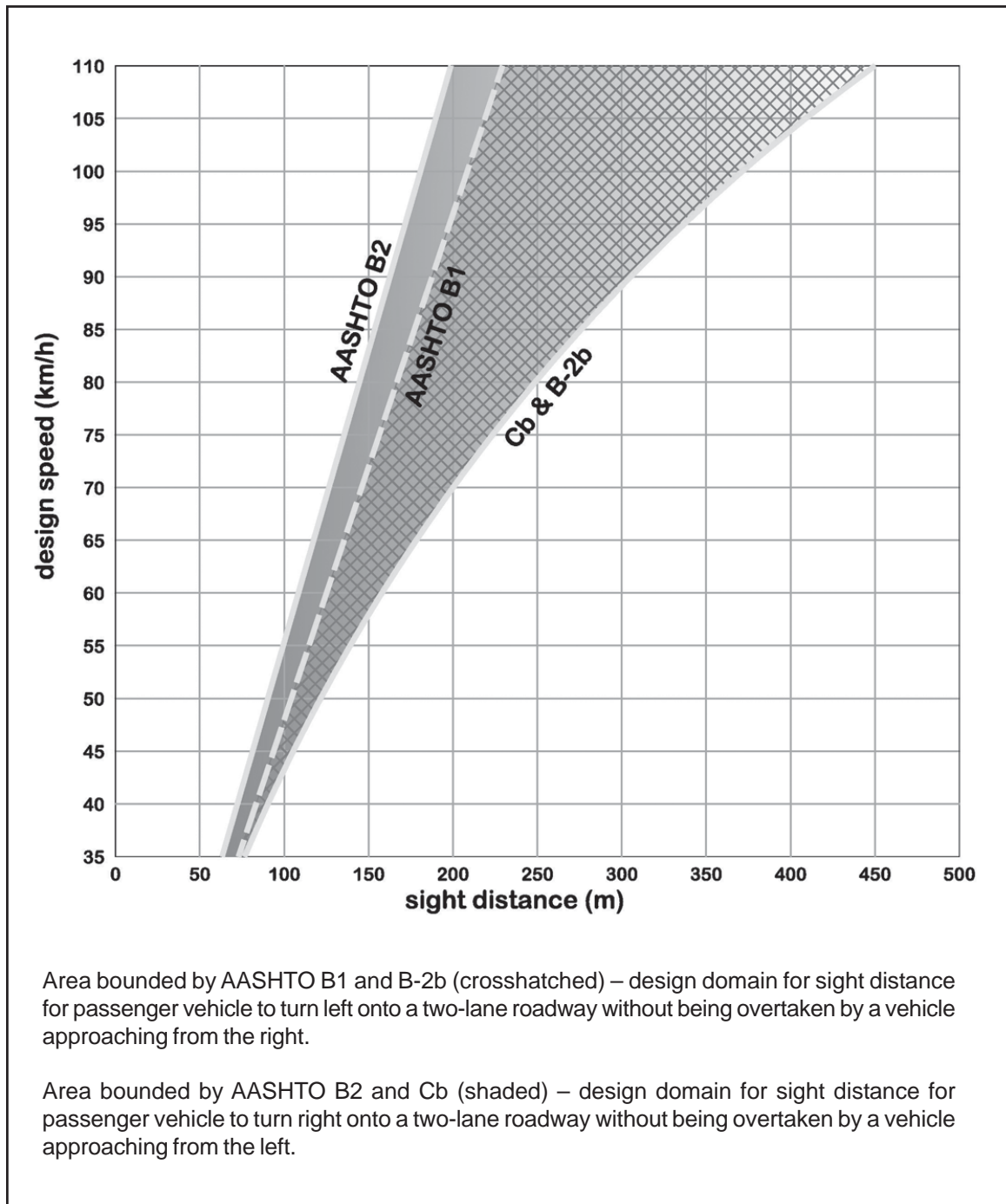


Figure 2.3.3.4b Sight Distance for Turning Movements with Vehicles approaching in the Intended Direction of Travel



b) Turning Sight Distance

Sight distance for turning movements is normally measured from the height of the turning vehicle driver's eye to the top of the approaching vehicle. However, a driver cannot clearly detect the presence of an approaching vehicle until some part of the vehicle is visible. It is prudent to take the sight line to the approaching vehicle at some depth below the top of the vehicle. This depth might vary with distance from the through vehicle. A depth of 150 mm below the top will usually alert the turning driver to the presence of a through vehicle. See Chapter 1.2 for vehicle height. The increased driver height for trucks is beneficial for sight distance on crest curves.

As illustrated in Figure 2.3.3.2, sufficient sight distance must be provided for vehicles turning from the minor road onto the major road under each of the following three scenarios:

- Vehicles turning left onto the major roadway with traffic approaching from the left.
- Vehicles turning left onto the major roadway with traffic approaching from the right.
- Vehicles turning right onto the major roadway with traffic approaching from the left.

The required sight distance under the first scenario is determined using line B-1 in Figure 2.3.3.4a. Sufficient sight distance must be provided such that the turning vehicle will avoid interruption of through traffic approaching from the left.

For divided roadways, the width of the median determines if the left-turn manoeuvre is considered as one or two manoeuvres. If the median width is less than the length of the design vehicle, the sight distance required is based on a single manoeuvre. For this condition, line B-1 would not be sufficient, since it is based on an undivided two-lane roadway. Additional sight distance is needed at a divided highway with a narrow median to account for the extra distance required for the vehicle to cross the additional lanes and the median, as part of the left turn manoeuvre. The sight distance for a passenger vehicle to turn left onto a four-lane roadway

across a passenger vehicle approaching from the left is shown on Figure 2.3.3.4a as a dashed line (B-1-4 lane + median).

The other two turning scenarios require that additional sight distance be provided such that the turning vehicle can attain a desired percentage of the mainline design speed without being overtaken by a vehicle approaching in the intended direction of travel, which is simultaneously assumed to be operating at a slightly reduced speed. The required sight distance under both of these scenarios is determined using a design domain approach. The methodologies used to define both the lower and upper boundaries for the design domain are outlined in the following paragraphs.

Lower Boundary of Design Domain

The lower boundary of the design domain is based on empirical gap acceptance methodology presented in AASHTO's 2001 Policy on Geometric Design of Highways and Streets. Acceptable gaps were determined such that vehicles travelling on the major road need not reduce their speed to less than 70% of their initial speed. Field observations have shown that the values contained in Table 2.3.3.2a provide sufficient time gaps to meet this condition. Table 2.3.3.2a also includes appropriate adjustments to these time gaps to account for vehicle size, number of lanes on the major road, and approach grade on the minor road.

Using the appropriate time gap value, the intersection sight distance along the major roadway (in both directions) is determined by:

$$ISD = (V_{\text{major}} \times t_g) / 3.6 \quad (2.3.3)$$

where:

ISD = intersection sight distance

V_{major} = design speed of the major roadway (km/h)

t_g = time gap for turning vehicle from the minor roadway to enter the major roadway (s)

The intersection sight distance requirements for a passenger vehicle turning left onto a two-lane roadway without being overtaken by a vehicle approaching from the right is represented by line AASHTO B1 in Figure 2.3.3.4b. Similarly, the intersection sight distance required for a passenger vehicle to turn right onto a two-lane roadway without being overtaken by a vehicle approaching from the left is represented by line AASHTO B2.

Upper Boundary of Design Domain

The upper boundary of the design domain is based on a more theoretical application of the gap acceptance methodology, which provides more conservative values of sight distance. This methodology assumes that vehicles on the major roadway should not reduce their speed to less than 85% of the design speed, and that a gap of at least 2 seconds must be maintained between the turning vehicle and the approaching vehicle.

To determine sight distance, the first step is to establish the distance travelled by the turning vehicle in order to reach a speed equal to 85% of the mainline speed. Next, the distance that the approaching vehicle would travel in the same time plus 2 seconds (while slowing to 85% of the design speed) is determined. Finally, the required sight distance is calculated as the difference between the total distance traveled by the approaching vehicle and the distance travelled beyond the intersection by the turning vehicle.

Based on this methodology, the intersection sight distance requirements for a passenger vehicle turning left onto a two-lane roadway without being overtaken by a vehicle approaching from the right is represented by line B-2b in Figure 2.3.3.4b. Similarly, the intersection sight distance for a passenger vehicle to turn right onto a two-lane roadway without being overtaken by a vehicle approaching from the left is represented by line Cb.

The upper boundary of the design domain should also be adjusted for vehicles turning left onto divided roadways. A proxy adjustment can be made by substituting the appropriate time adjustments from Table 2.3.3.2a (0.5s or 0.7s) into Equation 2.3.3 and adding the result to the

sight distance determined from line B-2b on Figure 2.3.3.4b.

Heuristics

It is the designer's responsibility to use their discretion to select appropriate sight distances values from the design domain. An effort should be made to incorporate the upper boundary values of the design domain when providing such distance is a feasible option. Consideration should also be given to such factors as the classification of the roadway and the anticipated traffic growth rates. Maximum sight distance is desired on higher class roadways and in areas where high traffic volumes are present.

Table 2.3.3.2a Time Gap for Turning Movements from Stop

Design Vehicle	Time gap t_g (s)	
	Left-turn	Right-turn
Passenger car	7.5	6.5
Single-unit truck	9.5	8.5
Combination truck	11.5	10.5

Note: Time gaps are for a stopped vehicle to turn right or left onto a two-lane highway with no median and grades of 3 percent or less. The table values require adjustment as follows:

For multilane highways: Add 0.5 seconds for passenger cars or 0.7 seconds for trucks for each additional lane, in excess of one, to be crossed by the turning vehicle.

For minor road approach grades: If the approach grade is an upgrade that exceeds 3 percent; add 0.2 seconds for each percent grade for a left turning vehicle or 0.1 seconds for each percent grade for a right turning vehicle.

Note: Gap times should be increased where turning manoeuvres by long combination trucks (length greater than 23m) are common.

c) Other Considerations

While all vehicles must stop on the minor roadway at the stop controlled intersection, certain sight distances should be provided on the approach for the main roadway in the event a driver violates the stop sign.

The sight line property requirements for this condition and for the purpose of providing daylighting or visibility on a two- and four-lane roadway, can be derived from Table 2.3.3.3¹ for intersections having a 90° intersection angle. The size of the daylighting or visibility triangle is a function of the number and width of lanes, the various design speeds on the main roadway, 30 km/h on the minor roadway and the right-of-way widths on both roadways, see Figure 2.3.3.5¹.

The foregoing is based on the time criterion of 3 s for both the major and minor road approaches, permitting vehicles on both roadways to adjust speeds to avoid a collision.

Visibility triangle dimensions for skewed intersections for two- and four-lane roadways have to be determined by the designer using the same principles that were employed for a 90° intersection angle.

The controls, as applied to two-way stop controls, may be justified under any one of several conditions, as follows:

- at an intersection of a minor road with a major road
- at an intersection of an arterial road with a collector road or an arterial road with a local road unless other factors such as volume, collisions or delay dictate a higher type device (four-way stop control or traffic control signals)
- at an intersection with a collision experience of three or more right-angle collisions per year over a period of three years, where less restrictive measures have not been effective
- at an intersection with a total AADT in the range of 1500 to 8000 (these volumes may

be an indication of the need for two-way stop control; since these are above the volume range where yield signs may operate satisfactorily and may be below the minimum of the volume ranges required for four-way stop control or traffic signal control; if an AADT volume in excess of 1500 vehicles is evident at the intersection of two local roads, the road classification plan should be re-evaluated)

Signal Control

The sight distances and sight triangles required for intersections controlled by traffic signals are often determined in the same manner as those for stop control. Since the intersecting traffic flows at a signalized intersection move at separate times, theoretically, sight distance considering the minor roadway traffic is not a requirement. However, due to numerous potential operating conditions associated with signalized intersections, the sight distance for stop control is normally provided as a minimum. The signal operational conditions that support this practice include: signal malfunction, violation of the signal, right turns permitted on red, and the use of the flashing red/yellow signal mode.

It is a basic requirement for all signal-controlled intersections that drivers must be able to see the control device soon enough to perform the action it indicates (i.e. stopping sight distance for red phase).

The sight distance for right-turn movements on the red phase of a signal-controlled intersection is the same as for stop control.

2.3.3.4 Decision Sight Distance

Minimum stopping sight distance generally allows drivers to bring their vehicles to a stop. However, this distance is often inadequate when drivers must make instantaneous decisions, where information is difficult to perceive and interpret or unexpected manoeuvres are required. Drivers may require longer sight distances at critical locations, such as intersections where several sources of information compete, where the intersection is on or beyond a crest of a vertical curve, or, where there is substantial

Table 2.3.3.3 Minimum Property Requirements at 90° Intersections for Stop Control

two-lane roadway

design speed on major roadway (km/h)	approach distance 'a' based on 3 s (m)	visibility triangle : X & Y ^a											
		major roadway - right of way (m)											
		20		26		30		35		40		45	
		X	Y	X	Y	X	Y	X	Y	X	Y	X	Y
40	30	8	7	5	4	2	2	-	-	-	-	-	-
50	40	15	10	10	7	7	5	3	2	-	-	-	-
60	50	22	11	16	8	12	6	7	4	2	1	-	-
70	60	29	12	22	9	17	7	11	5	5	2	-	-
80	65	32	12	24	9	19	7	13	5	6	2	-	-
90	75	39	14	30	10	24	8	17	6	9	3	2	1
100	85	46	14	36	10	29	8	20	6	12	3	3	1
110	95	53	14	41	11	34	9	24	6	15	4	5	1

four-lane roadway

design speed on major roadway (km/h)	approach distance 'a' based on 3 s (m)	visibility triangle : X & Y ^a											
		major roadway - right of way (m)											
		20		26		30		35		40		45	
		X	Y	X	Y	X	Y	X	Y	X	Y	X	Y
40	30	13	11	9	8	7	6	4	3	1	1	-	-
50	40	21	13	16	10	13	8	9	6	5	3	1	1
60	50	29	15	23	12	19	10	14	7	9	5	4	2
70	60	38	16	30	13	26	11	20	8	14	6	8	3
80	65	42	16	39	13	29	11	22	9	16	6	9	4
90	75	50	17	47	14	35	12	27	9	20	7	12	4
100	85	58	17	48	14	47	12	33	10	24	7	16	5
110	95	66	17	55	14	47	12	38	10	28	7	19	5

Note : a. Refer to Figure 2.3.3.5.

Figure 2.3.3.5 Sight Distance and Visibility Triangle at 90° Intersections for Approaches with Stop Control¹

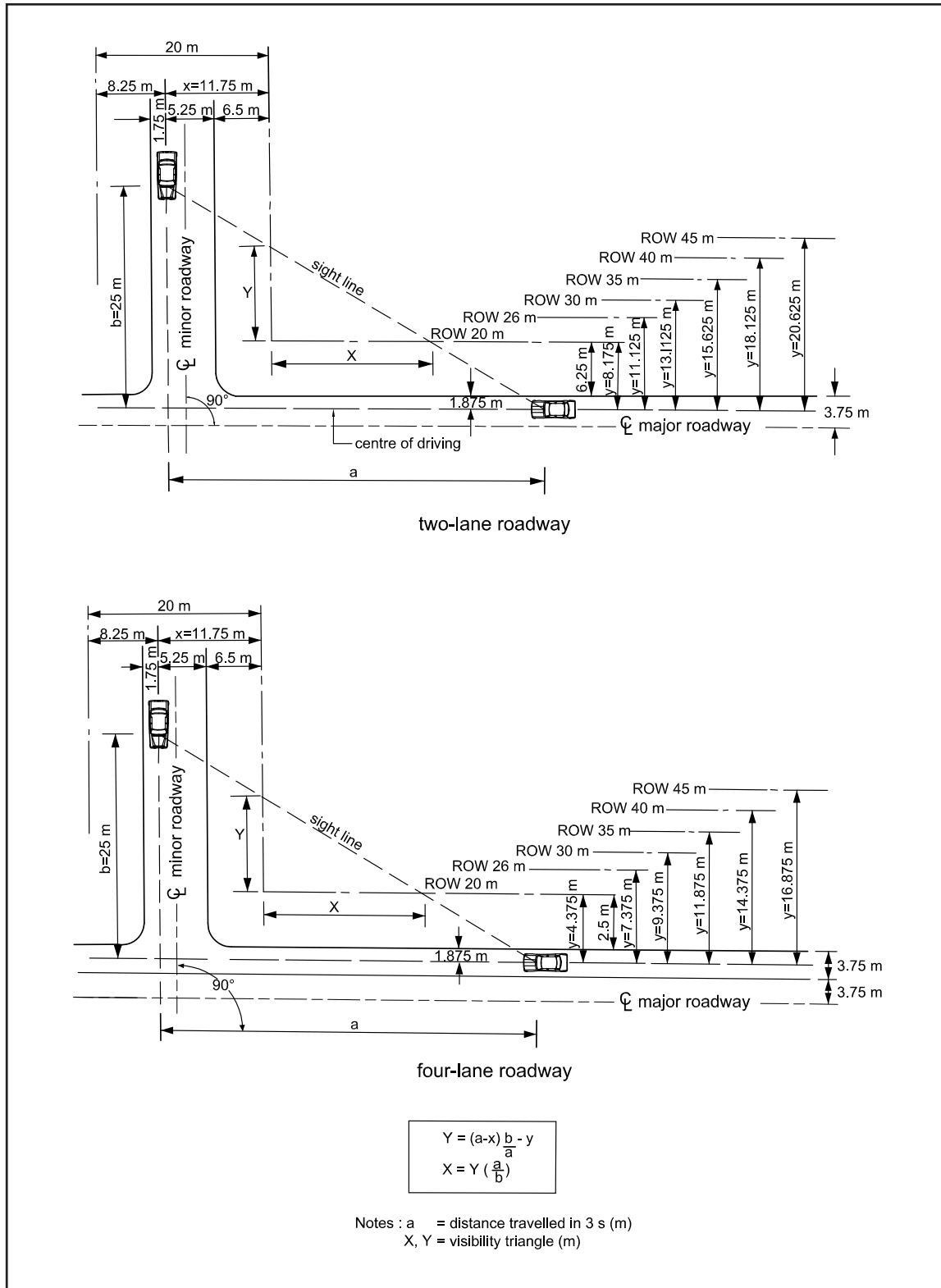


Table 2.3.3.4 Summary Table for Design of Sight Distance at Intersections

Intersecting Road	Sight Distance for Intersection Approaches			
	No Control	Yield Control	Stop Control	Signal Control
Minor Roadway	distance travelled in 3 s at design speed to decision sight distance	stopping sight distance (Urban 20 km/h; Rural 30 or 40 km/h) to decision sight distance	distance travelled in 3 s at design speeds to decision sight distance	distance travelled in 3 s at design speeds to decision sight distance
Major Roadway	distance travelled in 3 s at design speed to decision sight distance	stopping sight distance for the design speeds to decision sight distance	distance travelled in 3 s at design speeds to decision sight distance	distance travelled in 3 s at design speeds to decision sight distance
Intersecting Road	Sight Distance for Intersection Departures			
	No Control	Yield Control	Stop Control	Signal Control
Minor Roadway	stop control applies	stop control applies	stop control applies	stop control for right turns on red
Major Roadway	stop control applies	unrestricted open roadway condition applies		stop control for right turns on red

Table 2.3.3.5 Sight Distance for Left Turns at Unsignalized Interchange Ramp Terminals

Assumed Design Speed on Minor Roadway (km/h)	Sight Distance ^a (m) Required to Permit Design Vehicles to Turn Left and Clear Approaching Vehicle from Left		
	Passenger Vehicle	Single Unit Truck	Tractor-Trailers
50	95	150	195
60	115	180	235
70	135	210	275
80	150	240	315
90	170	270	355
100	190	300	395

Note: a) Refer to Figure 2.3.3.7.

The sight distance requirements defined in Table 2.3.3.5 are checked against both the vertical alignment design of the cross road and the horizontal sight triangle. The horizontal sight triangle is affected by the visual obstruction created by the railing or parapet of the bridge structure. The two sight distance requirements are illustrated on Figure 2.3.3.7.

horizontal curvature on the approach to the intersection area.

Decision sight distances provide designers with values for appropriate sight distance at such critical locations and serve as criteria in evaluating the suitability of the sight lengths at these locations. If it is not feasible to provide these distances because of horizontal or vertical curvature, special attention should be given to the use of traffic control devices for providing advance warning of the conditions to be encountered.

A range of decision sight distance values has been developed, see Figure 2.3.3.6.¹ The range recognizes the variation in complexity that may exist at various sites.

Decision sight distance is based on pre-manoeuvre and manoeuvre times converted into distance and verified empirically. Pre-manoeuvre is the time required for a driver to process information relative to a hazard. It consists of:

- detection and recognition
- decision and response initiation times

Manoeuvre time is the time to accomplish a vehicle manoeuvre. For design purposes the calculated values are rounded.

For measuring decision sight distance, the height of eye of 1.05 m is typically used, and the height of object of 0.38 m (legislated minimum height of tail lights) is typically used. For some locations, depending on the anticipated prevailing conditions, the height of object may be the roadway surface, in which case the object height should be 0 m¹ (see Chapter 1.2).

2.3.3.5 Summary

Table 2.3.3.4 summarizes the above discussion on sight distance at intersections relating to the four cases: no control, yield control, stop control and signal control.

2.3.3.6 Sight Distance at Bridge Structures

Where a bridge is located close to an at-grade intersection, such as at the intersection of an interchange ramp with a cross road adjacent to an overpass, particular attention is required to ensure adequate sight distance is provided. This is due to the potential visual obstruction created by the bridge railing or other structural components. The typical critical factor, at a ramp intersection, is the sight distance required for the left-turning vehicle departing from the ramp to clear the traffic approaching from the left on the cross road. If the intersection is signalized, the minimum critical sight distance is then the distance needed for vehicles turning right, off the ramp, to clear vehicles approaching from the left. However, as previously discussed, for signalized intersections, it is desirable to provide the left turning and crossing manoeuvre sight distance associated with stop control to account for possible signal malfunctions or similar conditions.

Using the acceleration time required to travel these distances, derived from the graphs on Figure 2.3.3.3¹⁰ and a perception/reaction time of 2.0 s, the sight distance required for the departure manoeuvre can be calculated. It is assumed that the distances travelled by vehicles turning left from the ramp onto the cross road¹, before clearing the travel lane occupied by a vehicle approaching from the left, are approximately 18 m for passenger vehicles, 28 m for single unit trucks and 37 m for tractor-trailer. The sight distances required for the three vehicle types and a range of approach speeds on the cross roadway are given in Table 2.3.3.5.

The sight distances defined in Table 2.3.3.5 are checked against both the vertical alignment design of the cross road and the horizontal sight triangle. The horizontal sight triangle is affected by the visual obstruction created by the railing or parapet of the bridge structure. The two sight distances are illustrated on Figure 2.3.3.7.

For the vertical alignment check, the assumed height of eye for the turning vehicle is 1.05 m for a car and up to 2.4 m for a large truck (see Chapter 1.2). The object height in all cases is

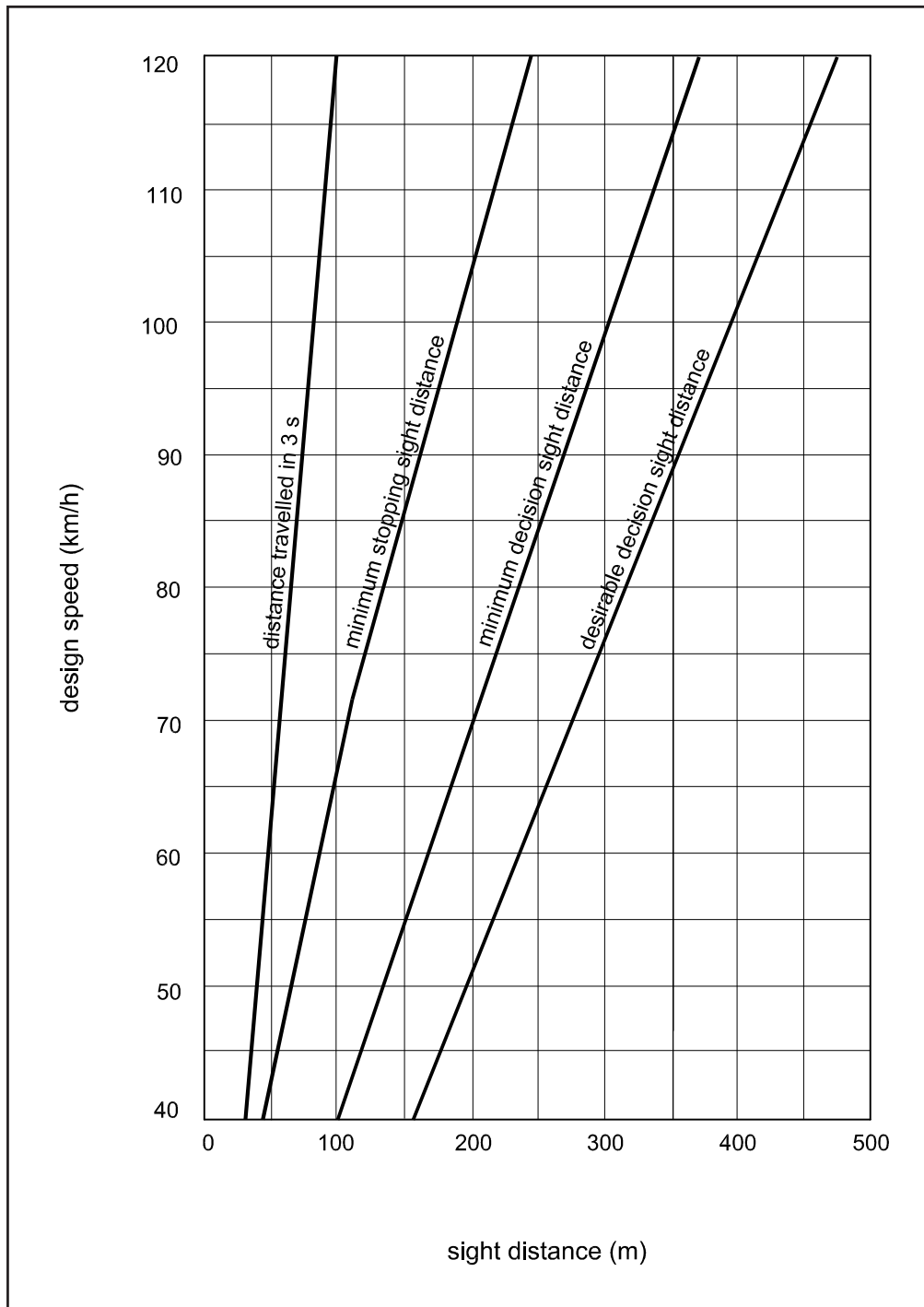
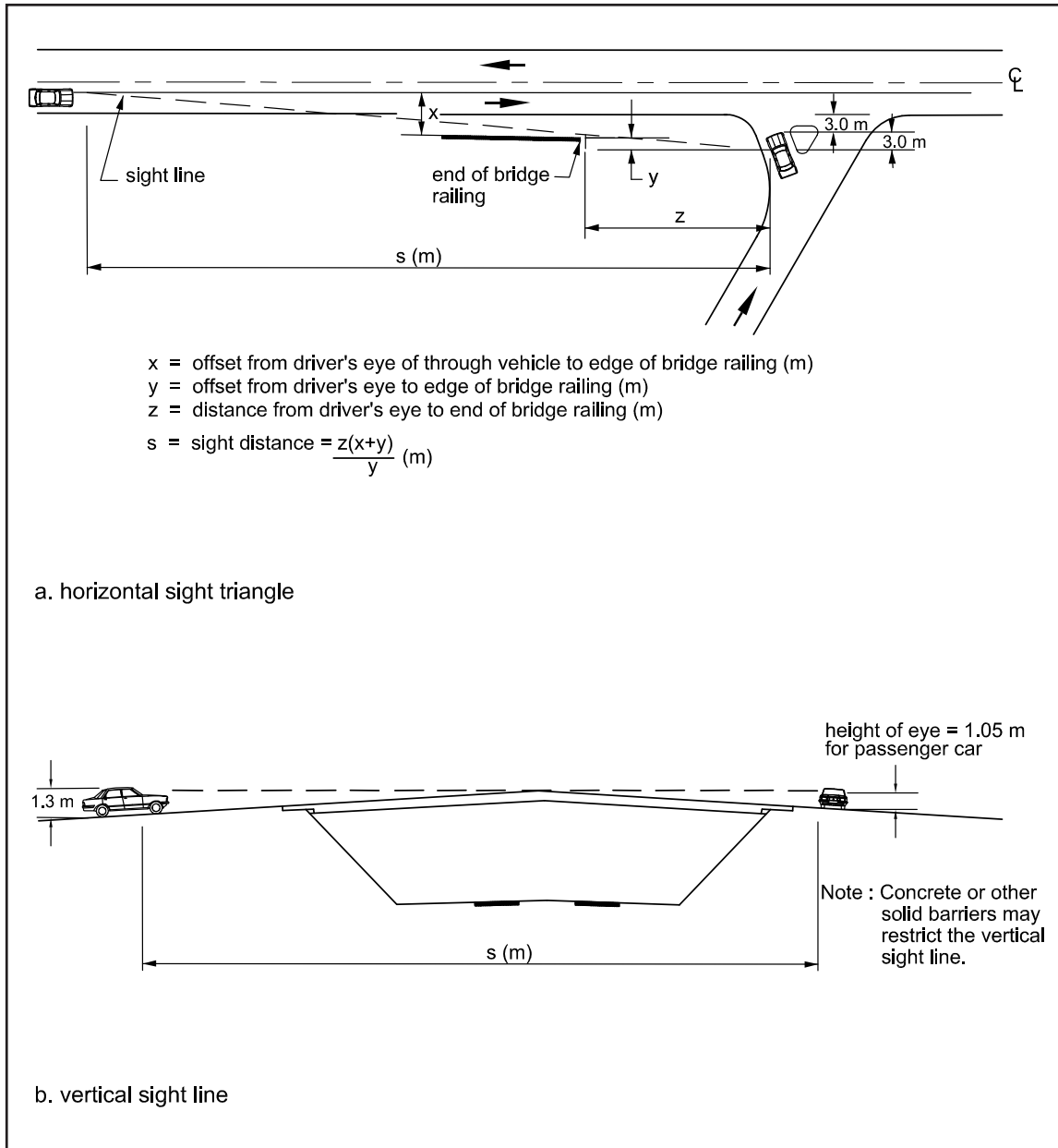
Figure 2.3.3.6 Decision Sight Distance¹


Figure 2.3.3.7 Measurement of Sight Distance at Ramp Terminals Adjacent to Overpass Structures



assumed to be 1.3 m, the assumed height of a passenger car. Where concrete or similar solid barriers are used along the cross roadway, particularly where the cross roadway alignment includes a crest vertical curve, the possible restrictions on sight-line are taken into account in determining the available sight distance.

For the horizontal sight triangle check, the location of the bridge railing or parapet of an overpass structure is often the critical factor for sight distance. In the case of a ramp terminal adjacent to an underpass structure, the bridge abutments or piers may be the limiting factors. Sight distance at the ramp terminals can be improved by increasing the lateral offsets from the cross roadway to the bridge railings, abutments or piers, or by increasing the distance between the ramp terminal intersection and the

structure. Where sufficient distance cannot be provided, traffic signals may be considered at the ramp terminal intersection to improve safety. In certain rare cases, the provision of mirrors can be reassuring and can reduce the problem of perceived lack of sight distance.

For other intersections adjacent to bridge structures, the critical sight distance factors vary with the actual physical roadway layout, traffic control and traffic patterns.

2.3.3.7 Sight Distance at Railway Crossings

Refer to Section 2.3.13.

2.3.12 ROUNDABOUTS

2.3.12.1 Introduction

Approximately one-half of the collisions on the North American road system occur at intersections,²⁰ where drivers are confronted with through, right-turn, and left-turn manoeuvres, and where capacity is restricted. Attempts to provide greater safety for motorists at these points began in the 1930s and 1940s with the construction of traffic circles in several jurisdictions. However, as a result of design differences and inconsistencies in assigning right of way and non-uniform signing, these circles did little to promote safety and moreover, they tended to constrict traffic flow.²⁰

The roundabout, a variation of the traffic circle, may provide a solution to these problems in some instances. In Western Europe and Australia, where this type of intersection is commonly found, changes in roundabout design, along with changes in traffic regulations, have noticeably increased road safety and capacity. Now many road engineers in North America have become supporters of roundabouts as a means to reduce collisions and improve traffic flow.²⁴

2.3.12.2 Roundabout Characteristics

Roundabouts are distinguished from traffic circles by their operational and design characteristics. The key operational feature is that traffic must yield at entry to traffic already within the roundabout. Deflection of a vehicle's path at entry and exit is an important design feature. Other salient design characteristics are entry angles of between 20 and 60 degrees; crosswalks upstream of the yield line; the absence of parking in the roundabout; and splitter islands, which reduce speed, deter left turns, and provide refuge to pedestrians, at all approaches.

Figure 2.3.12.1 illustrates a number of these significant characteristics. Definitions for each parameter shown are outlined as follows:

D - Inscribed Diameter is the diameter of the largest circle that can be inscribed within the intersection outline.

R - Entry Radius is measured as the minimum radius of curvature of the nearside curb at entry.

E - Entry Width is measured from the point A along a line perpendicular to the nearside curb.

V - Approach Half Width is measured at a point in the approach upstream from any entry flare, from the centreline to the nearside curb, along a perpendicular line to the curb face.

\emptyset - Entry Angle serves as a geometric proxy for the conflict angle between entering and circulating streams.

l^1 - The Average Effective Flare Length is found as shown in Figure 2.3.12.1.

The line GF'D is the projection of the nearside curb from the approach towards the yield line, parallel to the median HA and at a distance of V from it.

BA is the line along which E is measured (and is therefore normal to GBJ), m and thus D is at a distance of [E-V] from B.

The line CF¹ is parallel to BG (the nearside curb) and at a distance of [E-V]/2 from it. Usually the line CF¹ is therefore curved and its length is measured along the curve to obtain l^1 .¹³

2.3.12.3 Categories of Roundabouts

Roundabouts are typically categorized by the Inscribed Diameter (D). Table 2.3.12.1 summarizes typical D ranges for single lane roundabouts for each category, the environment they are typically used in, and the recommended maximum entry speed.

Figure 2.3.12.1 Geometric Elements of a Roundabout

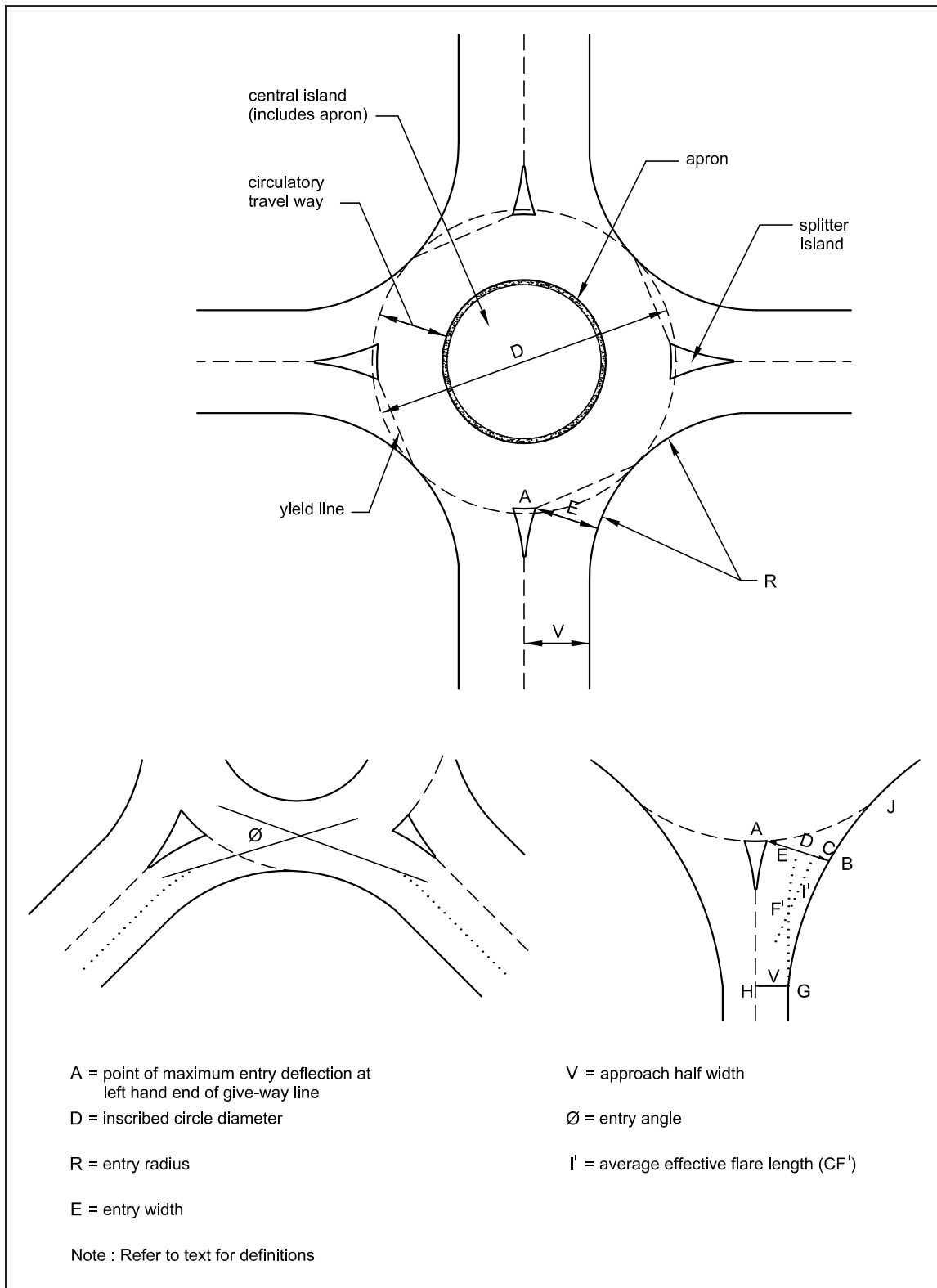


Table 2.3.12.1 Roundabout Categories

Category	Inscribed Diameter (D) (m)	Environment	Recommended entry speed (km/h)
Mini-roundabout	12 to 24	Urban	25
Small roundabout	24 to 30	Urban	25
Medium roundabout	30 to 40	Urban	35
	34 to 50	Rural	40
Large roundabout	40 to 54	Urban	40
	50 to 60	Rural	50

2.3.12.4 Typical Range of Geometric Parameters

A number of design references are available to assist designers in the design process.^{25, 26, 27} Table 2.3.12.2 summarizes the typical range of key geometric parameters involved with a roundabout.

Table 2.3.12.2 Typical Range of Geometric Parameters

Geometric Parameter	Typical Range
Entry Path Curvature	60 to 100 m radius
Entry and Exit Width	4 to 5 m – one lane roundabout 7 to 8 m – two lane roundabout
Circulatory Roadway Width	1 to 1.2 times the Entry Width

In some cases, design guides²⁷ are intended to address the movement of large trucks and may specify an Inscribed Diameter and other geometric parameters outside of these ranges.

2.3.12.5 Location/Application of Roundabouts

The decision to provide a roundabout rather than some other form of junction should be based on

operational, economical and environmental considerations. A roundabout can be used to:

- signify a significant change in road classification (ie. from a divided to an undivided roadway or from a grade separated intersection to an at-grade intersection), although complete reliance should not be placed on the roundabout alone to act as an indicator to drivers
- emphasize the transition from a rural to an urban or suburban environment
- accommodate very sharp changes in route direction which could not be achieved by curves, even of undesirable radii
- provide a greater measure of safety at sites with high rates of right-angle, head-on, left/through, and U-turn collisions
- replace existing all-way stop control
- accommodate locations with low or medium traffic volumes, instead of signals

Roundabouts should be sited on level ground preferably, or in sags rather than at or near the crests of hills because it is difficult for drivers to appreciate the layout when approaching on an up gradient. However, there is no evidence that roundabouts on hill tops are intrinsically dangerous if correctly signed and where the visibility standards have been provided on the approach to the yield line. Roundabouts should

not normally be sited immediately at the bottom of long descents where the down grade is significant for large vehicles and loss of control could occur.

Roundabouts may not be effective when the flow of heavy vehicles is great or long delays on one approach exists.

2.3.12.6 Geometry/Road Capacity

As noted above, roundabouts can improve road safety and increase capacity. Table 2.3.12.3 provides a summary of the relationship between geometric parameters and capacity.

Capacity is very sensitive to increases in the approach width V . This is normally the half width of the approach roadway and can only be increased if sufficient roadway width allows the centreline to be offset.

The entry geometry is defined by the entry width E and the flare length l' . Capacity is extremely sensitive to increase in either, and considerable scope exists for increasing capacity by various combinations.

Increasing the entry radius R above 20 m only improves capacity very slightly. However, as values drop below 15 m capacity reduces at an increasing rate.

The entry angle ' \emptyset ' is fixed by the alignment of the approach roadways and there is, therefore, little scope for varying ' \emptyset ' sufficiently to have a significant effect on capacity.

Table 2.3.12.3 Geometry/Capacity Relationships

Increase Parameter		Capacity Change
the approach width	V	rises rapidly
the entry width	E	rises rapidly
the flare length	l'	rises slowly
the entry angle	\emptyset	drops slowly
the inscribed circle diameter	D	rises slowly
the entry radius	R	rises slightly

When designing a roundabout the approach width is a known fixed value. The capacity is thereafter almost totally determined by the entry width and the flare length, as typical values of the other geometric parameters have only a minor influence.

Reducing the inscribed circle diameter reduces capacity. If, however, by reducing the inscribed circle radius an increase in the entry geometry can be achieved, then a large net increase in capacity is produced; very small, mini or micro roundabouts (diameter less than 4 m) are the limiting case. As the entry width increases, the entry deflection is reduced and consideration should be given to safety.

Increasing the number of entry lanes or increasing the width of these lanes has the potential for increased traffic conflict. Widening entry lanes is a concern for the safety of cyclists.

2.3.12.7 Safety Analysis

Recent research in Europe has shown that collision rates can be decreased by replacing conventional intersections with roundabouts. The Netherlands achieved a 95% reduction in injuries to vehicle occupants at locations where roundabouts were installed.²⁰ On inter-urban roads in France, the average number of collisions resulting in injuries was 4 per 100 million vehicles entering roundabouts, compared with 12 per 100 million vehicles entering intersections with stop or yield signs. The safety of roundabouts, installed mostly in France's urban and suburban areas, including residential areas, was generally superior to that of signalized intersections.²⁰ Researchers noted that large roundabouts with wide entries and heavy bicycle traffic appeared to be less safe than other roundabouts. In Germany the number of collisions was 1.24 per 1 million vehicles entering small roundabouts, compared with 3.35 for signalized intersections, and 6.58 for old traffic circles.²⁰ In Norway an extensive collision analysis also revealed that roundabouts are safer than signalized intersections. The number of collisions resulting in injuries was 3 per 100 million vehicles entering three-legged roundabouts and 5 per 100 million vehicles entering signalized three-legged (T-) intersections; it was 5 for four-legged

roundabouts and 10 for four-legged (cross-) intersections (with and without signals).²⁰

In the United States, a recent study confirms the safety benefits of roundabouts. An investigation of six sites in Florida, Maryland and Nevada revealed that the conversion of T- and cross-intersections (stop controlled and signalized) to roundabouts decreased collision rates.²⁰ According to the study, which was sponsored by the Federal Highway Administration, the reduction was statistically significant.

Given that roundabouts have only recently begun to appear in North America, roadway agencies have had little opportunity to gather empirical data on the safety benefits of the structures. Fortunately, similarities between collision-prediction models developed in the United Kingdom for roundabouts and those developed in the United States for cross-intersections allow agencies to compare in theory the safety of both types of intersections. Both the U.K. and the U.S. models yield estimates of collisions resulting in nonproperty damage.²⁰ In addition, both models use state-of-the-art regression analysis (Poisson and negative binomial) and samples of sufficiently large size to relate collisions to particular roadway characteristics. On the basis of these similarities, one could draw the conclusion that roundabouts in the United States have the potential to increase safety when compared with conventional intersections, just as they are projected to do in the United Kingdom.

Nevertheless, notwithstanding their good record, great care should be taken in layout design to secure the essential safety aspects. The most common problem affecting safety is excessive speed, both at entry or within the roundabout. The most significant factors contributing to high entry and circulating speeds are:

- inadequate entry deflection
- a very acute entry angle which encourages fast merging manoeuvres with circulating traffic
- poor visibility to the yield line

- poorly designed or positioned warning and advance direction signing
- “Reduce Speed Now” signs, where provided, being incorrectly sited
- more than four entries leading to a large configuration

Additionally, safety aspects to be considered in designing a layout include the following:

1. Angle between legs: The collision potential of an entry depends on both the angle counter clockwise between its approach leg and the next approach leg, and the traffic flows. A high-flow entry should have a large angle to the next entry, and a low-flow entry a smaller angle in order to minimize collisions.
2. Gradient: While it is normal to flatten approach gradients to about 2% or less at entry, research at a limited number of sites has shown that this has only a small beneficial effect on collision potential.
3. Visibility to the left at entry: This has comparatively little influence upon collision risk; there is nothing to be gained by increasing visibility above the recommended level.

Care should be taken with the choice of curb type for roundabout design. A safety problem can arise when certain specialized high profile curbs are used around a central island as they can be a danger to vehicles over running the entry.

Observations have shown that these curbs can result in loss of control or overturning of vehicles unless the approach angle is small and actual vehicle speeds are low. Where high profile curbs are to be used on approaches, the curbs can be hazardous for pedestrians and consideration should be given to the provision of handrails to control pedestrian movements.

High circulatory speeds cause associated entry problems and normally occur at large roundabouts with excessively long and/or wide

circulatory travel way. However, these problems can also be caused at smaller roundabouts by inadequate deflection at previous entries. The solution to high circulatory speeds usually has to be fairly drastic, involving the signalization of problem entry legs at peak hours. In extreme cases the roundabout may have to be converted to a “ring junction” in which the roundabout is made two-way and the entries/exits are controlled by individual mini or normal roundabouts, or traffic signals.

If entry problems are caused by poor visibility to the left, good results can be achieved by moving the yield line forward in conjunction with curtailing the adjacent circulatory hatching or extension of the traffic deflection island.

One note of caution should be sounded - the safety record of roundabouts for one group of road users is mixed. Pedestrians using roundabouts have long been considered at least as safe as those using conventional intersections because the prevailing speed is slower, and the islands provide refuge from automobile traffic. However, many countries have documented increases in collisions involving bicyclists after roundabouts were installed. On the other hand, the Netherlands reported a decrease of 1.3 to 0.37 injuries per year to bicyclists at 181 conventional intersections converted to mini-roundabouts.²⁰

REFERENCES

1. Geometric Design Standards for Ontario Highways, Ontario Ministry of Transportation, 1985.
2. Manual of Uniform Traffic Control Devices for Canada, Transportation Association of Canada, 1998.
3. Kuciemba, S. R., Cirillo, J. A., Safety Effectiveness of Highway Design Features, Volume V: Intersections, Publication No. FHWA-RD-91-078, US Department of Transportation, Federation Highway Administration, November 1992.
4. Accident Facts, 1968 and 1988 Editions, National Safety Council, Chicago, IL, 1968 and 1988.
5. Neuman, T. R., Jack E. Leisch and Associates, Intersection Channelization Design Guide, National Co-operative Highway Research Board (Report 27a), National Research Council, Evanston, Illinois, November, 1985.
6. Jack E. Leisch & Associates, Planning and Design Guide for At-Grade Intersection, 1978.
7. Hanna, J. T., Flynn, T. E. and Webb, L. T., Characteristics of Intersection Collisions in Rural Municipalities, Transportation Research Record 601, Transportation Research Board, 1976.
8. David, N. A., Norman, J. R., Motor Vehicle Collisions in Relation to Geometric and Traffic Features of Highway Intersections: Vol. II – Research Report, Report No. FHWA-RD-76-129, Federal Highway Administration, July 1979.
9. Parker, M. R., et al., Geometric Treatments for Reducing Passing Collisions at Rural Intersections on Two-Lane Highways: Vol. I – Final Report, Report No. FHWA/RD-83/074, Federal Highway Administration, September 1983.
10. Highway Geometric Design Guide, Alberta Transportation and Utilities, 1995
11. A Policy on Geometric Design of Highways and Roadways, American Association of State Highway and Transportation Officials (AASHTO), 1994
12. Harwood, D.W., et al., Median Intersection Design, NCHRP Report 375, National Co-operative Highway Research Program, Transportation Research Board, National Research Council, 1995.
13. Design Manual for Roads and Bridges, Vol. 6, Section 2, Part 3, Geometric Design of Roundabouts, Department Standard No. TD 1693, Department of Transportation, U.K., September 1993.
14. Crown, R. B., RODEL – An Alternative Approach to Roundabout Design Highway and Transportation, Vol. 34, No. 10, Journal of the Institute of Highways and Transportation, U.K., October 1987.
15. Guide for the Design of Roadway Lighting, Transportation Association of Canada, 1982.
16. Road/Railway Grade Crossing Manual, Transport Canada, 1997.
17. Canadian Capacity Guide for Signalized Intersections, 2nd Edition, Institute of Transportation Engineers, June 1995.
18. Traffic Control Signal Timing and Capacity Analysis at Signalized Intersections, Ontario Ministry of Transportation, December 1989.
19. Kenneth Ackeret, Criteria for the Geometric Design of Triple Left-Turn Lanes, ITE Journal, Volume 64, Number 12, December 1994.
20. Bared, J., Roundabouts Improving Road Safety and Increasing Capacity, TR News, No. 191, Transportation Research Board, July-August 1997.

21. Canadian Guide to Neighbourhood Traffic Calming, Transportation Association of Canada, 1998.
22. Highway Capacity Manual, Special Report 209, Transportation Research Board, National Research Council, 1994.
23. Design Vehicle Dimensions for Use in Geometric Design, Transportation Association of Canada, 1997.
24. Synthesis of North American Roundabout Practice, Transportation Association of Canada, 2008
25. National Cooperative Highway Research Program Report 672 "Roundabouts: An Informational Guide, Second Edition" Transportation Research Board, Washington, D.C., 2010
26. Roundabouts: A Different Type of Management Approach, Ministère des Transports du Québec (MTQ), 2005
27. B.C. MoT Supplement to the TAC Geometric Design Guide, 2007

barriers; bridge rails and transitions; and end treatments. Discussions of the design domains for each of these barrier types are presented in each individual section, and in keeping with traffic barrier design procedures, generally address:

- technology overview
- design domain: warrants
- design domain: selection criteria
- design domain: placement guidelines

In this Guide discussion on specific barrier technologies is limited to general coverage of generic barrier types to clarify overall design questions. Barrier technologies are constantly being refined and further developed. Designers should maintain currency in the availability and characteristics of specific technologies on an ongoing basis.

In addition to the design domain discussions, worked examples of the application of the design principles are provided.

Technology Overview

In accomplishing their task of guiding and redirecting impinging vehicles, a roadside barrier must balance the need to prevent penetration of the barrier with the need to protect the occupants of the vehicle. Various barrier technologies achieve this in various ways, but they can be grouped into three distinct types:

1. Flexible systems result in larger lateral barrier deflections, but the smallest vehicle deceleration rates. Such systems have application in places where a substantial area behind the barrier is free of obstructions and/or other hazards within the zone of anticipated lateral deflection. These barrier types usually consist of a weak post-and-beam system, and their typical design deflections are in the range of 3.2 m to 3.7 m. Designers must familiarize themselves with, and design to, the specific performance characteristics of their selected or candidate technologies.

2. Semi-rigid systems provide reduced lateral barrier deflections, but higher vehicle deceleration rates. These barrier systems have application in areas where lateral restrictions exist and where anticipated deflections must be limited. They usually consist of a strong post-and-beam system and have design deflections ranging from 0.5 m to 1.7 m. Designers must familiarize themselves with, and design to, the specific performance characteristics of their selected or candidate technologies.
3. Rigid systems usually taking the form of a continuous concrete barrier. These technologies result in no lateral deflection, but impose the highest vehicle deceleration rates. They are usually applied in areas where there is very little room for deflection or where the penalty for penetrating the barrier is very high. Numerous shapes are available including a higher version for use where there is a high percentage of trucks.

Typical examples of these barrier technologies are summarized in Table 3.1.6.1.

Embankment Warrants

Roadside hazards that warrant shielding by a barrier include embankments and roadside obstacles. In the past, techniques for determining barrier need for embankments generally used embankment height and side slope as the key parameters in the warrant analysis, and essentially compared the collision severity of hitting a barrier with the severity of going down an embankment.

Warrant nomographs can be developed using collision prediction and cost-effectiveness analysis techniques which do consider both the probability of an encroachment occurring as well as the relative cost-effectiveness of shielding versus not shielding⁴. In general, such warrants are agency specific since they must reflect unique local conditions, collision cost factors and agency policies. Examples of such a warrant procedure are shown in Figure 3.1.6.1. They are examples from specific jurisdictions and are neither a general warrant nor are they applicable to all types of barrier (e.g. cable barriers) and are not intended for general use.

Table 3.1.6.1 Examples of Roadside Barrier Technologies

Flexible Systems	Semi-rigid Systems	Rigid Systems
3-strand cable	Blocked-out W beam (strong post)	Concrete safety shape
W-beam (weak post)	Blocked-out thrie beam (strong post)	Stone masonry wall
Thrie-beam (weak post)	Modified thrie beam	
Box beam (weak post)	Self-restoring barrier (SERB)	
	Steel-backed wood rail	

As noted earlier, the development of new cost effectiveness analysis techniques provides designers with a preferred option for evaluating the need for roadside barriers. The techniques represent a considerable improvement over the general nomograph approach, since they provide designers with the ability to consider site-specific factors in their analysis. They are strongly recommended to designers concerned with making the most cost-effective use possible of their roadside improvement and protection budgets.

Roadside Obstacle Warrants

Man-made and natural roadside obstacles can be classed as either non-traversable terrain or fixed objects, and their character and presence directly define needs for shielding. Warrants for shielding should be developed using a quantitative cost-effectiveness analysis which accounts for the obstacle characteristics and its likelihood of being hit.

Table 3.1.6.2 provides an overview of the types of non-traversable terrain and fixed objects which are normally considered for shielding. This table is presented as a general guide to discerning situations in which cost-effectiveness analysis of shielding should be carried out but is not a substitute for that analysis.

A number of application heuristics should be considered when the shielding of roadside obstacles is being considered.

1. Shielding non-traversable terrain or a roadside obstacle is usually only warranted when it is in the clear zone and cannot be economically removed, relocated, or made breakaway, and a barrier provides a safety improvement over the unshielded condition.
2. Collision experience at the site (or a comparable site) should be used to help decide on the placement or omission of a barrier in marginal cases.
3. In practice, few traffic signal supports are shielded.

Pedestrians and Bicycle Warrants

In some situations, a measure of physical protection may be required for pedestrians or bicyclists using, or in close proximity to, a major street or highway. Examples of such cases could include: a barrier adjacent to a school boundary or property to minimize potential vehicle contact; shielding businesses or residences near the right of way in locations where there is a history of run-off-the-road collisions; or separating pedestrians and/or cyclists from vehicle flows in circumstances where high-speed vehicle intrusions onto boulevards or sidewalk areas might occur.

In all these cases, conventional criteria will not serve to provide warrants for barriers, and the designer must be cognizant of the needs and circumstances of the individual situation when deciding on appropriate action.

Figure 3.1.6.1 Sample Embankment Warrant Guides^{20,21}

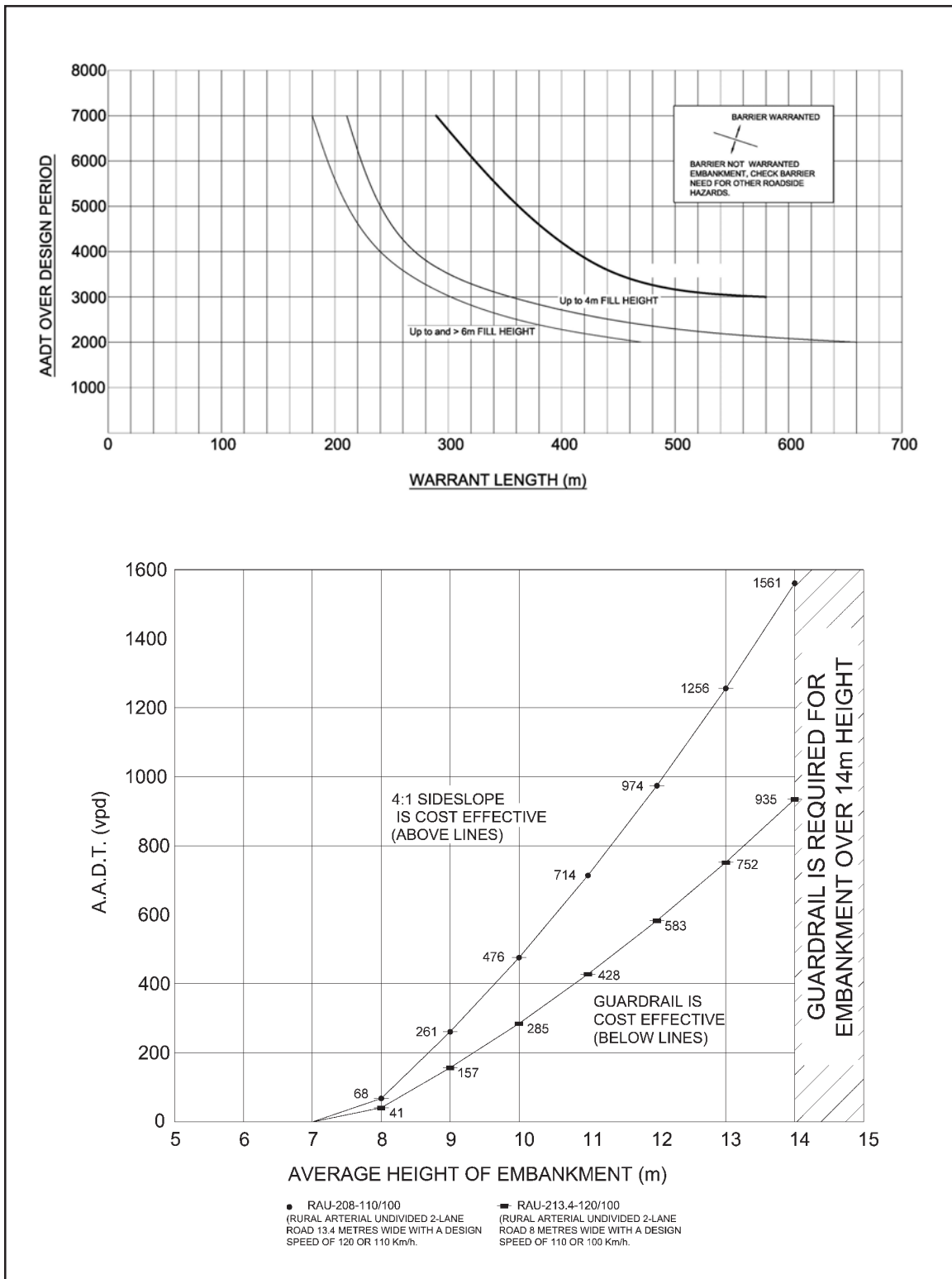


Table 3.1.6.2 Roadside Obstacles Normally Considered for Shielding

Terrain or Obstacle	Comment
Bridge piers, abutments, railing ends	Shielding analysis generally required
Boulders	Judgement: nature of object: likelihood of impact
Culverts, pipes & headwalls	Judgement: based on size, shape, location
Cut slopes (smooth)	Shielding analysis not generally required
Cut slopes (rough)	Judgement: based on likelihood of impact
Ditches (parallel)	Refer to earlier section on drainage channels
Ditches (transverse)	Analysis generally required if head-on impact likelihood is high
Embankments	Judgement: based on fill height and slope
Retaining walls	Judgement: based on wall smoothness and angle of impact
Sign, luminaire supports	Shielding analysis for non-breakaway supports
Traffic signal supports	Shielding analysis for isolated signals in the clear zone on high speed (80 km/h or greater) facility
Trees	Judgement: site specific
Utility poles	Judgement: case by case basis
Permanent bodies of water	Judgement: depth of water, likelihood of encroachment

Barrier Selection Criteria

Once a barrier need has been established, a specific barrier technology must be chosen for the application. Since each installation is unique, and given the complexity of the road environment, there is no simple "recipe" for selecting the correct barrier technology to use in any given situation. Nonetheless, there are well established criteria that designers should consider when reaching this decision, with the ultimate goal being to choose the system that provides the required degree of shielding at the lowest overall cost. Table 3.1.6.3 can be used as a guide to this selection process.

must consider several factors in specifying the final layout. These include:

- lateral offsets from the edge of travelled way
- terrain effects
- flare rate
- length of need

A set of design domain placement heuristics developed from various literature sources is provided below which cover most typical issues arising from the design of roadside barrier installations.

Placement Heuristics

A typical roadside barrier installation and its associated elements for a two-lane, two-way road is illustrated in Figure 3.1.6.2.

Having decided that a barrier is warranted and chosen the appropriate technology, the designer

Lateral Offsets

1. In general roadside barrier should be placed as far from the travelled way as conditions permit, in order to provide greater recovery area for errant vehicles and sight distance, particularly at intersections. However, roadside barriers should not usually be

REFERENCES

1. Final Report: Improving Roadway Safety: Current Issues. Roadway Safety Foundation. Washington, D.C. February, 1997.
2. Sanderson, R. "Fixed Objects - The North American Perspective". Paper presented at the 1996 AQTR Symposium on Fixed Objects and Road Safety. May, 1996.
3. "Roadside Safety Issues" Transportation Research Circular 435. TRB, Washington, DC. 1995. P.8.
4. Roadside Design Guide, American Association of State Highway and Transportation Officials. Washington, D.C. 1996.
5. Turner, D.S., Hall, J.W., "Severity Indices for Roadside Features: A Synthesis of Highway Practice". NCHRP Synthesis of Highway Practice 202. Transportation Research Board. Washington, D.C. 1994.
6. Mak, K.K., Sicking, D.L., Zimmerman, K. "Roadside Safety Analysis Program (RSAP) - A Cost Effectiveness Analysis Procedure". Preprint of paper presented at 77th Annual Meeting of the Transportation Research Board. Washington, D.C. 1998.
7. Highway Design and Operational Practices Related to Highway Safety. American Association of State Highway and Transportation Officials. Washington, D.C. 1974.
8. Standard Specifications for Structural Supports for Highway Signs, Luminaires, and Traffic Signals. American Association of State Highway and Transportation Officials. Washington, D.C. 1994.
9. Guide for Erecting Mailboxes on Highways. American Association of State Highway and Transportation Officials. Washington, D.C. 1994.
10. Traffic Manual, Section 1-04: Nomenclature: CALTRANS, Sacramento CA. 1978.
11. Ray, M.H., McGinnis, R. "Guardrail and Median Barrier Crashworthiness" NCHRP Synthesis 244 Transportation Research Board. Washington, D.C. 1997.
12. "Recommended Procedures for the Safety Performance Evaluation of Highway Features". National Cooperative Highway Research Program (NCHRP) Report No. 350. Transportation Research Board. Washington, D.C. 1993.
13. Roadside Safety Manual. Ministry of Transportation of Ontario. Toronto, Ontario. 1993.
14. Standard Specifications for Highway Bridges. American Association of State Highway and Transportation Officials. Washington, D.C. 1996.
15. Guide Specifications for Bridge Railings. American Association of State Highway and Transportation Officials. Washington, D.C. 1989.
16. Design of Highway Bridges CAN/CSA-S6-88. Canadian Standards Association. Toronto, Ontario, 1988.
17. Prioritized Contract Content Guidelines. Ministry of Transportation of Ontario. St. Catharines, Ontario. 1997.
18. Riggs, J.L., Rentz, W.F., Kahl, A.L., West, T.M. "Engineering Economics". McGraw-Hill Ryerson Limited. Toronto, Ontario. 1986.
19. deLeur, P., Abdelwahab, W., Navin, F. "Evaluating Roadside Hazards Using Computer-Simulation Model", ASCE, Journal of Transportation Engineering, Vol. 120, No. 2, March/April, 1994.

20. Roadside Barrier Warrant Manual. Nova Scotia Department of Transportation and Infrastructure, Halifax, Nova Scotia, 2003.

21. Roadside Design Guide. Alberta Infrastructure and Transportation, Edmonton, Alberta, 2007.