

FPInnovations



TM

Creating forest sector solutions

www.fpinnovations.ca



Connections in CLT Assemblies

Cross Laminated Timber Symposium
Vancouver, BC
February 8-9, 2011

M. Mohammad

Building Systems
Wood Products Division

Overview

- Importance of connections in CLT
- Common connection details/techniques in CLT assemblies: European experience
- Proposed European approach for connections design in CLT
- Adoption of European approach in NA design procedure
- Concluding remarks

Connections in CLT Assemblies



Source: Kevin Meehan
Courtesy WoodWorks



- A series of prefabricated CLT panels connected together on site to form an assembly or a building
- Quick on-site erection due to
 - High degree of prefab.
 - Ease of assembly using conventional & innovative fasteners

Outcome...



Remarkable low, mid & high-rise timber buildings that are pushing the envelope..

Why Connections are Important in CLT Assemblies?!

- Maintain structural integrity
- Provides ductility for lateral load design (e.g., seismic & wind)
- Affect the serviceability design (vibration, acoustics, etc.)
- May affect the fire safety design
- Interior and exterior finishing & building envelope
- Could control the level of prefab. at the mill
- Facilitates a quick assembly and disassembly (i.e., cost-competitiveness)

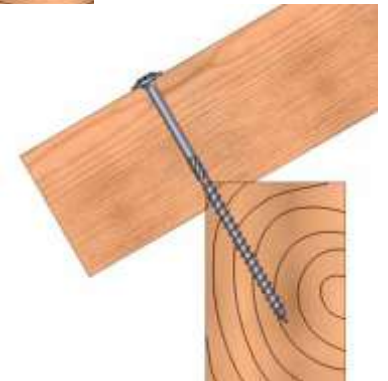
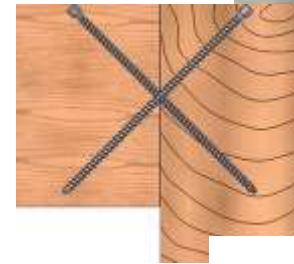

Source: Log & Timber Connections

Testing of Connections in CLT (CLT walls) FPInnovations

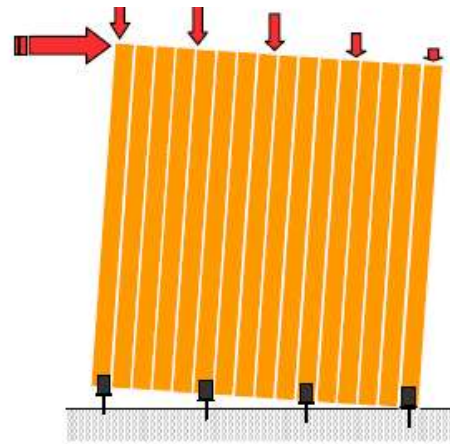

Seismic performance of CLT walls is governed by connections

Current CLT Connections Practice in Europe

- **Carpentry**

Using CNC technology to create various types of interlocking profiles (Dovetail connections)



- **Traditional fasteners**

Bearing or dowel type fasteners, i.e., nails, wood screws, lag screws & bolts, in combination with metal plates, brackets and ties.



- **Innovative/Proprietary**

Self-tapping screws & dowels, glued in rods, bearing-type systems, metal hooks, etc.



Source: Log & Timber Connections

Wood and Self Tapping Screws

- **Extensively used in Europe**
- Easy to install & provide high lateral & withdrawal capacity
- Come in a variety of sizes and features
 - Diameters from **4mm to 12mm**
 - Lengths up to **600mm**
- Do not require predrilling in most cases, (unlike traditional lag screws)
- Used for WW or WS connections



Source: SFSIntec



Source: Log & Timber Connections

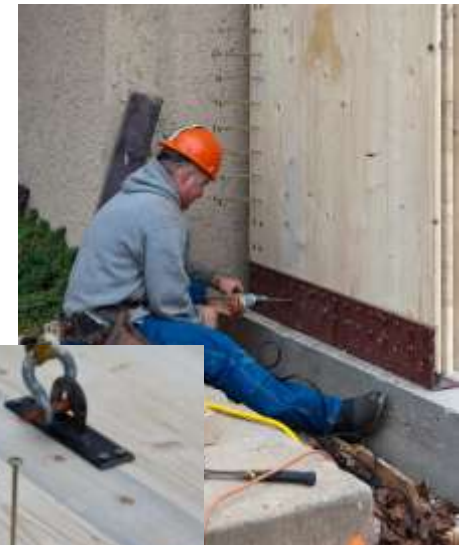

Source: Kevin Meechan
Courtesy WoodWorks

Traditional Fasteners in CLT

Nails and Rivets

- Not as commonly used as self tapping screws in CLT
- Nails with specific surface features such as grooved or helically threaded nails are the most commonly used
- Typically used in combination with metal plates and brackets



Why Connections in CLT are Different than those in Solid Timber or Glulam?!

Cross Lamination Effect

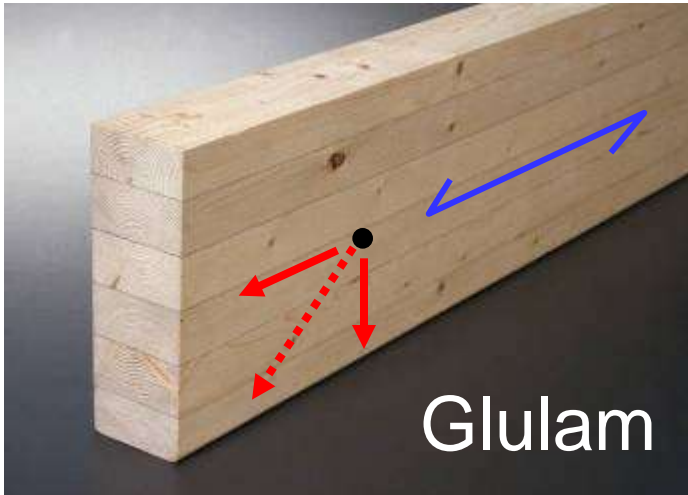

All laminates are aligned & loaded in the same direction ..

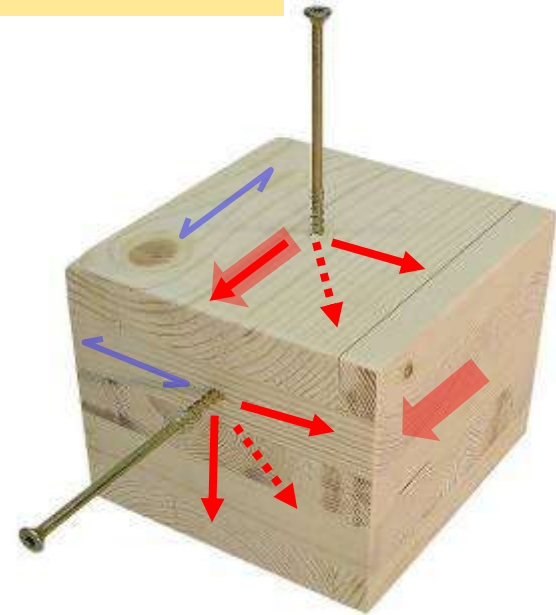

Different layers are loaded @ different angles due to X-lamination

Why Connections in CLT are Different than those in Solid Timber or Glulam?!

Moreover...

Presence of specific CLT panel features such as:

- Gaps in unglued cross laminates
- Artificially sawn grooves to relieve drying stresses

Not common to all CLT products as many products have edge-glued x-lamination

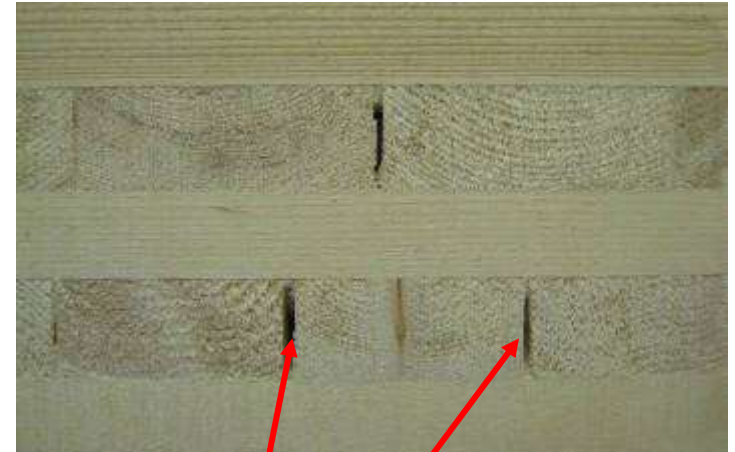

Gaps and grooves

Does that Make Connections Design in CLT more Challenging?

Absolutely NOT!!

- CLT has a more favourable ability to resist splitting due to X-lamination (i.e., acts like reinforcement)
- However, need to take into account some of the specific features of panels at the design stage (e.g., unglued edges)

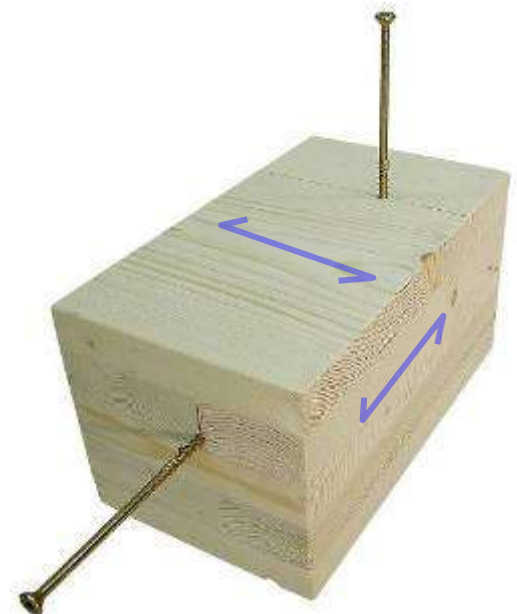
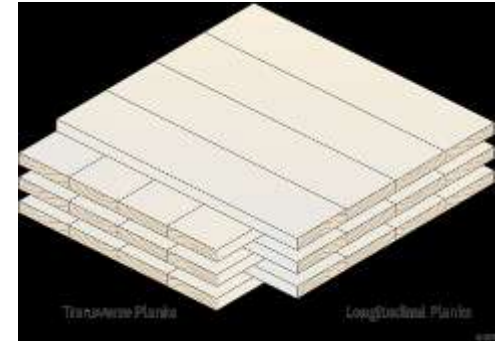

Connection Details in CLT Assemblies

Panel to Panel

(i.e., in wall, floor & roof assemblies)

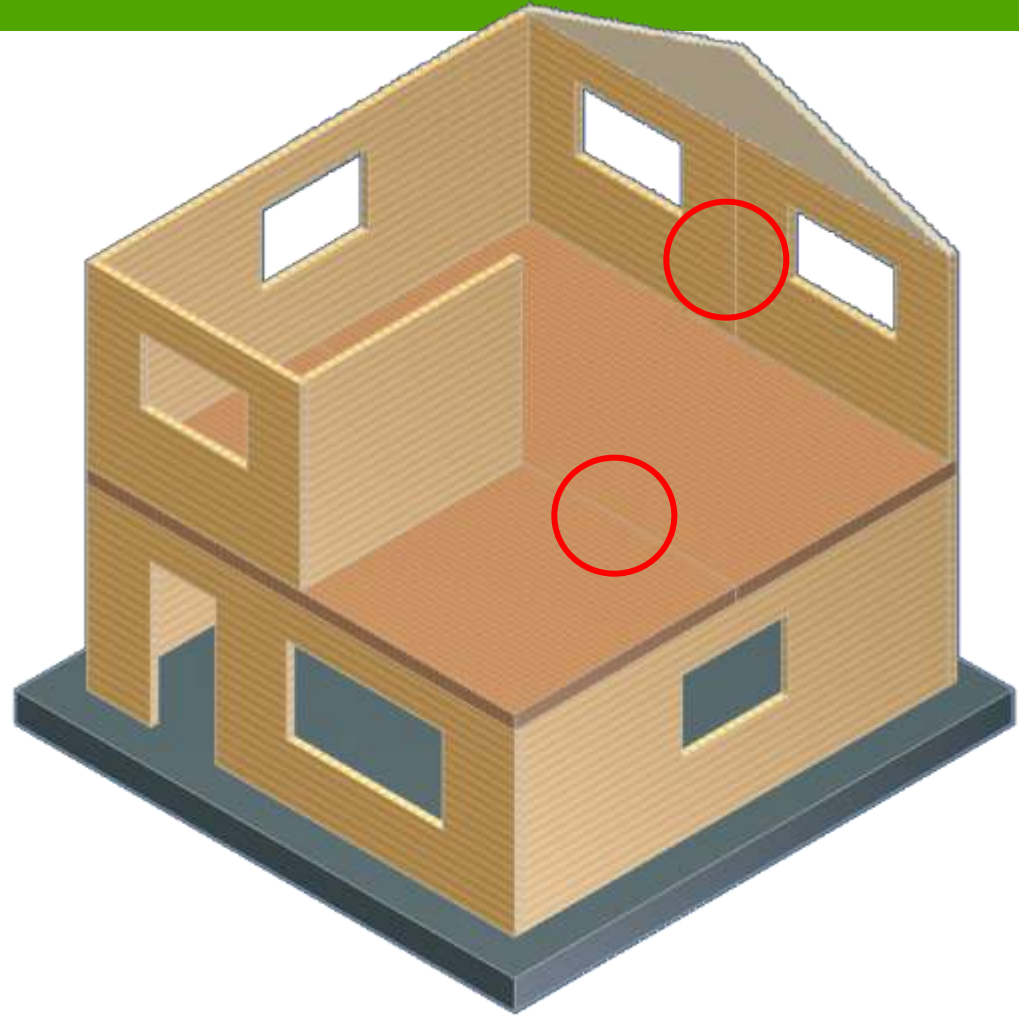

CLT Panel to Panel Connection Details

Traditional Fasteners (Screws, Nails)

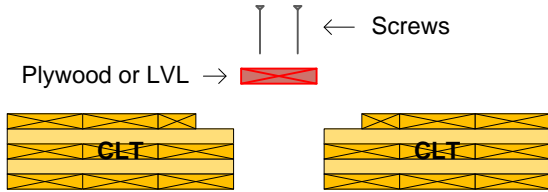

Single surface spline

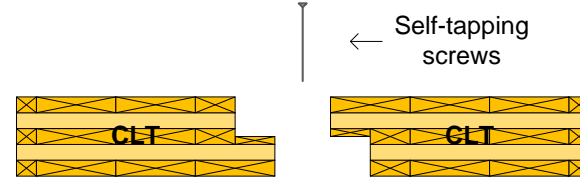

Half-lapped

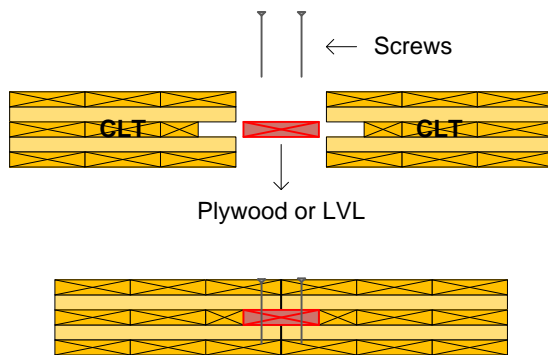
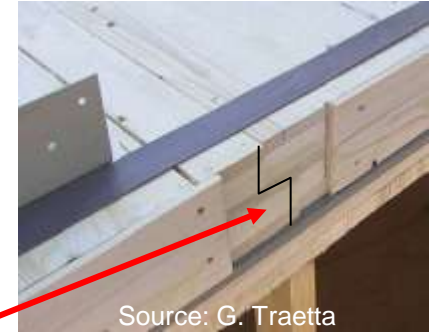

Internal spline

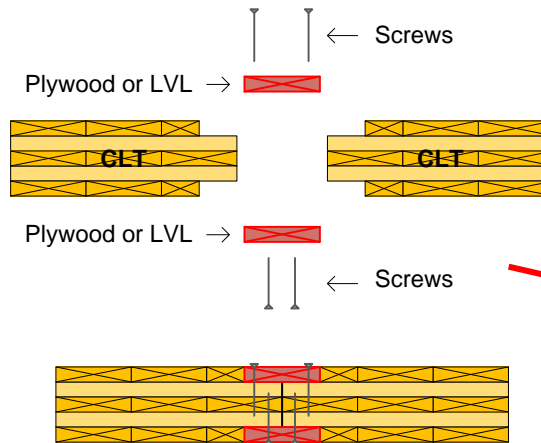

Double surface spline



CLT Panel to Panel Connection Details

Traditional Fasteners (Screws, Nails)



Double internal spline



Source: Kevin Meechan
Courtesy WoodWorks

Innovative/Proprietary Systems for CLT Panel to Panel Connections

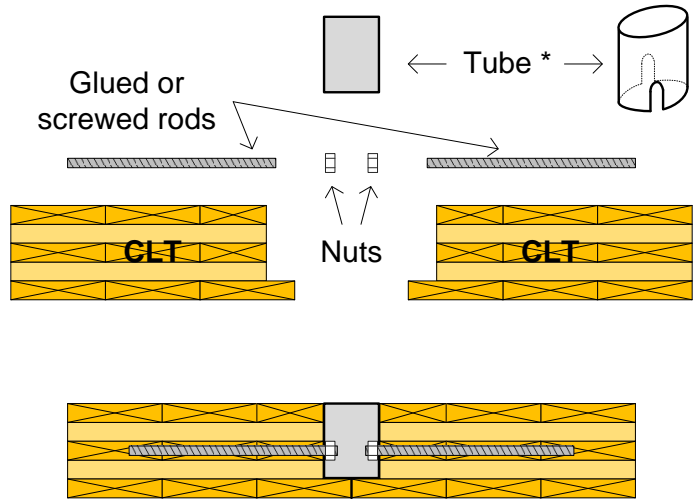

Tube connection system

(Source:Traetta & Schickhofer)

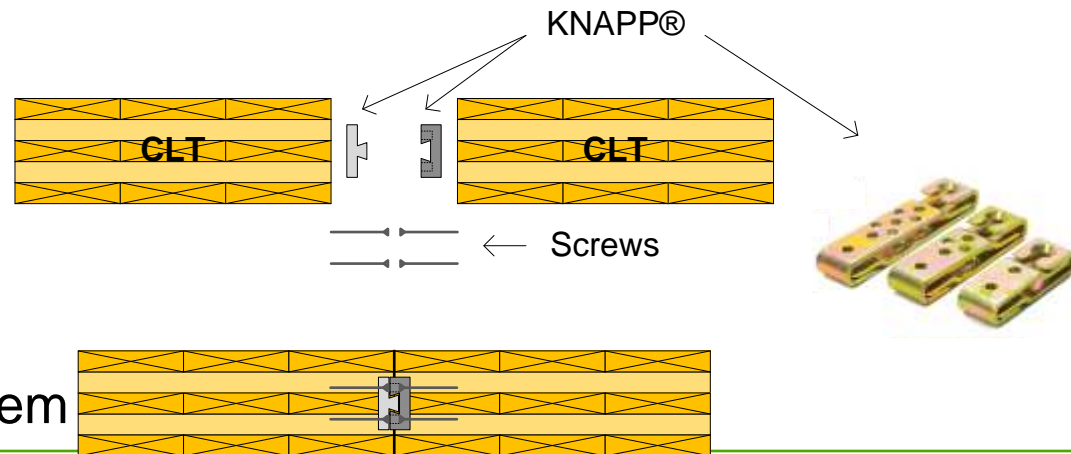

Knapp® connection system

Connection Details in CLT Assemblies

Wall to concrete foundation

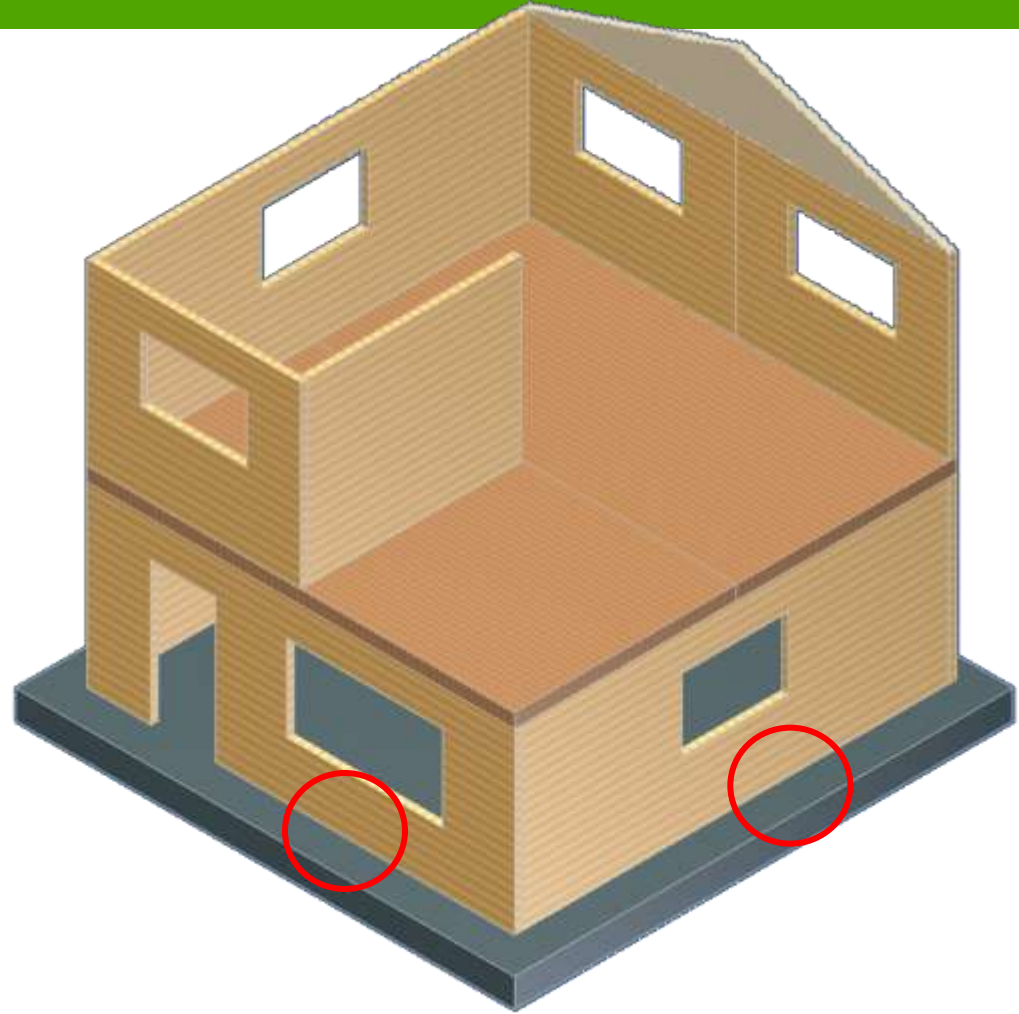

CLT Wall to Concrete Foundation

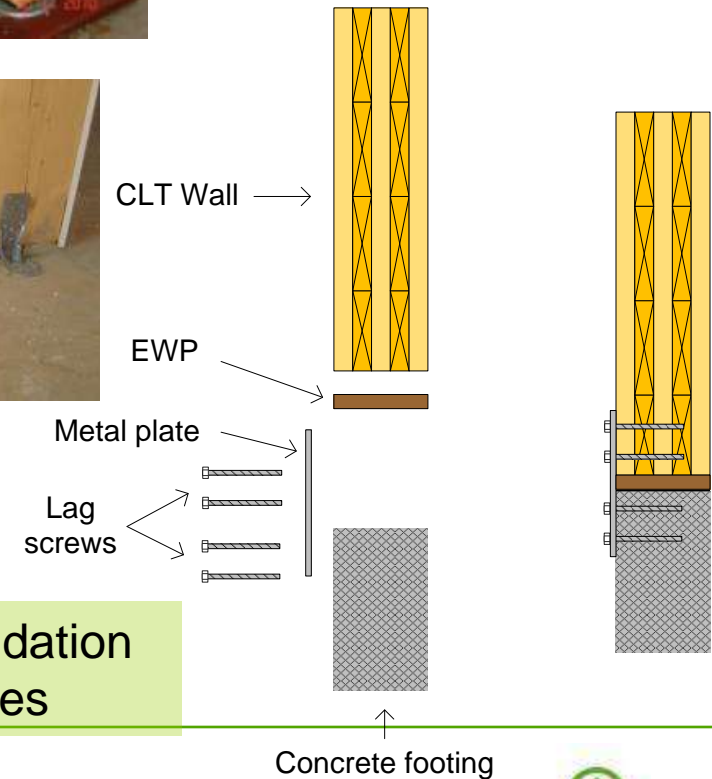
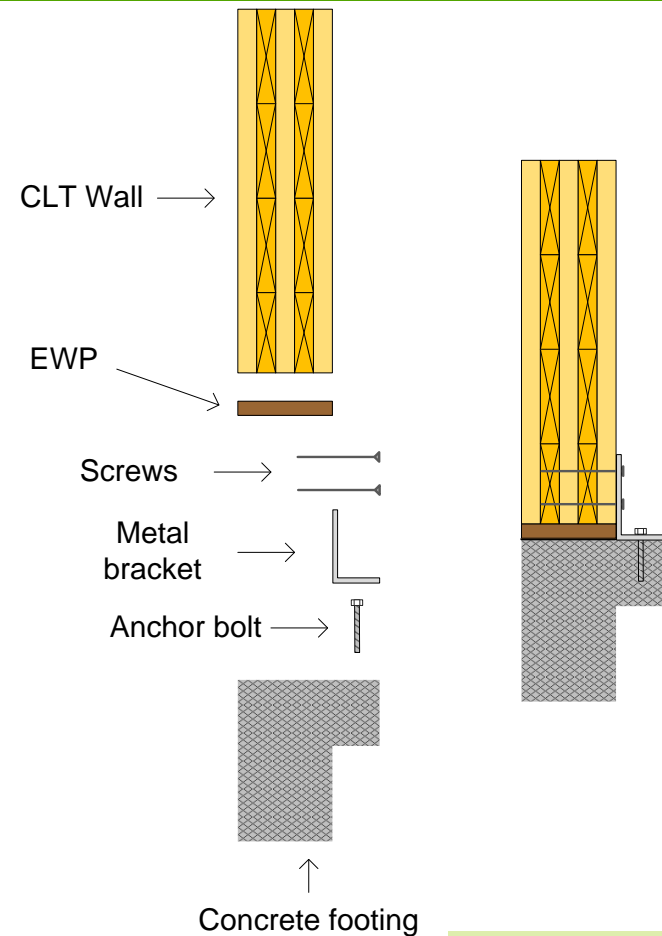

CLT wall to concrete wall or foundation slab using metal brackets or plates

CLT Wall to Foundation: Internal/concealed Metal Plates

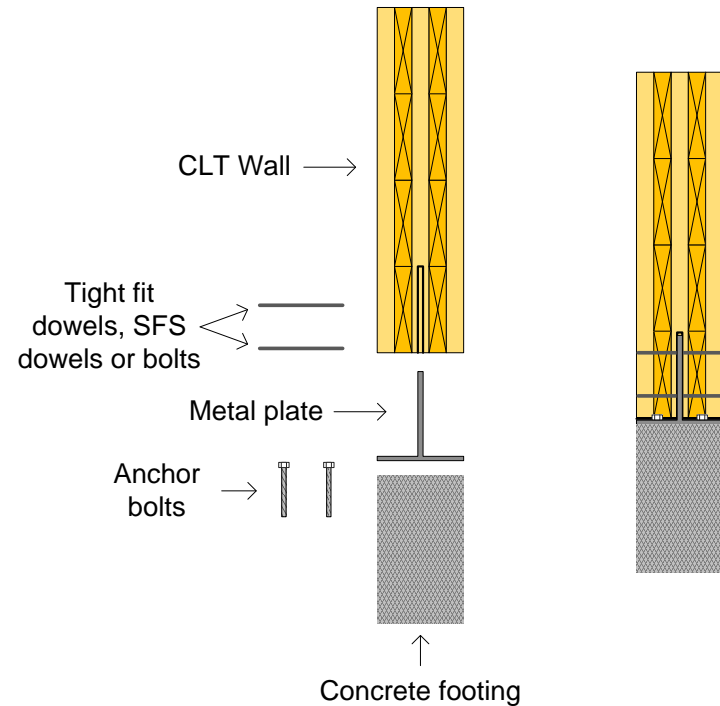

CLT panel/post to concrete pedestal through metal brackets

Connection Details in CLT Assemblies

Wall to Wall

(i.e., Exterior & interior walls intersections)

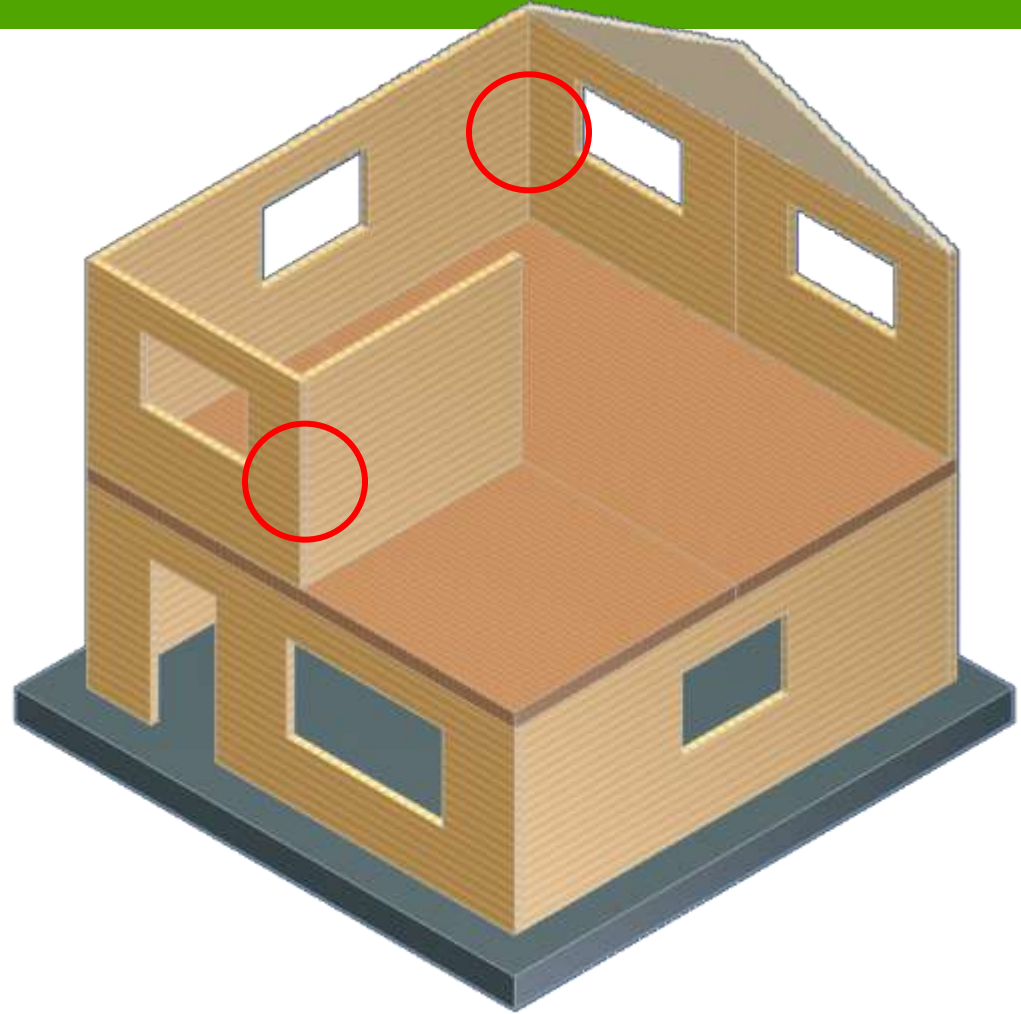

Wall to Wall Connections in CLT – Self tapping Screws

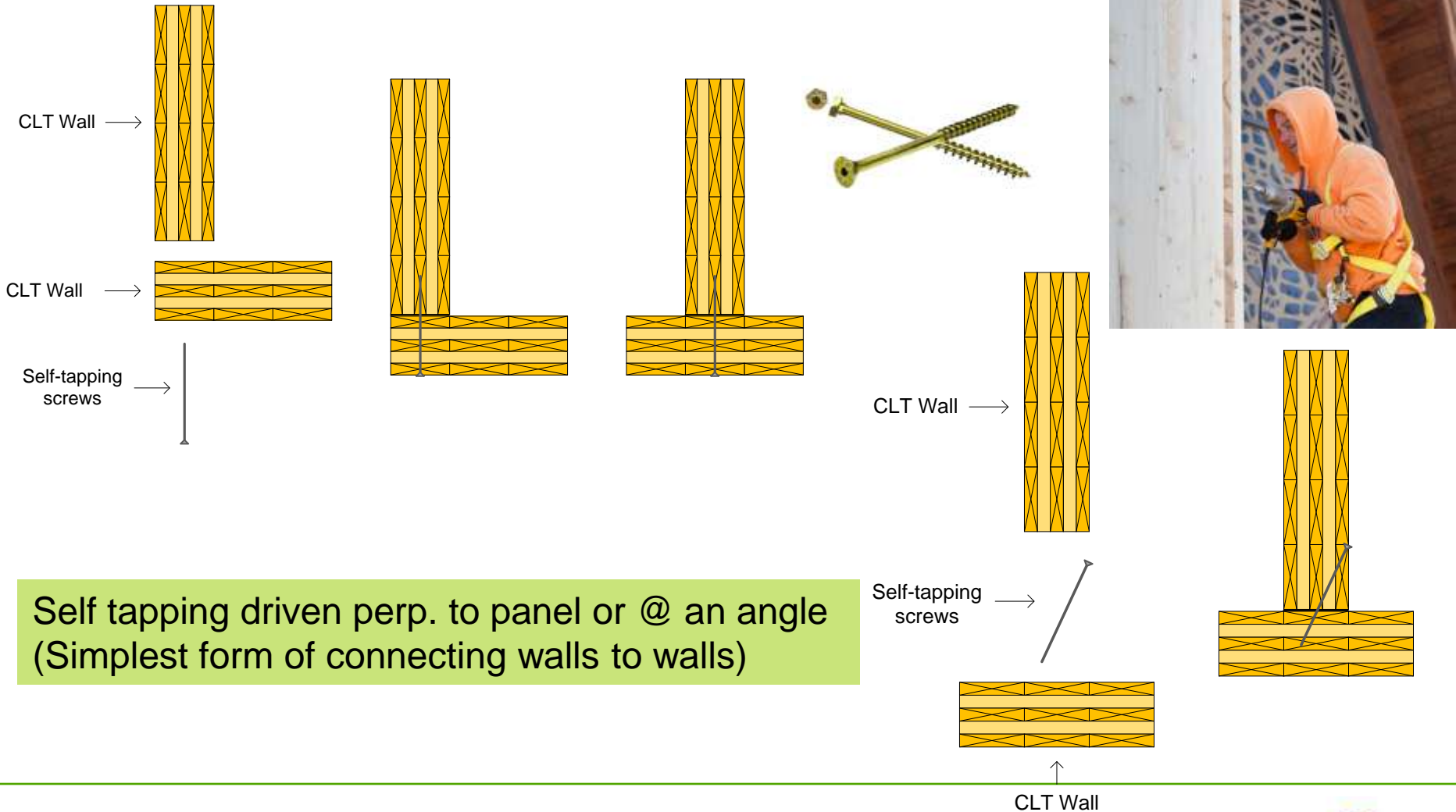

Self tapping driven perp. to panel or @ an angle
(Simplest form of connecting walls to walls)

Wall to Wall Connections in CLT – Metal Brackets

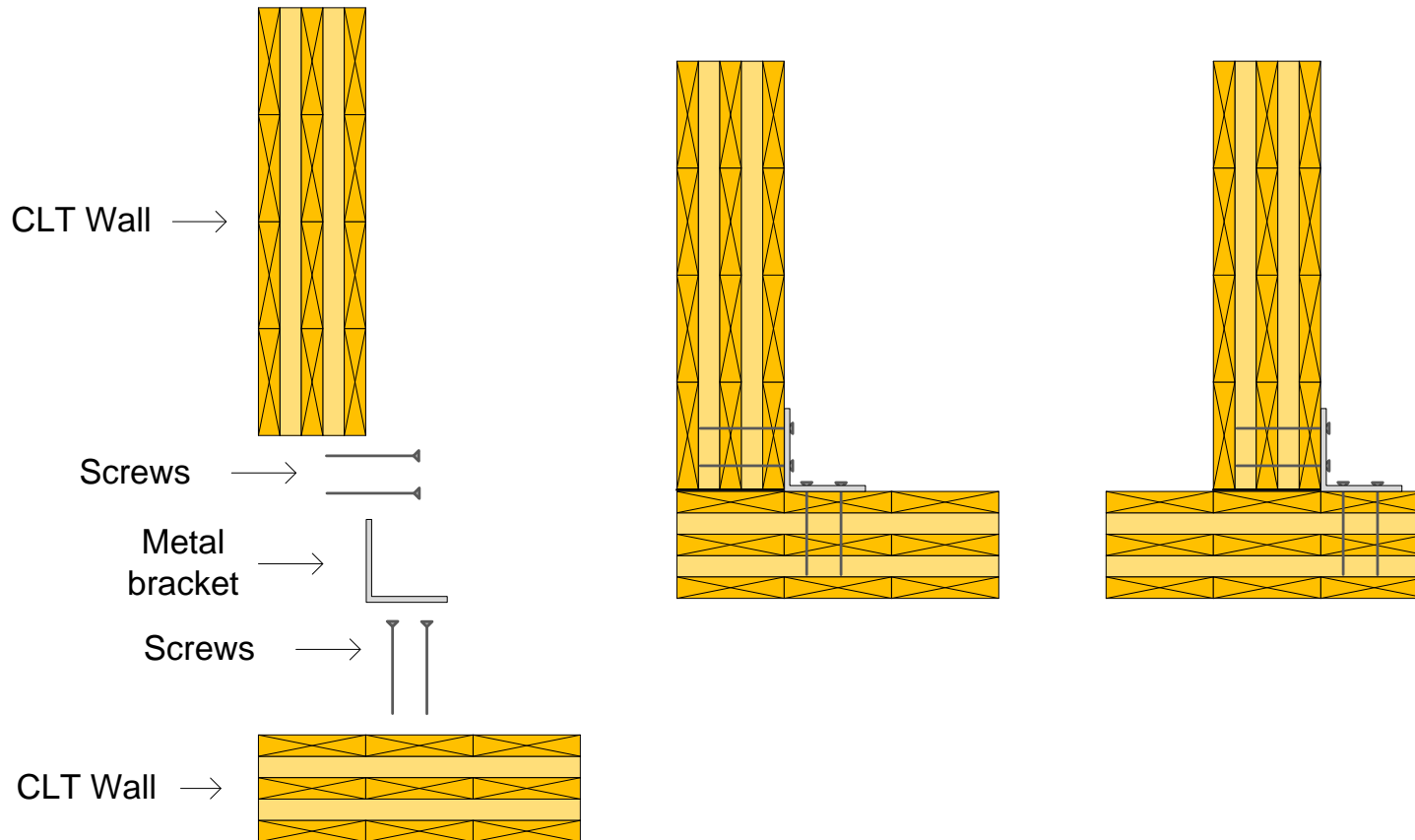

A combination of nails or self drilling screws and metal brackets

Connection Details in CLT Assemblies

Wall to Floor/Roof

Platform or Balloon type
of Construction System

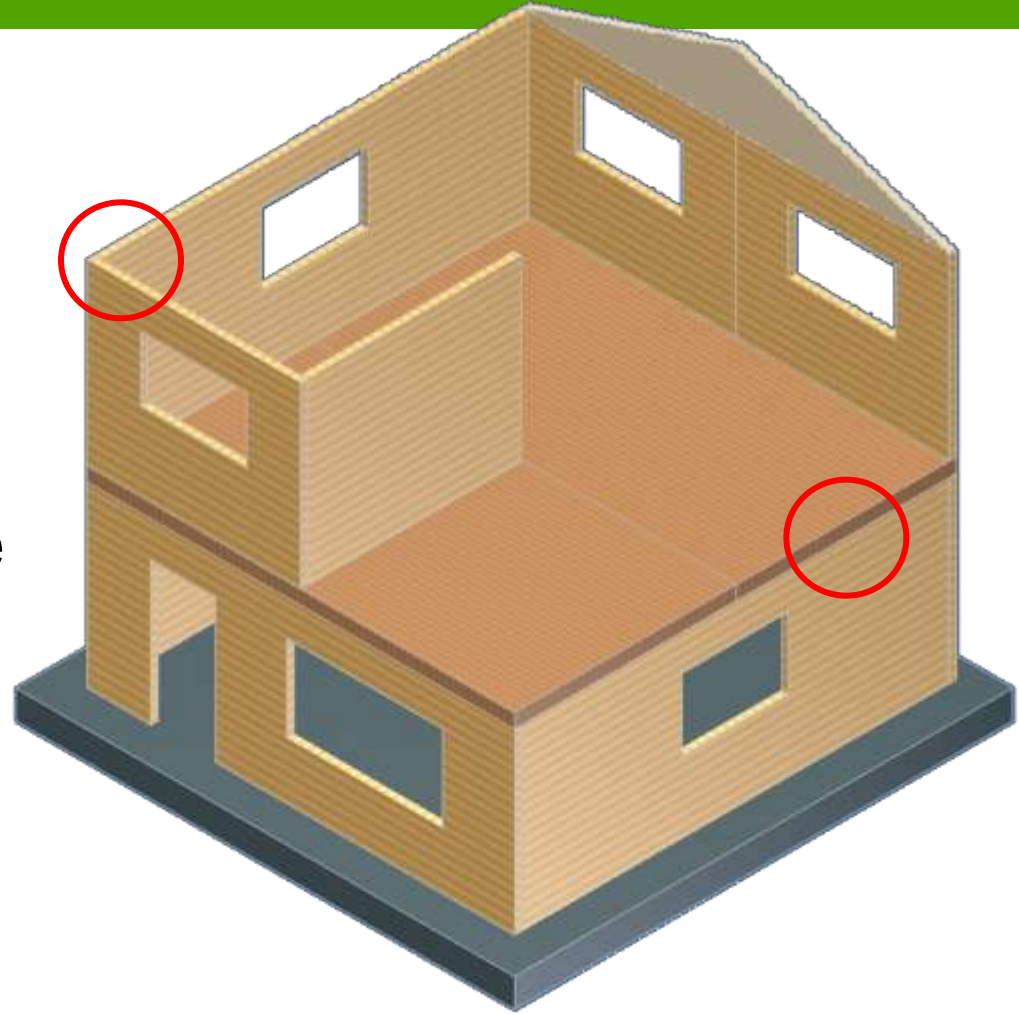

CLT Wall to Floor/Roof Connection Details - Platform

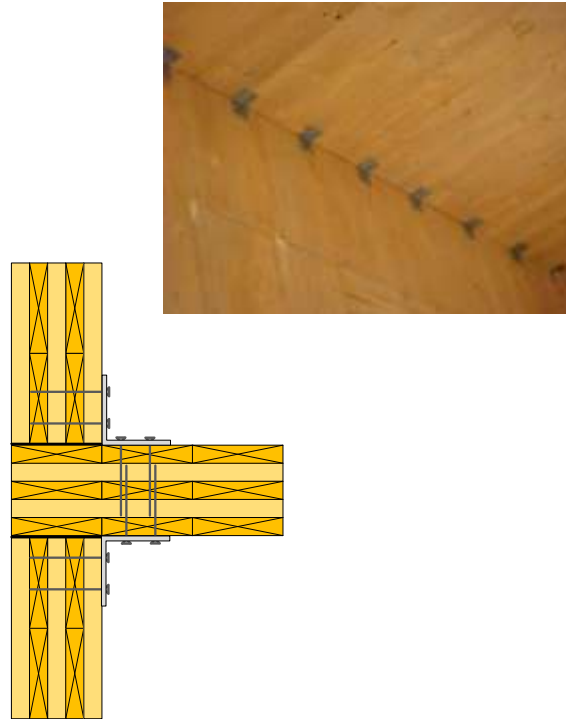
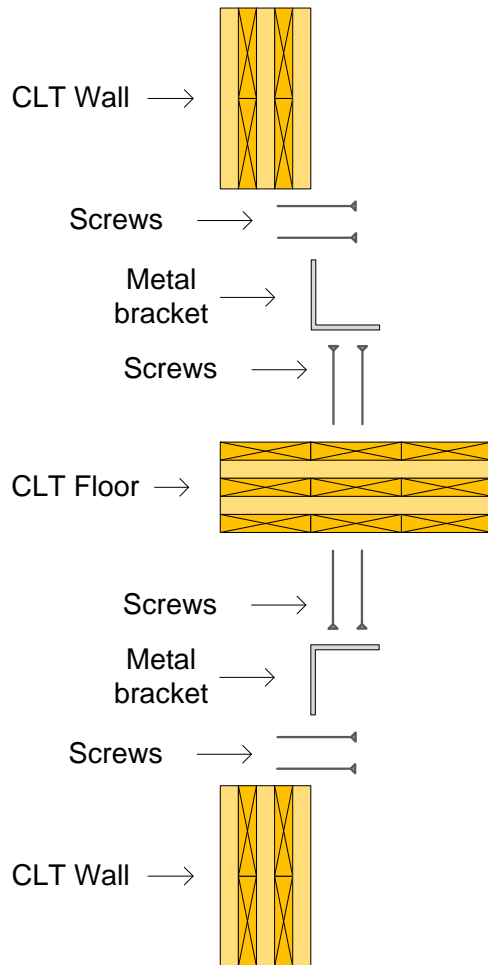

Most commonly used system in Europe in CLT assemblies

CLT Wall to Floor/Roof Connections: Platform

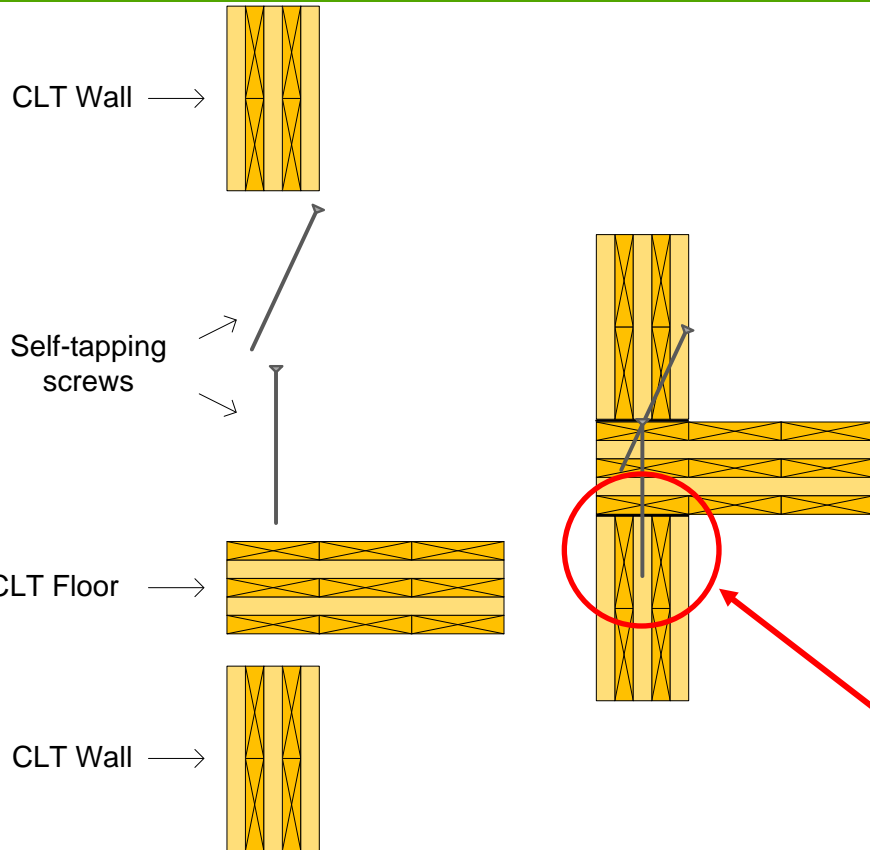

Use of self tapping screws
(Simplest form of connection)



Special attention should be paid in driving screws on edge as they may penetrate through end grain

CLT Wall to Floor/Roof: Combination of Several Systems

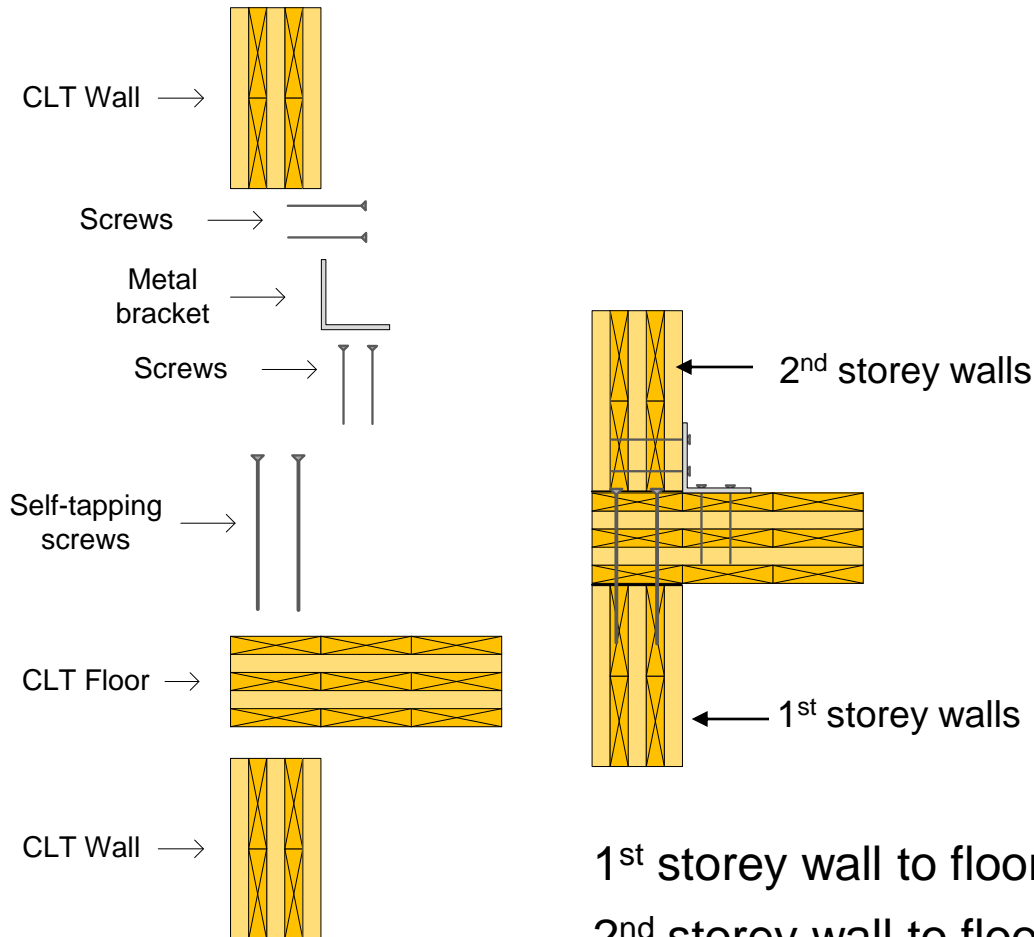

1st storey wall to floor/roof → self tapping screws
2nd storey wall to floor → combination of metal brackets and nails or screws

CLT Wall to Floor/Roof Connections- Balloon Type

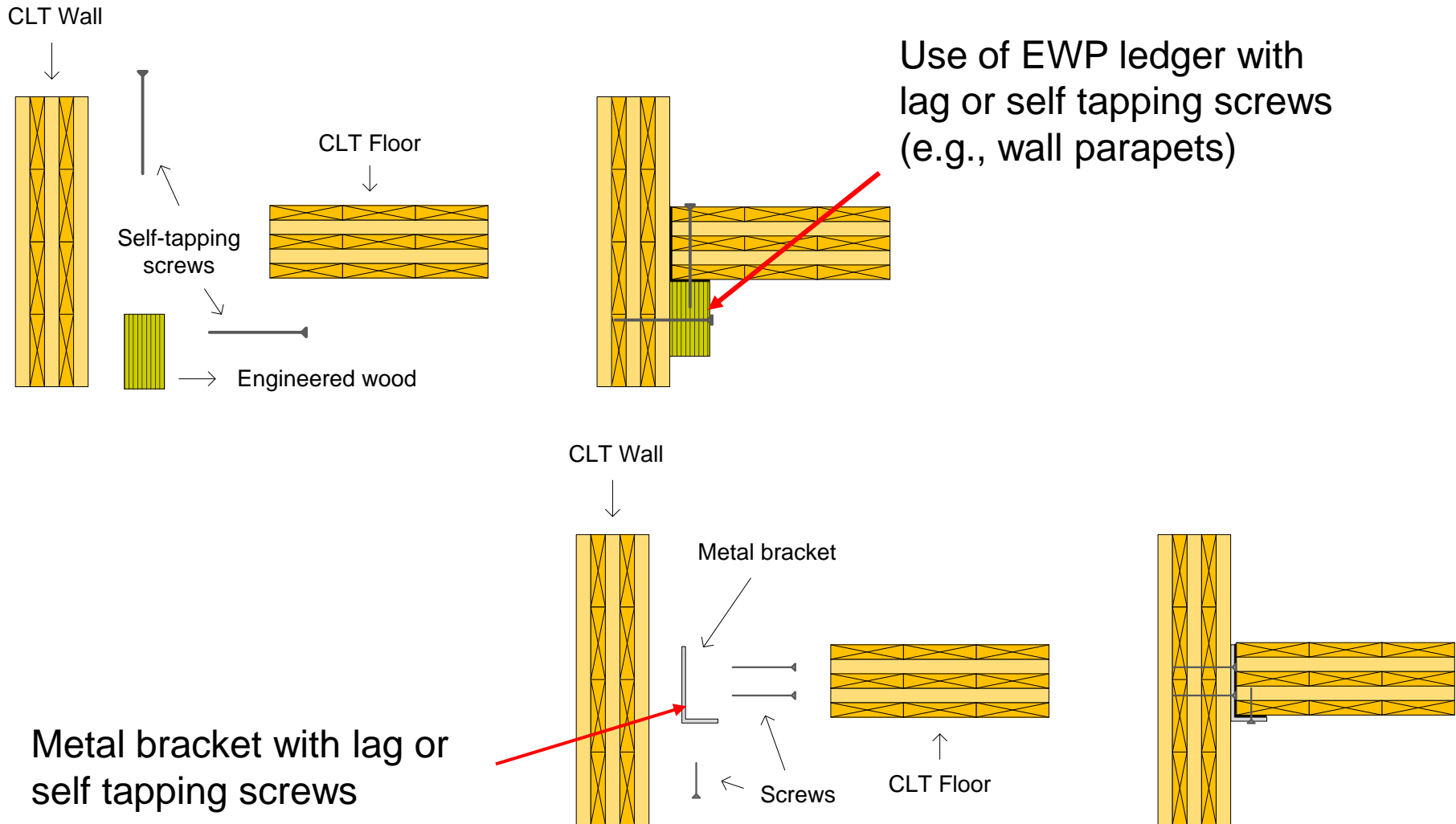

Mixed CLT with other Wood-Based Systems (Hybrid Systems): I-Joisted Floor Assemblies

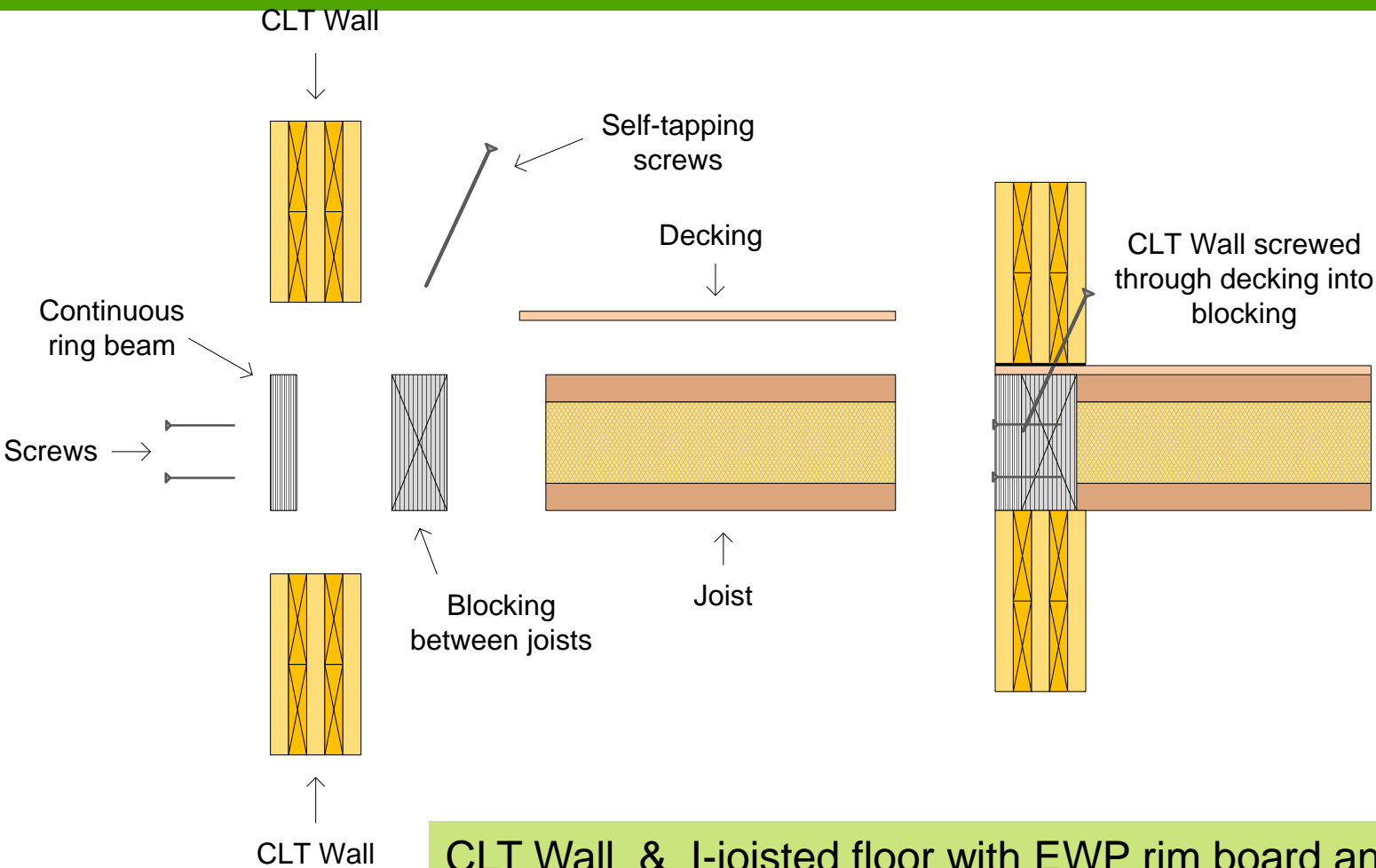

CLT Wall & I-joisted floor with EWP rim board and blocking. Self tapping screws are used

Adopted from TRADA

Mixed CLT with other Wood Based Systems (Hybrid Systems): Metal Plated Floor Assemblies

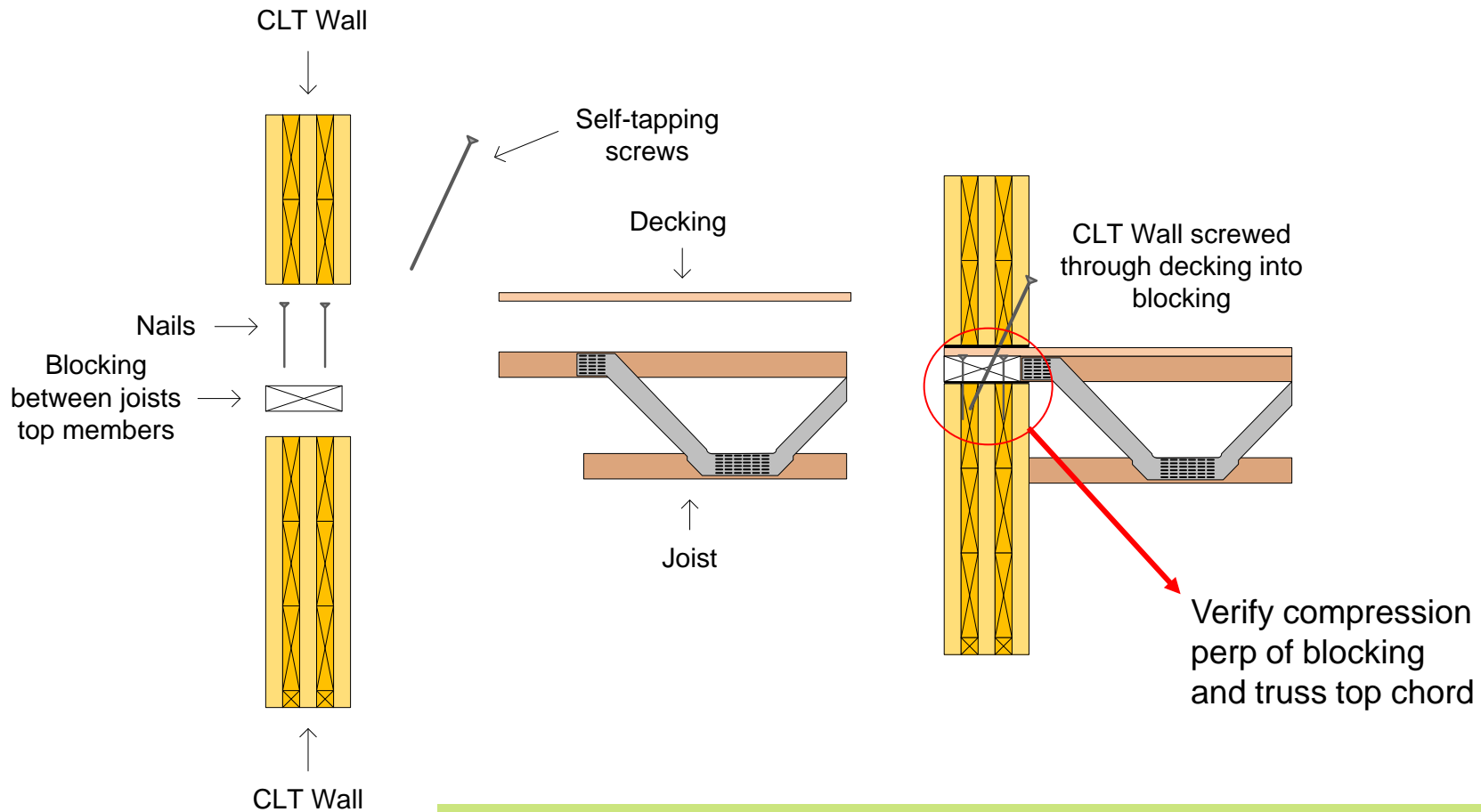

CLT Wall & metal plated floor trusses. Self tapping screws are used

Adopted from TRADA

Designing Connections in CLT – Challenges and Complications...

Fastener driven perp. to the CLT panel
Fastener's position relative to edge gaps between lamina:

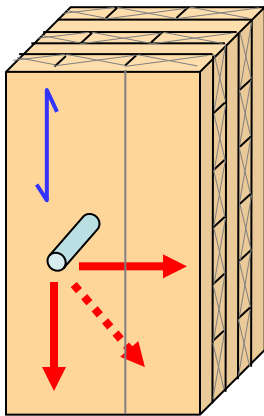

Outside
gaps

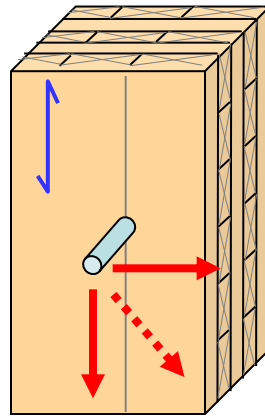

In outer layer
gap

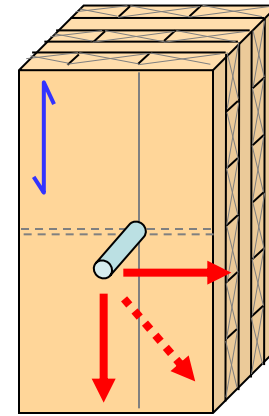

In both outer
and X-layers
gaps

- Not an issue for slender fasteners
- May need to consider in design of large diameter fasteners (i.e., bolts, dowels)

Fastener Driven on Edge..... Challenges and Complications...

Small fasteners

$d \leq$ lamina thickness

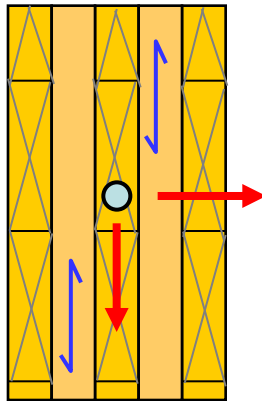

Driven // to grain

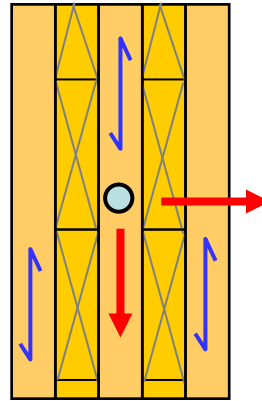

Perp. to grain

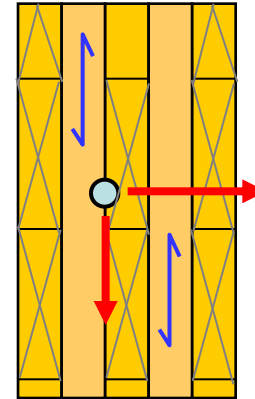

Between 2 lamina

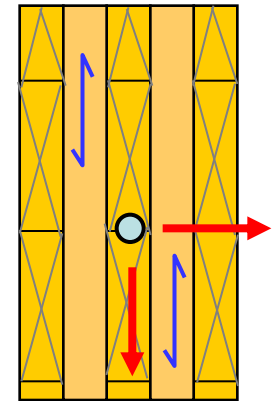

// & in gap

Some possible scenarios..

Large fastener

$d >$ lamina thickness

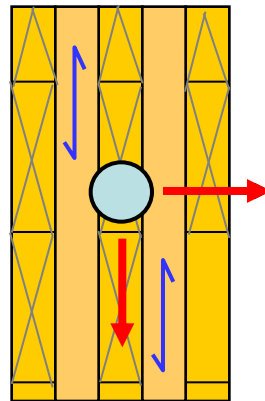

// to grain

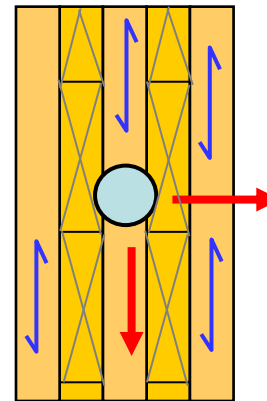

Perp. to grain

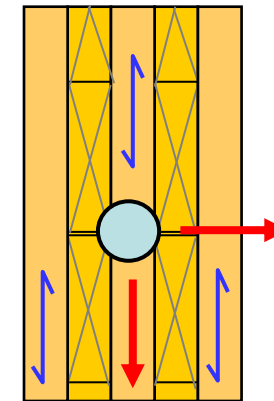

// & in gap

// & in gap

Research on CLT Connections – European Experience

- Extensive research in Germany, Austria & Norway on performance of traditional fasteners in CLT:
 - Different loading orientations 0° , 45° , 90° relative to outer layer
 - Different positions relative to edge gaps between lamina
 - Different types of fasteners
 - Long term connection tests

(Uibel & Blass 2006, 2007)(Traetta 2007)

- A simplified calculation methodology developed to establish the fastening capacity with screws, nails and dowels based on the embedment strength

(Uibel & Blass 2006, 2007)



Source: Uibel and Blass (2006)



Source: M. Augustin /ITE

Behavior of Connections in CLT: European Tests

5-layered CLT to steel connections: Comparison with glulam

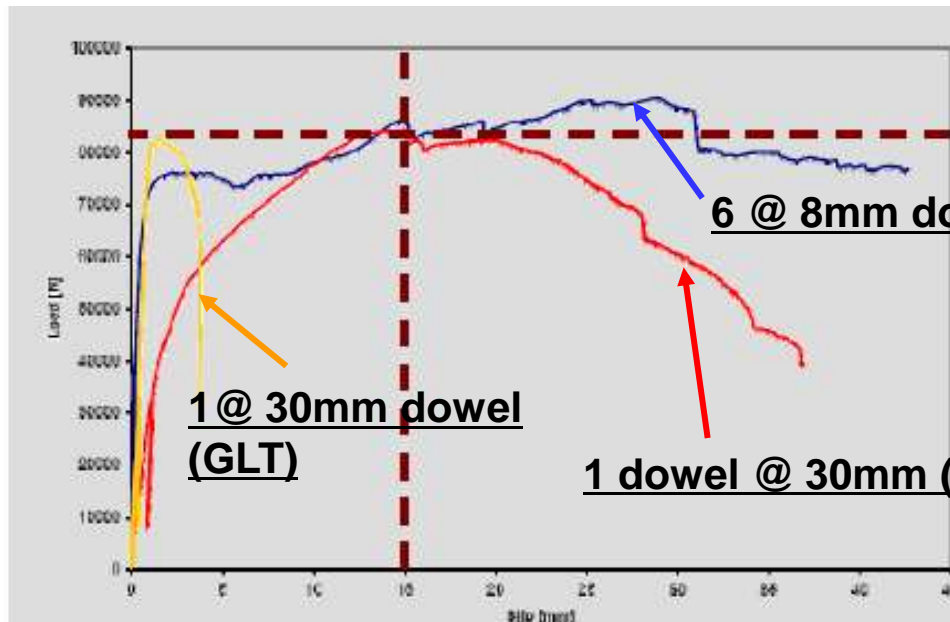

High ductility



Connections Research Activities @ FPInnovations

Exploratory Study

Half-lapped (step) joint

Self tapping screws

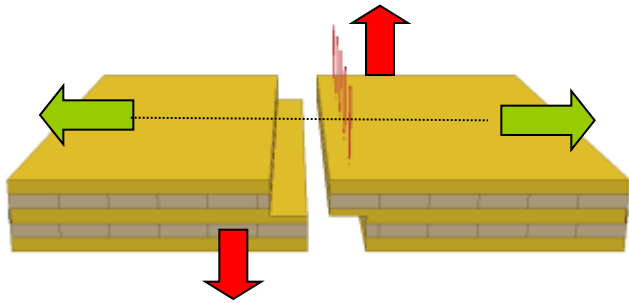

Single Spline joint

Wood screws

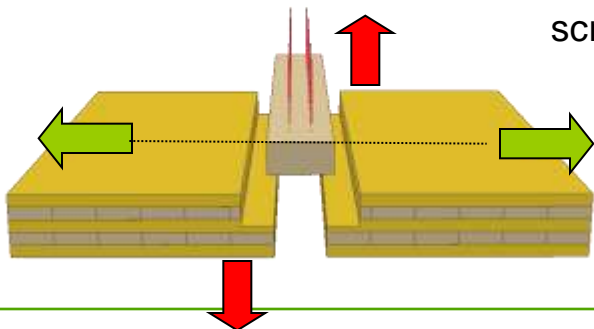

Lateral and withdrawal tests using European CLT to investigate the performance of screws in CLT with 2 different panel-to-panel profiles

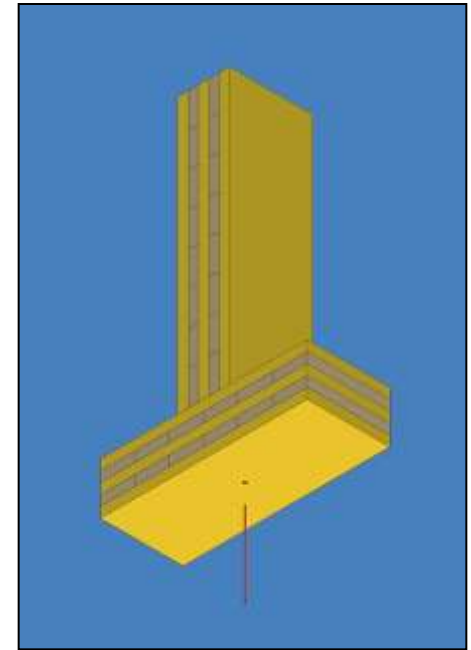
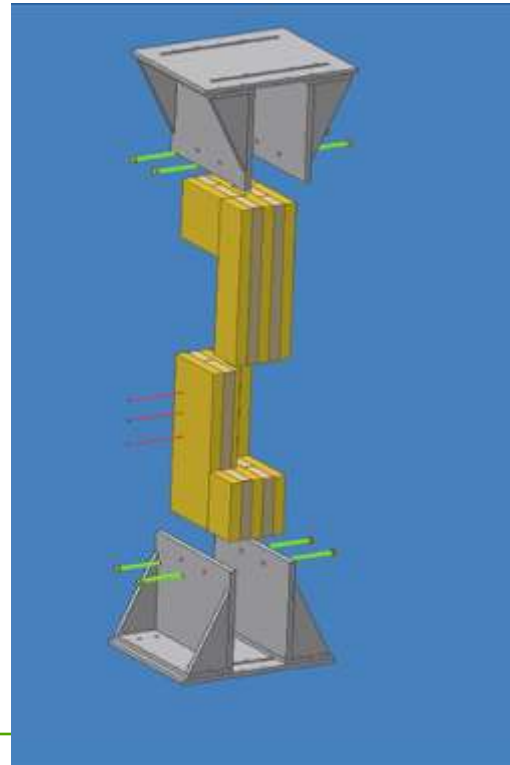

Development of Innovative Connection Systems Concepts in CLT @ FPInnovations

Design concepts developed..
Testing is underway..

Concept 1: Bearing washer (Prototype)

Capitalize on the high bearing resistance of wood

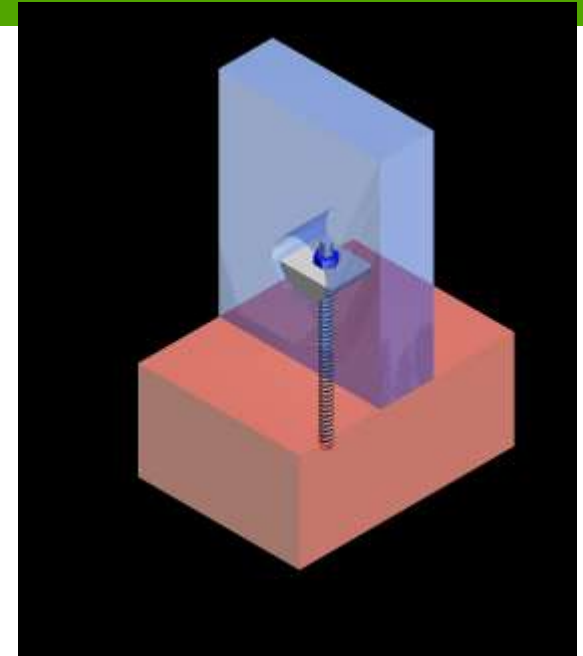

Development of Innovative Connection Systems Concepts in CLT @ FPInnovations

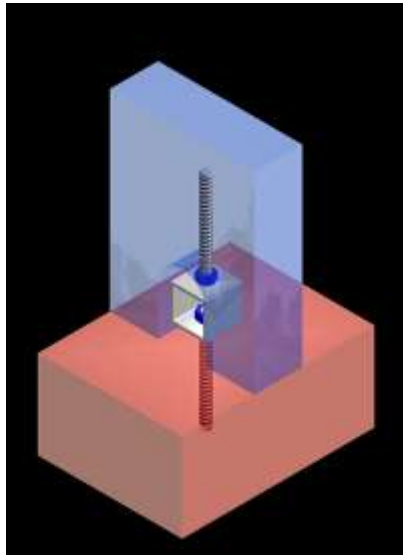

Concept 2

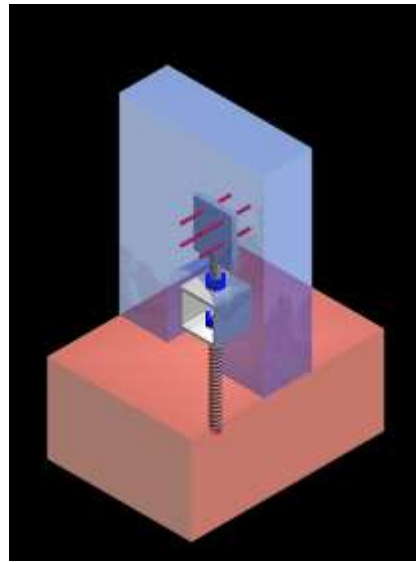

Concept 3

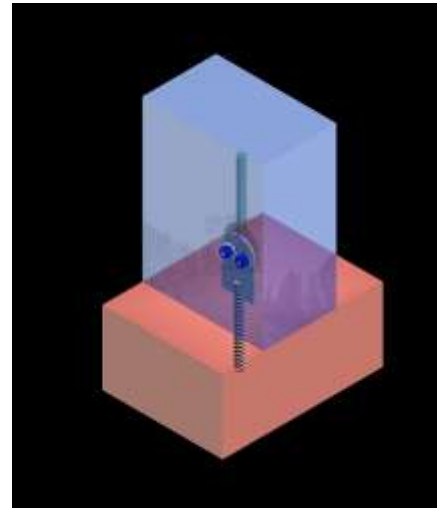

Concept 4

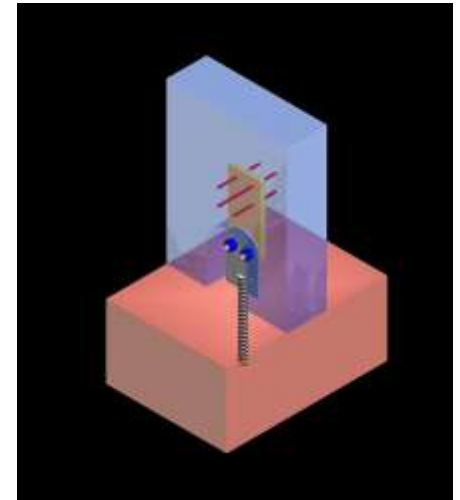

Concept 5

Adopting CNC technology & allowing for quick assembly/disassembly

Establishing steel to steel connections

Proposed European Design Approach for Connections in CLT

Laterally Loaded Dowel-type Fasteners

- Establish the embedment strength for each type of fasteners in CLT (in plane & on edge) – Empirically..
- Embedment strength eqs. are used in the current EC5 design procedure for connections in solid timber & glulam (EYM)
- Min. spacing & edge and end distances are specified to minimize brittle failure mode in CLT

Withdrawal Resistance

- Derive withdrawal resistance eqs. empirically by tests

Proposed Calculation Methodology for Embedment Strength – Over 1300 tests

Nails & Screws – Generalized Approach

Perp. To Plane

$$f_{h,k} = 0.112 d^{-0.5} \rho_k^{1.05} \quad (N/mm^2)$$

Narrow Side (Edge)

$$f_{h,k} = 0.862 d^{-0.5} \rho_{ply,k}^{0.56} \quad (N/mm^2)$$

Validity

- Nails: 4.2mm, Screws: 6,8 & 12mm
- ≤ 7mm thick lamina

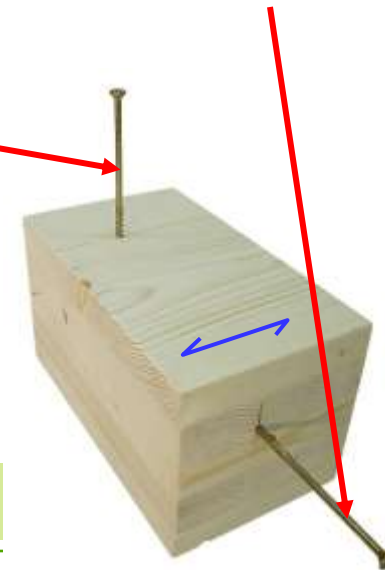

Independent of loading direction relative to outer layer

Proposed Empirical Models for Characteristic Embedment Strength from Europe

Bolts & Dowels

Perp. To Plane

$$f_{h,k} = \frac{0.031 (1 - 0.015 d) \rho_k^{1.16}}{1.1 \sin^2 \alpha + \cos^2 \alpha} \quad (N / mm^2)$$

Independent of panel build-up, but function of loading direction relative to outer layer

Validity

- 40mm thick lamina or less
- $0.94 < t_1/t_2 < 2.1$
- Min. penetration 3 layers

Narrow Side (Edge)

$$f_{h,k} = 0.0435 (1 - 0.017 d) \rho_{ply,k}^{0.91} \quad (N / mm^2)$$

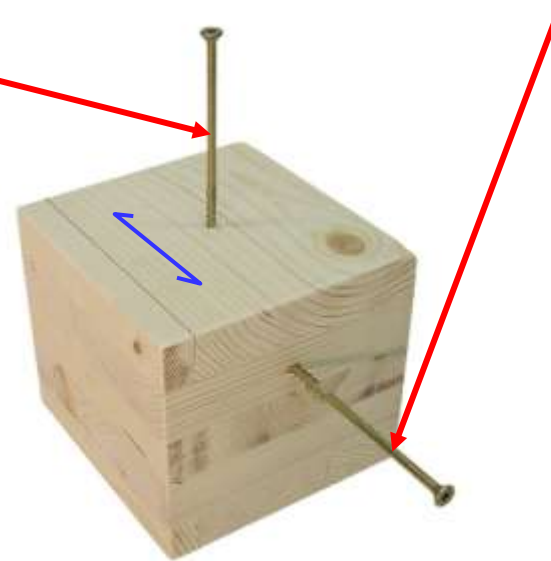

Proposed Withdrawal Resistance of Self-tapping Screws in CLT – Over 380 tests

Driven Perp. to Plane Or Narrow side

$$R_{ax,s,k} = \frac{0.35 d^{0.8} l_{ef}^{0.9} \rho_k^{0.75}}{1.5 \cos^2 \varepsilon + \sin^2 \varepsilon} \quad (N)$$

Where

ε = angle between screw axis and CLT grain direction

ρ_k = density of CLT panel (fasteners driven perp. to the plane of the panel); Or

density of relevant layers (fasteners driven on edge)

Validity

Withdrawal resistance in solid wood exceeds

$$f_{ax,k} = 80 \rho_k^2 10^{-6} \quad (N / mm^2)$$

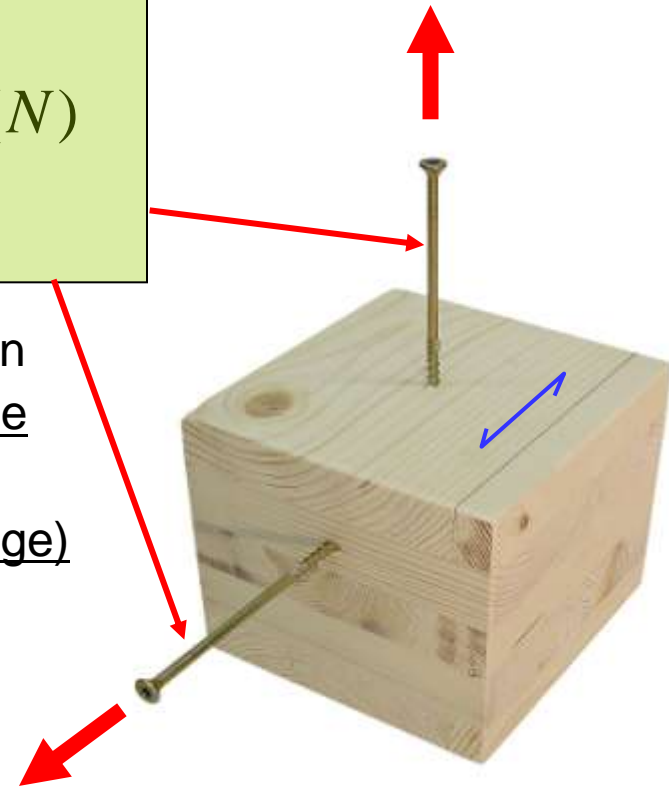

Placement of Fasteners in CLT Joints

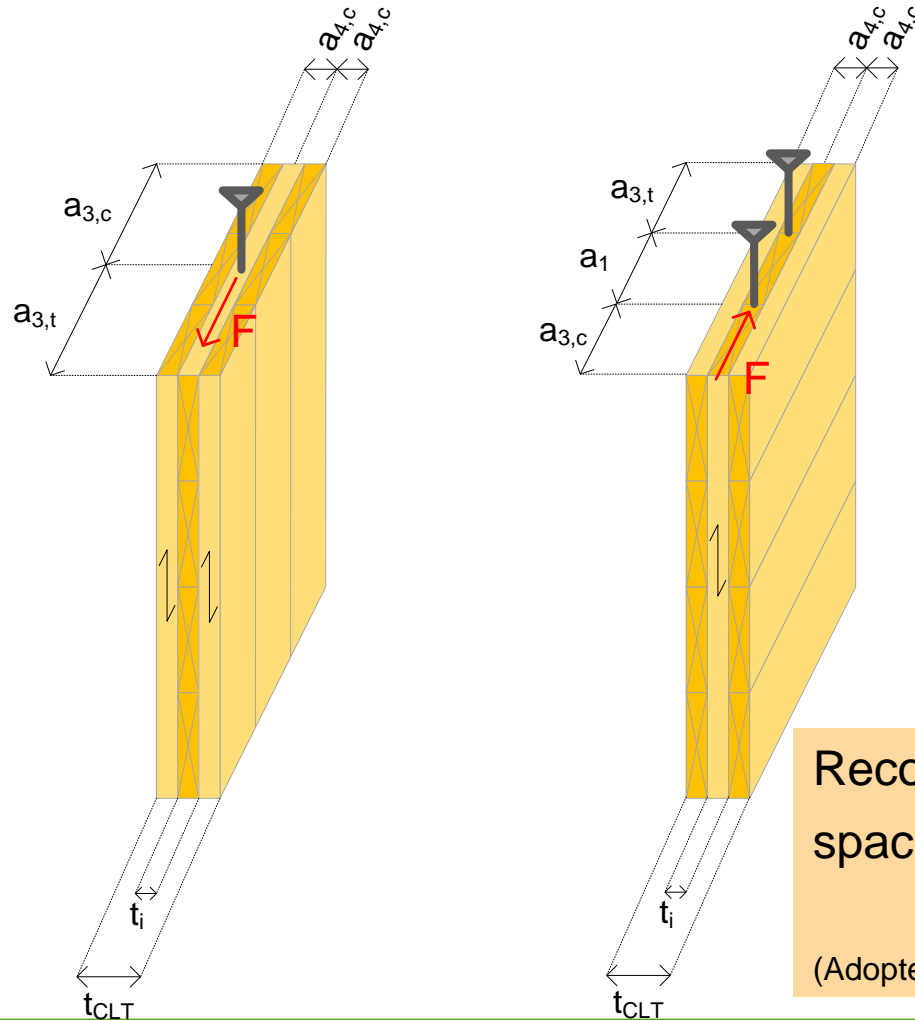

	Type of fastener	
	Self-tapping screws	Dowels
a_1	10 d	4 d
a_2	3 d	4 d
$a_{3,t}$	12 d	5 d
$a_{3,c}$	7 d	3 d
$a_{4,c}$	5 d	3 d

Recommended end and edge distances and spacings for dowel-type fasteners

(Adopted from Uibel and Blass 2007 & Annex J of CEN CLT Standard)

Dowel-type Mechanical Fasteners in CSA O86-09

Current design roles in CSA O86-09 for dowel-type fasteners in solid wood and glulam cover:

- Nails & spikes
- Wood screws (up to 1/4" in diameter)
- Lag screws
- Bolts & dowels
- Drift pins
- Timber rivets
- **Self tapping screws?! Not yet!!!**



No guidance is given on joints made with proprietary self-tapping screws.. Typically used in Europe for CLT connections

CLT Connections Design & Timber Design Standards in NA (CSA O86 & NDS)

- Based on limited verification testing & analysis @ FPInnovations, European design approach could be adopted within the CSA O86 and NDS provided that:



- **Brittle failure** modes need to be established in CLT (e.g., large diameters or closely spaced fasteners)
- Min. spacing and edge and end distances are specified



a)



b)

Current & Planned Research Activities on CLT Connections @ FPInnovations & Partners

Joint FPInnovations and Universities Research under Federal and Provincial programs:

- To investigate connections performance in CLT and develop technical information to support the development of design procedure
- Ultimately, introduce design provisions for connections in NA timber design standards (i.e., CSA O86, NDS)



Detailing of Connections in CLT

In detailing Connections in CLT, other performance attributes need to be addressed:

- Fire performance
- Acoustic & vibration
- Differential shrinkage
- Building envelope and durability
- Etc.

Need a Multi-disciplinary Approach



Detailing of Connections in CLT

Important!!

Ensure tight fit between individual panels!!

Key for:

- Structural integrity
- Improved fire resistance
- Sound insulation
- Air tightness



Source: Kevin Meechan
Courtesy WoodWorks

In Summary

- European experience & test results @ FPInnovations & elsewhere indicate that traditional connections in CLT are:
 - *Simple*
 - *Structurally efficient*
 - *Cost-competitive*
- Proposed European design methodology for CLT connections could be adopted in NA. However, need to account for potential CLT brittle failure modes
- Need to introduce self tapping screws and CLT in NA timber standards to promote CLT product & assemblies



Any Questions?!