

Construction OS&H

Working at height



Summary

Common hazards with working at height
General OS&H requirements when working at height
Scaffolding
Structural frames
Demolition of above ground structures
Roof-work

How this module will be taught

Working at height can be very dangerous and there is a lot of detailed knowledge to be learned to preserve OS&H for all those involved. So, this module will be taught in the following stages:

- 1 A presentation by the tutor which summarises the main parts of the subject
- 2 Simulated 'tool-box briefings in which your tutor and some colleagues will take you through the topics in more detail

What are the common hazards when working at height?

Although obviously hazardous, working at height should create no hazards for anyone on a construction project.

Spend 10 minutes thinking about why hazards arise, and list ten possible causes.

Common hazards when working at height

- Poor conceptual design of the permanent works
- Poor structural design
- Poor functional design
- Inadequate planning and provision for weather
- Structural elements incorrectly erected or installed
- Poor (or perhaps no) workplace design
- Signalling systems (manual, mechanical, electronic) malfunction
- Misuse (elements and equipment not used as designed or planned)
- Unprotected edges and openings
- Loads insecurely attached
- Release of pressure (concrete pumps)

Many of the hazards which arise have these causes

- Poor mechanical design (breaks in use, not powerful enough, components fracture or malfunction)
- Poor functional design (not properly designed for the stated purpose)
- Poor workplace design
- Signalling systems (manual, mechanical, electronic) malfunction
- Misuse (not used as designed)
- Loads insecurely attached
- Release of pressure (concrete pumps)
- Poor maintenance (breaks or emits noxious gases)

These cause the following hazards

- Workers put in dangerous positions
- Workers handling very heavy or awkward loads causing falls or injury
- Falls due to collapses of partly built permanent works
- Workers crushed by falling or otherwise moving elements or equipment
- Falling machinery or parts of machinery
- Falling loads
- Crushing due to impact of moving or toppling plant and equipment
- Impact from release of pressure
- Falling from plant and equipment
- Falls caused by swinging loads, plant and equipment
- Limbs or bodies caught in parts of the permanent works or machinery
- Physiological damage through exposure to weather
- Poor ergonomics
- Physiological and psychological damage through stress of dangerous work
- Stress caused by poor environment

Other hazards

These are, of course, just some of the main hazards, there are many more which are specific to particular projects.

Each project must be assessed specifically and all hazards taken into account.

Discussion!



General principles of safety when working at height

Fall of materials

Preventive measures should be taken against the fall of workers and tools or other objects or materials.

Openings

All openings through which workers are liable to fall should be kept effectively covered or fenced and indicated in the most appropriate manner.



Ladders

If a ladder is properly used it:

- Enables only one person to climb or descend at any one time
- Enables only one person to work from it at any one time
- If not lashed at the top, requires two workers for use – one on the ladder and the other at the bottom
- Leaves both hands free
- Restricts movement
- Has to be safely situated and secured
- Has a limitation on heights at which it can be used

Ladders must be fixed securely top & bottom

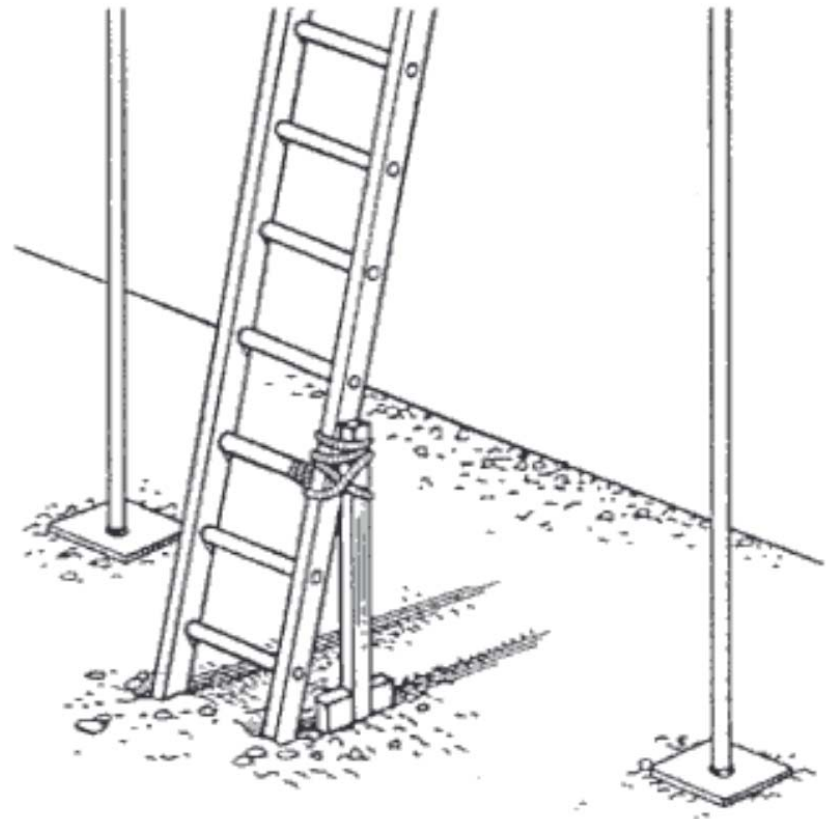
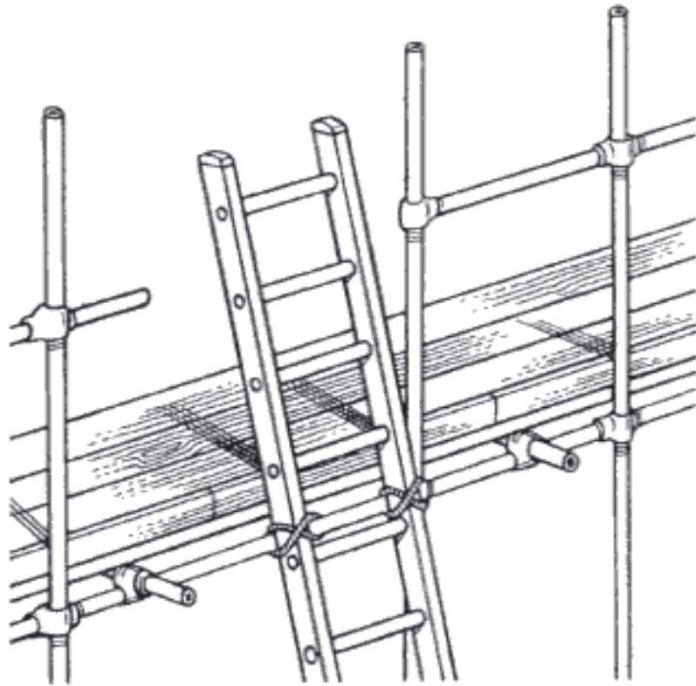

Points to remember when using ladders

Make sure that the ladder is long enough for the job.

Avoid carrying tools or materials in your hand while you are climbing ladders.

Don't over-reach.

Clean your footwear before climbing

Always inspect your ladder before you use it.

Remove damaged ladders from use and make sure that they are properly repaired. If they cannot be properly repaired, they must be destroyed.

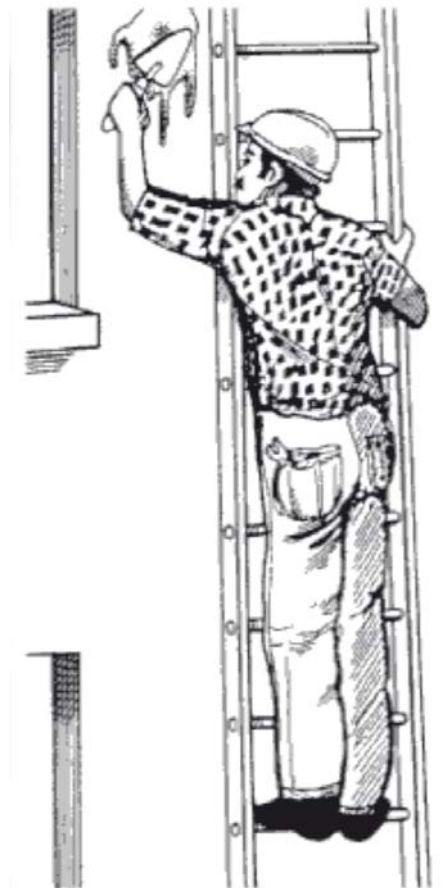

Scaffolding

Identify 10 points of good practice in the scaffold in the pictures, and one point of bad practice



Ten points of good practice & one of bad practice

1. Strongly braced diagonally in two directions
2. Good work platforms
3. Toe boards
4. Ladder tied at top with a clip (look closely)
5. Base plates spread the load on the pavement
6. Red & white warning tape on poles for pedestrians
7. Scaffold extends across roof and over ridge, so tied well to the building
8. Scaffold rests on boards on the roof, so protecting it
9. No ladder at bottom level - scaffolders put it up when working, so there is no easy access to the general public when they are not there
10. Additional lateral bracing across doorway

Bad practice:

Scaffold blocks the pavement, causing pedestrians to walk in the road.

Clips hold ladder top & bottom

This pole braces laterally



Working platforms and protection against falling materials and other items

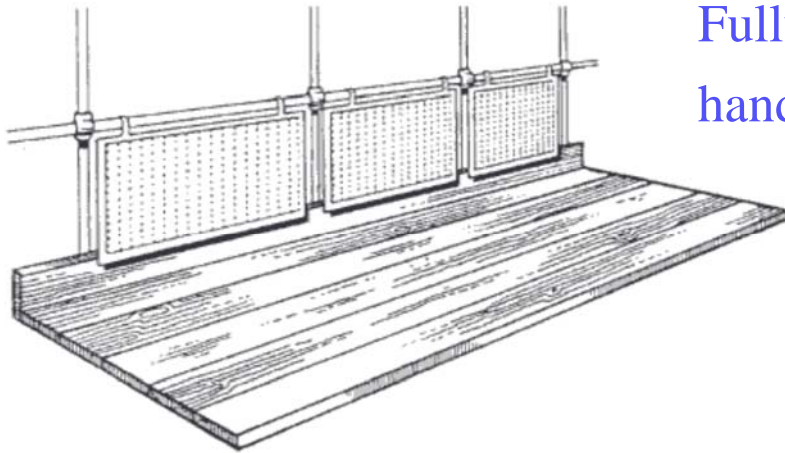

Fully boarded platform with toe boards, handrail and screens

‘Fans’ to catch falling items



Hong Kong has some of the world's tallest buildings. Nevertheless, the city still uses bamboo scaffolding for much of its construction work – a traditional skill passed down over 5000 years. Bamboo is sustainable, lightweight and cheap and, as long as it remains fairly dry, a good construction material with significant mechanical properties.

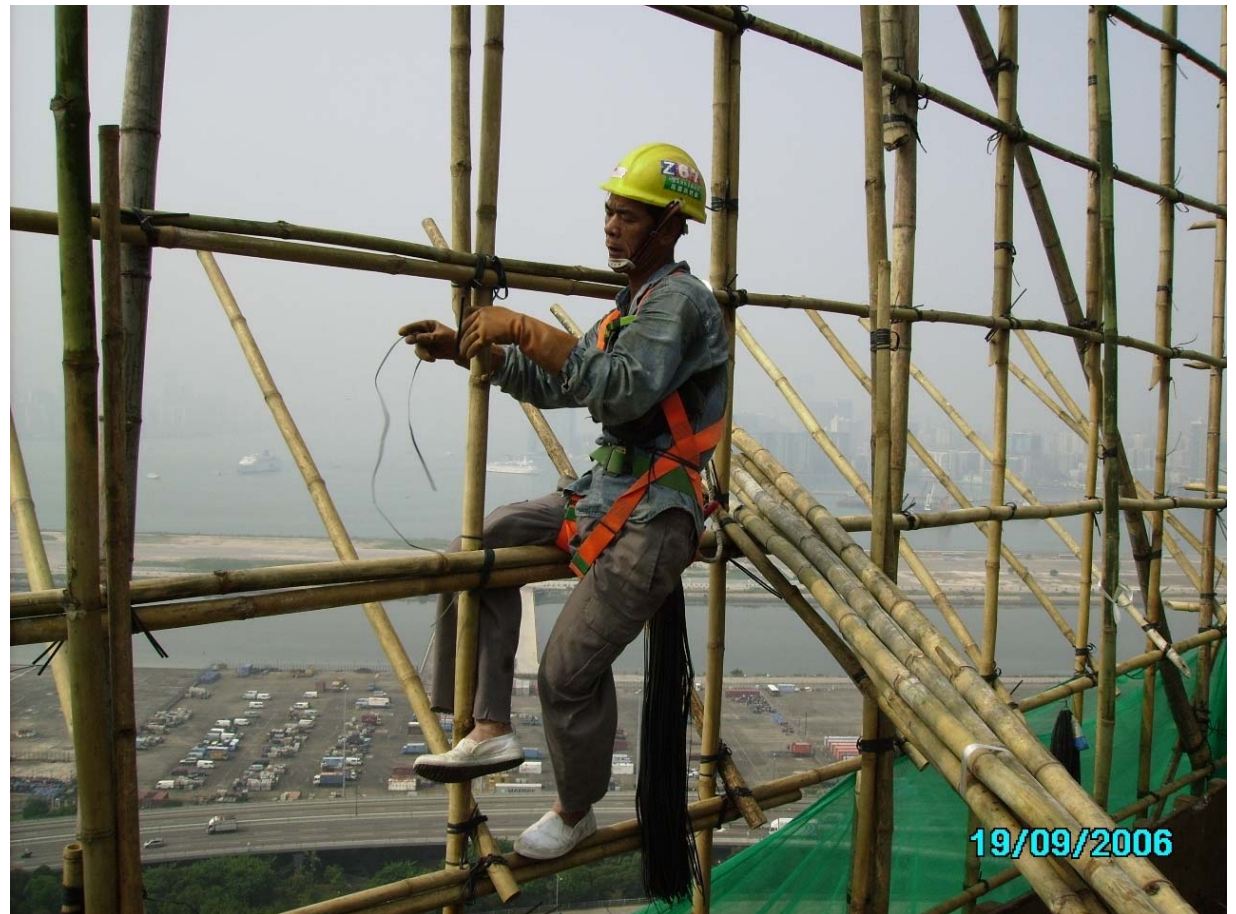

Tower & trestle scaffolds

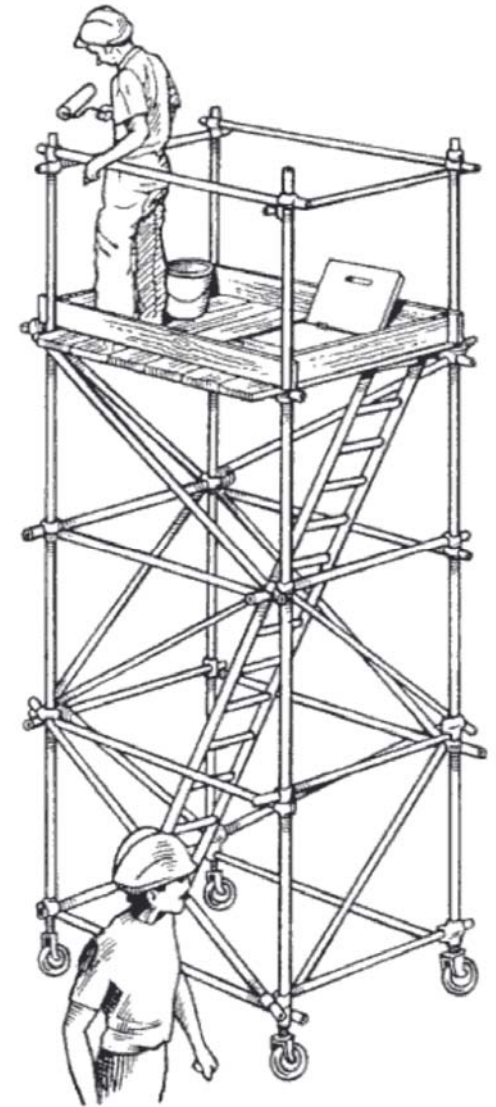
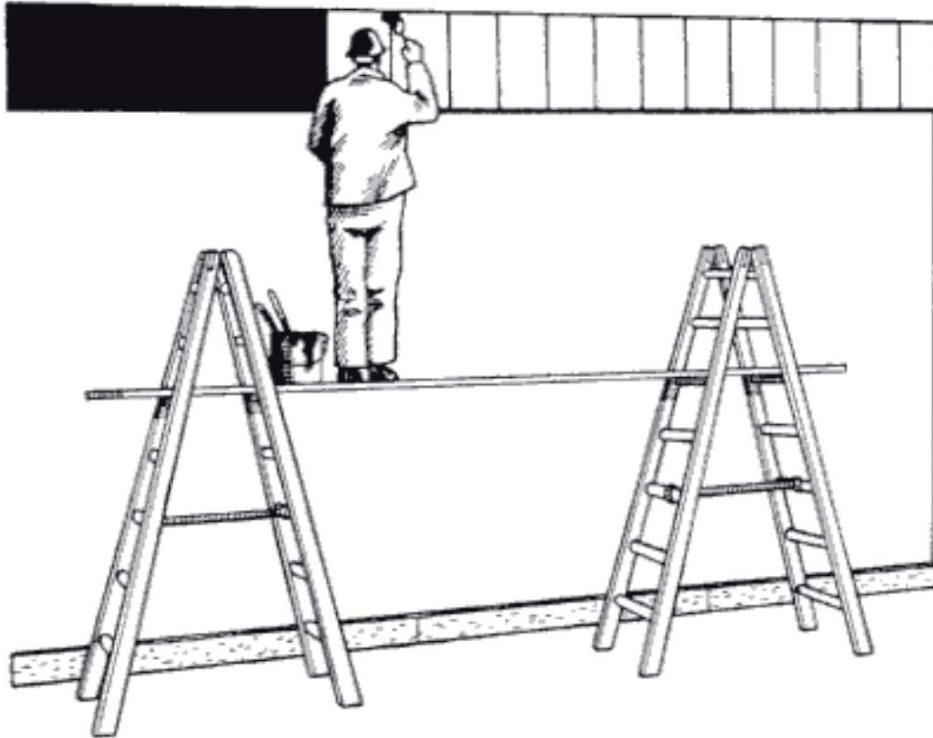

For light work only and must be used with great care

Mobile platform
gives versatility
and safety



Structural frames (steelwork)

An essentially hazardous occupation that can be made safer by the use of modern equipment

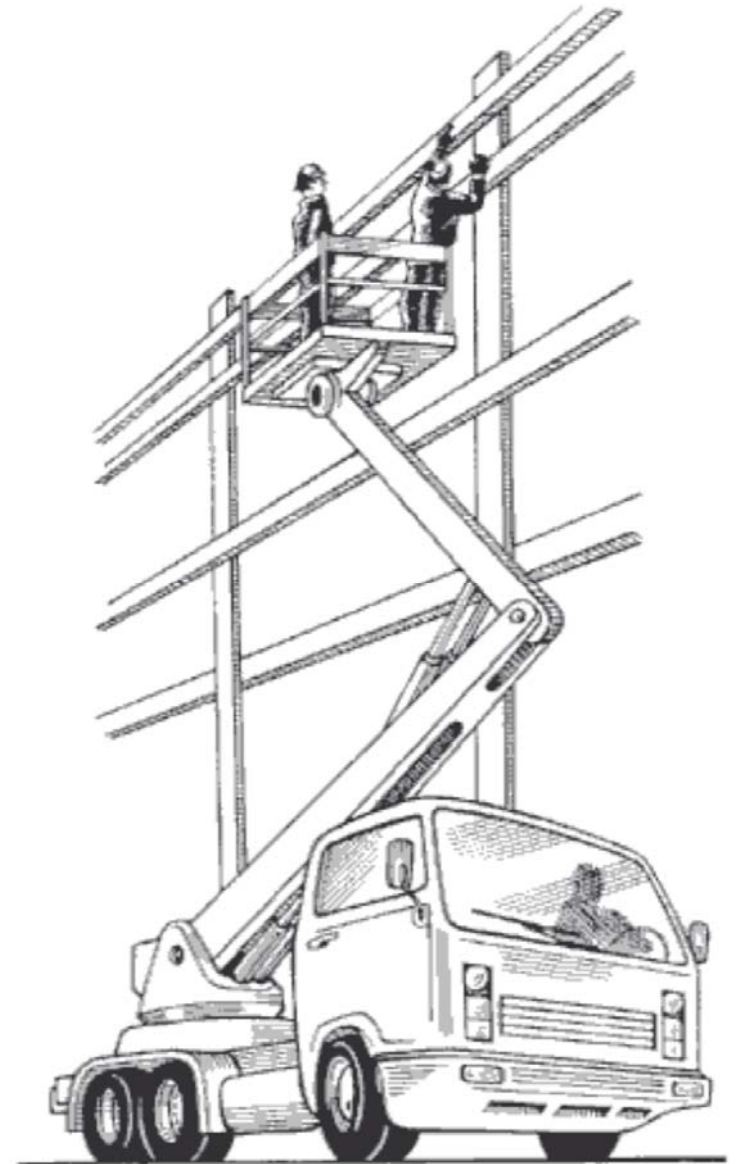
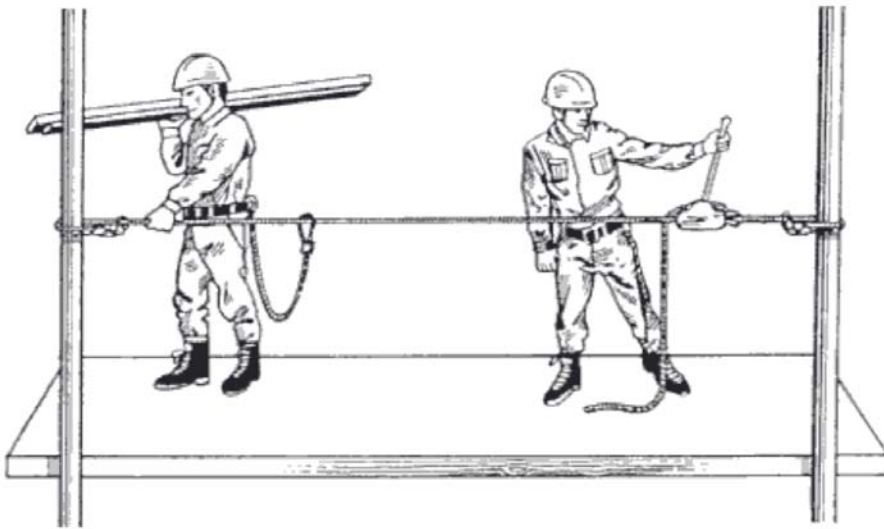

Points to remember for steel erectors

Trying to save crane time by reducing the number of bolts used in connections is a dangerous practice.

Do not work in high winds or on wet steelwork.

Always wear suitable personal protective equipment.

If you climb or walk on bare steel, sooner or later you will fall.

Demolition of above ground structures

The main causes of accidents during demolition are:

- The choice of an incorrect method of demolition
- An unsafe place of work
- The unintentional collapse of the building being demolished, or of an adjoining structure, because of lack of temporary support.
- Unexpected exposure to toxic substances

Wherever practicable, workers should avoid working directly from parts of the building or structure they are demolishing, such as standing on the top of a brick wall. This usually means that they have both poor handholds and poor footholds.

When work cannot safely be carried out from a building, a scaffold platform, self-supporting and independent of the part of the building being demolished, should be provided.



Points for demolition workers to remember

- Plan before you demolish and demolish according to plan
- Have a written method statement for your demolition site
- Never work on a tank or enclosed vessel without a written permit to work
- Always check whether asbestos is present in the building to be demolished

General health hazards & demolition

Insidious and unexpected health hazards frequently arise during demolition on account of exposure to dust and fumes.

Poisonous fumes may arise when a plant is opened up without having first been properly isolated, purged or cleaned, or when a vessel is entered without taking precautions.

Fumes also arise when flame-cutting of plant which has been painted with zinc or cadmium paint and lead-painted steelwork, and from the inhalation of dust or fumes from chemical deposits.

The site survey should have assessed the risk, and the method statement should set out permit-to-work systems, the use of breathing apparatus, approved respirators, and rescue equipment.

Exposure to asbestos

Exposure to asbestos-bearing materials is now a particular risk in demolition.

Construction workers may be more at risk from the presence of asbestos than almost any other category of worker.

Exposure to asbestos that was commonly used in sprayed insulation on columns and on the underside of ceilings and roofs for fire protection or for thermal insulation is common and very dangerous.

Stringent precautions need to be taken to avoid contaminating the general atmosphere and to prevent breathing in of the dust.

Disposal of asbestos

Material containing asbestos must be removed in isolation from other work, and workers must wear positive pressure breathing apparatus and protective clothing, and be trained in their use and the techniques of asbestos removal.

Where possible, wet methods of asbestos removal should be adopted rather than dry methods.

Special arrangements need to be made by management for the safe disposal of asbestos-contaminated debris.

The best way to deal with asbestos is to employ a specialist company.

Points to remember for demolition workers

Never work on a tank or enclosed vessel without a written permit to work.

Always check whether asbestos is present in the building to be demolished.

Chrysotile
asbestos
fibres

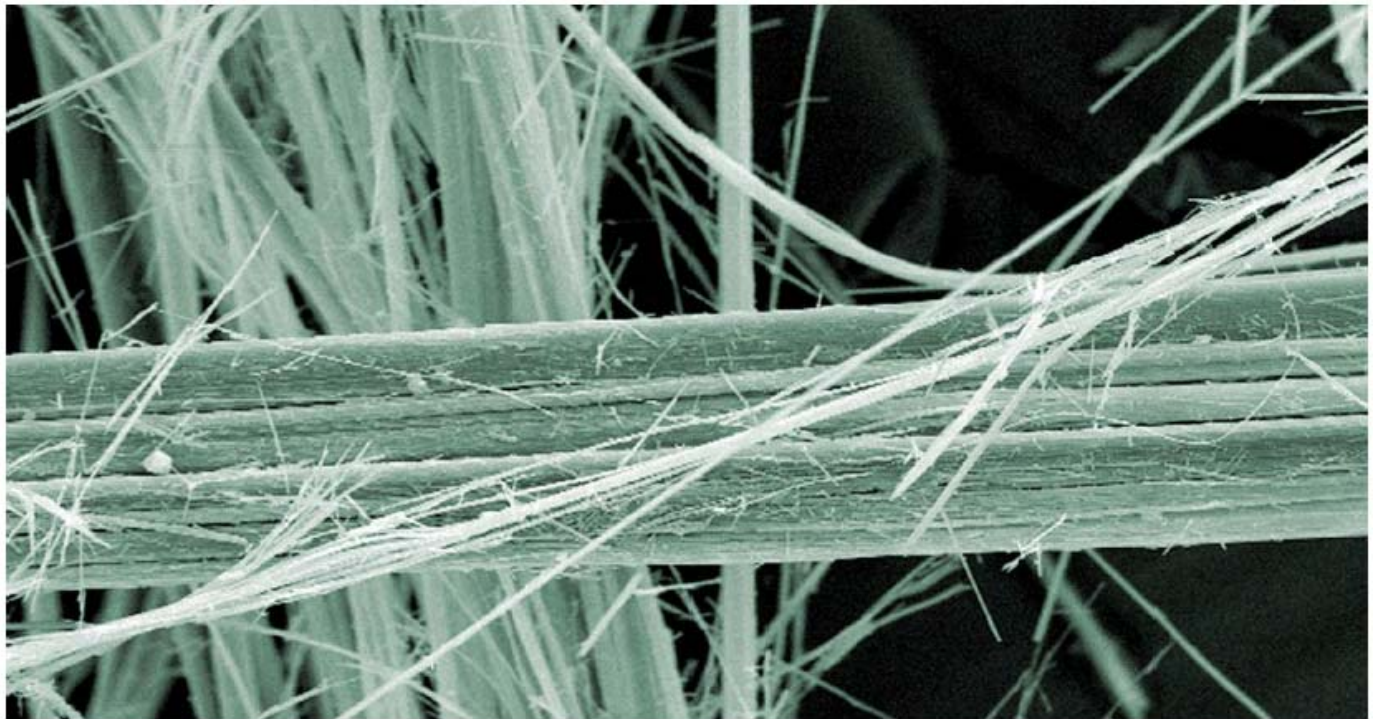

Roof work

Good edge protection is vital

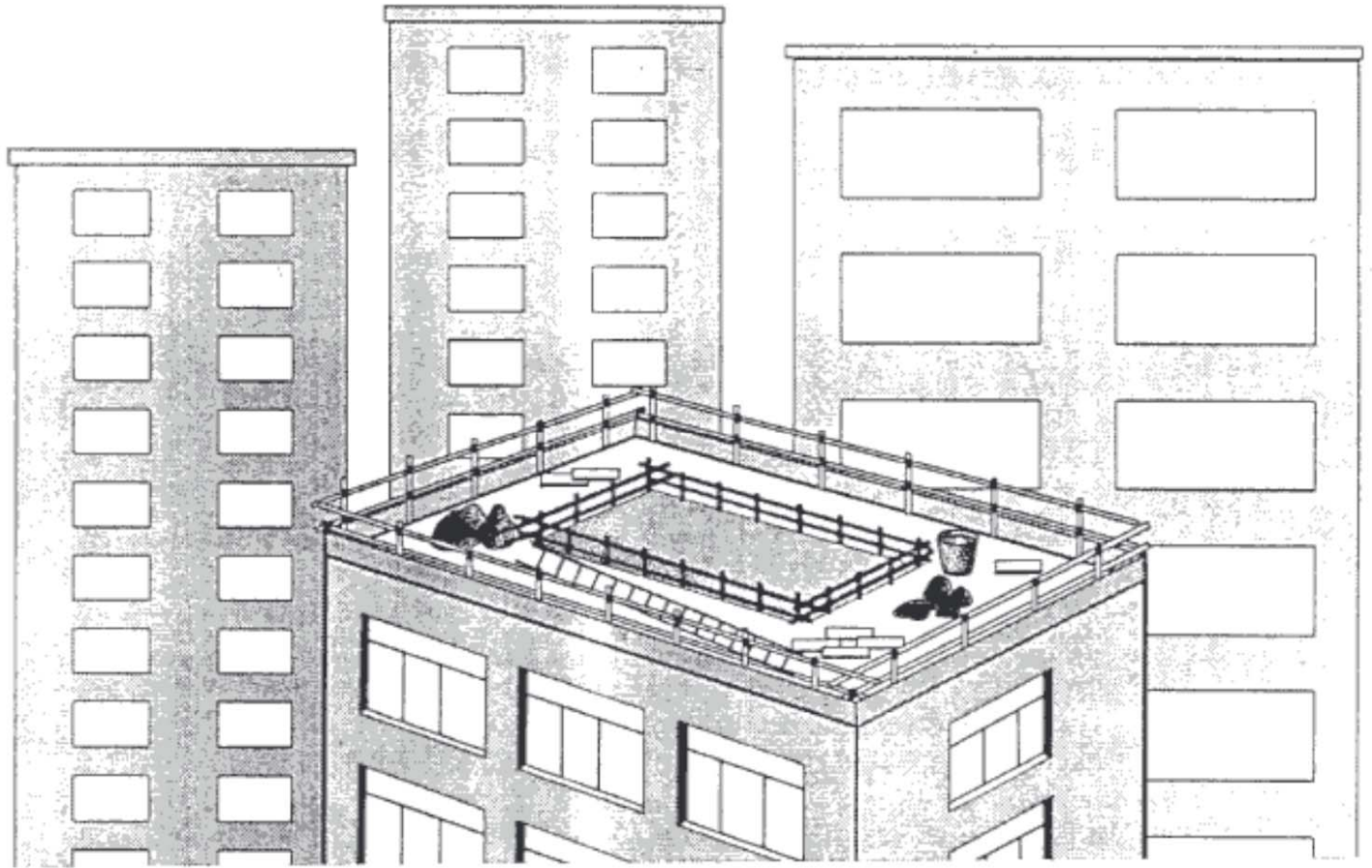

Protection on sloping roofs

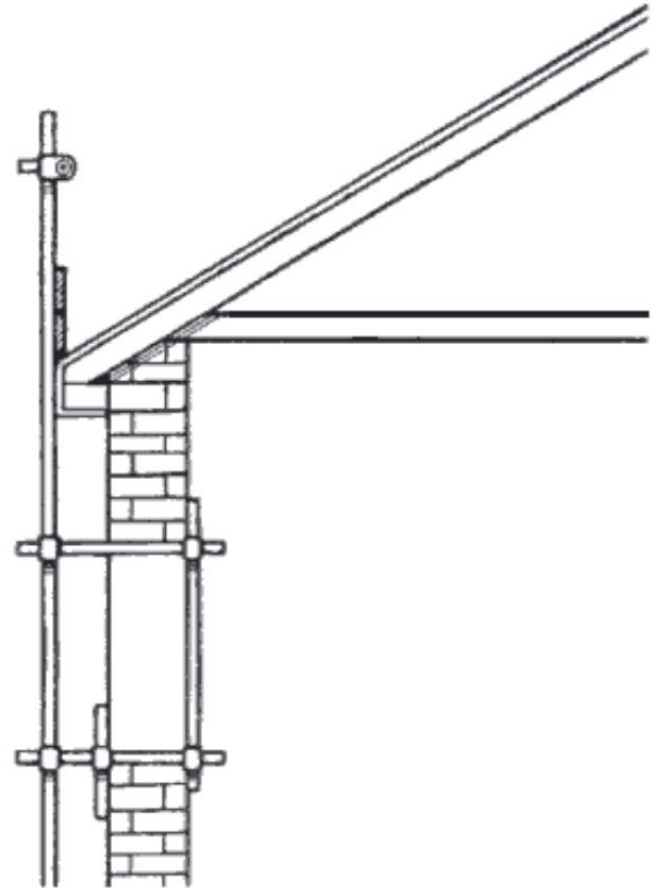
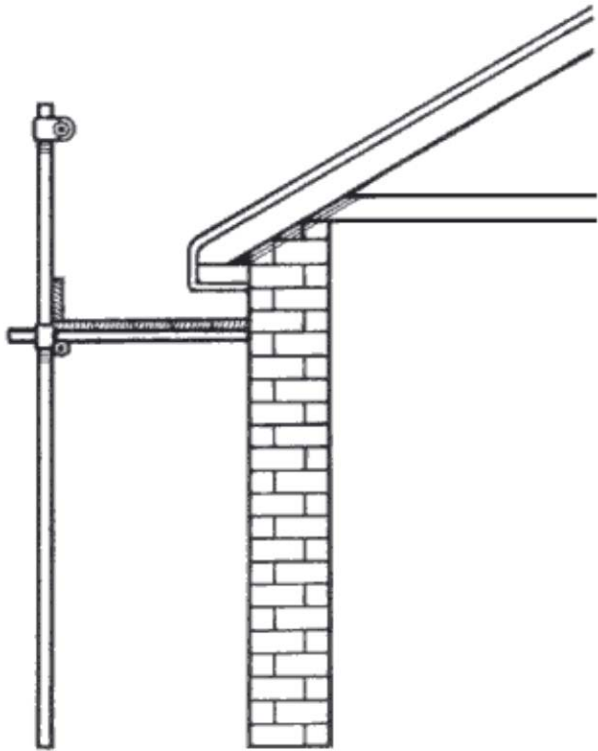

Protection when working on fragile material

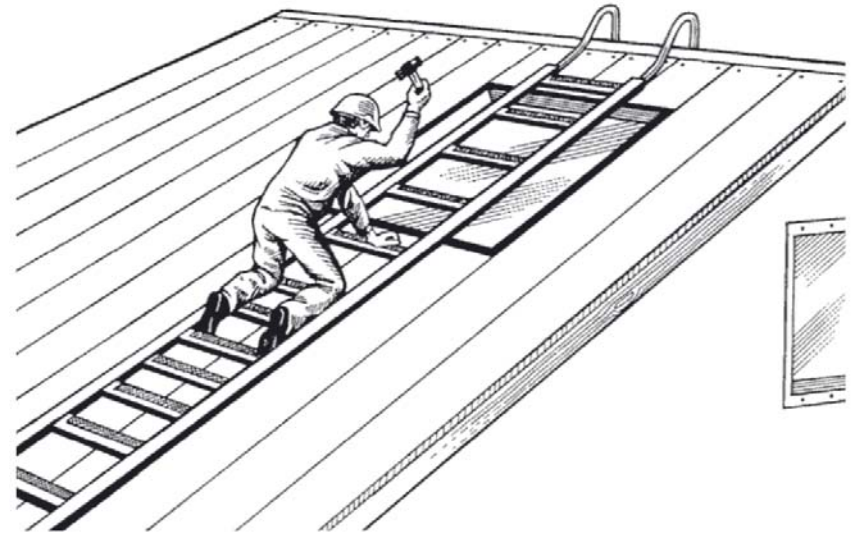
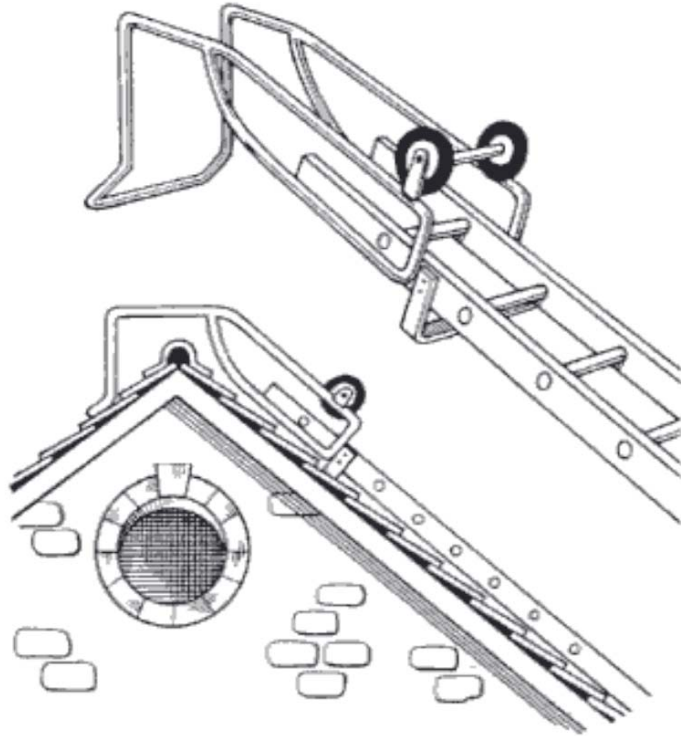

A worldwide problem, even in ‘developed countries’

Four roofers at edge of roof, without fall protection, manhandle lifting and tying off flared top of trash chute with which to funnel old roofing material into dump truck for disposal



Picture and caption by Dr Robert I Carr.

An example of good practice

Poster provided by
Charles Obongpiny,
Uganda Building
Worker's Union

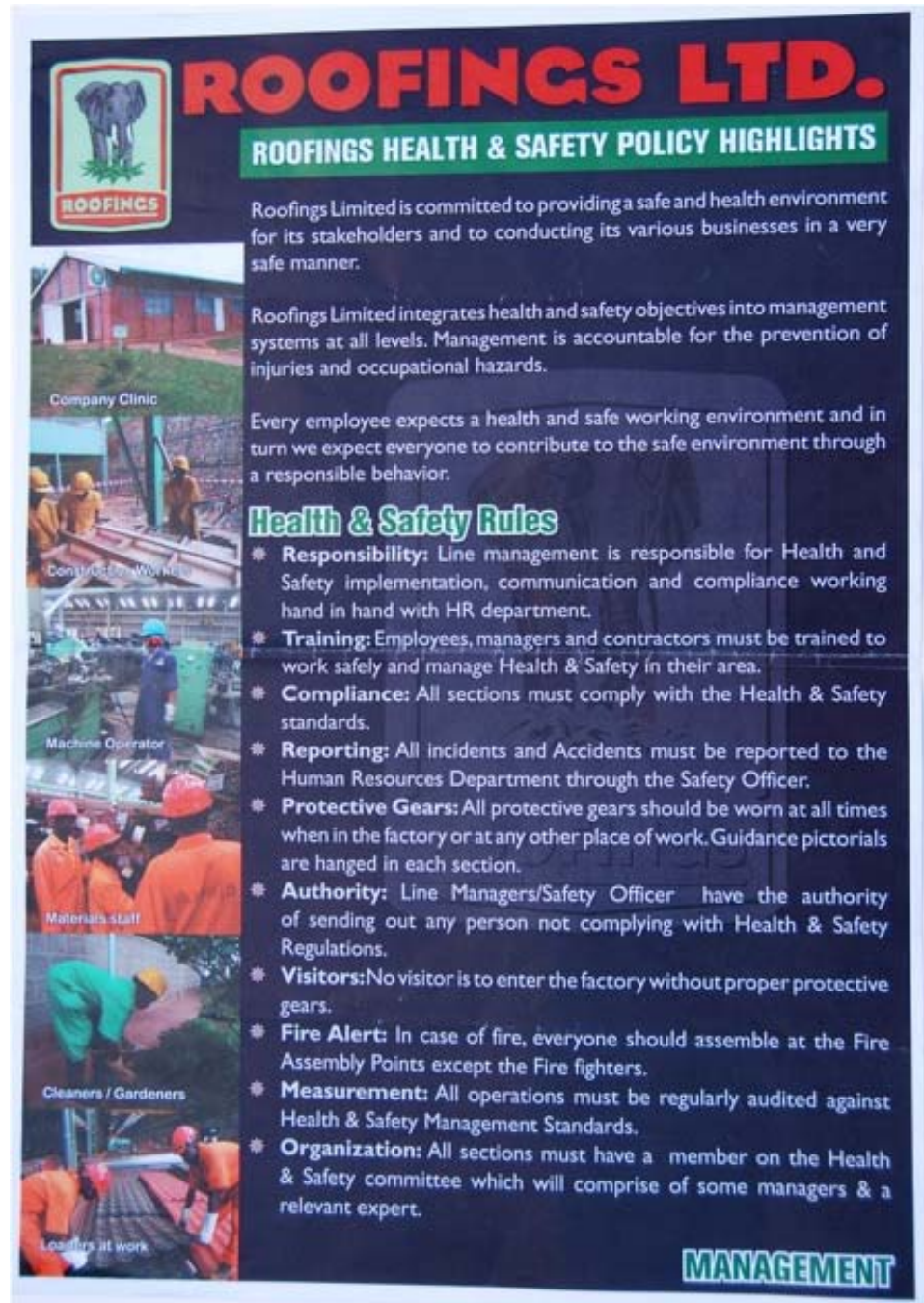

ROOFINGS LTD.

ROOFINGS HEALTH & SAFETY POLICY HIGHLIGHTS

Roofings Limited is committed to providing a safe and health environment for its stakeholders and to conducting its various businesses in a very safe manner.

Roofings Limited integrates health and safety objectives into management systems at all levels. Management is accountable for the prevention of injuries and occupational hazards.

Every employee expects a health and safe working environment and in turn we expect everyone to contribute to the safe environment through a responsible behavior.

Health & Safety Rules

- ✦ **Responsibility:** Line management is responsible for Health and Safety implementation, communication and compliance working hand in hand with HR department.
- ✦ **Training:** Employees, managers and contractors must be trained to work safely and manage Health & Safety in their area.
- ✦ **Compliance:** All sections must comply with the Health & Safety standards.
- ✦ **Reporting:** All incidents and Accidents must be reported to the Human Resources Department through the Safety Officer.
- ✦ **Protective Gears:** All protective gears should be worn at all times when in the factory or at any other place of work. Guidance pictorials are hanged in each section.
- ✦ **Authority:** Line Managers/Safety Officer have the authority of sending out any person not complying with Health & Safety Regulations.
- ✦ **Visitors:** No visitor is to enter the factory without proper protective gears.
- ✦ **Fire Alert:** In case of fire, everyone should assemble at the Fire Assembly Points except the Fire fighters.
- ✦ **Measurement:** All operations must be regularly audited against Health & Safety Management Standards.
- ✦ **Organization:** All sections must have a member on the Health & Safety committee which will comprise of some managers & a relevant expert.

MANAGEMENT

Company Clinic

Construction Work

Machine Operator

Materials staff

Cleaners / Gardeners

Loaders at work

The USA Department of Labor, Occupational Safety and Health Administration (OSHA) offers some excellent PowerPoint slide shows on fall prevention by the OSHA Office of Training and Education

http://www.osha.gov/doc/construction_ecats.html

These can be used to supplement this Theme PowerPoint Presentation

No caption needed!

