



Content and Activities

Chemistry S5

Experimental Version

Kigali, August 2018

Copyright

© 2018 Rwanda Education Board

All rights reserved.

This document is the property of Rwanda Education Board.

TABLE OF CONTENT

TABLE OF CONTENT	3
UNIT 1: INTRODUCTION TO ORGANIC CHEMISTRY	12
Key unit competency.....	12
1.1. Classification of organic compounds	15
1.1.1 Aliphatic compounds	16
1.1.2. Alicyclic compounds	17
1.1.3. Aromatic compounds.....	17
1.2 Types of formulas for organic compounds	19
1.2.1. Empirical formula.....	19
1.1.2. Molecular formula	20
1.2.3. Structural formula.....	22
1.3. Functional groups and homologous series	23
1.3.1 Functional groups	23
1.3.2. Homologous series	25
1.4. General rules of nomenclature of organic compounds according to IUPAC.....	26
1.5. Isomerism in organic compounds	30
1.5.1. Structural isomerism.....	31
1.5.2. Stereoisomerism	33
1.6. End unit assessment	35
UNIT 2: ALKANES	37
2.1. Nomenclature of alkanes	39
2.2. Isomerism	43
2.3 Occurrence of Alkanes	44
2.4. Preparation of alkanes	46
2.5. Physical properties of alkanes	49
2.5. Chemical properties of alkanes	51
2.6. Uses of alkanes.....	55
2.7. End unit assessment	61
UNIT 3: ALKENES AND ALKYNES	62
3.1. Definition, structure and nomenclature of alkenes.....	63
3.3. Isomerism in alkenes.....	66
3.4. Preparation of alkenes	68

3.5. Laboratory preparation and chemical test for ethene	73
3.6. Physical properties of alkenes	76
3.7. Chemical properties.....	77
3.7.1. Additions reactions	77
3.7.2. Oxidation reactions.....	82
3.7.3. Addition polymerisation	85
3.8. Structure, classification and nomenclature of alkynes	87
3.9. Laboratory and industrial preparation of alkynes	89
3.10. Physical properties of alkynes.....	91
3.11. Chemical reactions of alkynes.....	92
3.12. Uses of alkenes and alkynes.....	94
3.13. End unit assessment	97
UNIT 4: HALOGENOALKANES (ALKYL HALIDES).....	100
Key unit competency.....	100
4.1. Definition and Nomenclature of halogenoalkanes	101
4.2. Classification and isomerism	102
4.2.1. Classification of halogenoalkanes	104
4.2.2. Isomerism	104
4.3. Physical properties of halogenoalkanes.....	105
4.4. Preparation methods of halogenoalkanes.....	107
4.5. Chemical properties.....	110
4.6. Chemical test for the presence of halogenoalkanes	120
4.7. Uses of halogenoalkanes and dangers associated with CFCs	122
4.8. End unit assessment	125
UNIT 5: ALCOHOLS AND ETHERS.....	128
Key unit competency:.....	128
5.1. Definition and nomenclature.....	129
5.1.1. Definition.....	129
5.1.2. Nomenclature.....	129
5.3. Classification and isomerism	131
5.3. Alcohol preparations	134
5.4 Preparation of ethanol by fermentation.....	139
5.5 Chemical properties of alcohols.....	143

5.5.1. Oxidation	143
5.5.2. Reaction with sulphuric acid	145
5.5.3. Esterification.....	147
5.5.4. Reaction with strong electropositive metal and metal hydroxides	150
5.6.5 Action of hydrohalic acids (HX)	150
5.6. Uses of alcohols	152
5.7. Ethers.....	154
5.7.1 Structure and isomerism	154
5.7.2. Physical properties.....	155
5.7.3 Preparation of ethers	156
5.8. Chemical properties of ethers.....	156
5.8.1. Reactions in which the carbon – oxygen bond is broken	157
5.8.2 Oxidation reaction	157
5.9. Uses of ethers	158
5.10. End unit assessment	159
UNIT 6: CARBONYL COMPOUNDS: ALDEHYDES AND KETONES.....	162
Key unit competency.....	162
6.1. Definition and nomenclature of carbonyl compounds	162
6.1.1 Definition.....	164
6.1.2 Nomenclature.....	164
6.2. Isomerism.....	166
6.2.1 Functional group isomerism in aldehydes and ketones	167
6.2.2. Position isomerism in ketones	168
6.2.3. Chain isomerism in aldehydes and ketones	168
6.3. Physical properties of aldehydes and ketones	169
6.3.1. Solubility in water aldehydes and ketones	169
6.3.2. Boiling points of aldehydes and the ketones	170
6.4. Chemical properties of carbonyl compounds.....	171
6.4.1. Nucleophilic addition reactions	171
6.4.2. Condensation reactions.....	174
6.4.3. Oxidation reactions using KMnO_4/H^+ and $\text{K}_2\text{Cr}_2\text{O}_7/\text{H}^+$	177
6.4.4. Oxidation reactions using Tollens' reagent	179
6.4.5. Oxidation reactions using Fehling or Benedict solution	180

6.4.6. Iodoform reaction with aldehydes and ketones	182
6.5. Preparation methods of aldehydes and ketones.....	184
6.5.1. Oxidation of alcohols to make ketones and aldehydes.....	184
6.6. Uses of aldehydes and ketones.....	189
6.7. End unit assessment	190
UNIT 7. CARBOXYLIC ACIDS AND ACYL CHLORIDES	193
Key unit competency:.....	193
7.1. Nomenclature and isomerism.....	196
7.1.1. Nomenclature.....	196
7.1.2. Isomerism	198
7.2. Physical properties of Carboxylic acids	200
7.3. Acidity of carboxylic acids	203
7.4. Preparation of carboxylic acids	206
7.4.1. From primary alcohols and aldehydes.....	206
7.4.2. By hydrolysis of acid nitriles and amides with acid or alkali.....	206
7.4.3. From dicarboxylic acid.....	207
7.4.4. From organomagnesium compounds (Carboxylation reaction).....	207
7.4.5. From alkenes (Oxidation of alkenes).....	208
7.4.6. Laboratory preparation of acetic acid.....	208
7.5. Reactions of carboxylic acids.....	209
7.5.1. Reaction involving proton release of acidic O-H group.....	211
7.5.2. Reaction involving the whole group –O-H.....	213
7.5.3. Reduction of carboxylic acids	214
7.6. Uses of carboxylic acids.....	216
7.7. Acyl chlorides and nomenclature	217
7.7.1. Physical properties.....	219
7.7.2. Reactions of acyl chlorides.....	220
7.8. End unit assessment	224
UNIT 8: ESTERS, ACID ANHYDRIDES, AMIDES AND NITRILES	226
Key unit competency:.....	226
8.1 Structure and nomenclature of esters	227
8.1.1. Structure of esters	228
8.1.2. Nomenclature of esters	229

8.1.3. Physical properties and uses of Esters	229
8.1.4. Uses of Esters	230
8.2. Preparation and Chemical properties of Esters	232
8.2.1. Preparation of Esters.....	232
8.2.2. Chemical properties of Esters.....	235
8.3. Saponification and Detergents	238
8.4. Structure and nomenclature of Acid anhydrides	243
8.4.1. Structure of Acid anhydrides	243
8.4.2. Nomenclature of acid anhydrides	244
8.5. Preparation, Chemical properties and uses of Acid anhydrides.....	244
8.5.1. Preparation.....	245
8.5.2. Chemical properties of Acid anhydrides and their uses	246
8.5.3. Uses of acid anhydrides	247
8.6. Structure and nomenclature of amides	248
8.6.1. Structure of Amides.....	249
8.6.2. Nomenclature of amides	250
8.6.4. Uses of Amides.....	251
8.7. Preparation and Chemical properties of Amides.....	253
8.7.1. Preparation of amides	253
8.7.2. Chemical properties of amides	254
8.8. Structure and nomenclature of nitriles	256
8.8.1. Structure of nitriles	256
8.8.2. Nomenclature of nitriles	257
8.8.3. Physical properties and uses of Nitriles.....	257
8.9. Preparation and chemical properties of Nitriles	258
8.9.1. Preparation of Nitriles	258
8.9.2. Chemical properties of Nitriles.....	259
8.10. End Unit assessment	260
UNIT 9. AMINES AND AMINO ACIDS.....	266
Key unit competency:.....	266
9.1. Nomenclature and classification of amines.....	267
9.1.1 Classification of amines.....	268
9.1.2 Nomenclature of amines.....	268

9.2 Physical properties, natural occurrences and uses of amines	272
9.2.1 Physical properties of amines	272
9.2.2 Natural occurrence of amines and their usage	274
9.3 Preparation of amines	275
9.3.1 Alkylation of ammonia	275
9.3.2. Gabriel phthalimide synthesis	276
9.3.3. Hoffmann bromamide degradation reaction	276
9.3.4 Reduction of amides	276
9.3.5 Reduction of nitriles	277
9.3.6 Reduction of nitro compounds	277
9.4. Chemical properties of amines	278
9.4.1 Reactions of amines diluted with acids	278
9.4.2 Reactions of amines (alkylation, acylation, and sulfonation).....	279
9.4.3. Reaction with carboxylic acid	279
9.4.4. Reaction with nitrous acid	280
9.4.5. Reactions with ketones and aldehydes	280
9.4.6. Neutralization reactions	281
9.5. General structure of amino acids and some common examples	282
9.5.1. General structure of amino acids	282
9.5.2. Common Amino Acids.....	283
9.7. Chemical properties of amino acids	289
9.7.1. Acid–base properties of amino acids.....	290
9.7.2. Isoelectric point in aminoacids (pI)	291
9.7.3. Reaction with strong acids.....	292
9.7.4. Reaction with nitrous acid (deamination).....	293
9.7.5. Reaction with sodium hydroxide	293
9.7.6. Reaction of amino acids with sodium carbonate	293
9.8. Optical isomers of amino acids	294
9.9. Peptides and polypeptides	295
9.9.1. Formation of peptide bonds	295
9.9.2. Structure of peptides and polypeptides.....	296
9.9.3. Uses of amino acids as building blocks of proteins.....	298
9.10. End unit assessment	300

UNIT 10. PHASE DIAGRAMS	301
Key unit competency:.....	301
10.1. Phase equilibrium.....	302
10.1.1. Definition of key terms.....	302
10.2. Homogeneous and heterogeneous equilibria.....	303
10.3. Phase diagrams.....	305
10.3. 1. Phase diagram of water.....	307
10.3.2. Phase diagram of carbon dioxide.....	308
10.4. Comparison of phase diagrams of substances that expand and those that contract on freezing.....	310
10.4.1. Melting point curve	311
10.4.2. Triple point	311
10.5. Applied aspect of phase diagrams.....	312
10.6. End unit assessment	313
UNIT 11: SOLUTIONS AND TITRATION.....	316
11.1. Definition of standard solution and primary standard solution.....	317
11.2. Properties of a primary standard solution.	317
11.3. Preparation of Standard solutions	318
11.3.1. Preparation of standard solution by dissolution of solids.....	318
11.3.2. Preparation of standard solution by dilution.....	320
11.4. Simple acid-base titrations	323
11.5. Titration involving redox reactions	330
11.5.1. Titrations with potassium manganate (VII); KMnO_4	330
11.5.2. Titration with potassium dichromate (VI), $\text{K}_2\text{Cr}_2\text{O}_7$	337
11.5.3. Titrations involving sodium thiosulphate and iodine	339
11.6. Back titration.....	347
11.7. Applications of titration	351
11.7.1. Determination of the number of moles of water of crystallization.....	351
11.7.2. Determination of atomic masses.....	353
11.8. END UNIT ASSESSMENT	355
UNIT 12: CONDUCTIVITY OF SOLUTIONS	359
12.1. Conductance of electrolytic solutions	359
12.2. Measurement of conductivity of solutions	362
12.3. Specific conductivity of solutions	363

12.4. Molar conductivity of solutions	364
12.4.1. Strong electrolytes	365
12.4.2. Weak electrolytes	366
12.5. Molar conductivity at infinite dilution	367
12.6. Factors that affect molar conductivity	369
12.7. Kohlrausch's law of individual molar conductivity	370
12.7.1. Molar conductivity at a given concentration	371
12.8. Relation between molar conductivity, degree of ionisation and ionization constant	371
12.9. Use of conductivity measurement in titration and solubility product	372
12.9.1. Using conductivity to find the end point of a titration	373
12.9.2. Determination of solubility product by conductivity measurement	373
12.10. Difference between metallic conductivity and electrolytic conductivity	375
12.11. End unit assessment	376
UNIT 13: ELECTROLYSIS	378
13.1. Definition of electrolysis and Description of electrolytic cells	379
13.2. Electrolysis of sodium chloride	382
13.2.1. Electrolysis of Molten Sodium Chloride	383
13.2.2. Electrolysis of Dilute Sodium Chloride Solution	383
13.2.3. Electrolysis of Concentrated Sodium Chloride Solution	385
13.3. Electrolysis of water	386
13.4. Electrolysis of concentrated copper (II) sulphate solution using inert electrode	389
13.5. Electrolysis of concentrated copper (II) sulphate solution using copper electrodes	393
13.6. Faraday's Laws	396
13.6.1. Faraday's first law	397
13.6.2. Faraday's second law	398
13.7. Factors affecting Electrolysis	399
13.8. Application of electrolysis	406
13.9. End Unit Assessment	412
Unit 14: Enthalpy change of reactions	414
14.1. Definition of standard enthalpy of different reactions	415
14.2. Relationship between temperature and heat	419
14.3. Experimental methods for finding the standard enthalpy of combustion reactions	421
14.4. Experimental methods for finding the standard enthalpy of neutralisation reactions	424

14.5. Hess's law or Law of constant heat summation	427
14.6. Application of Hess's law	430
14.7. Lattice enthalpy	433
14.8. Born-Haber cycle	437
14.9. Born-Haber cycle: Calculations of the lattice enthalpy	441
14.10. Hydration energy	444
14.11. Average standard bond enthalpy	447
14.12. Calculating enthalpy change of reaction using average bond enthalpies	449
14.13. End unit assessment	452
UNIT 15: ENTROPY AND FREE ENERGY	456
15.1. DEFINITION OF ENTROPY AND CHANGE IN ENTROPY	457
15.1.1. Definition of entropy	457
15.1.2. Change in entropy	459
15.2. Second law of thermodynamics	460
15.3. Free energy, the deciding factor	462
15.4. Feasibility of chemical reactions: relationship between free energy, enthalpy and entropy feasibility	465
15.5. End unit assessment	469
Bibliography	474

UNIT 1: INTRODUCTION TO ORGANIC CHEMISTRY

Key unit competency

Apply IUPAC rules to name organic compounds and explain types of isomers for organic compounds

Learning objectives

- *Classify organic compounds as aliphatic, alicyclic and aromatic*
- *Determine different formulae for given organic compounds*
- *Describe the common functional groups and relate them to the homologous series*
- *Use IUPAC rules to name different organic compounds*
- *Describe the isomers of organic compounds*

Introductory activity

Consider the following substances: Sodium chloride, starch, table sugar, magnesium carbonate, glucose, sodium hydrogen carbonate, water.

1. Heat a small sample of each (5g for solids, 5ml for liquids) in a crucible
2. Record your observations.
3. From the observations, classify the substances listed above.
4. What criterion do you use for that classification?
5. Interpret your observations

Organic chemistry is defined as the study of the compounds mainly composed by carbon and hydrogen atoms, and sometimes oxygen, nitrogen, phosphorus, sulphur and halogens atoms. The study of the rest of the elements and their compounds falls under the group of inorganic chemistry. However, there are some exceptions such as carbonates, cyanides, carbides, carbon oxides, carbonic acid, carbon disulphide which are considered as inorganic compounds. Since various organic compounds contained carbon associated with hydrogen, they are considered as derived from hydrocarbons. Thus, a more precise definition of organic chemistry is: **“the study of hydrocarbons and the compounds which could be thought of as their derivatives”**.

The organic and inorganic compounds can be differentiated based on some of their properties as summarised in the following table.

Table 1.1 General features of organic and inorganic compounds

Organic compounds	Inorganic compounds
Form covalent bond	Most form ionic bond
Classified as alcohols, aldehydes, carboxylic acids, etc. with characteristic properties	Exist as acids, bases and salts
Lower melting and boiling points	Higher melting and boiling points
Insoluble in water but soluble in organic solvents such as n-hexane, ethanol, acetone...	Less soluble in water and insoluble in organic solvents
Highly volatile and inflammable	Not volatile and not inflammable
Reactions are generally slow	Reactions are generally fast
Exhibit the phenomenon of isomerism	Very few isomers

Why to study organic chemistry as a separate branch?

The organic chemistry involves the study of all chemical reactions that are commonly used in industries and many other organic reactions that take place in living systems. Materials used in everyday life, food processing and other manufacturing objects are obtained based on organic chemistry. Some other reasons are highlighted below.

- **Large number of compounds:** up to now, no one knows exactly the number of organic compounds that are present in nature.
- **Built of relatively few elements:** The elements frequently encountered in organic compounds are carbon, hydrogen, oxygen, nitrogen, sulphur, phosphorous, and halogens;
- **Unique characteristic of carbon to undergo catenation:** carbon atom is unique among other elements whose atoms possess the capacity to unite with each other by the covalent bonds resulting in a long chain of carbons (i.e: polysaccharides, proteins, polyesters, polyamides...).
- **Isomerism: an organic** with a chemical formula can be represented by two or more different compounds.
- **Functional groups as basis of classification:** Organic molecules contain active atoms or groups of atoms which determine their chemical behaviour. These are called

functional groups joined in a specific manner. Therefore, organic compounds with similar functional groups display similar properties and form a class.

- **Combustibility:** organic compounds are combustible.
- **Nature of chemical reactions:** organic compounds being formed by covalent bonds, they are slow and often have a low yield.

Importance of organic chemistry

The organic chemistry is a subject that plays an important role in modern life. In general, there is no art, science or industry where knowledge of organic chemistry is not applied.

Examples where organic chemistry is applied:

1) Application in daily life.

In our day-to-day life, we find many substances or materials that are commonly used and the later are made of organic compounds.

- *Food:* starch, fats, proteins, vegetables,...
- *Clothes:* cotton, wool, nylon, dacron,
- *Fuels:* petrol, diesel oil, and kerosene
- *Dyes* of all kinds
- *Cosmetics* (body lotion,...)
- *Soaps and detergents*
- *Medicine:* cortisone, sulphonamide, penicillin,...
- *Drugs:* morphine, cocaine,...
- *Stationery:* pencils, paper, writing ink,...
- *Insecticides, rodenticides, ovicides* ...

2) Applications in industry

The knowledge of organic chemistry is required in many industries such as manufacture of food, pharmacy, manufacture of dyes and explosives, alcohol industry, soil fertilisers, petroleum industry, etc.

3) Study of life processes

Organic chemistry in other words is the chemistry of life. For example the vitamins, enzymes, proteins and hormones are important organic compounds produced in our body to ensure its proper development.

1.1. Classification of organic compounds

Activity 1.1.

Observe the following compounds and based on the structure of the chain of each compound, attempt to classify them. By doing your own research, find a collective name for each class of compound that have been established.

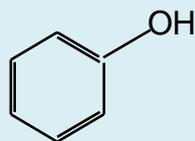
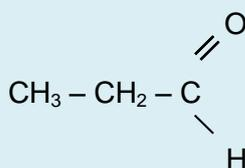
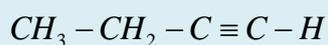
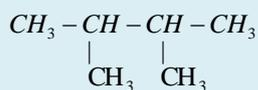
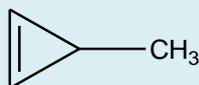
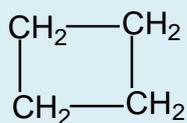
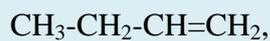

Organic compounds are classified as: aliphatic, alicyclic and aromatic (Figure 1.1)

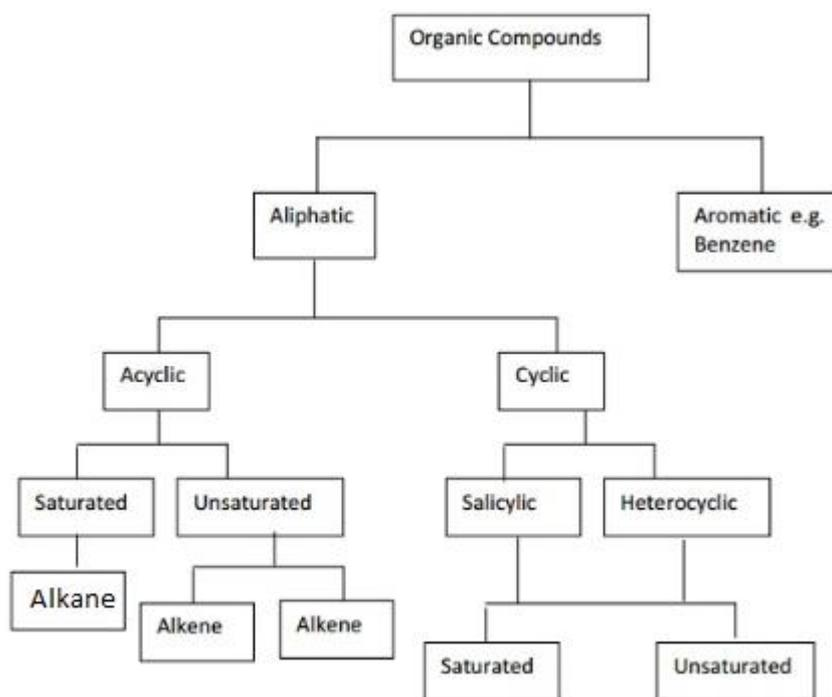

Figure 1.1. Classification of organic compounds

<https://chemistry.tutorvista.com/organic-chemistry/hydrocarbons.html>

1.1.1. Aliphatic compounds

Aliphatic compounds are organic compounds in which the carbon atoms are arranged in a straight or branched chain.

Examples

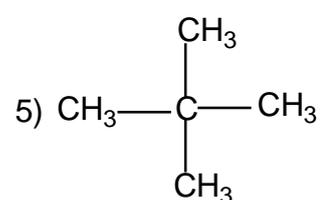
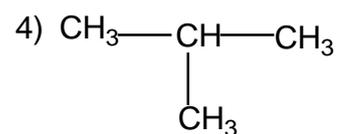
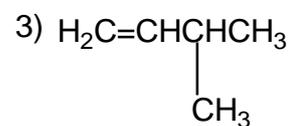
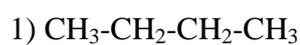

1.1.2. Alicyclic compounds

Alicyclic compounds are organic compounds that contain one or more carbon rings that may be saturated or unsaturated.

Example: 1) cyclobutane

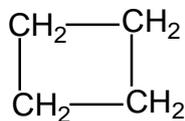

2) Cyclopentane



3) Cyclobutene



1.1.3. Aromatic compounds

Aromatic compounds are compounds that contain a closed ring that consists of alternating single and double bonds with delocalised pi electrons.

Example: 1) Benzene (C₆H₆)

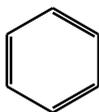

2) Toluene (C₆H₅-CH₃)

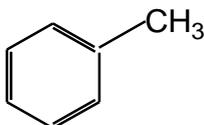

Aromatic compounds are designated as monocyclic, bicyclic and tricyclic if they contain one, two or three rings, respectively.

Examples:

1) Phenol (C₆H₅OH): Monocyclic

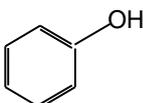

2) Naphthalene: Bicyclic

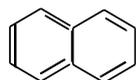

3) Anthracene: Tricyclic

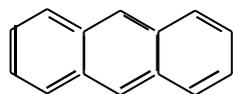

Note: Heterocyclic compounds: Are also classified as cyclic compounds which include one or two atoms other than carbon (O, N, S) in the ring. Thus furan, thiophene and pyridine are heterocyclic compounds.

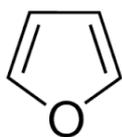

Furan

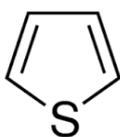

Thiophene

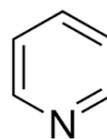

Pyridine

Checking up 1.1:

Observe the following compounds and classify them as aliphatic, alicyclic and aromatic.

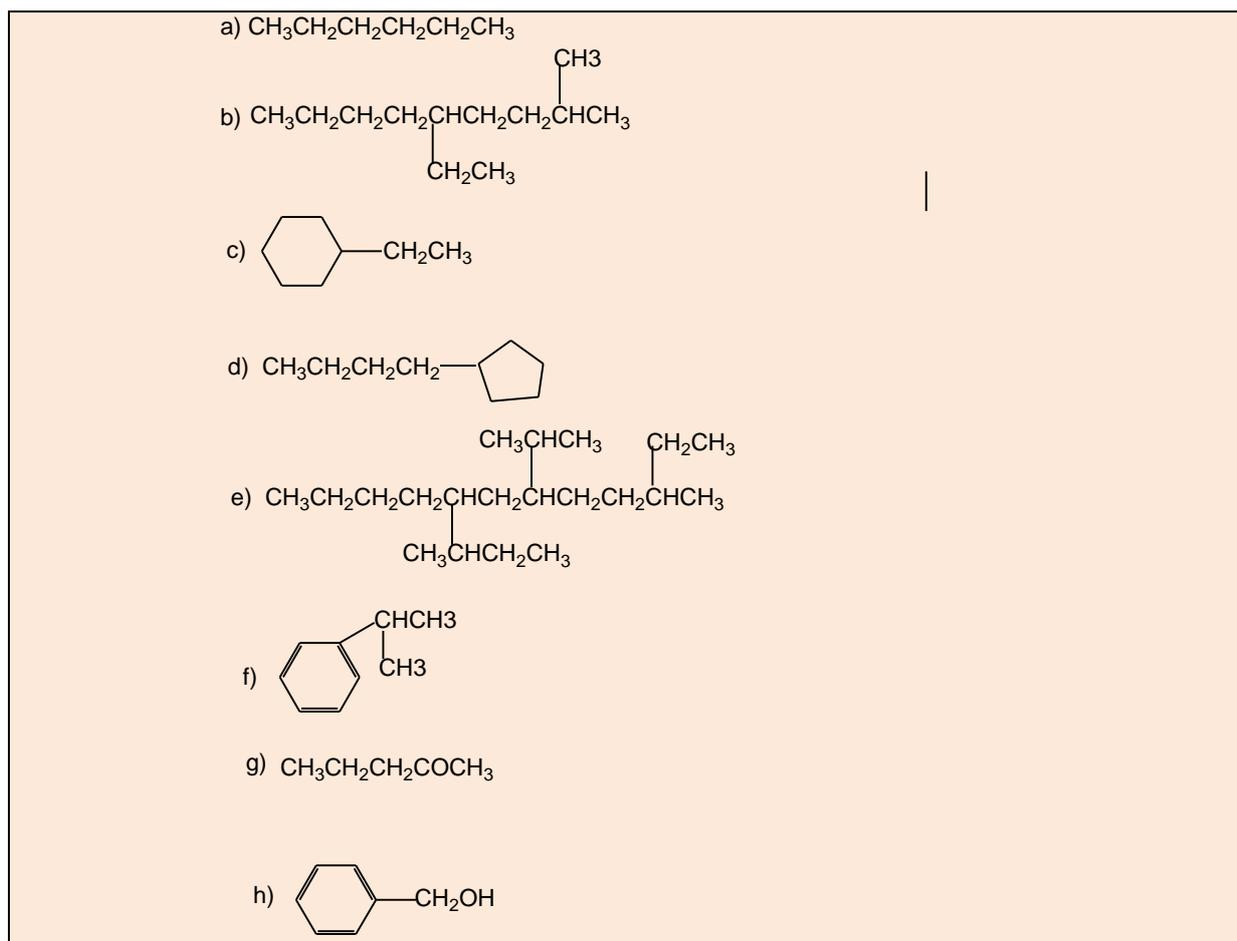

1.2. Types of formulas for organic compounds

Activity 1.2

- 1) Explain the terms empirical, molecular and structural formulae.
- 2) Use examples of organic compounds to differentiate the types of the formulae above.

Atoms bond together to form molecules and each molecule has a chemical formula. In organic chemistry, we can distinguish empirical, molecular and structural formulas.

1.2.1. Empirical formula

The empirical formula is the simplest formula which expresses the ratio of the number of atoms of each element present in a particular compound. The empirical formula is determined using the percentage composition according to the following steps.

- i. The percentage of each element, considered as grams of that element in 100g of the compound, is divided by its atomic mass. This gives the number of moles of the element in 100g of the compound.

ii. The result in i. is then divided by the lowest ratio (number of moles in 100g of the compound), seeking the smallest whole number ratio.

iii. If the atomic ratios obtained in ii. are not the whole number, they should be multiplied by a suitable common factor to convert each of them to the whole numbers (or approximately equal to the whole numbers). Minor fractions are ignored by rounding up or down (ex: 7.95 = 8).

Example

An analysis of organic compound showed that it has 39.13% carbon, 52.23% oxygen and the remaining is hydrogen. Determine the empirical formula of the compound.

Answer:

Elements	C	H	O
% composition	39.13	8.64	52.23
(i) Relative Ratio of atoms or number of moles in 100g	$\frac{39.13}{12} = 3.26$	$\frac{8.64}{1} = 8.64$	$\frac{52.23}{16} = 3.26$
(ii) Smallest ratio	$\frac{3.26}{3.26} = 1$	$\frac{8.64}{3.26} = 2.65$	$\frac{3.26}{3.26} = 1$
(iii) Seeking whole number ratios and Empirical formula: C ₃ H ₈ O ₃	3	7.95 ~ 8	3

Note: 2.65 can not be adjusted to 3 and it is multiplied by 3 equals to 7.95 which is rounded to 8.

1.1.2. Molecular formula

The molecular formula is a formula expressing the exact number of atoms of each element present in a molecule.

Molecular formula = Empirical formula x n

Where: $n = \frac{\text{molecular mass}}{\text{empirical mass}}$

Note: When n = 1, the molecular formula is the same as the empirical formula.

Example 1:

An organic compound contains 31.9% by mass of carbon, 6.8% hydrogen and 18.51% nitrogen and the remaining percentage accounts for oxygen. The compound has a vapour density of 37.5. Calculate the molecular formula of that compound.

Answer:

Elements	C	H	O	N
% composition	31.9	6.8	42.79	18.51
Relative Ratio of atoms,molecules	$\frac{31.9}{12} = 2.568$	$\frac{6.8}{1} = 6.8$	$\frac{42.79}{16} = 2.674$	$\frac{18.51}{14} = 1.322$
Atomic ratio	$\frac{2.568}{1.322} = 2.01 = 2$	$\frac{6.8}{1.322} = 5.14 = 5$	$\frac{2.674}{1.322} = 2.02 = 2$	$\frac{1.322}{1.322} = 1$
Empirical formula :	$C_2H_5NO_2$			

Vapour density = a half molecular mass

Molecular mass = 2 x vapour density = 2 x 37.5 = 75g/mol

$$n = \frac{\text{molecular mass}}{\text{empirical mass}} = \frac{75}{75} = 1$$

Hence the molecular formula = empirical formula = $C_2H_5NO_2$

Example 2:

0.45g of an organic acid on combustion gave 0.44g of carbon dioxide and 0.09g of water. If the molecular mass of the acid is 90, deduce the molecular formula.

Answer:

- Percentage of carbon in CO_2 : $\frac{12}{44} \times \frac{0.44}{0.45} \times 100 = 26.66\%$
- Percentage of hydrogen in H_2O : $\frac{2}{18} \times \frac{0.09}{0.45} \times 100 = 2.22\%$
- Percentage of oxygen = $100 - (26.66 + 2.22) = 71.12\%$

Elements	C	H	O
% composition	26.66	2.22	71.12
Relative Ratio of atoms,molecules	$\frac{26.66}{12} = 2.22$	$\frac{2.22}{1} = 2.22$	$\frac{71.12}{16} = 4.44$
Atomic ratio	$\frac{2.22}{2.22} = 1$	$\frac{2.22}{2.22} = 1$	$\frac{4.44}{2.22} = 2$
Empirical formula	CHO_2		
Molecular formula	N = $90/45 = 2$ $C_2H_2O_4$: oxalic acid		

Note: From the above calculations, we can extend our generalized expression:

$$\% \text{ of C in } CO_2 = \frac{12}{44} \times \frac{m_{CO_2}}{m_{\text{sample}}} \times 100$$

$$\% \text{ of H in H}_2\text{O} = \frac{2}{18} \times \frac{m\text{H}_2\text{O}}{m \text{ sample}} \times 100$$

% of Oxygen = 100 – (% hydrogen + % carbon)

1.2.3. Structural formulas

Structural formula shows how the different atoms in a molecule are bonded (i.e. linked or connected)

There are three types of structural formulas: displayed, condensed and skeletal (stick) formulas.

Example:

Molecular formula	Condensed structural formula	Displayed structural formula	Stick (skeletal) formula
C ₂ H ₆	CH ₃ CH ₃	<pre> H H H — C — C — H H H </pre>	
C ₄ H ₈	CH ₃ -CH ₂ -CH=CH ₂	<pre> H H H H H — C — C — C = C H H H H </pre>	

Note: Stick formula is also considered as structural formula.

Checking up 1.2.

- An organic compound M contains, C (80%), H (6.7%) and the remaining being oxygen.
 - Determine the empirical formula of M.
 - Deduce its molecular formula if the molecular mass of M is 120 g
- A complete combustion of 7.5 g of an organic compound M containing carbon, hydrogen and oxygen gave 17.8 g of CO₂ and 9.27 g of water.
 - Determine the empirical formula of M and deduce its molecular formula if the molecular mass of M is 74 g.
 - Suggest a possible structural (displayed, condensed and skeletal) formula for the compound M.

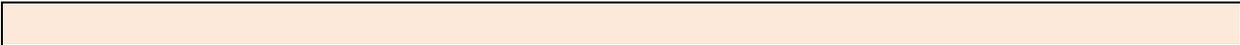

1.3. Functional groups and homologous series

1.3.1 Functional groups

Activity: 1.3.1

Using books or internet, explain the term functional group and point out some common functional groups.

A **functional group** is an atom or group of atoms in a molecule which determines the characteristic properties of that molecule. Examples of some functional groups are indicated in the Table 1.2.

Table 1.2: Name and examples of functional groups in organic compounds

Name	Functional group	Example
Alkanes	RH	CH ₃ CH ₃
Alkenes	C=C	CH ₃ CH=CH ₂
Alkynes	C≡C	CH ₃ C≡CCH ₃
Alkyl halides	RX	CH ₂ CH ₂ Cl
Alcohols	ROH	CH ₃ CH ₂ OH
Ethers	ROR	CH ₃ CH ₂ OCH ₃
Aldehydes	RCHO	CH ₃ CHO
Ketones	RCOR	CH ₃ COCH ₃
Amines	RNH ₂	CH ₃ CH ₂ NH ₂
Carboxylic acids	RCOOH	CH ₃ CH ₂ COOH
Esters	RCOOR	CH ₃ COOCH ₃
Amides	RCONH ₂	CH ₃ CONH ₂
Acyl halides	RCOX	CH ₃ COCl
Acid anhydrides	RCOOCOR	CH ₃ COOCOCH ₃
Nitriles	RC≡N	CH ₃ C≡N
Peroxides	ROOR	CH ₃ OOCH ₃
Peracids	RCOOOH	CH ₃ COOOH
Salts of carboxylic acids	RCOOM	CH ₃ COONa
Etc	Etc	Etc

(Source: Obot Keith, *Organic Chemistry for advanced level*, 2003)

1.3.2. Homologous series

Activity 1.3.2.

By doing your own research, provide the meaning of “homologous series”. What are the characteristics of such a series?

Illustrate your answer by using examples of alkanes, alcohols, carboxylic acids.

When members of a class of compounds having similar structures are arranged in order of increasing molecular mass, they are said to constitute a **homologous series**. Each member of such a series is referred to as a “homologous” of its immediate neighbours. For example, the following sequence of straight chain of alcohols forms a homologous series.

CH₃-OH: Methyl alcohol

CH₃-CH₂-OH: Ethyl alcohol

CH₃-CH₂-CH₂-OH: Propyl alcohol

CH₃-CH₂-CH₂-CH₂-OH: Butyl alcohol etc.

Characteristics of a homologous series

- (1) Any member of the series differs from the next by the unit -CH₂- (methylene group)
- (2) The series may be represented by a general formula of alcohols which is C_nH_{2n+1}OH where n = 1, 2, 3, etc.
- (3) The chemical properties of the members of a homologous series are similar, though in some series the first members show different behaviour.
- (4) The physical properties such as density, melting point and boiling point generally increase within the molecular mass.

Checking up 1.3

- 1) Give a precise definition of "functional group".
- 2) Indicate the functional group in the following compounds:
a) CH₂=CH₂ b) CH₃-CH₂OH c) CH₃-COOH d) CH₃-CH₃ e)
CH₃CH₂CH=CH₂
- 3) Predict which one of the two compounds a) and e) in 2) has the higher boiling point and explain why.

1.4. General rules of nomenclature of organic compounds according to IUPAC

Activity 1.4.

By your own research, describe the rules that are applied to name the organic compounds. Your answers can be given as a form of a report.

The organic compounds are named by applying the rules set by the International Union of Pure and Applied Chemistry (IUPAC). The purpose of the IUPAC system of nomenclature is to establish an international standard of naming compounds to facilitate the common understanding.

In general, an IUPAC name has three essential parts:

- A **prefix** that indicates the type and the position of the substituents on the main chain.
- The **base** or **root** that indicates a major chain or ring of carbon atoms found in the molecule's structure. e.g. **Meth-** for one carbon atom, **eth-** for 2 carbon atoms, **prop-** for 3 carbon atoms, **hex-** for six carbon atoms, etc.
- The suffix designates the functional group.

e.g **-ane** for alkanes, **-ene** for alkenes, **-ol** for alcohols, **-oic acid** for carboxylic acids and so on.

Steps followed for naming organic compounds:

(1) Identify the parent hydrocarbon:

- It should have the maximum length, or the longest chain

Example

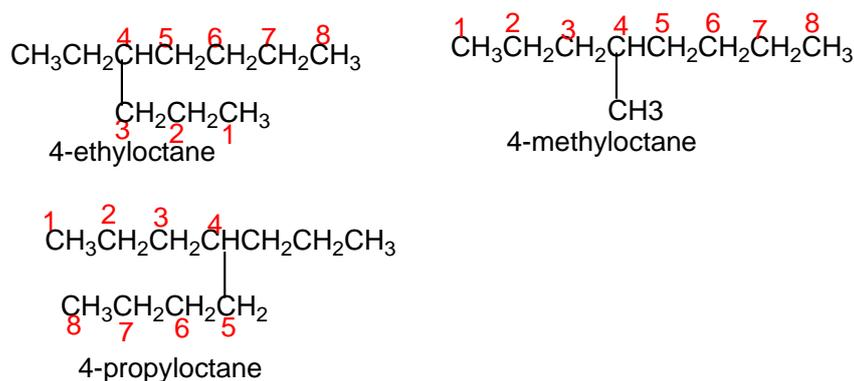

- It should have the maximum number of multiple bonds.

Example

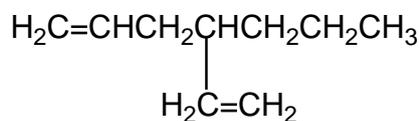

3-propylhexa-1,5-diene and not 4-vinyl-1-heptene

(2) Identify the parent functional group, if any, with the highest order of priority.

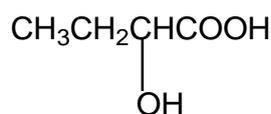

eg: 2-hydroxybutanoic acid

(3) Identification of the side chains.

Side chains are usually alkyl groups. An **alkyl group** is a group obtained by a removal of one hydrogen atom from an alkane. The name of alkyl group is obtained by replacing **-ane** of the corresponding alkane by **-yl** (**Table 1.3**).

Table 1.3. Nomenclature of alkyl group

Formula of alkyl group	Corresponding alkane	Name of the alkyl group
$\text{C}_n\text{H}_{2n+1}-$	Alkane	Alkyl
CH_3-	Methane	Methyl

CH_3CH_2- (C_2H_5-)	Ethane	Ethyl
$\text{CH}_3\text{CH}_2\text{CH}_2-$	Propane	Propyl
$\text{CH}_2\underset{\text{ }}{\text{C}}\text{HCH}_3$	Propane	Isopropyl
$\text{CH}_3\text{CH}_2\text{CH}_2\text{CH}_2-$	Butane	Butyl
$\text{CH}_2\underset{\text{ }}{\text{C}}\text{HCH}_2\text{CH}_3$	Butane	Sec-(s-) butyl
$\text{CH}_3\underset{\text{ }}{\text{C}}\text{HCH}_2-$ $\quad\quad\quad\text{CH}_3$	Methylpropane (isobutene)	Isobutyl
$\text{CH}_3\underset{\text{ }}{\underset{\text{ }}{\text{C}}}\text{CH}_3$ $\quad\quad\quad\text{CH}_3$	Methylpropane (isobutene)	Tertio-(t-) butyl
$\text{CH}_3\text{CH}_2\text{CH}_2\text{CH}_2\text{CH}_2-$	Pentane	Pentyl
CH_3 $\text{CH}_3\underset{\text{ }}{\underset{\text{ }}{\text{C}}}\text{CH}_2-$ $\quad\quad\quad\text{CH}_3$	2,2-dimethylpropane (neopentane)	Neopentyl

A side chain must be identified by the smallest possible numbers.

Example:

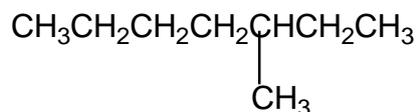

3-methylheptane and not 5-methylheptane

- (4) If the same substituent occurs two or more times, the prefix **di, tri, tetra,** ...is attached to substituent's name. Its locants separate the prefix from the name of the substituent.

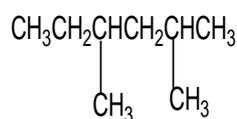

2,4-dimethylhexane

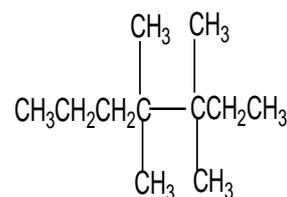

3,3,4,4-tetramethylheptane

- (5) Identify the remaining functional groups, if any, and name them. Different side chains and functional groups will be listed in alphabetical order.

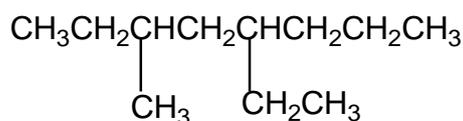

5-ethyl-3-methyloctane
not 3-methyl-5-ethyloctane

- (6) The prefixes *di*, *tri*, *tetra*,...are not taken into consideration when grouping alphabetically. But prefixes such **iso-**, **neo-** are taken into account.

Example:

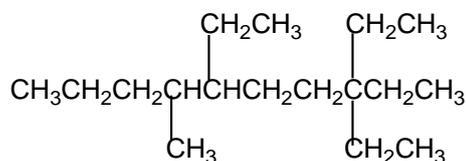

3,3,6-triethyl-7-decane

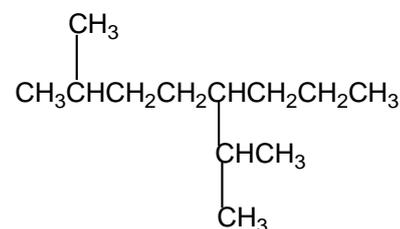

5-isopropyl-2-methyloctane

- (7) Identify the position of the double/triple bond.

Example:



- (8) Number the chain (left to right) or right to left).

The sum of the numbers which show the location of the substituents is the possible smallest.

Examples:

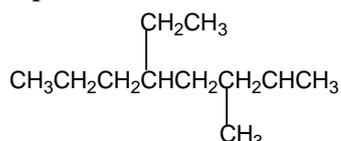

5-ethyl-3-methyloctane and not **4-ethyl-6-methyloctane**

The correct name will be the one which shows the substituents attached to the third and fifth carbon, respectively and not to the fourth and the sixth carbon atom.

- (9) Numbers are separated by commas Hyphens are added between numbers and words. Successive words are merged in one word.

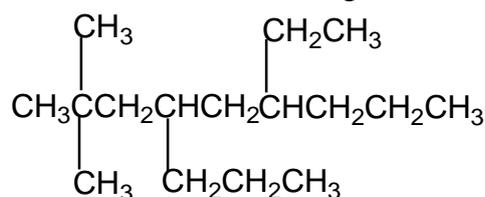

6-ethyl-2,2-dimethyl-4-propylnonane.

Checking up 1.4

- 1) Complete the sentence; the systematic nomenclature of organic compounds follows rules established by the
- 2) What are the main parts which made up the name of an organic compound?
- 3) Name each of the following compounds using the IUPAC system.

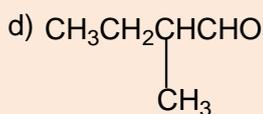
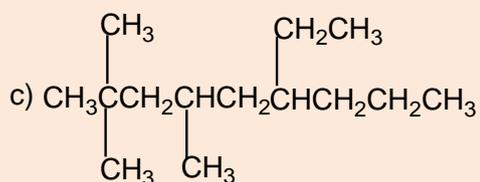
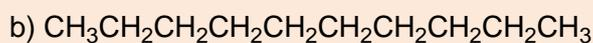
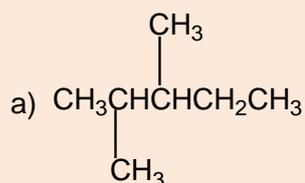

1.5. Isomerism in organic compounds

Activity 1.5: Consider the following set of compounds:

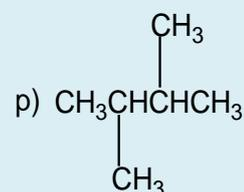
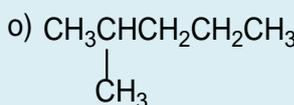
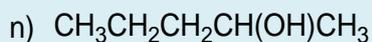
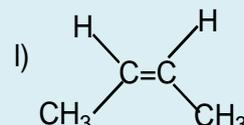
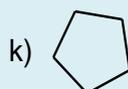
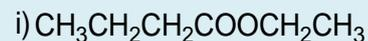
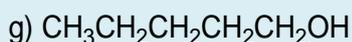
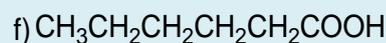
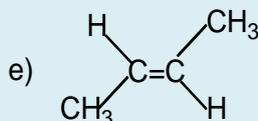
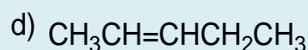
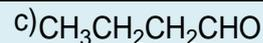
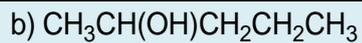
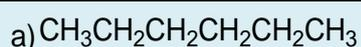

Analyse the structure of the compounds listed above and point out:

- 1) Compounds with the same structural formula
- 2) Compounds with the same molecular formula
- 3) Are there any compounds having the same molecular formula but different by their structures? Explain the main differences displayed by them? Name the relationship between them?
- 4) Explain the behaviour of the identified in 3)

Isomerism is the existence of compounds that have the same molecular formula but different arrangements of atoms; these compounds are called “**isomers**”.

Isomers have different physical or/and chemical properties and the difference may be great or small depending on the type of isomerism.

There are two main classes of isomerism: *Structural isomerism* and *stereoisomerism*.

1.5.1. Structural isomerism

Activity 1.5.1

1. Referring to the previous activity 1.5 above, what is the relationship between compounds: a), o and p) in the list of the activity 1.5?
2. Identify the relationship between compounds b) and g) in the activity 1.5?

3. Relate the relationship between compounds: b) and J) in the activity 1.5?
4. Estimate the relationship between compounds c) and h) in the activity 1.5?
5. Investigate if there is a relationship between compounds d) and k) in the activity 1.5?

Structural isomers are compounds with the same molecular formula but with different structural formula.

Example:

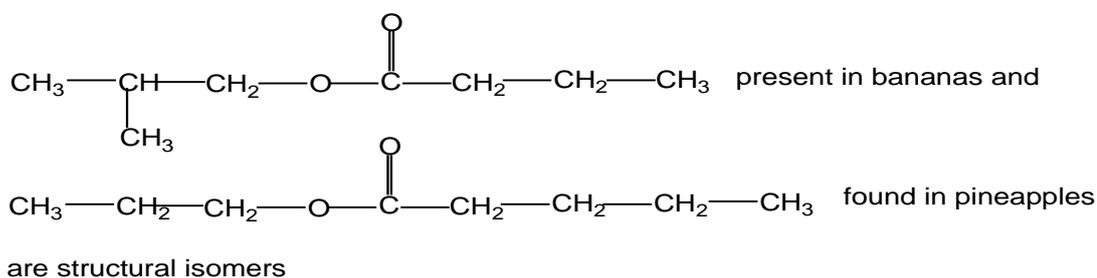

1) Position isomerism

Position isomers are compounds with the same molecular formula but different positions of the functional group or substituent(s).

Examples:



2) Chain isomerism

Chain isomers are compounds with the same molecular formula, belonging to the same homologous series, with chain of carbon atoms of different length.

Examples:

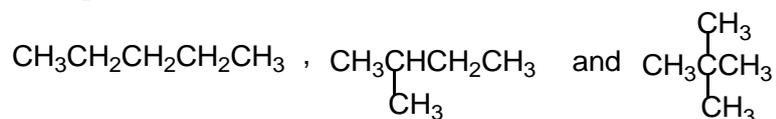

3) Functional isomerism

Functional (group) isomers are compounds which have the same molecular formula but different functional groups.

Examples:

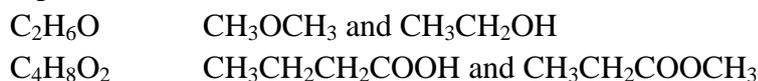

1.5.2. Stereoisomerism

Activity 1.5.2

- (1) What is the relationship between compounds e) and l) in the activity 1.5. ?
- (2) Suggest examples of other organic compounds which have a similar relationship.

1) Geometrical isomerism

Geometrical isomers or cis-trans isomers are compounds with the same molecular formula, same arrangement of atoms but differ by spatial arrangements.

This type of isomers is mainly found in alkenes due to the restricted rotation around the carbon-carbon double bond.

Note: For more information, visit the website below. (<https://www.youtube.com/watch?v=7tH8Xe5u8A0>).

The necessary condition for an alkene to exhibit geometrical isomerism is that each carbon doubly bonded has two different groups attached to it.

Examples:

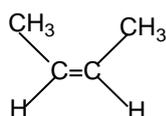

cis-2-butene

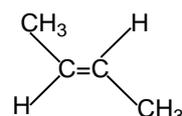

trans-2-butene

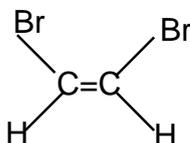

cis-1,2-dibromoethane

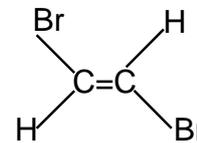

trans-1,2-dibromoethane

2) Optical isomerism

Activity 1.5.3.

- (1) Look at your two hands or the Figure 1.2 and discuss the relationship between them?
- (2) What are the necessary conditions for such pairs of organic compounds to exhibit that relationship?
- (3) What name is given to such compounds?

Optical isomers are compounds with the same molecular formula and arrangements of atoms but have different effect on the plane polarised light.

- A compound that rotates the plane polarised light is said to have an **optical activity**.
- This type of isomerism occurs in compounds containing an asymmetric (asymmetrical) carbon atom or **chiral centre**¹.
- When a molecule has chiral centre, there are two non superimposable isomers that are mirror images of each other.
- Such compounds are called **enantiomers**.

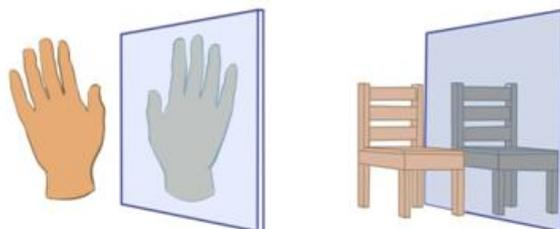
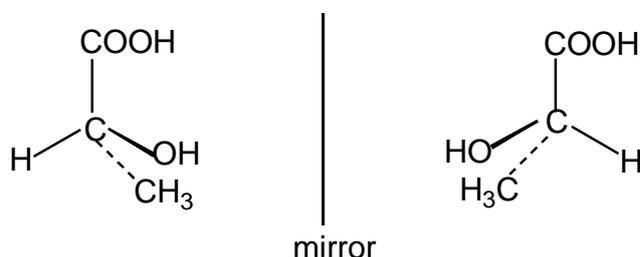

Figure 1.2 Mirror images

In a mirror, the left hand is the image of the right hand and they are nonsuperimposable, i.e. they are enantiomers. An achiral object is the same as its mirror image, they are nonsuperimposable.

Examples:

2-hydroxypropanoic acid, $\text{CH}_3\text{CHOHCOOH}$



2-aminopropanoic acid, $\text{CH}_3\text{CH}(\text{NH}_2)\text{COOH}$

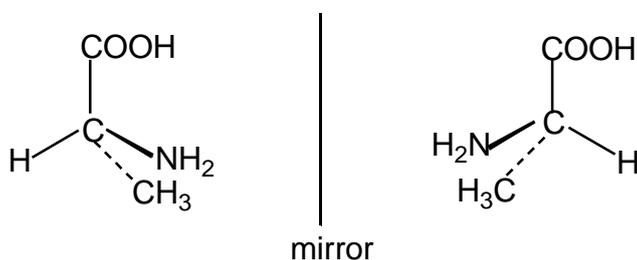

Checking up 1.5

- 1) What is meant by “isomers”
- 2) Using examples, distinguish structural isomers and stereoisomers. Describe the sub-classes of each type of isomers.

¹Chiral originates from the Greek name for Hand

- 3) Explain how the nature of the C=C bond gives rise to cis-trans isomerism.
- 4) Identify which of the isomers of hexene exhibit geometrical isomerism.
- 5) Which of the following compounds can exist as optical isomers? Justify your answer
 - a) $\text{CH}_3\text{CH}_2\text{CH}_2\text{CH}_2\text{CH}_3$
 - b) $\text{CH}_3\text{CH}(\text{Cl})\text{CH}_3$
 - c) $\text{CH}_3\text{CH}_2\text{CH}(\text{NH}_2)\text{CH}_3$
 - d) $\text{CH}_3\text{CH}_2\text{CH}_2\text{CH}(\text{CH}_3)_2$
- 6) Give examples of items which are enantiomers.

1.6. End unit assessment

- 1) a) An atom or group of atoms which dictates the characteristic properties of an organic compound is.....
 b) A set of compounds that have the same functional group is referred as
- 2) Chain isomers belong to the same class. True/False
- 3) Organic compounds belonging to the same class have similar physical properties. True/False
- 4) What is the name of the following compound?

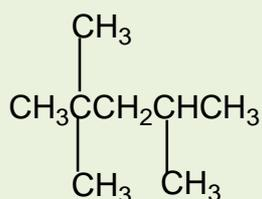

- A 1,1-butyl-2- methylpropane
 - B 2,2,4-trimethylpentane
 - C 2,2,4-methylpentane
 - D 2,4,4-trimethylpentane
 - E none of the previous answers
- 5) The compound that follows belongs to which class of organic compounds?
- $$\text{HC}\equiv\text{CCH}_2\text{CH}_3$$
- A alcohols
 - B alkenes
 - C alkynes

D aromatic

6) The compound that follows belongs to which class of compounds?

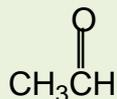

- A ethers
B aldehydes
C ketones
D alcohols
- 7) Write the structural formula of:
- 4-ethyl-3-methylheptane
 - 3-ethyl hexane
 - 3,3,5-trimethyloctane
 - 4-ethyl-2,2-dimethylnonane
- 8) Consider the following compound.
- $$\text{CH}_3\text{CH}_2\text{CH}_2\text{CH}_2\text{OH}$$
- Determine the percentage composition of each element present in the compound.
 - Determine the empirical formula of the above molecule
 - From the results from a) calculate the molecular formula of the compound
 - Write all possible structural formulae of isomers of the compound.
 - Name the isomers in d) according to the IUPAC system.
 - (i) From the results in d) classify the isomers as chain, position, functional and optical isomers.
(ii) From the results in d) show the compound that can exhibit optical isomerism.

UNIT 2: ALKANES

Key unit competency

Relate the physical and chemical properties of the alkanes to the preparation methods, uses and isomerism.

Learning objectives

- Name straight chain alkanes up to carbon-20
- Define homologous series
- Use IUPAC system to name straight and branched alkanes
- Describe the preparation methods of the alkanes
- Prepare and collect methane gas
- Respect of procedure in experiment to carry out preparation of methane or propane
- Describe and explain the trend in physical properties of homologous series of alkanes
- Be aware of the dangers associated with combustion reactions of the alkanes
- Write reaction for free radical mechanism for a photochemical reaction

- *State the chemical properties of the alkanes*
- *Develop practical skills, interpret results make appropriate deductions.*
- *Appreciate the importance of the alkanes in daily life*
- *Appreciate the dangers caused by the alkanes to the environment as major sources of air contaminants*
- *State the uses of the alkanes*

Introductory activity

Analyse the picture below and answer to the proposed questions



a) Explain the process observed in the above picture

- b) What is the source of the gas produced as shown by the picture?
c) Analyse the environmental problems caused by gas observed in the picture and suggest different ways to solve it.

Alkanes are the simplest class of organic compounds. They are made of carbon and hydrogen atoms only and contain two types of bonds, carbon-hydrogen (C-H) and carbon-carbon (C-C) single covalent bonds. They do not have functional groups.

Alkanes form a homologous series with the general formula C_nH_{2n+2} where n is the number of carbon atoms in the molecule. The first member of the family has the molecular formula CH_4 (n=1) and is commonly known as methane and the second member with molecular formula C_2H_6 (n=2) is called ethane.

These compounds are also known as saturated **hydrocarbons**. This name is more descriptive than the term “alkane” because both their composition (carbon and hydrogen) and the fact that the four single covalent bonds of each carbon in their molecules are fully satisfied or ‘saturated’.

The name alkane is the generic name for this class of compounds in the IUPAC system of nomenclature. These hydrocarbons are relatively unreactive under ordinary laboratory conditions, but they can be forced to undergo reactions by drastic treatment. It is for this reason that they were named paraffins (**Latin parum affinis** = little activity).

2.1. Nomenclature of alkanes

Activity 2.1

- 1) Discuss IUPAC rules for naming straight and branched alkanes.
- 2) Draw the structure of the following compounds:
 - (a) 3-ethyl-4-propyloctane
 - (b) 4-ethyl-2-methylhexane
 - (c) 2,2-dimethylpentane

IUPAC Rules for the nomenclature of alkanes

- a) Find and name the longest continuous carbon chain.
- b) Identify and name groups attached to this chain.
- c) Number the chain consecutively, starting at the end nearest a substituent group.
- d) Designate the location of each substituent group by an appropriate number and name.
- e) Assemble the name, listing groups in alphabetical order. The saturated hydrocarbon form homologous series (series in which members have similar chemical properties and each differs from the preceding by a methylene group $-CH_2-$).

The first four members are known by their common names, from C₅ and above the Roman prefixes indicating the number of carbon atoms is written followed by the ending “ane” of the alkanes.

Note: Alkyl groups are obtained when one hydrogen atom is removed from alkanes; therefore their names are deduced from the corresponding alkanes by replacing “ane” ending with “yl” desinence (Table 2.1).

Table 2.1. Examples of naming alkanes

n	Name of residue	R-H	Alkane	alkyl R	Residue	Abbreviation
1	Meth	ane	CH ₄	-yl	CH ₃ -	Me
2	Eth	ane	CH ₃ CH ₃	-yl	CH ₃ CH ₂ -	Et
3	Prop	ane	CH ₃ CH ₂ CH ₃	-yl	CH ₃ CH ₂ CH ₂ -	Pr
4	But	ane	CH ₃ (CH ₂) ₂ CH ₃	-yl	CH ₃ (CH ₂) ₂ CH ₂ -	Bu
5	Pent	ane	CH ₃ (CH ₂) ₃ CH ₃	-yl	CH ₃ (CH ₂) ₃ CH ₂ -	Pe
6	Hex	ane	CH ₃ (CH ₂) ₄ CH ₃	yl	CH ₃ (CH ₂) ₄ CH ₂ -	Hex
7	Hept	ane	CH ₃ (CH ₂) ₅ CH ₃	yl	CH ₃ (CH ₂) ₅ CH ₂ -	Hep
8	Oct	ane	CH ₃ (CH ₂) ₆ CH ₃	yl	CH ₃ (CH ₂) ₆ CH ₂ -	Oct
9	Non	ane	CH ₃ (CH ₂) ₇ CH ₃	yl	CH ₃ (CH ₂) ₇ CH ₂ -	Non
10	Dec	ane	CH ₃ (CH ₂) ₈ CH ₃	yl	CH ₃ (CH ₂) ₈ CH ₂ -	Dec
11	Undec	ane	CH ₃ (CH ₂) ₉ CH ₃	yl	CH ₃ (CH ₂) ₉ CH ₂ -	-
12	Dodec	ane	CH ₃ (CH ₂) ₁₀ CH ₃	yl	CH ₃ (CH ₂) ₁₀ CH ₂ -	-
13	Tridec	ane	CH ₃ (CH ₂) ₁₁ CH ₃	yl	CH ₃ (CH ₂) ₁₁ CH ₂ -	-
14	Tetradec	ane	CH ₃ (CH ₂) ₁₂ CH ₃	yl	CH ₃ (CH ₂) ₁₂ CH ₂ -	-
15	Pentadec	ane	CH ₃ (CH ₂) ₁₃ CH ₃	yl	CH ₃ (CH ₂) ₁₃ CH ₂ -	-
16	Hexadec	ane	CH ₃ (CH ₂) ₁₄ CH ₃	yl	CH ₃ (CH ₂) ₁₄ CH ₂ -	-
17	Heptadec	ane	CH ₃ (CH ₂) ₁₅ CH ₃	yl	CH ₃ (CH ₂) ₁₅ CH ₂ -	-
18	Octadec	ane	CH ₃ (CH ₂) ₁₆ CH ₃	yl	CH ₃ (CH ₂) ₁₆ CH ₂ -	-
19	Nonadec	ane	CH ₃ (CH ₂) ₁₇ CH ₃	yl	CH ₃ (CH ₂) ₁₇ CH ₂ -	-

20	icos	ane	$\text{CH}_3(\text{CH}_2)_{18}\text{CH}_3$	yl	$\text{CH}_3(\text{CH}_2)_{18}\text{CH}_2-$	-
----	------	-----	--------------------------------------------	----	---------------------------------------------	---

Note: n is the number of carbon atoms

Prefixes **di**, **tri**, **tetra**, **sec**, **tert**, are not considered when alphabetizing.

- f) In case of chains of the same length, the priority is given for part where many branched of alkyl groups appear.

Example

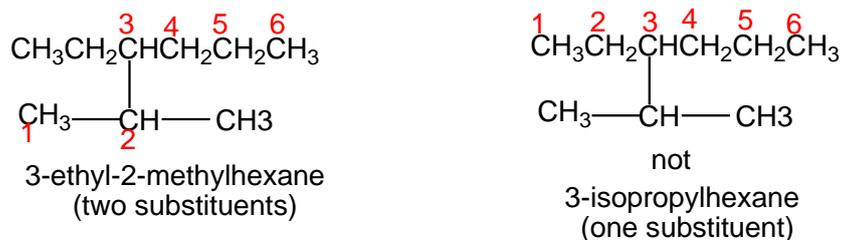

- g) For cyclanes or cycloalkanes, the prefix “**cyclo**” is recommended, followed by the name of the alkanes of the same carbon number.

But in case of ramified cyclanes, the priority is for the ring.

Examples:

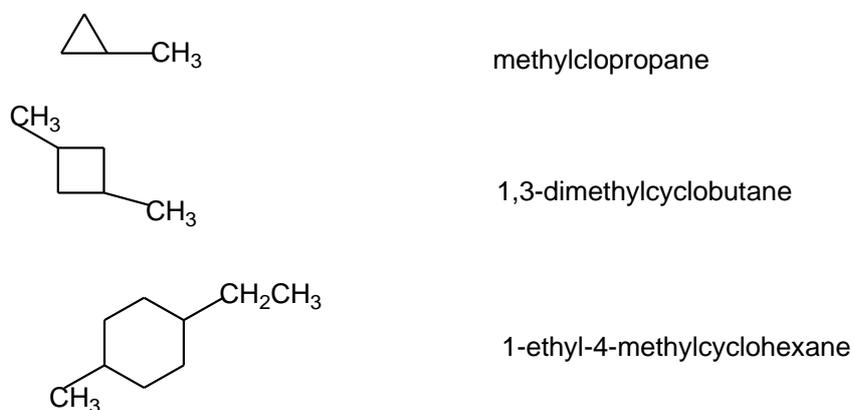

Checking up 2.1

1. What are alkanes? Why are they called saturated hydrocarbons?
2. Name each of the following alkanes according to the IUPAC system.

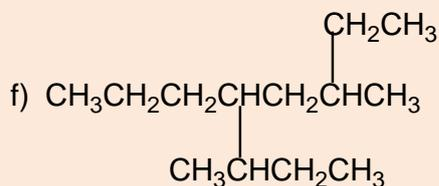
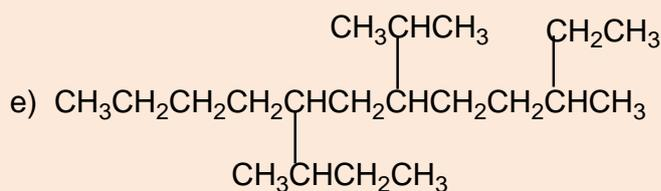
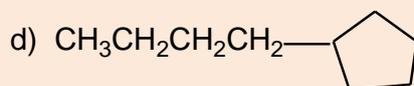
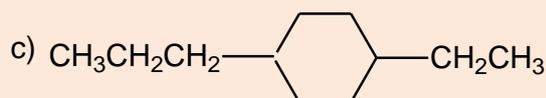
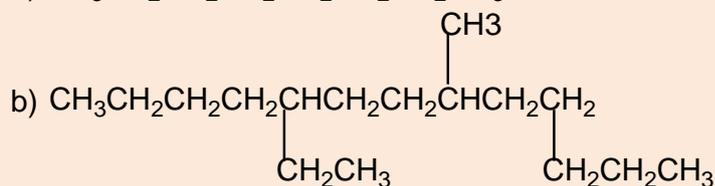
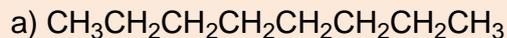

2.2. Isomerism

Activity 2.2.

Identify and write down all the structural formulas that fit the molecular formula C_6H_{14} and classify them into the position and chain isomers.

Alkanes show structural isomerism. The easiest way to find isomers is to draw the longest chain of carbon atoms first and then reduce it by one carbon first until repetition begins to occur.

E.g. C_6H_{14}

- (a) $\text{CH}_3\text{-CH}_2\text{-CH}_2\text{-CH}_2\text{-CH}_2\text{-CH}_3$: n-hexane (straight chain isomer)
- (b) Then reduce the length by one methyl group gives 5 carbon atoms
- (c) Substitute one hydrogen on carbon (2) by the methyl group

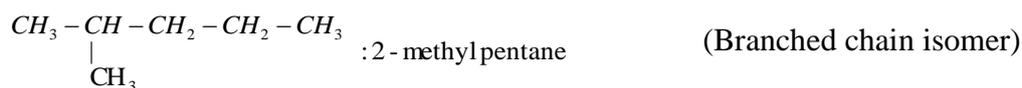

(d) Substitute one hydrogen on carbon (3) by the methyl group

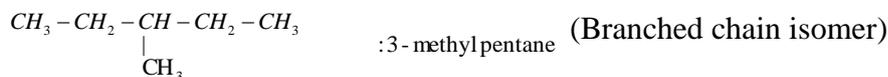

(e) Longest chain reduced further to 4 carbon atoms by cutting 2 methyl groups

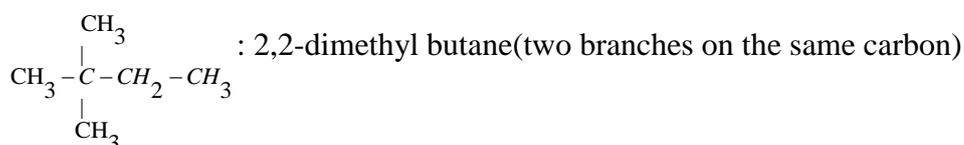
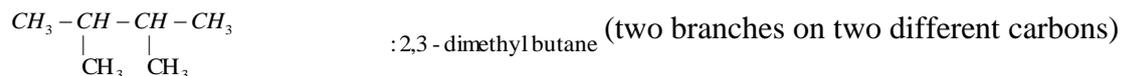

Therefore, C₆H₁₄ has 5 isomers: CH₃-CH₂-CH₂-CH₂-CH₂-CH₃,

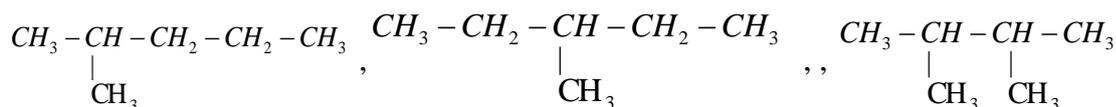

Note:

- Position 4 is identical to position 2 $\begin{array}{c} \text{CH}_3 \\ | \\ \text{CH}_3 - \text{C} - \text{CH}_2 - \text{CH}_3 \\ | \\ \text{CH}_3 \end{array}$
- Putting the methyl group on position 1 or 5 gives you the same straight chain isomer.

Checking up 2.2

Write the structural formulae of all isomers which fit the molecular formula C₇H₁₆ and name each of them according to the IUPAC system.

2.3 Occurrence of Alkanes

Activity 2.3:

Some organic compounds are found in living beings whereas others are synthesised by humans. Under which category do alkanes fall? Justify your opinion.

- 1) The alkanes exist in nature in form of natural gases and petroleum. Natural gas and petroleum existence are the results of decomposition of died bodies after many years ago.

- 2) The most natural gas is found in lake Kivu as methane gas but in form of traces like ethane, propane and butane
- 3) Petroleum is the most world energy, it is formed by decomposition by bacteria for millions of years died marine living things and as the last product is petroleum and natural gases which are separated in fractional distillation of their crude oil and the results are obtained according to their boiling point.

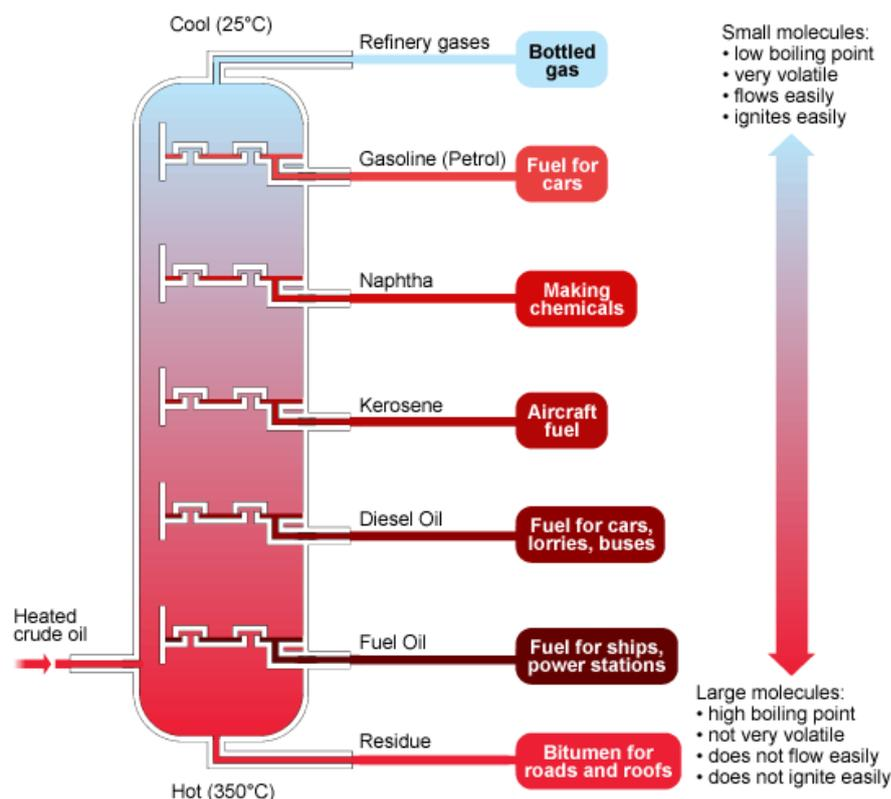

Figure 2.1. Fractional distillation of petroleum

Source: www.bbc.uk/schools/gcse/fractionaldistillationofcrudeoil

The fractional distillation and the different fractions are summarized in the following table and in the Figure 2.1.

Table 2.2. Fractions of petroleum

Fraction	Number of C atoms	B.P range (°C)
Natural gas	C1- C4	Below 40

Petrol	C5- C10	40-175
Kerosene/paraffin	C10- C14	175-275
Diesel oil	C14- C18	275-300
Lubricating oil, waxes (heavy gas oil)	Above 18	300-350
Bitumen, asphalt, (residues)	Above 40	Above 350

Checking up 2.3:

What are the main sources of alkanes?

2.4. Preparation of alkanes

Activity 2.4

Laboratory preparation of methane gas

Requirements:

Stand and accessories

Delivery tube

NaOH(s)

Sodium acetate(s)

Calcium oxide(s)

Procedure:

Set up the apparatus as shown on the diagram below

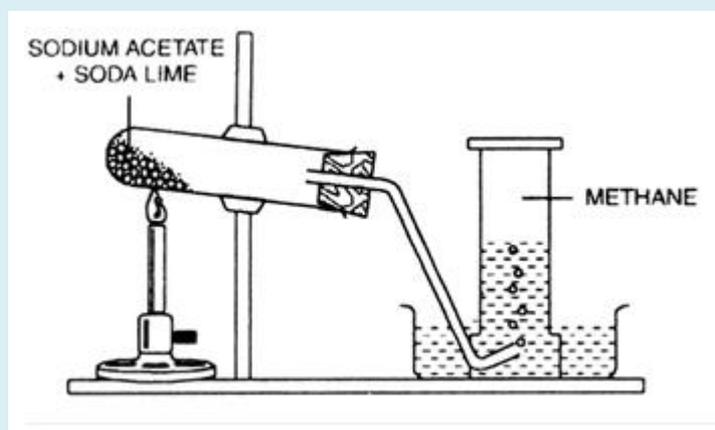

Figure 2.2 Laboratory preparation of methane

Source: <https://www.zigya.com/study/book>

Prepare a mixture of the reagents in ratio 1:1. Weight about 3 grams of sodium acetate and the same quantity as soda lime. Mix them thoroughly in a beaker.

Place about 4 grams of the mixture into a boiling tube.

Seal the boiling tube with a stopper with a gas-delivery tube. The gas-delivery tube should look upwards.

Fix the boiling tube on a stand.

Heat the test-tube gently with the cold part of the flame. To avoid local overheating keep the flame in motion.

After a while the gas starts liberating.

Prepare an empty test-tube. Collect some gas keeping this test-tube on top of the gas delivery tube.

Methane is a flammable gas. To set it on fire turn the covering test tube and hold a burning match to the end of the gas delivery tube.

The gas burns with a blue (red) fire.

Methane can be prepared by the reaction between sodium acetate and sodium hydroxide solid according to the equation:

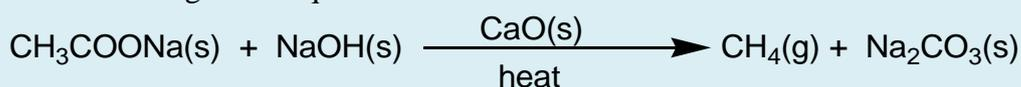

It is collected by the downward displacement of water.

Source: <https://www.zigya.com/study/book>

Other gaseous alkanes can be prepared in the same way according to the general equation.

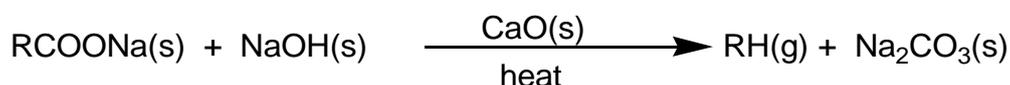

Note: The reaction is practically used to reduce by one carbon the length of carbon chain. It is referred as decarboxylation of sodium carboxylates.

Other reactions used for the preparation of alkanes are the following:

- 1) Addition reaction of hydrogen** to alkenes and alkynes in the presence of catalyst like Nickel, Palladium or platinum produces alkanes: this reaction is called hydrogenation reaction of alkenes and alkynes; it is also called a reduction reaction of alkenes and alkynes.

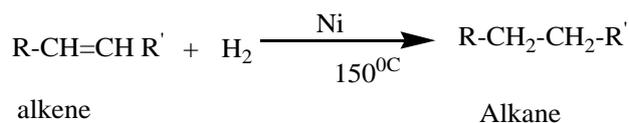

Example

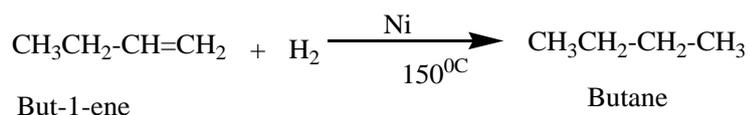

N.B: In organic chemistry, reduction reaction is the reaction that results in increasing of hydrogen content in the new product.

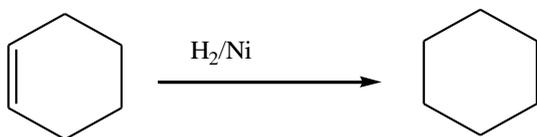

[Hydrogen content in the product (C₆H₁₂) is higher than the hydrogen content in the reactant (C₆H₁₀)].

Note: Reduction with Platinum and Palladium as catalyst occurs at room temperature, while using Nickel requires a temperature of about 150⁰C.

2) From halogenoalkanes or Alkyl halides

On reduction of alkyl halides with Zn and concentrated hydrochloric acid, alkyl halides are converted to alkanes.

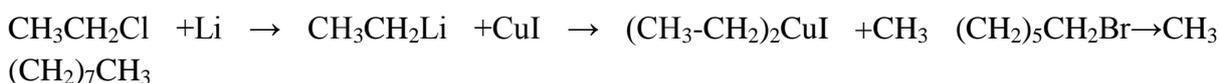
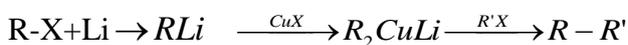
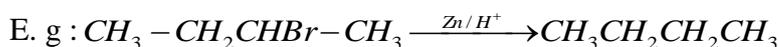
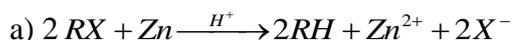

n- nonane

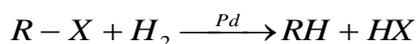

Example

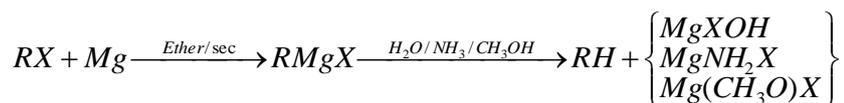
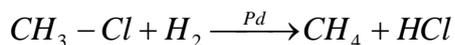

Example

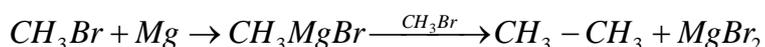

b) Alkyl halides when heated with sodium metal in ether solution give higher alkanes (alkanes with more carbon atoms) (Wurtz reaction).



Note: This reaction is practically useful in organic synthesis to increase the length of carbon chain.

c) When Alkyl halides are treated with Zn-Cu couple, in the presence of ethanol, alkanes are formed.

Note: Zn-Cu couple is obtained by adding Zinc granules in aqueous copper (II) sulphate solution where copper is deposited on the Zn pieces.

Example

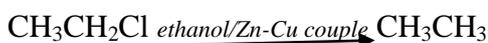

3) From carbonyl compounds

Reduction of carbonyl compounds, with amalgamated Zinc (alloy made of zinc and mercury) and HCl. This is the Clemmensen reduction).

4) From aldehydes or ketones

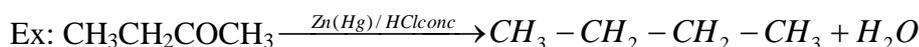

Note: Under special conditions, reduction also is realized by use of H₂ and Raney Nickel or using hydrazine (NH₂NH₂) and KOH. This is called Wolf Kushner reduction.

Checking up 2.4

Describe the main reactions used in the preparation of alkanes.

2.5. Physical properties of alkanes

Activity: 2.5

- (1) Put 5 ml of hexane in a test tube. Add 5ml of water and shake.
- (2) Record your observations
- (3) Repeat the above procedure using,
 - (i) cyclohexane
 - (ii) heptane
- (4) Repeat the steps 1-3 using carbon tetrachloride instead of water.
- (5) Record your observations.
- (6) Search about the melting and boiling point values of the alkanes used in the experiments above and record your findings.

Melting and boiling points

The values of melting, boiling points, density and physical state of some alkanes are summarized in the table below.

Table 2.3 Physical parameters of alkanes

Alkanes	Melting Point $^{\circ}\text{C}$	Boiling Point $^{\circ}\text{C}$	Density	Physical state
CH_4	-182.6	-162.0	0.4240	gas
C_2H_6	-172.0	-89.0	0.5463	
C_3H_8	-157.1	-44.0	0.5824	
C_4H_{10}	-135.0	-0.5	0.5933	
C_5H_{12}	-129.7	36.2	0.6264	Liquid
C_6H_{14}	-94.5	69.0	0.6594	
C_7H_{16}	-90.5	98.4	0.6837	
C_8H_{18}	-57.0	125.6	0.7028	
C_9H_{20}	-53.7	150.7	0.7179	
$\text{C}_{10}\text{H}_{22}$	-29.7	174.0	0.7298	
....	
....	
$\text{C}_{17}\text{H}_{36}$	16.0	300.0	0.769	
$\text{C}_{18}\text{H}_{38}$	28.0	309.0	0.7767	Solid and elsewhere as n increase

The above Table shows that the boiling and melting points of homologue alkanes increase with the number of carbon i.e. molecular mass.

Explanation:

The boiling and melting points depend on the magnitude of the Van Der Waal's forces that exist between the molecules. These forces increase in magnitude with molecular mass.

Note: Branched chain isomers have lower boiling and melting points than their straight chain isomers, because straight chain isomers are closer packed than the branched chain isomers.

Examples: n-pentane: $\text{CH}_3\text{-CH}_2\text{-CH}_2\text{-CH}_2\text{-CH}_3$ Boiling point is 36°C

Isopentane:

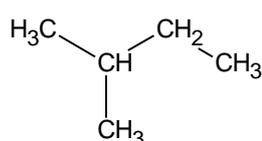

Boiling point is 28°C

Neopentane:

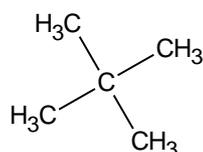

Boiling point is 9.5°C

Boiling points decrease with increase in branching because increased branching gives the molecule a more nearly spherical shape and this reduces the extent of contact between neighboring molecules, in other words the branched isomers are less packed than straight chain isomers, and hence the attractive force between the molecules are reduced hence decrease in the boiling points.

Alkanes are not soluble in water, because of their low polarity and also because of their inability to form hydrogen bonds. They are, however soluble in non polar solvents, like CCl_4 , CS_2 , benzene, and are miscible with one another.

Checking up 2.5

Using data in the Table 2.3, plot a graph of boiling and melting points against the number of carbon atoms, explain the shapes of the graphs drawn.

2.6. Chemical properties of alkanes

Activity 2.6.1

Experiment to investigate the reactivity of alkanes

- 1) Put 5ml of hexane in a test tube.
- 2) Add drop wise 5ml of potassium hydroxide and shake
- 3) Repeat steps 1-2 using bromine water instead of potassium hydroxide
- 4) Repeat steps 1-3 using octane.
- 5) Record all your observations in the table below.

Reaction of:	Evolution of a gas	Change in colour	Formation of a precipitate	Release of heat
Hexane with KOH				
Hexane with bromine water				
octane with KOH				
Octane with bromine water				

For a positive test put “yes” and “no” for a negative result.

- 6) What do you deduce from your observations?

Generally, alkanes are quite inert towards common reagents because:

- The C-C bond and C-H bonds are strong and do not break easily.
- Carbon and hydrogen have nearly the same electronegativity value hence
- C-H bond only slightly polarized; generally C-H bond is considered as covalent.
- They have unshared electrons to offer.

They, however, undergo the following reactions.

1) Reaction with oxygen

Alkanes react with oxygen to produce carbon dioxide (if oxygen is enough to burn all quantity of hydrocarbons), or carbon monoxide or carbon if oxygen is in insufficient quantity, and water. This reaction is called “combustion”.

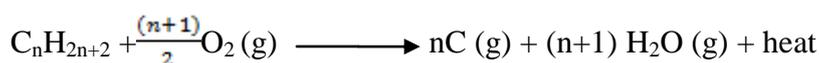
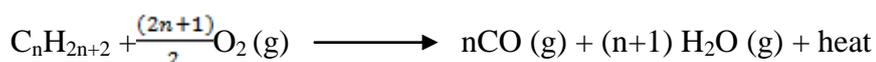
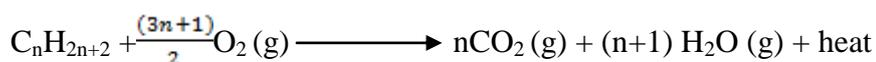

Carbon dioxide (CO₂) produced from the burning of alkanes or fossil fuels for heating, transport and electricity generation is the major atmospheric pollutant that increases the green house potential of the atmosphere. Carbon dioxide is the major Green House Effect (GHE) gas.

Burning wood and forests produce also carbon dioxide and lead to the increase of that gas in the atmosphere. Methane as another GHE gas is produced by human activities, agriculture (Rice), and cattle-rearing.

Activity 2.6.2

Do research and discuss different ways of avoiding or reducing the production of GHE gases such as carbon dioxide.

There are many natural ways of reducing atmosphere carbon dioxide:

- Water in seas dissolves millions of tonnes of gas (but less now than it did in the past, since the average ocean temperature has increased by 0.5 °C in the last 100 years, and gases are less soluble in hot than in cold water).
- Plankton can fix the dissolved carbon dioxide into their body mass by photosynthesis
- Trees fix more atmospheric carbon dioxide than do grass and other vegetation through photosynthesis according to the equation below.



There are other ways than natural ways of reducing GHE gases and among them there are the use of technologies that reduce the green house gas emissions, the recycling of the GHE.

2) Reaction with halogens (halogenations)



Example: Reaction of methane with bromine



Mechanism of the reaction:

A **mechanism of a reaction** is a description of the course of the reaction which shows steps of the reaction and the chemical species involved in each step.

The mechanism for the reaction between methane and bromine is the following.

- i. Phase 1: Initiation (radical formation: formation of Br atom)

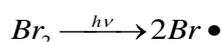

- ii. Phase 2: Propagation

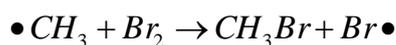
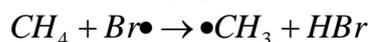

- iii. Phase 3: Termination steps (Radicals combination and end of the formation of radicals)



Hence, the generalized reaction is:

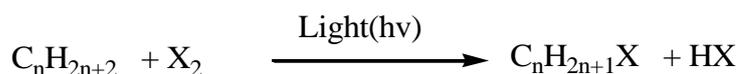

Where X_2 : Can be Cl_2 , Br_2 and in some case I_2 but not F_2

Notice: (i) Br_2 reacts as Cl_2 but slowly while iodine reacts hardly or does not. Fluorine, the most electronegative element of the periodic table reacts with alkanes to give coke, i.e. a decomposition reaction:

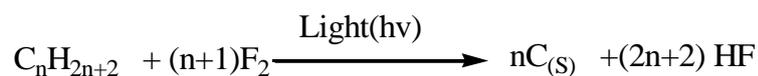

(ii) Due to radical formation involved, the main product of reaction is the one from the most stable radical, starting with tertiary, secondary, primary and methyl in decreasing order of stability.

A tertiary free radical is better stabilised by the electron donating methyl groups than the secondary, primary and methyl ones where the carbon atom is attached to more hydrogen atoms

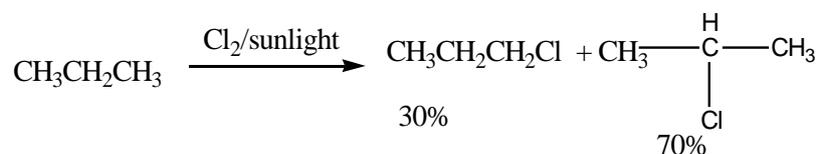

3) **Dehydrogenation** of alkanes gives alkenes under heat and a catalyst like V_2O_5 .

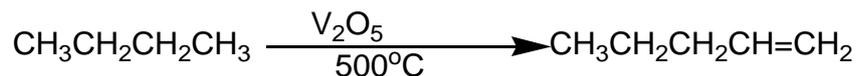

4) Cracking

On heating or in the presence of a catalyst, large molecules of alkanes are decomposed into smaller alkanes and alkenes. If the cracking is performed on heating, it is referred as thermocracking.

If the cracking is performed using a catalyst; it is referred as catalytic cracking and many products result from one reactant as shown below.

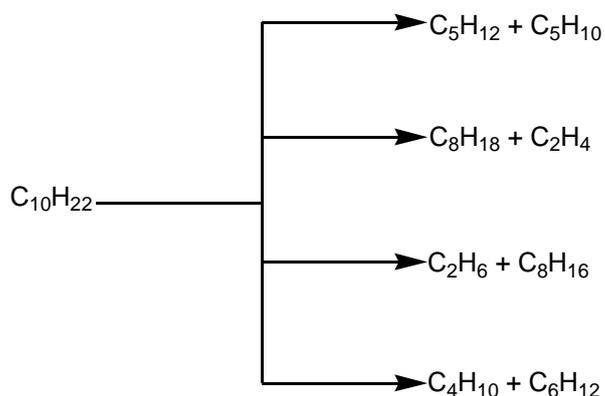

Checking up 2.6

- 1) From the reaction of combustion of alkanes, explain how the air resulting from kerosene is used as energy source?
- 2) Using a chemical equation, explain how butane can be prepared from bromoethane.

2.7. Uses of alkanes

Activity 2.7

In Rwanda, gas methane has been discovered in Lake Kivu and the government is under its exploitation.

1. Outline all possible uses of methane gas
2. Discuss the economic impact of the gas to the livelihood of Rwandans.



Picture 2.1: Kivu watt power station

3. With the help of the pictures below, deduce the uses of alkanes



(1) Methane (CH₄)

Methane finds many uses:

- It is used as a **fuel** at homes, ovens, water heaters, kilns and automobiles as it combusts with oxygen to produce heat.
- Highly refined liquid methane is used as **rocket fuel**.
- Methane is used as fuel for electricity generation.
- It is used as a vehicle fuel in the form of liquefied natural gas (LNG).
- Methane can be used as raw material in the production of urea, a fertilizer.

In general, methane is more environmental friendly than gasoline/petrol and diesel.

(2) Butane (C₄H₁₀)

- Butane is a key ingredient of synthetic rubber.
- It is used as fuel in cigarette lighters.
- When blended with propane and other hydrocarbons, it may be referred to commercially as LPG, for liquefied petroleum gas.

- Butane gas cylinders are used in cooking.
- Also used in aerosol spray cans.

(3) Propane (C₃H₈)

- Propane is used as a **propellant** for aerosol sprays such as shaving creams and air fresheners. Used as fuel for home heat and back up electrical generation in sparsely populated areas that do not have natural gas pipelines.

Propane is commonly used in movies for explosions

(4) Ethane (C₂H₆)

- Ethane is used in the preparation of ethene and certain heavier hydrocarbons. Ethane can be used as a refrigerant in cryogenic refrigeration systems.

(5) Pentane (C₅H₁₂)

- Pentane is used in the production of polystyrene **foams** and other foams.
- Used in laboratories as **solvents**.
- It is also an active ingredients of **pesticides**.
- Used as solvent in **liquid chromatography**

(6) Hexane (C₆H₁₄)

- It is used in the formulation of glues for shoes, leather products, and roofing.
- It is also used to extract cooking oils such as canola oil or soy oil from seeds.
- Hexane is used in extraction of pyrethrin from pyrethrum; e.g. Horizon SOPYRWA (a pyrethrum factory in Musanze District).
- Also for cleansing and degreasing a variety of items, and in textile manufacturing.

(7) Heptane (C₇H₁₆)

- Heptane is used as solvent in paints and coatings.
- Pure n-heptane is used for research, development and pharmaceutical manufacturing
- Also as a minor component of **gasoline**.
- It is used in laboratories as a **non-polar solvent**.

2.8. End unit assessment

1. Give the general formula of alkanes

2. Answer by **True** or **False**

- a) 2,2-dimethylbutane is an isomer of hexane
- b) Boiling point of alkanes increases with increasing the length of the chain. Explain why?
- c) Alkanes are polar molecules; justify your answer

3. Draw the structures of the following formulas:

- a) 2,3,5-trimethyl-4-propylheptane
- b) 2,2-dimethylpropane
- c) 2-methyl pentane
- d) 4-ethyl-2,3-dimethyloctane

4. Explain the different steps of the chlorination reaction of methane

5. An alkane with molecular mass of 72 is formed only by one monochloro substitution product. Suggest the structure of the alkane.

6. a) What do you understand by the term hydrocarbon?

b) What is the relationship between the number of carbon atoms in a hydrocarbon and its boiling point?

c) The hydrocarbon C_5H_{12} burns to form carbon dioxide and water. Write the balanced equation for the reaction.

d) Name the environmental problem that is caused by the formation of carbon dioxide during the combustion of hydrocarbon.

7. Consider the alkane with the formula $CH_3-CH_2-CH_2-CH_2-CH_2-CH_3$

- a) Determine the percentage composition of carbon and hydrogen in the compound,
- b) Determine the empirical formula of the above compound,
- c) From the results in a) calculate the molecular formula of the compound,
- d) Write down the balanced chemical equation of combustion of the compound,
- e) Name the environmental problem that is caused by the performance of the reaction in d) and suggest different ways to solve that environmental problem.

8. Show how each of the following conversions can be accomplished with a good yield

- a) $CH_3-CH_2-CH_2-COOH$ to $CH_3-CH_2-CH_3$
- b) CH_3-Br to $CH_3-CH_2-CH_3$
- c) $CH_3-CH=CH-CH_3$ to $CH_3-CH_2-CH_2-CH_3$

9. a) Referring to methane as an example of alkanes, discuss the importance of alkanes in our every day life.
- b) Gaz methane is extracted in Lake Kivu in Rwanda. Explain its perspectives in Rwandan economy?

UNIT 3: ALKENES AND ALKYNES

Key unit competency

Relate the physical and chemical properties of alkenes and alkynes to their reactivity and uses

Learning objectives

- *Explain the reactivity of alkenes in comparison to alkanes*
- *Explain the existence of geometrical isomerism in alkenes*
- *Describe the industrial process of preparing alkenes and alkynes*
- *Apply IUPAC rules to name alkenes and alkynes*
- *Carry out an experiment to prepare and test ethene gas*
- *Outline the mechanisms for electrophilic addition reactions for alkenes and alkynes*
- *Write the structural formulae of straight chain alkenes and alkynes*
- *Apply Markovnikov's rule to predict the product of hydrohalogenation of alkenes*
- *Classify alkynes as terminal and non-terminal alkynes using their different structures*
- *Appreciate the combustion reaction as source of fuels.*
- *Appreciate the uses and dangers of addition polymers (polythene used for polythene bags, polypropene for plastic bottles etc.)*

Introductory activity

Observe the following picture and answer the questions that follow.



- 1) What is the collective name of the substances used to manufacture the items showed in the above picture?
- 2) a) What are the raw materials used in the manufacture of the substances identified in 1)?
b) These raw materials may be obtained from different sources. Discuss this statement.
c) Do you expect these raw materials be soluble or not in water? Justify your answer.
- 3) Even though the items which appear in the picture above are interesting, they also present some disadvantages. Discuss this statement.

3.1. Definition, structure and nomenclature of alkenes

Activity 3.1.1

1. Describe the formation of a carbon-carbon double bond. What is the hybridisation state of a carbon doubly bonded?
2. What is the shape of the molecule around the double bond? Explain.

Alkenes are a homologous series of hydrocarbons which contain a carbon-carbon double bond. Since their skeleton can add more hydrogen atoms, they are referred as unsaturated hydrocarbons.

The general formula of alkenes is C_nH_{2n} .

Example: Ethene (C_2H_4)

Alkenes are abundant in the nature and play important roles in biology. Ethene, for example, is a plant hormone, a compound that controls the plant's growth and other changes in its tissues.

Ethene affects seed germination, flower maturation, and fruit ripening. They are described as **unsaturated hydrocarbons** because they can undergo addition reactions.

The double bond in alkenes is made of one sigma bond and one pi bond. This gives rise to the impossibility of rotation around the double bond. The hybridization state in alkenes is sp^2 and the structure around each carbon doubly bonded is trigonal planar with a bond angle value of 120° .

Activity 3.1.2

Refer to the IUPAC system used in the nomenclature of alkanes, name the following compounds.

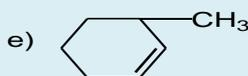
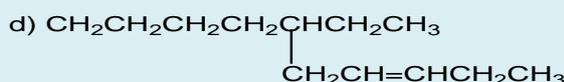
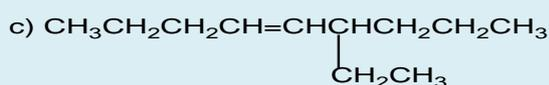
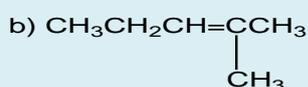
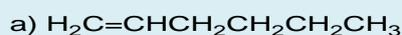

IUPAC names of alkenes are based on the longest continuous chain of carbon atoms that contains the double bond.

The name given to the chain is obtained from the name of the corresponding alkane by changing the suffix from **-ane** to **-ene**.

If the double bond is equidistant from each end, number the first substituent that has the lowest number. If there is more than one double bond in an alkene, all of the bonds should be numbered in the name of the molecule, even terminal double bonds. The numbers should go from lowest to highest, and be separated from one another by a comma

The chain is always numbered from the end that gives the smallest number for the location of the double bond.

In naming cycloalkenes, the carbon atoms of the double bond are numbered 1 and 2 in the direction that gives the smallest numbers for the location of the substituents.

e) Buta-1,2-diene

2) Name each of the following compounds according to the IUPAC system.

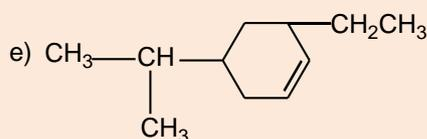
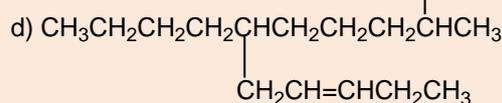
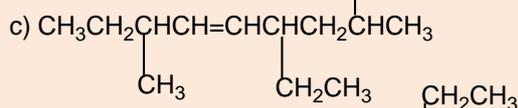
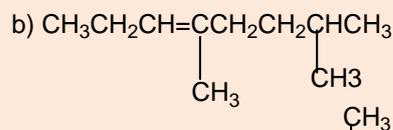

3.2. Isomerism in alkenes

Activity 3.2

1. What is meant by isomers and what are the types of isomers?
2. Which types of isomerism can be exhibited by alkenes? Give your reasons

Alkenes exhibit two types of isomerism: structural isomerisms and stereoisomerism.

1) Structural isomerism

Alkenes show as well position isomerism, chain isomerism and functional isomerism.

In position isomerism, the position of the double bond changes but the length of the chain remains the same.

Example:

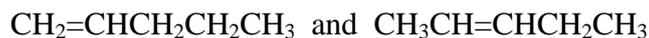

Pent-1-ene

pent-2-ene

The chain isomerism arises due to difference in the length of the chains.

Example:

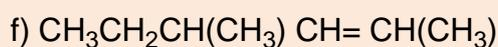
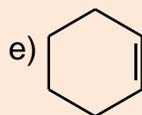
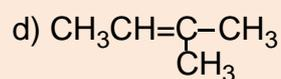
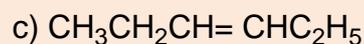
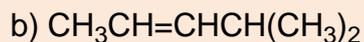
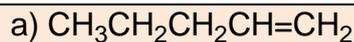

3.3. Preparation of alkenes

Activity 3.3

Different methods can be used to prepare alkenes. Discuss the possible reactions which may be involved in the preparation of alkenes and propose the mechanisms, where it is possible.

Different methods are used for the preparation of alkenes. Most of them are elimination reactions.

1) Dehydration of alcohols

An alkene may be obtained by dehydration of an alcohol. The reaction involves the loss of H and OH (water) from adjacent carbons of an alcohol to form an alkene. The dehydrogenation is carried out by heating an alcohol with concentrated sulphuric acid or 85% phosphoric acid.

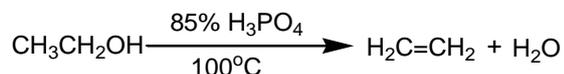
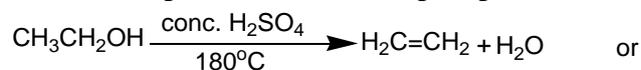

Mechanism of the reaction

The dehydration of alcohols giving alkenes occurs in three steps.

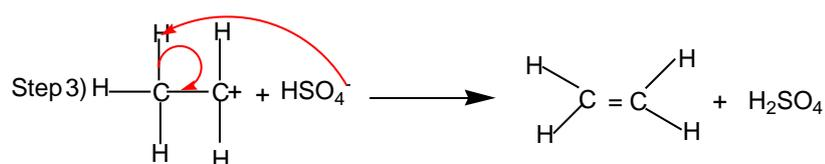
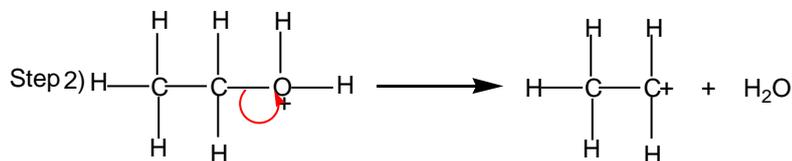
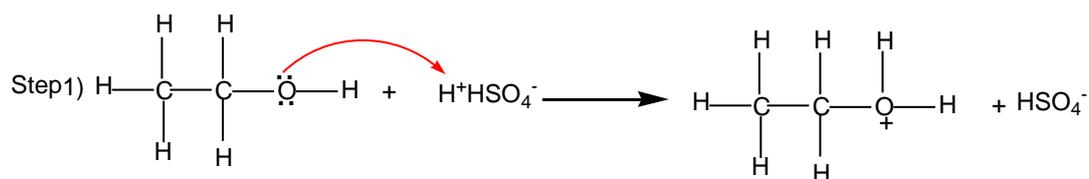

If two or more alkenes may be obtained, the one having more substituents on the double bond generally predominates. This is the Zaitsev's rule.

Example:

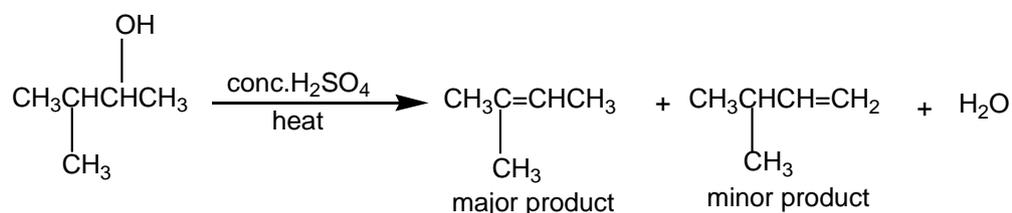
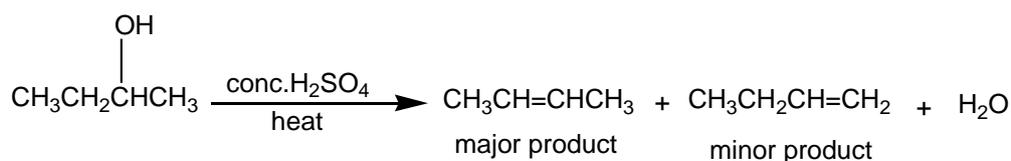

This is due to the stability of the intermediate carbocation. The carbocation produced in step 2 may undergo a transposition (rearrangement) of a hydride ion or a methyl group giving a more stable carbocation and therefore a more stable alkene.

Example 1:

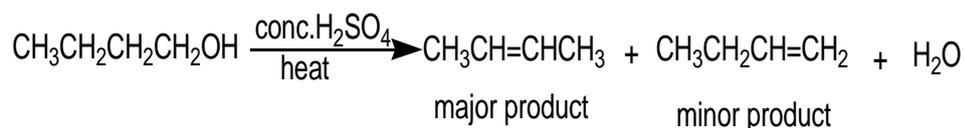

Mechanism

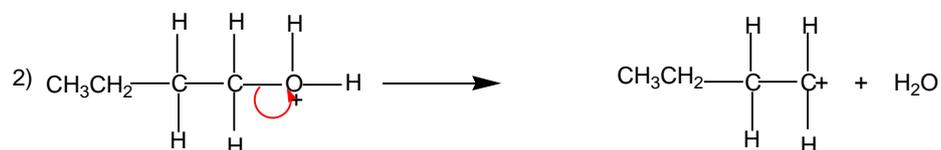
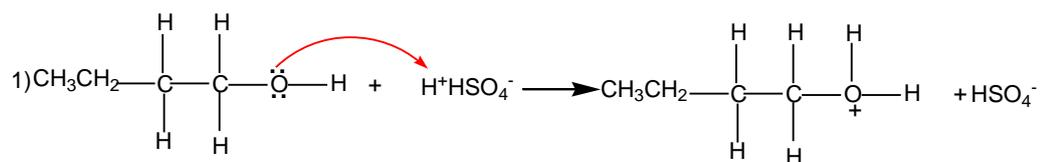

migration of hydride ion

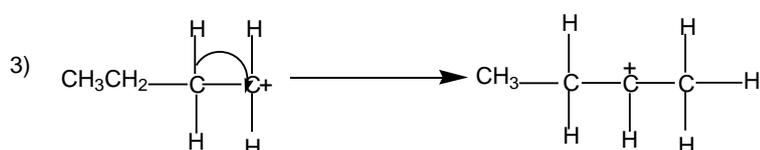

From the secondary carbocation, two products can be obtained and the reaction follows the Zaitsev's rule.

Example 2

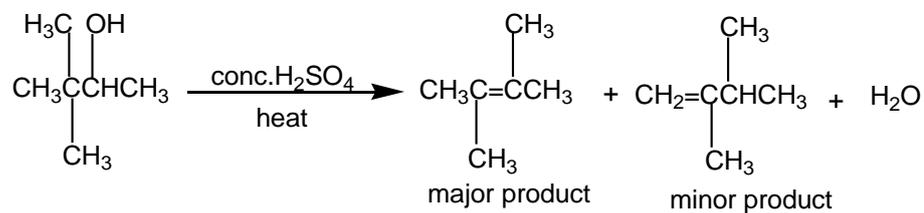

Mechanism

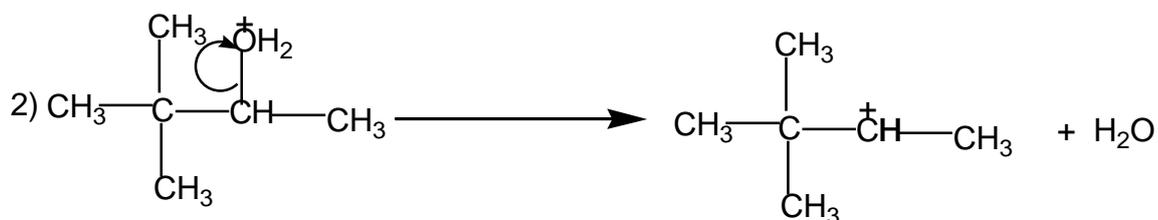
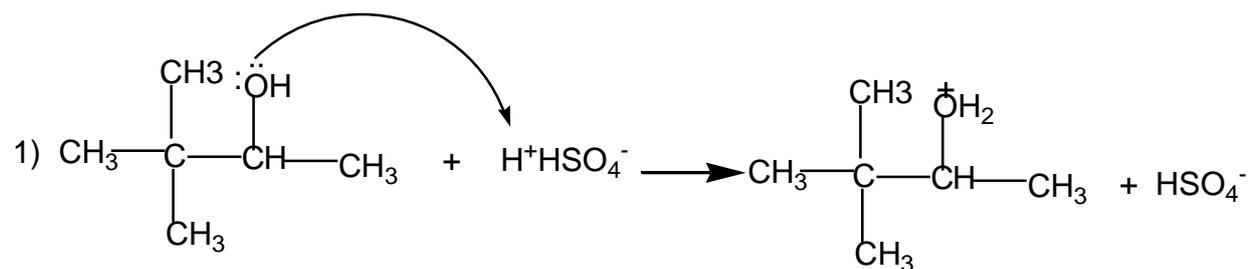

migration of a methyl group

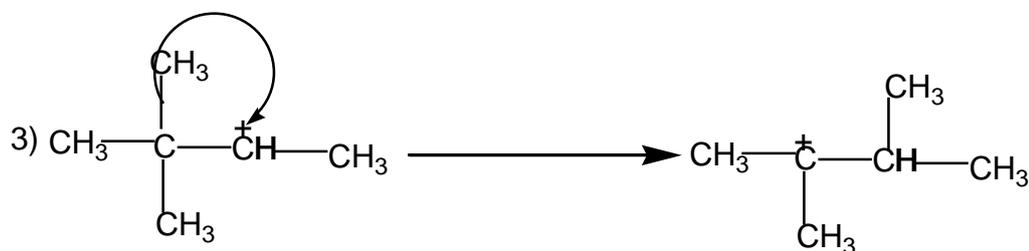

From the tertiary carbocation, two products can be obtained and the reaction follows the Zaitsev's rule.

The dehydration of alcohols leading to alkenes may also be effected by heating alcohols in the presence of alumina.

Example:



2) Dehydrohalogenation of haloalkanes

Haloalkanes react with hydroxide ions in ethanolic solution to yield alkenes. The reaction follows the Zaitsev's rule.

Examples

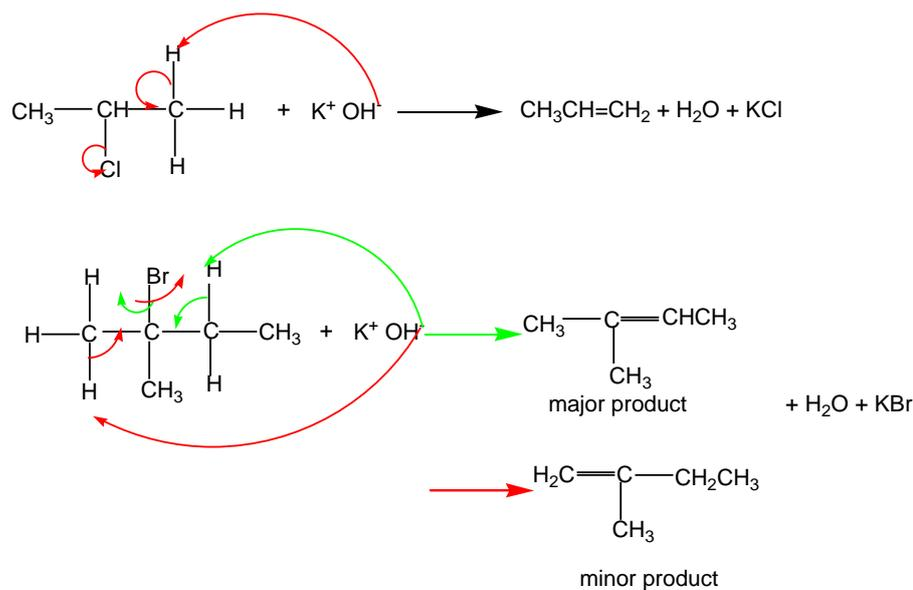

3) Dehalogenation of dihalogenoalkanes

When a compound containing two halogen atoms on the adjacent carbon atoms is treated with magnesium or zinc it transforms to an alkene.

Examples:

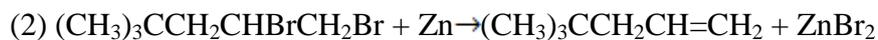
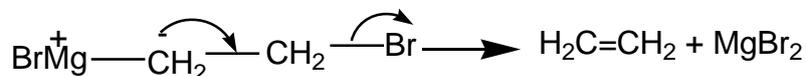
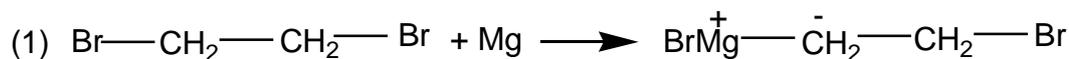

When the two halogen atoms are attached to non-adjacent carbon atoms, a cyclic alkane is formed.

Example:

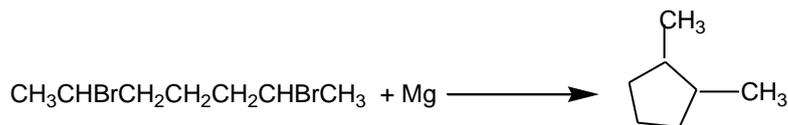

Checking up 3.3

1) Refer to the IUPAC system, name the alkenes formed when the

following alcohols are dehydrated in the presence of sulphuric acid.

- a) Pentan-2-ol
 - b) 2-methylpropan-1-ol
 - c) 2,3-dimethylbutan-2-ol
 - d) 2-methylcyclohexanol
 - e) 2-methylbutan-2-ol
- 2) What are the products of the dehydrohalogenation of the following compounds? Show the major product.
- a) 1-bromo-2-methylpropane
 - b) 2-bromo-3-methylpentane
 - c) 2-bromo-2,3-dimethylbutane
 - d) 3-chloro-3-ethylpentane
- 3) Establish the formula of the compounds formed when each of the following dihalogenoalkanes react with magnesium.
- a) $(\text{CH}_3)_2\text{CHCHClCHClCH}_3$
 - b) $\text{CH}_3\text{CH}_2\text{C}(\text{Br})(\text{CH}_3)\text{CH}(\text{Br})\text{CH}_2\text{CH}_3$
 - c) $\text{CH}_3\text{CHBrCH}_2\text{CH}_2\text{CH}_2\text{CHBrCH}_3$

3.4. Laboratory preparation and chemical test for ethene

Activity 3.4

Preparation of ethene

Set up the apparatus as shown in the Figure below (Figure 3.1) and follow the instructions to perform the experiment on the preparation of ethene.

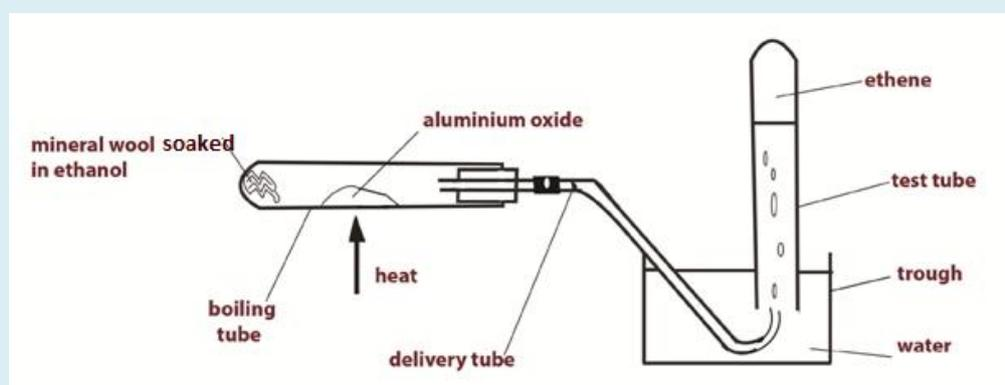

Figure 3.1: Laboratory preparation of ethene

Requirements:

Chemicals:

- Ethanol, aluminium oxide, lime water, mineral wool, bromine water, acidified potassium permanganate solution (very dilute), water.

Additional apparatus:

- Boiling tube
- Rubber stopper with hole
- Delivery tube
- Trough
- Test- tube rack
- 5 test tubes
- 5 rubber stoppers for test tubes
- Spatula
- Bunsen burner
- Glass rod
- Splint
- Matches

Procedure and setting**(1) Preparation of ethene:**

- Pour some ethanol into the boiling tube to a 3 cm depth
- Add some glass wool to soak the ethanol, using a glass rod to push the wool down the tube.
- Clamp the boiling tube in a horizontal position using a retort stand.
- Put a small amount of aluminium oxide about half way along the boiling tube.
- Complete the set up of the apparatus as shown in the diagram above.
- Light the Bunsen burner, adjust it to a blue flame and heat the aluminium oxide. (Make sure the test tube is filled with water when you start to collect the gas produced.)
- As the aluminium oxide gets hot the heat reaches the ethanol at the end of the tube. The ethanol then changes to vapour, passes over the hot aluminium oxide and is dehydrated to produce ethene gas.
- Collect 5 test tubes of the gas and put a stopper on each tube when it is filled.
- When the test tubes have all been filled, loosen the retort stand and raise the apparatus so that the delivery tube no longer dips into the water. This avoids suck back of water as the tube begins to cool which could cause the boiling tube to crack. Turn off the Bunsen burner.

(2) Testing the properties of ethene

Addition of bromine:

- Taking great care, add about 1ml of the test tube of bromine water to one of the test tubes of ethene.
- Replace the stopper and shake the tube a few times.
- Record your observations.
- Write down your conclusions
- Addition of acidified potassium permanganate:
- Add about 1ml of very dilute potassium permanganate solution to one of the test tubes of ethene and shake the tube a few times.
- Record your observations.
- Write down your conclusions

Combustion:

- Remove the stopper of one of the tubes filled with ethene and apply a light to the mouth of the test tube using a lighted splint.
- Allow the gas to burn and when it has stopped burning add a small amount of lime water to the test tube, stopper it and shake the tube a few times.
- Write down your observations.

Interpretation

When ethanol is heated in the presence of aluminium oxide, a gas is produced. This gas does not react with lime water. This means that the produced gas is not carbon dioxide. The equation of the reaction is:

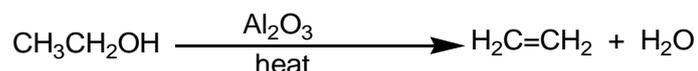

The gas decolourises bromine water. Bromine water is a test used to identify the presence of a carbon-carbon double bond or triple bond. The bromine adds across the double bond and a dibromoalkane is formed. The reaction between alkene and bromine water is shown below:



If you shake an alkene with bromine water (or bubble a gaseous alkene through bromine water), the solution becomes colourless. Alkenes decolourise bromine water.

The Figure 3.2 shows Bromine water added to ethene: before the reaction (left) the color of bromine appears, and after the reaction (right) the colour of bromine disappears.



Picture 3.2: Test for unsaturation

When ethene reacts with acidified potassium manganate (VII), the purple colour of the permanganate solution turned to colourless or light pink indicating the presence of the carbon – carbon double bond. The reaction is the following:

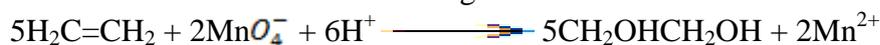

The gas burns with a smoky flame producing carbon dioxide and heat energy. The carbon dioxide produced turns into milky lime water.

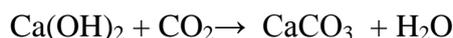

Checking up 3.4

- 1) Ethene is prepared by dehydration of ethanol in the presence of alumina, explain other reactions that produce ethene.
- 2) Describe the chemical test used to identify the presence of a carbon-carbon double bond in an organic compound.
- 3) Explain how ethene can be differentiated from carbon dioxide using a chemical test?

3.5. Physical properties of alkenes

Activity 3.5

1. How the physical state of alkenes changes compared to their molecular mass
2. Put in a test tube 5ml of cyclohexene. Add 5ml of water and mix. Record your observations.
3. Put in a test tube 5ml of cyclohexene. Add 5ml of tetrachloromethane and mix. Record your observations.
4. Alkenes exhibit geometrical isomerism. Which of cis and trans isomers are expected to be less volatile? Explain why.

- Alkenes which have less than 5 carbon atoms are gaseous at ordinary temperature, the other are liquid up to 18 while others are solids as the number of carbon atoms increases.
- Boiling points and melting points of alkenes are less than those of alkanes but also increase as the molecular weight increase.

- Alkenes are insoluble in water but soluble in most organic solvents.
- Cis-alkenes have a slightly higher boiling point than the trans-isomers because the dipole moments in trans structures cancel each others.

Checking up 3.5

Which one of the following compounds has higher boiling point? Explain.

- Cis-butane and trans-butane
- Ethene and propene

3.6. Chemical properties

3.6.1. Addition reactions

3.6.1.1. Electrophilic additions

Activity 3.6.1

- Explain the following terms and give two examples for each.
 - Addition reaction
 - Lewis acid
 - Distinguish other name given to a Lewis acid.
- Predict if Lewis acids can react with alkanes.
- Justify if Lewis acids react with alkenes.
- Differentiate the reactivity of alkenes and alkanes.

Alkenes are far more reactive than alkanes due to the carbon-carbon double bond. These compounds are unsaturated and they can easily undergo addition reactions to yield saturated products.

The double bond in alkenes is a region of high density of electrons. Therefore, this region is readily attacked by electrophiles. An **electrophile** is an atom, a molecule or an ion which is electron-deficient; i.e. it is a Lewis acid or an electron pair acceptor.

Electrophilic addition reactions take place in two steps:

- Formation of a carbocation

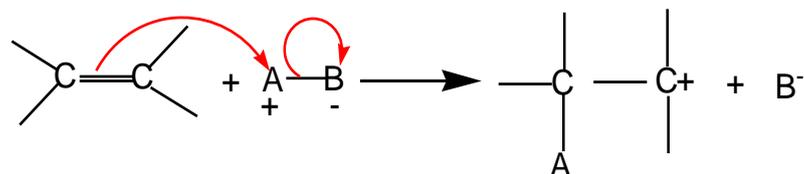

- Reaction of the carbocation

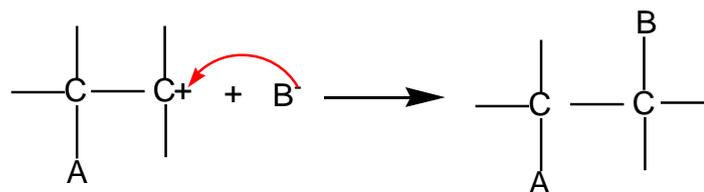

1) Addition of hydrogen halides

Hydrogen halides (HCl, HBr, HI) react with alkenes to yield halogenoalkanes. The reaction is carried out either with reagents in the gaseous state or in inert solvent such as tetrachloromethane.

Example:

(i) Formation of the carbocation

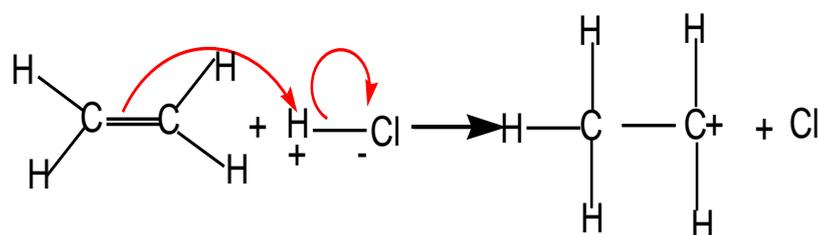

(ii) Reaction of the carbocation

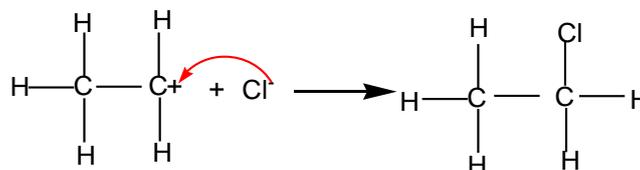

When hydrogen halides add to unsymmetrical alkenes, the reaction leads to the formation of two products in two steps. The first step leads to the formation of two different carbocations with the major product formed from the more stable carbocation. This is the Markownikov's rule. That is "*The electrophilic addition of an unsymmetric reagent to an unsymmetric double bond proceeds by involving the most stable carbocation.*"

The order of stability of the carbocations is:

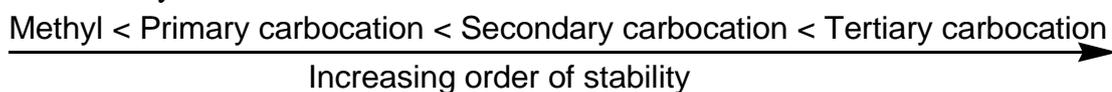

Example:

Reaction of propene with hydrogen chloride

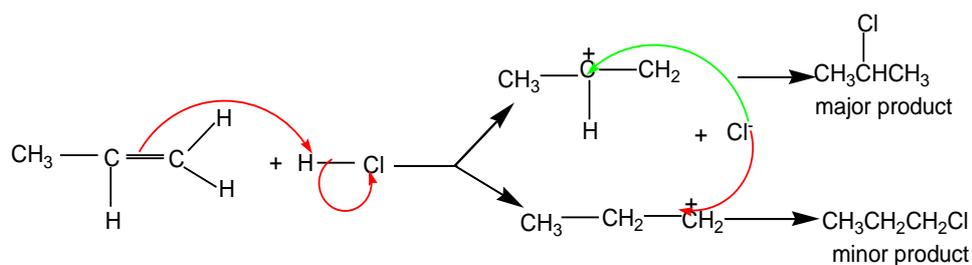

In the presence of peroxide, the reaction follows a free radical mechanism and it does not follow the Markonikov's rule.

Example

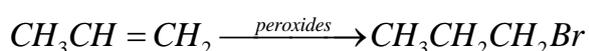

2) Addition of water

The hydration of alkenes catalysed by an acid is an electrophilic addition. Ethene can be transformed into ethanol. The first step consists of adding concentrated sulphuric acid. The second step consists of the hydrolysis of the product of the first step.

In industry the reaction is carried out at approximately 300 °C in the presence of phosphoric acid as a catalyst.

Example:

Hydration of 2-methylbut-2-ene

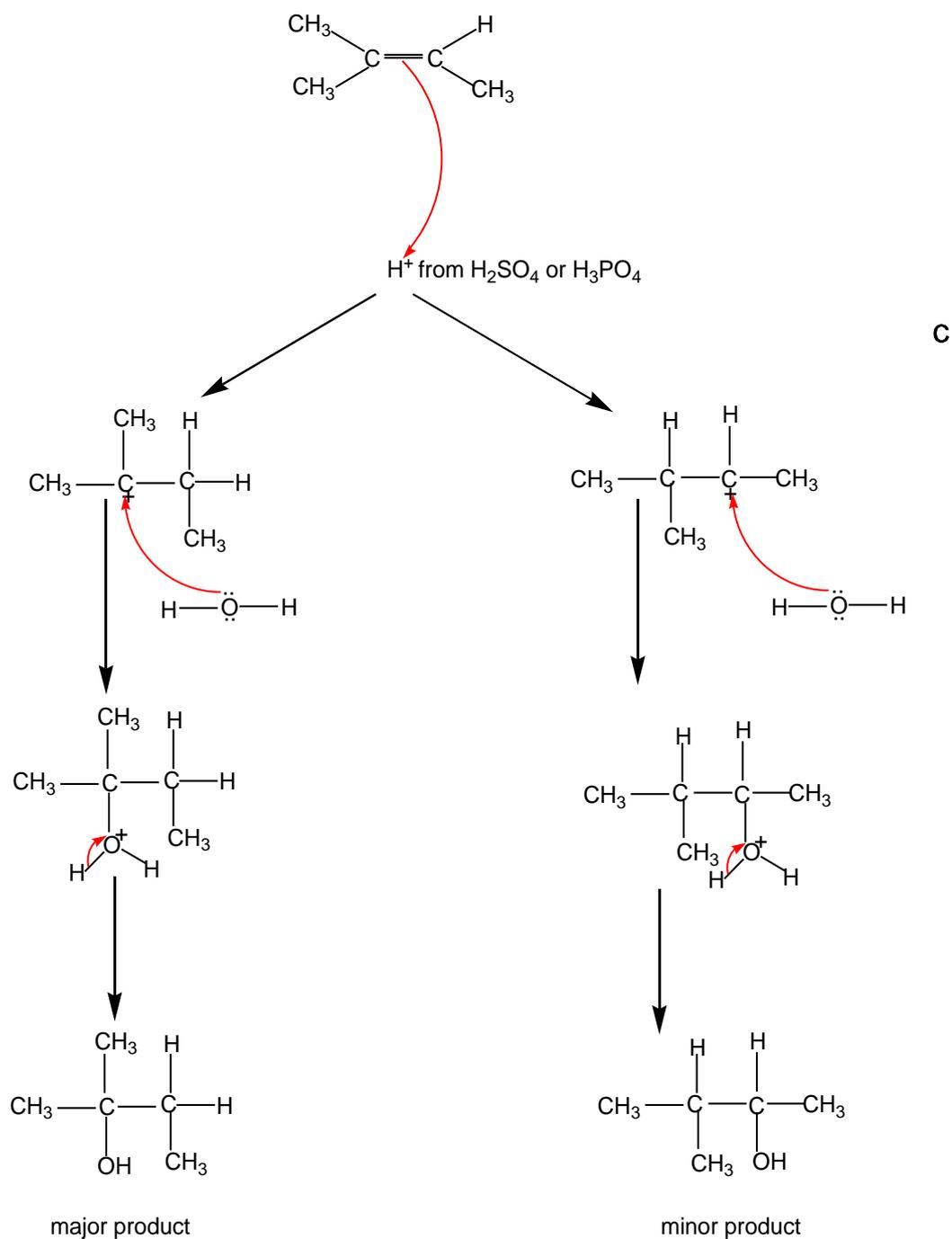

3) Addition of cold concentrated sulphuric acid

When cold concentrated sulphuric acid reacts with alkene, an alkyl hydrogen sulphate is obtained. If the starting alkene is unsymmetrical, two different alkyl hydrogen sulphates are obtained. If the alkyl hydrogen sulphate is warmed in the presence of water, an alcohol is obtained.

Example:

Reaction of propene with H_2SO_4

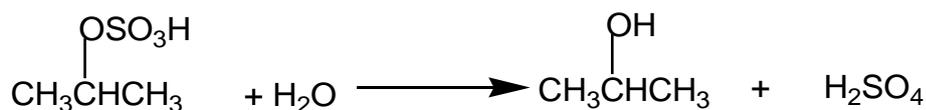
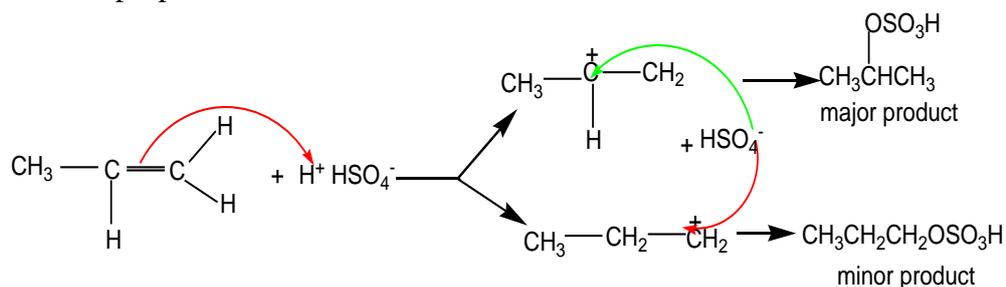

4) Addition of halogens

The addition of halogens (halogenation) on alkenes yields vicinal dihalogenoalkanes. The reaction takes place with pure reagents or by mixing reagents in an inert organic solvent.

When a chlorine or bromine molecule approaches an alkene, the pi electrons cloud interact with the halogen molecule causing its polarisation.

Example:

Reaction of ethene with bromine in an inert organic solvent gives:

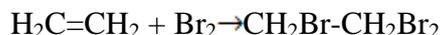

The reaction follows the mechanism below:

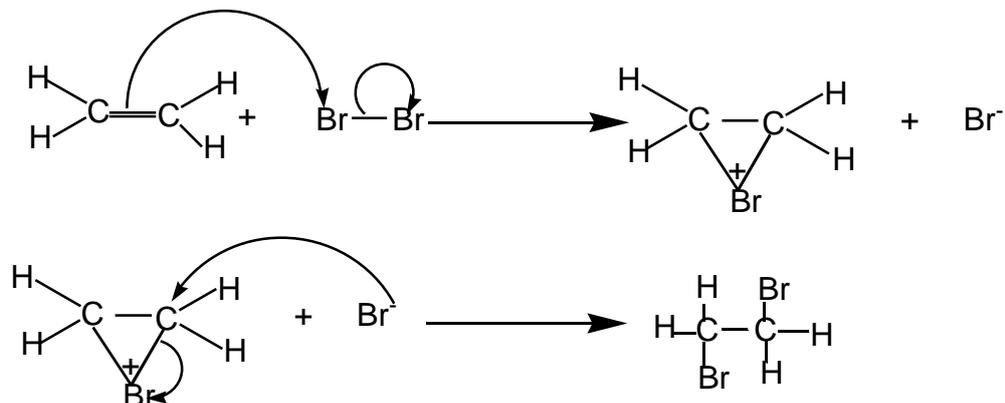

The reaction with bromine is a useful test for alkenes. The brown red colour of bromine is discharged in alkenes.

With bromine water, the reaction gives a mixture of organic products.

Examples



Bromine water containing sodium chloride gives a mixture of three organic products.

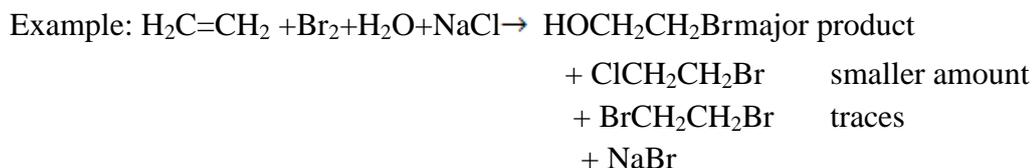

3.6.1.2. Hydrogenation

In the presence of a catalyst (Pt, Ni, Pd), alkenes react with hydrogen to give alkanes.

Example

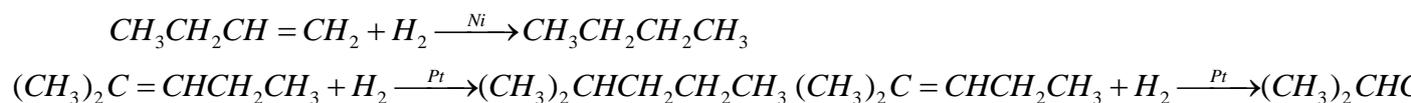

This reaction is very useful when transforming vegetable oils into fats such as margarine by hydrogenation. The process is referred as **hardening**.

Checking up 3.6.1

1. Predict the products formed when alkenes (But-1-ene and 3-methylpent-2-ene

react with each of the following reactants:

- HCl
- Water in acidic medium
- Cold sulphuric acid
- hydrogen

2. Outline the mechanism of the reaction between 2-methylpent-2-ene with hydrogen bromide.

3.6.2. Oxidation reactions

Activity 3.6.2

- Explain the terms oxidation, oxidising agent based on examples
- Explain the terms reduction, reducing agent and give examples
- The combustion of alkenes yields products, illustrate it by a reaction and indicate the types of products generated.
- Explain what happens when alkenes react with oxidising agents.

Alkenes are readily oxidised due to the presence of the double bond.

1) Reaction with oxygen

(i) Transformation to epoxides

Ethene react with oxygen in the presence of silver as a catalyst to yield epoxyethane.

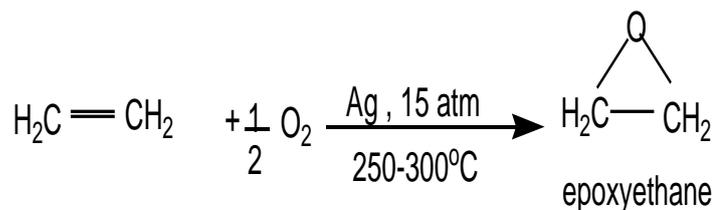

Epoxyethane is a very reactive substance. It reacts with water to give 1,2-ethanediol which is used in the making of polyesters, detergents, and so on.

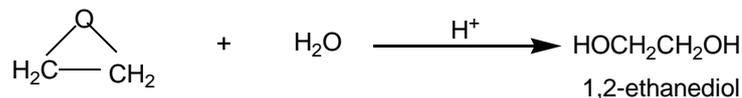

(ii) Combustion

Alkenes burn in oxygen to give carbon dioxide, water and energy.



Example:

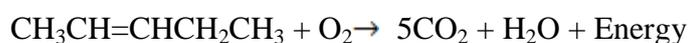

2) Reaction with ozone

An alkene reacts with ozone to give an ozonide.

The reaction is carried out at low temperature (below 20°C) in non-aqueous medium.

Example:

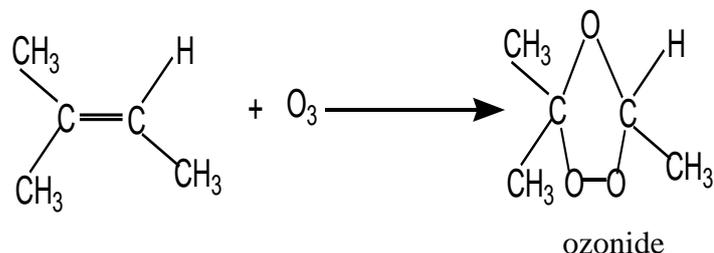

On hydrolysis, the ozonide splits into two carbonyl compounds. The reaction which is an oxidative cleavage is referred to as **ozonolysis**.

Since the by-product is hydrogen peroxide, the hydrolysis is carried out in the presence of a reducing agent.

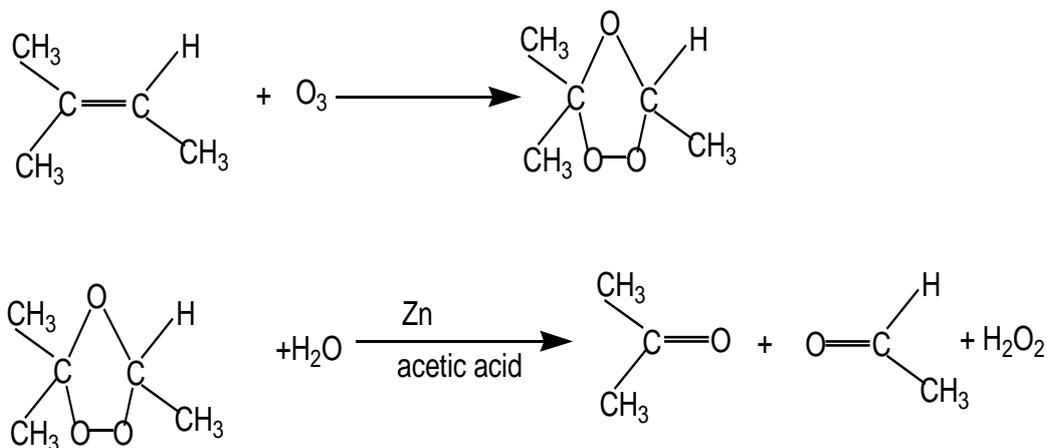

The interest of the ozonolysis reaction is that it can help the location of the double bond in an alkene.

3) Reaction with potassium permanganate

Alkenes react with dilute potassium permanganate solution to give diols. The reaction takes place in the cold.

The colour change depends on the medium of the reaction.

Examples

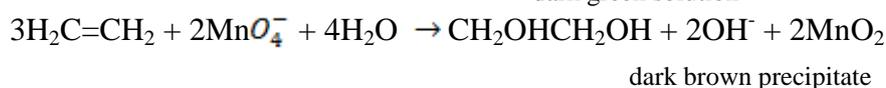
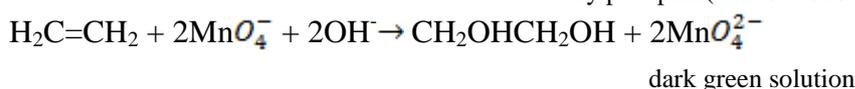

This reaction also is used to test for the presence a double bond.

An alkane does not react with KMnO_4 (left), but an alkene reacts with KMnO_4 producing a dark brown precipitate of MnO_2 (right) (Figure 3.3).



Picture 3.3: Reaction of alkenes and KMnO_4

4) Hydroformylation

The hydroformylation is a process by which alkenes react with carbon monoxide and hydrogen in the presence of rhodium catalyst to give aldehydes.

Example:



Checking up 3.6.2

1. Write the equations of the reaction between 3-methylpent-2-ene with:
 - a) Oxygen in the presence of silver catalyst.
 - b) Cold dilute potassium permanganate solution
 - c) Ozone
 - d) Analyse the interest of the reaction of alkenes with ozone.
2. Describe the observations when butane and but-2-ene react separately with potassium manganate (VII) solution.

3.6.3. Addition polymerisation

Activity 3.6.3

- 1) The students of a given class are asked to form separate couples of students. In each couple, the students hold each other by their two hands. Now each couple is asked to free one hand per student so that each student of each couple can hold a hand of another student from a different couple. What will be the result of such an arrangement compared to the first one?
- 2) From this example, predict what will happen in an addition reaction of many molecules of one or different alkenes?

Alkenes undergo addition polymerisation reaction to form long chain polymers. i.e. a **polymer** is a large molecule containing a repeating unit derived from small unit called **monomers**. A polymerisation reaction involves joining together a large number of small molecules to form a large molecule.

Many different addition polymers can be made from substituted ethene compounds. Each polymer has its physical properties and therefore many polymers have wide range of uses.

Mechanism for the polymerisation of ethene.

(1) Initiation

It is a free radical initiation.

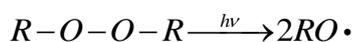

(2) Propagation

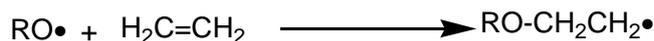

(3) Termination



where the part between brackets indicates a unit of the formula of the polymer that repeats itself in the formula; n indicates the number of the units in a formula of a polymer and is a very large number.

Summary of most alkene polymers obtained from alkenes as monomers and their uses (Table 3.1)

Table 3.1: Polymers of alkenes

Polymers	Monomers	Uses
Polyethylene(PE) -(CH ₂ -CH ₂) _n -	CH ₂ =CH ₂	Films, bags, pipe, insulating gloves, bottle stoppers, lids and plastic wraps
Polypropylene (PP) -(CH ₃ -CH-CH ₂) _n -	CH ₃ -CH=CH ₂	Household items, plastic wraps, automobile parts, batteries, garden furniture, syringes, bottle appliance.
Polystyrene (PS) (C ₆ H ₅ -CH-CH ₂) _n	C ₆ H ₅ -CH=CH ₂	plastic wraps, kitchen utensils, furniture covers thermal insulation, toys and office supplies, disposal razors.
Polyvinyl chloride -(CH ₂ -CHCl) _n -	CH ₂ =CHCl	Household items, electrical wire insulation, water pipes coverings, window and door covers, items for chemicals and industry sports.
Polytetrafluoro Ethylene(PTFE) -(CF ₂ -CF ₂) _n -	CF ₂ =CF ₂	Orthopedic and prosthetic appliances, Hearing aids, corrosion resistant and mechanical parts, upholstery, joints, flying pan coatings, electric insulation.

Checking up 3.6.3

1. Explain the terms
 - a) addition polymerisation
 - b) monomer
 - c) polymer
2. The use of some plastic bags is banned in our country. Analyse the scientific and environmental reasons of this prohibition and suggest alternative solutions.

Project work

Although they have many uses, plastics have side effects and therefore some of them are being replaced by more eco-friendly plastics.

Design a project for the making of plastics using starch from plants. In your project you will:

- 1) Perform the extraction of starch
- 2) Make plastics using starch you will have extracted
- 3) Test the properties of your plastics
- 4) Differentiate between bioplastics and biodegradable plastics.

3.7. Structure, classification and nomenclature of alkynes

Activity 3.7

1. Explain the formation of a carbon-carbon triple bond.
2. What is the hybridisation state of a carbon atom triply bonded and what is the shape of the structure around it.
3. Differentiate between the following compounds
 $\text{HC}\equiv\text{CCH}_2\text{CH}_2\text{CH}_2\text{CH}_3$ and $\text{CH}_3\text{CH}_2\text{C}\equiv\text{CCH}_2\text{CH}_3$

A triple bond consists of one sigma bond and two pi bonds. Each carbon of the triple bond uses two sp orbital to form sigma bonds with other atoms. The unhybridised 2p orbitals which are perpendicular to the axes of the two sp orbitals overlap sideways to form pi bonds.

According to the VSEPR model, the molecular geometry in alkynes include bond angle of 180° around each carbon triply bonded. Thus, the shape around the triple bond is linear.

Example: structure of ethyne.

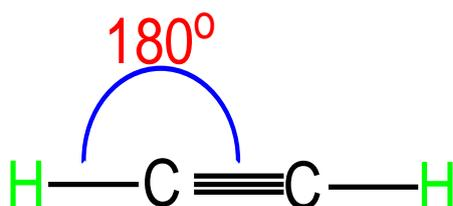

There are two types of alkynes: terminal alkynes and non-terminal (internal) alkynes

A terminal alkyne has a triple bond at the end of the chain e.g.: $\text{R}-\text{C}\equiv\text{C}-\text{H}$

A non-terminal alkyne has a triple bond in the middle of the chain: $\text{R}-\text{C}\equiv\text{C}-\text{R}'$

Examples

$\text{HC}\equiv\text{CHCH}_2\text{CH}_2\text{CH}_3$, a terminal alkyne

$\text{CH}_3\text{C}\equiv\text{CCH}_2\text{CH}_3$, a non-terminal alkyne

Alkynes are named by identifying the longest continuous chain containing the triple bond and changing the ending **-ane** from the corresponding alkane to **-yne**.

Examples

$\text{H}-\text{C}\equiv\text{C}-\text{H}$, ethyne

$\text{HC}\equiv\text{C}-\text{CH}_2\text{CH}_2\text{CH}_3$, pent-1-yne

$\text{CH}_3\text{CH}_2\text{CH}_2\text{CH}_2\text{CH}(\text{CH}_2\text{CH}_3)\text{C}\equiv\text{C}-\text{CH}_3$, 4-ethyl-2-octyne

The diagram shows the structural formula of 4-ethyl-2-octyne. The main chain is an eight-carbon alkyne with a triple bond between carbons 2 and 3. An ethyl group is attached to carbon 4. The carbons are numbered 1 to 8 in red, starting from the end closest to the triple bond.

Alkynes with four or more carbon atoms have structural isomers.

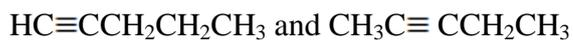

Checking up 3.7

1. Name according to the IUPAC system, each of the following compounds.

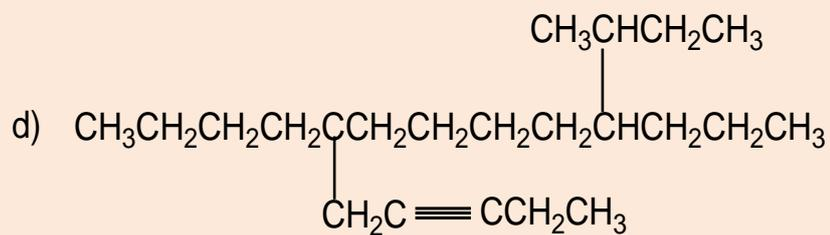
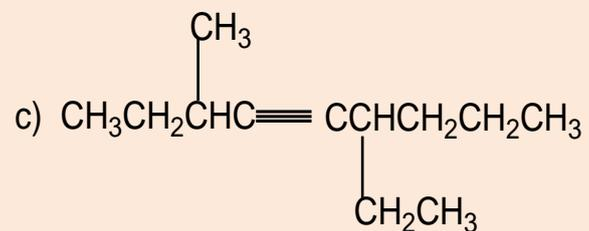
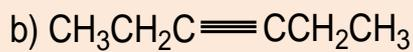
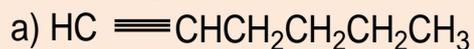

2. Write structural formula for:

- 2,5-dimethyl-3-hexyne
- 6-isopropyl-5-propyldec-3-yne
- 5-ethyl-4-methyloct-1-yne

3.8. Laboratory and industrial preparation of alkynes

1) Preparation of ethyne

Activity: 3.8

Set up the apparatus as shown in the diagram below.

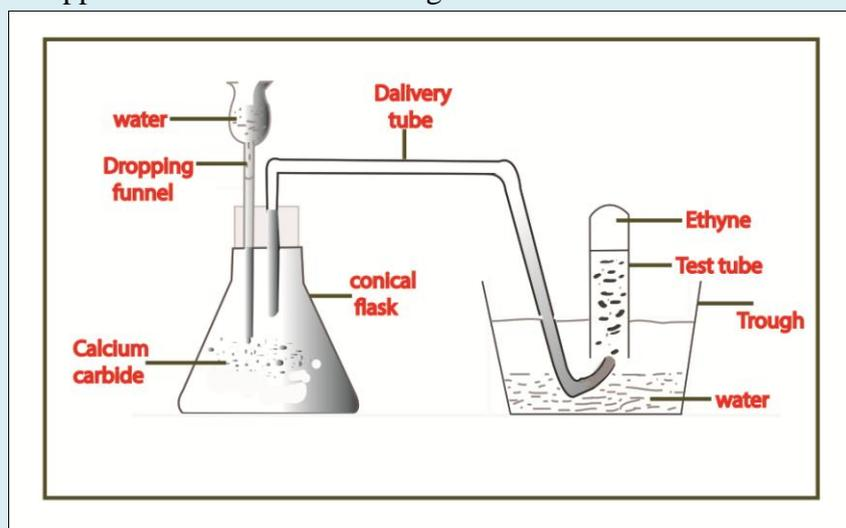
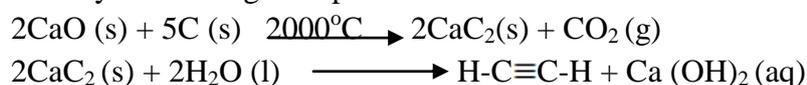

Figure 3.3 Laboratory preparation of ethyne

Procedure:

- Place 2g of calcium carbide in a conical flask
- Using the dropping funnel, add water drop by drop.
- Collect the gas produced in the test tube.
- Remove the first tube and connect a second test tube.
- To the first test tube add two drops of bromine water. Record your observations
- To the second tube add two drops of potassium manganate (VII). Record your observations.

Ethyne (acetylene) can be prepared from calcium carbide which is obtained by reduction of calcium oxide by coke at high temperature.



A more quick industrial production consists of heating methane alone at high temperature for 0.01-0.05second.

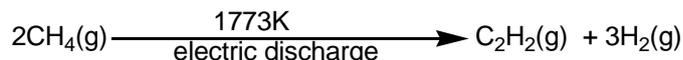

When bromine water is added to acetylene, the red colour of bromine is discharged. The solution becomes colourless.

The decolourisation of bromine water is a test for unsaturation in a compound.

When potassium manganate (VII) is added to acetylene, its purple colour is discharged.

2) Alkylation of acetylene

The hydrogen atom of ethyne as that of other terminal alkynes is slightly acidic and therefore it can be removed by a strong base like NaNH_2 or KNH_2 . The products of the reaction are acetylides. Acetylides react with halogenoalkanes to yield higher alkynes.

Examples

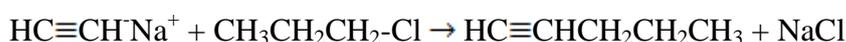

3) Dehydrohalogenation

The dehydrohalogenation of vicinal or geminal dihalogenoalkanes yields alkynes



Examples

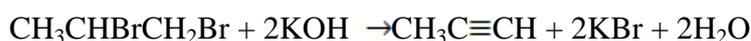
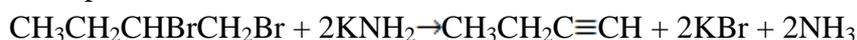

4) Dehalogenation

The dehalogenation of a tetrahalogenoalkane yield an alkyne.

Example

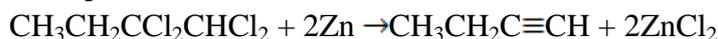

Checking up 3.8

- 1) Using chemical equations, describe the preparation of ethyne(acetylene)
- 2) By which reactions higher members of the alkynes family are prepared?
- 3) Suggest a synthesis for each of the following compounds using acetylene as the starting organic material.
 - a) Propyne
 - b) 2-butyne
 - c) 3-hexyne

3.9. Physical properties of alkynes

Activity 3.9

Alkynes have the general formula C_nH_{2n-2} . They have two fewer hydrogen atoms than alkenes, and four fewer H than alkanes. Do you expect alkynes to be more or less volatile than alkenes? Explain by referring to the nature of the chemical bonding and the structure of alkenes and alkynes.

Alkynes are non-polar compounds with physical properties similar to those of alkenes with the same number of carbon atoms. Their linear structure gives them greater intermolecular forces than alkenes

Examples

Compound	Melting point/ $^{\circ}C$	Boiling point/ $^{\circ}C$
Propene	-185	-47
Propyne	-101	-23
Pent-1-ene	-138	30
Pent-1-yne	-90	40

Alkynes are water insoluble but they dissolve in each other and in non-polar solvents.

Checking up 3.9

- 1) Which of 3,4,4-trimethylpent-1-yne and oct-3-yne has a high volatility? Explain
- 2) Table salt (NaCl) is water soluble but hex-2-yne is not. Explain why.

3.10. Chemical reactions of alkynes

Activity 3.10

Alkynes have a carbon-carbon triple bond. That is why they have a higher electron density than alkenes. Do you expect alkynes to be more reactive than alkenes? Which types of reactions can be exhibited by alkynes?

Addition reactions

As unsaturated hydrocarbons, alkynes are very reactive. Because they are unsaturated hydrocarbons, alkynes undergo addition reactions. Alkynes can add two moles of reagents.

Even though they have a higher electron density than alkenes, they are in general less reactive because the triple bond is shorter and therefore the electron cloud is less accessible.

1) Addition of hydrogen halides

Alkynes react with hydrogen halides to yield vicinal dihalogenoalkanes, the reaction follows the Markownikov's rule. The reaction takes place in four steps.

Example

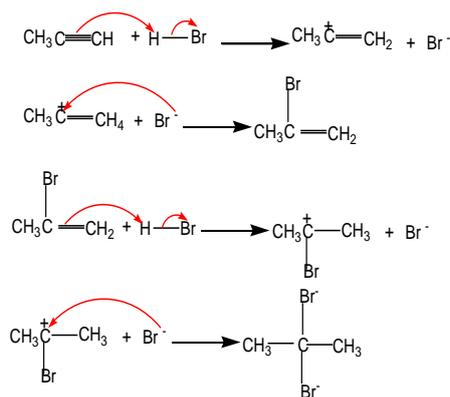

2) Addition of water

Alkynes react with water in the presence of sulphuric acid and mercury sulphate at 60°C to give carbonyl compounds.

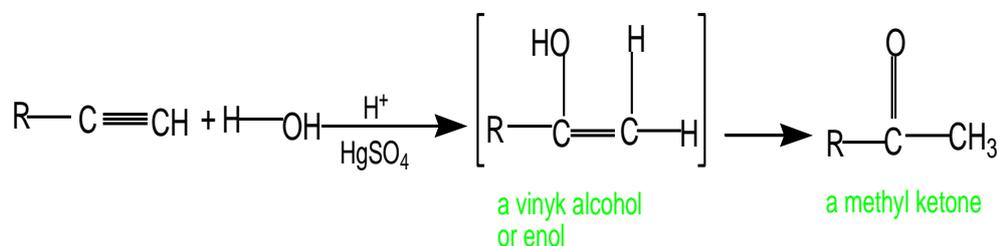

Example

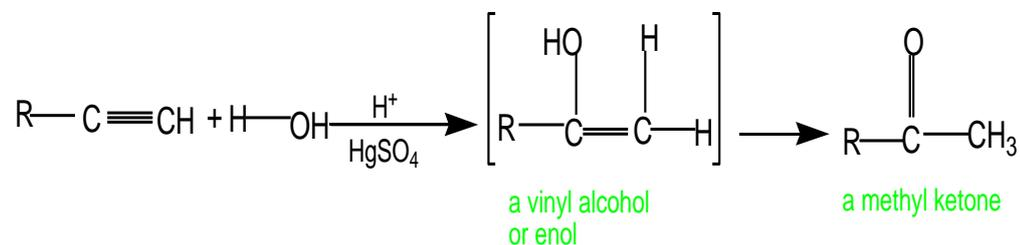

Example

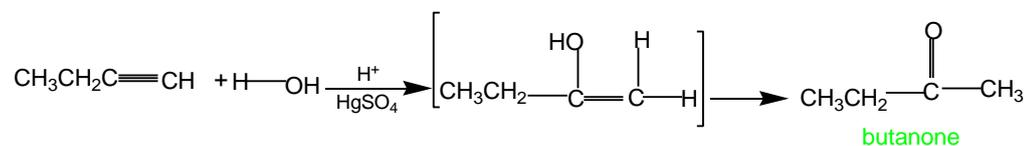

3) Hydrogenation

The hydrogenation of alkynes in the presence of palladium catalyst gives alkanes. The reaction requires two moles of hydrogen for a complete saturation.

Example

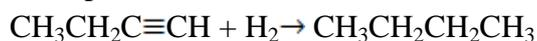

In the presence of Lindlar catalyst, the alkynes are partially hydrogenated giving alkenes

Example



A Lindlar catalyst is a heterogeneous catalyst that consists of palladium deposited on calcium carbonate and poisoned with different lead derivatives such as lead oxide or lead acetate. A heterogeneous catalyst is the one which is in the phase different from that of the reactants.

4) Reaction with metals

Terminal alkynes react with active metals to yield alkynides and hydrogen gas. Internal alkynes do not react as they do not have an acidic hydrogen atom.

Example



5) Reaction with metal salts

When a terminal alkyne is passed through a solution of ammoniacal silver nitrate, a white precipitate of silver carbide is formed.

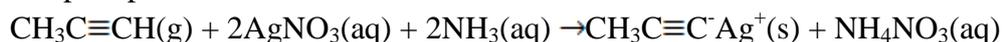

When a terminal alkyne is passed through a solution of ammoniacal copper(I) chloride, a red precipitate of copper(I) carbide is formed.

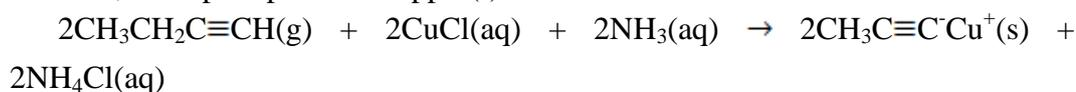

The reactions above are used to:

- Differentiate between terminal and non-terminal alkynes.
- Differentiate ethene and ethyne

The reaction shows that hydrogen atoms of ethyne are slightly acidic, unlike those of ethene.

Checking up 3.10

1. Write the formula(s) and the name (s) of the products of the reaction of – pent-1-yne with :
 - a) water
 - b) hydrogen chloride
 - c) sodium metal
2. Outline the mechanism of the reaction between but-2-yne with hydrogen bromide.
3. A hydrogen atom of a terminal alkyne is slightly acidic. Explain this statement.

3.11. Uses of alkenes and alkynes

Activity 3.11
Look at the picture below and appreciate the importance of alkenes and alkynes.

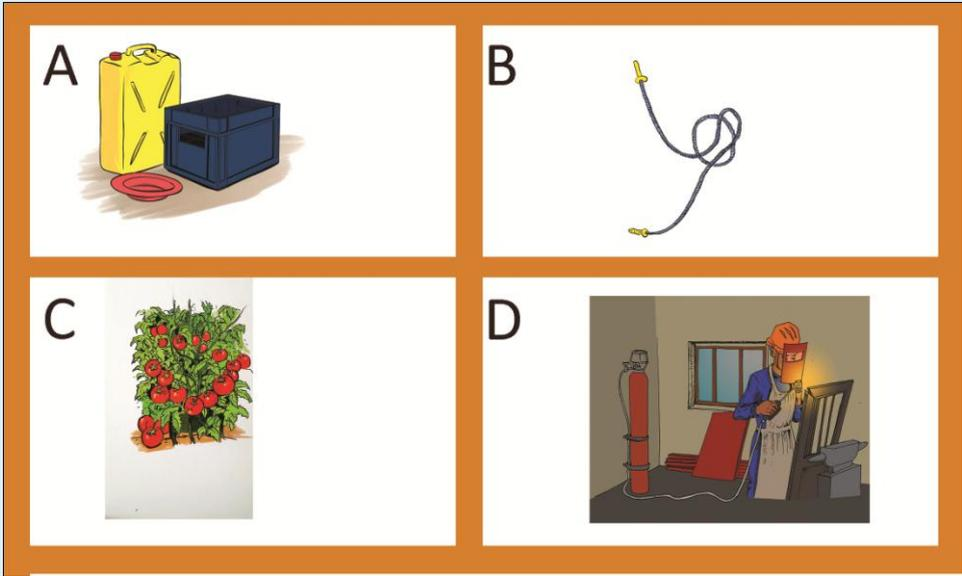

Figure 3.3: Some plastic materials (A& B), tomatoes which are ripening (C) and a person who is welding (D)

- Alkenes are extremely important in the manufacture of plastics which have many applications such as: packaging, wrapping, clothing, making clothes, artificial flowers, pipes, cups, windows, ...
- Ethene is a plant hormone involved in the ripening of fruits, seed germination, bud opening;



Picture 3.4: Ethene is a plant hormone which causes bananas to ripen

- Ethene derivatives are also used in the making of polymers such as polyvinylchloride (PVC), Teflon,...
- Alkenes are used as raw materials in industry for the manufacture of alcohols, aldehydes, ...
- Alkynes are used in the preparation of many other compounds. For example ethyne is used in the making of ethanal, ethanoic acid, vinyl chloride, trichloroethane, ...
- Ethyne (acetylene) is used as a fuel in welding and cutting metals.
- Propyne is used as substitute for acetylene as fuel for welding.

Checking up 3.11

Alkenes, alkynes and their derivatives have many applications in our daily life. Discuss this statement.

3.12. End unit assessment

I. Multiple choice questions. Choose the best answer in the following by noting the corresponding letter.

- 1) Which of the following is given off during ripening of fruits and vegetables?
 - a) Ethane
 - b) Ethene
 - c) Ethyne
 - d) Methane
- 2) Loss of hydrogen halide is called:
 - a) Halogenation
 - b) Dehydration
 - c) Dehydrohalogenation
 - d) Hydrogenation
- 3) Alkenes can be oxidized using powerful oxidizing agent in acidified medium.
 - a) Potassium manganate (VII)
 - b) Sodium manganate (VI)
 - c) Calcium manganate (VI)
 - d) All of them
- 4) The molecular formula of----- fit the general formula (C_nH_{2n-2}).
 - a) Alkanes
 - b) Alkynes
 - c) Alcohols
 - d) Alkenes
- 5) Example of addition reactions include all but one of the following. Which is the odd one out?
 - a) Combustion of propene.
 - b) Reaction of Cl_2 with propene.
 - c) Reaction of HBr with but-2-ene.
 - d) Polymerization of ethene.
- 6) Which statement is incorrect about reactions of propene?
 - a) Reaction with Br_2 and H_2O gives 1-bromo propan-2-ol as the main product.
 - b) Polymerization of propene gives polypropene, of which the isotactic and syndiotactic forms are commercially valuable.
 - c) Reaction with Br_2 in the presence of a radical initiator yields 2-bromopropane as the major product.
 - d) No correct answer.
- 7) Which one of the following statements is incorrect?
 - a) The electrophilic addition of HBr to but-2-ene involves a secondary carbonium ion intermediate.

- b) In the presence of a radical initiator, HBr reacts with but-1-ene to give 1-bromobutane as the major product.
- c) In the presence of a radical initiator, HBr reacts with but-1-ene to give a Markovnikov addition product.
- d) The major product of the electrophilic addition of HBr to hex-1-ene is 2-bromohexane.

8) What type of reaction do alkynes undergo across triple bond?

- a) Elimination reaction
- b) Substitution reaction
- c) Addition reaction
- d) Halogenation

9) Acetylene is also called:

- a) Ethyne
- b) Ethene
- c) Ethane
- d) Methane

10) What product(s) will be obtained from the acid-catalysed hydration of pent-2-yne?

- a) pentanal
- b) pent-2-one and pentan-3-one
- c) pentan-2-one
- d) pentan-3-one

II. Open questions

11) Give all possible isomers of C_5H_{10} .

12) Explain the following observations

- a) When bromine in presence of dichloromethane is added to propene, only one product is formed i.e. 1,2-dibromopropane.
- b) When bromine water (Br_2/H_2O) is added to propene, a mixture of products namely 1,2-dibromopropane and bromopropan-2-ol are obtained.
- c) When bromine in presence of carbon tetrachloride and sodium chloride is added to propene, a mixture of products namely, 1,2-dibromopropane and bromo-2-chloropropane are formed.

13) Show how the following conversions may be accomplished

- a) $CH_3-CHBr-CH_3$ to $CH_3-CH_2-CH_2Br$
- b) $CH_3-CHOH-CH_3$ to $CH_3-CH_2-CH_2OH$
- c) $CH_3-CH=CH_2$ to Propyne

14. a) In an experiment it was found that 35g of pure alkene reacted with 100g of bromine

- (i) Calculate the molecular mass of the alkene
- (ii) Write the molecular formula of the alkene
- (iii) Write the structural formulae and the systematic names of one of any two alkenes in (ii)

b) Using equations only show the mechanism for the reaction of one of alkenes in

(iii) with bromine.

15) Three hydrocarbons **D**, **E** and **F**, all have the molecular formula C_6H_{12} . **D** decolourises an aqueous solution of bromine and shows geometric isomerism. **E** also decolourises an aqueous solution of bromine but does not show geometric isomerism. **F** does not decolourise an aqueous solution of bromine. Draw one possible structure each for **D**, **E** and **F**.

16) Alkenes such as ethene and propene have been described as the building blocks of the organic chemical industry. Discuss this statement, giving examples. What particular features of the chemistry of alkenes make them suitable for this role and why are alkanes less suitable.

UNIT 4: HALOGENOALKANES (ALKYL HALIDES)

Key unit competency

The learner should be able to relate the physical and chemical properties of halogenoalkanes to their reactivity and their uses

Learning objectives

- *Define halogenoalkanes and homologous series.*
- *Explain the reactivity of halogenoalkanes.*

- Explain the physical properties of halogenoalkanes.
- Describe preparation methods for halogenoalkanes.
- Explain different mechanisms in halogenoalkanes.
- Explain the uses and dangers associated with halogenoalkanes.
- Draw displayed structural formulae of halogenoalkanes and give names using IUPAC system.
- Classify halogenoalkanes according to developed formula as primary, secondary and tertiary.
- Write reaction mechanisms of halogenoalkanes as $SN1$, $SN2$, $E1$ and $E2$.
- Test for the presence of halogenoalkanes in a given sample organic compound.
- Appreciate the uses and dangers of halogenoalkanes in everyday life.
- Develop the awareness in protecting the environment.
- Develop team work approach and confidence in group activities and presentation sessions.

Introductory activity

Look at the pictures below and answer the following questions. Record your answers and discuss them.

- Observe carefully pictures 4.1 and 4.2 and suggest the similarity between them.
- Observe carefully pictures 4.1 and 4.2 and suggest the difference between them.
- Substances which are used in the pictures belong to the same homologous series. They may be obtained from the reaction between alkanes and halogens. What homologous series do these substances belong to?

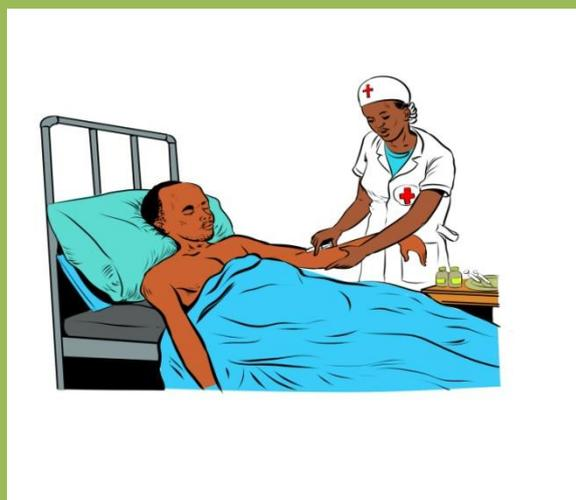

Picture 4.1



Picture 4.2

4.1. Definition and nomenclature of halogenoalkanes

Activity 4.1

1) Look at the following compounds and answer the questions that follow.

- a) $\text{CH}_3\text{CH}_2\text{CHClCH}_2\text{CH}_2\text{CH}_3$
- b) $\text{CH}_3\text{CH}_2\text{CH}_2\text{CH}_2\text{CH}_3$
- c) $\text{CH}_2\text{ICH}_2\text{CH}_2\text{CH}_3$
- d) $\text{CH}_3\text{CH}_2\text{CH}(\text{CH}_3)_2$
- e) $\text{CH}_3\text{CHBrCH}_2\text{CH}_2\text{CH}_3$

Questions:

- (i) Which structures do represent halogenoalkanes?
- (ii) What are the similarities between the selected structures?
- (iii) From your answers above deduce the general formula for alkanes.

1) Definition

Halogenoalkanes compounds are compounds in which the halogen atoms like **chlorine, bromine, iodine** or **fluorine** are attached to a hydrocarbon chain. When the halogen atom is attached to a hydrocarbon chain the compound is called a **halogenoalkane** or **haloalkane** or an **alkyl halide**.

Halogenoalkanes contain halogen atom(s) attached to the sp^3 hybridised carbon atom of an alkyl group.

2) Nomenclature of halogenoalkanes

Halogenoalkanes are organic compounds that contain a **halogen** atom: **F, Cl, Br, I**.

They are named using the prefixes **fluoro-, chloro-, bromo-** and **iodo-**.

Numbers are used if necessary to indicate the position of the halogen atom in the molecule.

Examples:

$\text{CH}_3\text{CH}_2\text{Cl}$: Chloroethane; here it is not necessary to indicate the number 1.

$\text{CH}_3\text{CHBrCH}_3$: 2-bromopropane.

If the molecule contains more than one halogen atom of the same kind, the prefixes **di-, tri-, tetra-**, etc... are used.

Examples:

$\text{CH}_2\text{ClCH}_2\text{Cl}$: 1,2-dichloroethane

$\text{CHCl}_2\text{CHClCH}_3$: 1,1,2-trichloropropane.

Checking up 4.1

1. Name these compounds

- a) $\text{CH}_3\text{CH}_2\text{CHICH}_3$
- b) CH_3CHCl_2
- c) CCl_4
- d) CHCl_3
- e) $(\text{CH}_3)_3\text{CBr}$

2. Write the structural formulae for the following compounds:

- a) 1,2-dibromo-3-chloropropane

b) 1,1,2-trichloro-1,2,2-trifluoroethane

4.2. Classification and isomerism

Activity 4.2

Consider the following compounds and based on the carbon atom attached to the halogen atom, classify them.

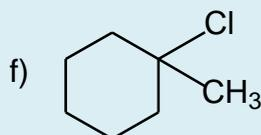
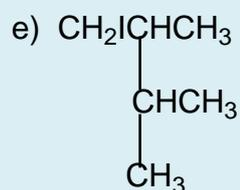
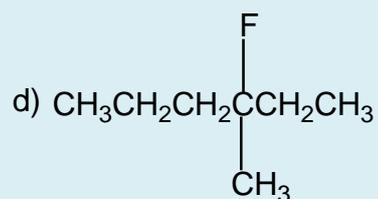
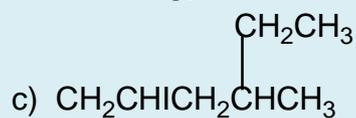
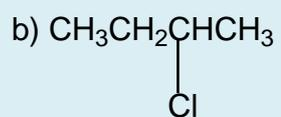
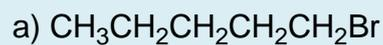

Do research to find an appropriate name for each class

4.2.1. Classification of halogenoalkanes

There are three types of halogenoalkanes:

Primary

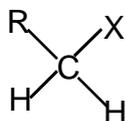

Secondary

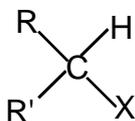

Tertiary

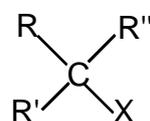

A primary halogenoalkane has a halogen atom attached to the ended carbon atom of the chain. A secondary halogenoalkane has a halogen atom attached to a carbon bonded to two other carbon atoms while a tertiary halogenoalkane has a halogen atom attached to a carbon bonded to three other carbon atoms.

4.2.2. Isomerism

Halogenoalkanes exhibit both chain and position isomerism.

e.g: Molecular formula $\text{C}_4\text{H}_9\text{Br}$

- a) Chain isomerism: This arises due to arrangement of carbon atoms in chains of different size.

The chain isomers are $\text{CH}_3\text{CH}_2\text{CH}_2\text{CH}_2\text{Br}$: 1-bromobutane



:2-methyl-1-bromopropane

- b) Position isomerism: This arises due to the different positions taken by the halogen atom on the same carbon chain.

The following compounds are position isomers: $\text{CH}_3\text{CH}_2\text{CH}_2\text{CH}_2\text{Br}$ and $\text{CH}_3\text{CH}_2\text{CHBrCH}_3$; because the atoms of bromine are on different positions of the chain.

Hence, all isomers of the compound with molecular formula $\text{C}_4\text{H}_9\text{Br}$ are the following.

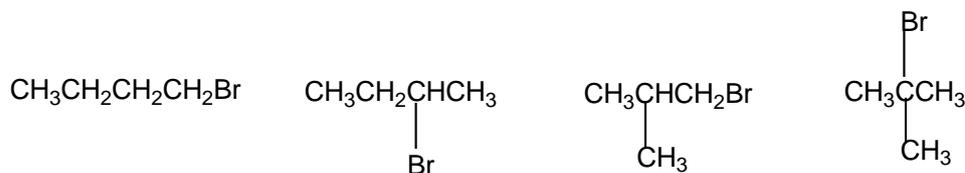

Checking up 4.2:

1. How many positional isomers possess the chlorobromopropane, $\text{C}_3\text{H}_6\text{BrCl}$? Enumerate those able to form optical isomers. Draw their structural formulae.
2. Illustrate the structural formulas of :
 - a) 1,1,2-trichloropropane
 - b) 2-chloro-2-methylpropane

4.3. Physical properties of halogenoalkanes

Activity 4.3

1. Consider the following substances:
Sodium chloride, potassium bromide, hexane, pentane, trichloromethane, tetrachloromethane
Mix a sample of each compound (1g for solids, 2ml for liquids) with 10ml of water.
2. Record your observations.
3. Write down your conclusions.
4. Based on the physical state and the nature of chemical bonding, predict the increasing order in the boiling points of the compounds above.
5. Write down your conclusions.

(1) Volatility

Volatility is a property that shows if a substance transforms easily or not into vapour or gaseous form. This property depends on the nature of the bonds that make up the molecule of the substance. Generally covalent compounds and substances are more volatile than polar covalent compounds. We know that halogens when bonded to other atoms form polar bonds because they possess high electronegativities: F = 4.0, Cl = 3.0, Br = 2.8, I = 2.5, and C = 2.5.

The more the difference of electronegativities of the atoms that form the bond, the more polar is the bond. This explains the high polarity of C-F bond with an electronegativity difference of 1.5, and the low polarity of C-Cl and C-Br bonds where the electronegativity differences are 0.5 and 0.3 respectively.

The presence of polarity or charge distribution results into more attraction between polar molecules called dipole-dipole attraction forces, one type of Van der Waals forces, as shown below:

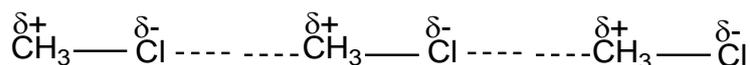

The dashed line represents the attraction forces between the polar molecules or dipoles.

Therefore, more energy must be supplied to separate polar molecules and this explains why melting and boiling temperatures of fluoroalkanes and chloroalkanes are higher than those of alkanes of similar molecular mass.

As we have already learnt, molecules of organic halogen compounds are generally polar. Due to the greater polarity as well as higher molecular mass as compared to the parent hydrocarbons, the intermolecular forces of attraction (dipole-dipole and van der Waals) are stronger in the halogen derivatives. That is why the boiling points of chlorides, bromides and iodides are considerably higher than those of the hydrocarbons of comparable molecular mass (Table 4.1).

Table 4.1: Comparison of boiling points of some halogenoalkanes

Boiling Points of Haloalkanes (°C)						
R	X =	H	F	Cl	Br	I
CH ₃		-161.7	-78.4	-24.2	3.6	42.4
CH ₃ CH ₂		-88.6	-37.7	12.3	38.4	72.3
CH ₃ (CH ₂) ₂		-42.1	-2.5	46.6	71.0	102.5
CH ₃ (CH ₂) ₃		-0.5	32.5	78.4	101.6	130.5
CH ₃ (CH ₂) ₄		36.1	62.8	107.8	129.6	157.0
CH ₃ (CH ₂) ₇		125.7	142.0	182.0	200.3	225.5

Chloromethane, bromomethane, chloroethane and some chlorofluoromethanes are gases at room temperature. Higher members are liquids or solids.

The attractions get stronger as the molecules get bigger in size. The pattern of variation of boiling points of different halides is depicted in Figure 4.1. For the same alkyl group, the boiling points of alkyl halides increase in the order: RF < RCl < RBr, < RI This is because with the increase in size and mass of halogen atom, the magnitude of van der Waal forces increases.

(2) Solubility

The solubility is the capacity of a substance to dissolve in a given solvent; in chemistry the most common solvent we refer to is water. It is a result of the interaction between the molecules of the substance, a solute, and the molecules of the solvent.

Polar molecules can interact with water molecules, but the attractive forces set up between water molecules and molecules concerned are not as strong as the hydrogen bonds present in water. Halogenoalkanes therefore, although they dissolve more than alkanes, are only slightly soluble in water.

(3) State

The state of matter is the physical appearance of that matter: solid, liquid and gaseous.

Chloromethane, bromomethane, chloroethane and chloroethene are colourless gases at room temperature and pressure. The higher members are colourless liquids with a sweet pleasant smell

(4) Density:

The density is a measure of the quantity of matter by volume unit. Cotton wool is less dense than sand because if you compare the quantity of matter cotton wool and sand contained in for instance 1m³, you find that there more matter in sand than in cotton wool.

The density of halogenoalkanes increases in the order $\text{RCl} < \text{RBr} < \text{RI}$, since the atomic weight of halogens increases in order $\text{Cl} < \text{Br} < \text{I}$. Iodo, bromo and polychloro derivatives are denser than water but chloro derivatives are less dense than water.

Checking up 4.3

- Arrange each set of compounds below in order of increasing boiling points and explain why.
 - Bromomethane, tribromomethane, chloromethane, dibromomethane.
 - 1-chloropropane, 2-chloro-2-methylpropane, 1-chlorobutane.
- Explain the origin of the difference between the boiling temperatures of the following compounds:

Compound	Molar mass/ g mol^{-1}	Boiling temperature/ $^{\circ}\text{C}$
C_5H_{12}	72	36
$\text{C}_3\text{H}_7\text{Cl}$	79	46
C_3H_8	44	-42

4.4. Preparation methods of halogenoalkanes

1) From alkenes and alkynes

Activity 4.4.1

1. Give the product for each of the following chemical reaction.

- $\text{CH}_3\text{CH}_2\text{CH}=\text{CH}_2 + \text{HBr} \rightarrow$
- $\text{CH}_3\text{CH}=\text{CHCH}_3 + \text{HI} \rightarrow$
- $(\text{CH}_3)_2\text{C}=\text{CHCH}_3 + \text{HCl} \rightarrow$
- $\text{CH}_3\text{CH}=\text{CHCH}_3 + \text{Br}_2 \rightarrow$
- $\text{CH}_3\text{C}\equiv\text{CH} + \text{HCl} \rightarrow$

2) Identify the class of the products of the reactions above.

Halogenoalkanes can be prepared by a reaction of alkenes or alkynes with:

(i) hydrogen halides

Addition of hydrogen halide to alkenes, gives alkyl halides as the products. The orientation in the addition reaction is described by Markovnikov's rule (see alkenes).

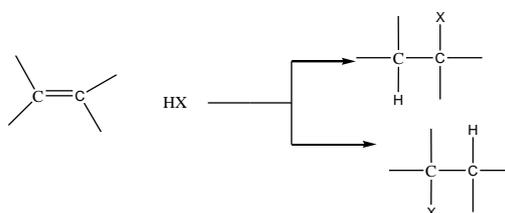

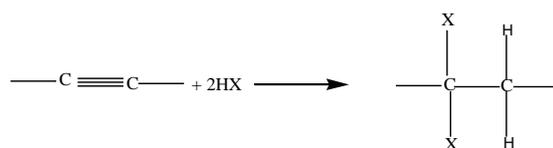

Examples



Major product

minor product



(ii) Halogens

Examples

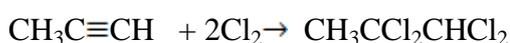
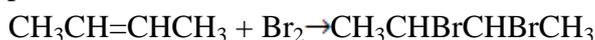

2) From alcohols

When ethanol reacts with potassium bromide in the presence of concentrated sulphuric acid, bromoethane is formed. The reactions that took place in flask A are the following.

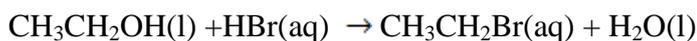
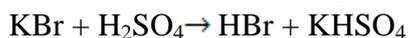

In this reaction the hydroxyl group $-\text{OH}$ is replaced with a bromine atom.

Halogenoalkanes are also obtained from alcohols using other reagents such as phosphorus halides (PCl_3 , PCl_5 , PBr_3 , PI_3) and thionyl chloride (SOCl_2)

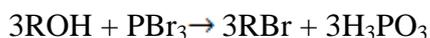

Example

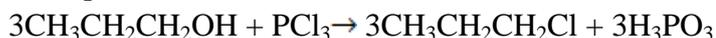

Example

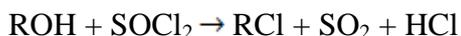

Example

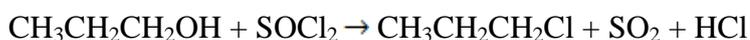

3) From alkanes

Activity 4.4.2

Observe the set up below and answer to the following questions. Record your answers and discuss.

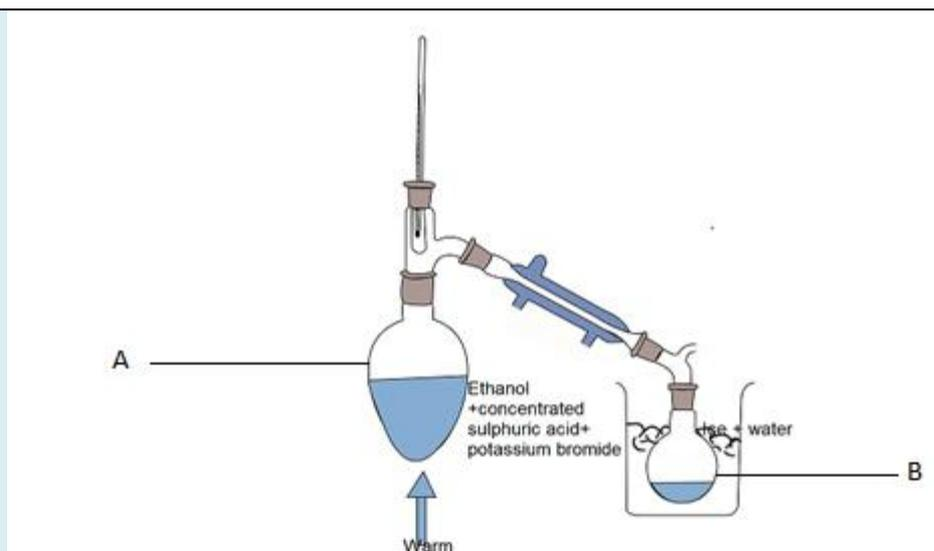

Picture 4.2: preparation of halogenoalkanes

- a) Observe carefully the picture and suggest the product of the reaction in flask A.
- b) What is the role of:
 - (i) Concentrated sulphuric acid?
 - (ii) Water in the picture above?

Direct halogenation of alkanes in the presence of ultraviolet light gives alkyl halides and a hydrogen halide.

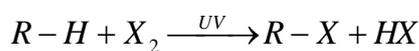

Example

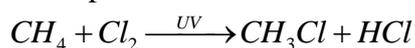

4) From aldehydes or ketones

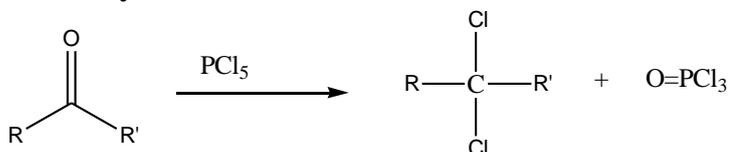

Example

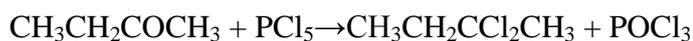

Checking up 4.4:

1) Complete the following chemical reactions :

- a. $CH_2=CH_2 + HCl \rightarrow$
- b. $CH_4 + Cl_2 \rightarrow$
- c. $CH_3CH_2-OH + HBr \rightarrow$

- d. $\text{CH}_3\text{-CH}_2\text{CH}_2\text{OH} + \text{PCl}_5 \xrightarrow{\text{H}_2\text{SO}_4}$
 e. $\text{CH}_3\text{CH}_2\text{-OH} + \text{SOCl}_2 \rightarrow$
 f. $3\text{CH}_3\text{CH}_2\text{CH}_2\text{-OH} + \text{PCl}_3 \rightarrow$
 g. Write a chemical equation for the preparation of a halogenoalkane from an aldehyde.

2) Give the reagents and conditions needed to make the following compounds from 1-bromopropane:

- a) propan-1-ol, b) propene.

4.5. Chemical properties

Activity 4.5.1

To investigate some reactions of halogenoalkanes

To 5cm^3 of dilute sodium hydroxide solution in a test tube, add 5 drops of 1-bromobutane and gently warm the mixture.

Carefully smell the product.

Neutralize the solution with dilute nitric acid. Acidify the solution by adding 5 more drops of nitric acid.

Then add 5 drops of silver nitrate and observe. Write down your observations.

Write the equation of the reactions that take place. What is the role of sodium hydroxide in this experiment?

When 1-bromobutane reacts with dilute sodium hydroxide solution, a product with a sweet alcoholic smell is formed. That indicates that an alcohol is formed. The formation of a pale yellow precipitate on addition of silver nitrate indicates the presence of bromide ions. That means the carbon-bromine bond has been heterolytically broken (the bromine atom takes the whole bonding electron pair). In other words the bromine atom has been replaced by hydroxide ions. Thus, sodium hydroxide provides the OH^- ion which replaces bromine atom which leaves as a bromide ion. As OH^- is a nucleophile (Lewis base) this reaction is called **nucleophilic substitution**.

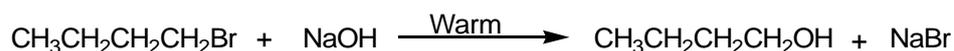

The order of reactivity for the same alkyl group is such that iodides > bromides > chlorides >> fluorides.

Example: $\text{CH}_3\text{-I}$ reacts faster than $\text{CH}_3\text{-Br}$ which also reacts faster than $\text{CH}_3\text{-Cl}$ which react much faster than $\text{CH}_3\text{-F}$.

The greater the electronegativity of the halogen, the greater the separation of charges on the carbon and the halogen atoms, hence the stronger the bond. Therefore the reaction is fastest with Iodoalkane because iodine is less electronegative compared to bromine and Cl. Hence it will have weak C-I bond unlike that of C-Cl which will be very strong due to the strong electronegativity of the chlorine atom. Hence bond energies below are due to the above reason.

Type of bonds	C-I	C-Br	C-Cl	C-F
Bond energy (kcal)	43.5	54	66.5	116

Because the carbon atom attached to the halogen atom is deprived of its electron, it carries a partial positive charge $-C^{\delta+} - X^{\delta-}$. Thus when electron rich substrates called nucleophiles, approach the carbon atom, the halogen atom leaves as a halide ion. Hence alkyl halides undergo **nucleophilic substitution** reaction, also written as SN.

1) Nucleophilic substitution reaction:



(a) **Reaction with aqueous alkali:** when alkyl halides are refluxed with aqueous alkali, or moist silver oxide, alcohols are produced through substitution of the halogen by hydroxide ion.

This reaction is also called "hydrolysis".

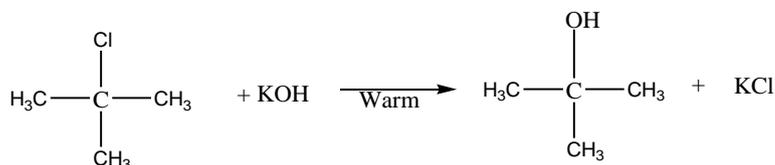
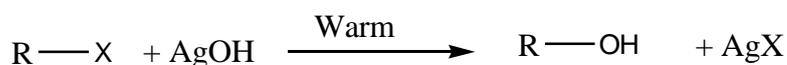

Note: Tertiary alkyl halides react by SN₁ mechanism, i.e. the mechanism where the first step is the self ionization forming a carbonium ion (carbocation), an alkyl radical that has lost its electron and bear a positive charge on the carbon, which immediately adds the nucleophile (see the mechanism SN₁ below).

Secondary alkyl halides however react by either S_N1 or S_N2 mechanism depending on the condition of the reaction while primary alkyl halides react by S_N2 (see below).

S_N1 : Unimolecular Nucleophilic Substitution that takes place in two steps; the reaction rate is determined by the concentration of one molecule.

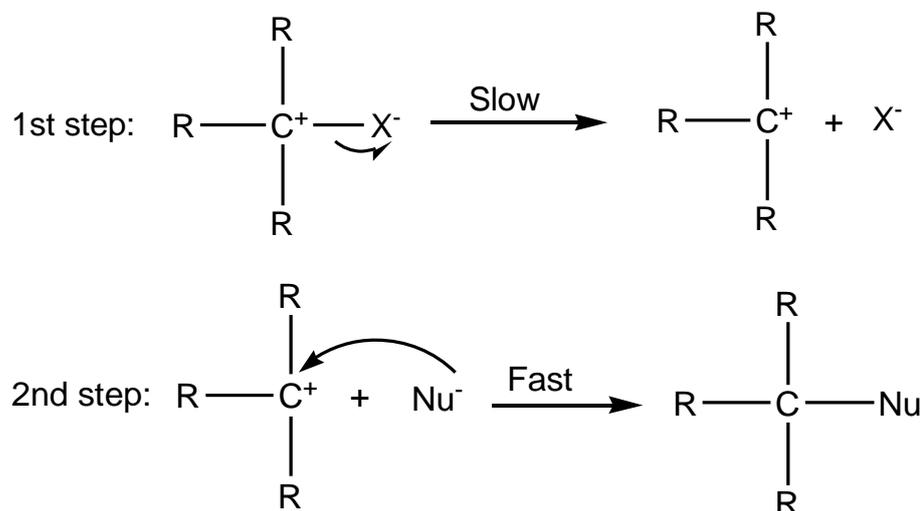

Example of S_N1 reaction: hydrolysis of tertiary alkyl halides with sodium hydroxide

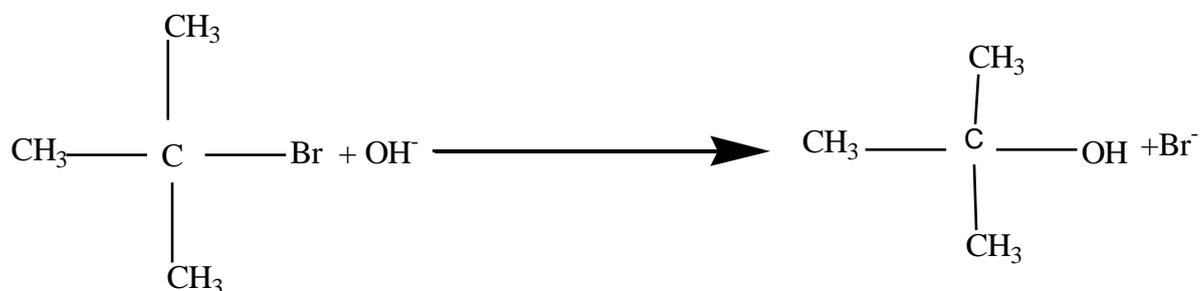

The hydrolysis can also take place when water alone is added to tertiary alkyl halides. In this case water molecules act as nucleophiles.

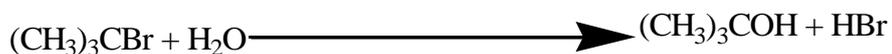

Mechanism: Step 1: self ionization of the alkyl halides to a stable carbonium ion and a halide ion. This is the slowest step of the reaction hence it is the rate determining step.

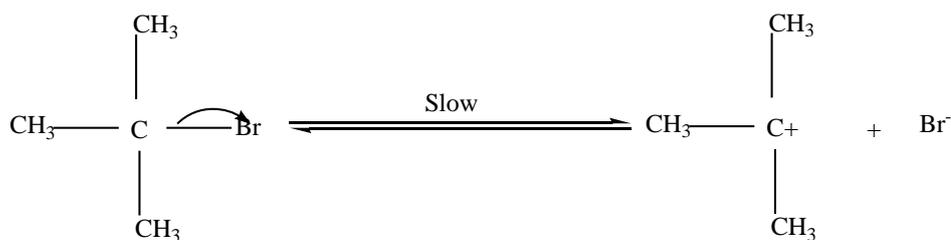

Step 2: Attack by incoming nucleophile. This is a fast reaction.

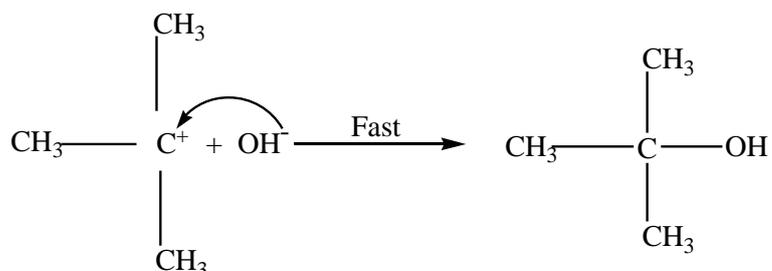

The potential energy P.E against reaction co-ordinate for hydrolysis of tertiary alkyl halides is as below (Fig.4.2). Potential energy is the energy stored in chemical bonds of a substance, or the energy of an object due to its position.

The diagram below shows that the products formed have lower energy than the reactants, this indicates a favorable situation for the reaction to occur spontaneously.

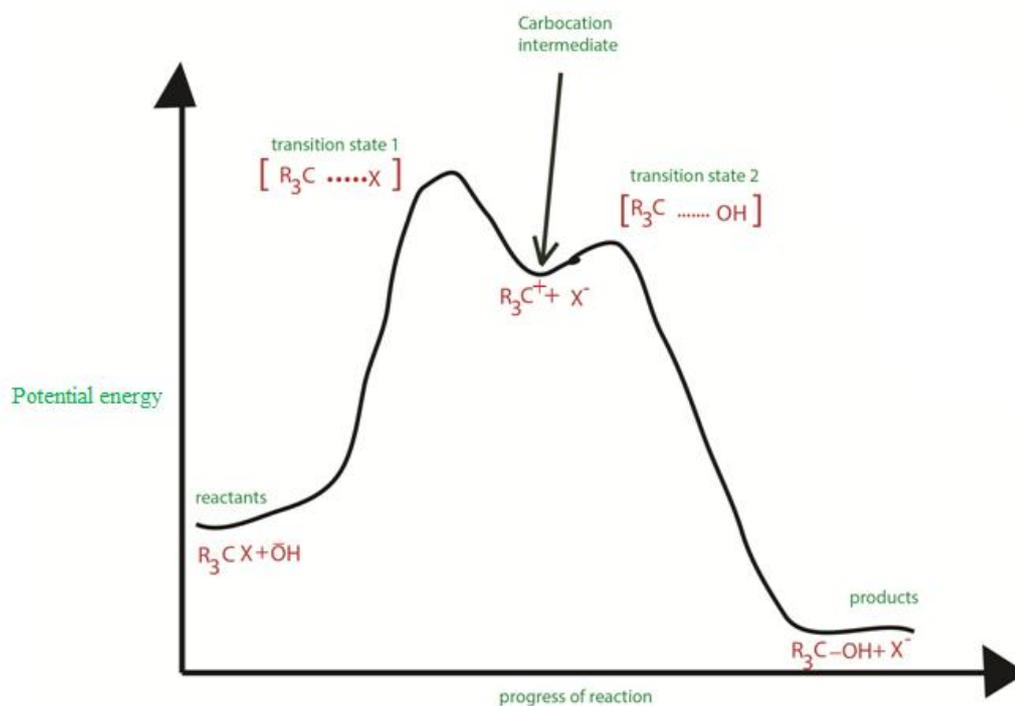

Figure 4.2: S_N1 potential energy diagram

Note: This reaction is of practical importance in organic synthesis because it is used to increase the length of a carbon chain.

(e) Reaction with silver nitrite

When alkyl halides are refluxed with silver nitrite, a mixture of a nitro alkane and alkyl nitrite are obtained as the products. The difference between the two products is in the bonds between the nitrite and the alkyl: C-NO₂ in nitro alkane and C-ONO in alkyl nitrite.

The two products can be separated by fractional distillation.

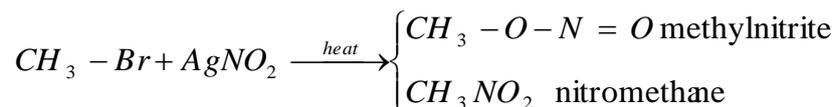

(f) Reaction with ammonia and amines

Reaction of alkyl halide with concentrated ammonia produces a mixture of amines.

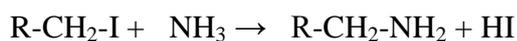

The alkyl amine produced can then react with a molecule of alkyl iodide to produce a series of substituted amines as shown in the reactions below:

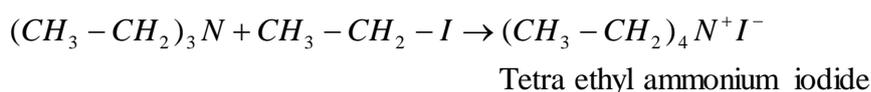
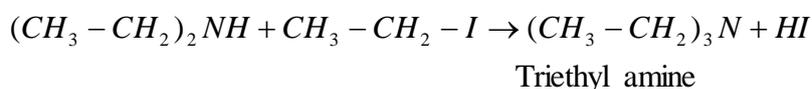
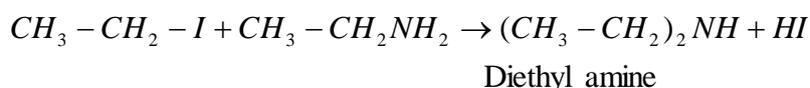

Example of S_N2 reaction: hydrolysis of primary alkyl halides with sodium hydroxide

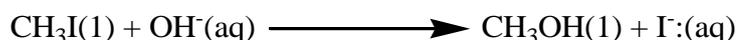

Mechanism:

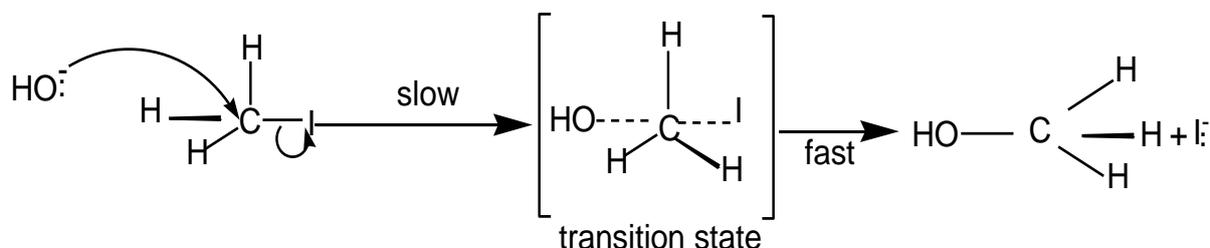

The transition state shows partial C-O bond formation and partial C-I bond cleavage. Energy change diagram during the reaction is as below:

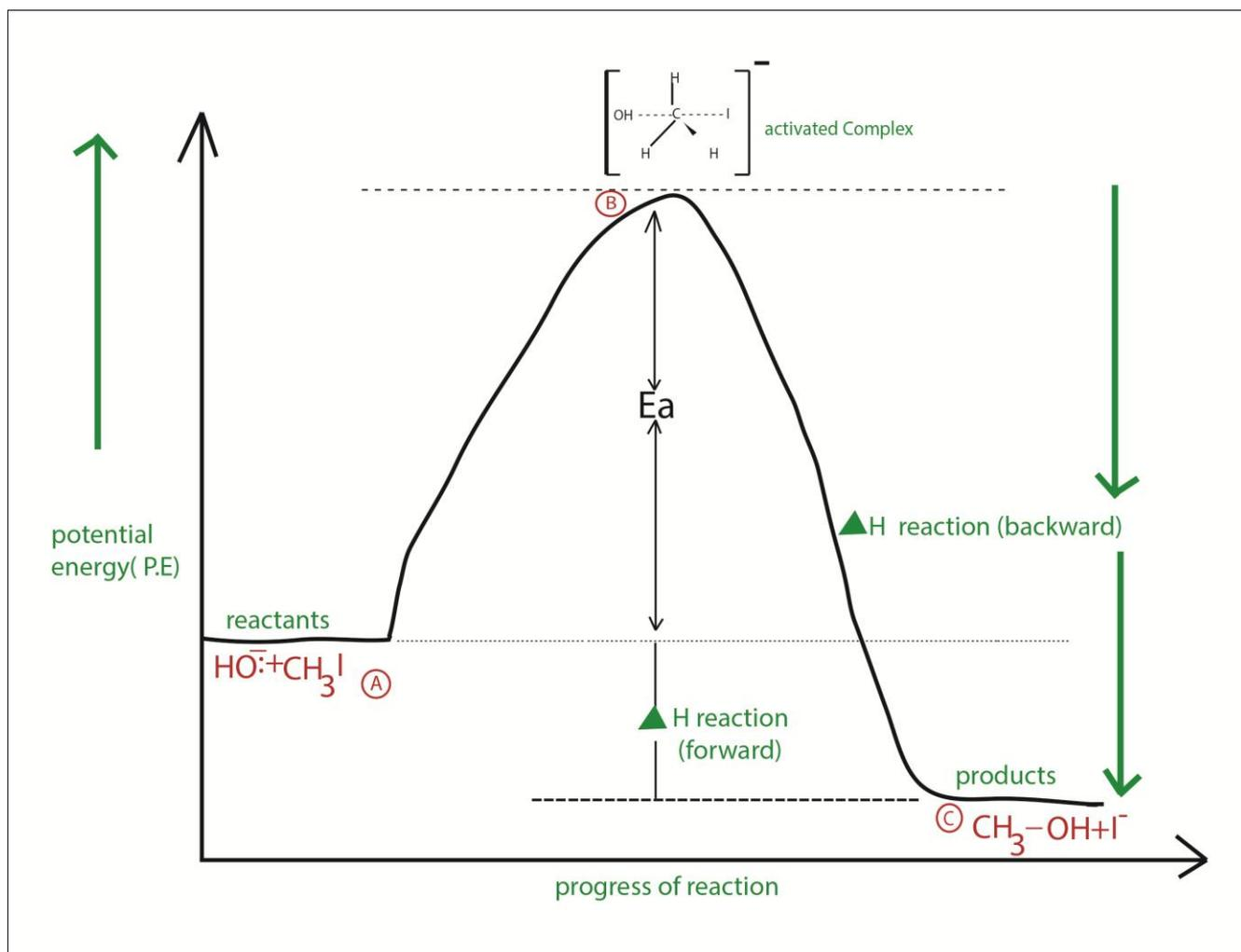

Figure 4.4: S_N2 potential energy diagram

The P.E of the system initially increases along AB curve because energy is required to break C-I bond; but when C-O is formed, energy is released and this is shown by the curve BC. Since energy released by the formation of C-O bond is greater than the energy required to break C-I, the products end up with a lower energy compared to the reactant and this is favourable for the reaction to occur. At B a maximum P.E is reached when C-I bond is partially broken and C-O bond is partially formed. This state is called **the transition state** or **activated complex**. The energy barrier, E_a , which must be overcome in order that the transition state is reached, is called **the activation energy of the reaction**. The P.E of the system then falls along BC releasing energy due to the formation of C-O bond.

Primary alkyl halides prefer **S_N2 reaction** because of the unstable nature of the intermediate or the activated complex formed in S_N2 mechanism, the primary carbonium ion, R-CH_2^+ .

Table: 4. 1: Summary of alkyl halides reactions.

Nucleophilic reagents	Products
OH^- (Base)	R-OH (alcohols)
$\text{R}'\text{-O}^-$ ($\text{R}'\text{-O-Na}$)	$\text{R}'\text{-O-R}$ (ethers)
RCOO^- (RCOONa)	RCOOR' : esters
CN^- (KCN)	R-CN (nitriles)
$\text{R}'\text{C}\equiv\text{C}^-$	$\text{R}'\text{-C}\equiv\text{C-R}$ (alkynes)
R^- (RMgX)	$\text{R}'\text{-R}$ (alkanes)
NO_2^- (AgNO_2)	R-NO_2 , R-ONO

2) Elimination reactions

Activity 4.5.2

- 1) What is meant by elimination reaction?
- 2) Can halogenoalkanes undergo elimination reactions? Explain.
- 3) a) What are the products of an elimination reaction in halogenoalkanes?
 - b) What specific name is given to this reaction?
 - c) What are the conditions and reagent required for this type of reaction?

An elimination reaction is where a saturated organic compound loses an atom or group of atoms to form an unsaturated organic compound. Elimination is the opposite of addition reaction.

Alkyl halides when boiled with alcoholic potassium hydroxide form alkenes by elimination reaction. Hence the alkyl halide loses a molecule of the hydrogen halide.

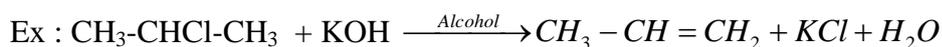

Note: Elimination reaction usually occurs in competition with substitution reaction. So when chloroethane is treated with a solution of potassium hydroxide two organic products are formed depending on the conditions of the reaction.

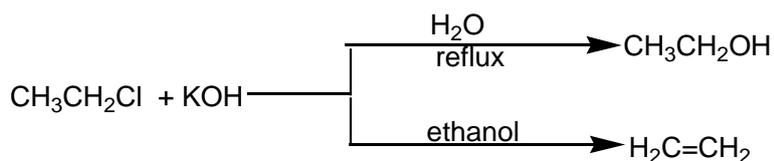

Ethene is formed by elimination reaction while diethyl ether is formed by substitution reaction.

Mechanism: Ether is formed by S_N2 mechanism in which $CH_3CH_2O^-$ is acting as nucleophile. While Ethene is formed by elimination reaction in which $CH_3CH_2O^-$ is acting as base?

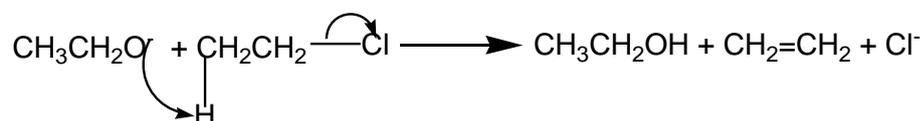

Because the two molecules are involved i.e. $CH_3CH_2O^-$ and CH_3CH_2Cl the reaction is bimolecular and since the alkyl halide loses a mole of HCl the reaction is called elimination. Hence the reaction is a **bimolemmolecular elimination (E_2)**.

In competition between S_N2 and E_2 in primary or secondary alkyl halides, the nature of the product formed depends on the solvent, temperature, and structure of the halide.

Elimination is favoured by use of high temperature and a strong base e.g alcohol instead of water.

For tertiary alkyl halides, elimination occurs by E_1 mechanism. In the mechanism, the tertiary alkyl halide undergoes ionization first and then later loses a proton.

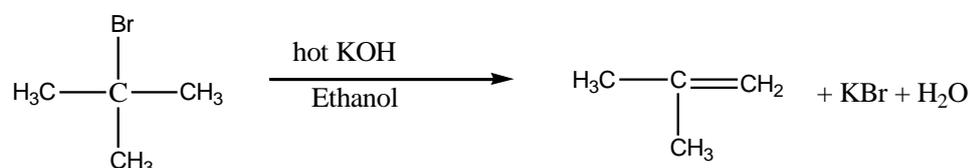

3) Wurtz reaction

Alkyl halides with sodium metal to give alkanes.



4) Reaction of polyhalides

These are compounds in which more than one halogen atom is present. There are two types of poly halides. **Gem dihalides:** This is where two halogen atoms are attached to the same carbon atom.

Example



Vicinal dihalides: Here the two halogen atoms are on adjacent carbon atoms.

Example

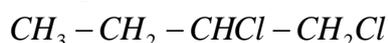

tubes and place them in a hot water bath at about 50°C and leave for a few minutes to equilibrate. Working quickly add about 1 mL of silver nitrate solution to each tube. Start the stopwatch and shake the tubes to ensure complete mixing.

- Record your observation
- Make a comment about comparison of the reactions of the three halogenoalkane

Halogenoalkanes can be identified due to some tests. The following Table illustrate some chemical tests of halogenoalkanes.

Table 4. 2: Chemical test for halogenoalkanes

Test for	Test Method	Observations	Comments and explanations
<p>Halogenoalkanes (haloalkanes), R-X where R = alkyl, X = Cl, Br or I</p> <p>Basic principles underlying the test</p> <p>The halide is covalently bound (C-X bond), so the halogen X cannot react with the silver ion to form the ionic $\text{Ag}^+\text{X}^-_{(s)}$ precipitate until it is converted to the 'free' X⁻ ionic form. Note that aromatic halogen compounds where the halogen (X) is directly attached to the ring, do NOT readily hydrolyse in this way and no</p>	<p>(i) -Put 4 drops of the sample in a test tube. -Add 5 drops of aqueous ethanoic silver nitrate solution (ethanol increases the solubility of haloalkanes). -Warm with water bath Warm a few drops of the haloalkane with aqueous ethanolic silver nitrate solution, the ethanol increases the solubility of the immiscible haloalkanes.</p> <p>(ii) Gently simmering 5 drops with aqueous NaOH (may need to add ethanol to increase solubility and reaction rate). Add dilute nitric acid followed by aqueous silver nitrate solution.</p> <p>(What would happen if the precipitate does</p>	<p>(i) -Observe and note the color of the sample before adding test reagent. -Observe and note what happens when the test reagent is added: *is a precipitate formed? If yes, what is its colour? [and note the colour of the precipitate and the effect of ammonia solution on it.</p>	<p>(i) $\text{AgNO}_3 + \text{RX} \rightarrow \text{R-NO}_3 + \text{AgX}_{(s)}$</p> <p>(ii) Sodium hydroxide converts the halogen atom into the ionic halide ion in a hydrolysis reaction.</p> <p>$\text{RX}_{(aq)} + \text{NaOH}_{(aq)} \rightarrow \text{ROH}_{(aq)} + \text{NaX}_{(aq)}$</p> <p>then $\text{Ag}^+_{(aq)} + \text{X}^-_{(aq)} \rightarrow \text{AgX}_{(s)}$</p> <p>The addition of dilute nitric acid prevents the precipitation of other silver salts or silver oxide (e.g. Ag_2O forms if solution alkaline).</p>

<p>AgX ppt. will be seen. Aromatic C-X is a stronger bond than aliphatic C-X.</p> <p>(Indicate the colour of silver halides: AgCl: white, AgBr: pale cream, AgI: pale yellow</p>	<p>appear immediately?)</p>		
----------------------------------------------------------------------------------------------------------------------------------------------------------------------------------	-----------------------------	--	--

Checking up 4.6

Given two samples A and B. You carry out the test for haloalkanes and get the following results: A form a pale yellow precipitate and B form a white precipitate. Which sample represents $(\text{CH}_3)_2\text{CHCl}$ and which one represents $(\text{CH}_3)_2\text{CHI}$. Write chemical equations to justify your answer.

4.7. Uses of halogenoalkanes and dangers associated with CFCs

Activity 4.7

- 1) Do you know CFCs? If yes what do you know about them?
- 2) Do CFCs affect directly our health in our daily life? If yes explain how.
- 3) What are the dangers posed by CFCs?
- 4) What solutions do you propose or have been proposed to the problem of CFCs

Halogenoalkanes have many uses in our everyday life such as in agriculture, at home, industry as solvents, medicine and in pharmacy.

Solvents:

- CH_2Cl_2 in varnish and paints manufacturing
- CCl_4 is used as the most organic solvent for fats and oils and can be used as fire extinguisher
- CH_3CCl_3 : is used in cleaning of most ink.
- $\text{CHCl}=\text{CCl}_2$: is used in dry cleaning and in caffeine extraction

Medicine:

- CHCl_3 (chloroform): is used in anesthesia

Agriculture:

- DDT: Dichloro diphenyl trichloroethane is used as insecticides DDT, colorless chemical pesticide, dichlorodiphenyltrichloroethane, used to eradicate disease-carrying and crop-eating insects. It was first isolated in Germany in 1874, but not until 1939 did the Swiss Nobel Prize-winning chemist Paul Müller recognize it as a potent nerve poison on insects. The product is banned in Rwanda. Below is the structure of DDT.

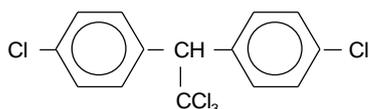

Home: Refrigeration perfumes, etc...

Halogenoalkanes which have boiling temperatures just below room temperature can easily be liquefied by a slight increase in pressure. Halogenoalkanes containing chlorine and fluorine and no hydrogen are Chlorofluorohydrocarbons. Examples are CFCl_3 , CCl_2F_2 and $\text{C}_2\text{Cl}_2\text{F}_4$. They are usually called chlorofluorocarbons or CFCs. In addition to having low boiling temperatures, they are non-flammable, odourless, stable, non-toxic and solvents.

- **CFCs appeared to be ideal for use as fluids in refrigerators and as solvents in aerosol sprays**, they were developed in the 1920s as what appeared to be ideal replacements for liquid ammonia and liquid sulphur dioxide, which were formerly used as fluids in refrigerators and air-conditioning units. Being good solvents, they were also ideal as the solvents in aerosol sprays. Aerosols were used to dispense insecticides, hairsprays, perfumes and deodorants, window-cleaning, polishes, waxes and laundry products. As more and more uses were found for these remarkable compounds, CFCs became big business, with hundreds of thousands of tones being produced yearly. Now they are being phased out. These stable, non-toxic compounds are dangerous!
- **Their high stability has turned out to be a problem**, during all the time that the use of CFCs was increasing, no-one thought about what would happen to the gases in the atmosphere. Because of their lack of reactivity and insolubility in water, there is no natural process for removing CFCs. In fact they drift up into the stratosphere where ultraviolet light causes photolysis, i.e. a reaction cause by light. The chlorine radicals formed in photolysis take part in a chain reaction which converts ozone into oxygen.

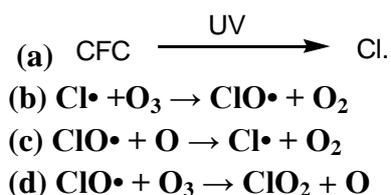

As you can notice, the chain of reaction above results in the decomposition of ozone into ordinary oxygen, which does have the capacity to absorb, and stop dangerous UV from reaching the Earth. This can be avoided if and only if human activities send no CFCs in the atmosphere.

And what can be done?

- **Reduce the thickness of the ozone layer**, reactions (a) to (c) form a chain. This is why one chlorine radical from one CFC molecule can destroy thousands of ozone molecules.
- **Replacements for CFCs have been found**, because of concern over the decrease in the ozone layer, many nations have agreed to cut down the use of CFCs. Alternative compounds are already in production. Hydrohalocarbons contain at least one hydrogen atom per molecule. The C-H bond can be attacked by HO• radicals in the lower atmosphere and the compounds do not reach the upper atmosphere. Hydrohalocarbons include
 - ✓ Hydrochlorofluorocarbons, HCFCs, e.g. CHCl_2CF_3 , used in blowing plastics foam and CHClF_2 , used in air-conditioners
 - ✓ Hydrofluorocarbons, HFCs, e.g. CH_2FCF_3 , used in air-conditioners and refrigerators. HCFs cause no damage to the ozone layer, although they are greenhouse gases.

Checking up 4.7

1. State four industrial uses of the halogenoalkanes. Why do fluoroalkanes find special uses?

4.8. End unit assessment

- Which of the following is NOT a halogenoalkane compound:
 - Tribromobenzene
 - 3-iodohexane
 - 2-chloro-3-methylpentane
 - 2-bromopentane
- Choose from a list of words and fill in the missing words in the text below
Halogenoalkanes, iodine, alkyl halide, haloarene, thyroxine
.....compounds are compounds in which the halogen atoms like chlorine, bromine, or fluorine are attached to a hydrocarbon chain or an aromatic ring. When the halogen atom is attached to a hydrocarbon chain the compound is called an or
- Answer by true or false
 - Chloroform is employed as a solvent as a paint remover.
 - Iodoform was used earlier as an antiseptic.
 - Methyl chloride, methyl bromide, ethyl chloride and some chlorofluoromethanes are gases at room temperature.
 - The objects which are non-superimposable on their mirror image (like a pair of hands) are said to be chiral and this property is known as chirality. While the objects, which are superimposable on their mirror images are called achiral.
 - CHCl_3 (chloroform): is used as insecticide
 - DDT: Dichloro diphenyl trichloroethane is used as anaesthesia
 - Halogenoalkanes therefore, although they dissolve more than alkanes, are only slightly soluble in water.
 - Halogenoalkanes undergo nucleophilic substitution reactions in which the halogen atom is replaced by a nucleophile.
 - Elimination reaction is where a saturated organic compound loses an atom or group of atoms attached to form unsaturated organic compound.
- Name the following halides according to IUPAC system and classify them as primary, secondary or tertiary halogenoalkanes
 - $(\text{CH}_3)_2\text{CHCHClCH}_3$
 - $\text{CH}_3\text{CH}_2\text{C}(\text{CH}_3)_2\text{CH}_2\text{I}$
 - $(\text{CH}_3)_3\text{CCH}_2\text{Br}$
 - $\text{CH}_3\text{CH}(\text{CH}_3)\text{CHBrCH}_3$
 - $\text{CH}_3\text{CH}=\text{CHC}(\text{Br})(\text{CH}_3)_2$
 - $\text{CH}_3\text{CH}=\text{C}(\text{Cl})\text{CH}_2\text{CH}(\text{CH}_3)_2$
- Write the structures of the following organic halogen compounds.
 - 2-chloro-3-methylpentane
 - 2-chloro-2-methylpropane
 - 2,3-dichlorobutane

d) 2-bromo-4-chloropentane

e) 1,1,2-trichloropropane

6. Why do bromoalkanes react more readily than chloroalkanes?

7. Why does 1-bromopropane react with nucleophiles but propane does not?

8. Write the equations for the preparation of 1-iodobutane from (a) 1-butanol, (b) 1-chlorobutane, (c) but-1-ene

9. Write the structure of the major organic product in each of the following reactions:

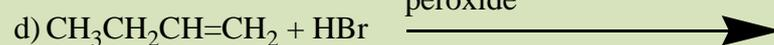
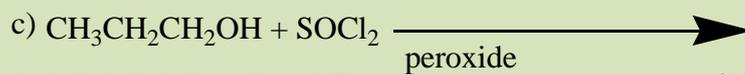
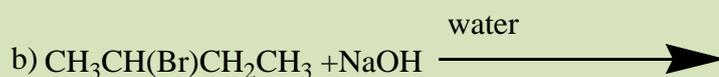
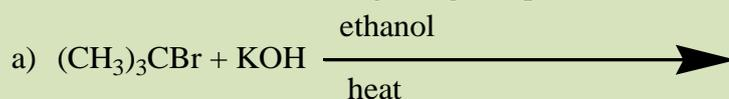

10. Arrange the compound of each set in order of reactivity towards $\text{S}_{\text{N}}2$ displacement:

a) 2-bromo-2-methylbutane, 1-bromopentane, 2-bromopentane

b) 1-bromo-3-methylbutane, 2-bromo-2-methylbutane, 3-bromo-2-methylbutane

c) 1-bromobutane, 1-bromo-2,2-dimethylpropane, 1-bromo-2-methylbutane, 1-bromo-3-methylbutane.

11. a) There are four structural isomers of molecular formula $\text{C}_4\text{H}_9\text{Br}$. The formulae of two of these isomers are given.

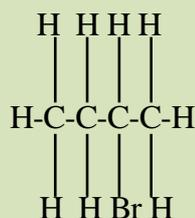

Isomer 1

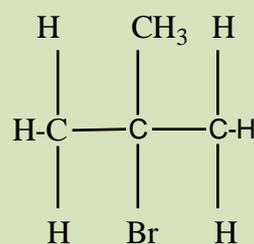

Isomer 2

i. Draw the remaining two structural isomers.

ii. Give the name of isomer 2

b) All four structural isomers of $\text{C}_4\text{H}_9\text{Br}$ undergo similar reactions with ammonia

- i. Give the name of the mechanism involved in these reactions.
- ii. Draw the structural formula of the product formed by the reaction of isomer 2 with ammonia.
- iii. Select the isomer of molecular formula C_4H_9Br that would be most reactive with ammonia. State the structural feature of your chosen isomer that makes it the most reactive of the four isomers.
 - d) The elimination of HBr from Isomer 1 produces two structural isomers, compounds A and B.
 - i. Give the reagents and conditions required for this elimination reaction.
 - ii. Give the structural formulae of the two isomers, A and B formed by elimination of HBr from isomer 1.
 - e) Ethene, C_2H_4 , reacts with bromine to give 1,2-dibromoethane.
 - i. Give the name of the mechanism involved.
 - ii. Show the mechanism for this reaction.

UNIT 5: ALCOHOLS AND ETHERS

Key unit competency:

To be able to compare the physical and chemical properties of alcohols and ethers to their preparation methods, reactivity and uses.

Learning objectives:

- Distinguish between alcohols from other organic compounds by representing the functional group of alcohols
- Classify primary, secondary and tertiary alcohols by carrying out the method of identification
- Write the name of alcohols by using IUPAC system
- Describe the physical properties of alcohols to other series of organic compounds
- Carry out the method of preparation of alcohols
- Describe the local process of making alcohol by fermentation.
- Explain the effect of oxidation on urwagwa when it overstay
- Compare the physical, chemical and the method of preparation of alcohols to ethers
- Compare the use of ethers

Introductory activity

The following represent two images or pictures A and B. Observe each image carefully and answer to the related questions.

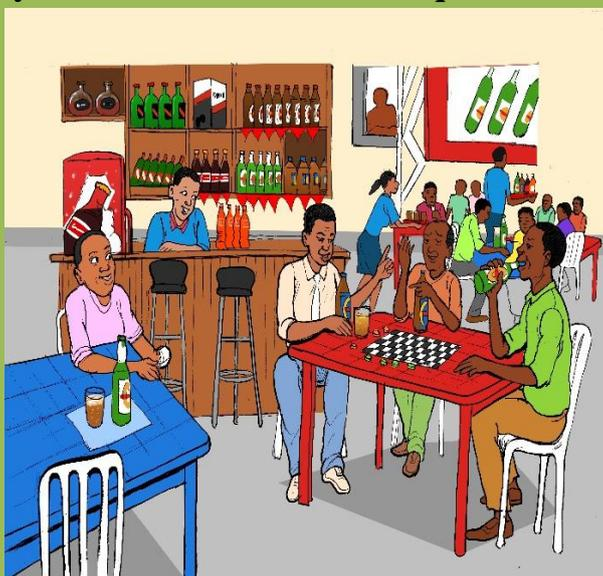

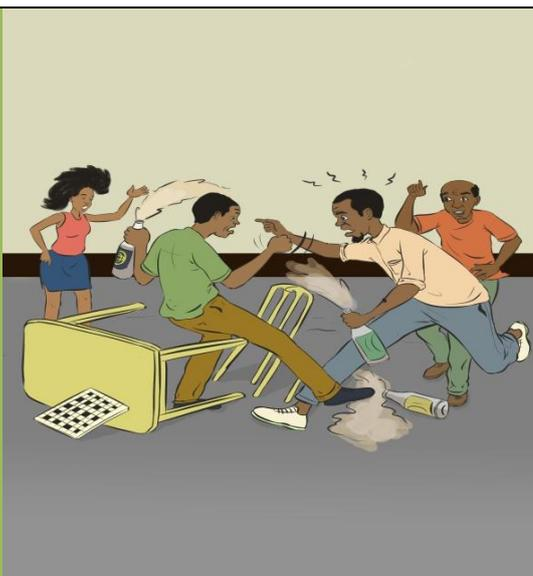

A



B

1. Discuss the meaning of each image.
2. What objects do you observe in the above images?
3. Explain the consequences that can arise from the image B

5.1. Definition and nomenclature

Activity 5.1

1. Look at the following compounds and classify them in their homologous series.
 - a. $\text{CH}_3\text{CH}_2\text{CH}_2\text{CH}_2\text{CH}_3$
 - b. $\text{CH}_3\text{CH}=\text{CHCH}_2\text{CH}_3$
 - c. $\text{CH}_3\text{CHOHCH}_2\text{CH}_3$
 - d. $\text{CH}_3\text{CH}_2\text{-O-CH}_3$
 - e. $\text{CH}_3\text{CH}_2\text{CH}_2\text{CH}_2\text{CH}_2\text{OH}$
 - f. $(\text{CH}_3)_2\text{CHCHOHCH}_3$
2. By doing your own research, distinguish the rules used to name alcohol compounds.

5.1.1. Definition

Alcohols are organic compounds that are derivatives of hydrocarbons where one or more hydrogen atoms of hydrocarbon is or are replaced by hydroxyl (-OH) group. They are represented by the general formula: $C_nH_{2n+1}OH$ or **ROH** where R is a radical: alkyl group made by a chain of carbon atoms.

Alcohols are called monohydric if only one hydroxyl group is present (eg: CH_3CH_2-OH) Dihydric alcohols are those with two hydroxyl group (diol: vicinal and gem), trihydric (triols) and polyhydric are those with many - C-OH groups. The functional group attached is -OH group to any atom of carbon.

5.1.2. Nomenclature

According to IUPAC system, alcohols are named by replacing the final “e” of the parent hydrocarbon with “ol”, then specify the position of -OH group before ending by **ol**.

Examples:

CH_3OH : Methanol

CH_3-CH_2-OH : ethanol

$CH_3-CH_2-CH_2-OH$: Propan-1-ol

$CH_3-CHOH-CH_3$: Propan-2-ol

$CH_3-CH_2-CH_2-CH_2OH$: Butan-1-ol

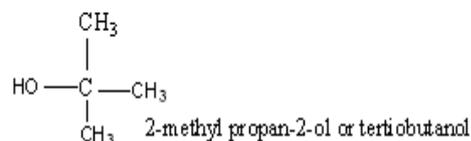
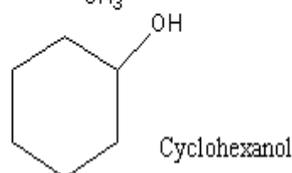
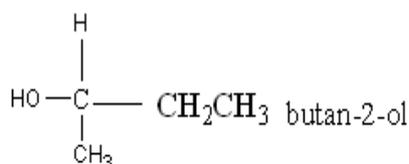

When there are more than one hydroxyl group present, prefixes, **di**, **tri**, **tetra**,... are used.

Examples

HOCH₂-CH₂OH: Ethane-1, 2-diol (ethylene glycol)

HOCH₂-CHOH-CH₂OH: propane-1,2,3-triol (glycerin or glycerol)

Notice: -OH group takes priority over alkyls substituents, double or triple bonds and even halides.

Examples

CH₃-CH=CH-CHOH-CH₂-CHCl-CH₃: 6-Chloro hept-2-en-4-ol

(CH₃)₂CH-CHOH-C≡CH: 4-Methyl pent-1-yn-3-ol

Checking up 5.1

According to IUPAC system, name each of the following compounds:

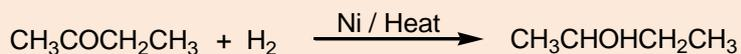

5.2. Classification and isomerism

Activity 5.2

- 1) Write the structural formulas of all organic compounds containing C-OH group and fit the molecular formula $\text{C}_5\text{H}_{12}\text{O}$.
- 2) Based on their structures and your knowledge about classes of halogenoalkanes, classify the compounds identified in 1) above.
- 3) Classify them as chain and position isomers.
- 4) Which of them can exhibit optical isomerism?

Alcohols are classified as:

Primary alcohols: These have only one alkyl group attached to the carbon carrying the -OH.

Examples

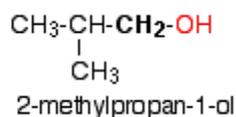
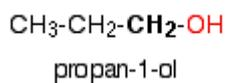
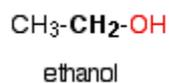

Secondary alcohols: they are alcohols in which the OH group is attached to carbon atom bonded to two other carbon atoms.

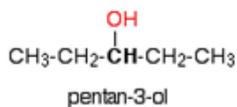
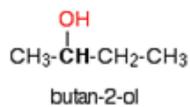
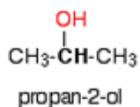

Tertiary alcohols: they are alcohols in which the OH group is attached to carbon atom bonded to three other carbon atoms.

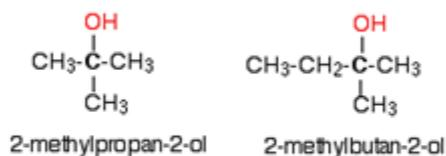

Alcohols containing at least three carbon atoms exhibit different types of isomerism:

- **Chain isomerism:**

This is due to the difference in the size of the chain.

Example:

Butan-1-ol and 2-methyl propan-1-ol

- **Position isomerism:**

This is due to different positions taken by the –OH in the same carbon chain.

Examples

$\text{C}_3\text{H}_8\text{O}$: there exist propan-1-ol and propan-2-ol

$\text{C}_4\text{H}_{10}\text{O}$ has 2 pairs of position isomers such as butan-1-ol, butan-2-ol and 2-methyl propan-1-ol, 2-methyl propan-2-ol.

- **Functional isomers:** Except methanol which has one carbon, other alcohols are isomers with ethers another chemical function of general formula $\text{R-O-R}'$ where R and R' are alkyl groups or aryl groups but not hydrogen.

E.g: $\text{C}_2\text{H}_6\text{O}$ has 2 functional isomers:

$\text{CH}_3\text{-CH}_2\text{-OH}$ (alcohol: ethanol) and $\text{CH}_3\text{-O-CH}_3$ (ether: methoxymethane or dimethyl ether).

$\text{C}_3\text{H}_8\text{O}$ represents $\text{CH}_3\text{CH}_2\text{CH}_2\text{OH}$ or $\text{CH}_3\text{-CHOH-CH}_3$ (both alcohols) and one ether:

$\text{CH}_3\text{-CH}_2\text{-O-CH}_3$ (methoxyethane).

5.3. Physical properties

Activity 5.3.

Analyze the following data and answer to the question

Name	Boiling Point/K	Name	Boiling point/K
------	-----------------	------	-----------------

Methanol	337	Methane	111.3
Ethanol	351	Ethane	184.4
Propan-1-ol	371	Propane	231
Butan-1-ol	396	Butane	272.5

Explain the trends in the boiling point of the molecules given in the table

Compare and explain the differences in the boiling point of alkanes and alcohols.

a) Boiling points

The chart shows the boiling points of some simple primary alcohols and alkanes with up to 4 carbon atoms.

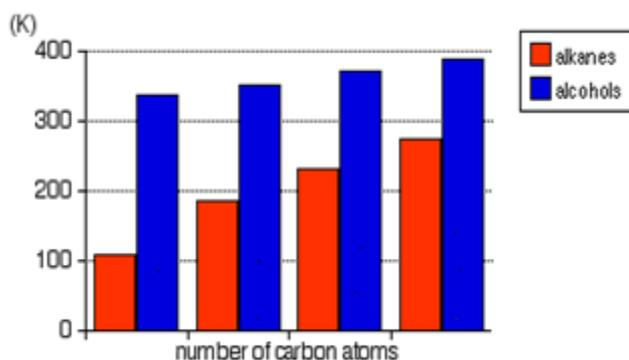
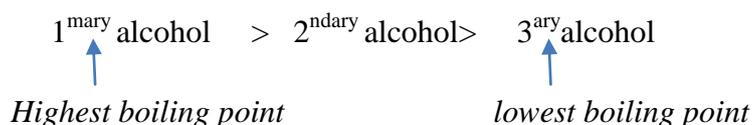
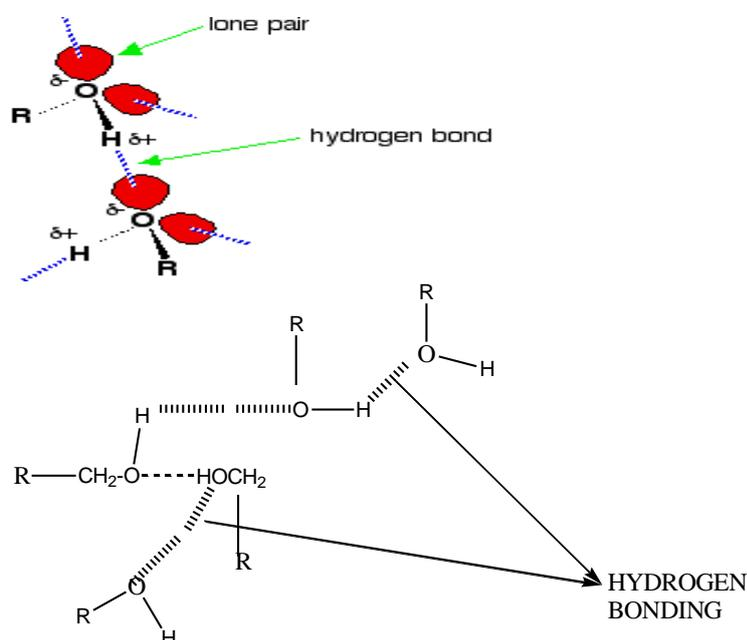

Figure 5.1: boiling points of alcohols and alkanes

- The boiling point of an alcohol is always much higher than that of the alkane with the same number of carbon atoms.
- The boiling points of the alcohols increase as the number of carbon atoms increases.
- The boiling point of alcohols with branches is lower than that of unbranched alcohols with the same number of carbon atoms. This is because increased branching gives molecules a nearly spherical shape and the surface area of contact between molecules in the liquid. This results in weakened intermolecular forces and therefore in lower boiling points.
- Tertiary alcohols exhibit the lowest boiling point than secondary and primary alcohols:



The patterns in boiling point reflect the patterns in intermolecular attractions: In the case of alcohols, there are hydrogen bonds set up between the slightly positive hydrogen atoms and lone pairs on oxygen in other molecules.



b) Solubility of alcohols in water

The lower members of alcohols are completely soluble in water because mixed hydrogen bonds between water and alcohol molecules are formed.

As the length of hydrocarbon group of the alcohol increases, the solubility decreases.

c) Volatility

Alcohols are volatile and the volatility decreases as the molecular mass increases. Compared to alkyl halides, alcohols are less volatile. Polyalcohols are viscous or solids. Example: propane-1, 2, 3-triol (glycerine). This is due to stronger intermolecular forces than those of monoalcohols.

Checking up 5.3

1. Comment on the solubility of alcohols compared to alkanes in water.
2. Ethanol with a molecular mass of 46 and butane with a molecular mass of 58 have the boiling point of 78 °C and -0.5 °C, respectively. Explain these differences.
3. Are alcohols electric conductors? Justify your answer.

5.4. Alcohol preparations

Activity 5.4

Complete the following chemical equations. For each, show the mechanism of the

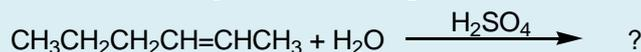

Alcohols are prepared with different methods

a) From alkyl halides

Alkyl halides when refluxed with aqueous alkali (NaOH or KOH) or moist silver oxide (AgOH) produce alcohols. The hydrolysis occurs by a nucleophile substitution reaction.

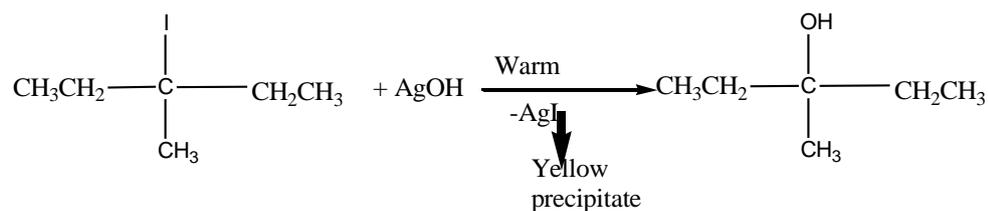
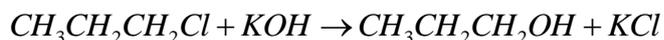
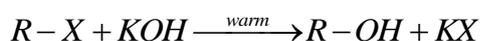

Note: During the reaction of these preparations of alcohols, you have to use the dilute NaOH, KOH and warm in order to increase the rate of SN_2 for primary alcohol while tertiary alcohols undergo SN_1

b) From alkenes

Alkenes react with water in the presence concentrated sulphuric acid to yields alcohols

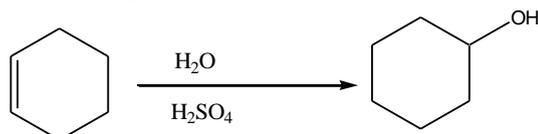
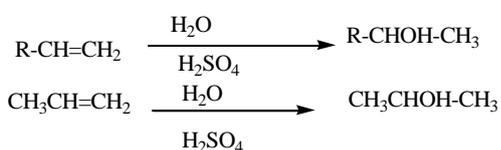

Notice: Alkenes in the presence of Aluminium oxide reacts with water to form alcohols in vapour phase then condense to give liquid alcohols.

Example

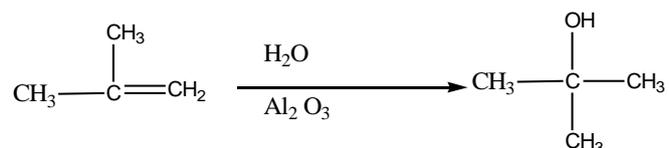

c) From carbonyl compounds

When aldehydes and ketones are reduced by hydrogen in the presence of a suitable catalyst like Pt, Ni or Pd, they form primary and secondary alcohols respectively.

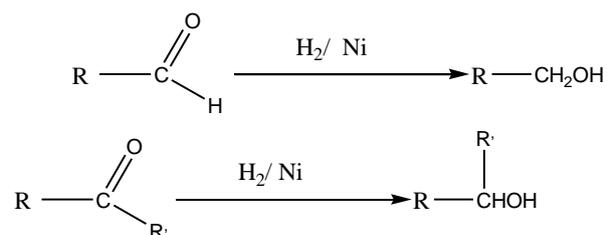

Examples

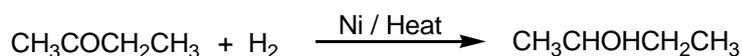
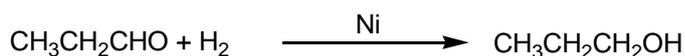

Note:

Lithium tetrahydridoaluminate (LiAlH_4) can also be used as a reducing agent.

Examples

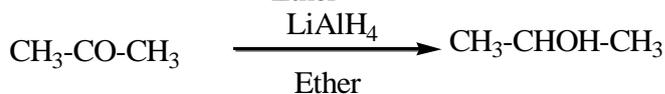
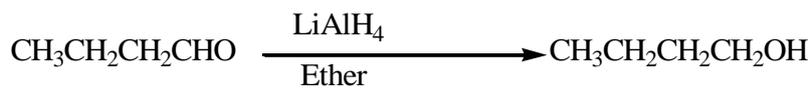

Lithium tetrahydridoaluminate is not a strong enough reducing agent to reduce a double bond unlike H_2 which can reduce both the double bond and the carbonyl group.

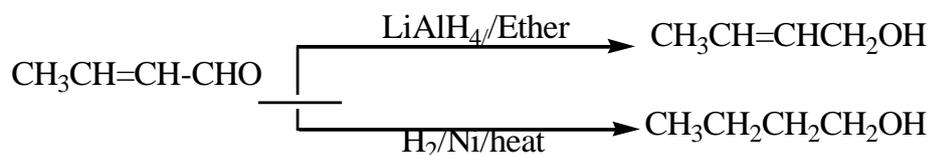
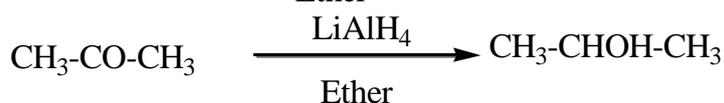
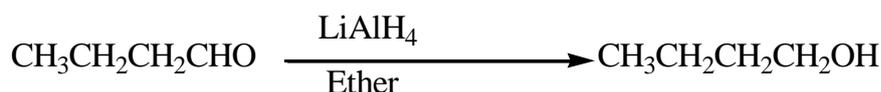

d) From esters

Esters on hydrolysis in the presence of mineral acid or alkalis produce alcohols and carboxylic acids.

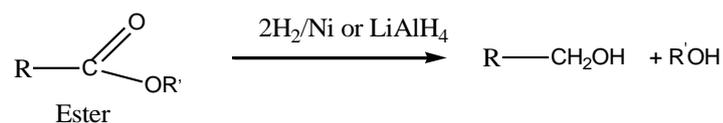
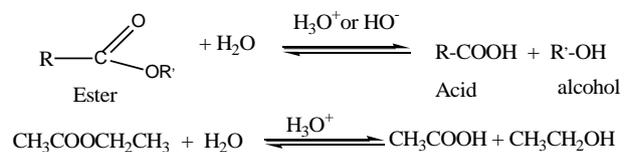

Note: In spite of LiAlH_4 we can also use NaBH_4 , KBH_4 by H^- attack specifically on $\text{C}=\text{O}$ group followed by hydrolysis.

e) From Grignard reagents

The reaction between carbonyl compound and Grignard reagent (alkyl magnesium halides) produces an alcohol with more carbon atoms. The reaction is a nucleophilic addition on a carbonyl compound.

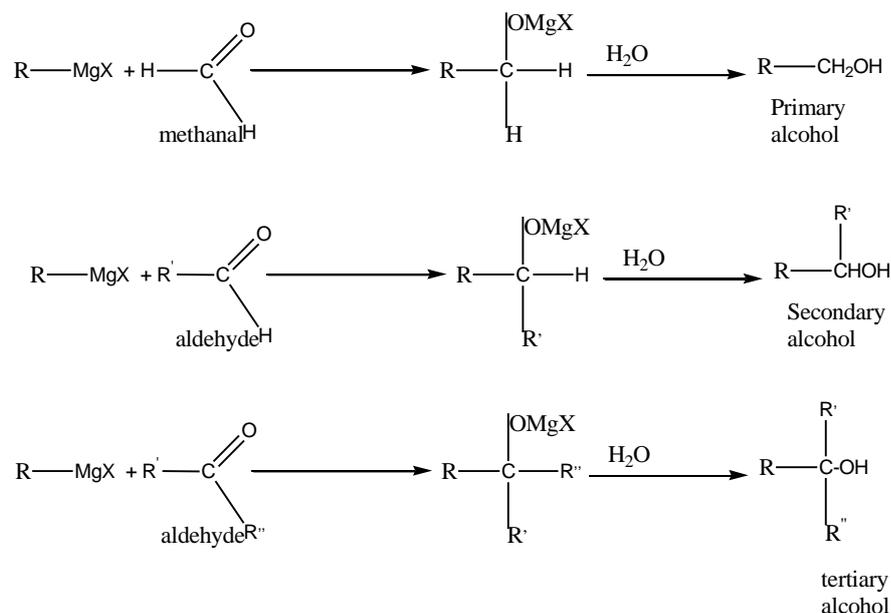

Examples

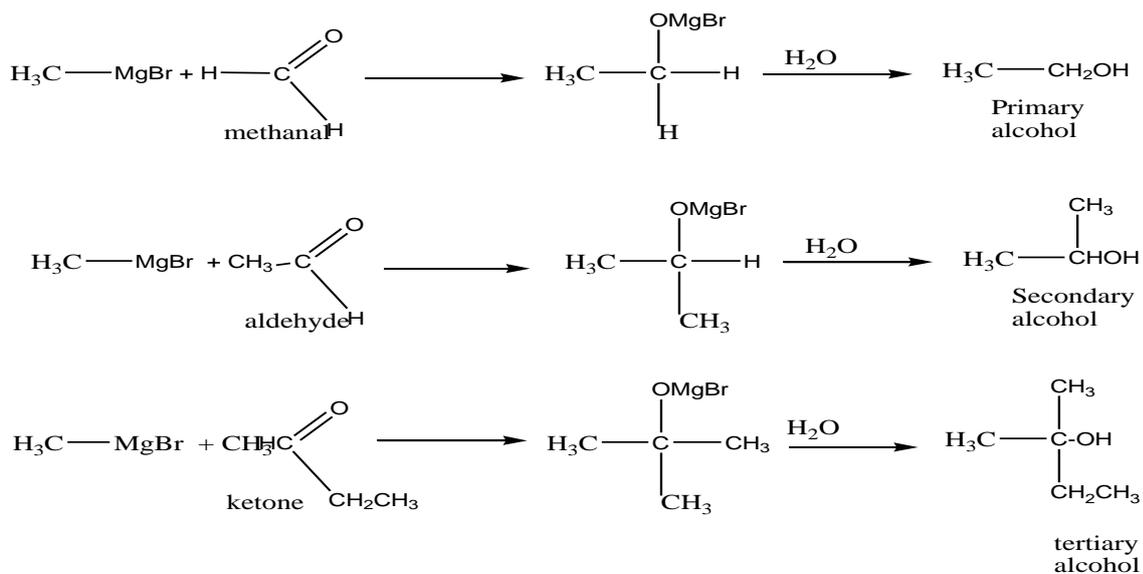

f) From primary amine to give primary alcohol

Primary amines react with nitrous acid to produce primary alcohols.



Example



Checking up 5.4

- 1) Using chemical equations, explain how 3-methylbutan-2-ol could be prepared:
 - a) from an alkene
 - b) using a Grignard reagent
 - c) from a halogenoalkanes
 - d) from an amine
 - e) by reduction of a carbonyl compound

5.5. Preparation of ethanol by fermentation

Activity 5.5

Process of alcoholic fermentation



- 1) Observe the above images and then interpret each image.
- 2) Describe the process followed to produce alcohol refer to the above images.
 - a) What are the raw materials used in the process?
 - b) What is the main component of the final products?
 - c) Give the name of the process illustrated by the picture.
 - d) Propose another process that can be used to yield the product in b.

This method is mainly used to prepare ethanol industrially. Ethanol is prepared from starch

(e.g. maize, cassava, millet, sorghum) and sugar (e.g. banana juice, molasses) by fermentation process.

Fermentation can be defined as any of many anaerobic biochemical reactions in which enzymes produced by microorganisms catalyse the conversion of one substance into another.

Alcoholic fermentation is the process in which enzymes act on carbohydrates to give simpler compounds like ethanol (alcohol) and carbon dioxide (CO₂).

a) From starch: malt obtained either from maize grain, millet, or cassava contains an enzyme called diastase which catalyzes the hydrolysis of starch to maltose.

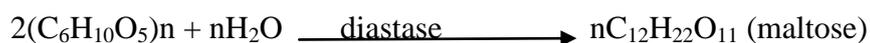

At room temperature, yeast is added and one of its enzymes called maltase catalyzes the hydrolysis of maltose to simple sugar so called glucose.

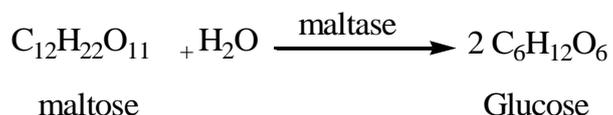

Finally another enzyme of yeast called zymase catalyzes the decomposition of glucose to ethanol.

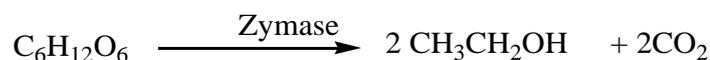

b) From sugar

Molasses containing sugars are mixed with water and yeast and then allowed to ferment for several days after which ethanol are obtained during fermentation process.

One enzyme of the yeast called sucrase catalyzes the hydrolysis of sucrose present in the molasses to glucose and fructose.

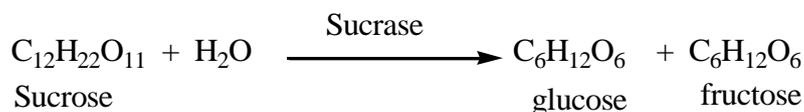

Thus, another enzyme of yeast called zymase catalyzes the decomposition of glucose to ethanol.

$$\text{C}_6\text{H}_{12}\text{O}_6 \xrightarrow{\text{Zymase}} 2 \text{CH}_3\text{CH}_2\text{OH} + 2\text{CO}_2$$

The ethanol obtained by fermentation process is only about 11%. This is made concentrated by distillation which converts it to about 95% ethanol.

This on further distillation yields a constant boiling mixture whose composition does not change (an azeotropic mixture). Therefore, 100% ethanol is obtained by either:

- (i) Adding quick lime which removes water

(ii) Distilling with of benzene as a third component

Note: Methanol can be prepared industrially by the reaction of carbon monoxide and hydrogen at 300 °C and a pressure of 200 atmospheres.

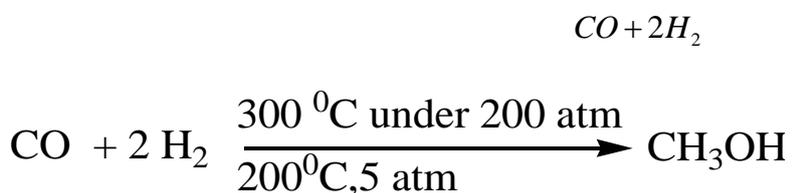

Checking up 5.5

- 1) Briefly, describe the preparation of ethanol by alcoholic fermentation.
- 2) Compare and contrast the preparation of ethanol by hydration of ethene and by alcoholic fermentation.

Project work 5.1

The task is about the fermentation of glucose

Part A

In this project, you will investigate the fermentation of different types of substances containing starch.

Requirements

- Conical flask,
- some yeast,
- some boiled potatoes,
- some bread,
- some boiled cassava,
- boiling tube,
- cork with delivery tubes,
- stands and cramps,
- glucose,
- weighing balance

Why boiled potatoes or cassava is preferred?

Procedure

Weigh 25g of each starch including glucose and place them in separate conical flasks. Add to each one spatula of dried yeast followed by 100 cm³ of water.

Cork the conical flask and connect it to boiling tube containing lime water as shown in the figure below. Label each flask clearly. Leave all the flasks in a warm environment. Record your observation for seven days.

- The conical flask
- The boiling tube

For each type of starch

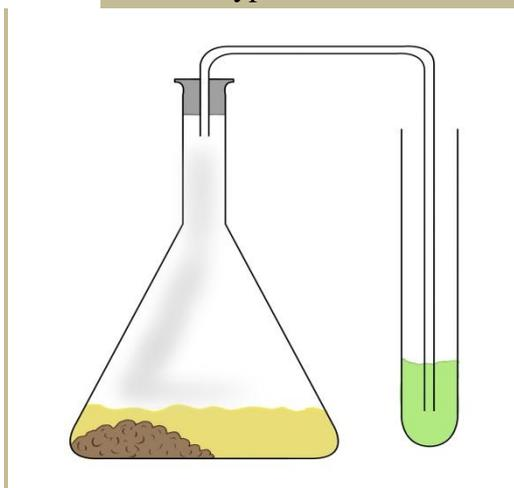

Fermentation of glucose

Note: use the same quantity and concentration of lime water in each boiling tube.

Part B: Comparison of yield of alcohol obtained

Filter the mixture from each flask separately and collect the filtrate in measuring cylinder. Record the volume in each case.

Perform fractional distillation on each filtrate, collecting the fraction between 72°C- 78°C. Record the volume of distillate collected from each starch. Take 5cm³ of each on watch glass, ignite and note the time it takes to burn completely. Observe the amount of water left on watch glass.

5.6. Chemical properties of alcohols

Activity 5.6.1.

To investigate the oxidation reaction of an alcohol.

Requirements: methanol, ethanol, 2M sulphuric acid, potassium dichromate solution, test tubes, burner, droppers, propan-2-ol and 2-methylpropan-2-ol.

Procedure:

- Place 5 drops of methanol in test tube
- Add 10 drops of dilute sulphuric acid followed by 5 drops of potassium dichromate solution.
- Warm the mixture gently
- Repeat the experiment with ethanol, propan-2-ol and 2-methylpropan-2-ol.

- 1) What happens to the colour of the solution?
- 2) Explain the observation.
- 3) Write an equation for the reaction taking place.

5.6.1. Oxidation

Primary and secondary alcohols are oxidized to aldehydes and ketones respectively by use of acidified $K_2Cr_2O_7$, CrO_3 , acidified $KMnO_4$, nitric acid once concentrated.

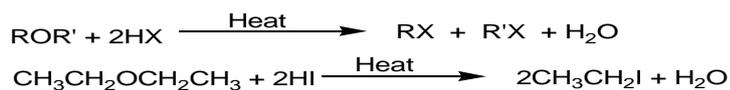

examples :

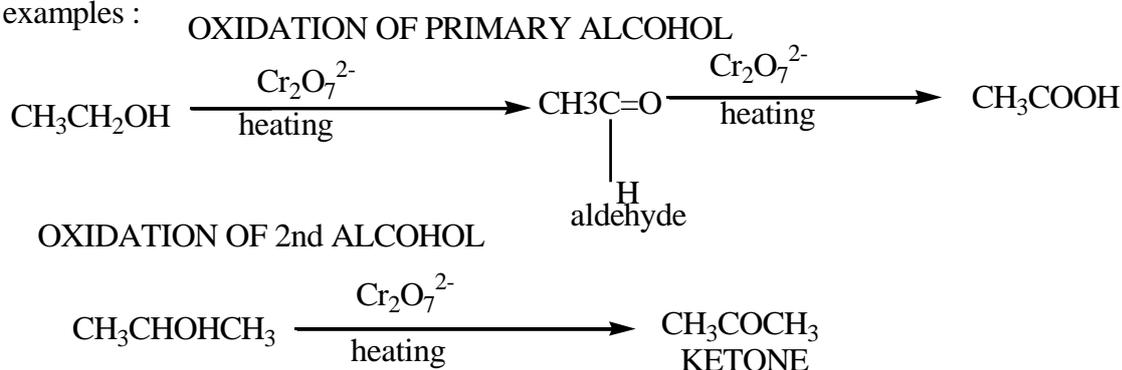

Aldehydes formed by oxidation of primary alcohols tend to undergo further oxidation to carboxylic acid.

Ketones formed by oxidation of secondary alcohols are not further oxidised, unless if the oxidising agent is hot and concentrated in which case bonds around the $-CO-$ group are broken and two smaller carboxylic acids are formed.

Example



Tertiary alcohols resist oxidation because they have no hydrogen atom attached on the functional carbon atom.

Oxidation also occurs when the alcohol is in gaseous phase by used of silver or copper catalyst under $500^\circ C$ and $300^\circ C$ respectively; and the vapour of the alcohol is passed with air (oxygen) over heated silver.

Examples

These reactions help to distinguish between primary, secondary and tertiary alcohols because primary and secondary alcohols decolourise the purple solution of $KMnO_4$.

An acidified potassium dichromate solution is turned from orange to green when it reacts with primary and secondary alcohols.

Secondary alcohols having the following structure $R-CHOH-CH_3$ only undergo oxidation, on treatment with iodine solution in the presence of sodium hydroxide to give yellow precipitate of tri-iodomethane.

Note: This is a reaction which is characteristic of methyl ketones, CH_3-CO-R' ; but iodine here acting as an oxidizing agent first oxidizes the $CH_3-CHOH-R'$ to CH_3-CO-R' ; then the methyl ketone formed then gives the yellow precipitate of CHI_3 (*Iodoform*). From the reaction involved we have the Iodoform test.

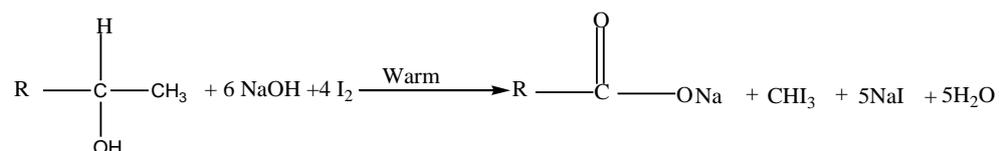

Example

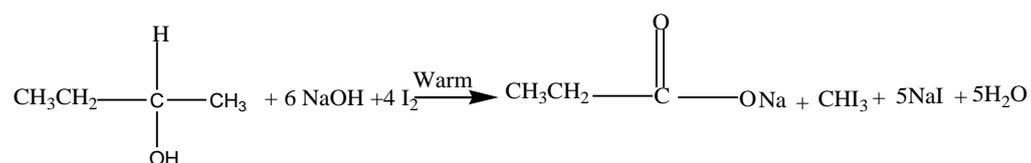

5.6.2. Reaction with sulphuric acid

Activity 5.6.2

Show the product of the reaction referring to the preparation of alkenes and show the mechanism of reaction.

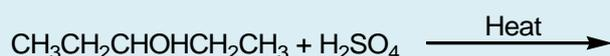

Alcohols react with concentrated acid to give products depending on the nature of the alcohol and conditions of reactions.

- a) At about 0 °C alcohols react with sulphuric acid to produce alkyl hydrogen sulphates.

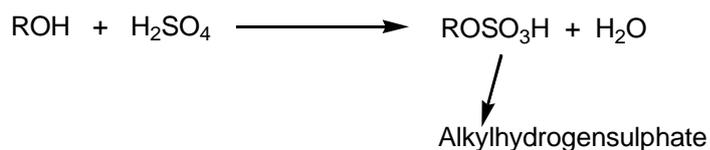

This reaction is a substitution reaction where the OH group has been replaced by HSO_4^-

- c) At about 140°C in the presence of excess primary alcohol and concentrated sulphuric acid, ether is formed.

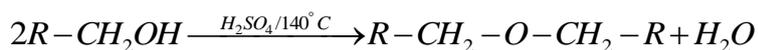

Example

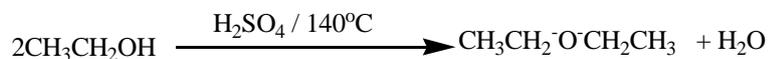

Mechanism

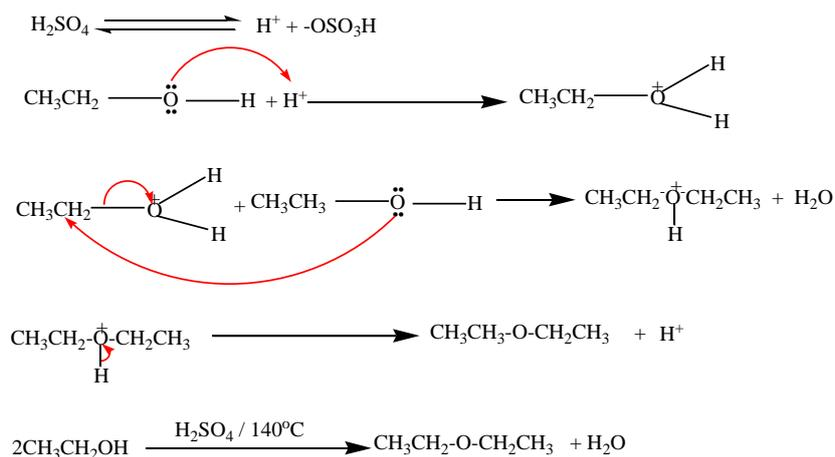

This reaction is an intermolecular dehydration.

d) Elimination reaction

Alcohols are dehydrated by heating with concentrated sulphuric acid or phosphoric acid to alkenes. The ease of dehydration is in the order tertiary > secondary > primary, this reaction is the intramolecular dehydration of water.

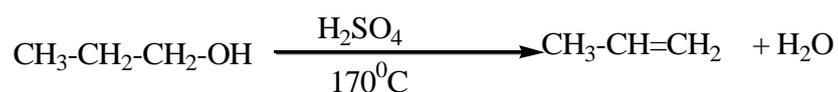

Notice: For primary alcohols any temperatures between 170°C-180°C is sufficient and the acid should be sufficiently concentrated.

Example

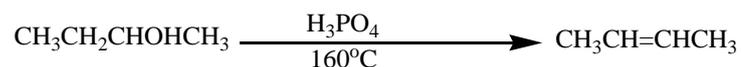

This dehydration respects Zaitsev's elimination law (see alkenes) reason why the hydration of butan-1-ol and butan-2-ol gives the same products which is but-2-ene via E₁ catalyzed by concentrated H₂SO₄.

Elimination always competes with nucleophilic substitution reaction. Substitution leading to formation of ether is favoured by use of excess primary alcohols while higher temperatures favour elimination. Therefore, dehydration of ethanol may produce

both alkenes by elimination and diethylether by substitution reaction. The relative proportion of two products depends on the condition of the reaction.

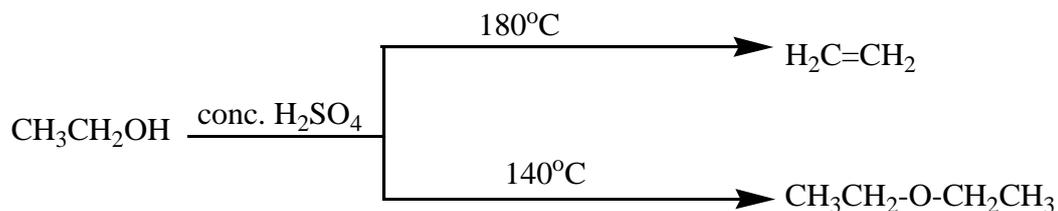

Dehydration of alcohols also occurs when the vapours of the alcohols are passed over heat aluminium oxide at about 300°C .

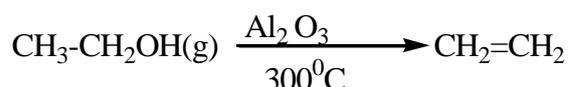

5.6.3. Esterification

Alcohols react with organic acids in the presence of mineral acids (such as sulphuric acid (catalyst) with elimination of water under 100°C to produce an ester with given off a perfume smell.

This reaction is called “**esterification**”.

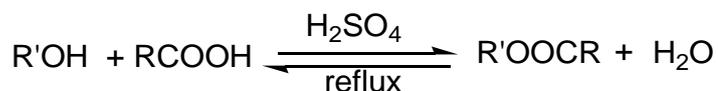

Example:



The mechanism

Step 1

In the first step, the ethanoic acid takes a proton (a hydrogen ion) from the concentrated sulphuric acid. The proton becomes attached to one of the lone pairs on the oxygen which is double-bonded to the carbon.

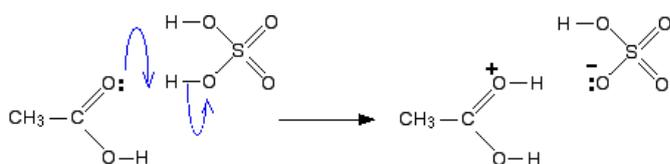

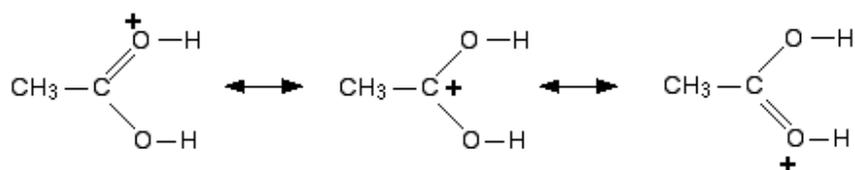

Step 2

The positive charge on the carbon atom is attacked by one of the lone pairs on the oxygen of the ethanol molecule.

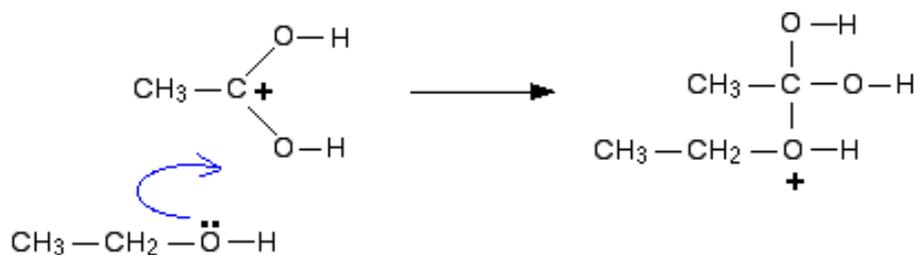

Step 3

What happens next is that a proton (a hydrogen ion) gets transferred from the bottom oxygen atom to one of the others. It gets picked off by one of the other substances in the mixture (for example, by attaching to a lone pair on an unreacted ethanol molecule), and then dumped back onto one of the oxygens more or less at random.

The net effect is:

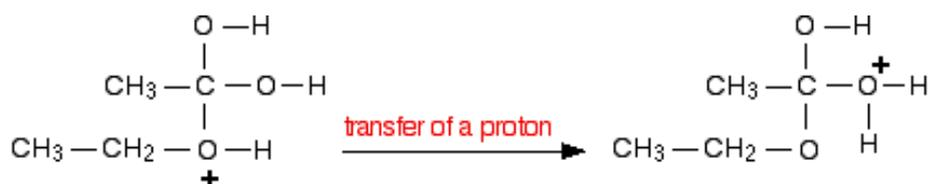

Step 4

Now a molecule of water is lost from the ion.

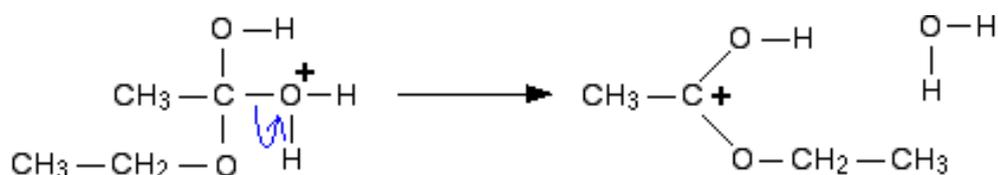

The product ion has been drawn in a shape to reflect the product which we are finally getting quite close to!

The structure for the latest ion is just like the one we discussed at length back in step 1. The positive charge is actually delocalised all over that end of the ion, and there will also be contributions from structures where the charge is on the either of the oxygen atoms:

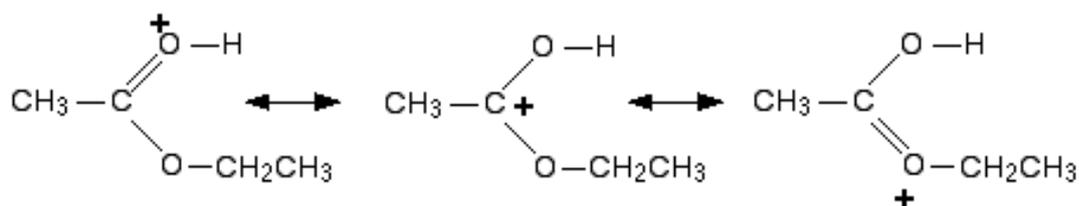

Step 5

The hydrogen is removed from the oxygen by reaction with the hydrogensulphate ion which was formed way back in the first step.

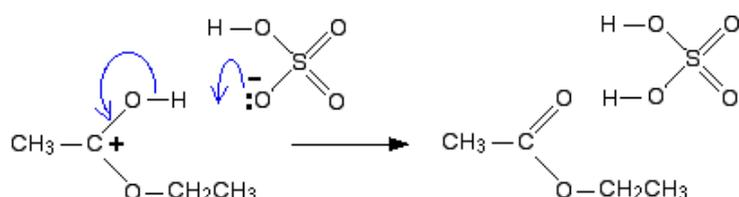

Source: <https://w.w.w.chemguide.co.uk>

5.6.4. Reaction with strong electropositive metals and metal hydroxides

Electropositive metals like Na, K, reacts with alcohols forming alkoxide with evolution of hydrogen gas.

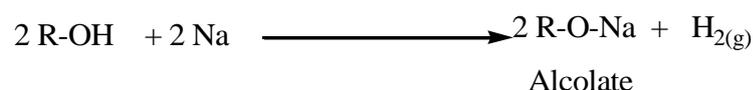

Example

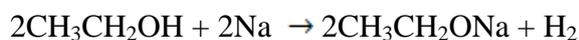

Note: Alcohols are not enough acidic to react with metal hydroxides such as sodium hydroxide or potassium hydroxide.



5.6.5 Action of hydrohalic acids (HX)

Activity 5.6.5

Referring to preparation of alkyl halides, complete the following reactions:



Alcohols react with hydrohalic acids to give alkyl halides.

Examples

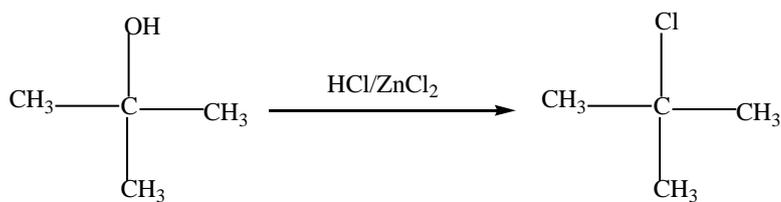
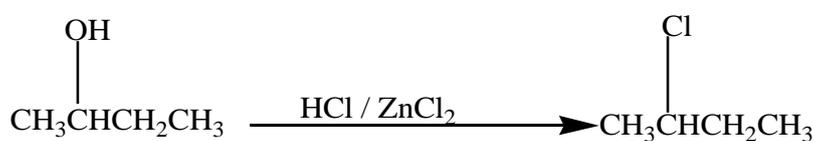
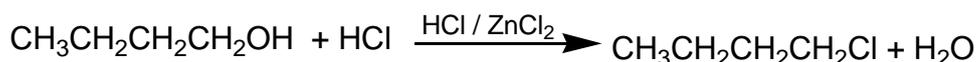
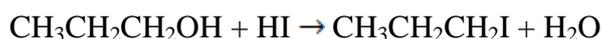
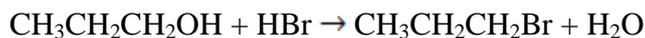

Notice: (i) Reaction with concentrated hydrochloric acid is catalyzed by anhydrous zinc chloride.

- (i) This reaction is called **LUCAS** test and is used to distinguish between simple primary, secondary or tertiary alcohols. In this reaction, the alcohol is shaken with a solution of zinc chloride in concentrated hydrochloric acid.

Observations: Immediate cloudiness indicates presence of a tertiary alcohol. If the solution becomes cloudy within 5 minutes then the alcohol is a secondary one. Primary alcohol would show no cloudiness at room temperature since the reaction is very slow.

For example all alcohols which are isomers of $\text{C}_4\text{H}_{10}\text{O}$ can be distinguished by the **LUCAS** test.

Alcohols are also transformed into halogenoalkanes using phosphorus halides and thionyl chloride

Examples

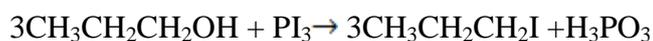
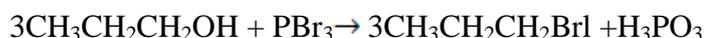
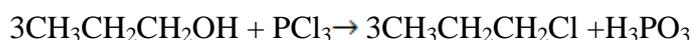

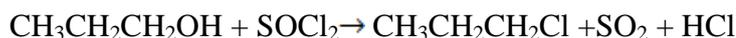

Checking up 5.6

- An organic compound A possesses 87.6 % composition by mass and the rest is hydrogen. If the same molecule possesses the molecular mass of 56 g/mol, deduce the molecular formula of A.
 - The reaction of A with water produces the compound B. B can be represented in different forms called isomers. Represent the isomers of B. When B reacts with KMnO_4 , it produces different compounds depending on the reaction conditions. Write the structural formulae of those compounds and state the conditions of their formation.
 - When B reacts with H_2SO_4 , three products are obtained depending on the temperature used. Write structural formulae of those products.
- Explain why tertiary alcohols are not oxidized.
- Complete the following chemical reactions and name the products obtained:
 - Propan-2-ol + Na \rightarrow
 - Propan-2-ol + HBr \rightarrow
 - methanol + $\text{CH}_3\text{CH}_2\text{-COOH}$ \rightarrow
 - butan-1-ol + PCl_5 \rightarrow
 - butan-2-ol + SOCl_2 \rightarrow
 - 2-methylpentan-3-ol + PBr_3 \rightarrow

5.7. Uses of alcohols

Activity 5.7

In Rwanda, different types of alcoholic drinks are produced. However, some of the them produced locally including “Kanyanga” are prohibited.

- Explain why this alcohols is prohibited?
- Discuss the possible effects of using non certified alcoholic drinks.
- How would you differentiate alcoholic products from non-alcoholic ones?

Ethanol is the alcohol found in alcoholic drinks. Alcoholic fermentation converts starch sugar into ethanol. For example grapes are used to produce wine, ripe banana to produce *urwagwa*, honey for spirits are obtained by distilling the ethanol –water product obtained when sugar is fermented.

Drinking alcohol, i.e. the ethylic alcohol also called ethanol, is a normal social activity; but excess of it is dangerous for our health. Hence excess of alcoholic consumption must be avoided.

For non-adult youth, consumption of alcohol in any form is illegal in Rwanda and many other countries.

There are some alcoholic drinks produced in Rwanda and in the Region that are prohibited to be sold in Rwanda. However, alcohols have many other applications in daily life as indicated in the Table 5.1.

Table 5.1. Application of some alcohols

Kind	Manufacture	Uses
Methanol	<ul style="list-style-type: none"> - By destructive distillation of wood. - By synthesis from hydrogen and carbon monoxide under high pressure. 	Solvent for fats, oils, resins, nitrocellulose. Manufacture of dyes, formaldehyde, antifreeze solutions, special fuels, plastics.
Ethanol	<ul style="list-style-type: none"> - By fermentation of sugar, starch, or waste sulphite liquor. - Synthesis from ethylene or acetylene. Direct hydration of ethylene. 	Solvent for products such as lacquers, paints, varnishes, glues, pharmaceuticals, explosives; vinegar preparation, perfume synthesis; source of energy as well as biofuels or gasohol; alcoholic drink(as wine, beer). Also as 'building block' in making high-molecular-weight chemicals.
Propan-2-ol	<ul style="list-style-type: none"> - By hydration of propylene from cracked gases. - By-product of certain fermentation processes. 	Solvent for oils, gums, alkaloids, resins. Making acetone, soap, antiseptic solutions.
Propan-1-ol	<ul style="list-style-type: none"> - As a coproduct of air oxidation of propane and butane mixtures. 	Solvent for lacquers, resins, coatings, films, waxes. Also as brake fluid, in manufacture of propanoic acid, plasticizers.

Butan-1-ol	- By fermentation of starch or sugar. - By synthesis, using ethyl alcohol or acetylene.	Solvent for nitrocellulose, ethyl cellulose, lacquer, urea-formaldehyde, urea-melamine plastics. Diluent of hydraulic fluids, extracting of drugs.
Methylpropan-1-ol	- By synthesis from carbon monoxide and hydrogen at high pressure, then distillation from products formed.	Solvent for castor-oil-base brake fluids. Substitute for n-butyl alcohol in making urea resins.
Butan-2-ol	- By hydration of 1-but-1-ene, formed in petroleum cracking.	In making other chemicals such as butanone. Solvent in nitrocellulose lacquers. Production of brake fluids, special greases.
Methylpropan-2-ol	- By hydration of methylprop-1-ene, derived from petroleum cracking.	In perfume making. As wetting agent in detergents. Solvent for drugs and cleaning compounds.
Propane-1,2,3-triol	From treatment of fats in soap making. Synthetically from propene.	In explosives, cellophane. Tobacco humectant.
Cyclohexanol	By catalytic hydrogenation of phenol. By catalytic air oxidation of cyclohexane.	Intermediate in making chemicals used in nylon manufacture. Stabilizer and homogenizer of soaps, synthetic detergents. Solvent.

Ethanol produced by sugar cane fermentation has been used as alternative fuel to gasoline (petrol). It has been mixed with gasoline to produce gasohol.

Project 5.2. USE OF ALCOHOLS

Consult leader to your community religious, political, professionals, e.g. doctors, nurses, parents, teachers, and elders and find out from them the following:

- What are the true recommended users of alcohols
- How should alcohol be used
- Real life examples of the effect of alcohol abuse on:
 - i) Social life
 - ii) Spiritual life

iii) Physical life of an individual

- a) Come up with your own resolution and statements concerning alcohol abuse. Write it out on a card and share it with trusted friends and your parents/guardian and mentor.
- b) Discuss with your peers show how you would help one of your members of your family who is addicted to alcohol to come out of it
- c) Find out the good economic uses of alcohol.

5.8. Ethers

5.8.1 Structure and isomerism

Activity 5.8.1.

- 1) Represent the possible isomers of $C_4H_{10}O$. Which of them are:
 - a) Structural isomers?
 - b) Functional isomers
- 2) What homologous series do those isomers belong to?

Ethers are organic compounds in which two carbon groups are connected to a single oxygen. The general formula of ether is $R-O-R'$. Based on the general structure of ether, they are classified as symmetrical, unsymmetrical and epoxide.

- For symmetrical ethers, R and R' are identical.

Examples:

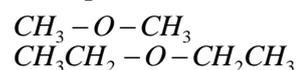

- For unsymmetrical esters, R and R' are different ($R \neq R'$);

Examples:

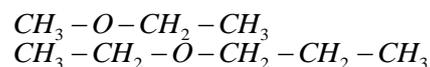

- Epoxides are cyclic ethers; a ring that contains elements other than carbon is called a heterocyclic ring.)

Example:

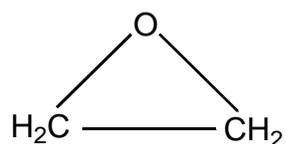

Checking up 5.8.

Classify the isomers of the molecules identified in activity 7.8.1 above into symmetric, asymmetric and cyclic.

5.8.2. Physical properties

- 1) Ethers are sparingly soluble in water but are soluble in organic solvents.
- 2) The polar nature of the C-O bond (due to the electronegativity difference of the atoms) results in intermolecular dipole-dipole interactions.
- 3) An ether cannot form hydrogen bonds with other ether molecules since there is no H to be donated (no -OH group).
- 4) Their melting and boiling points increase with the increase in molecular mass because of increasing the magnitude of Van der Waal's forces with size.
- 5) The boiling points of ethers are much lower than those of alcohols of similar molecular mass. This is because of the intermolecular hydrogen bonding which are present in alcohols but are not possible in ethers.

Molecule	Molecular mass	Boiling points °C
$CH_3 - O - CH_3$	46	-24.9
$CH_3 - CH_2 - OH$	46	78
$CH_3 - CH_2 - O - CH_2 - CH_3$	74	35
$CH_3 - CH_2 - CH_2 - CH_2OH$	74	117.7

5.8.3 Preparation of ethers

Activity 5.8.2

- 1) With reference to alcohols, define intermolecular dehydration reaction.
- 2) State the reagent and conditions used in that reaction and give one example.

1) Intermolecular dehydration of alcohols

This is done by heating excess primary alcohol with concentrated sulphuric acid or phosphoric acid at about 140°C.

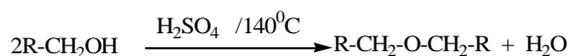

Example:

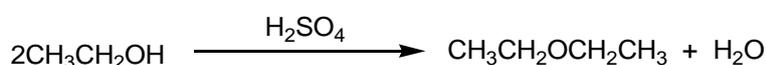

2) From halogenoalkanes

(a) In this method halogenoalkanes are heated together with sodium or potassium alkoxides.

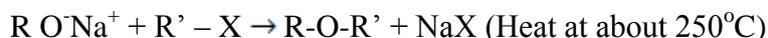
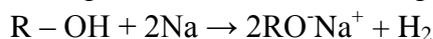

This is the Williamson's synthesis

(b) In the second method, the halogenoalkane is heated with dry silver oxide.

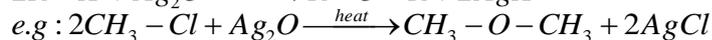

5.9. Chemical properties of ethers

Activity 5.9

A compound with molecular formula C_3H_8O has three isomers. One of them does not react with sodium metal. Identify that isomer.

Since they are saturated compounds and non-polar, they are relatively chemically inert reason why their chemical reactions are very few.

5.9.1. Reactions in which the carbon – oxygen bond is broken

(a) Ethers react with hot concentrated sulphuric acid to form alcohols according to the following reaction.

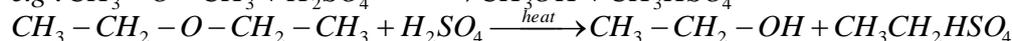
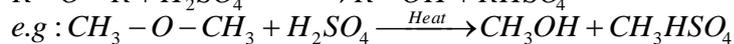

(b) Reaction with hydrohalic acids

Ethers react with cold hydrohalic acids to form alkyl halides and alcohols.



Examples

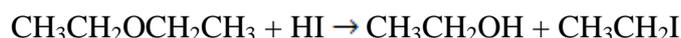

Note: For unsymmetrical ethers, the halogen is attached to the smaller of the two alkyl groups

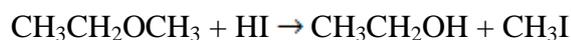

Ethers react with hot hydrohalic acids to form only alkyl halides.

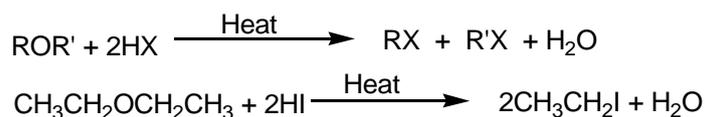

- (c) Ethers can act as the Lewis base due to the two non-bonded electron pair on oxygen to form coordinative bonds with Grignard reagent. This explains clearly why organ magnesium compounds are manipulated in ether solvent but not in water since in water, there is a reaction which generate alkanes.

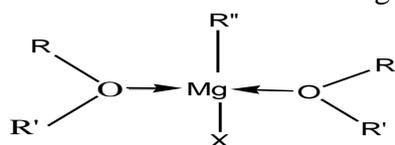

- (d) Combustion of ethers gives carbon dioxide and water:

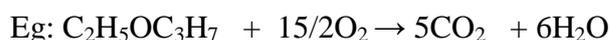

5.9.2 Oxidation reaction

Ethers react with oxygen of air to form **peroxides**



In concentrated or solid form, these peroxides are dangerous because they are highly explosive. The presence of peroxides contaminates the ether. This type of contamination is purified by treatment with a reducing agent such as **alkaline ferrous sulphate**.

5.10. Uses of ethers

Activity 5.10

A nurse is injecting anaesthesia to a patient as seen by the image below.



1. What product that form the anaesthesia.
2. Explain the effects of anaesthesia.
3. In which case a patient is injected anaesthesia?

Lower ethers are used as anesthesia since they produce inert local cooling when sprayed on a skin, ether are also used as local anesthesia for minor surgery operation.

Lower ethers are volatile liquid which on evaporation produce low temperature they are therefore used as **refrigerants**.

Ether itself is one of the most important organic solvents for fats, oils, resins, and alkaloids.

Checking up 5.10:

Make a research and establish at least four uses of ethers

5.11. End unit assessment

I. Multiple choice questions

1. What is the correct name of the molecule with the skeletal formula shown below?

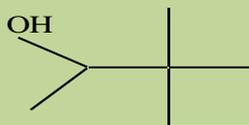

- A 1,2, 2-trimethylbutan-3-ol
B 2-ethyl-2-methylbutan-2-ol
C 3,3-dimethylpentan-2-ol
D 4-hydroxy-3,3-dimethylpentane
2. Compound X, $C_4H_8O_2$, has an unbranched carbon chain. An aqueous solution of X has an approximate pH of 3. Compound Y, C_3H_8O , is a secondary alcohol. X and Y are reacted together in the presence of a little concentrated sulphuric acid to form Z as the major organic product.
What is the structural formula of Z?
A $(CH_3)_2CHCO_2CH_2CH_2CH_3$.
B $CH_3(CH_2)_2CO_2CH(CH_3)_2$
C $CH_3(CH_2)_2CO_2(CH_2)_2CH_3$
D $(CH_3)_2CHCO_2CH(CH_3)_2$
3. The ester $CH_3CH_2CH_2CO_2CH_2CH(CH_3)_2$ was hydrolysed under acidic conditions.
What are the organic products of this hydrolysis?
A butanoic acid and 2-methylpropan-1-ol
B butanoic acid and 2-methylpropan-2-ol
C butan-1-ol and 2-methylpropanoic acid
D propanoic acid and 2-methylpropan-1-ol
4. An unknown organic compound reacts with sodium to give a combustible gas as one product but does not give a yellow precipitate with alkaline aqueous iodine. What is a possible identity of the unknown organic compound?
A Propanal
B Propan-1-ol
C propan-2-ol
D propanone

II Open questions

- 5) A compound A $C_4H_{10}O$, is found to be soluble in sulphuric acid, A doesn't react with sodium or potassium permanganate. When A is heated with hydroiodic acid, it is converted into single alkyl iodide suggest the structure of A
- 6) An organic compound Y possesses the centesimal composition by mass of 87.6% carbon and the rest is hydrogen. The molecular mass of it is 56 g/ mol. Water molecule in presence

of sulphuric acid was added to the same molecule to produce **M**, the molecule **M** was subjected to sulphuric acid and the temperatures of 140 °C, and produce **N**. **Y** possess many isomers including cycles molecules

Establish the structure of **Y**, and all isomers, **M** and all isomers and **N**. Show the mechanism where is possible

7) An organic liquid **M** contains carbon, hydrogen and oxygen. When 0.25 g of **M** is combusted, 0.592g of carbon dioxide and 0.30 g of water was formed

a) (i) calculate the empirical formula

(ii)Molecular formula if the molecular mass is 74 g/mol

b) Write the structural formula and name of all isomers of **M**

c) **M** gives a yellow precipitate with solution of iodine in sodium hydroxide

(i) Identify**M**

(ii) Describe briefly how the functional group in **M** may be determined

(iii) Give a reaction scheme of how **M** can be converted into but-2-yne

8) Compare and contrast the preparation of ethanol by hydration of ethanol and by fermentation by putting an emphasis on the advantages and disadvantages of each process.

UNIT 6: CARBONYL COMPOUNDS: ALDEHYDES AND KETONES

Key unit competency

To be able to compare the chemical nature of carbonyl compounds to their reactivity and uses.

Learning objectives

- *Describe the reactivity of carbonyl compounds*
- *State the physical properties of aldehydes and ketones*
- *Describe the preparation reactions of ketones and aldehydes*
- *Explain the mechanism of nucleophilic addition reactions of carbonyl compounds*
- *Prepare ketones from secondary alcohols by oxidation reactions*
- *Compare aldehydes and ketones by using Fehling's solution and Tollens' reagent*
- *Write and name carbonyl compounds and isomers of ketones and aldehydes*
- *Write equations for the reactions of carbonyl compounds with other substances*
- *Compare the physical properties of carbonyl compounds to those of alcohols and alkenes*
- *Differentiate the methyl ketones from other ketones by using the iodoform test*
- *Carry out an experiment to distinguish between carbonyl compounds and other organic compounds*
- *Carry out an experiment to distinguish between ketones and aldehydes*
- *Carry out an experiment to prepare ethanol and propan-2-one.*

6.1. Definition and nomenclature of carbonyl compounds

Introductory activity

Many fruits such as mangoes and honey contained sugar. The following images represent mangoes, honey and some sugars such as fructose and glucose.

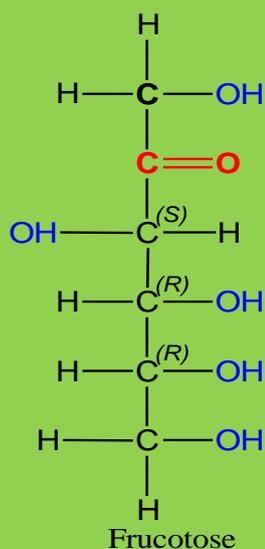
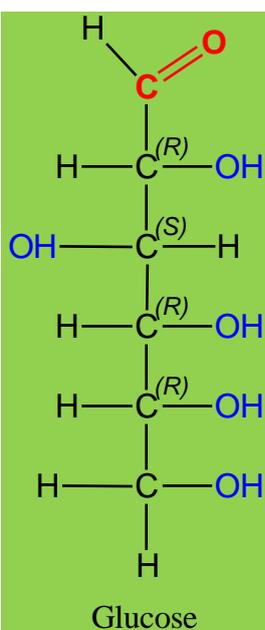

1. State the functional groups found in fructose and glucose.
2. Enumerate other foods that contain sugars

If you are going to write this in a condensed form, you write aldehyde as -CHO , **don't write it as** -COH , because that looks like an alcohol functional group.

Ketone molecules

Ketone has two alkyl groups attached to the carbonyl group. Examples:

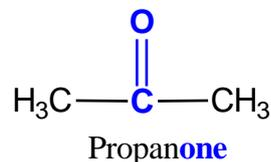

Important: ketones **don't** have a hydrogen atom attached to the carbonyl group.

6.1.2 Nomenclature

Aldehydes

The systematic name of an aldehyde is obtained by replacing the terminal “e” from the name of the parent hydrocarbon with “al.” In numbering the carbon chain of an aldehyde, the carbonyl carbon is numbered one.

1st Example: Write formula of **propanal**.

Propanal has a chain of 3 carbons without carbon-carbon double bonds. The **suffix ‘al’** indicates the presence of the -CHO group. The carbon in carbonyl functional group is counted as first of the chain.

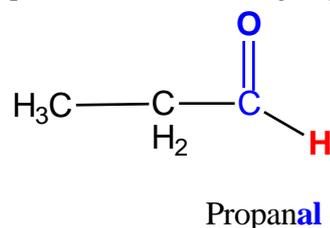

2nd Example: Write formula of **2-methylpentanal**.

This molecule has 5 carbons in the longest chain, including the one in the -CHO group. There aren't any carbon-carbon double bonds. A methyl group is attached to the number 2 carbon

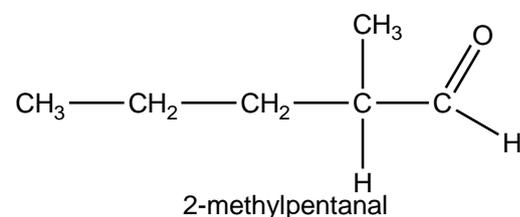

Important: in aldehydes, the carbon in the -CHO group is always counted as first carbon.

Ketones

The systematic name of a ketone is obtained by removing the terminal “e” from the name of the parent hydrocarbon and adding “one.” The chain is numbered in the direction that gives

the **carbonyl carbon the smallest number**. Ketone contains a carbon-oxygen double bond just like aldehyde, but for ketone carbonyl groups are bonded to two alkyl groups.

1st Example: Write formula of **propanone**.

Propanone has a chain of 3 carbons. The **suffix "one"** indicates the presence of the $>C=O$ in the middle of the carbon chain. The carbon-oxygen double bond has to be in the middle of the carbon chain, for this molecule, the carbonyl group is on carbon 2.

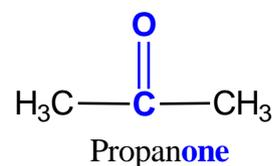

2nd Example: Write formula of **pentan-3-one**.

In pentanone, the carbonyl group could be in the middle of the chain or next to the end - giving either pentan-3-one or pentan-2-one.

The position of the carbon-oxygen double bond has to be indicated because there is more than one possibility. This molecule has its carbon-oxygen double bond at carbon 3. If it was on the second carbon, it would be pentan-2-one.

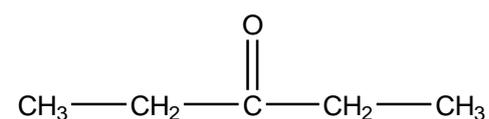

Checking up 6.1

1. For each of the following structures, justify whether it is an aldehyde or a ketone, and name each.

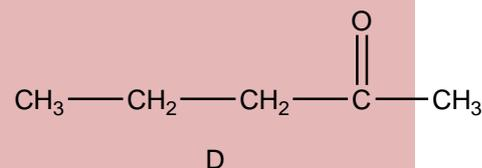
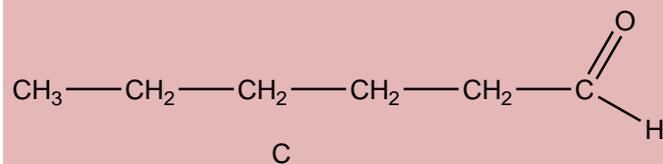
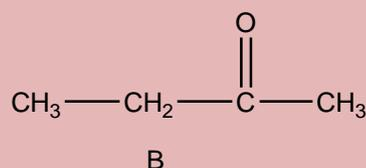
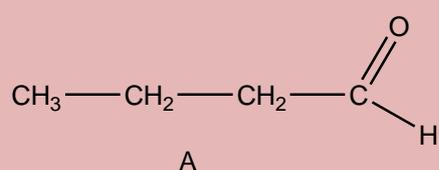

2. Draw the structural formulas derived from the following names.

- i. Hexan-3-one
- ii. pentan-2-one
- iii. 2-methylpropanal

6.2. Isomerism

Activity 6.2

Look at the molecules below and answer the following questions.

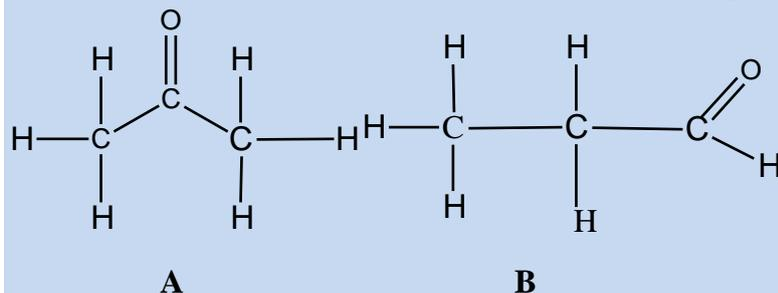

- 1) Write molecular formula of **A** and **B**
- 2) Compare the molecular formulae of **A** and **B**
- 3) State a term that can be used to describe relationship between molecules **A** and **B**.
- 7) write down other three different examples which are related as **A** and **B**.

6.2.1 Functional group isomerism in aldehydes and ketones

Isomers are molecules that have the same molecular formula, but have a different arrangement of the atoms in space.

Functional group isomers are molecules that have same molecular formula but contain different functional groups, and they belong to different homologous series of compounds.

Example 1; C_3H_6O , structural formulae of this molecular formula can be either propanal or propanone, aldehyde or ketone.

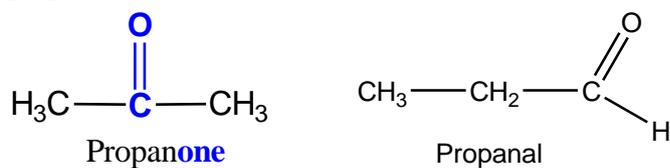

Other possible structural formula of C_3H_6O is:

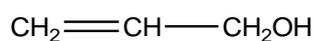

Example 2: $C_5H_{10}O$, structural formulae of this molecular formula can be pentan-3-one or pentan-2-one, aldehyde or ketone.

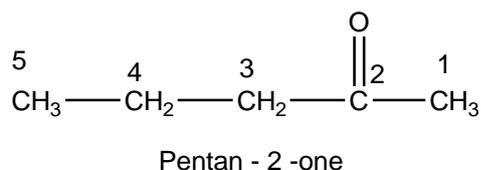
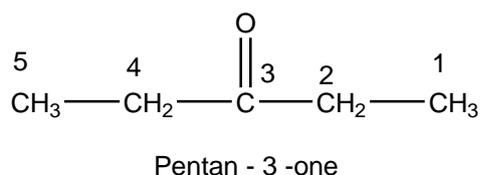

You could draw others possible structural formula of $\text{C}_5\text{H}_{10}\text{O}$ that have alkene and alcohol functional groups.

Example:

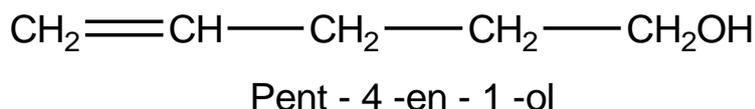

6.2.2. Position isomerism in ketones

Position isomerism is isomerism where carbon skeleton remains constant, but the functional group takes different positions on carbon skeleton.

Example1: $\text{C}_5\text{H}_{10}\text{O}$, structural formulae of this molecular formula can be pentan-3-one or pentan-2-one, aldehyde or ketone.

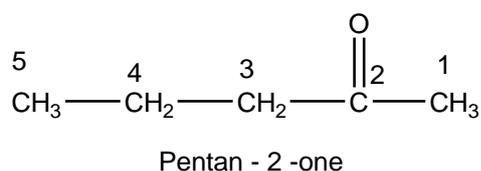
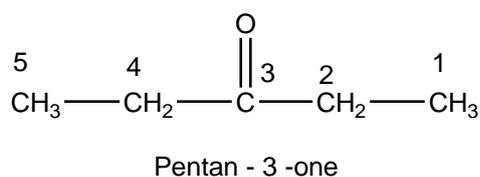

6.2.3. Chain isomerism in aldehydes and ketones

In chain isomerism the same number of carbons forms different skeletons. Aldehydes with 4 or more carbon atoms and ketones with five or more carbon atoms show chain isomerism.

For example1: $\text{C}_4\text{H}_8\text{O}$

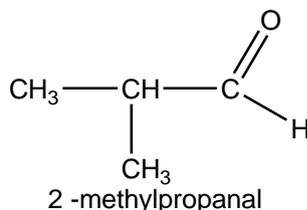
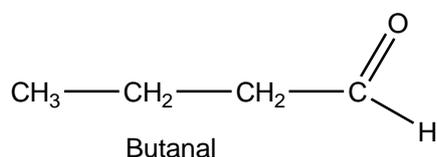

For example2: $\text{C}_5\text{H}_{10}\text{O}$

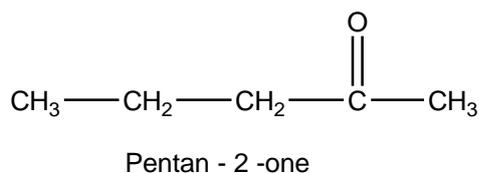
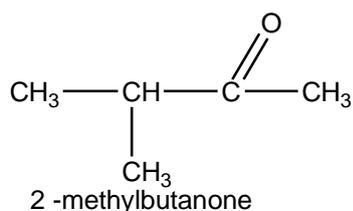

Checking up 6.2

Draw as many as possible all the structural isomers of $\text{C}_5\text{H}_{10}\text{O}$.

6.3. Physical properties of aldehydes and ketones

Activity 6.3

- Take 50 ml for each substance: ethanal, butanal and propanone.
- Mix ethanal with 50ml of water in beaker
- Mix butanal with 50ml of water in beaker
- Mix propanal with 50ml of water in beaker
 - i. Compare the solubility of ethanal, butanal and propanone in water.
 - ii. State intermolecular forces present in each substances
 - iii. Explain what happen in term of intermolecular forces during mixing those above substances with water.
 - iv. Explain why some substances have high solubility in water than other.
 - v. Explain how the intermolecular forces present in ethanal, butanal and propanone affect other physical properties like boiling and melting point of these substances.

6.3.1. Solubility in water aldehydes and ketones

The small molecules of aldehydes and ketones are soluble in water but solubility decreases with increase of carbon chain. Methanal, ethanal and propanone - the common small aldehydes and ketones are soluble in water at all proportions.

Even though aldehydes and ketones don't form hydrogen bond with themselves, they can form hydrogen bond with water molecules.

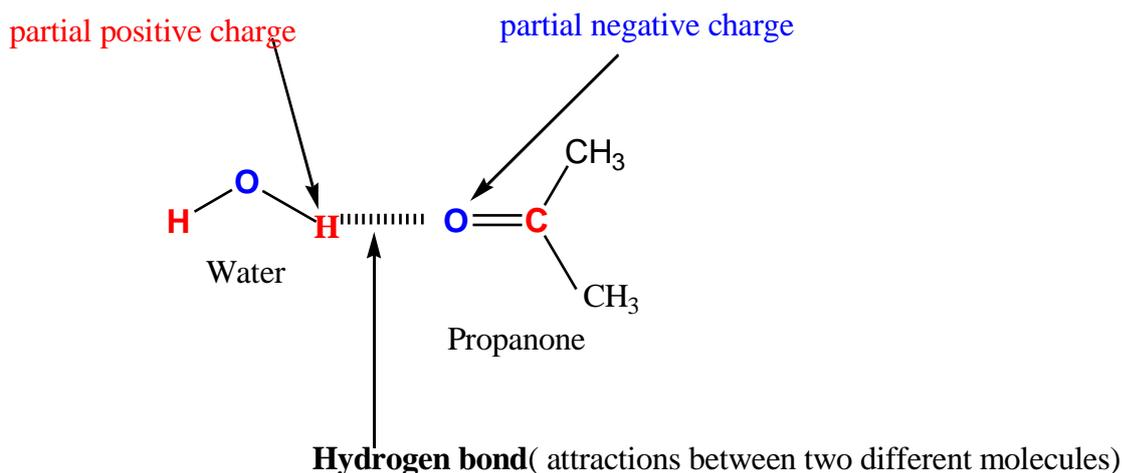

The slightly positive hydrogen atoms in a water molecule can be sufficiently attracted to the lone pair on the oxygen atom of an aldehyde or ketone to form a hydrogen bond.

Other intermolecular forces present between the molecules of aldehyde or ketone and the water are dispersion forces and dipole-dipole attractions

Forming these attractions releases energy which helps to supply the energy needed to separate the water molecules and aldehyde or ketone molecules from each other before they can mix together.

Apart from the carbonyl group, hydrocarbon chains are non polar, they don't dissolve in water. By forcing hydrocarbon chain to mix with water molecules, they break the relatively strong hydrogen bonds between water molecules without replacing them by other attractions good like hydrogen bonds. This makes the process energetically less profitable, and so solubility decrease.

6.3.2. Boiling points of aldehydes and the ketones

Methanal is a gas and has a boiling point of -21°C , and ethanal has a boiling point of $+21^{\circ}\text{C}$. The other aldehydes and ketones are liquids or solids, with boiling points rising with rising of molecular mass hence rising of strength of Van der Waals force.

Comparing the physical properties of carbonyl compounds to those of alcohols and alkanes

Physical properties of covalent compounds depend on intermolecular forces. Compounds that have similar molecular mass but different intermolecular forces have different physical properties.

Example of comparison between molecules of similar mass but different composition

Molecule	Molecular mass	type	Boiling point ($^{\circ}\text{C}$)

CH ₃ CH ₂ CH ₃	44	alkane	-42
CH ₃ CHO	44	aldehyde	+21
CH ₃ CH ₂ OH	46	alcohol	+78
CH ₃ COCH ₃	54	ketone	+56

Alcohols have higher boiling point than aldehydes and ketones of similar lengths. In the alcohol, there is hydrogen bonding, but the molecules of aldehydes and ketones don't form hydrogen bonds. Aldehydes and ketones are polar molecules but alkanes are non polar molecules.

Checking up 6.3

The Table below shows the boiling points of an alkane, an aldehyde and an alcohol.

molecule	Molecular mass	type	boiling point (°C)
CH ₃ CH ₂ CH ₃	44	alkane	-42
CH ₃ CHO	44	aldehyde	+21
CH ₃ CH ₂ OH	46	alcohol	+78

- Explain why the boiling point of an aldehyde is greater than that of the alkane?
- Why is the boiling point of the alcohol still higher?
- Explain why, unlike the similar-sized alkanes, the small aldehydes and ketones are soluble in water.
- Describe the solubility variation of aldehydes and ketones.

6.4. Chemical properties of carbonyl compounds

6.4.1. Nucleophilic addition reactions

Activity 6.4.1

- KCN is a reagent used to add HCN to carbonyl compounds.

Write equation that show how KCN dissociates in polar solvent

- Observe carefully the following carbonyl functional group and answer the following questions.

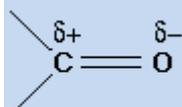

Compare the electronegativities of carbon and oxygen

1. Explain how these partial charges in carbonyl group arise.
- CN⁻ is added first to carbonyl functional group then H⁺ is added after.
2. At which element of carbonyl functional group CN⁻ will be added, and why?
 3. At which element of carbonyl functional group H⁺ will be added, and why?

a. Polarity of carbonyl group

By comparing carbon-carbon double bond and carbon-oxygen double bond the only difference between bonds C=C and C=O is distribution of electrons. The distribution of electrons in the pi bond is heavily *attracted* towards the oxygen atom, because oxygen atom is much more electronegative than carbon.

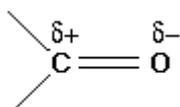

During chemical reactions *nucleophiles* will attack carbon of the carbonyl functional group which bears a partial positive charge. While electrophile will attack oxygen of the carbonyl functional group which bears a partial negative charge.

b. Reaction of HCN with aldehydes and ketones

Hydrogen cyanide adds to aldehydes or ketones to form *cyanohydrins or hydroxynitriles*. The product has one more carbon atom than the reactant. For example, ethanal reacts with HCN to form 2-hydroxypropanenitrile:

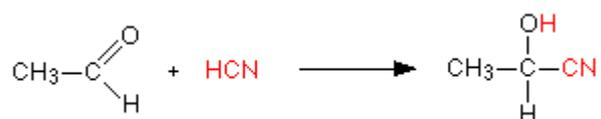

When HCN reacts with propanone, the product is 2-hydroxy-2-methylpropanenitrile:

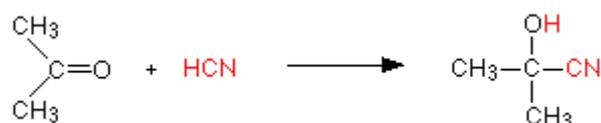

Because hydrogen cyanide is a toxic gas, the best way to carry out this reaction is to generate hydrogen cyanide during the reaction by adding HCl to a mixture of the aldehyde or ketone and excess sodium cyanide. Excess sodium cyanide is used in order to make sure that some

cyanide ion is available to act as a nucleophile. The solution will contain hydrogen cyanide (from the reaction between the sodium or potassium cyanide and the HCl)

The pH of the solution is maintained in range 4 - 5, because this gives the fastest reaction. The reaction takes place at room temperature.

c. The mechanism of reaction between HCN and propanone

1st Step: A nucleophilic, CN^- , attacks on the slightly positive charged carbon of carbonyl group.



Important: Nucleophile is a negative ion (for example CN^-), or compound in which an atom has unshared pair of electrons (for example: NH_3).

2nd Step: The negative ion formed picks up a hydrogen ion from hydrogen cyanide. Water or the H_3O^+ ions present in solution can serve as source of the hydrogen ion.

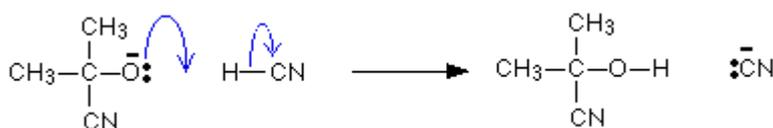

Important: Electrophile is a reagent which attacks high electron density region (for example, HCN , SO_3).

These are examples of *nucleophilic addition*.

d. Application of the reaction

The product of the reaction above has two functional groups:

- The -OH group which behaves like ordinary alcohol and can be replaced by other substituent like chlorine, which can in turn be replaced to give other functional group, for example, an - NH_2 group;
- The -CN group which can be hydrolysed into a carboxylic acid functional group -COOH.

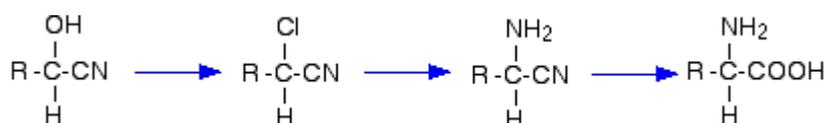

e. Reaction of NaHSO_3 with aldehydes or ketones

The aldehyde or ketone is shaken with a saturated solution of sodium hydrogen sulphite in water. Hydrogen sulphite with negative charge act as nucleophile, where the product formed is separated as white crystals. Propanone react hydrogen sulphite, as below:

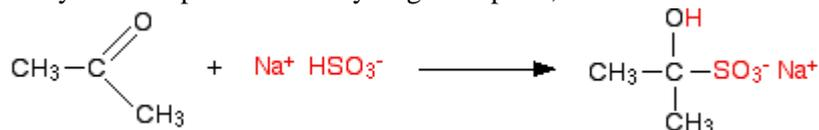

Impure aldehyde and ketone can be purified by using this reaction. Impure aldehyde or ketone is shaken with a saturated solution of sodium hydrogensulphite to produce the crystals. Impurities don't form crystals; these crystals formed are filtered and washed to remove any impurities. Addition of dilute acid to filtered crystals regenerates the original aldehyde. Dilute alkali also can be added instead dilute acid.

Checking up 6.4.1

Aldehydes and ketones undergo addition reactions involving hydrogen cyanide in which H and CN add on the carbon-oxygen double bond.

- Why isn't hydrogen cyanide itself normally used in these reactions?
- Give a mixture which can be used instead of starting with hydrogen cyanide itself.
- Draw the structures and give the names of the products of the reaction between hydrogen cyanide and
 - Ethanal
 - Propanone
- One use of the products of these reactions (known as hydroxynitriles) is as a part of a sequence of reactions to make more complicated molecules like amino acids from more simple ones. The amino acid valine has the structure:

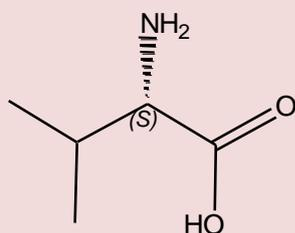

valine

- Write the structure of the hydroxynitrile which you would have to modify in order to make valine
- Write the structure of the aldehyde or ketone which you would have to react with hydrogen cyanide in order to get that hydroxynitrile.

6.4.2. Condensation reactions

Activity.6.4.2

You are provided with the following: propanal, propanone, alcohol (ethanol), glucose solution and 2,4-dinitrophenylhydrazine (Brady reagent)

Take about 2ml of each solution; propanal, propanone, alcohol (ethanol) and glucose solution in test tubes. Add 6 drops of the 2,4-dinitrophenylhydrazine to each of the test tubes containing: propanal, propanone, (alcohol)ethanol or glucose solution. If no precipitate forms immediately, warm for 5 minutes in the water bath. Record your observations in the table below.

Substance	Observations	Deductions
Aldehydes (propanal)		
Ketones (propanone)		
Alcohol(ethanol)		

a. Experimental reaction

The procedure of the preparation of Brady's reagent and carbonyl compounds changes slightly depending on the nature of the aldehyde or ketone, and the solvent in which 2,4-dinitrophenylhydrazine is dissolved in. The Brady's reagent for activities (6.4.1) is a solution of the 2,4-dinitrophenylhydrazine in methanol and sulphuric acid.

Add a few drops of Brady's reagent to either aldehyde or ketone. A bright orange or yellow precipitate indicates the presence of the carbonyl group in an aldehyde or ketone.

b. Structural formula of 2,4-dinitrophenylhydrazine.

The carbon of benzene attached to hydrazine is counted as number one. In 2,4-dinitrophenylhydrazine, there are two nitro groups, NO_2 , attached to the phenyl group in the 2- and 4- positions.

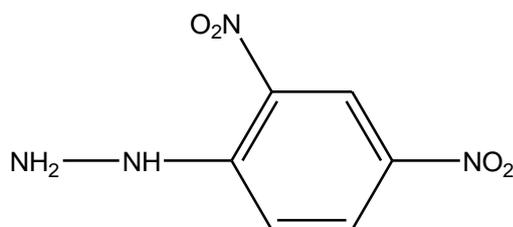

2,4 -dinitrophenylhydrazine

2,4-dinitrophenylhydrazine is often abbreviated as 2,4-DNP or 2,4-DNPH.

c. The reaction of carbonyl compounds with 2,4-dinitrophenylhydrazine

Brady's reagent is a solution of the 2,4-dinitrophenylhydrazine in methanol and sulphuric acid. The overall reaction of carbonyl compounds with 2,4-dinitrophenylhydrazine is:

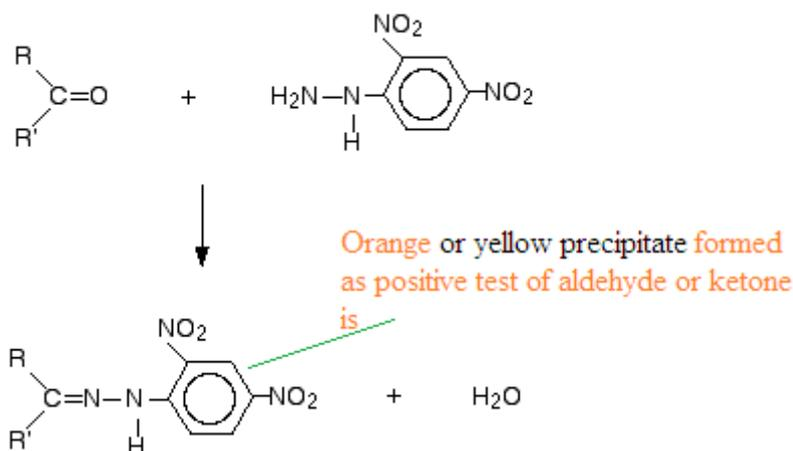

Where R and R' represent alkyl groups or hydrogen(s); if both or only one is hydrogen(s) the starting carbonyl compound is an aldehyde. If both R and R' are alkyl groups the carbonyl compound is a ketone. The following molecule shows clearly how the product is formed.

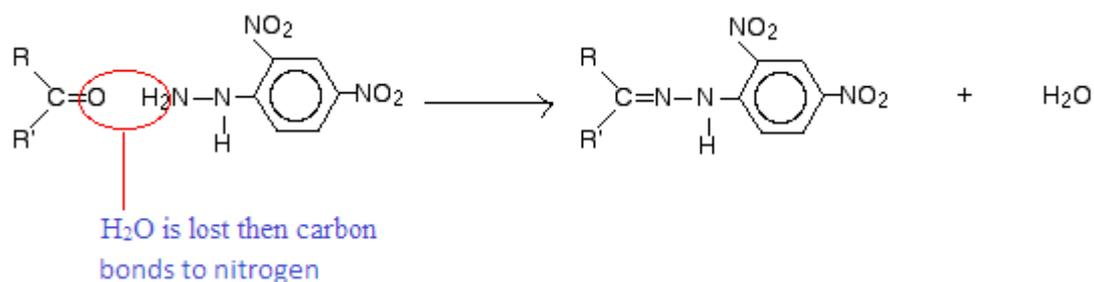

The product formed is named "2,4-dinitrophenylhydrazone". The simple difference consists in replacing suffix "-ine" by "-one".

The reaction of 2,4-dinitrophenylhydrazine with ethanal produces ethanal 2,4-dinitrophenylhydrazone; The reaction of 2,4-dinitrophenylhydrazine with butanal produces butanal 2,4-dinitrophenylhydrazone. This is an example of **condensation reaction**.

During the chemical reaction, the change takes place only on nitrogen (-NH₂) of hydrazine in 2,4-dinitrophenylhydrazine. If the -NH₂ group is attached to other groups a similar reaction as that of 2,4-dinitrophenylhydrazine will take place:

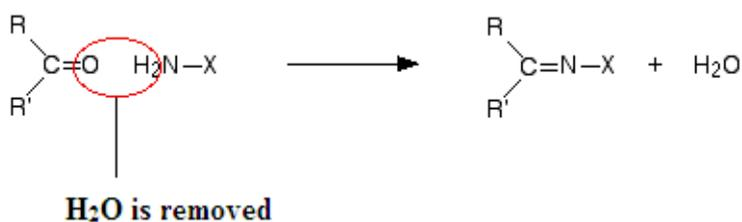

Note: A condensation reaction is one in which two molecules join together with the loss of a small molecule in the process.

Where "X" can be: hydrazine, phenylhydrazine or hydroxylamine.

- Hydrazine reacts with carbonyl compound to form **hydrazone**

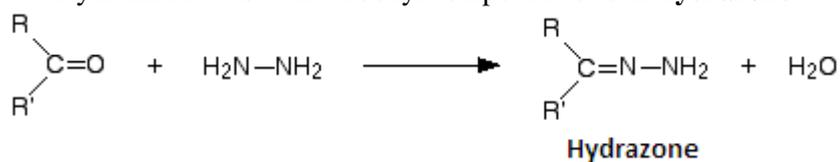

Example

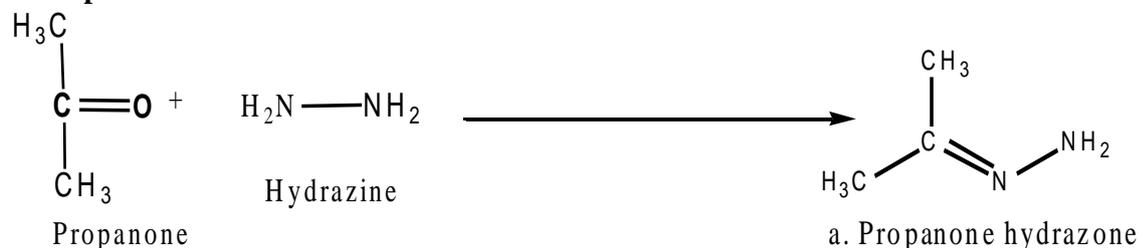

- Phenylhydrazine reacts with carbonyl compound to form "**phenylhydrazone**".

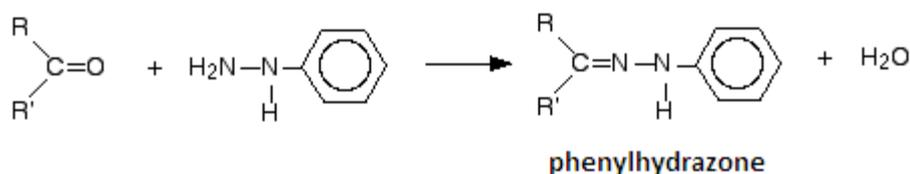

- Hydroxylamine reacts with carbonyl compounds to form **oxime**.

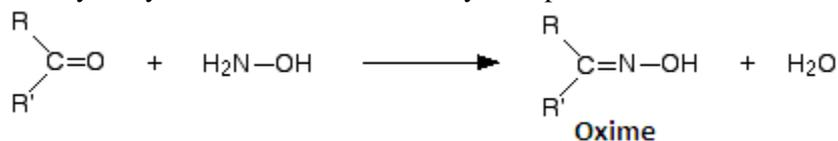

Checking up 6.4.2

- Brady's reagent is a solution of 2,4-dinitrophenylhydrazine in a mixture of methanol and sulphuric acid.
 - How is Brady's reagent used to test for an aldehyde or ketone?
- Draw the structural formulae for
 - Propanone hydrazone
 - Propanone phenylhydrazone

6.4.3. Oxidation reactions using KMnO_4/H^+ and $\text{K}_2\text{Cr}_2\text{O}_7/\text{H}^+$

Activity 6.4.3

Materials:

- Test tubes
- Test tubes holder
- Test tube racks
- Count droppers
- Beakers

You are provided with the following: propanal, propanone and potassium dichromate (VI) solution acidified with dilute sulphuric acid.

Take about 2ml of each solution; propanal and propanone; add 6 drops of the potassium dichromate(VI) solution acidified with dilute sulphuric acid. Record your observations in the table below.

Substance	observations	Deductions
Aldehydes (propanal)		
Ketones (propanone)		

a. Difference in reactivity of ketones and aldehydes with $\text{K}_2\text{Cr}_2\text{O}_7$

By considering the structural formulae of aldehydes and ketones, the difference is only the presence of a hydrogen atom attached to the carbonyl functional group in the aldehyde whereas ketones have a alkyl group instead.

Important:
Oxidation
 could be defined as loss of hydrogen or as gain of

Ketone doesn't have hydrogen attached on carbonyl group

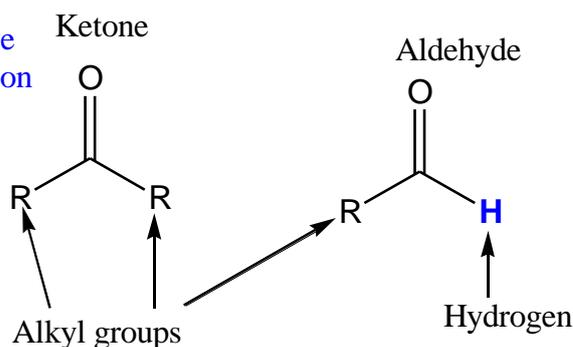

During chemical reaction aldehydes react with oxidizing agent; hydrogen on carbonyl functional group is replaced by oxygen, look on figure below. The presence of hydrogen atom makes aldehydes very easy to oxidize, in other words aldehydes are strong reducing agents.

For ketone, absence of hydrogen on carbonyl functional group makes ketones to resist oxidation. But very strong oxidising agents like potassium permanganate solution oxidize ketones - and they do it in a destructive way, by breaking carbon-carbon bonds.

Aldehyde oxidation can take place in acidic or alkaline solutions. Under acidic solutions, the aldehyde is oxidized to a carboxylic acid. Under alkaline solutions, acid formed react with base to form a salt of carboxylic acid.

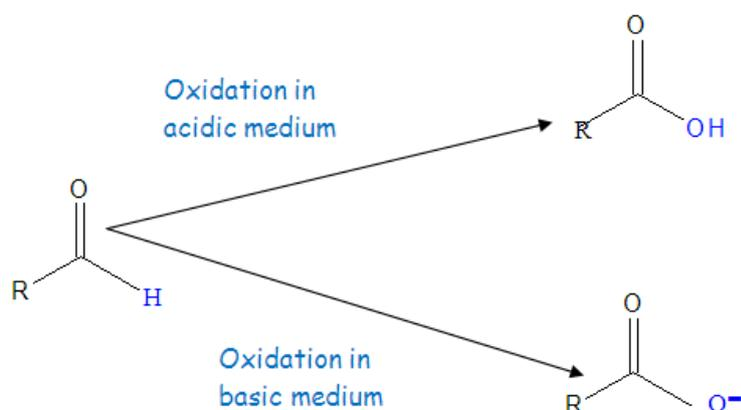

b. Oxidation of aldehyde by $K_2Cr_2O_7/H^+$ solution

Add few drops of the aldehyde or ketone to a solution of potassium dichromate (VI) acidified with dilute sulphuric acid. If the color doesn't change in the cold, the mixture is warmed gently in a beaker containing hot water.

Tested substances	Observations
Aldehydes	Orange color of $K_2Cr_2O_7$ solution turns green of Cr^{3+} solution.
Ketones	Orange color of $K_2Cr_2O_7$ solution doesn't change.

The dichromate (VI) ions, $Cr_2O_7^{2-}$, is an oxidizing agent, it oxidizes aldehyde to carboxylic acid, and it is reduced to Cr^{3+} :

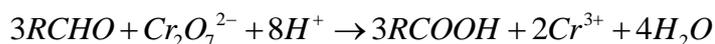
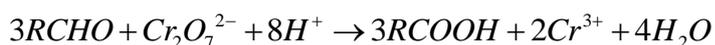

Checking up 6.4.3

- i. If you react ethanal with acidified potassium dichromate (VI) solution, what organic product would you get?
- ii. Write a half-equation for the formation of that product from ethanal.
- iii. Write a half-equation for the dichromate(VI) ion acting as an oxidising agent is

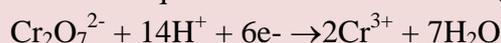

Use this equation and the one you wrote in part (ii) to work out the ionic equation for the reaction.

6.4.4. Oxidation reactions using Tollens' reagent

Activity 6.4.4

Materials:

- Test tubes
- Test tubes holder
- Test tube racks
- Count droppers
- Beakers
- Bunsen burner

You are provided with the following: propanal, propanone and Tollens' reagent.

Take about 2ml of each solution; propanal and propanone. Add 6 drops of the Tollens' reagent to each of the following in the test tubes; propanal or propanone. Warm gently the mixture in a hot water bath for a few minutes. Record your observations in the table below.

Substance	observations	Deductions
Aldehydes (propanal)		
Ketones (propanone)		
Sugar (glucose)		

a. Difference in reactivity of Ketones and Aldehydes with Tollens' reagent

Aldehydes can also be oxidized into carboxylic ions in basic medium.

Tollens' reagent is a solution of diamminesilver (I) ion, $[Ag(NH_3)_2]^+$ and OH^- .

In order to identify if a substance is aldehyde or ketone, add few drops of Tollens reagent to test tubes containing aldehyde or ketone and warm gently in a hot water bath for a few

minutes. The formations of silver mirror or grey precipitate is an indication of the presence of aldehyde.

Tested substances	Observations
Aldehydes	The colourless solution produces a grey precipitate of silver, or a silver mirror on the test tube.
Ketones	Colourless solution doesn't change: no reaction

Equation of reaction:

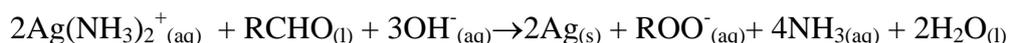

Checking up 6.4.4

a) Tollens' reagent is alkaline because of the sodium hydroxide solution and ammonia solution used to make it. What organic product would you get in this case if you reacted propanal with Tollens' reagent?

b) Write half equation for the formation of that product from propanal.

c) Write the half-equation for the reaction of the $[\text{Ag}(\text{NH}_3)_2]^+$ ion when it forms the visible product of the reaction.

Combine these two half-equations to give an ionic equation for the reaction of Tollens' reagent with ethanal.

6.4.5. Oxidation reactions using Fehling or Benedict solution

Activity 6.4.5

Materials:

- Test tubes
- Test tubes holder
- Test tube racks
- Count droppers
- Beakers
- Bunsen burner

You are provided with the following: ethanal, propanone, Fehling's solution and Benedict's solution

Take about 2ml of each solution. Add 6 drops of the Fehling's solution or Benedict's solution to each of the tubes containing 2ml of ethanal or propanone to be tested. Warm gently the mixture in a hot water bath for a few minutes. Record your observations in the table below.

Substance	observations	Deductions
Ketones (propanone)		
Aldehydes (propanal)		

a. Difference in reactivity of Ketones and Aldehydes with Fehling or Benedict solution

Fehling's solution and Benedict's solution react with aldehyde in the same way; both solutions contain Cu^{2+} and OH^- . In Fehling's solution Cu^{2+} is complexed with tartrate ligand but in Benedict's solution Cu^{2+} is complexed with citrate ligand.

Don't worry about ligands, important reagents are Cu^{2+} and OH^- , ligands tartrate and citrate are used to prevent formation of precipitate copper (II) hydroxide or copper (II) carbonate.

A few drops of Fehling's solution or Benedict's solution is added to the aldehyde or ketone and the mixture is warmed gently in a hot water bath for a few minutes.

Tested substances	Observations
Aldehydes	The blue solution produces a dark red precipitate of copper (I) oxide (Cu_2O).
Ketones	The blue color of Cu^{2+} solution doesn't change. Reaction doesn't occur

Fehling's solution and Benedict's solution are oxidizing agent, they oxidize aldehydes to carboxylic acid. Remember that reaction takes place in basic solutions, acid formed is neutralized by base, and hence the products are a salt of carboxylic acid instead of carboxylic acid. Equations of reaction.

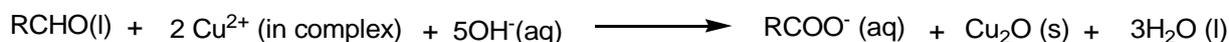

Checking up 6.4.5

Fehling's solution and Benedict's solution both contain copper (II) complexes in an alkaline solution. The copper (II) complex can be simplified to $\text{Cu}^{2+}(\text{in complex})$, and the electron-half-equation given as

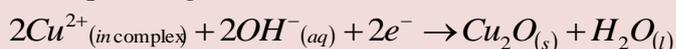

- Write the electron-half-equation for the oxidation of propanal in an alkaline solution.
- Combine this with the equation above to give the ionic equation for the reaction between Fehling's or Benedict's solution with propanal.

6.4.6. Iodoform reaction with aldehydes and ketones

Activity 6.4.6

Materials:

- Test tubes
- Test tubes holder
- Test tube racks
- Count droppers
- Beakers
- Bunsen burner

You are provided with the following: propanone, propanal, 6M NaOH solution and KI_3 solution

Put 4 drops of each tested substances, propanone, propanal, into different test tubes.

Add to this 0.5 mL distilled water to each test tube.

Add 0.25mL 6M NaOH and 0.25 mL of water to each test tube.

Add 6 drops of I_3^- solution to each test tube.

If no precipitate forms immediately, warm the mixture very gently. Record your observations in the table below.

Substance	Observations	Deductions
$\begin{array}{c} \text{CH}_3 \\ \\ \text{C}=\text{O} \\ \\ \text{CH}_3 \end{array}$		
$\text{CH}_3-\text{CH}_2-\text{C} \begin{array}{l} \nearrow \text{O} \\ \searrow \text{H} \end{array}$		

a. Reagents for iodoform reaction

There are two different mixtures that can be used to do iodoform test, these mixture are:

- Iodine and sodium hydroxide solution
- Potassium iodide and sodium chlorate (I) solutions

Don't worry about Potassium iodide and sodium chlorate(I) solutions, Potassium iodide and sodium chlorate(I) react to form final solution contain I_2 and OH^- . Both mixtures contain the same reagents.

Each of these mixtures contains important reagent I_2 and OH^- which react with aldehyde or ketone. When I_2 and OH^- is added to a carbonyl compound containing the group CH_3CO (blue in the cycle) as shown below, pale yellow precipitate (triiodomethane) is formed.

Carbonyl compound that has this group reacts with I_2 and OH^- to form pale yellow precipitate

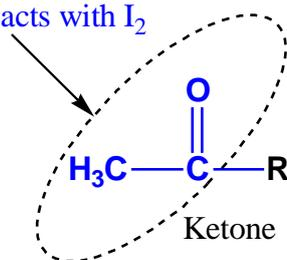

Where **R** is an alkyl group for ketone

Carbonyl compound that has this group reacts with I_2 and OH^- to form pale yellow precipitate

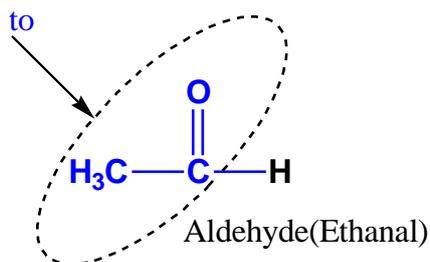

Note: iodine, I_2 , is dissolved in iodide solution to form I_3^- which is soluble in water

a. Description of iodoform test

For iodine and sodium hydroxide solution

Iodine solution, I_3^- , is added to aldehyde or ketone, followed by just enough sodium hydroxide solution to remove the colour of the iodine. If pale yellow precipitate doesn't form in the cold, it may be necessary to warm the mixture very gently. The positive result is pale yellow precipitate of CHI_3

For potassium iodide and sodium chlorate (I) solutions

Potassium iodide solution is added to a small amount of aldehyde or ketone, followed by sodium chlorate (I) solution. If pale yellow precipitate doesn't form in the cold, warm the mixture very gently. The positive result is pale yellow precipitate of CHI_3 .

Reaction of iodoform test

The reagents of iodoform test are I_2 and OH^- solution. The reaction takes place into two main steps:

- Three hydroxides, OH^- , remove three hydrogens from methyl group and the place of hydrogen is taken by iodide.

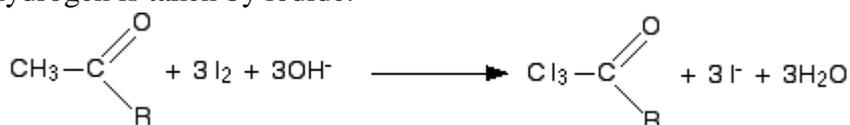

- CI_3^- group is a good leaving group; CI_3^- is replaced by OH^- to form carboxylic acid, because CI_3^- is a base according to Bronsted-Lowry, it reacts with acid to form the following product:

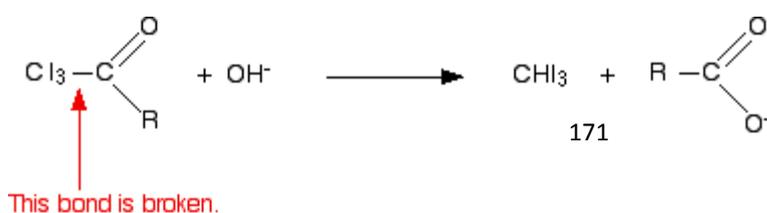

The overall equation for reaction of iodoform test:



The same reaction takes place for other halogen elements in the same way. The general equation is given below

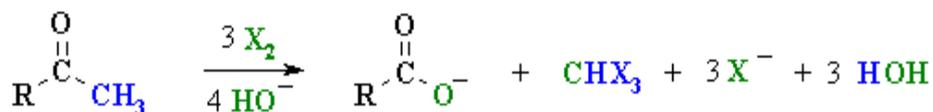

When methyl ketones or methyl aldehyde, ethanal, are treated with the halogen element in basic solution, hydrogens of the methyl group are replaced by halogen element followed by cleavage of the methyl group. The products are the salt of carboxylic acid and trihalomethane. The reaction is fast until the 3 hydrogens at the methyl group have been replaced by a halogen.

Checking up 6.4.6

A has the formula $\text{C}_5\text{H}_{12}\text{O}$. Its oxidation gives **B** with the formula $\text{C}_5\text{H}_{10}\text{O}$. **B** reacts with 2,4-dinitrophenylhydrazine to give a positive test. **A** is dehydrated by concentrated H_2SO_4 to **C**, C_5H_{10} . Reductive ozonolysis of **C** gives butanal. Identify the compound **A**

6.5. Preparation methods of aldehydes and ketones

6.5.1. Oxidation of alcohols

Activity 6.5.1

The set up below represents the method of preparation of ethanal from ethanol. Look it carefully and answer the following questions.

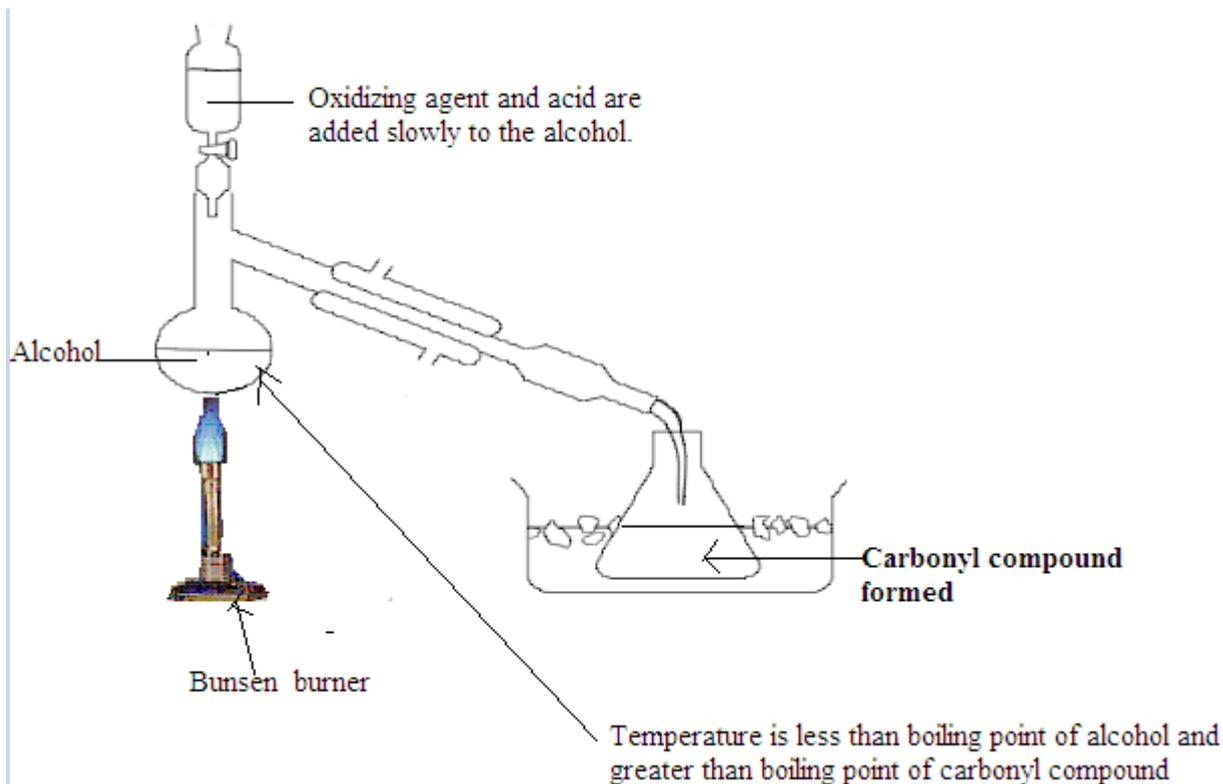

Ethanol reacts with $\text{K}_2\text{Cr}_2\text{O}_7/\text{H}^+$, does ethanol undergoes oxidation or reduction in this reaction?

- 1 Write down chemical equation that takes place in this experiment
- 2 Explain why it is necessary to heat and explain the point of choosing temperature at which reaction takes place.
- 3 Write a balanced equation of the reaction between propan-2-ol and $\text{K}_2\text{Cr}_2\text{O}_7/\text{H}^+$.

a. Oxidation of alcohol by $\text{K}_2\text{Cr}_2\text{O}_7/\text{H}^+$

Potassium dichromate (VI) acidified with dilute sulphuric acid is used as oxidizing agent during the preparation of aldehyde or ketone. Primary alcohol is oxidized to aldehyde, oxygen atom from the oxidising agent removes two hydrogens; one from the -OH group of the alcohol and the other hydrogen comes from the carbon that is attached to hydroxide functional group.

- Primary alcohol undergoes oxidation to produce aldehyde

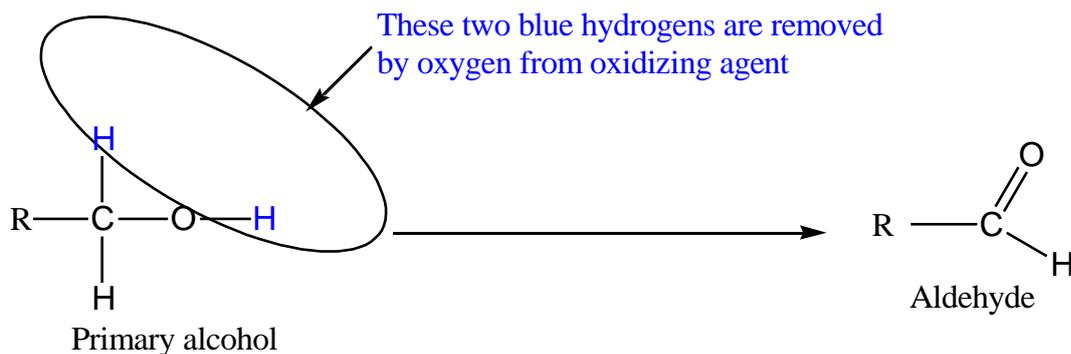

- Secondary alcohol undergoes oxidation to produce ketone

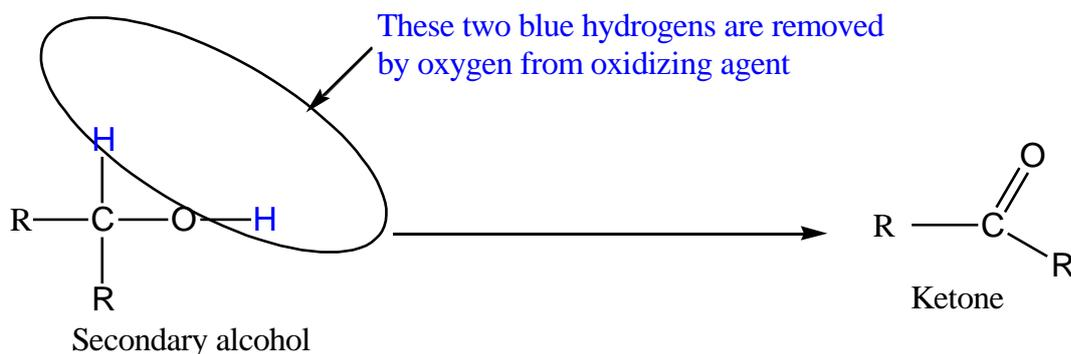

- Tertiary alcohol doesn't undergo oxidation because the carbon bonded to hydroxide doesn't have hydrogen to be removed.

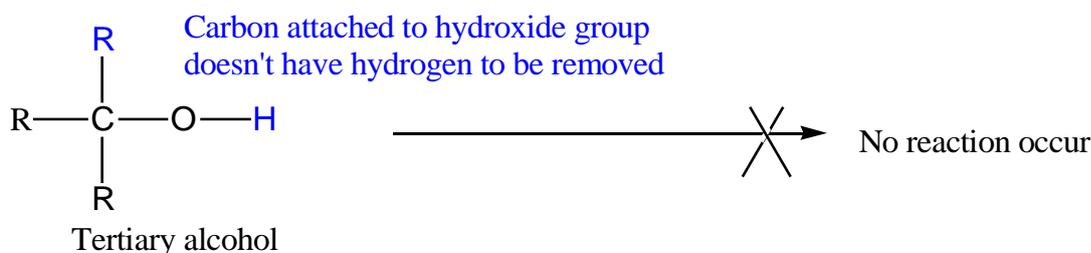

The solution of dichromate (VI) ions, $\text{Cr}_2\text{O}_7^{2-}$, is orange, during chemical reaction dichromate (VI) ions is reduced to chromium (III) ions, Cr^{3+} which is green.



b. Technique of stopping oxidation of aldehyde

The aldehyde produced by oxidation of alcohol could make further oxidation to a carboxylic acid if the acidified potassium dichromate (VI) is still present in solution where reaction takes place. In order to prevent this further oxidation of aldehyde to carboxylic the following technique are used.

- Use an excess of the alcohol than potassium dichromate (VI). Potassium dichromate (VI) is limiting reactant hence there isn't enough oxidising agent present to carry out the second stage of oxidizing the aldehyde formed to a carboxylic acid.

- Distil off the aldehyde as soon as it forms. Removing the aldehyde as soon as it is formed this means that aldehyde is removed from solution where oxidizing agent is, to prevent further oxidation. Ethanol produces ethanal as shown by the following reaction.



To simplify the writing of the reaction, [O] represents oxygen from an oxidising agent. Then the reaction is written as follows:

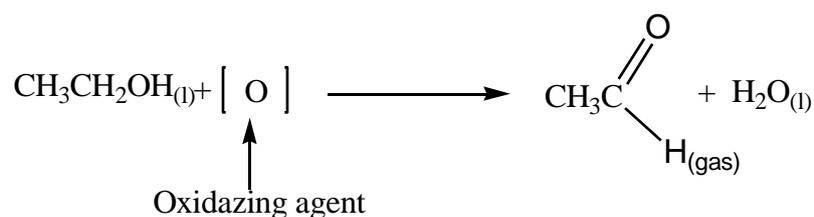

Checking up 6.5

1. Draw the structure of the aldehyde or ketone that would be formed if each of the following alcohols is oxidised. You can assume that conditions are fulfilled to avoid further oxidation of the aldehyde to a carboxylic acid.

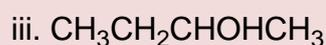
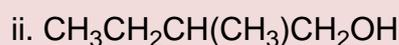
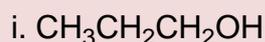

2. Draw the structure of the alcohol you would oxidize in order to obtain each of the following compounds.

i. pentan-2-one

ii. Butanal

3. If you want to oxidize ethanol to ethanal without further oxidation to ethanoic acid, how do you proceed?

4. Which oxidising agent is used to oxidize alcohols to either aldehydes or ketones, and what would you observe during the reaction?

c. Oxidation of alkene by KMnO_4/H^+

Oxidation of alkenes with hot concentrated acidified potassium manganate (VII) solution produces carbonyl compounds. Consider the general formula of alkene below:

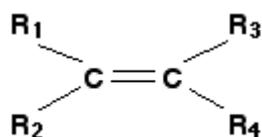

Where R₁, R₂, R₃ and R₄ represent alkyl groups or hydrogen atoms

Carbon-carbon double bond of alkene is broken by acidified potassium manganate (VII) and is replaced by two carbon-oxygen double bonds to each carbon from double bond. General equation:

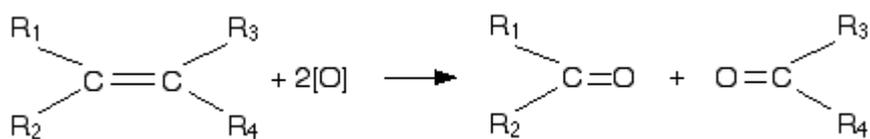

Example 1:

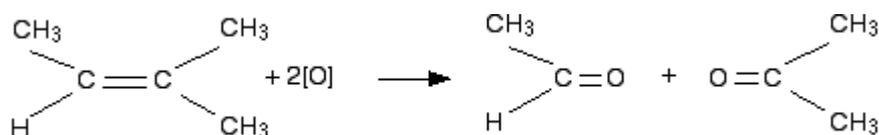

If acidified potassium manganate (VII) is still present in solution, aldehyde makes further oxidation to carboxylic acid

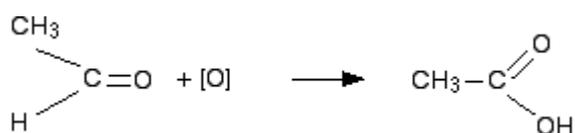

Example 2:

The molecule below has two hydrogens attached to a carbon with double bond

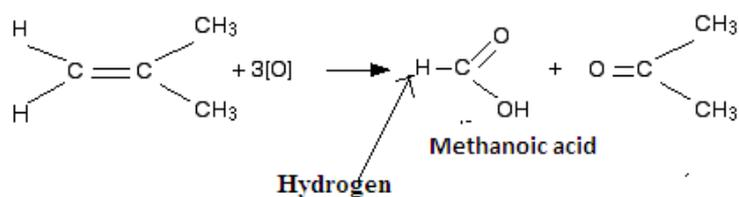

Methanoic acid has hydrogen attached on carbonyl group hence it makes further oxidation to carbon dioxide. Final equation is written as below

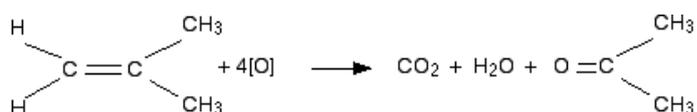

6.5.2. Preparation of ketone by distillation of calcium acetate

Example: preparation of acetone

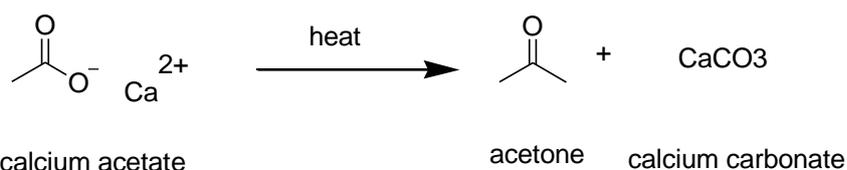

Procedure: Transfer 15g of calcium acetate in 50mL round bottom flask fixed on a stand, and place it on a heating mantle fitted with a condenser and a receiver flask. Adjust the temperature until the condensation starts. Use the aluminium foil to insulate the flask. Heat the flask and collect the acetone in receiver flask. The obtained product is a crude acetone and needs to be purified. Set up a distillation apparatus and distil the crude product to obtain pure acetone (56^oc). Do not forget to use stirrer bar which must be placed in the round bottom flask containing the acetone.

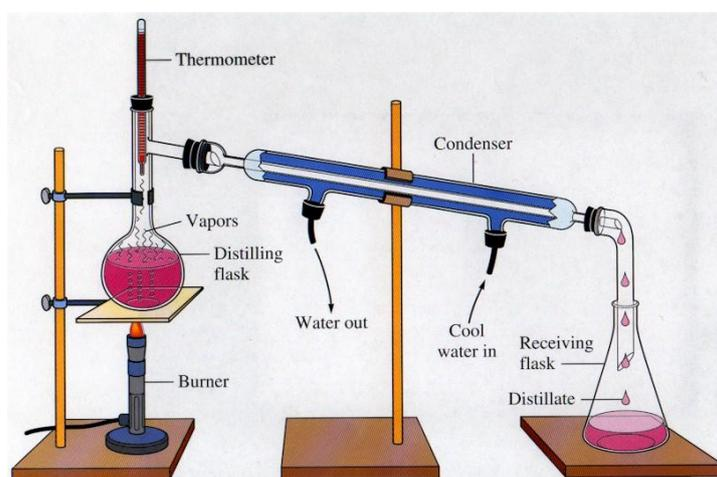

Distillation set up

6.6. Uses of aldehydes and ketones

Aldehydes and ketones have many uses for example in industries such as pharmaceutical industry and in medicine.

a. Formaldehyde:

Formaldehyde is a gas at room temperature but is sold as a 37 percent solution in water.

Formaldehyde is used as preservative and germicide, fungicide, and insecticide for plants and vegetables. Formaldehyde is mainly used in production of certain polymers like Bakelite (Figure 6.1). Bakelite and **formaldehyde** is used as monomers in production of Bakelite



Figure 6.1: Materials made by bakelite polymers

b. Acetone as solvent:

Acetone is soluble in water at all proportions and also dissolves in many organic compounds. Boiling point of acetone is low, 56°C , which makes it easier to be removed by evaporation. Acetone is an industrial solvent that is used in products such as paints, varnishes, resins, coatings, and nail polish removers.

b. Aldehydes and ketones

Organic molecules that contain ketones or aldehydes functional group are found in different foods such as irish potatoes, yellow bananas.

Aldehydes and ketones perform essential functions in humans and other living organisms. For examples sugars, starch, and cellulose, which are formed from simple molecules that have aldehyde or ketone functional group

c. Aldehydes and ketones in human's body

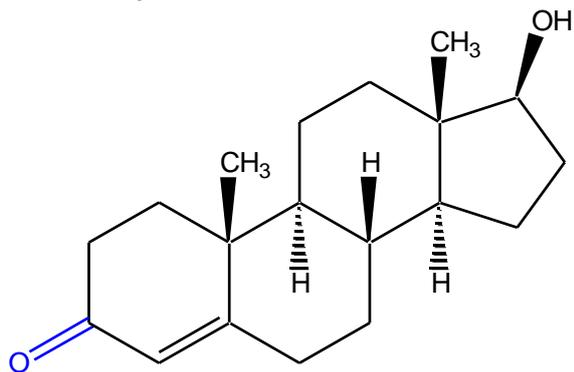

Testosterone
male sex hormone

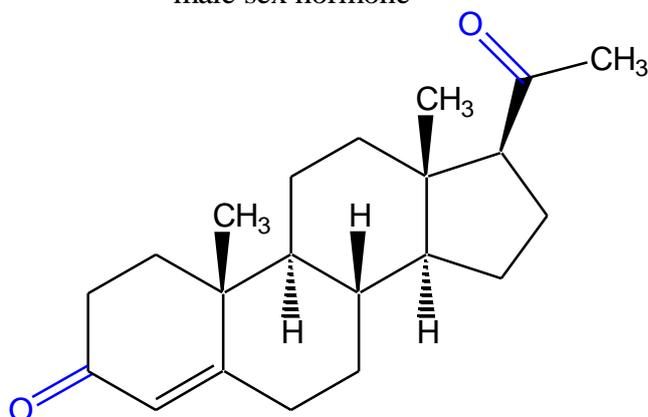

progesterone
female sex hormone

Aldehydes and ketones functional group are found in humans hormones like progesterone, testosterone.

6.7. End unit assessment

1. An aliphatic aldehyde **A** has the formula $RCHO$.
 - a. **A** reacts with 2,4-dinitrophenylhydrazine. Explain what happens and name the type of reaction.
Say how the product of reaction could be used to identify **A**
 - b. When **A** is treated with warm, acidified $K_2Cr_2O_7$ solution, **B** is formed. Give the structural formula of **B**.
 - c. When **A** is treated with lithium tetrahydridoaluminate (reducing agent) in ethoxyethane solution
C is formed. Give the structural formula of **C**.
 - d. **A** is warmed gently with ammoniacal silver nitrate. Explain what happens, and say what is observed.
 - e. **B** and **C** react to form **D**. Write the structural formula of **D**.
 - f. From the compounds **A**, **B**, **C**, and **D**, which would you predict to possess:
 - i. Highest boiling point

ii. Lowest boiling point

2.

a. Three compounds **E**, **F**, and **G** all have the molecular formula C_3H_6O . **E** is an alcohol, **F** is ketone and **G** is aldehyde.

i. Draw all possible structural formulae for **E**, **F**, and **G**.

ii. Describe tests (reagents, conditions and observations with each compound) that would allow you to show that.

1. **E** is an alcohol whereas **F** and **G** aren't

2. **F** and **G** are carbonyl compounds whereas **E** isn't

3. **G** is aldehyde, whereas **E** and **F** aren't.

4. Write balanced equations for all reactions that occur.

b. One of the compounds responsible for the flavor of butter is butan-2,3-dione.

i. Give the structural formula of butan-2,3-dione.

Give the structural formula of the organic products formed when butan-2,3-dione reacts with

i. H_2/Ni

ii. I_2/OH^-

3.

Carbonyl compounds **X** undergoes the following reactions

X gives an orange precipitate with 2, 4-dinitrophenylhydrazine.

X gives pale yellow precipitate with mixture of potassium iodide and sodium iodate (I)

X Doesn't react with warm acidified $K_2Cr_2O_7$ solution.

X doesn't react with aqueous bromine.

X is reduced by hydrogen in the presence of catalyst to a mixture of isomers **Y** and **Z** of formula $C_4H_{10}O$. Identify **X**, and give the structural formulae of **X**, **Y** and **Z**.

4.

P has the formula $C_5H_8O_2$. It forms a compound by reaction with hydrogen cyanide which has the formula $C_7H_{10}O_2N_2$. **P** gives a positive iodoform test, a silver mirror with Tollens' reagent and can be reduced to pentane. What is **P**?

5.

a) The carbon-oxygen double bond present in aldehydes and ketones is very polar. What does this mean and how does it arise?

b) The carbon-oxygen double bond is readily attacked by nucleophiles like cyanide ions or ammonia.

(i) What do you understand by the term *nucleophile*?

(ii) Which part of the carbon-oxygen double bond is attractive to nucleophiles?

6.

Warfarin is an oral anticoagulant, a drug that inhibits the clotting of blood. It prevents the formation of blood clots by reducing the production of factors by the liver that promote clotting, factors II, VII, IX, and X, and the anticoagulant proteins C and S. The structural formula of Warfarin is:

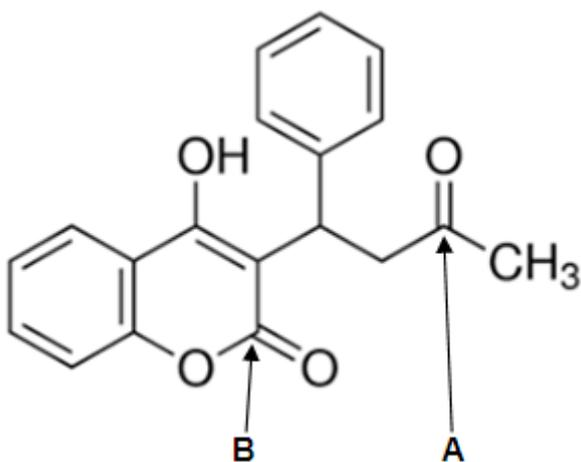

- a. Name any three different functional groups present in the Warfarin molecule
- b. State what would be expected to be observed if warfarin is treated under appropriate conditions with each of the following reagents. In each case give a reason for your prediction
 - i. Bromine in tetrachloromethane in absence of Lewis acid.
 - ii. Iodine and aqueous solutions of NaOH.
- c.
 - i. The structural shows two $>C=O$ groups the carbon atoms of which are labeled **A** and **B**. State how many molecules of 2, 4-dinitrophenylhydrazine would react with one molecule of Warfarin. Give a reason for your answer.
 - ii. State, giving a reason, whether you would expect Warfarin to reduce Tollens reagent.

UNIT 7. CARBOXYLIC ACIDS AND ACYL CHLORIDES

Key unit competency:

The learner should be able to compare the chemical nature of the carboxylic acids and acid halides to their reactivity

Learning objectives

- Explain the physical properties and uses of carboxylic acids and acyl chlorides
- Describe the inductive effect on the acidity of carboxylic acid
- Explain the reactions of carboxylic acids and acyl chlorides
- Apply the IUPAC rules to name different carboxylic acids acyl chlorides
- Write the structural formula and isomers of carboxylic acids
- Distinguish between carboxylic acids from other organic compounds using appropriate
 - chemical test
 - Prepare carboxylic acids from oxidation of aldehydes or primary alcohols

- Compare the physical properties of carboxylic acids to those of alcohols
- Outline the mechanisms of esterification and those of reaction of acyl chlorides with ammonia, amines and alcohols
- Develop a culture of working as a team group activities and self-confidence in presentation
- Appreciate the uses of carboxylic acids as the intermediate compounds in industrial processes such as aspirin, vinegar and perfumes

Introductory activity



1. You have certainly drunk and tasted fresh milk and fresh banana juice or any other fruit juice. What happens if the milk or juice stays for a long time: how does it taste? Can you explain the change?
2. After an ant's sting, you feel a prolonged pain and sometimes the part of the body that was stung swells.
 - a) Explain the reasons of these observations and sensations
 - b) Is there any other substance that accompanies the ant's stings?
3. Lemon juice and vinegar, both have a sour taste and they can be used in treatment of salad before they are eaten.
 - a) Why are they used for this purpose?
 - b) Which chemical substance do they have in common that is responsible for this sour taste?
 - c) Identify the part that is common in the structures of the main chemical responsible for their sour taste.

Carboxylic acid is classified in the family of organic compounds due to the presence of a carboxyl group (-COOH) in their chemical formula. The general formula for carboxylic acids is R-COOH where R- refers to the alkyl group of the molecule.

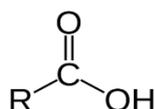

Carboxylic acids naturally occur in different substances that we normally encounter in our daily life and are also used to make various useful materials. For instance, lemons taste sour because they contain citric acid and ant stings are painful because they are followed by an injection of formic acid in the stung part of the body.

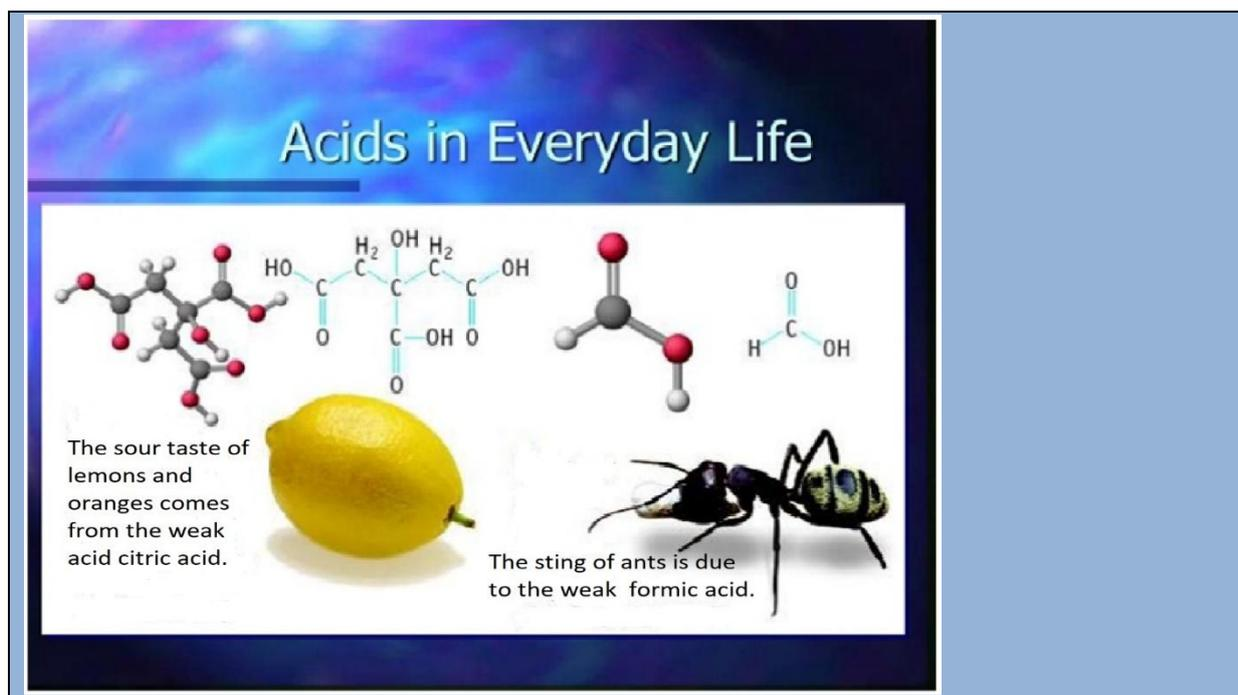

Figure 7.1. Examples of occurrence of carboxylic acids in living organisms

7.1. Nomenclature and isomerism

Activity 7.1

1. With help of the general rules of naming organic compounds, studied in unit 1, suggest the IUPAC names of the following compounds.
 - a) $\text{CH}_3\text{-COOH}$
 - b) $\text{CH}_3\text{-CH}(\text{CH}_3)\text{-COOH}$
 - c) HCOOH
 - d) $\text{HOOC-CH}_2\text{-COOH}$
 - e) $\text{CH}_3\text{-CH}_2\text{-CH}(\text{CH}_3)\text{-COOH}$
2. Find the structures that correspond to the systematic names below
 - a) 2,2-dimethylpropanoic acid
 - b) 3-methylbutanoic acid
3. You are provided with molecular formulae of different organic compounds: $\text{C}_2\text{H}_4\text{O}_2$, $\text{C}_3\text{H}_6\text{O}_2$. Identify all possible isomers of these compounds.
4. A student was given two samples of enantiomers; L-lactic acid and D-lactic acid, which are both colorless liquids.
 - a. How are these two isomers related?
 - b. Briefly describe how the two samples can be distinguished so that they can be properly labeled.

7.1.1. Nomenclature

Carboxylic acids are named by following the general rules of naming organic compounds, where the suffix 'oic acid' is added to the stem name of the longest carbon chain that contains the acid functional group. The side branches are also positioned by starting from the carbon with carboxylic functional group.

The carboxylic group takes priority to other functional group when numbering carbons in the case of substituted chain.

Table 7.1: Nomenclature of carboxylic acids

Formula	Systematic name	Common name
HCOOH	Methanoic acid	formic acid
CH_3COOH	Ethanoic acid	acetic acid
$\text{CH}_3\text{-CH}_2\text{-COOH}$	Propanoic acid	propionic acid
$\text{CH}_3\text{-(CH}_2)_2\text{-COOH}$	Butanoic acid	butyric acid
$\text{CH}_3\text{-(CH}_2)_{10}\text{-COOH}$	Dodecanoic acid	lauric acid

$\text{CH}_3(\text{CH}_2)_{12}\text{COOH}$	Tetradecanoic acid	myristic acid
$\text{CH}_3(\text{CH}_2)_{14}\text{COOH}$	Hexadecanoic acid	palmitic acid
$\text{CH}_3(\text{CH}_2)_{16}\text{COOH}$	Octadecanoic acid	stearic acid

For diacids, the suffix of the IUPAC name becomes '**dioic acid**'. They have a general formula of $\text{HOO-C}_n\text{H}_{2n}\text{-COOH}$.

Table 7.2: Nomenclature of carboxylic acids with two carboxyl groups

Formula	Systematic name	Common name
HOOC-COOH	Ethanedioic acid	Oxalic acid
$\text{HOOC-CH}_2\text{-COOH}$	Propanedioic acid	Malonic acid
$\text{HOOC-CH}_2\text{-CH}_2\text{-COOH}$	Butanedioic acid	Succinic acid
$\text{HOOC-(CH}_2)_4\text{-COOH}$	Hexanedioic acid	Caproic acid or adipic acid
$\text{HOOC-(CH}_2)_8\text{-COOH}$	Decanedioic acid	Sebacic acid

Unsaturated acids (alkenoic acids) are systematically named by changing the stem suffix '**-an**' to '**-en**'.

Table 7.3: Nomenclature of unsaturated carboxylic acids

Formula	Systematic name	Common name
$\text{CH}_2=\text{CH-COOH}$	Prop-2-enoic acid	Acrylic acid
$\text{CH}_3\text{-CH=CH-COOH}$	But-2-enoic acid	Crotonic acid
$\text{CH}_2=\text{C}(\text{CH}_3)\text{-COOH}$	2-methylprop-2-enoic acid	Metacrylic acid
$\text{CH}_3\text{-(CH}_2)_7\text{-CH=CH-(CH}_2)_7\text{-COOH}$	Octadec-9-enoic acid	Oleic acid

Hydroxy-acids are named by considering -hydroxyl group as a substituent on the longest carbon chain that contains carboxylic functional group.

Table 7.4: Nomenclature of hydroxy-acids

Formula	Systematic name	Common name
$\text{HOCH}_2\text{-CH}_2\text{-COOH}$	3-hydroxy-propanoic acid	β -lactic acid

$\text{CH}_3\text{-CHOH-COOH}$	2-hydroxypropanoic acid	α -Lactic acid
$\text{HOCH}_2\text{-CHOH-COOH}$	2,3-dihydroxypropanoic acid	Glyceric acid
HOOC-CHOH-COOH	Hydroxypropanedioic acid	Malic acid
$\text{HOOC-CHOH-CHOH-COOH}$	Dihydroxybutanedioic acid	Tartaric acid

7.1.2. Isomerism

Carboxylic acids show diverse types of isomers either among themselves or with other compounds that have different functional groups:

• Chain isomers

Chain isomers have the same molecular formula and they differ in the longest carbon chain (carbon backbone) of the molecule.

Example: $\text{CH}_3\text{-CH}_2\text{-CH}_2\text{-COOH}$ (butanoic acid) and $\text{CH}_3\text{-CH}(\text{CH}_3)\text{-COOH}$ (2-methylpropanoic acid) are chain isomers of $\text{C}_4\text{O}_2\text{H}_8$

Functional isomers with esters

Functional isomers have the same molecular formula and they differ from the functional groups that are found in the structure of the molecule.

Example: $\text{CH}_3\text{-CH}_2\text{-COOH}$ (propanoic acid) and $\text{CH}_3\text{-COO-CH}_3$ (methyl ethanoate) are functional isomers of $\text{C}_3\text{O}_2\text{H}_6$.

• Optical isomers

Optical isomers have the same molecular formula and the same structural formula, but they are different in the spatial arrangement of atoms and their optical properties. An organic compound shows optical isomerism, when there is **chiral carbon** (a carbon atom attached to four diverse groups) in its structure. A chiral carbon is also known as **asymmetric carbon**.

For example, lactic acid can exist in two isomers that are mirror images of one other and they cannot be superimposed on each other. This is caused by the molecule which has an asymmetric carbon.

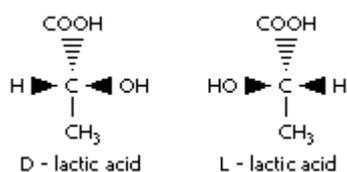

Just as the right hand and left hand are mirror images of another but not superimposable, optical isomers, also known as enantiomers, are different from each other and can have

different properties. For example, muscles produce D-lactic acid when they contract, and a high amount of this compound in muscles causes muscular pain and cramps.

These molecules are optical isomers, because they have opposite optical activities. They can be distinguished by a plane-polarized light where one enantiomer rotates the light to the right while the other rotates it to the left.

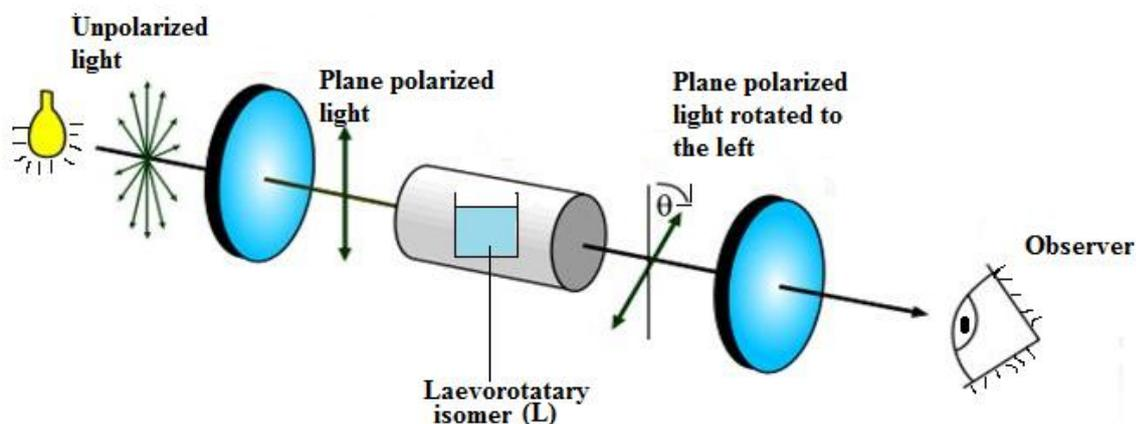

Figure 7.2. Levorotatory (L) isomer rotates plane polarized light to the left

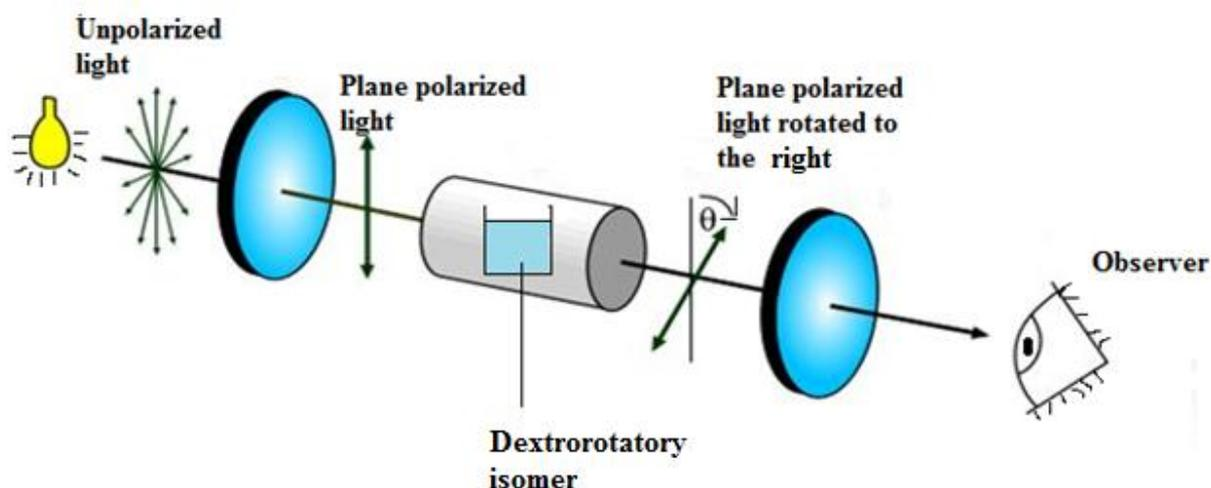

Figure 7.3. Dextrorotatory (D) isomer rotates plane polarized light to the right

Enantiomers are often identified as D- or L- prefixes because of the direction in which they rotate the plane polarized light as shown in figures 7.2 and 7.3. Enantiomers that rotate plane polarized light in clockwise direction are known as dextrorotatory (right-handed) molecules and enantiomers that rotate plane polarized light in anticlockwise direction are known as levorotatory (left-handed) molecules.

A solution containing equal amounts of enantiomers, 50% levorotatory and 50% dextrorotatory is known as a racemic mixture that will not rotate polarized light, because the rotations of the two enantiomers cancel each other out.

Checking up 7.1.

- Write the structures of the following compounds:
 - 2,3-Dimethylpentanoic acid
 - 2-Methylhexanedioic acid
- Give the IUPAC names of the organic acids below:
 - $\text{CH}_3\text{-CH}(\text{CH}_3)\text{-CH}=\text{CH-CH}_2\text{-CH}_2\text{-COOH}$
 - $\text{CH}_3\text{-CH}(\text{OH})\text{-CH}_2\text{-COOH}$
- Identify the type of isomers that are in the following group of compounds:
 - $\text{CH}_3\text{-CH}_2\text{-CH}(\text{CH}_3)\text{-CH}_2\text{-COOH}$ and $\text{CH}_3\text{-CH}_2\text{-COO-CH}(\text{CH}_3)_2$
 - $\text{CH}_3\text{CH}_2\text{CH}_2\text{CH}_2\text{COOH}$ and $\text{CH}_3\text{C}(\text{CH}_3)_2\text{COOH}$
- Explain which of the compounds below is/are optically active: 2-hydroxybutanoic acid, 3-hydroxybutanoic acid, 2-methylpropanoic acid and 2-methylbutanoic acid.

7.2. Physical properties of Carboxylic acids

Activity 7.2

- Imagine a scenario of two balls tied together by a metallic wire and other two balls attached to one another by a thin banana leaf rope. If you are asked to separate them by breaking what ties them together; explain in which case it will require much energy.
- Use a diagram to explain the type of intermolecular forces that hold molecules of carboxylic acids together.
- How do you compare the melting and boiling points of carboxylic acids and alcohols which have the same number carbon atoms? From your research give supporting examples with relevant experimental values.

a. Physical state

Many carboxylic acids are colorless liquids with disagreeable odors. Aliphatic carboxylic acids with 5 to 10 carbon atoms are all liquids with a “goaty” odors (odor of cheese). These acids are also produced by the action of skin bacteria on human sebum (skin oils), which accounts for the odor of poorly ventilated storerooms. The acids with more than 10 carbon atoms are wax-like solids, and their odor diminishes with increasing molar mass and resultant decreasing volatility. Anhydrous acetic acid freezes at (17°C) slightly below ordinary room temperature, reason why it is called **glacial acetic acid** (Figure 7.4). But a mixture of acetic acid with water

solidifies at much lower temperature.

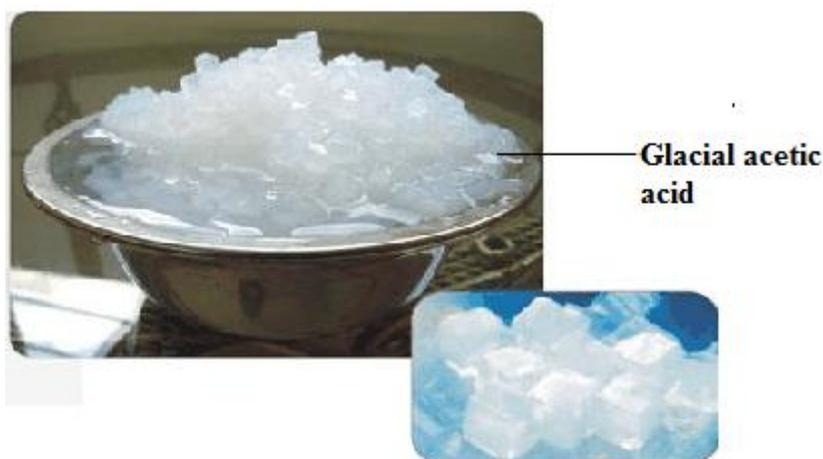

Figure 7.4. Glacial ethanoic acid at 17⁰C

b. Melting and boiling point

Carboxylic acids show a high degree of association through hydrogen bonding. Because of this, they have high melting and boiling points compared to other organic compounds of the same mass or number of carbon atoms.

Table 7.6: Comparison of melting and boiling points of carboxylic acids and alkanes

Formula	Molar mass (g/mol)	Melting point (⁰ C)	Boiling point (⁰ C)
HCOOH	46	8	100.5
CH ₃ CH ₂ CH ₃	44	-190	-42
CH ₃ COOH	60	17	118
CH ₃ CH ₂ CH ₂ CH ₃	58	-138	-0.5

Carboxylic acids have high melting and boiling points because their hydrogen bonds enhance the possibility of bringing two acid molecules together by forming a kind of **dimer**.

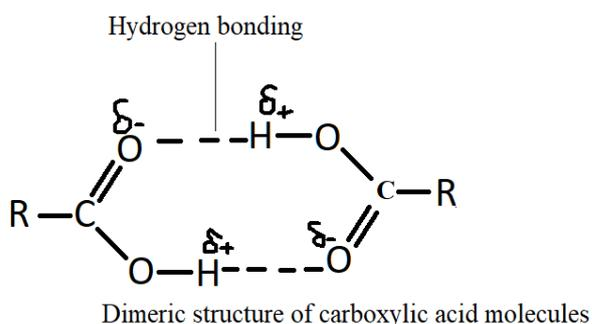

Figure 7.5. Carboxylic acids form hydrogen bonds in a dimeric structure

c. Solubility

The carboxyl group readily engages in hydrogen bonding with water molecules (Figure 7.3). The acids with one to four carbon atoms are completely miscible with water. Solubility decreases as the carbon chain length increases because of increasing of the non-polar hydrocarbon chain which is insoluble in water. Hexanoic acid $\text{CH}_3(\text{CH}_2)_4\text{COOH}$ is slightly soluble in water. Palmitic acid $\text{CH}_3(\text{CH}_2)_{14}\text{COOH}$, with its large non polar hydrocarbon part, is essentially insoluble in water. The carboxylic acids generally are soluble in organic solvents such as ethanol, toluene, and diethyl ether.

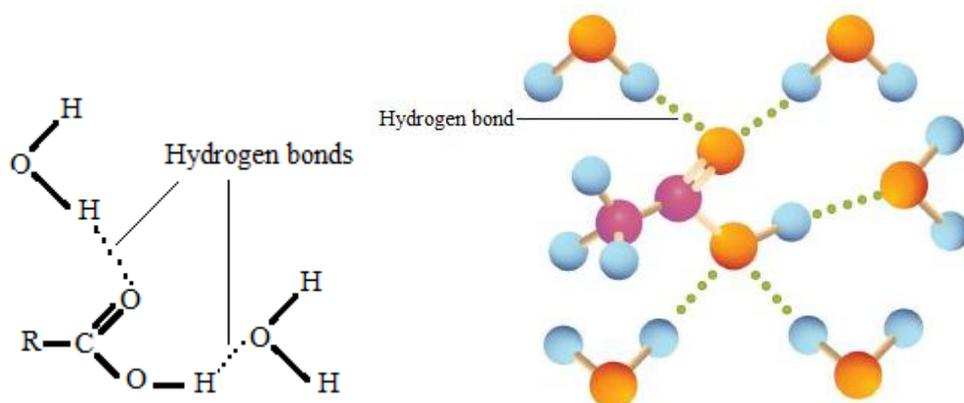

Figure 7.6. Carboxylic acids form hydrogen bonds with molecules of water

Checking up 7.2.

1. How do you compare the melting points of hexadecanoic acid and octadecanoic acid?
2. Butanoic acid has molar mass of 88 and pentan-2-one has a molar mass of 86. Which of these compounds has the higher boiling point? Explain.
3. Would you expect butyric acid (butanoic acid) to be more soluble than butan-1-ol in water? Explain.

7.3. Acidity of carboxylic acids

Activity 7.3.

1. What characterizes acidic substances?
2. Explain what is meant by;
 - a) Arrhenius acid.
 - b) Bronsted-Lowry acid
 - c) Lewis acid

3. Explain which acid-base theory explains properly the acidity of carboxylic acids.

4. Experiment

To test for the acidic properties of carboxylic acids.

Materials

- Test tubes and test tube rack
- Dropper

Chemicals

- Ethanoic acid/ vinegar (0.1M)
- Distilled Water
- Dilute HCl (aq) solution (0.1M)
- Methyl orange indicator/ Blue litmus paper/Red litmus paper

Procedure

1. Take about 5cm³ of distilled water in a test tube
2. Test it with the indicator provided and note your observations.
3. To 5cm³ of distilled water add 2-3 drops of ethanoic acid and note your observations; repeat the same test in steps 1 to 3 for HCl (aq).
4. Analyze your findings and try to draw relevant conclusions.

Solutions of carboxylic acid turn blue litmus paper red; they do not change the color of red litmus paper; therefore, they are acids as other mineral acids such as HCl (aq).

Organic or carboxylic acids are weak acids in opposition to some mineral acids such as hydrochloric acids which are strong acids. According to Arrhenius' theory of acids and bases, strong acids dissociate completely in water to give hydrogen ion, H⁺(aq) or H₃O⁺, whereas weak acids dissociate partially. The hydrogen ion released combines with a water molecule to form H₃O⁺ a hydrate positive ion called hydronium H₃O⁺:

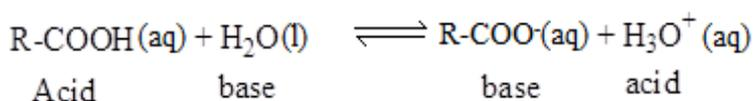

The carboxylate ion formed by ionization of the acid is more stable than the acid because it has many resonance structures.

Ethanoic acid is a weaker acid than methanoic because its methyl group has a **positive inductive effect**; that is to mean that it pushes electrons towards the O-H bond hence make

hydrogen ion stable and not easily leaving.

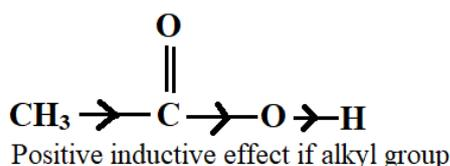

The greater the number of such groups, the greater the effect and therefore the weaker will be the acid. For example, 2,2-dimethylpropanoic is weaker than 2-methylpropanoic acid which is in turn weaker than propanoic.

The same rule applies to the increase in the length of the alkyl group chain. Butanoic acid is a weaker acid than propanoic acid which shows that the acidity strength decreases as the alkyl chain increases.

On the other hand, when an electron withdrawing group (a group with a **negative inductive effect**) is present, the opposite effect is observed. For example, chloroethanoic acid is a stronger acid than ethanoic acid. This is because chlorine being electronegative, will withdraw electron towards itself thus reducing the electron density around the O-H bond thus weakening it. It causes O-H bond to easily break, and the concentration of hydrogen ions will be high in the solution.

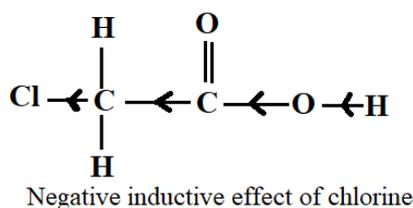

The more the number of groups with negative inductive effect, the greater is the effect and hence the more acidic will be the solution. Trifluoroacetic acid is more acidic than trichloroacetic, dichloroacetic, chloroacetic and acetic acid because fluorine is more electronegative than chlorine and hydrogen. It will strongly withdraw electron towards itself, hence makes easier for the proton to leave.

It must also be noted that the further away the electronegative element, the less the effect. For example, 3-chlorobutanoic acid is therefore a weaker acid than 2-chlorobutanoic acid.

Checking up 7.3

1. Explain the reasons of the following observations:
 - a) Propanoic acid releases more hydrogen ions in solution than 2-methyl propanoic acid.
 - b) Fluoroethanoic acid is stronger than ethanoic acid.
2. Consider the molecules in the following table, analyze them and rank the following acids according to increasing order of their acidity strength as 1, 2, 3 and 4. Give reasons for

your answer	
Molecule	Ranking
2-chlorobutanoic acid	
3-chlorobutanoic acid	
4-chlorobutanoic acid	
Butanoic acid	

7.4. Preparation of carboxylic acids

Activity 7.4

- We normally prepare or manufacture substances because we need them in our daily life to solve some of the problems that we have. Are carboxylic acids useful to us?
- Now that we accept that carboxylic acids are in the category of organic compounds that are widely used in our daily life; either in industry or in our household activities. Since they are needed, they must be obtained from somewhere.
 - Suggest diverse ways carboxylic acids can be obtained.
 - Describe how acetic acid that is used to make vinegar can be prepared.

Carboxylic acids are common and vital functional group; found in amino acids, fatty acids etc. and provide the starting raw material for acid derivatives such as acyl chlorides, amides, esters and acid anhydrides. There are several methods of preparation of carboxylic acids where the most common are discussed in this section.

7.4.1. From primary alcohols and aldehydes

Different carboxylic acids can be prepared by oxidation of either primary alcohols or aldehydes. In the process, the mixture of alcohol is heated under reflux with an oxidizing agent such acidified potassium permanganate or potassium dichromate. Primary alcohols are first oxidized to aldehydes then further oxidation of aldehydes produces carboxylic acid.

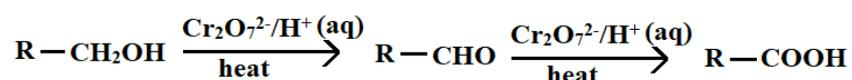

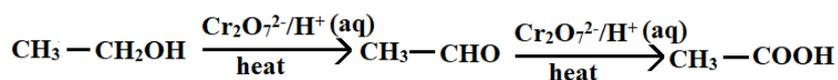

In fact, when excess oxidizing agents like acidified $\text{K}_2\text{Cr}_2\text{O}_7$ or KMnO_4 are used, primary alcohols are oxidized to carboxylic acids.

7.4.2. Hydrolysis of acid nitriles and amides with acid or alkali

When nitriles are hydrolyzed by water in acidic medium and the mixture is submitted to heat, the reaction yields carboxylic acids.

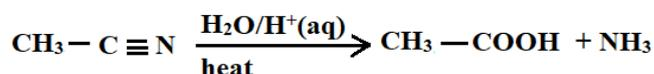
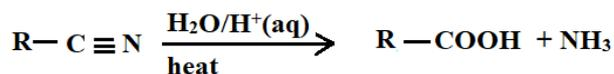

The preparation of carboxylic acids from nitriles passes through formation of amide as an intermediate product and further hydrolysis leads to the formation of carboxylic acid.

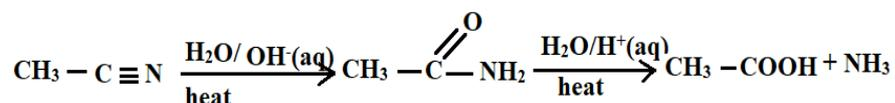
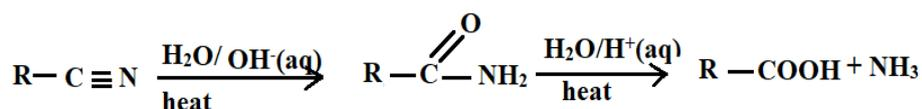

7.4.3. From dicarboxylic acid

Monocarboxylic acids can be prepared by heating dicarboxylic acids which have two carboxylic functional groups attached to the same carbon atom.

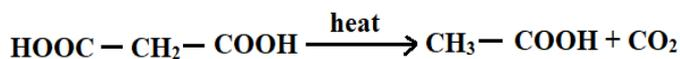
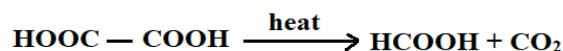

Note that the reaction is used to reduce length of the carbon chain. The mono carboxylic acid prepared has one carbon atom less than the starting dicarboxylic acid.

7.4.4. From organomagnesium compounds (Carboxylation reaction)

Grignard reagents react with carbon dioxide gas, and when the intermediate compound formed is hydrolyzed it finally forms carboxylic acid.

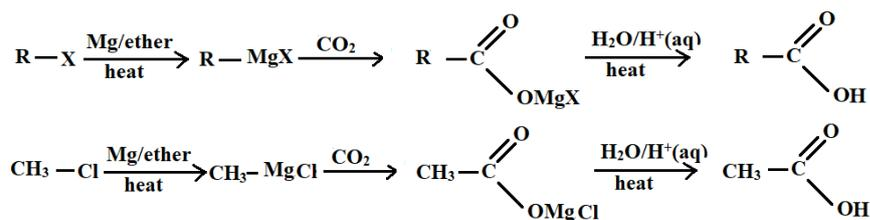

Mechanism:

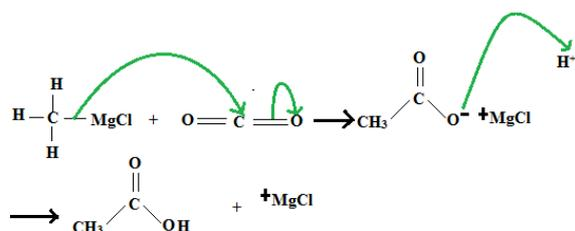

It should be noted that this method of preparation yields a carboxylic acid with one carbon atom more than the starting alkyl halide.

7.4.5. From alkenes (Oxidation of alkenes)

Carboxylic acids are also obtained by heating alkenes with concentrated acidified potassium permanganate. The reaction unfortunately forms a mixture of compounds that must be later separated.

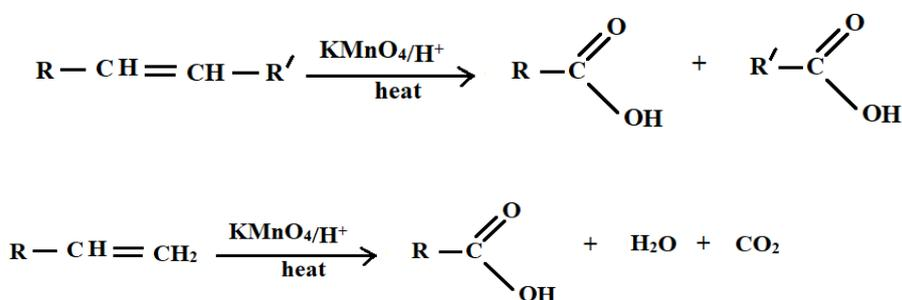

Note that the hydrolysis of carboxylic acid derivatives such as amide, esters, acyl chloride and acid anhydrides also produce the corresponding acids.

7.4.6. Laboratory preparation of acetic acid

Acetic acid can be prepared in the laboratory.

- From its salt:

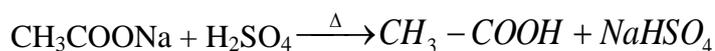

Or

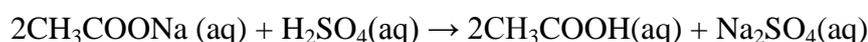

- From acetylene:

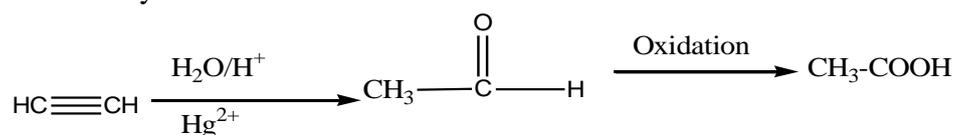

- From ethanol:

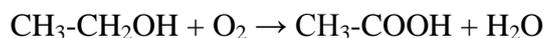

Checking up 7.4

1. Describe how the following interconversions can be carried out in one or more than one steps:
 - a) Propanoic acid from monobromoethane
 - b) Propanoic acid from ethanol
2. When banana wine (the wine obtained locally from the fermented juice from ripe banana stays for some time its taste becomes sour. Explain these observations by a chemical reaction.

7.5. Reactions of carboxylic acids

Activity 7.5

1. Carboxylic acids are starting materials for the synthesis of many other important organic substances such as esters used to make sweets and wines, acetic anhydrides used to make aspirin, etc. Explain the reason why it is possible to transform carboxylic acids into other compounds. What property of carboxylic acids is exploited in this regard?
2. Fatty acids are some of the raw materials used in the manufacture of soaps. How is this possible, to convert fatty acid into these important cleansing agents?
3. Complete the following reaction:

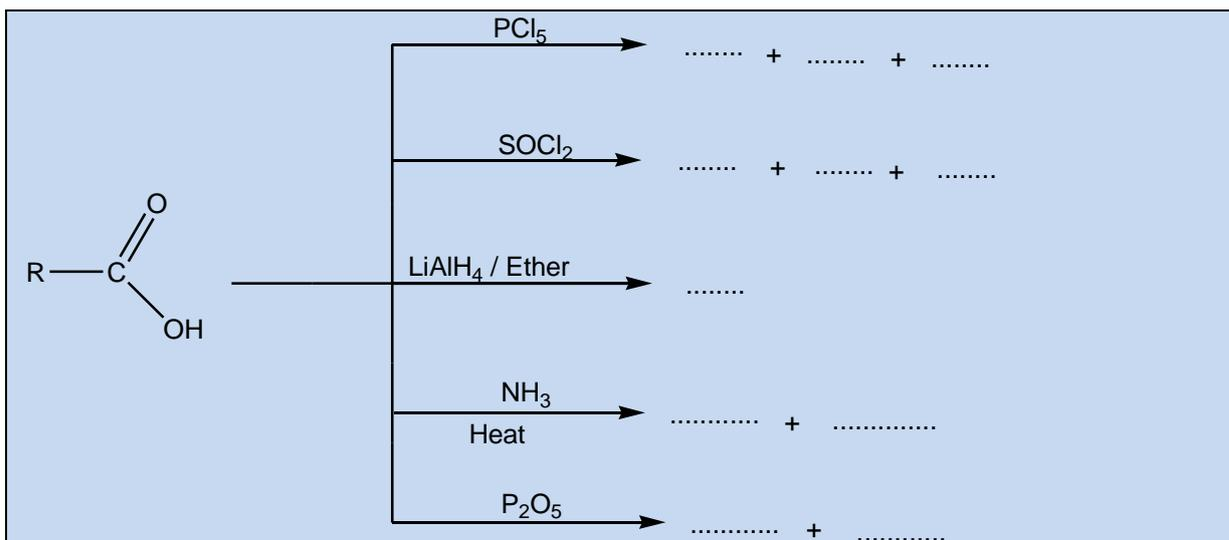

3. Experiment

Materials

- 2 Test tubes
- Rubber stopper
- A delivery tube

Chemicals:

- Sodium carbonate
- Acetic acid
- Lime water

Procedure

1. Put an end full spatula of sodium carbonate in a test tube
2. Add about 10cm^3 of acetic acid solution
3. Immediately close it with a rubber stopper joined to a delivery, already immersed in lime water, as in the diagram below.
4. Note all your observations.

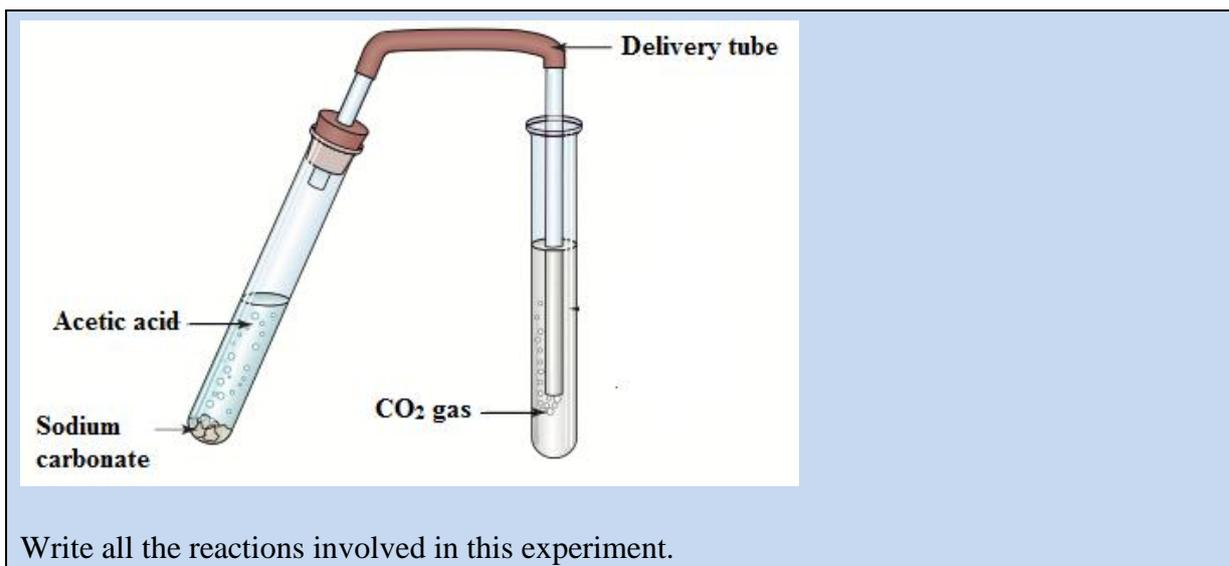

Carboxylic acids are reactive, and their reactions are classified into:

- Reaction involving $-H$ of hydroxyl group $O-H$ (i.e. reaction as acids)
- Reaction involving $-O-H$ group of carboxylic acid (i.e. nucleophilic substitution reactions).

- Reaction involving carbonyl group $\begin{array}{c} O \\ || \\ C \end{array}$ (reduction reaction to alcohols)

7.5.1. Reaction involving proton release of acidic $O-H$ group

Carboxylic acids react with reactive metals, metal oxide, sodium carbonate, sodium hydrogen carbonate, NH_4OH and alkalis. These are typical reactions as acids.

1. Reaction with metals

Carboxylic acids react with reactive metals to form salts of carboxylic acids and hydrogen gas. For example, acetic acid reacts with sodium metal to form sodium acetate and hydrogen gas.

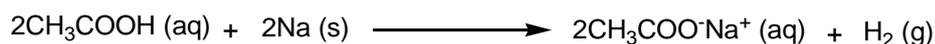
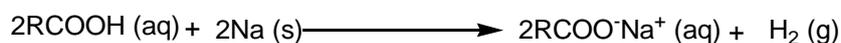

2. Reaction with alkali solutions

Strong alkalis such as sodium hydroxide react with carboxylic acids by the process of neutralization that forms salts of carboxylic acids and water.

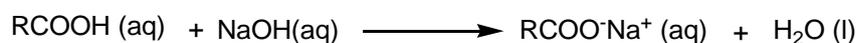

3. Reaction with sodium carbonate and sodium hydrogencarbonate

Like other mineral acids, carboxylic acids react with carbonates and bicarbonates of metals to form salts, water and carbon dioxide. The reaction is followed by observable effervescence (bubbles of carbon dioxide in the solution) in figure 7.5.

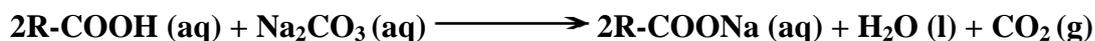

Example:

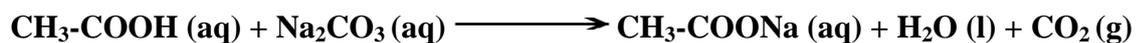

Figure 7.7. Effervescence when acetic acid is added to sodium carbonate

The reaction of acids with carbonates is the basis for the chemical test of carboxylic acid functional group and it can be used to distinguish carboxylic acids from other functional groups in qualitative analysis.

Carbon dioxide produced is also tested by lime water and it turns lime water milky (Figure 7.8)

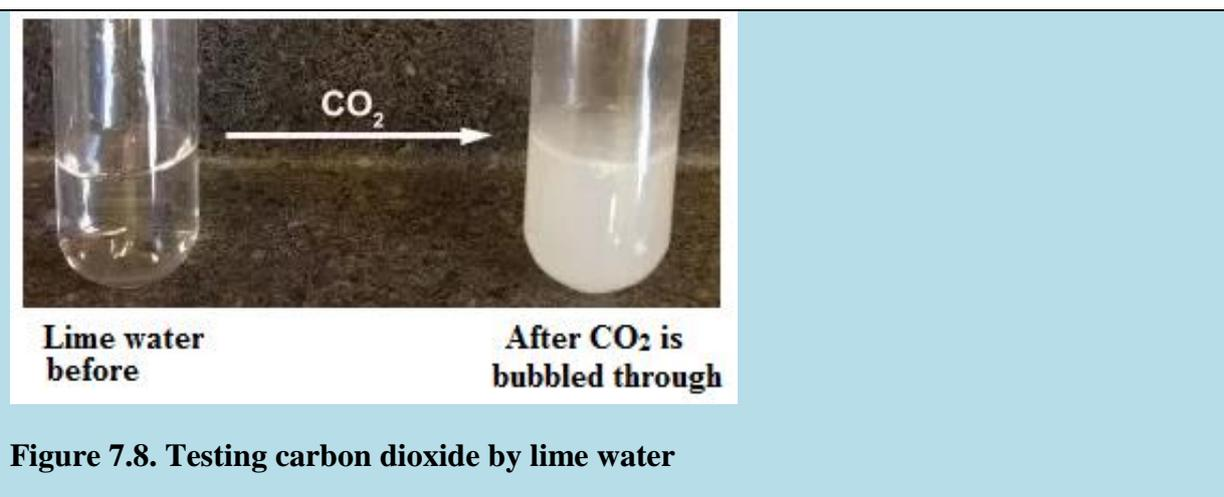
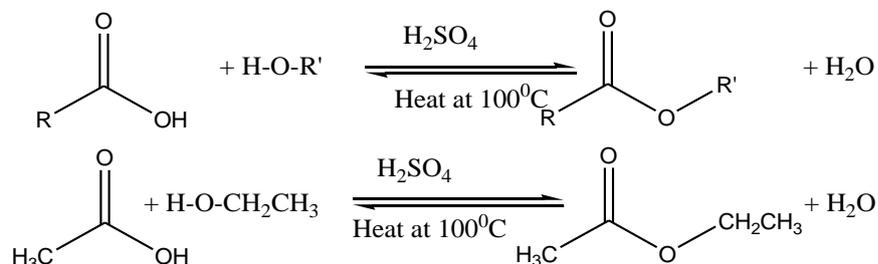

Figure 7.8. Testing carbon dioxide by lime water

7.5.2. Reaction involving the whole group -O-H

1^o. Reaction with alcohols (Esterification)

Carboxylic acids react with alcohols to form esters and the reaction is known as esterification reaction. The reaction requires heating under reflux and in the presence of concentrated H_2SO_4 . It is a reversible reaction because all the reactants are not converted into products.



The mechanism of esterification reaction:

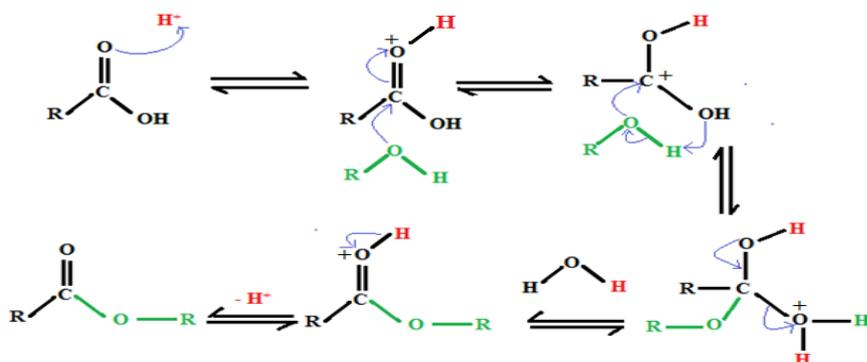

It is noted that the oxygen atom in the ester formed comes from the alcohol and the one in water is from the acid. In the mechanism of esterification, the acid loses -OH group while the alcohol loses H-atom.

2^o. With phosphorus halides, thionyl chloride

Due to the presence of -OH group in carboxylic acids, like alcohols, they react with PCl_5 and SOCl_2 and the organic product is acyl chloride. This is the basis reaction of the synthesis of acyl chlorides from carboxylic acids.

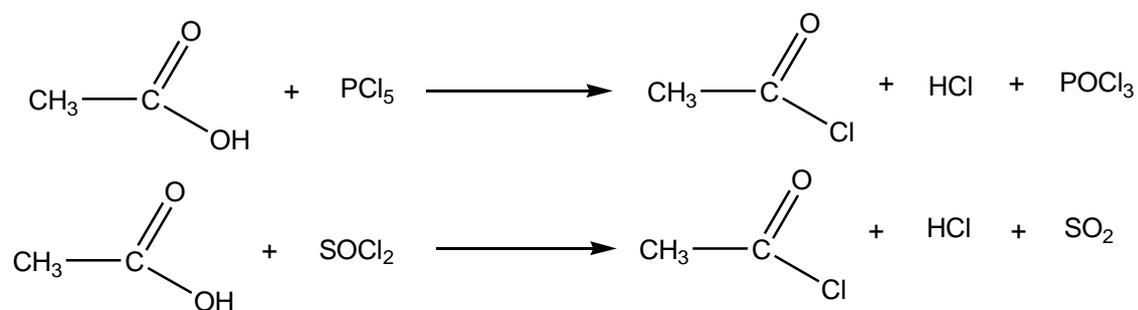

3. Reaction with phosphorous pentoxide

Carboxylic acids molecules can be dehydrated by phosphorous pentoxide to yield corresponding acid anhydrides.

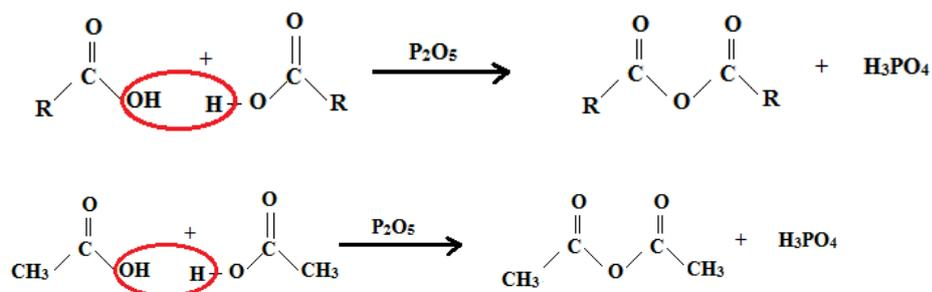

7.5.3. Reduction of carboxylic acids

Carboxylic acids are reduced to primary alcohols on treatment with reducing agent such as LiAlH_4 in dry ether or by use of hydrogen in the presence of Ni catalyst. The reduction does not form aldehyde as an intermediate product, like in oxidation of primary alcohols.

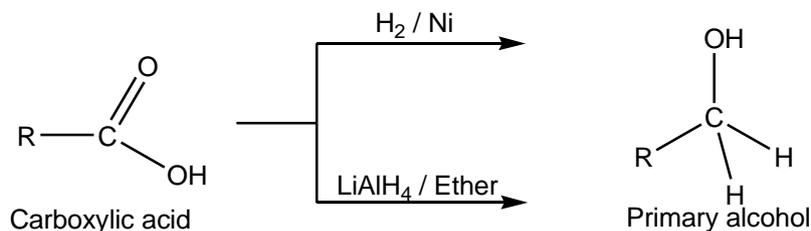

Checking up 7.5

1. Explain the following observations:

- Sodium hydroxide dissolves in acetic acid, but it does not dissolve in ethanol
- A student took a 10cm^3 of 0.1mol dm^{-3} potassium hydroxide solution, she/he then added 2 drops of phenolphthalein and the solution turned purple. When she/he added 10cm^3 of 0.1mol dm^{-3} ethanoic acid the mixture of solutions turned colorless.

2. Complete the following reactions:



b)

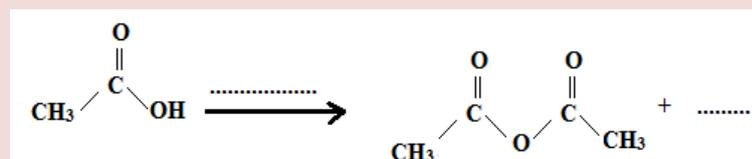

c)

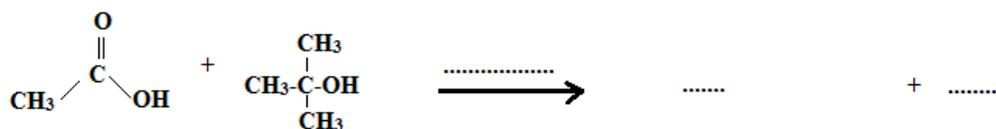

3. A student called Mugabo, in the chemistry laboratory was having samples of chemicals which were not labeled. In one beaker he had 50cm³ of acetic acid and in another beaker, he had 50cm³ of ethanol and then he mistakenly mixed up the beakers. To find out how he could identify them properly, called his colleague Keza to exchange ideas. Explain how you would help Mugabo if you were Keza.

4. Describe the chemical test that can be used to distinguish the following pairs of compounds:

- Ethanoic acid and 2-methylpropan-2-ol
- Ethanoic acid and phenol

7.6. Uses of carboxylic acids

Activity 7.6

Observe the following images and answer the questions related.

The activity shows six images with labels:

- Rubber tyre**: A stack of black rubber tyres.
- Soap**: A bar of light green soap with the word 'SOAP' embossed on it.
- Candle wax**: A lit candle with a flame.
- Sodium benzoate**: A white powdery substance next to a packet labeled 'Sodium Benzoate'.
- Red wine**: A bottle of red wine and a glass filled with red wine.
- Aspirin**: A glass bottle of Aspirin tablets with several white tablets spilled out.

- Do you find any relationship between carboxylic acids and the manufacture process of each the substances represented in the above images?
- Suggest other instances where carboxylic acids are used in our daily life.

Carboxylic acids occur naturally in fats, acidic dairy and citrus fruits, and among their most important uses are:

Food industry and nutrition

- Food additives: Sorbic acid, benzoic acid, etc.
- Main ingredient of common vinegar (acetic acid).
- Elaboration of cheese and other milk products (lactic acid).

Pharmaceutical industry

- Antipyretic and analgesic (acetylsalicylic acid or aspirin).
- Active in the process of synthesis of aromas, in some drugs (butyric or butanoic acid).
- Antimycotic and fungicide (Caprylic acid and benzoic acid combined with salicylic acid).
- Active for the manufacture of medicines based on vitamin C (ascorbic acid).
- Manufacture of some laxatives (Hydroxybutanedioic acid).

Other industries

- Manufacture of varnishes, resins and transparent adhesives (acrylic acid).
- Manufacture of paints and varnishes (Linoleic acid).
- Manufacture of soaps, detergents, shampoos, cosmetics and metal cleaning products (Oleic acid).
- Manufacture of toothpaste (Salicylic acid).
- Production of dyes and tanned leather (Methanoic acid).
- Manufacture of rubber (Acetic acid).
- Preparation of paraffin candles (Stearic acid)

Checking up 7.6

Make a research and explain 5 uses of carboxylic acids either in our daily life or in industries.

7.7. Acyl chlorides and nomenclature

Activity 7.7

- Write the reaction between ethanoic acid and phosphorus pentachloride.
- What is the functional group in product of the reaction a)?
- How can this organic product be named?
- How is the nomenclature of the compound related to that of carboxylic acids?

Acyl halides are compounds with the general formula where the -OH group of carboxylic acid has been substituted by a halogen atom. The acyl remaining structure is represented as:

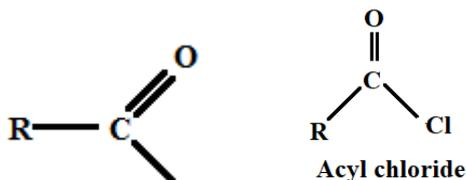

Acyl group

Examples: CH_3COCl : ethanoylchloride (acetyl chloride); $\text{C}_6\text{H}_5\text{COCl}$: benzoylchloride

They are named in the same way as carboxylic acids where the suffix ‘-ic acid’ of the acid is replaced by ‘ylchloride’. Like in carboxylic acids, in acyl chlorides side branches are given positions by starting from the acyl functional group.

Examples:

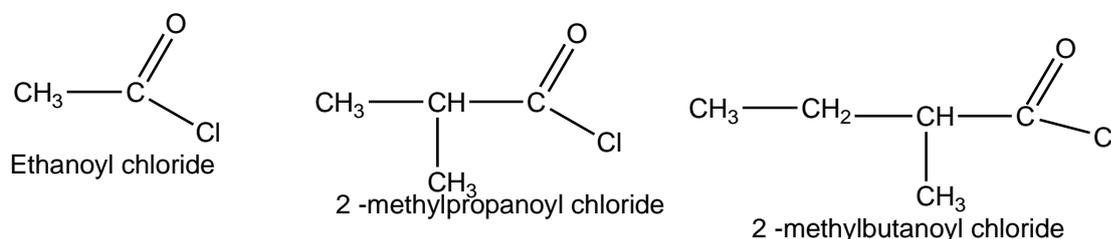

Their isomers can be chain isomerism, positional isomerism and functional isomerism with chloro aldehydes and ketones, alcohols with double bond $\text{C}=\text{C}$ and chlorine as a substituent, cyclic ethers with chlorine.

Acid chlorides have not many applications in our everyday life, but industrially they are used in synthesis of perfumes and nylons, which are polymers of high importance in textile industry. They can also be used in pharmaceutical industries to synthesize drugs with aromatic ester or amide functional groups like aspirin or paracetamol.

Checking up 7.7

1. Draw structures for the following.
 - a) Propanoyl chloride
 - b) Butanoyl chloride
 - c) 4-Methylpentanoyl chloride
 2. Answer by True or False. Also give relevant explanations for your answer in each case.
 - a) In naming acyl chlorides, side branches are given positions on the main chain from the opposite extremity to the acyl chloride functional group.
 - b) Acyl chloride can show optical isomerism.
2. Name this compound: $\text{CH}_3\text{-C}(\text{CH}_3)_2\text{CH}_2\text{COCl}$

7.7.1. Physical properties

Activity 7.7.1

Use the information about the structure and intermolecular forces to compare the physical properties (solubility, melting and boiling points) of carboxylic acids and acyl chlorides.

a. Appearance

Acyl chlorides are colourless fuming liquids. Their characteristic strong smell is caused by hydrogen chloride gas that is produced when they get in contact with moisture (see figure 7.7). For example, the strong smell of ethanoyl chloride is a mixture of vinegar odour and the acrid smell of hydrogen chloride gas.

b. Solubility

Acyl chlorides are slightly soluble in water due to their small dipole that can interact with the polarity of water molecule. They cannot be said to be soluble in water because they readily react with water. It is impossible to have a simple aqueous solution of acyl chlorides, rather we have the products of their reaction with water.

c. Boiling and melting points

Acyl chloride molecules interact by Van der Waals forces whose strength increases with the increase in molecular masses of the compounds.

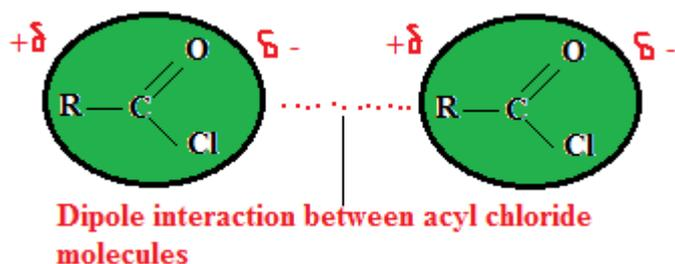

Figure 7.9. Intermolecular forces between molecules of acyl chlorides

The boiling and melting points of acyl chlorides increases as their molecular masses rise. They have lower boiling and melting points than alcohols and carboxylic acids of the same number of carbon atoms, because they lack hydrogen bonds.

Checking up 7.7.1

1. When you mix ethanoyl chloride with water, a clear solution is obtained; yet it is meaningless to talk about the solubility of ethanoyl chloride in water? Explain why.
2. Ethanoyl chloride is a colourless fuming liquid. Why does it fume?

3. What types of intermolecular forces are there in liquid ethanoyl chloride? How do these forces account for the boiling points of acyl chlorides?

7.7.2. Reactions of acyl chlorides

Activity 7.7.2

1. Acyl chlorides mostly react when there is a substitution of chloride ion by another negatively charged ion or molecule with a free lone pair of electrons.

a) How is this type of reaction mechanism called?

b) Given the following acyl chloride molecule and a reagent with a substituting group Y^- . Propose the appropriate mechanism for this reaction.

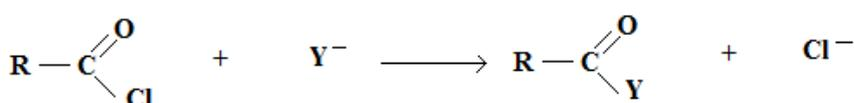

Explain the chemical properties that Y^- should possess so that it can be a good substituent of Cl from the acyl chloride.

The chemistry of acyl chlorides is dominated by nucleophilic substitution, where a stronger nucleophile replaces chlorine atom of acyl chloride. They undergo nucleophilic substitution reactions more easily than alkyl halides and carboxylic acids because the nucleophile targets the carbon which is deficient in electrons and $-\text{Cl}$ is better leaving group than $-\text{OH}$ group.

The common reactions of acyl chlorides include reactions with water, alcohols and ammonia and amines. These reactants have a very electronegative element that has a free lone pair of electrons to act as a nucleophile.

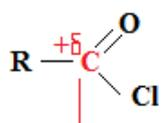

Target for nucleophilic attack

Reaction with water (hydrolysis)

Acyl chlorides violently react with water to form corresponding carboxylic acids and in each case white acidic fumes of hydrogen chlorides are also observed (Figure 7.10).

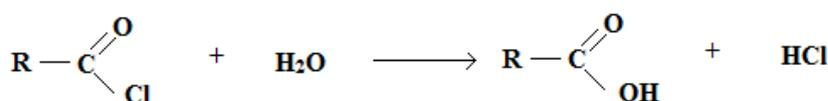

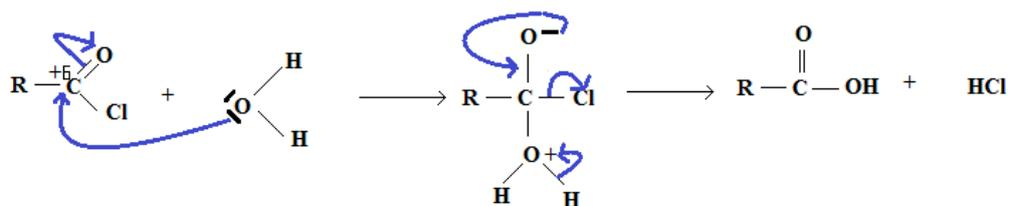

Example:

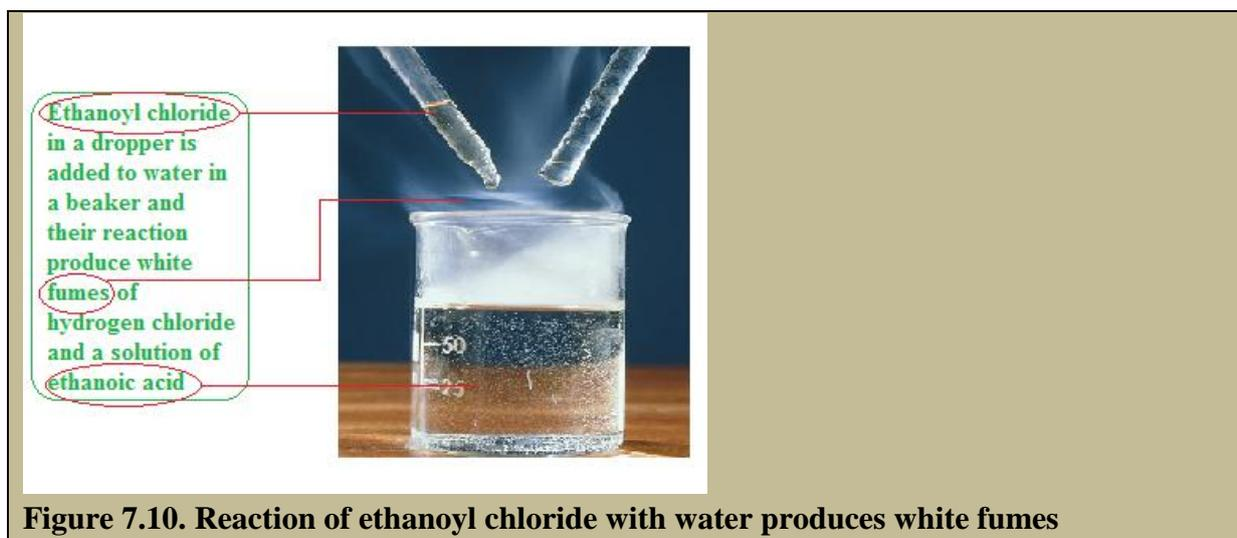
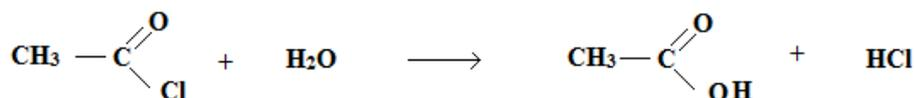
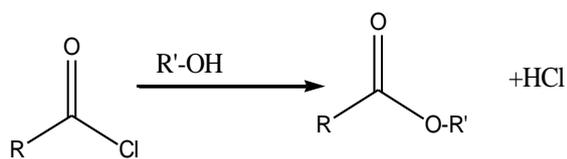

Figure 7.10. Reaction of ethanoyl chloride with water produces white fumes

Reaction with alcohols

They react with alcohol to produce esters with high yields than esterification of an alcohol and carboxylic acid, since Cl-atom in acyl chloride is a better leaving group than O-H for the case of carboxylic acid. The difference in electronegativity is the main reason for this observation.



Mechanism

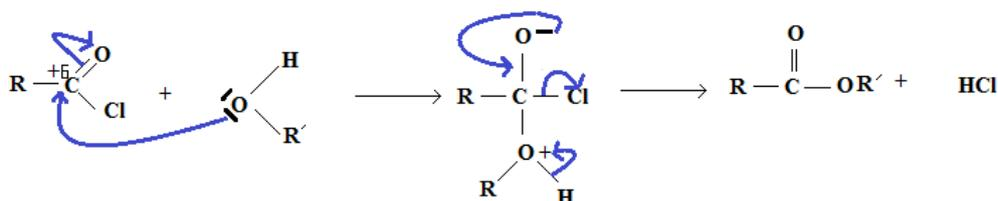

Example:



In addition, this reaction is very important in preparation of aromatic esters which would not be possible by the reaction of phenol with carboxylic acids.

Reaction with ammonia and amine

Acyl chlorides react with ammonia and amines to yield amides. Ammonia, primary amines and secondary amines form primary amides, secondary amides and tertiary amides respectively.

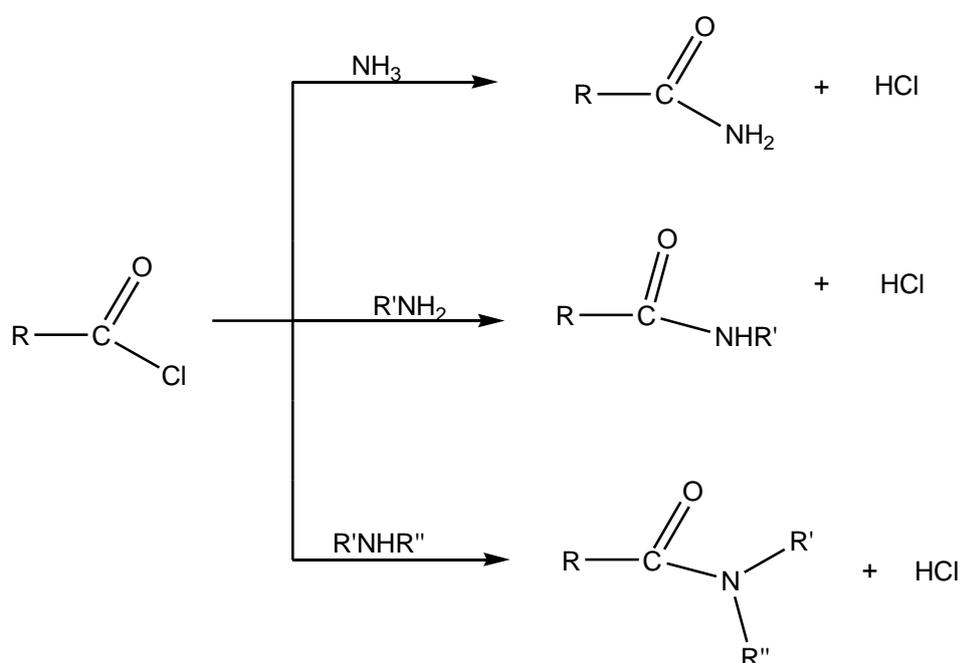

Mechanism:

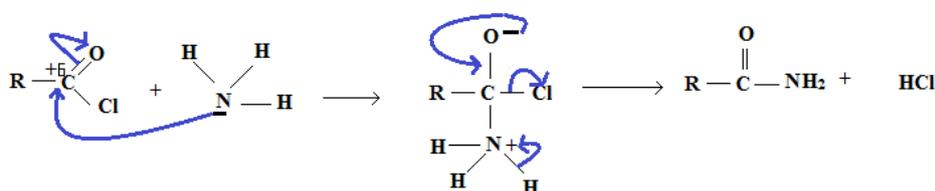

Checking up 7.7.2

1. Explain if tertiary amines can react with acid chloride. If it is possible what would be the expected product.
2. Acyl chlorides are acid derivatives and they contain an acyl group. Using ethanoyl chloride as an example, explain what is meant by the terms acid derivative.
3. Explain these observations:

- a) Ethanoyl chloride is more reactive towards water than is chloroethane
- b) Acyl chlorides are more reactive by nucleophilic substitution than carboxylic acids.

7.8. End unit assessment

A. Multiple choice questions

Choose the correct answer from the four options given.

1. CCl_3COOH is the strongest of
 - a) Acids
 - b) Bases
 - c) Alkalis
 - d) Compounds
2. The reaction of Acyl chlorides with alcohols and phenols will give
 - a) Esters
 - b) Ketones
 - c) Aldehydes
 - d) Haloalkanes
3. Acyl chlorides are made by reacting carboxylic acids with
 - a) PCl_5
 - b) PCl_3
 - c) SOCl_2
 - d) All of them
4. Vinegar contains a carboxylic acid known as
 - a) Citric acid
 - b) Ethanoic acid
 - c) Acetic acid
 - d) Both b and c
5. For synthesis of carboxylic acid intermediate product needed is
 - a) Aldehyde
 - b) Aryls
 - c) Benzene
 - d) Carboxylic acid

B. Open questions

6. Arrange the compounds below in increasing order of boiling point: Propanoic acid, Propanal, Propan-1-ol and Propane. Explain your answer

7. Draw the isomer that is;

a) The most acidic of dichlorobutanoic acid

b) The least acidic of fluoropentanoic acid

8. Naturally occurring fats and oils are the esters of acids with an even number of carbon atoms. Acids with an odd number of carbon atoms are very rare. Suggest a method of increasing the length of an aliphatic acid chain by one carbon atom. More than one steps may be needed.



9. Study the reaction chart flow given below and answer related questions

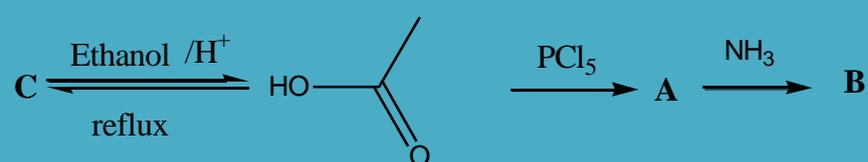

a) Give the names and structures of the compounds A, B, and C

b) Outline the appropriate mechanism for the reaction that converts A into B.

10. Given the following boiling points: 141⁰C, 186⁰C, 118⁰C, 299⁰C, match them with the compounds in the table below.

CH ₃ —CO ₂ H	
CH ₃ (CH ₂) ₁₀ —CO ₂ H	
CH ₃ (CH ₂) ₃ —CO ₂ H	
CH ₃ CH ₂ —CO ₂ H	

10. Starting from any aliphatic carboxylic acid, how could you make its derivative;

- An acyl chloride
- An acid anhydride
- An amide
- An ester

In each case, give the necessary conditions for reaction and equations for the reaction.

11. Describe how the following interconversions can be carried out. In each case, indicate the appropriate reagents and conditions.

- Propan-1-ol from Propanoic acid
- Acetic anhydride from acetic acid

12. A student was given two samples of organic compounds A and B. Both are colorless

liquids in transparent glass bottles. A is carboxylic a derivative of carboxylic acid. The student was asked to use the provided chemicals to distinguish the two compounds. When she added drops of sodium carbonate solution to both samples in separate test tubes, she observed effervescence for B and there was no effervescence for A. She then added few drops of water to both liquids, she observed white fumes with irritant gas, while on B there was no observable change.

- c) Explain the organic compounds that are present in each sample
- d) Use the general structure of the compounds to write the equations of the reactions that took place where applicable.

UNIT 8: ESTERS, ACID ANHYDRIDES, AMIDES AND NITRILES

Key unit competency:

To be able to relate the functional groups of esters, acid anhydrides, amides and nitriles to their reactivity, preparation methods and uses.

Introductory activity

The development of organic chemistry has led scientists to the production of new substances and materials that are necessary in our everyday life which could not be provided by our natural environment. Others were produced to satisfy the high demand of consumers which cannot be assured by natural products only. Analyze the items presented below and answer the questions listed down.



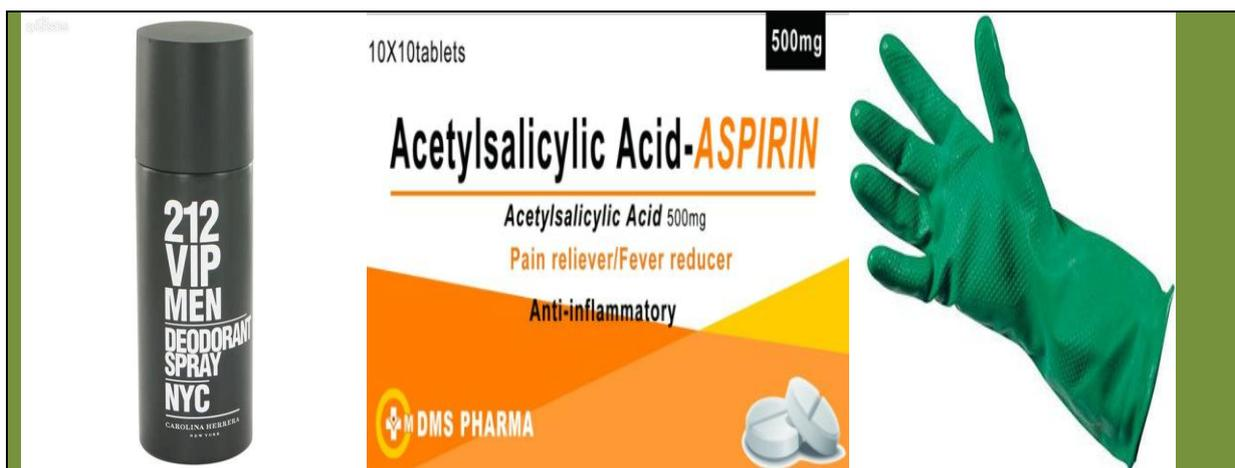

1. What kind of textile is used to make umbrellas? How did scientists make this kind of textiles?
2. One of the substances used to improve soil fertility so as to ensure food security is urea? How is it synthesized?
3. Why is it possible to make artificial drinks with flavors of natural fruits?
4. How are pain killer drugs manufactured?
5. What kinds of substances provide perfumes with their fragrances?

8.1. Structure and nomenclature of esters

Activity 8.1

1. The compounds listed below contain acid derivatives and other organic molecules. Classify them in the following table.

$\text{CH}_3\text{CH}_2\text{CH}_2\text{COOH}$, $\text{CH}_3\text{CH}_2\text{CH}_2\text{COOC}(\text{CH}_2)_2\text{CH}_3$, $\text{CH}_3\text{CH}_2\text{CH}_2\text{CONH}_2$, $\text{CH}_3\text{CH}_2\text{CH}_2\text{CONHCH}_3$,
 $\text{CH}_3\text{CH}_2\text{CH}_2\text{CONHCH}_3$, $\text{CH}_3\text{CH}_2\text{CH}_2\text{CH}_2\text{OH}$, $\text{CH}_3\text{CH}_2\text{CH}_2\text{COH}$, $\text{CH}_3\text{CH}_2\text{COCH}_3$, $\text{CH}_3\text{CH}(\text{CH}_3)\text{CN}$,
 $\text{CH}_3\text{CH}(\text{CH}_3)\text{COOH}$, $\text{CH}_3\text{CHOHCH}_2\text{CH}_3$.

Acid derivatives	Carboxylic acids	Alcohols	Carbonyl compounds

2. Draw all possible isomers with molecular formula $\text{C}_4\text{H}_8\text{O}_2$ and label esters with letter A and acids with letter B.

8.1.1. Structure of esters

In unit 7, the reactions of carboxylic acids were discussed. The reactions of carboxylic acids produce the derivatives of acids such as esters, acid halides, acid anhydrides and amides.

The general molecular formula of esters is $C_nH_{2n}O_2$ and their general structural formula is: $RCOOR'$ or

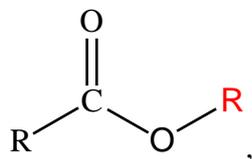

Where R may be a hydrogen atom or an alkyl group and R' may be an alkyl group or an aryl group but not a hydrogen atom. In case that R' is the hydrogen atom, the compound is no longer an ester but it is a carboxylic acid.

The following Figures, 8.1 and 8.2 show models for two common esters where green spheres = Hydrogen atoms, red spheres = oxygen atoms; blue spheres = carbon atoms

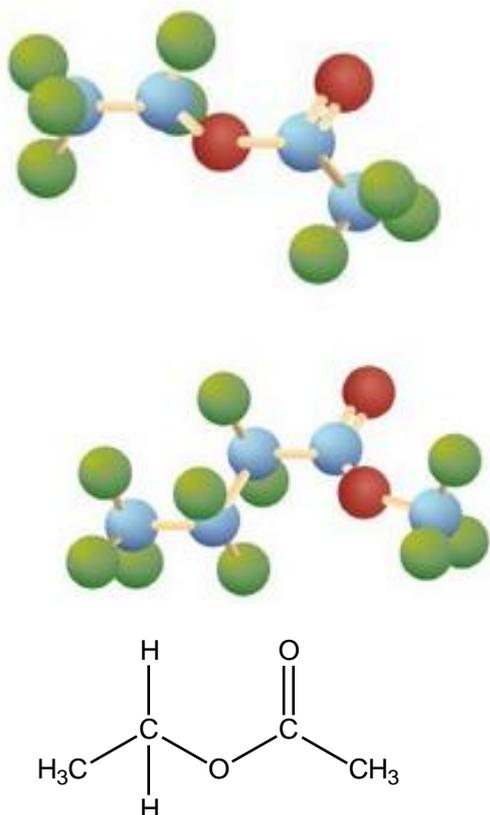

Figure 8.1. Structure of ethyl acetate butanoate

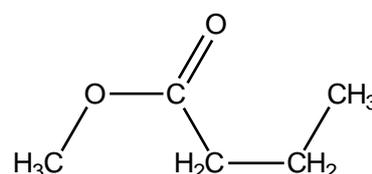
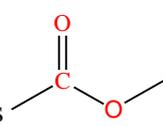
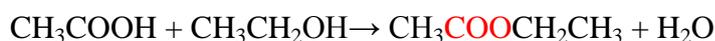

Figure 8.2. Structure of methyl butanoate

The functional group of esters is 

Esters are compounds produced by the reaction involving an acid and an alcohol with the elimination of water molecule.

For example, the reaction between acetic acid and ethanol yields an ester with water.



Acetic acid ethanol ester water

Esters are known for their distinctive odor and they are commonly responsible for the characteristic of food (fruits) aroma, flowers and fragrances. Esters are found in nature but they can be also synthesized. Both natural and synthetic esters are used in perfumes and as flavoring agents.

8.1.2. Nomenclature of esters

The nomenclature of esters follows some steps. When naming esters the alkyl group R' is named followed by the name of RCOO- group.

The group name of the alkyl or aryl portion is written first and is followed by the name of the acid portion. In both common and International Union of Pure and Applied Chemistry (IUPAC) nomenclature, the *-ic* ending of the corresponding acid is replaced by the suffix *-ate*. Some examples of names of esters are given in Table 8.1.

Examples:

Structural formula	Common name	IUPAC name
$\text{CH}_3\text{COOCH}_3$	Methyl acetate	Methyl ethanoate
HCOOCH_3	Methyl formate	Methyl methanoate
$\text{CH}_3\text{COOCH}_2\text{CH}_3$	Ethyl acetate	Ethyl ethanoate
$\text{CH}_3\text{CH}_2\text{COOCH}_2\text{CH}_3$	Ethyl propionate	Ethyl propanoate
$\text{CH}_3\text{CH}_2\text{CH}_2\text{COOCH}(\text{CH}_3)_2$	Isopropyl butyrate	Isopropyl butanoate

Table 8.1. Examples of structural formulae of some esters and their name

8.1.3. Physical properties and uses of Esters

Experiment

A. Analyzing the solubility of esters (fats and oils)

Materials and Chemicals

Cooking oil, margarine, water, ethanol, stirring rods and test tubes labeled A and B.

Procedure

1. Pour water in a test tube A and ethanol in test tube B and add some cooking oil in each test tube. Shake well to mix and record your observation.

2. Pour water in a test tube A and ethanol in test tube B and add a small piece of margarine in each test tube. Use a stirring rod to mix and record your observation.

Conclusion: Esters are soluble in organic solvents such as ethanol and insoluble in water.

B. Comparing boiling points of alcohols, carboxylic acids and esters

Materials and Chemicals

Propan-1-ol, propanoic acid and methyl ethanoate, test tubes, test tube holders (lacks), heaters, and thermometers.

Procedure

1. Put 10 mL of each substance in a labeled test tube.
2. Boil carefully substances are volatile and flammable
3. Use a thermometer to measure the boiling point of each substance.
4. Record the results and compare them. Suggest a reason for the difference in boiling points of the three substances.

Conclusion: Esters have lower boiling points than alcohols and carboxylic acids because they lack hydrogen bonds. A compound having hydrogen bonds has a high boiling point because, to break that bond requires higher energy.

Other physical properties of esters

- (i) Lower esters have sweet fruity smells
- (ii) Melting and boiling points of esters increase as the molecular mass increases.
- (iii) Small esters are fairly soluble in water but the solubility decreases as the length of the chain increases

8.1.4. Uses of Esters

Esters find various uses:

- (i) They are used as organic solvent
- (ii) Due to their aroma, they are used as constituent of fragrance, essential oils, food flavoring and cosmetics.
- (iii) They are used to manufacture soaps, detergents and glycerol.
- (iv) They are used to provide energy in the body
- (v) Polyesters are used to produce plastics etc.

Checking up 8.1

1. Name the following compounds by using the common and IUPAC names.

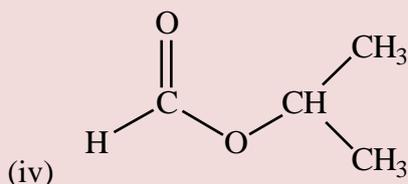

Draw the structural formulae corresponding to each of the following names.

(v).Propyl methanoate (vi) octyl ethanoate

2. Discuss the solubility of esters
3. State one industrial and one biological use of esters.
4. Two compounds A and B of molecular formula $\text{C}_2\text{H}_4\text{O}_2$ were analyzed to compare their relative boiling points. Compound A had lower boiling point than compound B. Draw the structural formula of each compound.
5. Identify the relationship that exists between compounds A and B. Explain your reasoning.

8.2. Preparation and chemical properties of esters

Activity 8.2.

1. Perfumes are manufactured using flowers and fruit essential oils to give them pleasant fragrances. Each essential oil has a specific odor. Suppose that you are working in a perfume's factory as a chemist, how can you proceed to produce perfumes of new odors? Suggest one physical and one chemical method.

2. Ethyl propanoate is used to make juices with a pineapple flavor. State the organic compounds used to synthesize each ester. Write down the reaction equations showing their synthesis.



3. Using your research on internet and reading books, make a summary of each of the following terms:

- Reduction of esters
- Hydrolysis of esters
- Alkaline hydrolysis of ester
- Trans-Esterification
- Comparison of the reactivity of esters, acid chlorides and acid anhydrides

4. Give an example of an equation for each of the processes in (1).

5. Express the technical name given to the process in 3 (c)

8.2.1. Preparation of Esters

The preparation of esters involves different types of reaction such as esterification, reaction of an acid chloride with an alcohol and the reaction of acid anhydrides with alcohols.

1. Esterification reaction

In units five and seven, it is mentioned that esters can be produced by a reaction between alcohols and carboxylic acids in strong acidic medium acting as a catalyst. The acid is commonly a concentrated sulphuric acid, under reflux (Figure 8.3). The reaction is generally called “Esterification” (a condensation reaction which involves the addition of the alcohol and acid molecules followed by an elimination of a water molecule).

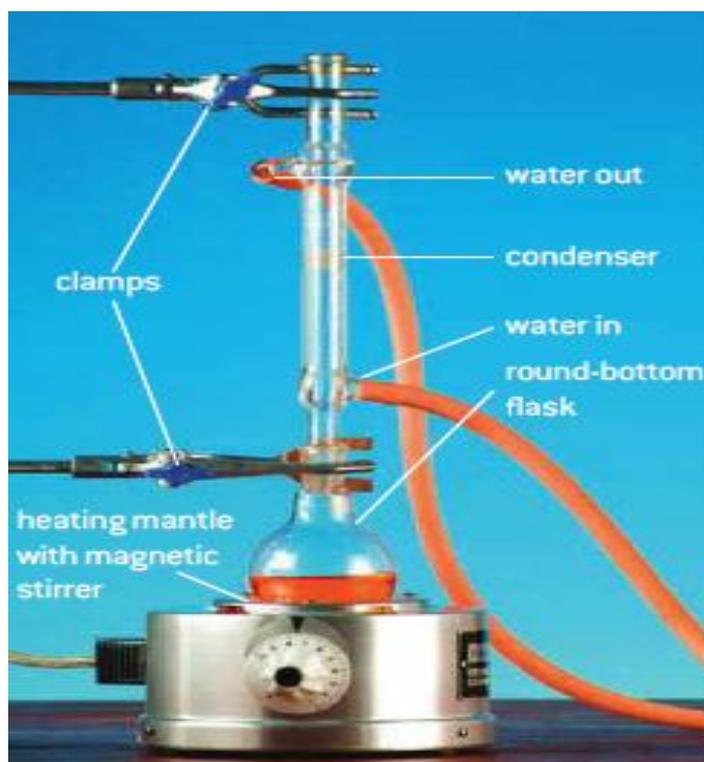
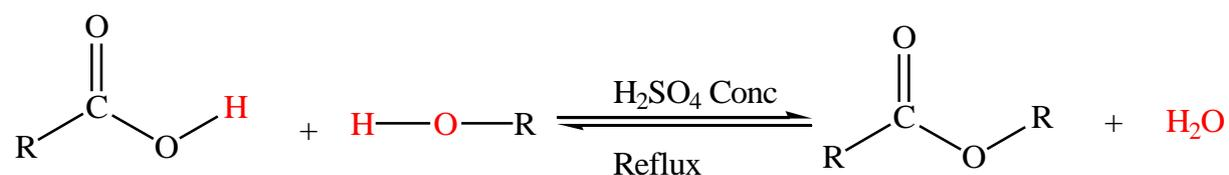
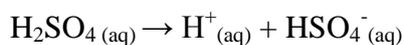
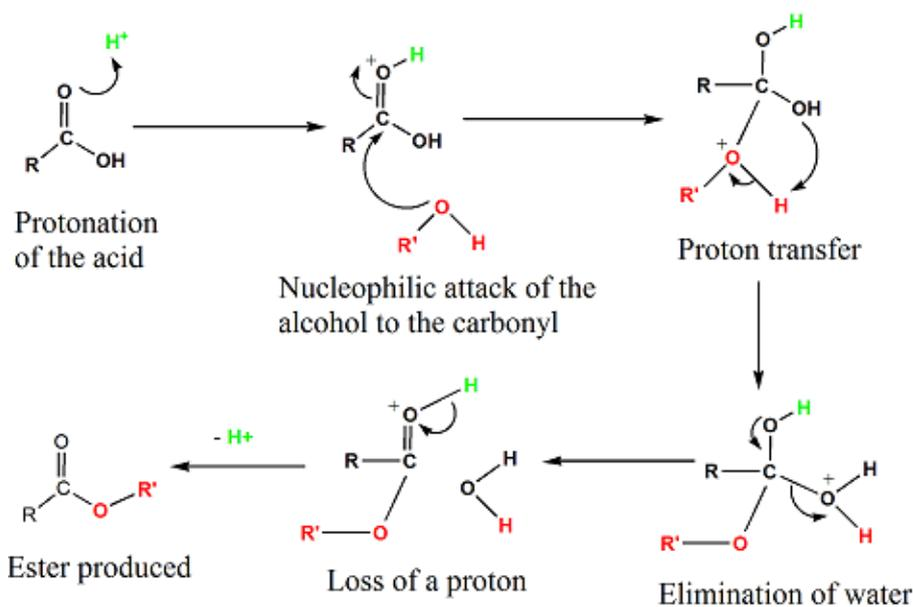

Figure 8.3. Ester preparation set up

Reaction mechanism





Example:

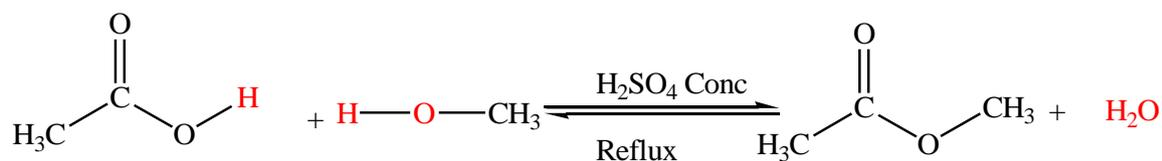

2. Reaction of an acid chloride with an alcohol

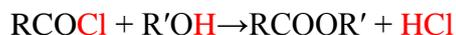

Example

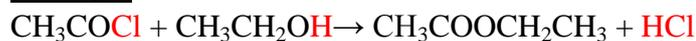

3. Reaction of acid anhydrides with alcohols (Trans-esterification)

Alcohols react with esters to undergo an exchange of the alkoxide segment. The reaction is acid catalyzed and the used alcohol must be in excess. This is a very common technique of producing new esters from available esters.

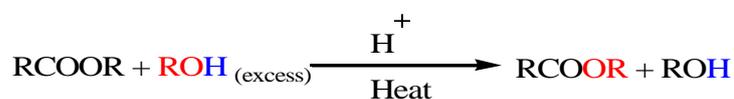

Example

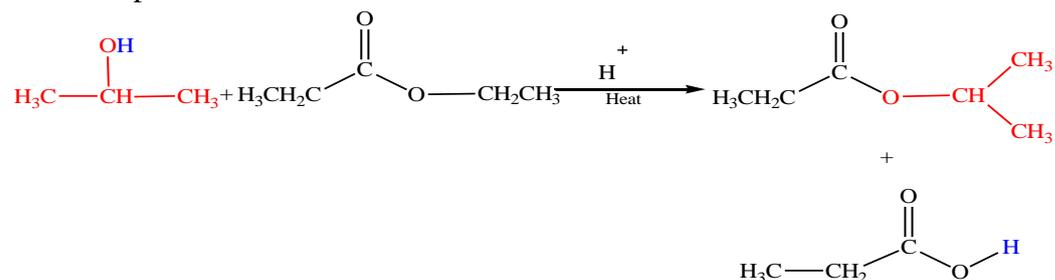

8.2.2. Chemical properties of esters

Chemical properties of esters involve their reactivity with other compounds.

a. Reduction of esters

Compared to ketones and aldehydes, esters are relatively resistant to reduction.

Esters are reduced by Lithiumtetrahydridoaluminate (LiAlH_4) giving two alcohols, one from the acyl segment ($\text{RC}=\text{O}$) and one from the alkoxide segment ($\text{R}-\text{O}$) as shown by the reaction below.

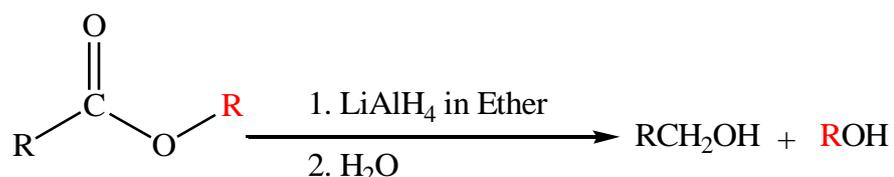

When a less reactive reducing agent such as diisobutylaluminium hydride (DIBAH) is used the acyl segment is converted into an aldehyde and the alkoxide group is still converted into an alcohol. Exactly one equivalent of the hydride must be used, and the reaction must be carried out at -78°C

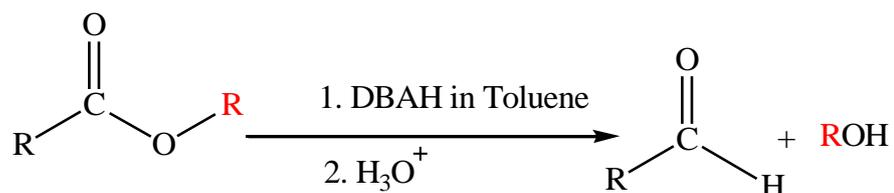

b. Hydrolysis of esters.

The reaction of an ester with water is called hydrolysis. This reaction is very slow unless catalyzed by a base or an acid.

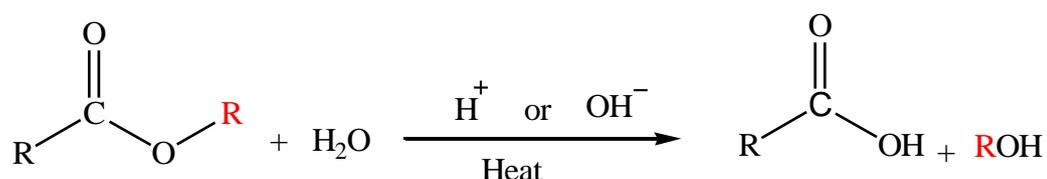

Mechanism of basic hydrolysis of Esters

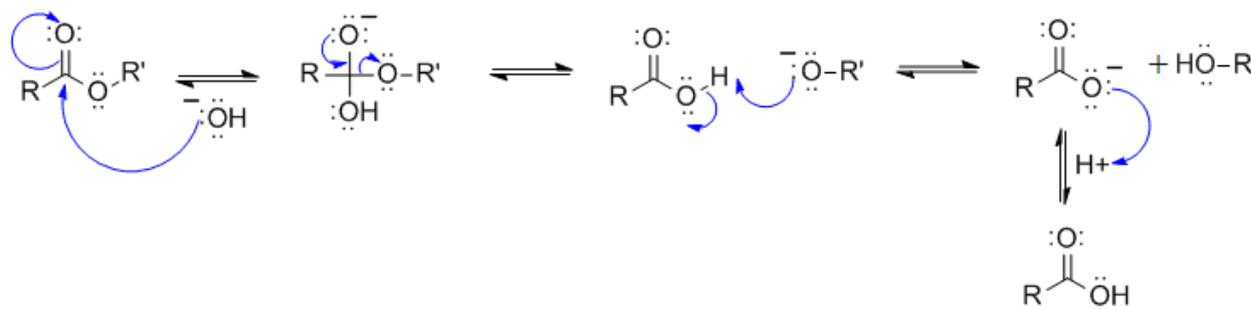

Example

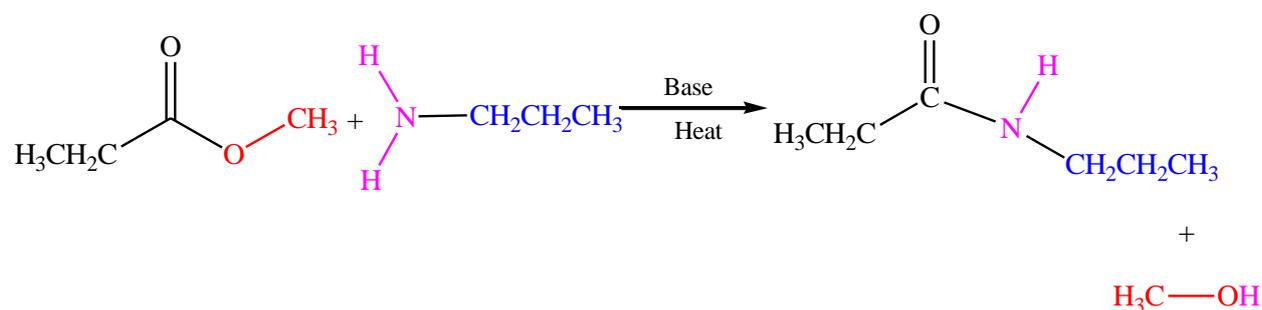

e. Reaction with Grignard reagents

Esters react with two equivalents of a Grignard reagent to form tertiary alcohols. This reaction produces ketone intermediates which undergo a fast conversion into the alcohol because of being more reactive than esters.

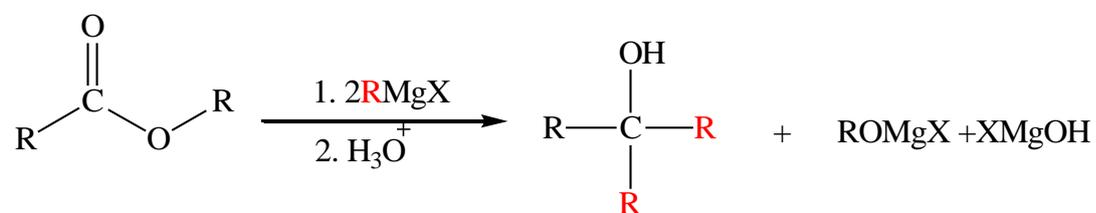

Checking up 8.2.

- Write a balanced equation for the reaction between propanoyl chloride and butan-1-ol and name the product.
- Investigate how to carry out the following conversions by using a non-organic compounds other than the one cited. Use any inorganic substances you need.
 - Propan-1-ol to propyl propanoate
 - Ethanal to ethyl ethanoate
- Ethanoic acid reacts with an alcohol of molecular formula $\text{C}_4\text{H}_{10}\text{O}$ to produce an ester which is optically active.
 - Identify the structure of the alcohol.
 - Sketch the structure of the ester formed.
- Complete the equations below:
 - $\text{CH}_3\text{CH}_2\text{COOCH}_3 + \text{NaOH} \rightarrow$
 - $\text{CH}_3\text{CH}_2\text{OOCH} + \text{CH}_3\text{NH}_2 \rightarrow$



5. For a reaction to take place, some conditions may be required depending on the type of reaction. Discuss the conditions to be used in order to carry out the reaction 4.a.
6. Reactions of amines with esters are not common. Explain briefly this statement.
7. You are provided with ethyl ethanoate and asked to prepare isobutyl ethanoate.

Describe how you can proceed to prepare that compound. In your explanations, include reagents, conditions and equation(s) for the reaction(s) that take place.

You are allowed to use any other organic compound you need.

8.3. Saponification and Detergents

Activity 8.3.



Observe the above picture and answer the following questions

1. Describe the use of the products above –mentioned in the picture.
2. Explain the properties that these products have which make them suitable for their use as you have stated in (1).
3. Explain how these products manufactured?
4. Propose the differences and similarities of these products?
5. Using NaOH and cooking oil, how can you prepare a solid soap in laboratory?

Surfactants like soaps and detergents are important cleaning products which play an essential role in our daily life. By safely and effectively removing soils, germs and other contaminants, they help us to stay healthy, care for our homes and possessions, and make our surroundings more pleasant.

SOAPS

Soaps are water-soluble sodium or potassium salts of fatty acids. Soaps are made from fats and oils, or their fatty acids, by reacting them with a strong alkali. The process is known as “*saponification*”.

Fats and oils

The fats (solid lipids at room temperature and pressure) and oils (liquid lipids at room temperature and pressure) used to produce soaps find their sources from animal or plant. Each fat or oil is made up of a distinctive mixture of several different triglycerides.

In the formation of a triglyceride molecule, three fatty acid molecules reacted with one molecule of propane-1,2,3-triol or glycerol as shown in Figure 8. 4 below.

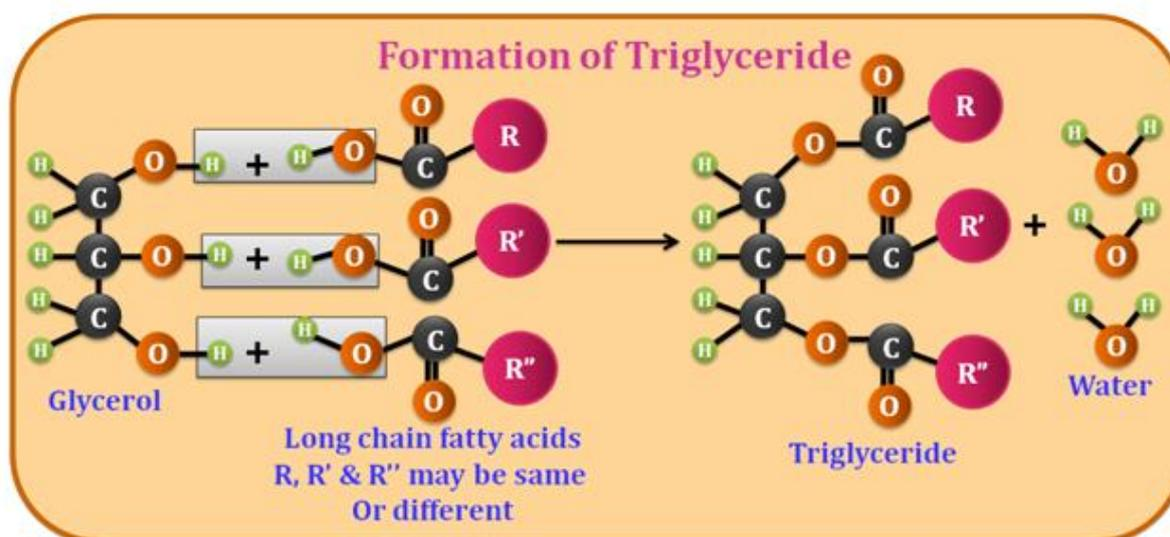

Figure 8.4. Formation of a triglyceride

Examples of other fatty acids include stearic acid ($\text{CH}_3(\text{CH}_2)_{16}\text{CO}_2\text{H}$), palmitic acid ($\text{CH}_3(\text{CH}_2)_{14}\text{COOH}$), ...

Saponification reaction

The reaction of saponification involves the collision between triglycerides in fat/oil and aqueous NaOH or KOH. The result is the formation of soap and glycerol (Figure 8.5).

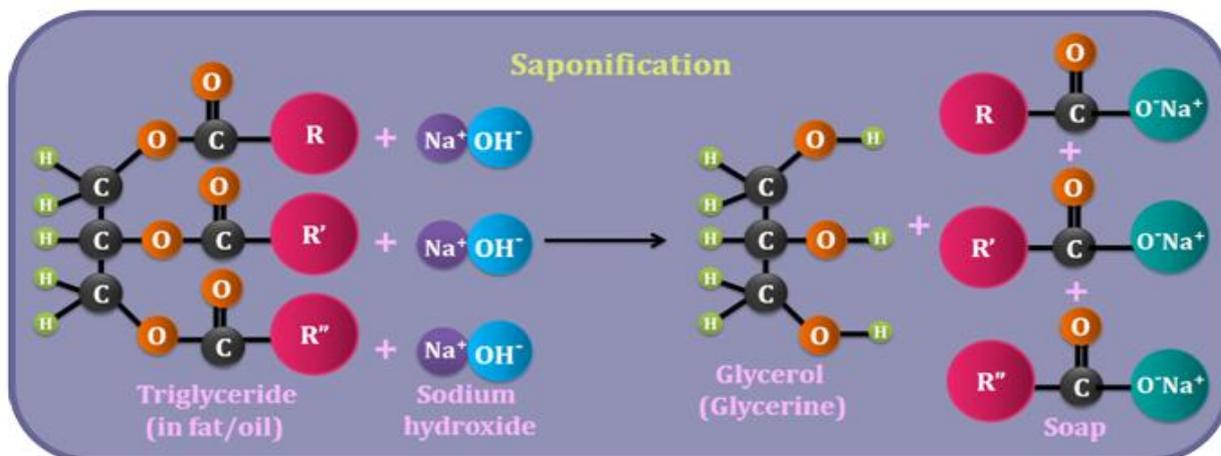
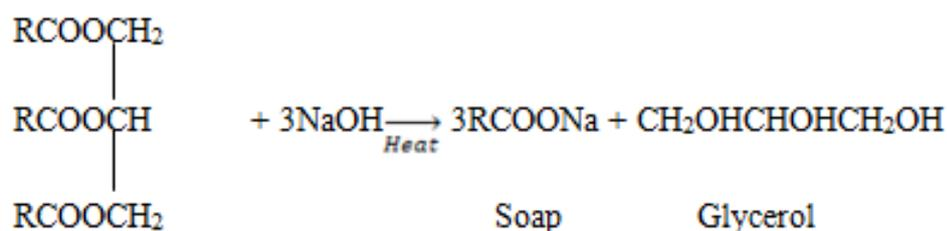

Figure 8.5. Saponification

Or



The reaction of saponification is exothermic because there is liberation of heat and the soap formed remains in suspension form in the mixture. Soap is precipitated as a solid from the suspension by adding common salt to the suspension.

Example:

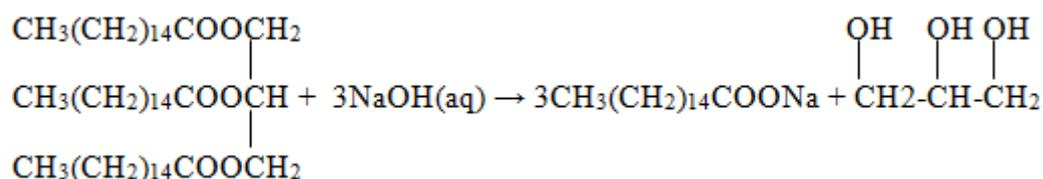

The other major soap-making process is the neutralization of pure fatty acids with an alkali.
Note: Sodium soaps are “hard” soaps whereas potassium soaps are soft.

DETERGENTS

Detergents are organic liquid or water-soluble solid cleaning substances that, unlike soap, are not prepared from fats and oils.

The chemical composition of detergents is different from that of soaps but they have the same cleaning mechanism and are not adversely affected by hard minerals in the water and this

makes them more effective than soaps. However, they are less environmental friendly because of a reduced biodegradability.

Detergents may be used for household cleaning, laundry or for body and hand washing. They exist in the powder or liquid form.

How do soaps and detergents work?

When a soap or detergent is added to water, a polar solvent, the molecules form clusters, known as *micelles* (Figure 8.6), in which the polar ends of the molecules are on the outside of the cluster and the non-polar ends are in the middle.

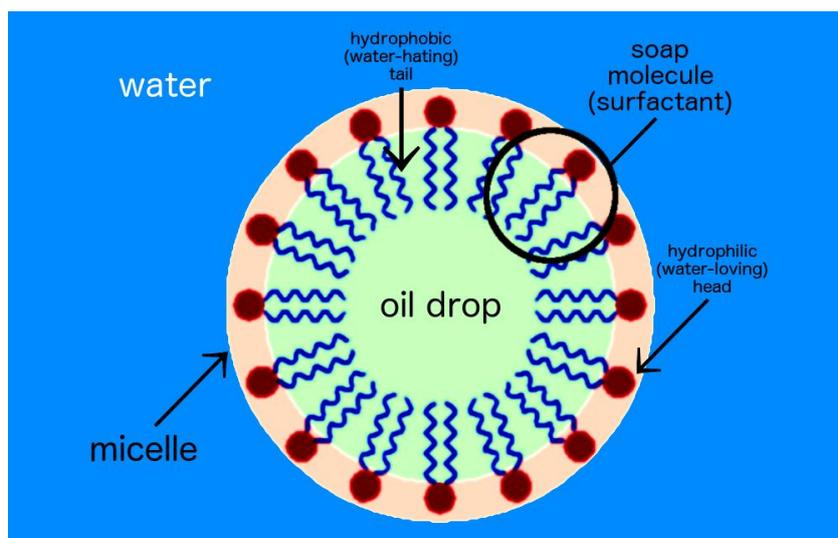

Figure 8.6. Soap or detergent micelle

The carboxylate end of the soap molecule is attracted to water. It is called the hydrophilic (water-loving) end. The hydrocarbon chain is attracted to oil and grease and repelled by water. It is known as the hydrophobic (water-hating) end. When washing, the hydrophobic part of the soap molecule (Figure 8.7) dissolves oil or grease the main source of dirt and it gets washed away by water as it is insoluble in it.

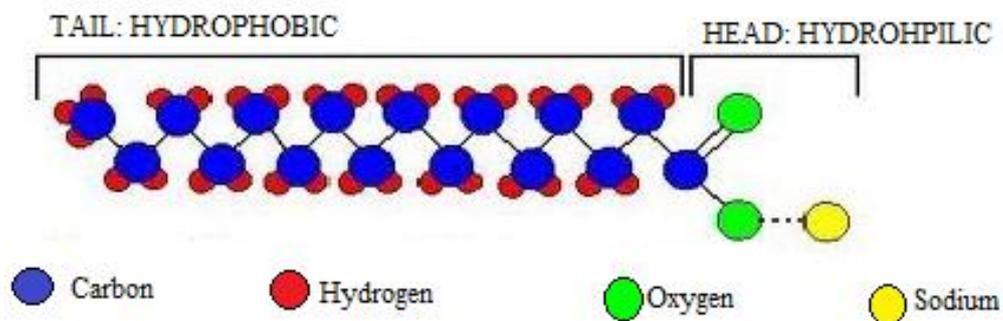
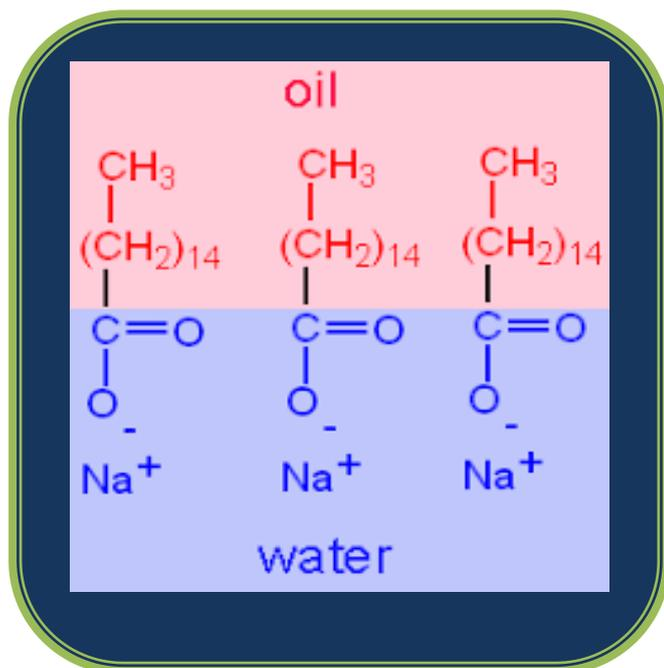

Figure 8.7. Representation of soap molecule

The cleaning property of both soaps and detergents results from their capacity to emulsify water-insoluble materials (dirt, oil, grease, etc.) and hold them in suspension in water. This ability originates from the molecular structure of soaps and detergents. When a soap or detergent adds on to water that contains oil or other water-insoluble materials, the soap or detergent molecules surround the oil droplets. The oil or grease is “dissolved” in the alkyl groups of the soap molecules while the ionic end allows the micelle to dissolve in water. As a result, the oil droplets are dispersed throughout the water (this is referred to as *emulsification*) and can be rinsed away.



Checking up 8.3.

1. Propyl tristearate reacts with sodium hydroxide to form soap.
 - a. Write a balanced equation for the reaction which takes place.
 - b. Calculate the mass of sodium hydroxide needed to react exactly with 4kg of this oil and the mass of the produced soap.
2. Describe the chemical difference of solid and liquid soaps.
3. Distinguish soaps from detergents.
4. Why are detergents more effective than soaps?
5. Describe briefly in your own words how soaps and detergents work.
6. Discuss the importance of soaps and detergents in our everyday life.

8.4. Structure and nomenclature of acid anhydrides

Activity 8.4.



One of the most used pain killers is aspirin (image above). This is a medical drug which can be prepared using salicylic acid and ethanoic acid. However, ethanoic acid is not used. Instead, one of its derivatives is used. Search from internet or the school library and answer the questions below:

1. Propose a derivative of acetic acid is used in this preparation?
2. Explain why is it used in preference to acetic acid?
3. Write down its molecular formula and structure.
4. Suggest how it is produced from acetic acid.

8.4.1. Structure of acid anhydrides

The acid anhydrides are derivatives of carboxylic acids. The general structure of acid anhydrides is RCOOOCR , or

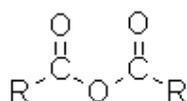

The functional group of acid anhydrides consists of two acyl groups held together by an oxygen atom.

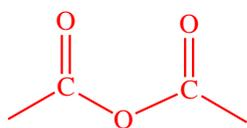

When the two R groups are identical, the acid anhydride is symmetric and when the two R groups are different, the acid anhydride is asymmetric. The general molecular formula of acid anhydride is $\text{C}_n\text{H}_{2n-2}\text{O}_3$

8.4.2. Nomenclature of acid anhydrides

The nomenclature of acid anhydride is based on whether they are symmetrical or unsymmetrical. Symmetrical acid anhydrides are named as parent acid followed by the term anhydride

Examples: $\text{CH}_3\text{COOOCCH}_3$: Ethanoic anhydride

$\text{CH}_3\text{CH}_2\text{COOOCCH}_2\text{CH}_3$: Propanoic anhydride (Illustration below)

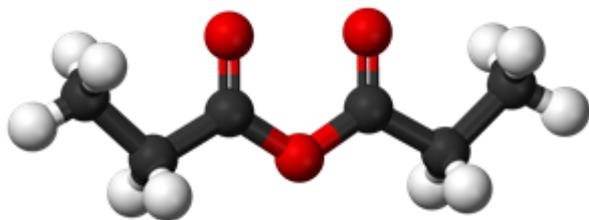

Unsymmetrical acid anhydrides are named by writing alphabetically the names of parent acids followed by the term anhydride.

Examples: $\text{CH}_3\text{CH}_2\text{COOOCCH}_3$ Ethanoic propanoic anhydride

$\text{CH}_3\text{COOCOCH}_2\text{Cl}$: Acetic chloroacetic anhydride

Checking up 8.4.

1. Write the molecular formula of an acid anhydride which has 6 carbon atoms
2. Draw the structure of one straight and one branched isomers of the molecular formula in (1) above.
3. Name the isomers from (2).

8.5. Preparation, chemical properties and uses of acid anhydrides

Activity 8.5.

1. Two carboxylic acids can react to form an acid anhydride and a water molecule. However, this method is not suitable when preparing mixed (unsymmetrical) acid anhydrides.
Suggest a reason why this method is not suitable.
2. Using your knowledge in organic chemistry so far, suggest a method which may be suitable to prepare ethanoic propanoic anhydride. Write the equation for the reaction. (Hint: you may refer to the preparation of ethers).
3. Prepare ethanoic anhydride using ethanoic acid and phosphorous pentoxide.
4. Aspirin is synthesized using ethanoic anhydride and salicylic acid. Suggest an equation for the reaction that occurs.

8.5.1. Preparation

Anhydride means “without water”. Two carboxylic acids can react, eliminating a water molecule to yield an acid anhydride.

Example:

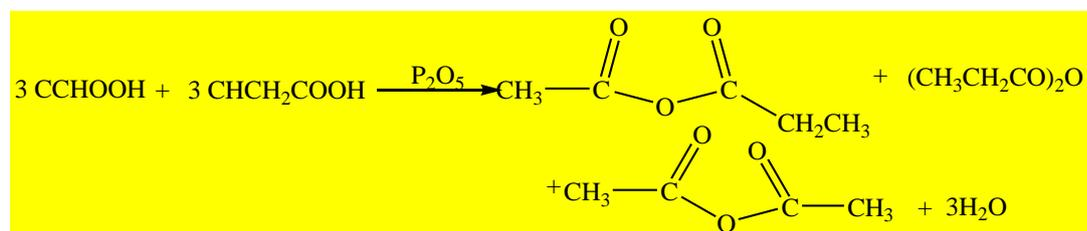

The commonly used dehydrating agent is phosphorous pentoxide, P_2O_5 . If two different acids are used, a mixed anhydride is produced. The method is less efficient however, as one obtains the two symmetrical anhydrides in addition to the desired mixed anhydride.

Example:

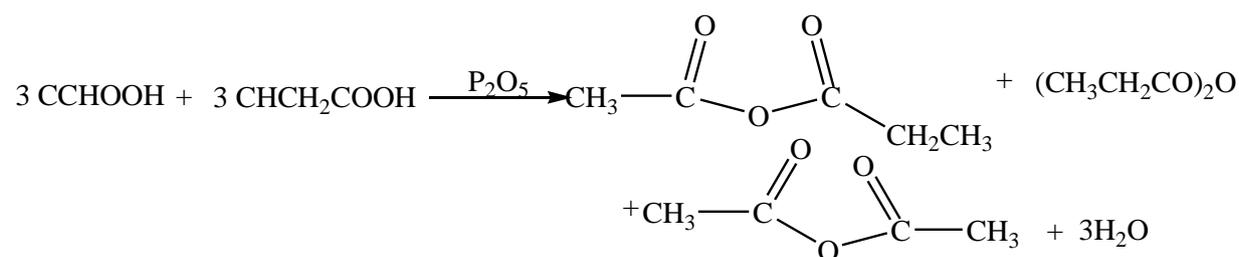

A better method of making mixed anhydrides is to react an acid halide with a salt of a carboxylic acid. This method can be used to make symmetrical anhydrides too.



8.5.2. Chemical properties of acid anhydrides and their uses

The term “chemical properties” indicates the reactivity between two or more compounds. In the case of acid anhydrides, their reactivity involves the electron-deficient carbonyl-carbon which is attacked by nucleophiles. This reaction occurs slowly.

There are mainly four types of reactivity of acid anhydrides such as hydrolysis, reaction with alcohols, reaction with ammonia and amines and the reduction reaction.

1. Hydrolysis

This reaction of acid anhydride in water leads to the formation of parent carboxylic acids which were used to prepare the anhydride. The reaction is carried out in acidic medium under reflux.

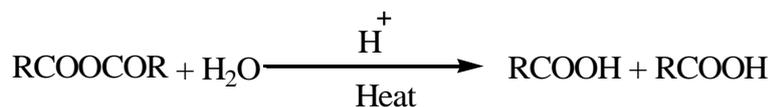

Example:

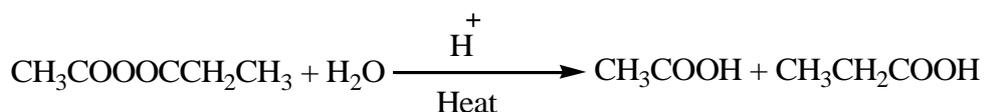

2. Reaction with alcohols

Anhydrides react readily with primary, secondary, tertiary alcohols to form esters and carboxylic acid.

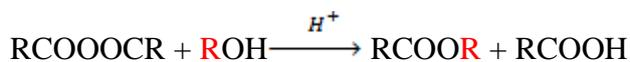

Aspirin synthesis is an application of this reaction

Example:

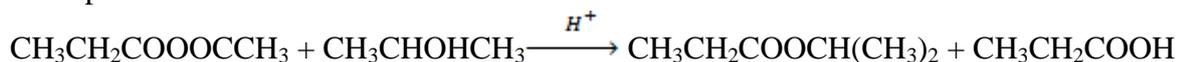

This reaction is very important in pharmaceutical industries and it indicates the main use of acid anhydrides as it is the basis of aspirin manufacture as shown below.

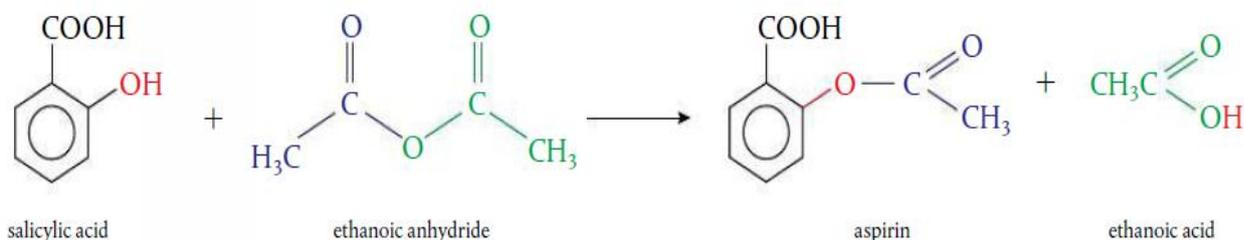

3. Reaction with ammonia and amines

Anhydrides react with ammonia, primary and secondary amines to produce amides.

The reaction with amide: $\text{RCOOCR} + \text{R}'\text{NHR}' \rightarrow \text{RCON}(\text{R}')_2 + \text{RCOOH}$

Amide Acid



Reaction with ammonia: $(\text{RCO})_2\text{O} + \text{NH}_3 \rightarrow \text{RCONH}_2 + \text{RCOOH}$

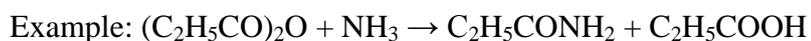

Amide

4. Reduction of acid anhydrides

Anhydrides are reduced by Lithium tetrahydridoaluminate, LiAlH_4 , to yield two moles of primary alcohols.

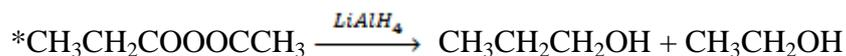

8.5.3. Uses of acid anhydrides

1. Ethanoic anhydride is used in the synthesis of acetate esters.
Examples: aspirin, cellulose acetate,...
2. Maleic anhydride is used in the synthesis of various resins when copolymerized with styrene.
3. They are used to synthesize polyesters and polyamides.

Checking up 8.5

1. Write the equations that can be used to synthesize the following acid anhydrides from ethanol.
 - a. Ethanoic anhydride
 - b. Propanoic anhydride
 - c. Ethanoic propanoic anhydride
2. Students of senior five MCB were asked to prepare butanoic propanoic anhydride and group A used a method similar to Williamson's method of synthesizing ethers whereas group B decided to use a dehydrating agent. Which group chose a better method? Explain your reasoning

3. Complete the equations below

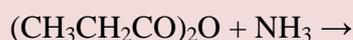

4. Propose the products from the reaction below:



5. Draw the structures of products formed when propanoic anhydride reacts with 2-methylpropan-2-ol
6. State the necessary chemicals and conditions to prepare aspirin.
7. Chemists prefer using acid anhydrides than acyl chlorides when preparing esters. Discuss this statement.

8.6. Structure and nomenclature of amides

Activity 8.6.

In the previous unit, it has been mentioned that carboxylic acids react with ammonia and amines to produce new organic compounds.

1. Draw and name their functional group.
2. Draw their general structure and determine their general molecular formula.
3. What natural and artificial polymers contain the same functional group?
4. Suggest how their boiling points would be relative to those of esters. Provide an

explanation for your suggestion.

5. What kind of textile is used to make this wedding dress below?



8.6.1. Structure of amides

Amides are acid derivatives in which the $-OH$ group is replaced by $-NH_2$, $-NHR$ or $-N(R)_2$. The functional group comprises nitrogen atom which is attached to the carbonyl carbon atom. The carbonyl group linked to nitrogen atom is called *an amide linkage*. The general structure of amides is:

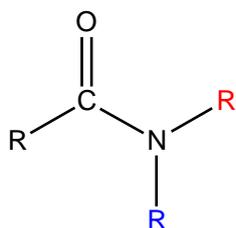

Where R and **R** can be hydrogen atoms (for primary amides), alkyl groups (for tertiary amides). For secondary amides only one R is a hydrogen atom. Their general molecular formula is $C_nH_{2n+1}ON$. Examples of some amides are given in the Table 8.2.

Table 8.2. Examples of some amides

Primary amide	Secondary amide	Tertiary amide
$\begin{array}{c} \text{O} \\ \parallel \\ \text{R}-\text{C}-\text{N}-\text{H} \\ \\ \text{H} \end{array}$	$\begin{array}{c} \text{O} \\ \parallel \\ \text{R}-\text{C}-\text{N}-\text{H} \\ \\ \text{R} \end{array}$	$\begin{array}{c} \text{O} \\ \parallel \\ \text{R}-\text{C}-\text{N}-\text{R} \\ \\ \text{R} \end{array}$

$\text{CH}_3\text{CH}_2\text{CONH}_2$	$\text{CH}_3\text{NHCOCH}_3$	$(\text{CH}_3)_2\text{NCOCH}_2\text{CH}_2\text{CH}_3$

8.6.2. Nomenclature of amides

The nomenclature of amides is derived from the name of corresponding acid. The –oic acid suffix or –ic acid is replaced by –amide.

As for other organic compounds, the first step is to consider the number of carbon atoms forming the chain.

The alkyl group bonded to nitrogen atom is indicated by a capital N preceding the alkyl name.

Examples: $\text{CH}_3\text{CH}_2\text{CONH}_2$: propanamide, $\text{CH}_3\text{CONHCH}_3$: N-methylethanamide,

$\text{CH}_3\text{CON}(\text{CH}_3)_2$: N,N-dimethylethanamide, $\text{CH}_3\text{CONCH}_2\text{CH}_3$: N-ethyl-N-methylethanamide

8.6.3. Physical properties and uses of amides

Physical properties of amides

Except formamide, all the amides are crystalline solids at room temperature. Amides have higher melting and boiling points than corresponding esters due to hydrogen bonding as shown below.

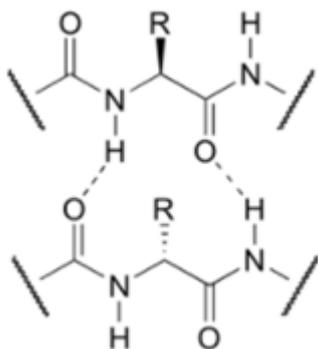

The melting and boiling points increase as molecular mass increases. Lower members are soluble in water but this solubility decreases as the molecular mass increases. All the amides are soluble in organic solvents. The Table 8.3 shows the comparison of melting and boiling points of some amides.

Table 8.3. Some physical properties of lower amides

Name	Melting point (°C)	Boiling point (°C)	Solubility in water
Methanamide	2	193	Soluble
Ethanamide	82	222	Soluble
Propanamide	81	213	Soluble
Butanamide	115	216	Soluble
Benzamide	132	290	Slightly soluble

Source: <https://chem.libretexts.org>

8.6.4. Uses of Amides

Amides are used in the production of many useful chemicals and materials such as fertilizers (urea), nylon textiles and skin care substances.

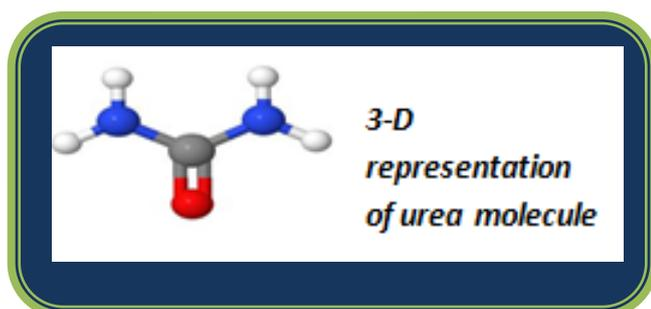

Urea manufacture

Urea can be prepared in three ways:

a. Reaction of phosgene and ammonia

$\text{O}=\text{CCl}_2 + \text{NH}_3 \rightarrow \text{O}=\text{C}(\text{NH}_2)_2 + 2\text{HCl}$. The diagram below shows the representation of Urea.

Phosgene Urea

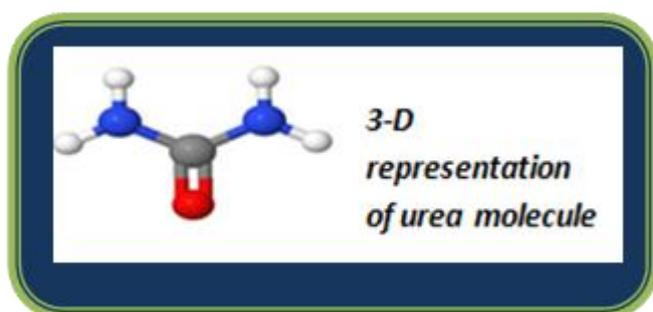
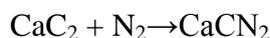

Figure 8.8. 3-D Urea molecule

b. From calcium cyanamide, CaCN₂

Calcium carbide reacts with nitrogen to produce calcium cyanamide and carbon. The produced CaCN₂ is then treated with a mixture of water and carbon dioxide to produce urea.



c. Reaction of carbon dioxide and ammonia



Urea is also naturally present in animal urines.

It is widely used in agriculture as a source of nitrogen, chemical fertilizer. It also finds use in animal feeding and in resins manufacture.

Nylon manufacture

Nylon-6,6 is a synthetic textile produced when hexane-1,6-dioic acid(adipic acid) reacts with hexane-1,6-diamine. Nylon is a polyamide. Materials and clothes are made from nylon-6,6.

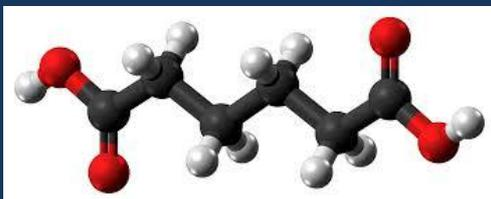

Figure 8.9. Adipic acid

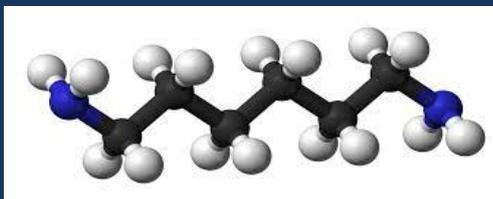

Figure 8.10. Hexane-1,6-diamine

Medical use of urea

Urea containing creams are used in skin treatment to promote its rehydration. It softens the skin.

Checking up 8.6.

1. Write the molecular formula of amides with 4 carbon atoms
2. Draw all possible structural formulae of primary, secondary and tertiary amides with molecular formula in (1) above and name them
3. Compare the solubilities of butanamide and N,N-dimethylethanamide in water
4. The solubility of amides decreases with the increase in molecular mass. Suggest a reason for

this observation.

5. Which one between ethanol and ethanamide do you expect to have a higher boiling point? Explain your answer.
6. Discuss the benefits and dangers of using animal urine as a source of nitrogen for plants.

8.7. Preparation and chemical properties of amides

Activity 8.7.

1. Draw the structure of propanamide.
2. Suggest how this compound can be prepared from propanoic acid. Include an equation in your answer and state working conditions.
3. Draw the structure of ethanoyl chloride and write an equation for its reaction with CH_3NH_2
4. Suggest other possible reactions that can be used to prepare amides in general
5. What reagents and conditions which can be used to reduce amides?

8.7.1. Preparation of amides

Amides can be prepared from all of the other acid derivatives when they react with ammonia and primary or secondary amines. Their production of amides involves the following reactions.

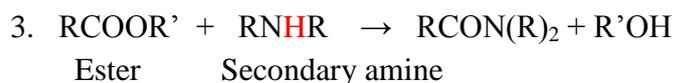
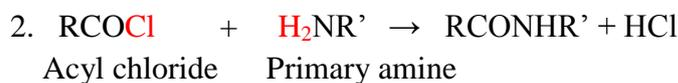
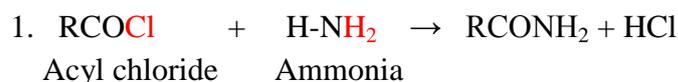

Acid anhydride primary amine



5. Amide can also be prepared from a reaction of a carboxylic acid and ammonia or an amine. The produced salt must be heated to dehydrate it.

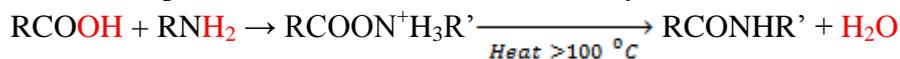

6. The hydrolysis of nitriles also produces amides

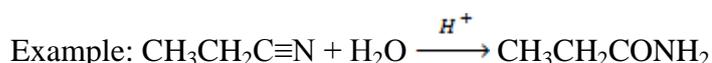
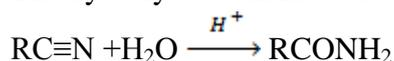

8.7.2. Chemical properties of amides

The reactivity of amides involves different types of reaction to form various organic compounds.

1. Reduction reaction

Amides are reduced with sodium and ethyl alcohol or with lithium aluminium hydride (LiAlH_4) to yield primary amines.

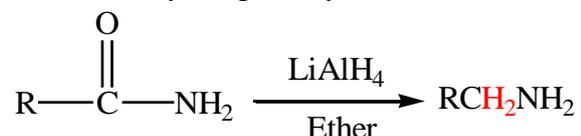

Example:

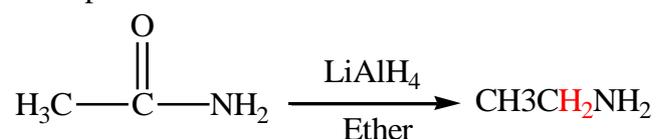

2. Hydrolysis

Amides react with water in acidic medium (dilute) at high temperatures to form acids.

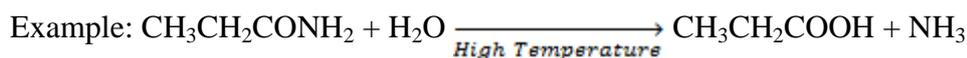

3. Hoffman degradation

Amides react with a mixture of sodium hydroxide and bromine or sodium hypobromite to produce amines. The reaction is called degradation as the carbon chain is reduced by one carbon.



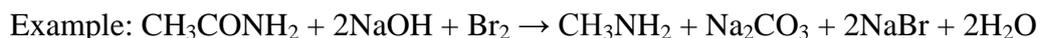

This equation can be simplified as follows:

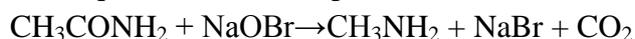

Note: Hoffman degradation reaction is used to test the presence of the amide functional group. When an amide is treated with sodium hypobromite, a colorless gas which turns milky lime water is evolved, CO_2 .

4. Reaction with nitrous acid

Amides react with nitrous acid to produce an acid, water and nitrogen gas.

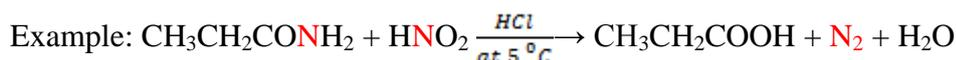
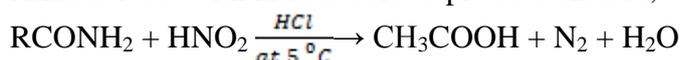

5. Dehydration reaction

Dehydrating reagents, like thionyl chloride (SOCl_2), remove one molecule of water from amides to give nitriles. Phosphorous pentoxide can also be used. The reaction is done under reflux.

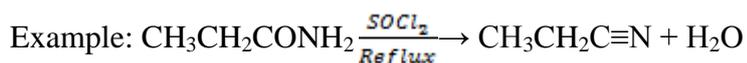
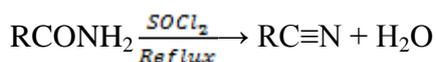

Checking up 8.7.

1. Referring to the hydration of alkynes, draw the structure of the intermediate compound formed during the preparation of amides from nitriles.
2. Identify the compounds corresponding to each letter in the scheme of reactions below

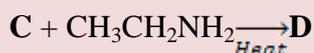
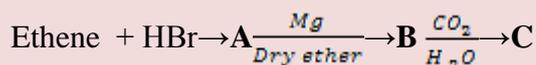

3. Explain how you can distinguish between these pairs of compounds. State the reagents to be used and the expected observations.
- Butanamide and ethyl ethanoate
 - Aqueous sodium carbonate and ethanamide.
4. How can you perform the following conversions?
- $\text{CH}_3\text{CH}_2\text{CH}_2\text{OH}$ to $\text{CH}_3\text{CH}_2\text{CN}$ (your conversion must include an amide formation step)
 - CH_3CHO to CH_3NH_2

8.8. Structure and nomenclature of nitriles

Activity 8. 8.

In the previous lesson of this unit you learnt different reactions of amides. From your knowledge and understanding, answer the questions that follow:

1. Draw the structure of compound A:

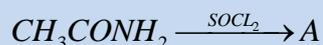

- To what homologous series does product A belong?
- Write the molecular formula of A.
- Suggest the general structure and the general molecular formula for all compounds belonging to the same homologous series as A.
- At room temperature, these compounds are liquids or solids depending on the molecular mass and yet they lack hydrogen bonding. Suggest a brief explanation for this specialty.

8.8.1. Structure of nitriles

Nitriles are organic compounds with the general structure $\text{RC}\equiv\text{N}$ where $-\text{C}\equiv\text{N}$ is its functional group. The nitrile compounds include a nitrogen atom attached to a carbon atom by a triple covalent bond. Their general molecular formula is $\text{C}_n\text{H}_{2n-1}\text{N}$. Unlike other acid derivatives they do not contain an acyl group.

8.8.2. Nomenclature of nitriles

The nitriles are named using the name of the alkane parent followed by the term –nitrile. The carbon attached to the nitrogen atom is given the location position number 1.

Structure and name of some nitriles are shown in the Table 8.4.

Table 8.4. Examples of some nitriles

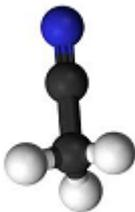
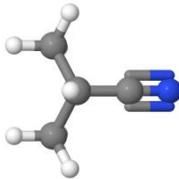
Ethanenitrile	Propanenitrile	butanenitrile	2-methylbutanenitrile
$\begin{array}{c} \text{H} \\ \\ \text{H}-\text{C}-\text{C}\equiv\text{N} \\ \\ \text{H} \end{array}$	$\begin{array}{c} \text{H} \quad \text{H} \\ \quad \\ \text{H}-\text{C}-\text{C}-\text{C}\equiv\text{N} \\ \quad \\ \text{H} \quad \text{H} \end{array}$	$\begin{array}{c} \text{H} \quad \text{H} \quad \text{H} \\ \quad \quad \\ \text{H}-\text{C}-\text{C}-\text{C}-\text{C}\equiv\text{N} \\ \quad \quad \\ \text{H} \quad \text{H} \quad \text{H} \end{array}$	$\begin{array}{c} \text{H} \quad \text{H} \quad \text{H} \\ \quad \quad \\ \text{H}-\text{C}-\text{C}-\text{C}-\text{C}\equiv\text{N} \\ \quad \quad \\ \text{H} \quad \text{H} \quad \text{CH}_3 \end{array}$
CH ₃ CN	CH ₃ CH ₂ CN	CH ₃ CH ₂ CH ₂ CN	$\begin{array}{c} \text{CH}_3\text{CH}_2\text{CHCN} \\ \\ \text{CH}_3 \end{array}$
			

8.8.3. Physical properties and uses of nitriles

Physical properties

The physical properties of nitriles are summarized below.

1. The nitrile compounds are present as colorless solids and liquids having a characteristic odor.
2. Nitriles have boiling points ranging between 82 and 118 °C. The high boiling points are due to strong dipole-dipole moments caused by the polarity of the C≡N bond.
3. Nitriles compounds exhibit high polar and electronegativity
4. Lower nitriles are highly soluble in water but this solubility decreases with the increase in molecular mass as the non-polar part becomes larger.

Uses of nitrile compounds

Nitriles find many uses:

- Nitriles are used in the manufacture of nitrile gloves, seals, and pipes or tubes as they exhibit resistance to chemicals.
- They are used as an antidiabetic drug which is used in the treatment of breast cancers.
- This compound is found in many plant and animal sources.
- They are utilized in the applications of oil resistant substances and also for low-temperature uses

They are also employed in automotive systems, hydraulic tubes and also in aircraft systems.

Checking up 8. 8

1. Draw the structure of each of the compound below:

- a. Butanenitrile
- b. 3-methylpentanenitrile

2. Name these compounds:

- a. $\text{CH}_3\text{CH}_2\text{CH}_2\text{CH}(\text{CH}_3)\text{CN}$
- b. $\text{CH}_3\text{CH}(\text{CH}_3)\text{CH}(\text{CH}_3)\text{CN}$

3. Draw all possible isomers of molecular formula $\text{C}_4\text{H}_7\text{N}$ and name them.

8.9. Preparation and chemical properties of nitriles

Activity 8. 9

One method of preparing nitriles is to dehydrate an amide.

1. Use your knowledge about chemistry of alkyl halides and suggest another preparation method.
2. Name the reaction mechanism involved in that method
3. Write an equation of the preparation of propanenitrile using the method you have suggested

8.9.1. Preparation of nitriles

Nitriles are prepared by dehydration of amides under reflux in the presence of phosphorous (V) oxide, P_2O_5 or sulphur dichloride oxide, $SOCl_2$ and there is elimination of water molecule.

1. Dehydration of amides

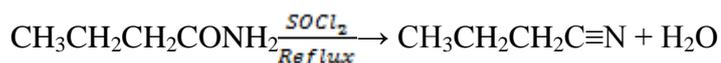

2. Nucleophilic substitution of halogenoalkanes

The halogenoalkane is heated under reflux with a solution of sodium or potassium cyanide in ethanol. The halogen is replaced by a -CN group and a nitrile is produced.

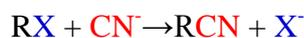

8.9.2. Chemical properties of Nitriles

Nitrile compounds undergo various reactions. Nitriles are hydrolyzed in the presence of an acid or a base to form carboxamides and carboxylic acids. This is the reason why they are considered to be acid derivatives while they have no acyl group.

1. Hydrolysis

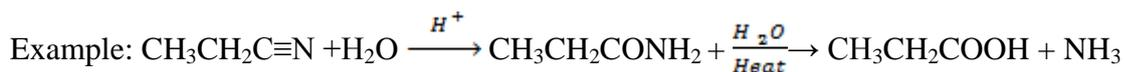

2. Reduction reaction

Nitriles can be reduced by $LiAlH_4$ to produce primary amines in the presence of catalysts such as H_2/Pd .

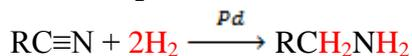

Checking up 8.9.

1. An aldehyde of molecular formula C_3H_6O reacts with hydrogen cyanide in strong basic medium to give compound A. compound A undergoes a reduction to give compound B.
 - a. Suggest a reducing agent which can be used to reduce A.
 - b. Draw the structure of the product formed when compound A is treated with hot

acidified water

2. What is meant by the term hydrolysis?
3. Nitriles are considered to be acid derivatives even though they do not have the acyl group. Search from the internet or library a reason for this consideration.

8.10. End Unit assessment

Part I: Objective questions

1. The esters are acyl chlorides
 - a. more reactive than
 - b. equal in reactivity
 - c. less reactive than
2. Secondary amines react with acid chloride to give
 - a. amines
 - b. carboxylic acids
 - c. amides
 - d. imines
3. A mixture of acetic acid and propanoic acid undergo dehydration to give
 - a. acetic anhydride
 - b. propanoic anhydride
 - c. acetic and propanoic anhydrides
 - d. acetic, propanoic and acetic propanoic anhydrides
4. Ethanoyl bromide reacts with sodium propanoate to give
 - a. ethanoic anhydride
 - b. propanoic anhydride
 - c. ethanoic propanoic anhydride
 - d. all of the above
5. Esters are made from the reaction between
 - a. carboxylic acid molecules
 - b. alcohol molecules
 - c. alcohol and carboxylic acid molecules
 - d. acid anhydride and water molecules

6. Ethyl acetate is hydrolyzed by water to give a/an
 - a. lactone
 - b. ester
 - c. acid anhydride
 - d. carboxylic acid and an alcohol
7. The reaction between ethyl ethanoate and dimethylamine gives an
 - a. amide
 - b. imide
 - c. acid anhydride
8. LiAlH_4 reduces Ethanamide to give a/an
 - a. carboxylic acid
 - b. amide
 - c. alcohol
 - d. amine
9. Nitriles can be hydrolyzed with water to give
 - a. alcohols
 - b. aldehydes
 - c. acids
 - d. acids and amides
10. Reduction of nitriles gives
 - a. amide
 - b. amine
 - c. imine
 - d. carboxylic acids

Part II: Structured questions

1. Use equations to show how you could prepare the following compounds, using the organic compounds cited as the only organic substances and any inorganic substance you need:

- $\text{CH}_3\text{CH}_2\text{COOH}$ to $\text{CH}_3\text{CH}_2\text{NH}_2$
- ethyl propanoate to ethanamide
- propanoic acid to propanoic anhydride
- butanenitrile to $\text{CH}_3\text{CH}_2\text{CH}_2\text{NH}_2$
- propanoic acid to N-propylpropanamide

2. Identify compounds A, B, C, D and E, and reagents x, y and z in the following scheme of reactions. Write equations for the reactions involved:

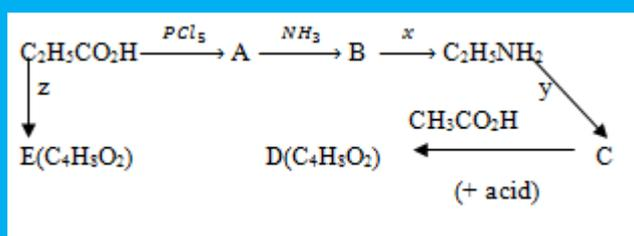

3. Identify the compound corresponding to each letter in the scheme of reactions below:

- $(a) + \text{HBr} \rightleftharpoons (b) + \text{H}_2\text{O}$
- $(b) + \text{Mg} \rightarrow (c)$
- $(c) + \text{CO}_2$ plus $\text{H}_2\text{O} \rightarrow (d) + \text{BrMgOH}$
- $(d) + \text{NaOH} \rightarrow (e) + \text{H}_2\text{O}$
- $(d) + \text{PCl}_5 \rightarrow (f) + \text{POCl}_3 + \text{HCl}$
- $(e) + (f) \rightarrow (g) + \text{NaCl}$
- $(a) + (g) \rightarrow \text{CH}_3\text{CH}_2\text{CO}_2\text{CH}_2\text{CH}_3 + \text{CH}_3\text{CH}_2\text{COOH}$

4. Name the following:

- a. $\text{CH}_3\text{CH}_2\text{COOCH}_3$
 - b. $\text{CH}_3\text{CH}_2\text{CONHCH}_3$
 - c. $\text{CH}_3\text{COOOCCH}_2\text{CH}_3$
 - d. $\text{CH}_3\text{CH}_2\text{CN}$
 - e. $\text{CH}_3\text{CON}(\text{CH}_3)_2$
5. Draw the structural formula of:
- a. 2-chloropropanamide
 - b. Methylpentanoate
 - c. Butanoic anhydride
 - d. Propanoyl chloride
 - e. N-ethyl-N-propylbutanamide
6. Give the organic products of the following reactions:
- a. Propanoic acid and ammonia.
 - b. Ethanoyl chloride plus methanol.
 - c. Butanoic anhydride plus water.
 - d. Propanamide plus sodium hypobromite
 - e. Ethanol plus propanoyl chloride
7. Give reagents, essential conditions and equations for the conversion of ethanoic acid into:
- a. Ethanoic anhydride
 - b. Ethanamide
 - c. Ethyl ethanoate
8. Ethanoic anhydride is a liquid at room temperature but Ethanamide is a solid. Comment briefly on this.
9. Discuss the uses of esters.
10. a. Write an equation for the formation of ethyl ethanoate from ethanoyl chloride and ethanol. Name and outline the mechanism for the reaction taking place.
- b. Explain why dilute sodium hydroxide will cause holes in clothing made from

polymers such as terylene while polythene containers can store caustic soda.

11. Ethyl oleate is an ester with the molecular structure below:



It is possible the body could synthesize this compound from the ethanol present in alcoholic drinks and the natural fatty acid, oleic acid.

- Write the structural formula of oleic acid
- Construct a balanced equation for the production of ethyl oleate from ethanol and oleic acid.
- Suggest how oleic acid can be obtained from the triglyceride below

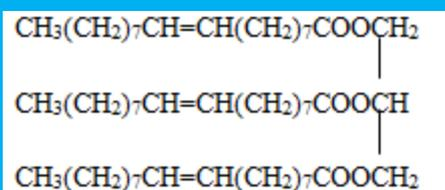

12. This question is about the reactions of carboxylic acids and their derivatives.

- A carboxylic derivative X was found to contain C, H, N and O. analysis gave the following percentage composition by mass: 49.4%, 9.6% and 19.1% for carbon, hydrogen and nitrogen respectively. Compound X had a relative molecular of 73.
 - Calculate the empirical and molecular formulae of X.
 - Suggest three possible structures of X.
- Acyl chlorides such as ethanoyl chloride undergo several reactions due to their high reactivity. What could be produced when ethanoyl chloride reacts with:
 - Water
 - Propan-2-ol
 - Ammonia
 - Sodium acetate
- A and B are two isomeric amides which can be hydrolyzed in acidic medium.

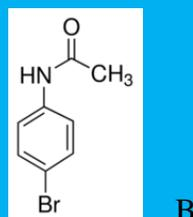
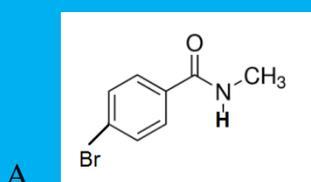

- i. Draw the structures of the products formed from hydrolyzing A and B.
- ii. What is the structure of the compound produced when A reacts with sodium hypobromite?
- iii. Write an equation for the reaction of B with ethanoyl chloride.

UNIT 9. AMINES AND AMINO ACIDS

Key unit competency:

The learner should be able to relate the chemical nature of the amines and aminoacids to their properties, uses and reactivity.

Introductory activity

Read the text below, observe the accompanying images and answer to the questions.

The cell is the basic structural, functional, and biological unit of all known living organisms. A cell is the smallest unit of life. All cells are made up of Inorganic compounds and Organic compounds. **Inorganic compounds** are compounds that do not contain carbon atoms while **organic compounds** are compounds that mainly contain carbon (C) and hydrogen (H) atoms, and eventually other elements such as oxygen (O) and nitrogen (N) in biological macromolecules that include the **carbohydrates, lipids, proteins** and **nucleic acids**.

Proteins are macromolecules consisting of one or more long chains of **amino acid residues**. Proteins differ from one another primarily in their sequence of **amino acids** which is dictated by the nucleotide sequence of their genes, and which usually results in protein folding into a specific three-dimensional structure that determines its activity. **Nucleic acids** [Deoxyribonucleic acid (DNA) and ribonucleic acid (RNA)] alongside proteins, lipids and complex carbohydrates (polysaccharides), are one of the four major types of macromolecules that are essential for all known forms of life. They are a thread-like chain of nucleotides carrying the genetic instructions used in the growth, development, functioning and reproduction of all known living organisms and many viruses.

The image below shows the partial molecular structure of **DNA** (A) and of a **protein** (B, C).

A

Nucleotide
Hydrogen bonds
Sugar-phosphate backbone

Key
Adenine (A)
Thymine (T)
Cytosine (C)
Guanine (G)

B

Primary structure
amino acid sequence

Ala, Arg, Asp, Cys, Glu, Gln, Ile, Leu, Met, Phe, Pro, Trp, Tyr, Val, Asn

alpha helix
beta strand

C

The protein
molecular structure of the protein

Oxygen
Carbon
Nitrogen
Amino acid side chain
Hydrogen

1. Identify the common point between DNA and proteins. Explain your answer.
2. The terminology **“amino acid”** is found in the text and image above. According to you, what is it, and what is its role in living organisms?
3. If protein molecules are made essentially of Carbon, Hydrogen, Oxygen, Nitrogen and amino acid side chains (figure C),
 - a. What kind of bonds do you expect to see in those structures?
 - b. What kind of reactions do expect in those molecules?

9.1. Nomenclature and classification of amines

Activity 9.1

Pentan-2-ol, butan-1-ol and 2-methylpropan-2-ol are alcohols.

1. For each one:
 - a. give its molecular formula
 - b. give its structural formula
 - c. give its displayed formula
 - d. give its skeletal formula
 - e. State whether it is a primary, secondary or tertiary alcohol.
2. Give the general formula that is used to represent alcohols.
3. Two of the alcohols in this question are isomers of each other. Identify which two and identify the type of isomerism they show.
4. Name the alcohol whose structural formula is $\text{CH}_3\text{CH}_2\text{COH}(\text{CH}_3)_2$.

Amines are one of organic compounds containing nitrogen. They are one of the most important classes of organic compounds which are *obtained by replacing one or more hydrogen atoms by an alkyl or aryl group in a molecule of ammonia (NH₃)*. They are present in vitamins, proteins, hormones, etc. They are extensively used in the manufacturing of many drugs and detergents.

9.1.1 Classification of amines

Nitrogen has 5 valence electrons and so is trivalent with a lone pair. As per VSEPR theory, nitrogen present in amines is sp³ hybridized and due to the presence of lone pair, it is pyramidal in shape instead of tetrahedral shape which is a general structure for most sp³ hybridized molecules. Each of the three sp³ hybridized orbitals of nitrogen overlap with orbitals of hydrogen or carbon depending upon the configuration of amines. Due to the presence of lone pair, the C-N-H angle in amines is less than 109 degrees which is characteristic angle of tetrahedral geometry. The angle in amines is near about 108 degrees.

The general formula of amines contains NH₂ functional group. Amines have as general formula, RNH₂, where R may be H or a hydrocarbon group. Depending upon the number of hydrogen atoms that are replaced by an alkyl or aryl group in ammonia, amines are classified as *primary*, *secondary* and *tertiary* (Table 9.1).

Table 9.1. Classification of amines and examples

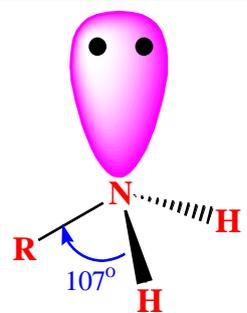
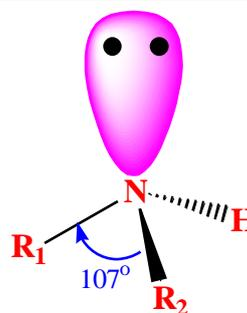
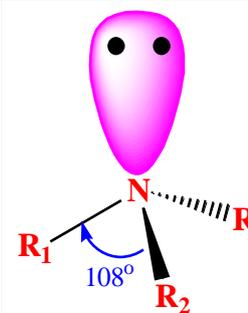
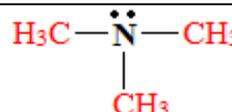
	<i>Primary amine</i>	<i>Secondary amine</i>	<i>Tertiary amine</i>
General structure	 <p>One of the three hydrogens of ammonia is replaced by an alkyl group</p>	 <p>Two of the three hydrogens of ammonia is replaced by an alkyl group</p>	 <p>All the three hydrogens of ammonia is replaced by an alkyl group</p>
Examples	$\text{CH}_3 - \text{CH}_2 - \text{NH}_2$	$\text{CH}_3 - \text{NH} - \text{CH}_3$	

9.1.2 Nomenclature of amines

In organic chemistry, the names of the compounds are given according to the guidelines provided by IUPAC. In this regards, amines are named by ending with *-amine*. The *IUPAC* system names amine functions as substituents on the largest alkyl group.

Examples:

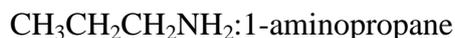

If there is another priority functional group as well as the amine group then the prefix amino is used. Example:

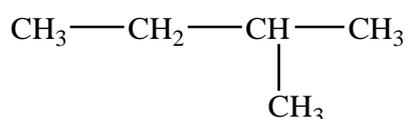

If the amine is secondary and has two alkyl groups attached to the nitrogen, then each chain is named and the smaller alkyl group is preceded by an *-N* which plays the same role as a number in positioning a side alkyl chain.

Example: $\text{CH}_3\text{CH}_2\text{CH}_2\text{NHCH}_3$: *N*-methylpropylamine is the common name and *N*-methyl-1-aminopropane is the IUPAC name.

If in the common naming the lengths of the chain are the same, an *-N* is not used as shown in the following example:

$\text{CH}_3\text{CH}_2\text{-NH-CH}_2\text{CH}_3$ (*Diethylamine* is the common name which does not contain *N* because the chains have the same length and *N*-ethylethanamine is the IUPAC where *N* does appear.

In case of a tertiary amine, the use of *N* is applied at each alkyl side group.

Example:

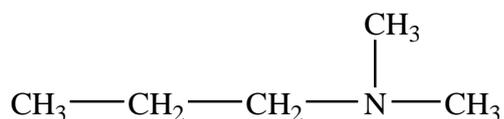

N,N-dimethylpropylamine (common name)

N,N-dimethyl-1-aminopropane (IUPAC name)

The following are examples of primary, secondary and tertiary amines (Table 9.2) with their corresponding names using IUPAC or common name.

Table 9.2. Some examples of primary, secondary and tertiary amines

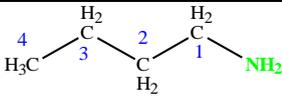
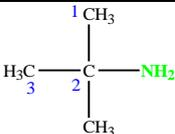
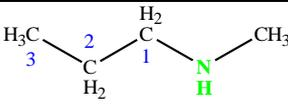
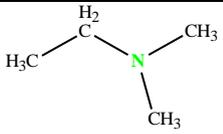
				
	<i>A primary amine</i>	<i>A primary amine</i>	<i>A secondary amine</i>	<i>A tertiary amine</i>
IUPAC name	1-aminobutane	2-amino-2-methylpropane	1-methylaminopropane	dimethylaminoethane
Common name	n-butylamine	tert-butylamine	methylpropylamine	ethyldimethylamine

Aliphatic and Aromatic and heterocyclic amines are named after the groups surrounding the **nitrogen + amine**.

Examples:

1° Aliphatic amines

$C_2H_5NH_2$: ethylamine

$(CH_3)_2NH$: dimethylamine

$(CH_3)_3N$: trimethylamine

2° Aromatic amines

$C_6H_5NH_2$: phenylamine or aniline

In case of heterocyclic amines, there is a systematic nomenclature of these compounds as indicated in the following examples.

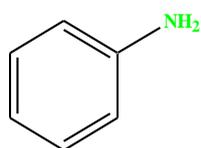

aniline

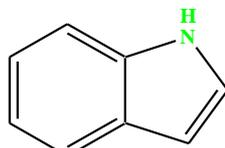

indole

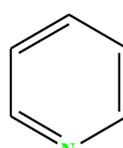

pyridine

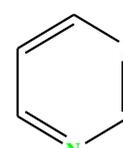

pyrimidine



pyrrolidine

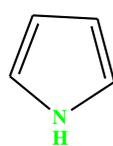

pyrrole

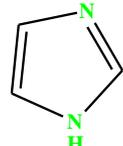

imidazole

Checking up 9.1

1. Classify the following as primary, secondary and tertiary amines.

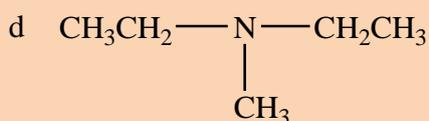
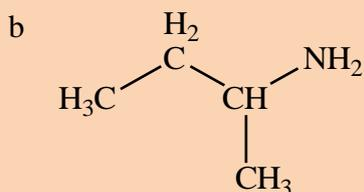
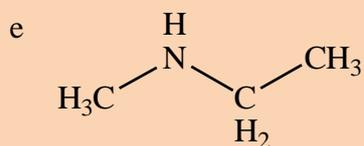
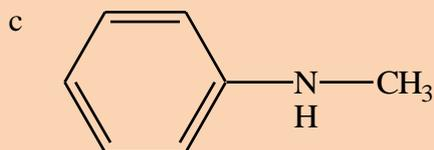
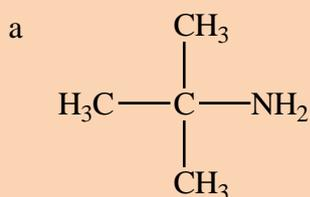

2. For each compound below, provide the respective IUPAC name.

	IUPAC name
CH_3NH_2	
$\text{CH}_3\text{CH}_2\text{CH}_2\text{NH}_2$	
$\text{CH}_3\text{CHNH}_2\text{CH}_3$	
$\text{CH}_3\text{NHCH}_2\text{CH}_3$	
$\text{CH}_3\text{CH}_2\text{N}(\text{CH}_3)\text{CH}_2\text{CH}_2\text{CH}_3$	

3. Write IUPAC names of the following compounds and classify them into primary, secondary and tertiary amines.

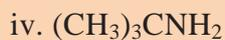
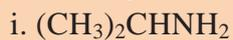

- v. $\text{C}_6\text{H}_5\text{NHCH}_3$
 vi. $(\text{CH}_3\text{CH}_2)_2\text{NCH}_3$
 vii. *m*- $\text{BrC}_6\text{H}_4\text{NH}_2$

9.2 Physical properties, natural occurrences and uses of amines

Activity 9.2

Calculate the molecular mass of the given products and justify the difference between boiling points of amines, alkanes and alcohols

Compound	Molecular mass	Boiling point
Methanol (CH_3OH)		65°C
Methylamine (CH_3NH_2)		-6°C
Ethane (CH_3CH_3)		-89°C
1-propanol ($\text{CH}_3\text{CH}_2\text{CH}_2\text{OH}$)		97°C
propyl Amine ($\text{CH}_3\text{CH}_2\text{CH}_2\text{NH}_2$)		48°C
Ethylmethylamine ($\text{CH}_3\text{NHCH}_2\text{CH}_3$)		36°C
Trimethylamine $\text{N}(\text{CH}_3)_3$		2.9°C
Butane ($\text{CH}_3\text{CH}_2\text{CH}_2\text{CH}_3$)		-0.5°C
Butylamine (<i>n</i> - $\text{C}_4\text{H}_9\text{NH}_2$)		77.65°C
Diethyl-amine [$(\text{C}_2\text{H}_5)_2\text{NH}$]		56.15°C
Ethyl-dimethyl-amine [$\text{C}_2\text{H}_5\text{N}(\text{CH}_3)_2$]		37.35°C
2-Methyl-butane [$\text{C}_2\text{H}_5\text{CH}(\text{CH}_3)_2$]		27.65°C
Butan-1-ol (<i>n</i> - $\text{C}_4\text{H}_9\text{OH}$)		117.15°C

9.2.1 Physical properties of amines

Primary and secondary amines can form a hydrogen bond to each other (as shown in the Figure 9.1 below where two molecules of $\text{H}_3\text{C}-\text{NH}_2$ are bonded together).

Because Nitrogen is less electronegative than oxygen, the $\text{N}-\text{H}$ bond is not quite as polar as the $\text{O}-\text{H}$ bond reason why amines are not strong as alcohol molecules. Primary and

secondary amines have lower boiling points than alcohols of similar molecular weight due to their hydrogen bonding.

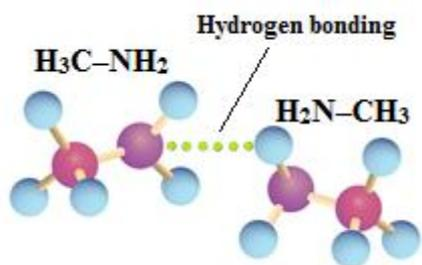
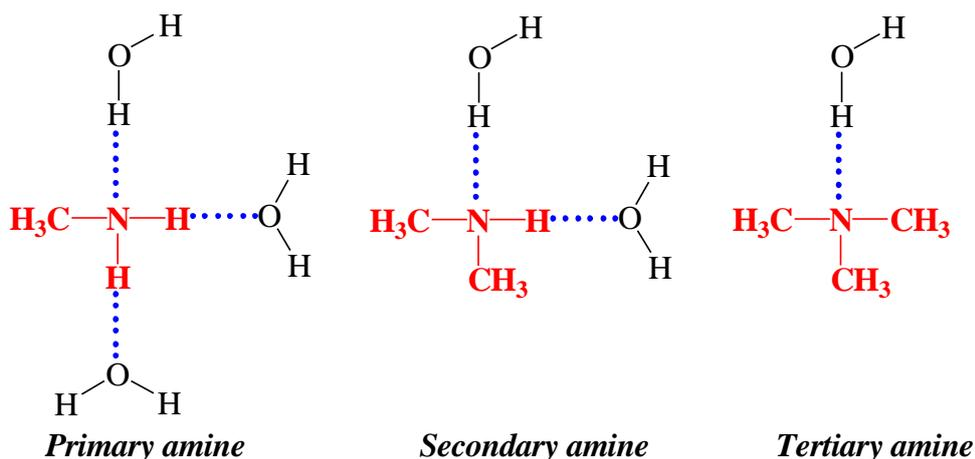

Figure 9.1. Hydrogen bonding between two amine molecules

Tertiary amines do not bond to each other by hydrogen bond and they have boiling points similar to hydrocarbons of the same molecular weight. However, primary, secondary and tertiary amines form hydrogen bond with water and amines with low-molecular weight are generally soluble in water.

Example of hydrogen bond between amines and water:



Generally the boiling point of amines increases as the molecular weight increase and they boil at higher temperatures than alkanes but at lower temperatures than alcohols of comparable molar mass.

The amines are soluble in organic solvent and the solubility decreases as the molecular weight increases. The Table 9.3 summarizes some physical properties of some amines.

Table 9.3: Physical Properties of Some Amines Compared to some Oxygen-Containing Compounds

Name	Condensed Structural Formula	Class	Molar Mass	Boiling Point (°C)	Solubility at 25°C (g/ 100g Water)
Butylamine	$\text{CH}_3\text{CH}_2\text{CH}_2\text{CH}_2\text{NH}_2$	Primary amine	73	78	miscible
Diethylamine	$(\text{CH}_3\text{CH}_2)_2\text{NH}$	Secondary amine	73	55	miscible
Butylalcohol	$\text{CH}_3\text{CH}_2\text{CH}_2\text{CH}_2\text{OH}$	—	74	118	8
Dipropylamine	$(\text{CH}_3\text{CH}_2\text{CH}_2)_2\text{NH}$	Secondary amine	101	111	4
Triethylamine	$(\text{CH}_3\text{CH}_2)_3\text{N}$	Tertiary amine	101	90	14
Dipropylether	$(\text{CH}_3\text{CH}_2\text{CH}_2)_2\text{O}$	—	102	91	0.25

Amines tend to be gases at low molecular weight (e.g. up to $(\text{CH}_3)_3\text{N}$, trimethylamine) and the heavier ones are liquids at room temperature. In fact, Methyl, dimethyl, trimethyl, and ethyl -amines *are gases* under standard conditions. Most common alkyl amines are *liquids*, and high molecular weight amines are, quite naturally, *solids* at standard temperatures. Additionally, gaseous amines possess a characteristic *ammonia smell*, while liquid amines have a distinctive "fishy" smell: higher molecular-weight amines often **smell like rotting fish**, and are often **found in decaying animal tissues**. Cadaverine [$\text{H}_2\text{N}(\text{CH}_2)_5\text{NH}_2$] and putrescine [$\text{H}_2\text{N}(\text{CH}_2)_4\text{NH}_2$] are some of the examples. The lower molecular-weight amines with up to about five carbon atoms are *soluble in water*. The higher-molecular-weight amines that are *insoluble in water* will dissolve in acid to form ionic amine salts.

9.2.2 Natural occurrence of amines and their usage

Naturally amines occur in proteins, vitamins, hormones, etc. and they are also prepared synthetically to make polymers, drugs and dyes.

Amines can be used as dyes (colorants) or as drugs: Primary aromatic amines are used as a starting material for the manufacture of azo dyes. They react with nitrous (II) acid to form diazonium salt which can undergo a coupling reaction in order to form an azo compound. As azo compounds are highly coloured, they are widely used in dyeing industries. Examples include Methyl orange and Direct brown 138.

In medicine, amines can be used as drugs.

- *Chlorpheniramine* is an antihistamine that helps to relief allergic disorders due to cold, hay fever, itchy skin, insect bites and stings.
- *Diphenhydramine* is the common antihistamine.
- *Chlorpromazine* is a tranquillizer that anaesthetizes without inducing sleep. It is used to relieve anxiety, excitement, restlessness or even mental disorder.
- *Acetaminophen* is also known as *paracetamol* or *p-acetaminophenol*, it is an analgesic that relieves pains such as headaches. It is believed to be less corrosive to the stomach and is an alternative to aspirin.

Amines are widely encountered in biological and pharmacological studies. Some important examples are the 2-phenylethylamines, some vitamins, antihistamines, tranquilizers, and neurotransmitters (noradrenaline, dopamine and serotonin) which act at neuromuscular synapses.

Checking up 9.2

1. Which compound of each pair has the higher boiling point? Explain.
 - a. butylamine or pentane
 - b. CH_3NH_2 or $\text{CH}_3\text{CH}_2\text{CH}_2\text{CH}_2\text{CH}_2\text{NH}_2$
2. Between the two compounds $\text{CH}_3\text{CH}_2\text{CH}_3$ and $\text{CH}_3\text{CH}_2\text{NH}_2$, explain which is more soluble in water.

9.3 Preparation of amines

Activity 9.3

Ammonia (NH_3) molecules react with water molecules. Write the detailed chemical equation of that reaction.

The amines can be prepared based on the following reactions:

9.3.1 Alkylation of ammonia

Primary amines can be synthesized by alkylation of ammonia. The reaction involves nucleophilic substitution of an alkyl halide when ammonia is used as nucleophilic agent. The reaction is carried out in a sealed tube at 100°C or 373 K .



9.3.2. Gabriel phthalimide synthesis

This procedure is used for the preparation of primary amines. Phthalimide on treatment with ethanolic potassium hydroxide forms potassium salt of phthalimide which on heating with

alkyl halide followed by alkaline hydrolysis produces the corresponding primary amine. However, primary aromatic amines cannot be prepared by Gabriel phthalimide synthesis because aryl halides do not undergo nucleophilic substitution with the anion formed by phthalimide.

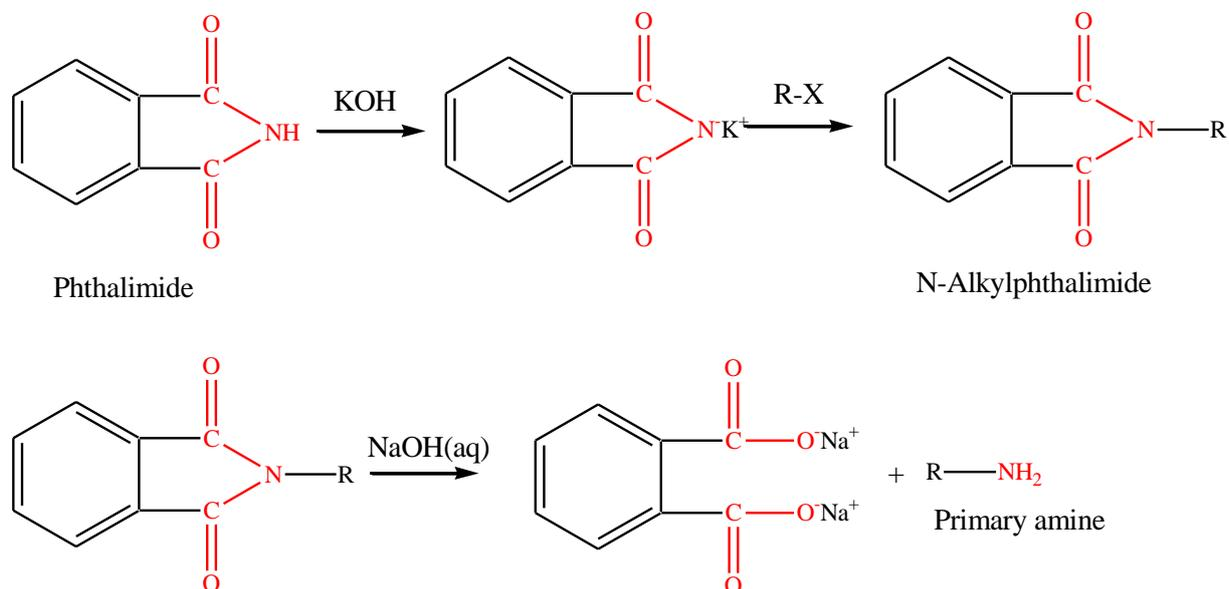

9.3.3. Hoffmann bromamide degradation reaction

Hoffmann developed a method for the preparation of primary amines by treating an amide with bromine in an aqueous or ethanolic solution of sodium hydroxide. This is a degradation reaction with migration of an alkyl or aryl group taking place from carbonyl carbon of the amide to the nitrogen atom.

The reaction is valid for the preparation of primary amines only, and it yields uncontaminated compound with other amines.

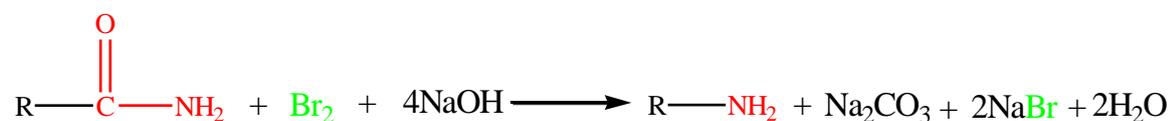

9.3.4 Reduction of amides

Similarly to reduction of amides, lithium aluminium hydride (LiAlH_4) reduces amides to amines.

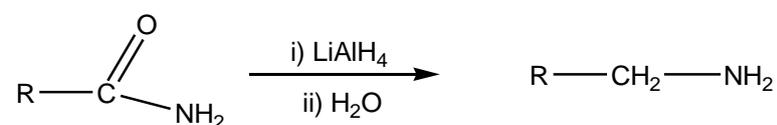

9.3.5 Reduction of nitriles

Nitriles are reduced to amines using hydrogen in the presence of a nickel catalyst, although acidic or alkaline conditions should not be used to avoid the possible hydrolysis of the -CN group. LiAlH_4 is more commonly employed for the reduction of nitriles on the laboratory scale.

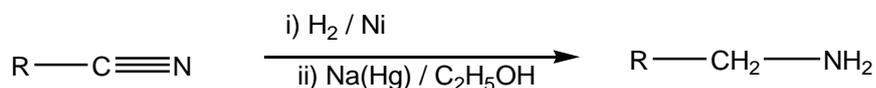

9.3.6 Reduction of nitro compounds

Nitro compounds are reduced to amines by passing hydrogen gas in the presence of finely divided nickel, palladium or platinum and also by reduction with metals in acidic medium. Nitroalkanes can also be similarly reduced to the corresponding alkanamines.

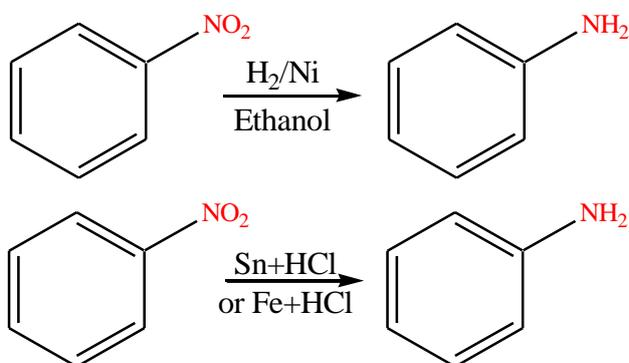

Reduction with iron scrap and hydrochloric acid is preferred because FeCl_2 formed gets hydrolysed to release hydrochloric acid during the reaction. Thus, only a small amount of hydrochloric acid is required to initiate the reaction.

Checking up 9.3

1. Give two reagents that could be used to synthesize the following reaction.
 - a. $(\text{CH}_3)_2\text{CHCN}$
 - b. $(\text{CH}_3)_2\text{CHCH}_2\text{NH}_2$
2. Discuss the conditions for using each of the reagents of your choice.
3. Write chemical equations for the following reactions:
 - a. Reaction of ethanolic NH_3 with $\text{C}_2\text{H}_5\text{Cl}$.
 - b. Ammonolysis of benzoyl chloride and reaction of amine so formed with two moles of CH_3Cl .

9.4. Chemical properties of amines

Activity 9.4

Experiment: In a solution of ethylamine at room temperature (A), add dilute hydrochloric acid (B). After a while (C), add excess of sodium hydroxide in the solution (D) to obtain the solution E.

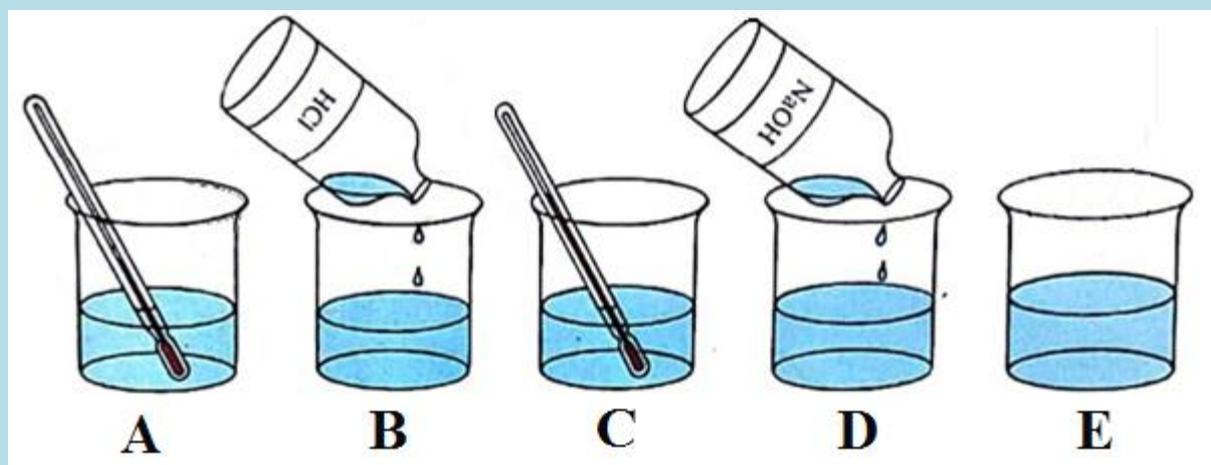

Explain:

1. What evidence is there for a chemical reaction between ethylamine and hydrochloric acid?
2. Why does the smell of ethylamine disappear when hydrochloric acid is added?
3. Why does the smell reappear when sodium hydroxide is added?

Difference in electronegativity between nitrogen and hydrogen atoms and the presence of unshared pair of electrons over the nitrogen atom makes amines reactive. The number of hydrogen atoms attached to nitrogen atom also is involved in the reaction of amines; that is why the reactivity of amines differ in many reactions. Amines behave as nucleophiles due to the presence of unshared electron pair (as shown below in primary, secondary and tertiary functional group of amines).

Primary (-NH_2), secondary ($\text{$) and tertiary amines ($\text{$). The chemical properties of amines are summarized in the reactions below.

9.4.1 Reactions of amines diluted with acids

Amines, like ammonia, are bases. Being basic in nature, they react with acids to form salts.



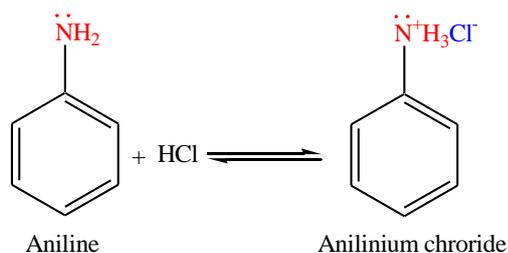

Amine salts on treatment with a base like NaOH, regenerate the parent amine.



Example:

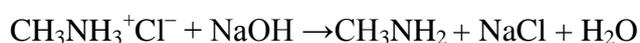
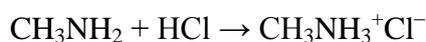

9.4.2 Reactions of amines (alkylation, acylation, and sulfonation)

Acyl chlorides and acid anhydrides react with primary and secondary amines to form amides. Tertiary amines cannot be acylated due to the absence of a replaceable hydrogen atom.

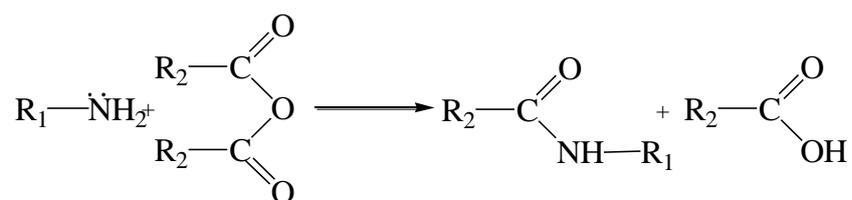
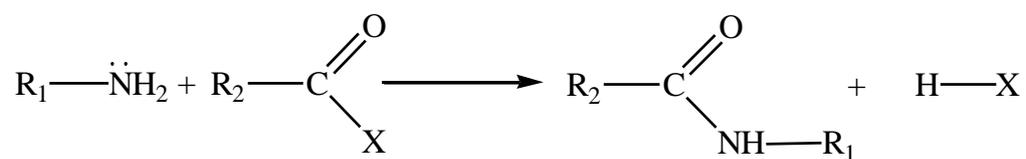

9.4.3. Reaction with carboxylic acid

Because amines are basic, they neutralize carboxylic acids to form the corresponding ammonium carboxylate salts. Upon heating at 200°C, the primary and secondary amine salts dehydrate to form the corresponding amides.

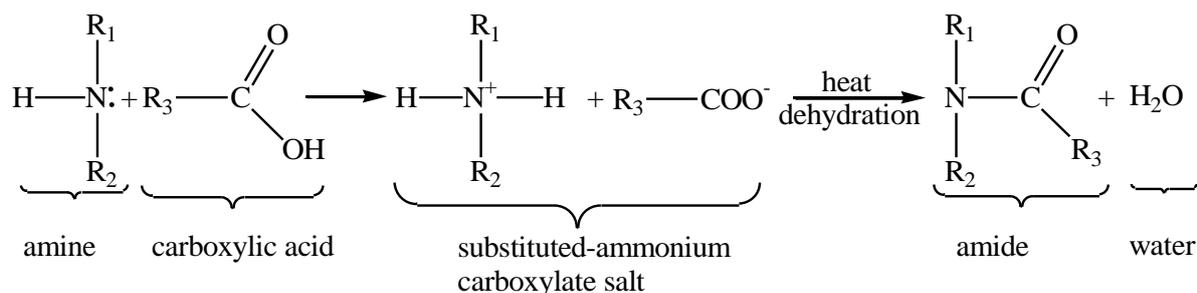

9.4.4. Reaction with nitrous acid

Nitrous acid, HNO_2 is unstable. It is produced indirectly using a mixture of NaNO_2 and a strong acid such as HCl or H_2SO_4 in diluted concentration. Primary aliphatic amines react with nitrous acid to produce a very unstable diazonium salts which spontaneously decomposes by losing N_2 to form a carbenium ion. Further, the carbenium ion is used to produce a mixture of alkenes, alkanols or alkyl halides, with alkanols as major product said above

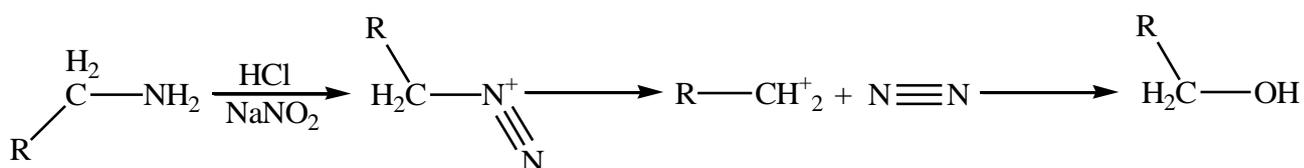
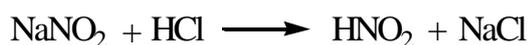

Primary aromatic amines, such as aniline (phenylamine) forms a more stable diazonium ion at 0°C – 5°C . Above 5°C , it will decompose to give phenol and N_2 . Diazonium salts can be isolated in the crystalline form but are usually used in solution and immediately after preparation, due to its rapid decomposition.

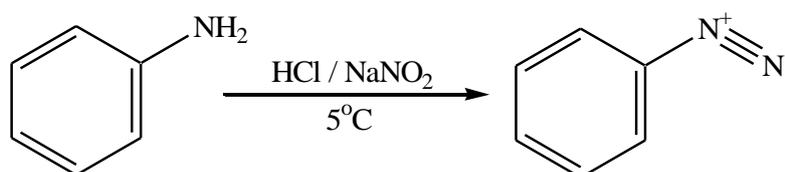

9.4.5. Reactions with ketones and aldehydes

Primary amines react with carbonyl compounds to form imines. Specifically, aldehydes become aldimines, and ketones become ketimines. In the case of formaldehyde ($\text{R}' = \text{H}$), the imine products are typically cyclic trimers.



Secondary amines react with ketones and aldehydes to form enamines. An enamine contains a C=C double bond, where the second C is singly bonded to N as part of an amine ligand.

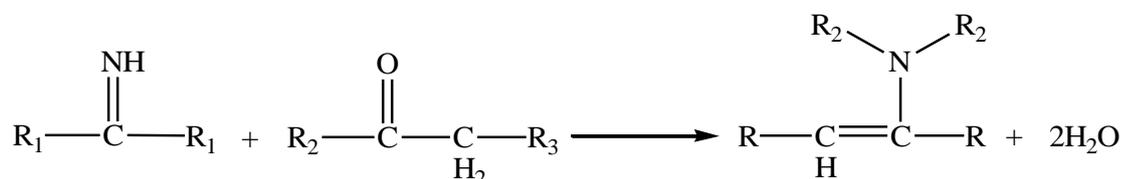

9.4.6. Neutralization reactions

Tertiary amines (R_3N) react with strong acids such as hydroiodic acid (HI), hydrobromic acid (HBr) and hydrochloric acid (HCl) to give ammonium salts R_3NH^+ .

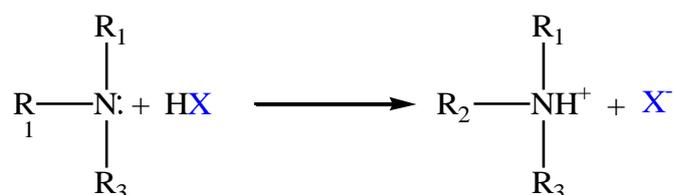

Checking up 9.4

- Draw the structures of all amines of molecular formula $C_4H_{11}N$. Classify them as primary, secondary and tertiary amines
- Write the equation for the reaction which happens when dimethylamine, $(CH_3)_2NH$, reacts with water.
 - Write the formula of the product of the reaction between trimethylamine gas, $(CH_3)_3N$, and hydrogen chloride gas, showing the essential details of its structure.
- Nitrous acid is unstable and has to be produced in the same test tube as the reaction is happening in. If you were to test an amine with nitrous acid, how would you do it?
- This question is about the reactions between amines and halogenoalkanes (alkylhalides).
 - The reaction between bromoethane and ethylamine produces a complicated mixture of products, but the first to be formed are given by the equations below:

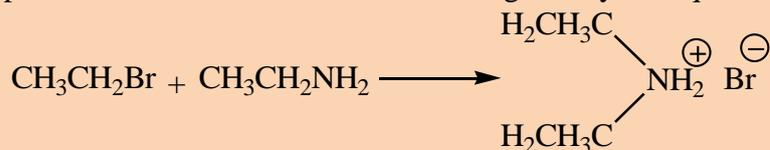

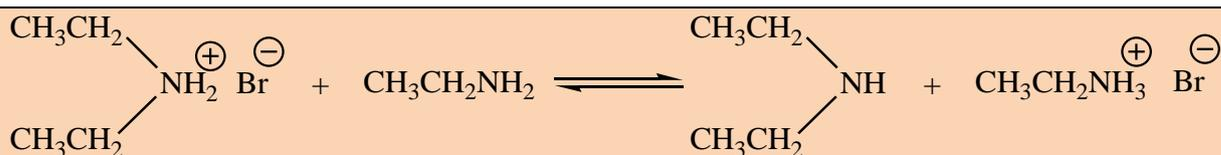

Describe in words what is happening.

These next three questions are deliberately made **uncooperative** so that you can only do them by understanding what you have read, and not just learning it. Take your time over them.

- Write the formulae for the corresponding products of the reaction if you started with methylamine rather than ethylamine, but still reacted it with bromoethane.
- If you started with a secondary amine such as dimethylamine, you would initially get a tertiary amine and its salt in the mixture. Write the formulae of these products if you reacted dimethylamine with bromoethane.
- Draw the structure of the product that you would get if you reacted the tertiary amine trimethylamine with bromoethane.

9.5. General structure of amino acids and some common examples

Activity 9.5

Amines are molecules that have as general formula, R-NH₂ while *carboxylic acids* have as general formula, R-COOH. Predict a general structure (skeletal formula) of a molecule that contains an *amino group* and a *carboxyl group* on an aliphatic chain.

9.5.1. General structure of amino acids

Amino acids are organic compounds containing amine (-NH₂) and carboxyl (-COOH) functional groups, along with a side chain (R group) specific to each amino acid. The key elements of an amino acid are carbon (C), hydrogen (H), oxygen (O), and nitrogen (N). About 500 naturally occurring amino acids are known.

The general structure of amino acid is shown by the functional group (-NH₂) and a carboxylic acid group (-COOH) attached to the same carbon and they are called ***α-amino acids***.

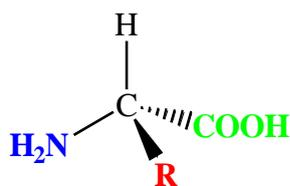

2-amino acid

The **R** group is the part of the amino acid that can vary in different amino acids. It can be a hydrogen (in that case, the amino acid is called *Glycine*) or a $-\text{CH}_3$ group (Alanine) or other radicals. Examples of amino acid are proteins that are linear polymers of amino acids.

9.5.2. Common Amino Acids

Among the 500 known amino acids, there are 20 important α -amino acids, as shown in the Table 9.4 below. Each amino acid has a **common name**. You will notice that the names in common used for amino acids are not descriptive of their structural formulas; but at least they have the advantage of being shorter than the **systematic names**. The **abbreviations** (Gly, Glu, ...) that are listed in table below, are particularly useful in designating the sequences of amino acids in proteins and peptides.

Table 9.4: Common amino acids and their formulas [adapted from (Chang, 2005) and (Schmitz, 2018)]

#	Common Name & Systematic name	Abbreviation	Structural Formula (at pH 6)	Molar Mass	Distinctive Feature
1	Glycine <i>2-Amino acetic acid</i>	Gly (G)		75	the only amino acid lacking a chiral carbon
2	Alanine <i>2-Amino-propionic acid</i>	Ala (A)		89	—

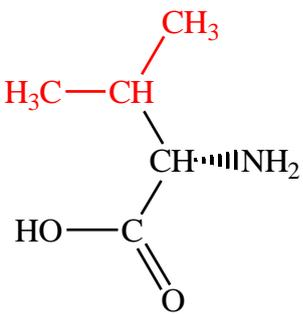
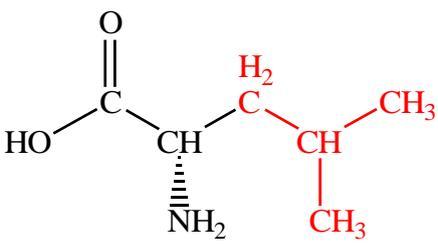
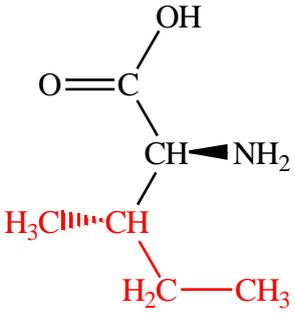
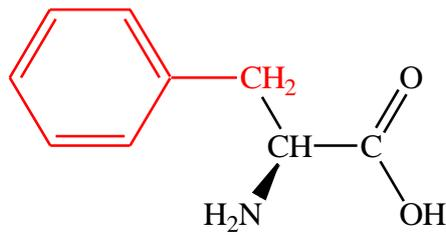
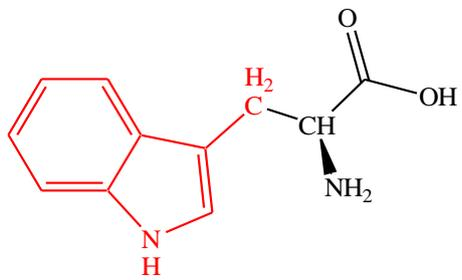
#	Common Name & Systematic name	Abbreviation	Structural Formula (at pH 6)	Molar Mass	Distinctive Feature
3	Valine <i>2-Amino-3-methylbutyric acid</i>	Val (V)		117	a branched-chain amino acid
4	Leucine <i>2-Amino-4-methylpentanoic acid</i>	Leu (L)		131	a branched-chain amino acid
5	Isoleucine <i>2-Amino-3-methylpentanoic acid</i>	Ile (I)		131	an essential amino acid because most animals cannot synthesize branched-chain amino acids
6	Phenylalanine <i>2-Amino-3-phenylpropionic acid</i>	Phe (F)		165	also classified as an aromatic amino acid
7	Tryptophan <i>2-Amino-3-(1H-indol-3-yl)propionic acid</i>	Trp (W)		204	also classified as an aromatic amino acid

#	Common Name & Systematic name	Abbreviation	Structural Formula (at pH 6)	Molar Mass	Distinctive Feature
8	Methionine <i>2-Amino-4-methylsulfanyl-butyric acid</i>	Met (M)		149	side chain functions as a methyl group donor
9	Proline <i>Pyrrolidine-2-carboxylic acid</i>	Pro (P)		115	contains a secondary amine group; referred to as an α -imino acid
10	Serine <i>2-Amino-3-hydroxy-propionic acid</i>	Ser (S)		105	found at the active site of many enzymes
11	Threonine <i>2-Amino-3-hydroxy-butyric acid</i>	Thr (T)		119	named for its similarity to the sugar threose
12	Cysteine <i>2-Amino-3-mercapto-propionic acid</i>	Cys (C)		121	oxidation of two cysteine molecules yields <i>cystine</i>
13	Tyrosine <i>2-Amino-3-(4-hydroxy-phenyl)-propionic acid</i>	Tyr (Y)		181	also classified as an aromatic amino acid

#	Common Name & Systematic name	Abbreviation	Structural Formula (at pH 6)	Molar Mass	Distinctive Feature
14	Asparagine <i>2-Amino-succinamic acid</i>	Asn (N)		132	the amide of aspartic acid
15	Glutamine <i>2-Amino-4-carbamoyl-butyric acid</i>	Gln (Q)		146	the amide of glutamic acid
16	Aspartic acid <i>2-Amino-succinic acid</i>	Asp (D)		132	carboxyl groups are ionized at physiological pH; also known as aspartate
17	Glutamic acid <i>2-Amino-pentanedioic acid</i>	Glu (E)		146	carboxyl groups are ionized at physiological pH; also known as glutamate
18	Histidine <i>2-Amino-3-(1H-imidazol-4-yl)-propionic acid</i>	His (H)		155	the only amino acid whose R group has a pKa (6.0) near physiological pH
19	Lysine <i>2,6-Diamino-hexanoic acid</i>	Lys (K)		147	—

#	Common Name & Systematic name	Abbreviation	Structural Formula (at pH 6)	Molar Mass	Distinctive Feature
20	Arginine <i>2-Amino-5-guanidino-pentanoic acid</i>	Arg (R)		175	almost as strong a base as sodium hydroxide

The first amino acid to be isolated was asparagine in 1806. It was obtained from protein found in asparagus juice (hence the name). Glycine, the major amino acid found in gelatin, was named for its sweet taste (Greek glykys, meaning “sweet”). In some cases an amino acid found in a protein is actually a derivative of one of the common 20 amino acids.

Checking up 9.5

- Write the side chain of each amino acid.
 - serine
 - arginine
 - phenylalanine
- Draw the structure for each amino acid.
 - alanine
 - cysteine
 - histidine
- Identify an amino acid whose side chain contains:
 - amide functional group.
 - aromatic ring.
 - carboxyl group.

9.6. Comparison of physical properties amino acids to those of carboxylic acids and amines

Activity 9.6

By using examples, distinguish amines, carboxylic acids and amino acids (in different states: gas, liquid, solid) based on their characteristic odour.

The amino acids, carboxylic acids and amines have different functional groups; this is the base of their different physical properties as shown in the Table 9.5.

Table 9.5. Comparison of physical properties of amines, carboxylic acids and amino acids

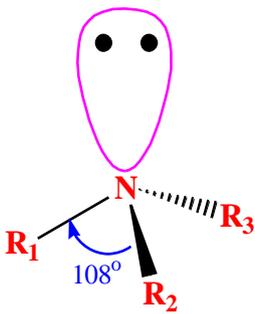
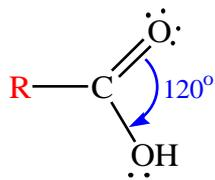
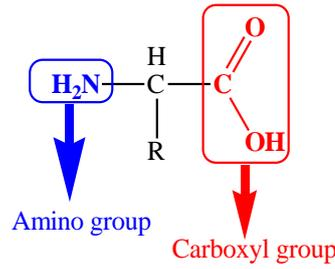
	Amines	Carboxylic acids	Amino acids
General structure			
Hydrogen bond	<ul style="list-style-type: none"> – Primary and secondary amines can form hydrogen bond one to other. – As a result of hydrogen bonding, primary and secondary amines have higher boiling points than alkanes of similar size. – Lone pairs on amines imply their hydrogen bond to water. (water solubility better than alkanes) 	<ul style="list-style-type: none"> – Carboxylic acids are able to form a hydrogen bond. – Carboxylic acids have high boiling points due to their ability to form hydrogen bond one another. – The ability to form hydrogen bonds, in addition to the presence of polar C=O, C-O, and O-H bonds, gives small carboxylic acids a significant water solubility. – An increasing number of carbon atoms leads to a reduction in water solubility. – Their hydrogen bonds enhance the possibility of bringing two acid molecules together by forming a dimer 	<ul style="list-style-type: none"> – No hydrogen bond is found between two amino acids molecules. Rather, they undergo a peptide bond which generates loss of one molecule of water. – Hydrogen bonds exist between two polypeptides chains (chain of many amino acids)..
Physical state	<ul style="list-style-type: none"> – Low molecular weight Amines tend to be gases and many heavier ones are liquids or <i>solids</i> at normal standard temperatures. – Gaseous amines possess a characteristic <i>ammonia smell</i>, while liquid amines have a distinctive 	<ul style="list-style-type: none"> – Many carboxylic acids are colorless liquids with disagreeable odours. – Aliphatic carboxylic acids with 5 to 10 carbon atoms are all liquids which have “goaty” odors. – The acids with more than 10 carbon atoms are wax-like solids, and their odour diminishes with increasing of molar mass and these results in the decreasing degree of volatility. 	<ul style="list-style-type: none"> – The amino acids are crystalline solids with surprisingly high melting points.

	Amines	Carboxylic acids	Amino acids
	<p>"fishy" smell.</p> <ul style="list-style-type: none"> - Volatile amines have strong odors. - Amines smell like rotten fish. - Many amines are physiologically active. - Smaller amines are irritating to the skin, eyes, and mucous membrane and are toxic by ingestion. 		
Melting and boiling point	<ul style="list-style-type: none"> - <i>Primary</i> and <i>secondary amines</i> boil at higher temperatures than alkanes but at lower temperatures than alcohols of comparable molar mass. - The boiling points of <i>tertiary amines</i> is low because they do not form a hydrogen bond. 	<ul style="list-style-type: none"> - Carboxylic acids have high melting and boiling points compared to other organic compounds of the same mass or number of carbon atoms. 	<ul style="list-style-type: none"> - The α-amino acids <i>crystallize as the dipolar forms</i>, $\text{H}_3\text{N}^+-\text{CHR}-\text{CO}_2^-$, and the strong intermolecular electrical forces in the crystals lead to higher melting points than those of simple amines or monocarboxylic acids. - The melting points are so high that decomposition often occurs on melting and tend to be in the 200 – 300°C range.
Solubility	<p>All three classes of amines can engage in hydrogen bonding with water. Amines of low molar mass are quite <i>soluble in water</i>; the borderline of solubility in water is at five or six carbon atoms. The</p>	<ul style="list-style-type: none"> - The carboxyl group readily engages in hydrogen bonding with water molecules. - The acids with one to four carbon atoms are <i>completely miscible with water</i>. - Solubility decreases as the carbon chain length increases because dipole 	<ul style="list-style-type: none"> - Amino acids are generally soluble in water and insoluble in non-polar organic solvents such as hydrocarbons. The extent of the solubility in water varies depending on the size and nature of the "R"

	Amines	Carboxylic acids	Amino acids
	higher-molecular-weight amines that are <i>insoluble in water</i> will dissolve in acid to form ionic amine salts.	forces become less important and dispersion forces become more predominant. – The carboxylic acids generally are <i>soluble in such organic solvents</i> as ethanol, toluene, and diethyl ether.	group. – The dipolar structures of amino acids greatly reduce their solubility in nonpolar organic solvents compared to simple amines and carboxylic acids.

Checking up 9.6

Discuss the solubility of amino acids, referring on the solubility of amines and carboxylic acids.

9.7. Chemical properties of amino acids

Activity 9.7

A and B are organic products formed from the reactions in a) and b) respectively, propose a mechanism of those reactions and identify A and B.



The reactivity of amino acids involves the reactions of both amines and carboxylic acids. Some of these reactions are given below.

9.7.1. Acid–base properties of amino acids

As the name suggests, amino acids are organic compounds that contain both a carboxylic acid group and an amine group. Amino acids are crystalline, high melting point ($>200^\circ\text{C}$) solids. Such high melting points are unusual for a substance with molecules of this size — they are a result of internal ionisation. Even in the solid state, amino acids exist as *zwitterions* in which a proton has been lost from the carboxyl group and accepted by the nitrogen of the amine group:

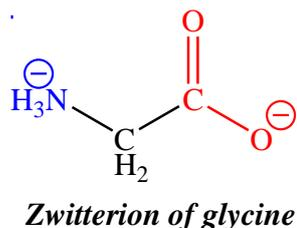
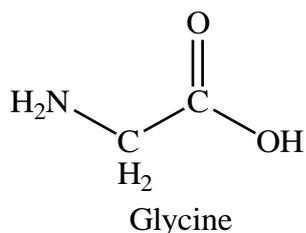

So instead of hydrogen bonds between the amino acid molecules there are stronger ionic (electrovalent) bonds. This is reflected in the relative lack of solubility of amino acids in non-aqueous solvents compared with their solubility in water.

Zwitterions exhibit acid–base behaviour because they can accept and donate protons. In acids a proton is accepted by the carboxylic acid anion, forming a unit with an overall positive charge:

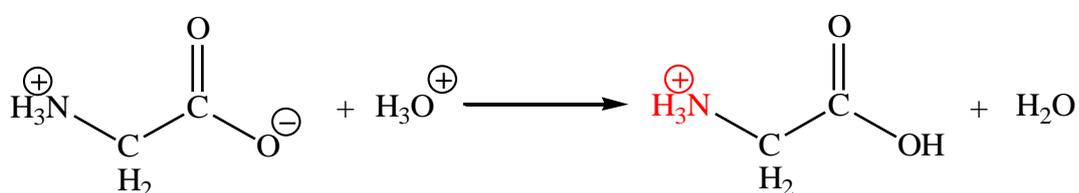

In alkalis the reverse occurs with the loss of a proton from the nitrogen atom:

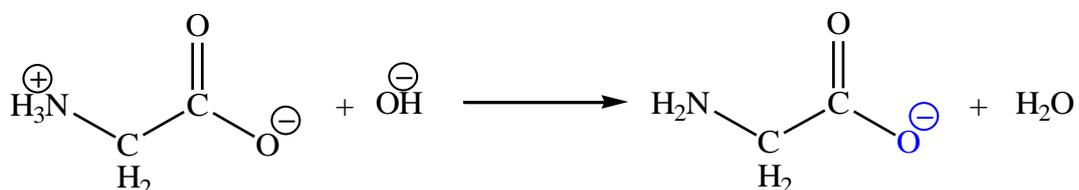

The species present in a given solution depends on the pH of the solution.

Carboxylic acids have acidic properties and react with bases. Amines have basic properties and react with acids. It therefore follows that amino acids have both acidic and basic properties.

9.7.2. Isoelectric point in aminoacids (pI)

The isoelectric point (pI), is the pH at which a particular molecule carries no net electrical charge in the statistical mean. This means it is the pH at which the amino acid is neutral, i.e. the zwitterion form is dominant. The pI is given by the average of the pK_as that involve the zwitterion, i.e. that give the boundaries to its existence.

The table below shows the pK_a values and the isoelectronic point, pI, are given below for the 20 α-amino acids (Table 9.6).

pK_{a1} = α-carboxyl group, pK_{a2} = α-ammonium ion, and pK_{a3} = side chain group

Table 9.6. pKa and pI values for the 20 α -amino acids

Amino acid	pKa1	pKa2	pKa3	pI
Glycine	2.34	9.60	---	5.97
Alanine	2.34	9.69	---	6.00
Valine	2.32	9.62	---	5.96
Leucine	2.36	9.60	---	5.98
Isoleucine	2.36	9.60	---	6.02
Methionine	2.28	9.21	---	5.74
Proline	1.99	10.60	---	6.30
Phenylalanine	1.83	9.13	---	5.48
Tryptophan	2.83	9.39	---	5.89
Asparagine	2.02	8.80	---	5.41
Glutamine	2.17	9.13	---	5.65
Serine	2.21	9.15	---	5.68
Threonine	2.09	9.10	---	5.60
Tyrosine	2.20	9.11	---	5.66
Cysteine	1.96	8.18	---	5.07
Aspartic acid	1.88	9.60	3.65	2.77
Glutamic acid	2.19	9.67	4.25	3.22
Lysine	2.18	8.95	10.53	9.74
Arginine	2.17	9.04	12.48	10.76
Histidine	1.82	9.17	6.00	7.59

There are 3 cases to consider:

1. Neutral side chains

These amino acids are characterised by two pKas: pKa₁ and pKa₂ for the carboxylic acid and the amine respectively. The isoelectronic point will be halfway between, or the average of, these two pKas $pI = \frac{1}{2} (pKa_1 + pKa_2)$. This is most readily appreciated when you realise that at very acidic pH (below pKa₁) the amino acid will have an overall positive charge and at very basic pH (above pKa₂) the amino acid will have an overall negative charge.

Example: For the simplest amino acid, *glycine*, pKa₁ = 2.34 and pKa₂ = 9.6, pI = 5.97.

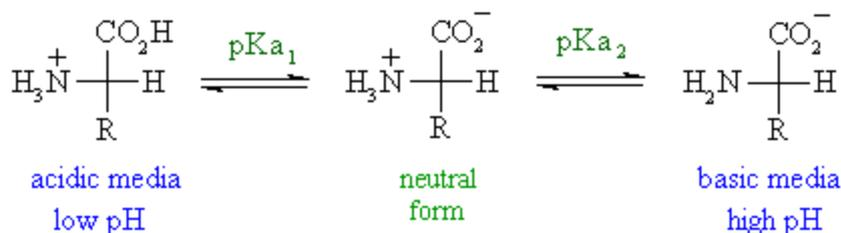

The other two cases introduce other ionisable groups in the side chain "R" described by a third acid dissociation constant, pK_{a_3}

2. Acidic side chains

The pI will be at a lower pH because the acidic side chain introduces an "extra" negative charge. So the neutral form exists under more acidic conditions when the extra -ve has been neutralised. For example, for *aspartic acid* shown below, the neutral form is dominant between pH 1.88 and 3.65, pI is halfway between these two values, i.e. $\text{pI} = 1/2 (\text{pK}_{a_1} + \text{pK}_{a_3})$, so $\text{pI} = 2.77$.

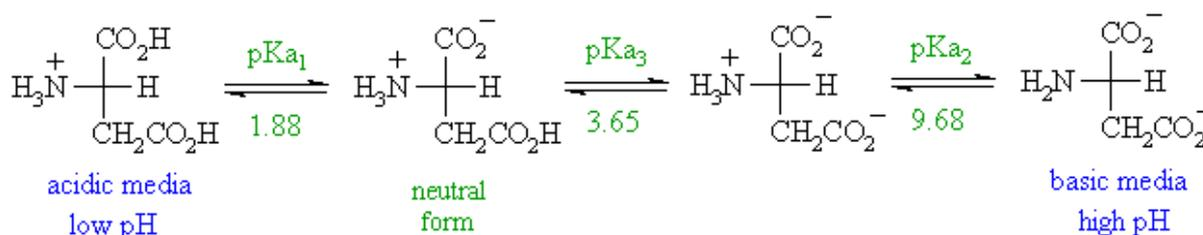

3. Basic side chains

The pI will be at a higher pH because the basic side chain introduces an "extra" positive charge. So the neutral form exists under more basic conditions when the extra positive's has been neutralised. For example, for histidine, which has three acidic groups of pKa's 1.82 (carboxylic acid), 6.04 (pyrrole NH) and 9.17 (ammonium NH), the neutral form is dominant between pH 6.04 and 9.17; pI is halfway between these two values, i.e. $\text{pI} = 1/2 (\text{pK}_{a_2} + \text{pK}_{a_3})$, so $\text{pI} = 7.60$.

9.7.3. Reaction with strong acids

In the following reaction, amino acids react with strong acids such as hydrochloric acid:

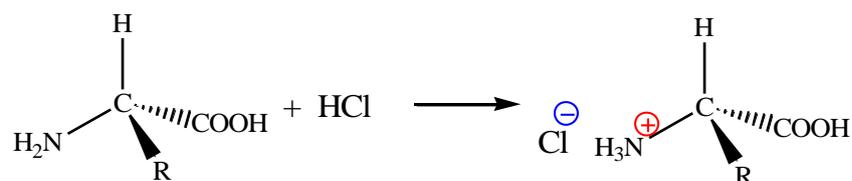

In **low pH**, therefore, amino acids exist in cationic form:

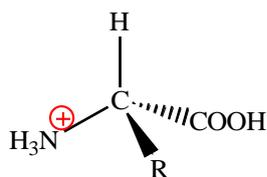

9.7.4. Reaction with nitrous acid (deamination)

The amine function of *α-amino acids* and *esters* reacts with nitrous acid in a similar manner to that described for primary amines. The *diazonium ion* intermediate loses molecular nitrogen in the case of the acid, but the diazonium ester loses a proton and forms a relatively stable diazo compound known as ethyl diazoethanoate:

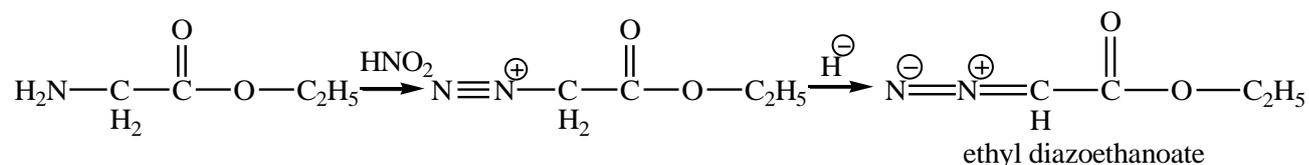

The diazo ester is formed because of the loss of N_2 from the diazonium ion which results in the formation of a quite unfavourable carbocation.

9.7.5. Reaction with sodium hydroxide

Amino acids react with strong bases such as sodium hydroxide:

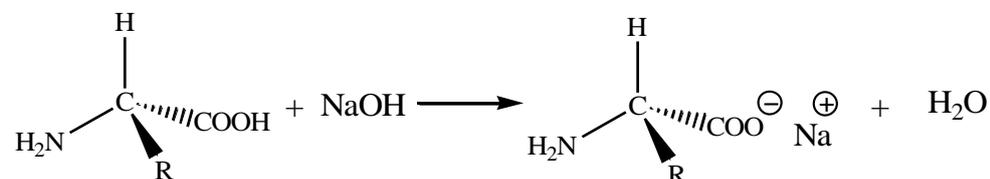

In **high pH**, therefore, amino acids exist in anionic form:

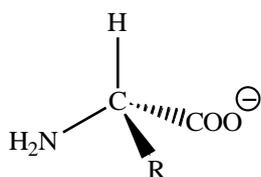

9.7.6. Reaction of amino acids with sodium carbonate

Amino acids are instantly dissolved by strong hydrochloric acid but are in part recovered unchanged on dilution and evaporation. They are not decomposed by *sodium carbonate* but are easily decomposed by sodium hydroxide. (Dakin & West, 1928)

Checking up 9.7

1. Draw the structure for the anion formed when glycine (at neutral pH) reacts with a base.
2. Draw the structure for the cation formed when glycine (at neutral pH) reacts with an acid.
3. Calculate the Isoelectric point of Glycine? ($pK_1 = 2.4$; $pK_2 = 9.8$)
4. Calculate the Isoelectric point of Lysine? ($pK_1 = 2.2$, $pK_2 = 8.9$; $pK_3 = 10.5$)

9.8. Optical isomers of amino acids

Activity 9.8

The molecule CHBrClF exhibits optical isomerism. Draw the 3D displayed formulae of both optical isomers.

In chemistry, the term “isomer” means molecules that have the same molecular formula, but have a different arrangement of the atoms in space.

Simple substances which show optical isomerism exist as two isomers known as *enantiomers*. Where the atoms making up the various isomers are joined up in a different order, this is known as *structural isomerism*. Structural isomerism is not a form of stereoisomerism, which involve the atoms of the complex bonded in the same order, but in different spatial arrangements. *Optical isomerism* is one form of stereoisomerism; *geometric isomers* are a second type.

The general formula for an amino acid let us see that (apart from **glycine**, 2-aminoethanoic acid) the carbon at the centre of the structure has four different groups attached. In glycine, the "R" group is another hydrogen atom.

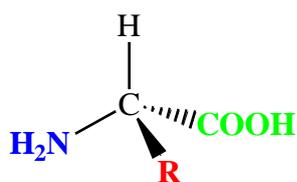

The lack of a plane of symmetry means that there will be two stereoisomers of an amino acid (apart from glycine) - one the non-superimposable mirror image of the other.

For a general 2-amino acid, the isomers are:

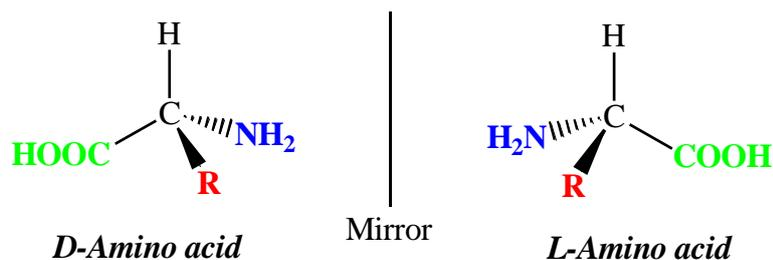

The R group, usually referred to as a side chain, determines the properties of each amino acid. Scientists classify amino acids into different categories based on the nature of the side chain. A tetrahedral carbon atom with four distinct groups is called **chiral**. The ability of a molecule to rotate plane polarized light to the left, L (**levorotary**) or right, D (**dextrorotary**) gives it its optical and stereo chemical fingerprint.

All the naturally occurring amino acids have the right-hand structure in the diagram above. This is known as the "**L-**" **configuration**. The other one is known as the "**D-**" **configuration**.

When asymmetric carbon atoms are present in a molecular compound, there are two ways in which the groups attached to that carbon can be arranged in the three dimensions, as we have just shown with the two models above. **Chemically**, optical isomers behave the same. **Biologically**, they do not. One will react properly, but the other will not.

Checking up 9.8

1. Write the optical isomers of 2-aminopropanoic and
2. Using diagrams, explain why glycine is not chiral.

9.9. Peptides and polypeptides

Activity 9.9

Ethyne (C_2H_2) is a compound which can undergo a polymerisation reaction. Deduce the reaction of polymerisation of ethyne, showing the mechanism of reaction.

9.9.1. Formation of peptide bonds

Amino acid molecules can also react with each other; the acidic $-\text{COOH}$ group in one molecule reacts with the basic $-\text{NH}_2$ group in another molecule. When two amino acids react together, in the resulting molecule is called a **dipeptide**, forming *an amide linkage (peptide bond)*, with the elimination of a water molecule.

Each amino acid possesses a carboxylic acid group and an amine group. The possibilities for constructing polypeptides and proteins are enormous. Let us consider two simple amino acids, **glycine** (2-aminoethanoic acid) and **alanine** (2-aminopropanoic acid). The figures below show that these can be joined in two ways:

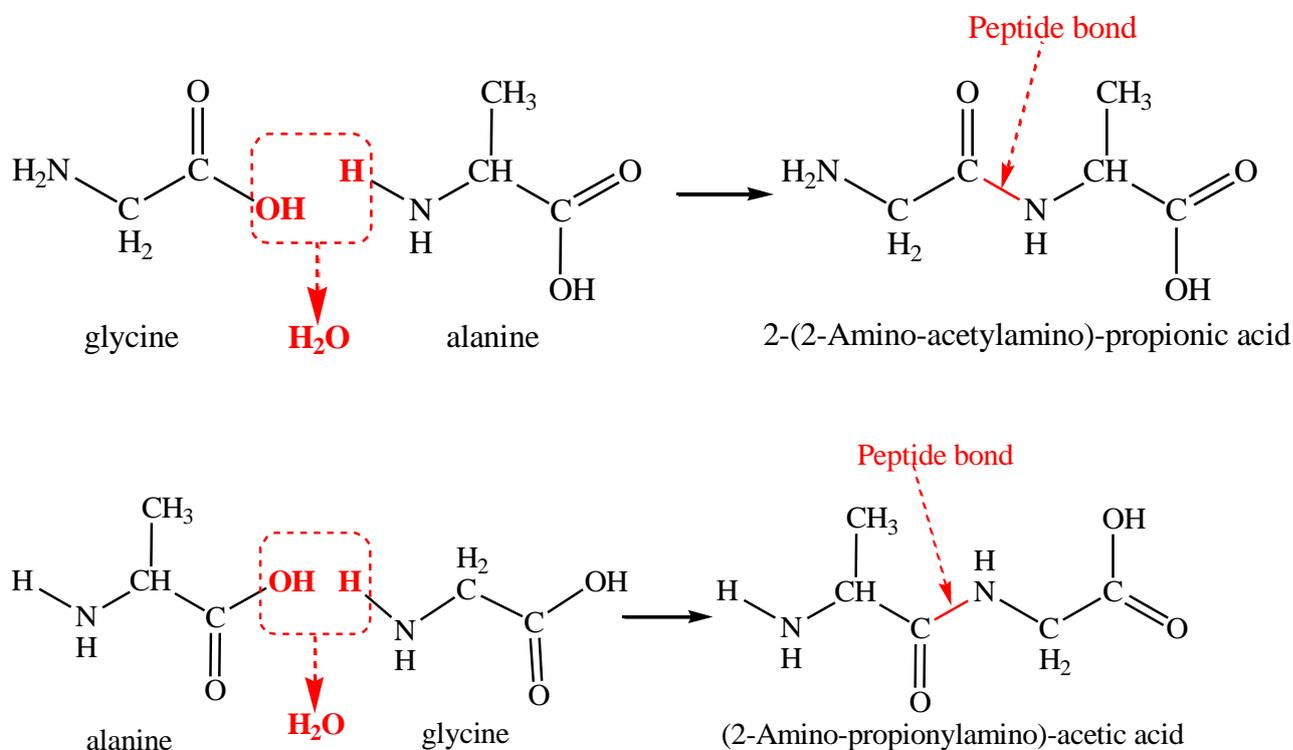

Note the amide link between the two amino acids. An amide link between two amino acid molecules is also called a **peptide link**. The reaction is a **condensation reaction** as a small molecule. The **dipeptide** product still has an -NH₂ group at one end and a -COOH group at the other end. Therefore the reaction can continue, to form a **tripeptide** initially, and then ever-longer chains of amino acids. The longer molecules become known as **polypeptides**, and then **proteins** as they get even longer sequences of amino acids. A typical protein is formed from between 50 and 200 amino acids joined in a variety of sequences.

9.9.2. Structure of peptides and polypeptides

A series of amino acids joined by peptide bonds form a polypeptide chain, and each amino acid unit in a polypeptide is called a residue. A polypeptide chain has polarity because its ends are different, with α -amino group at one end and α -carboxyl group at the other. By convention, the amino end is taken to be the beginning of a polypeptide chain, and so the sequence of amino acids in a polypeptide chain is written starting with the aminoterminal residue. Thus, in the pentapeptide Tyr-Gly-Gly-Phe-Leu (YGGFL), phenylalanine is the amino-terminal (N-terminal) residue and leucine is the carboxyl-terminal (C-terminal) residue (Figure 3.19). Leu-Phe-Gly-Gly-Tyr (LFGGY) is a different pentapeptide, with different chemical properties.

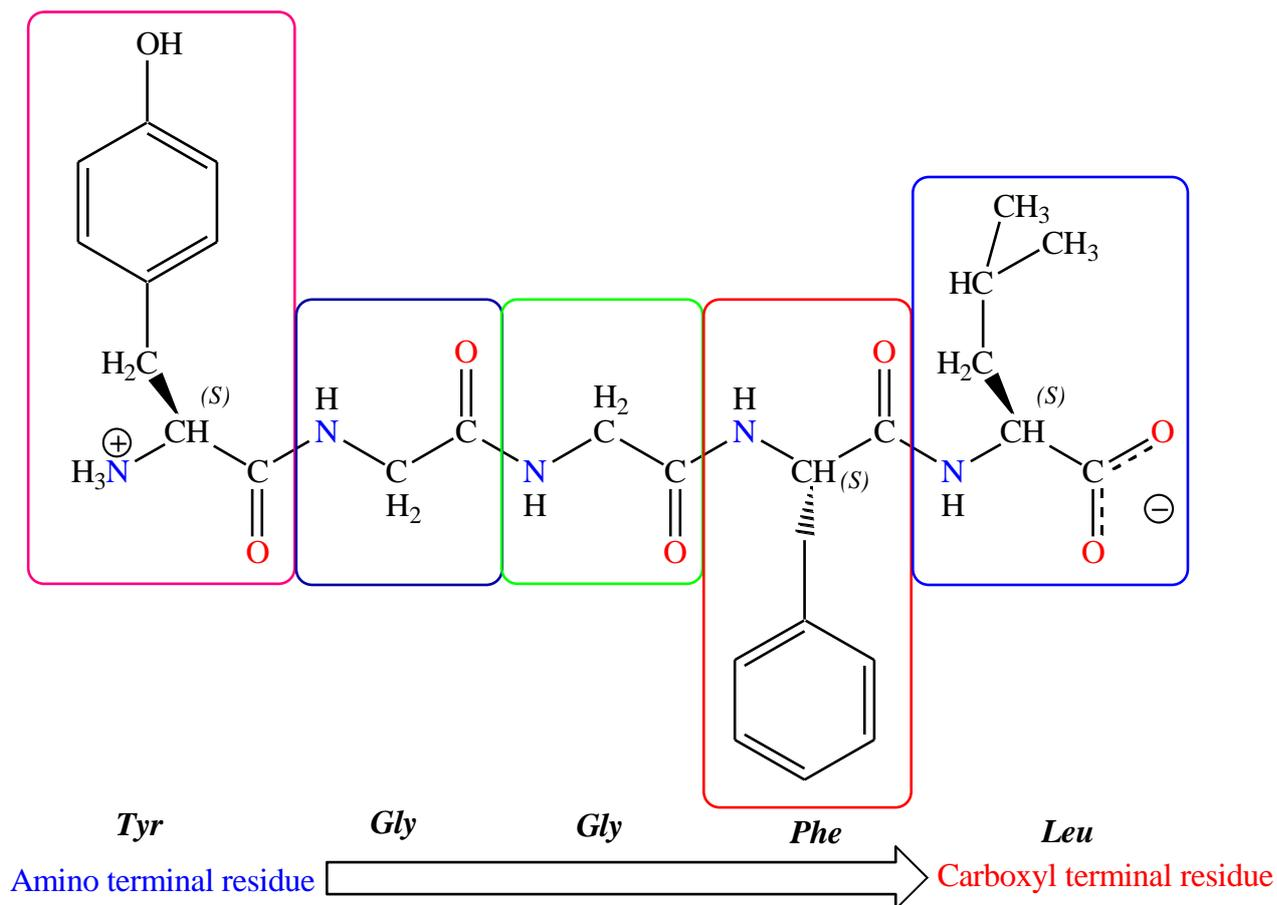

This above illustration of the *pentapeptide Tyr-Gly-Gly-Phe-Leu (YGGFL)* shows the sequence from the amino terminus to the carboxyl terminus. This pentapeptide, Leu-enkephalin, is an opioid peptide that modulates the perception of pain. The reverse *pentapeptide, Leu-Phe-Gly-Gly-Tyr (LFGGY)*, is a different molecule and shows no such effects.

A **polypeptide chain** consists of a regularly repeating part, called the *main chain or backbone*, and a variable part, comprising the distinctive *side chains*. The polypeptide backbone is rich in *hydrogen-bonding potential*. Each residue contains a carbonyl group, which is a good hydrogen-bond acceptor and, with the exception of proline, an NH group, which is a good hydrogen-bond donor. These groups interact with each other and with functional groups from side chains to stabilize particular structures, as will be discussed later.

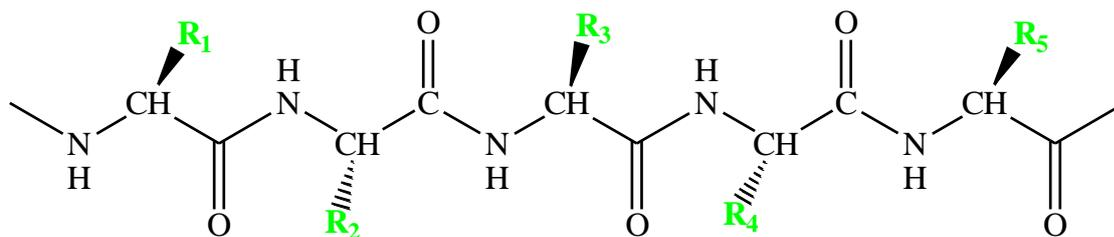

Components of a Polypeptide Chain

A polypeptide chain consists of a constant backbone (shown in blue) and variable side chains (shown in green).

9.9.3. Uses of amino acids as building blocks of proteins

Like carbohydrates and lipids, proteins contain the elements **carbon (C)**, **hydrogen (H)** and **oxygen (O)**, but in addition they also **always** contain **nitrogen (N)**. **Sulphur (S)** is often present as well as **iron (Fe)** and **phosphorus (P)**. Before understanding how proteins are constructed, the structure of amino acids should be noted.

The process of construction of proteins begins by amino acids bonding together, as seen earlier, through **peptide bonds**. When many amino acids join together a **long-chain polypeptide** is produced. The linking of amino acids in this way takes place during **protein synthesis**.

The simplest level of protein structure, **primary structure**, is simply the sequence of amino acids in a polypeptide chain. **The primary structure** (Figure 9.2) of a protein refers to its linear sequence of amino acids and the (-S-S-) bridges. One of those sequences is: -Gly-Ile-Val-Cyst-Glu-Gln-Ala-Ser-Leu-Asp-Arg-Asp-Arg-Cys-Val-Pro-

The primary structure is held together by peptide bonds that are made during the process of protein biosynthesis. The two ends of the polypeptide chain are referred to as the carboxyl terminus (C-terminus) and the amino terminus (N-terminus) based on the nature of the free group on each extremity.

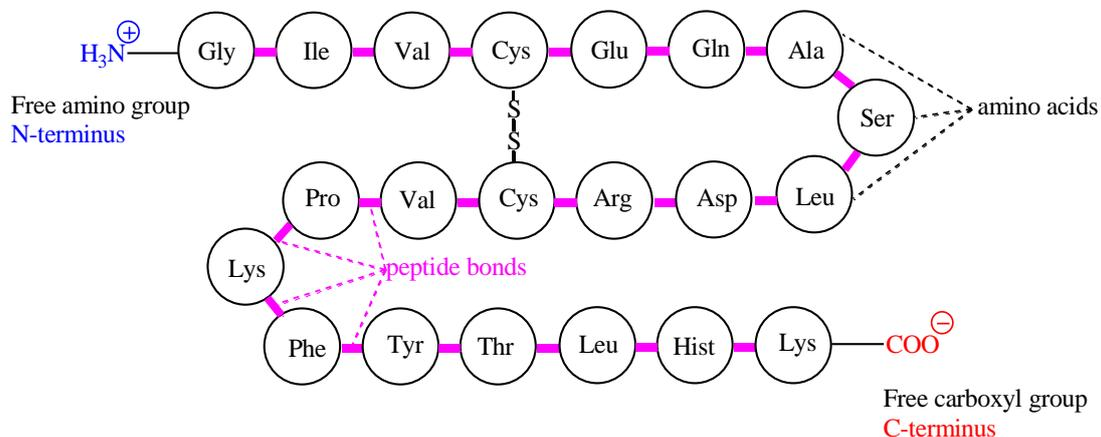
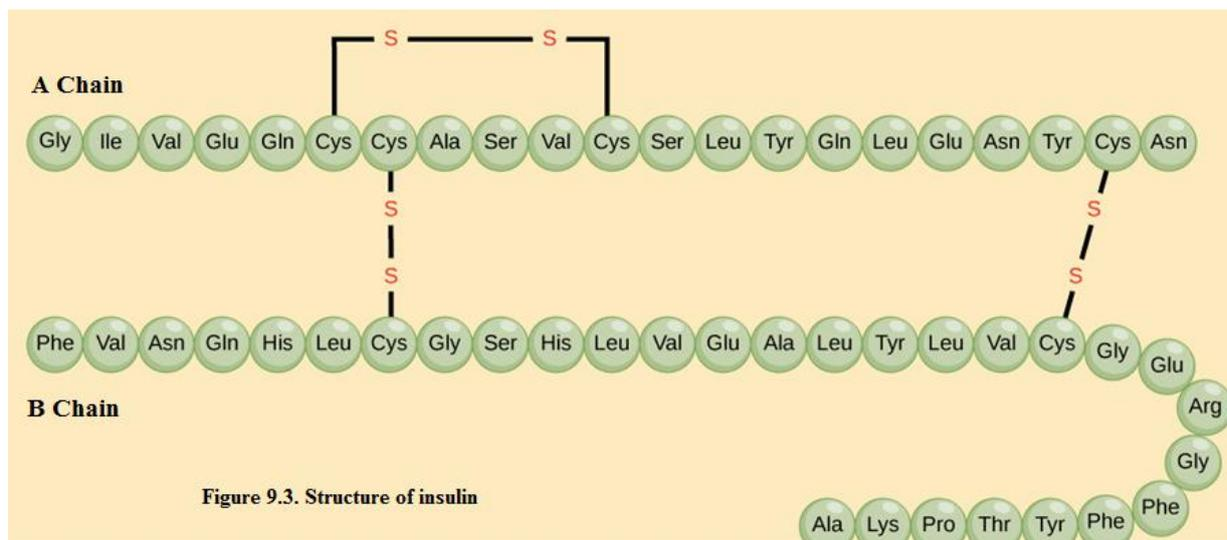

Figure 9.2. Structure of a primary protein

For example, the **hormone insulin** (Figure 9.3) has two polypeptide chains, A and B, shown in diagram below. Each chain has its own set of amino acids, assembled in a particular order. For instance, the sequence of the A chain starts with **glycine at the N-terminus** and ends with **asparagine at the C-terminus**, and is different from the sequence of the B chain. You may notice that the insulin chains are linked together by **sulfur-containing bonds between cysteines**.



Checking up 9.9

1. Distinguish between the N- terminal amino acid and the C- terminal amino acid of a peptide or protein.
2. Describe the difference between an amino acid and a peptide.
3. Amino acid units in a protein are connected by peptide bonds. What is another name for the functional group linking the amino acids?
4. Draw the structure for each peptide.
 - a. gly-val
 - b. val-gly
5. Identify the C- and N- terminal amino acids for the peptide lys-val-phe-gly-arg-cys.

9.10. End unit assessment

- Ethylamine and phenylamine are two organic compounds and both are basic.
 - Draw the displayed formula of each compound, including lone pairs.
 - Write a balanced symbol equation for the reaction between one of these compounds and an acid to form a salt.
 - Which structural feature of each compound accounts for the basicity?
- The formulae of two amino acids, glycine (Gly) and alanine (Ala), are given:
Glycine: $\text{H}_2\text{NCH}_2\text{COOH}$ and alanine: $\text{H}_2\text{NCH}(\text{CH}_3)\text{COOH}$.

- Give the systematic names of both amino acids.
 - Draw their skeletal formulae.
- Alanine can exist as two stereoisomers.
 - Draw these two stereoisomers, showing how they differ in their spatial arrangements.
 - Explain why glycine does not have stereoisomers.

- The structure of a certain tripeptide is shown here:

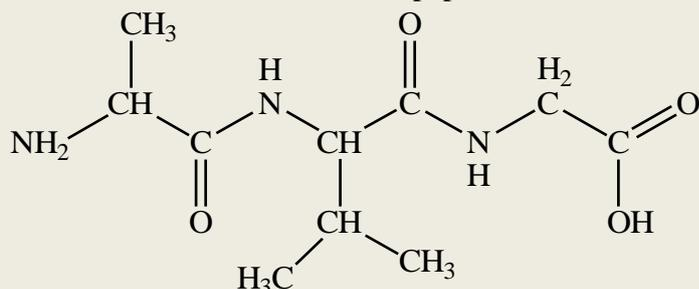

- Draw the displayed formulae of the three amino acids that make up the tripeptide.
 - Which of these amino acids has two chiral carbon atoms?
- This tripeptide can be split up into the three amino acids by refluxing with aqueous hydrochloric acid.
 - Which bond is broken in this reaction?
 - The reaction can be described as hydrolysis. Explain why, using a diagram.

UNIT 10. PHASE DIAGRAMS

Key unit competency:

To be able to interpret the phase diagrams for different compounds.

- *Define a phase*
- *Explain the term phase equilibrium*
- *Explain the effect of change of state on changing pressure and temperature*
- *Define heterogeneous and homogeneous equilibria*
- *Define triple point, critical point, normal boiling and melting points of substances*
- *Relate the physical properties of compounds to their phase diagrams.*
- *Locate triple point, critical point, normal boiling and melting points on the phase diagrams*
- *Compare the phase diagrams for water with that carbon dioxide*
- *Develop analysis skills, team work, and attentiveness in interpreting the phase diagrams and in practical activities*

Introductory Activity

In our daily life, we use varied materials which have distinct properties and they can exist in different physical states of the matter. In this regard, we sometimes need to keep a given substance in a certain state because we know that it will serve better. Explain two important conditions that should be dealt with to maintain stable some physical states of the matter as we need them.

Explain why ice floats on water.

10.1. Phase equilibrium

Activity 10.1

1. Observe the diagrams that represent different systems and assess the number of phases and components involved in each system.

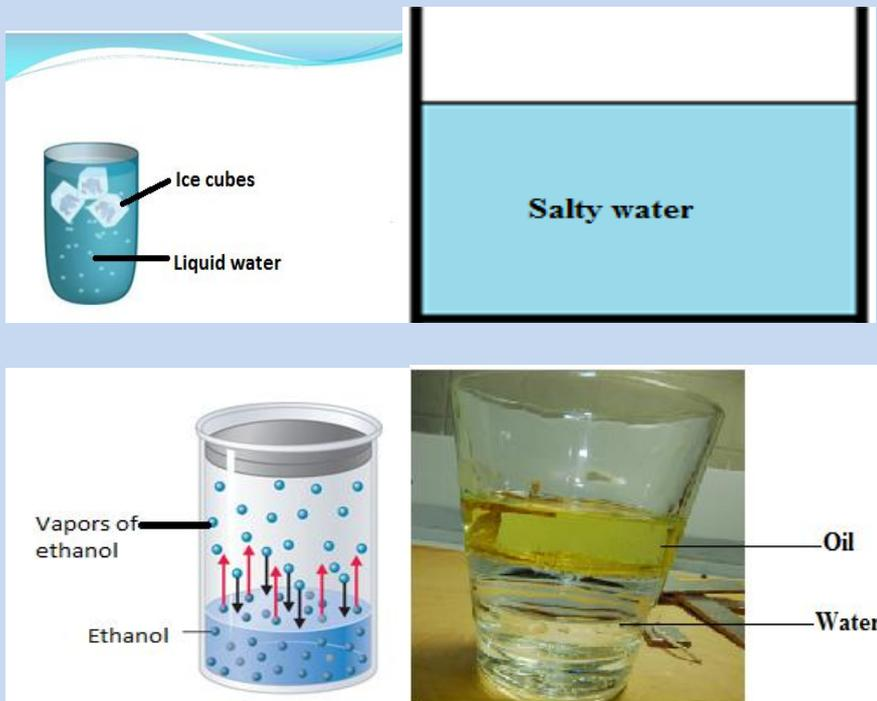

2. Differentiate a phase and a physical state of matter. Explain your answer.

10.1.1. Definition of key terms

A **phase** is a homogeneous portion of a system which has uniform physical characteristics. It can be separated from other parts of the system by a clear boundary (limit). A phase can be a solid, liquid, vapor (gas) or aqueous solution which is uniform in both chemical composition and physical state.

Examples

- (i) A mixture of gases (air) consists of one phase only
- (ii) A mixture of oil and water consists of two different liquid phases
- (iii) A mixture of solids, each solid is regarded as having one phase

A component: it is a chemical species which may be used to specify the composition of a system. For example;

- A three-phase system of water (i.e. water, ice, and vapor) is a one component system. The constituent substance of the three phases is water only.

- A mixture of water and ethanol is a one phase, two components system because there are two different chemical compositions.

An equilibrium: it is the state of a reaction or physical change in which the rates of the forward and reverse processes are the same and there is no net change on the amount of the equilibrium components

A phase equilibrium: it is a balance between phases, that is, the coexistence of two or more phases in a state of dynamic equilibrium. The forward process is taking place at the same rate as the backward process and therefore the relative quantity of each phase remains unchanged unless the external condition is altered.

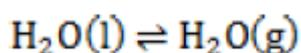
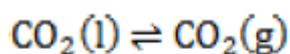

In homogeneous equilibrium, all substances are in the same phase while in heterogeneous equilibrium, substances are in distinct phases.

Checking up 10.1

- Which of the following is not an example of phase equilibrium?
 - $\text{N}_2\text{O}_4(\text{g}) \rightleftharpoons 2\text{NO}_2(\text{g})$
 Colourless Brown
 - Carbon dioxide in a stoppered fizzy drink: $\text{CO}_2(\text{aq}) \rightleftharpoons \text{CO}_2(\text{g})$
 - Vapours above the surface of liquid water in a closed container, at a given temperature.
- At 0.001°C and 0.00603 atm water, ice and vapor can coexist in a closed container.
 - Explain the number of phases that this equilibrium has.
 - How many components does this system have? Explain.

10.2. Homogeneous and heterogeneous equilibria

Activity 10.2

Differentiate homogeneous mixture from heterogeneous mixture.

1. Homogeneous equilibrium

A system with one phase only is described as a **homogeneous system** and when this system is at equilibrium, it is said to be a **homogenous equilibrium**.

In general, a homogeneous equilibrium is one in which all components are present in a single phase. In a case of a chemical reaction, both reactants and products exist in one phase (gaseous phase, liquid phase or aqueous solution and solid phase).

For example, in the esterification of acetic acid and ethanol the equilibrium is homogeneous because all involved substances are in the same liquid phase.

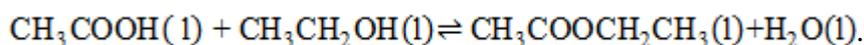

All the reactants and products are liquids

2. Heterogeneous equilibrium

A system consisting of more than one distinct phases is described as **heterogeneous system**. A **heterogeneous equilibrium** is a system in which the constituents are found in two or more phases. The phases may be any combination of solid, liquid, gas, or solutions.

For example, in the manufacture of quick lime from lime stone the following equilibrium is involved:

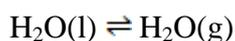

It is a heterogeneous equilibrium because some of the components are solids (lime stone and quick lime) and another is a gas (carbon dioxide).

Checking up 10.2

Classify the following reactions as homogeneous equilibrium and heterogeneous equilibrium

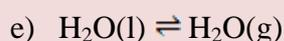
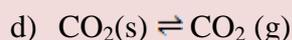
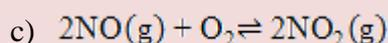
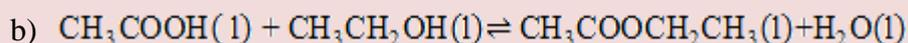
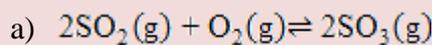

10.3. Phase diagrams

Activity 10.3

1. When ice cream trucks drive through towns on hot season days, they keep their products from melting by using dry ice (solid carbon dioxide) as shown in the image below. Why is dry ice used instead of ice?



2. Explain the reason why ice floats on water while most of other substances' solids sink in their liquid forms.
3. Why most of the time very high mountains are covered by ice?



4. Explain the conditions that are required to be changed so that the pure substance change from one state of matter to another.

Phase diagram is a graph illustrating the conditions of temperature and pressure under which equilibrium exists between the distinct phases (states of matter) of a substance. Phase

diagrams are divided into three single phase regions that cover the pressure-temperature space over which the matter being evaluated exists: liquid, gaseous, and solid states. The lines that separate these single-phase regions are known as *phase boundaries*. Along the phase boundaries, the matter being evaluated exists simultaneously in equilibrium between the two states that border the phase boundary.

The general form of a phase diagram for a substance that exhibits three phases is shown below in the Figure 10.1.

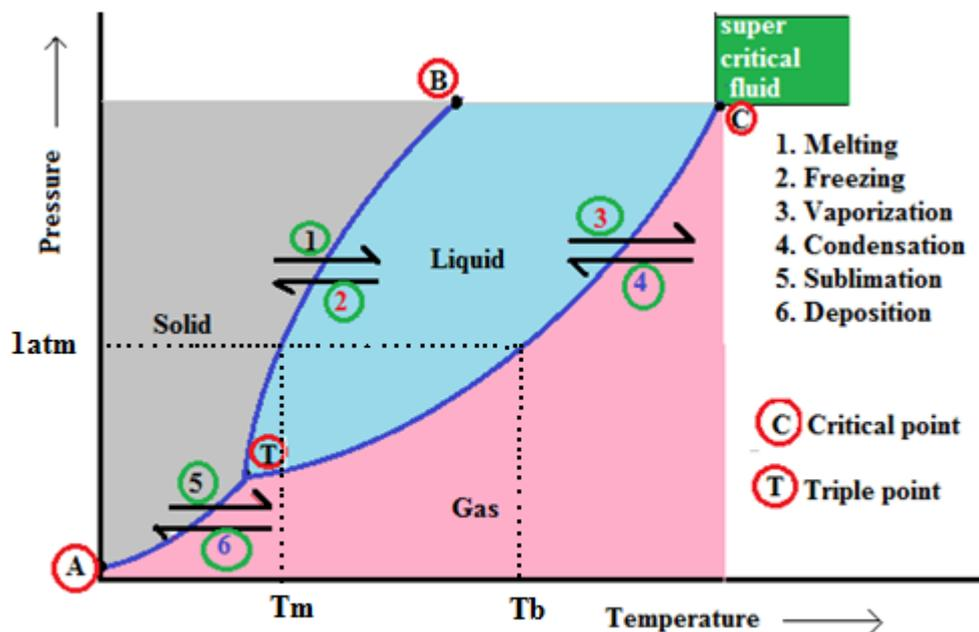

T_m: Normal melting point
T_b: Normal boiling point

Figure 10.1. Phase diagram for a one component system

Under appropriate conditions of temperature and pressure of a solid can be in equilibrium with its liquid state or even with its gaseous state. The phase diagram allows to predict the phase of substance that is stable at any given temperature and pressure. It contains three important curves, each of which represents the conditions of temperature and pressure at which the various phases can coexist at equilibrium.

i) Boiling point

The line TC is the vapor pressure curve of the liquid. It represents the equilibrium between the liquid and the gas phases. The temperature on this curve where the vapor pressure is equal to 1atm and it is the **normal boiling point** of the substance. The vapor pressure curve ends at the **critical point** (C) which is the critical temperature corresponding to the critical pressure

of the substance which is the pressure required to bring about liquefaction at critical temperature.

ii) Critical point

Critical point consists of the temperature and pressure beyond which the liquid and gas phases cannot be **distinguished**. Every substance has a critical temperature above which the gas cannot be liquefied, regardless the applied pressure.

iii) Sublimation point

The line **AT** is the sublimation curve which represent the variation in the vapor pressure of the solid as it sublimates into gas at different temperatures. The reverse process is **deposition** of the gas as a solid. Sublimation point is the temperature at which the solid turns to gas at a constant pressure.

iv) Melting point

The line **TB** is the melting point curve which represent the change in melting point of the solid with increasing pressure. The line usually slopes slightly to the right as pressure increases. For most substances, the solid is denser than the liquid, therefore, an increase in pressure favors the more compact solid. Thus, higher temperatures are required to melt the solid at higher pressures. The temperature at which the solid melts at a pressure of 1atm is the “**normal melting point**”.

v) Triple point

The triple point **T** is a point where the three curves intersect. All the three phases exist at equilibrium at this temperature and pressure. The triple point is unique for each substance.

vi) Supercritical fluid

Supercritical fluid of a substance is the temperature and pressure above its own thermodynamic critical point that can diffuse through solids like a gas and dissolved materials like a liquid.

Any point on the diagram that does not fall on a line corresponds to conditions under which one phase is present. Any other point on the three curves represents equilibrium between two phases.

The gas phase is stable phase at low pressures and elevated temperatures. The conditions under which the solid phase is stable extend to low temperatures and high pressures. The stability range for liquids lie between the other two regions. That is between solid and liquid regions.

10.3. 1. Phase diagram of water

Water is a unique substance in many ways due to its properties. One of these special properties is the fact that solid water (ice) is less dense than liquid water just above the freezing point. The phase diagram for water is shown in the Figure 10.2.

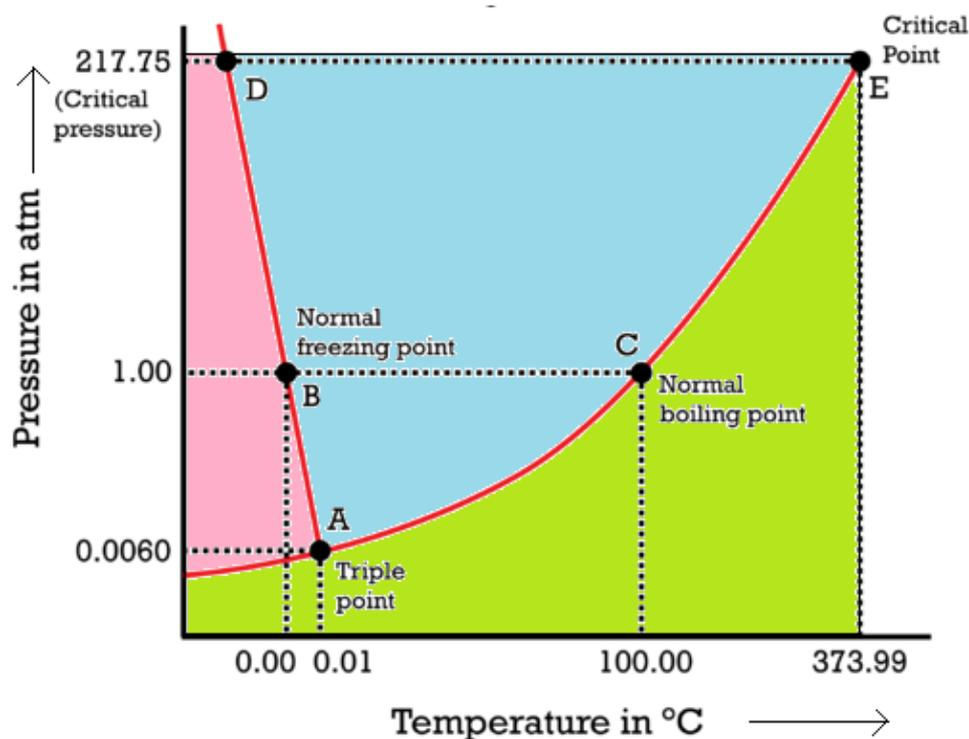

Figure 10.2. Phase diagram of water

Water can turn into vapor at any temperature that falls on the vapor pressure curve depending on the conditions of pressure, but the temperature at which water liquid turns into vapor at normal pressure (1atm) is called the **normal boiling point** of water, 100 °C (Figure 10.2)

Point **E** in the Figure 10.2 is the **critical point** of water where the pressure is equal to 218 atm and the temperature is about 374 °C. At 374°C, particles of water in the gas phase are moving rapidly. At any other temperature above the critical point of water, the physical nature of water liquid and steam cannot be distinguished; the gas phase cannot be made to liquefy, no matter how much pressure is applied to the gas.

The phase diagram of water is not a typical example of a one component system because the line **AD** (melting point curve) slopes upward from right to left. It has a negative slope and its melting point decreases as the pressure increases. This occurs only for substances that **expand** on freezing. Therefore, liquid water is denser than solid water (ice), the reason why ice floats on water.

10.3.2. Phase diagram of carbon dioxide

Compared to the phase diagram of water, in the phase diagram of carbon dioxide the solid-liquid curve exhibits a positive slope, indicating that the melting point for CO₂ increases with pressure as it does for most substances. The increase of pressure causes the equilibrium between dry ice and carbon dioxide liquid to shift in the direction of formation of dry ice that is freezing. Carbon dioxide contracts on freezing and this implies that dry ice has higher density than that of liquid carbon dioxide. The Figure 10.3 shows the phase diagram of carbon dioxide.

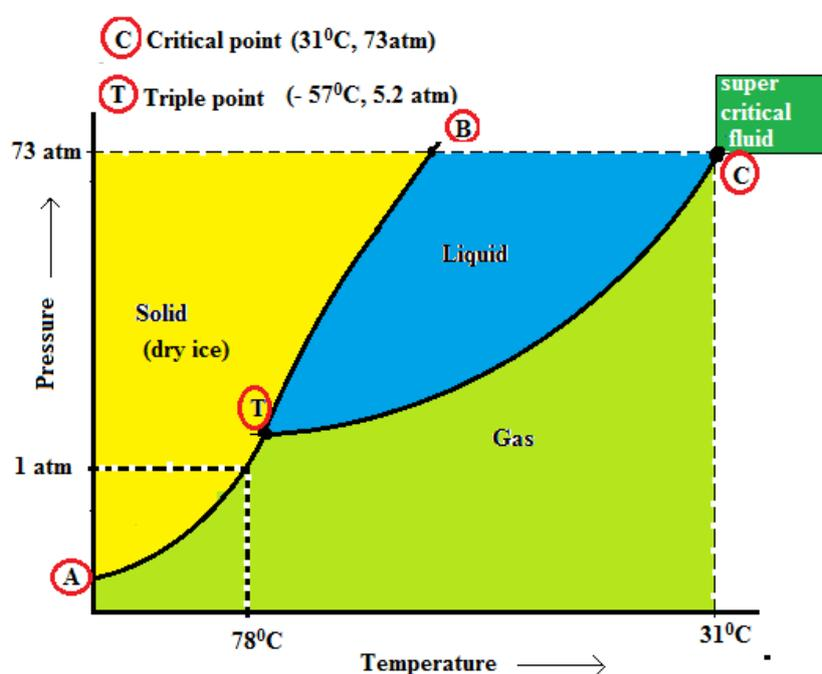
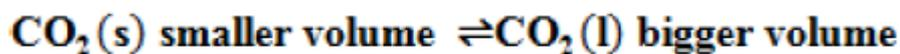

Figure 10.3. Phase diagram of carbon dioxide

An equilibrium is observed between CO₂ as shown below.



The triple point is observed at the pressure above 1atm, indicating that carbon dioxide cannot exist as a liquid under normal conditions of pressure. Instead, cooling gaseous carbon dioxide at 1atm results in its deposition into the solid state. Likewise, solid carbon dioxide does not melt at 1atm pressure but instead sublimates to yield gaseous CO₂.

Checking up 10.3

1. If a piece of dry ice is left on the lab counter, you will see it get smaller until it

disappears, with no liquid left around it. Explain why.

2. Describe what conditions of pressure and temperature will carbon dioxide exist as a liquid?
3. What is the meaning of the term “critical temperature”, and what is the value of the critical temperature of CO_2 ?
4. Why does CO_2 make an excellent fire extinguisher?
5. Explain the following observations:
 - a) When a closed glass container full of water is put in fridge, it directly breaks when the water freezes.
 - b) The water of oceans at the poles of the Earth are normally covered by ice and ice does not submerge in water.



10.4. Comparison of phase diagrams of substances that expand and those that contract on freezing

Activity 10.4

1. Analyze the phase diagrams of water and carbon dioxide previously discussed to assess their similarities and differences.
2. The glacier easily slides on ice as shown in the photo below. Explain how the property of water facilitates this movement.



For the phase diagrams, some materials contract on freezing while others expand on freezing. The main differences between **substances that expand and those that contract on freezing** can be highlighted by comparing the phase diagrams of carbon dioxide and that of water. In

the phase diagram of carbon dioxide, the substance contracts on freezing and that of water expands on freezing.

Both phase diagrams for water and carbon dioxide have the same general Y-shape, just shifted relative to one another. This shift occurs because the liquid phase in the dry ice can only occur at higher temperatures and pressures, whereas, in ice the liquid phase occurs at lower temperatures and pressures. There are two more significant differences between the phase diagram of carbon dioxide and that of water:

10.4.1. Melting point curve

The melting point curve of carbon dioxide slopes upwards to right (Figure 10.3) whereas that of water slopes upward to left (Figure 10.2). This means that for carbon dioxide the melting point increases as the pressure increases, a characteristic behavior of substances that contract on freezing. Further, water expands on freezing (Figure 1.4) and this unusual behavior caused by the open structure of the regular packing of water molecules in ice due to the network of hydrogen bonding in ice which is more extensive than in liquid.

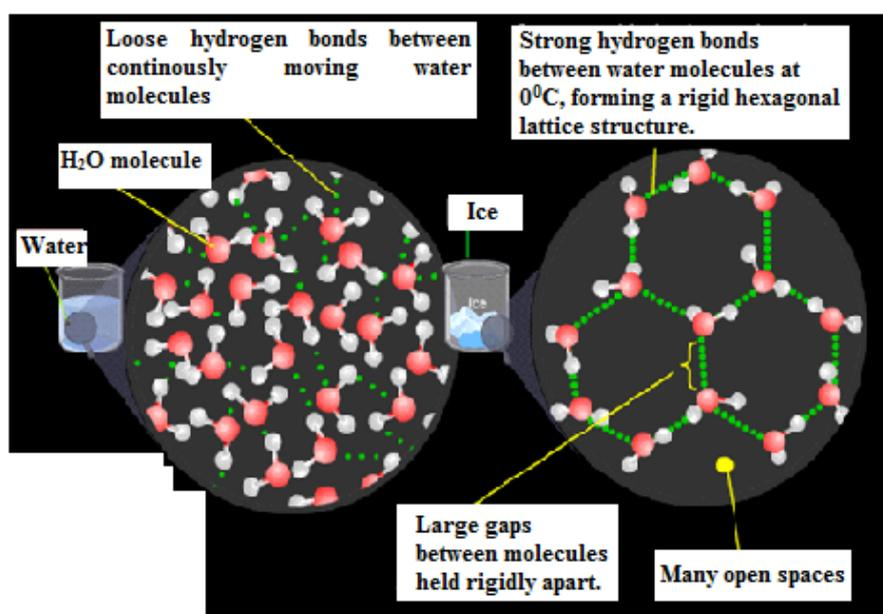

Fig. 10.4. Expansion of water on freezing

Ice floats on liquid water (Figure 10.5), this unusual behavior caused by the open structure of the regular packing of water molecules in ice due to the network of hydrogen bonding in ice which is more extensive than in liquid. **The ice is less dense than water reason why it floats in water.**

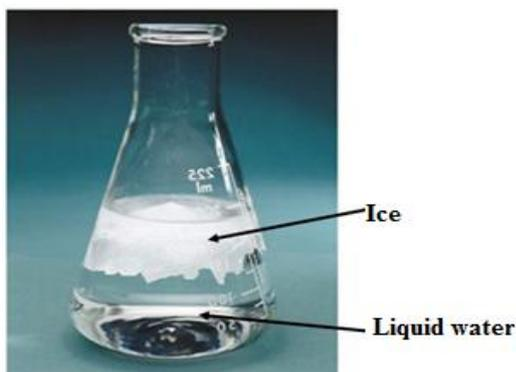

Figure 10.5. Ice floating in water

10.4.2. Triple point

The triple point of carbon dioxide is above atmospheric pressure. This means that the state of liquid carbon dioxide does not exist at ordinary atmospheric pressure. Dry ice remains as a solid below -78°C and changes to fog (gas) above -78°C . It sublimates without forming liquid at normal atmospheric pressure (Figure 10.6). The sublimation of carbon dioxide results in a low temperature which causes water vapors in the air to form moist.



Figure 10.6. Sublimation of Dry ice at normal pressure

Ice is stable below 0°C and water is stable between 0°C and 100°C while water vapor is stable above 100°C . At normal atmospheric pressure, ice can first melt and ultimately boils as the temperature increases.

Checking up 10.4

1. Explain three ways that dry ice is different to the normal ice.
2. Explain why the liquid phase is not observed in the dry ice as it sublimates, whereas all three phases are observed in the ice?
3. At temperature and pressure of 5°C and 1atm (refer to both phase diagram of H_2O and CO_2), are normal ice and dry ice at the same phase? Explain your reasoning.
4. Draw and label a phase diagram for water and carbon dioxide and explain why they are different?
5. Explain the reason why a glass container breaks when water freezes.

10.5. Applied aspect of phase diagrams

Activity 10.5

Engineers use diverse materials in construction of houses, bridges, etc. and in making different other products such as cars, airplanes, computers, etc. Explain if the knowledge of the phase diagrams of those materials the engineers use is important to them.

The applications of phase diagrams are useful for engineer's materials and material applications. The scientists and engineers understand the behavior of a system which may contain more than one component. Multicomponent phase's diagrams show the conditions for the formation of solutions and new compounds. The phase diagrams are applied in solidification and casting problems. Many materials and alloy system exist in more than one phase depending on the conditions of temperature, pressure and compositions. In the area of alloy development, phase diagrams have proved invaluable for tailoring existing alloys to avoid over design in current applications, each phase has different microstructure which is related to mechanical properties. The development of microstructure is related to the characteristics of phase diagrams. Proper knowledge and understanding of phase diagrams lead to the design and control of heating procedures for developing the required microstructure and properties.

Phase diagrams are consulted when materials are attacked by corrosion. They predict the temperature at which freezing or melting begins or ends. Phase diagrams differentiate the critical point, triple point, normal boiling point, etc of some substances.

Examples

- Zn-Fe based high-order phase diagrams have found a wide range of applications in continuous galvanizing.
- The Zn-rich corner of the Zn-Fe-Al phase diagram is being used daily for scientific interpretation of bath assays.

In general the industrial applications of phase diagrams include alloy design, processing, and performance.

Checking up 10.5

Make a research and explain different applications of phase diagrams.

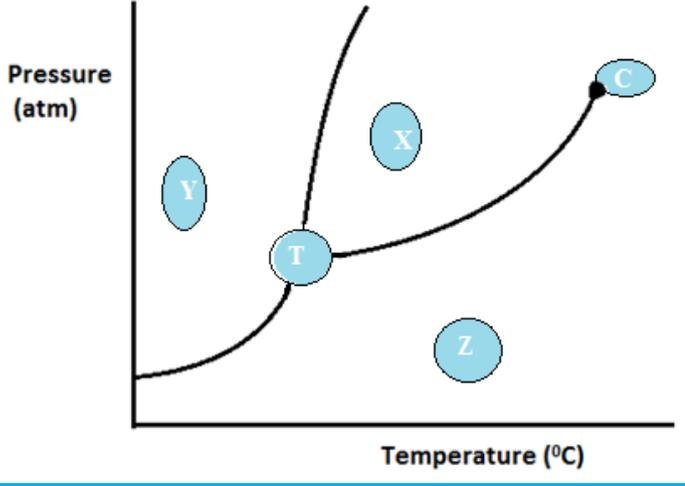

- a. Explain what is labeled in the parts X, Y, Z, C and T
- b. Would the substance represented on this graph contract or expand when it was frozen? Explain your answer.
- c. Describe what will happen to Y if the temperature is increased at constant pressure.
- d. Explain what will happen to X if the pressure is much lowered at constant temperature.

7. The diagram below shows the variation of vapor pressure with temperature for a pure substance.

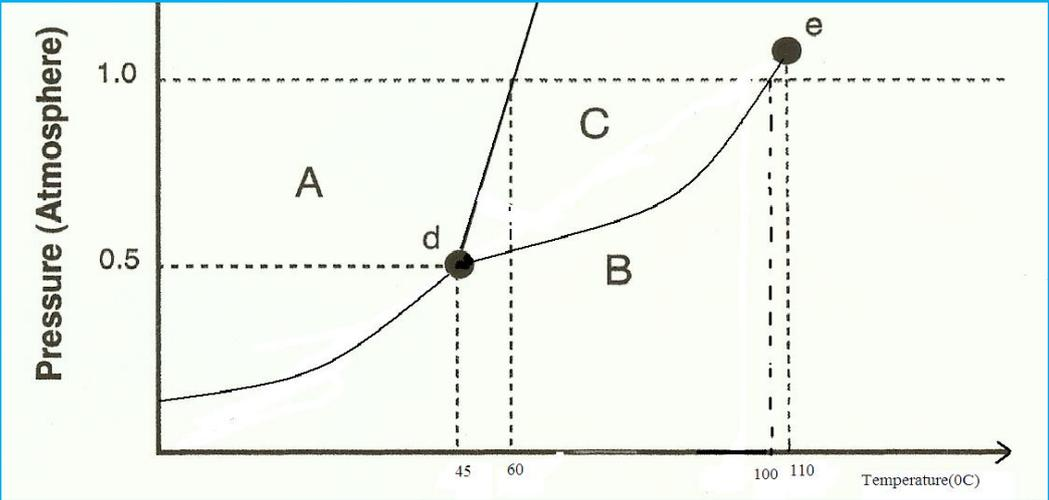

- a) What sections represent liquid, gas, solid phases?
- b) What letter represents the triple point? Give the definition of the triple point.
- c) What is the substance's normal boiling and melting point?
- d) Above which temperature it is not possible to liquefy the gas of the substance, no matter how much pressure is applied?

- e) At a constant temperature, what would you do to cause this substance to change from the liquid phase to the solid phase?

UNIT 11: SOLUTIONS AND TITRATION

Key unit competency: Be able to prepare standard solutions and use them to determine concentration of other solutions by titration.

Learning objectives:

- *Define the terms standard solution and primary standard solution.*
- *Explain the properties of a standard primary solution.*
- *Explain the titration process, emphasising the need for precise measurements.*
- *Prepare solutions with different concentrations.*
- *Properly use the burettes, pipettes during titration.*
- *Interpret the experimental data obtained by titration and report.*
- *Carry out acid-base, redox titrations and do calculations involved.*
- *Develop a team approach and a sense of responsibility in performing the experiments of titration.*
- *Respect of procedure in practical experiment.*
- *Develop a culture of orderliness in performing practical experiments.*

- Appreciate the use of appropriate measurements in daily life.

Introductory activity



Observe the above photo and attempt the following questions:

- 1) For the bottle of PRIMUS, and that of MUTZIG, we find on the bottle of its labels 5% alcohol and 5.5% alcohol respectively.
 - a) Explain the meaning of 5% and 5.5% alcohol.
 - b) 5% alcohol corresponds to which volume of alcohol of the total volume of 72cl of the bottle of PRIMUS.
 - c) Calculate the volume of alcohol corresponding to 5.5% alcohol of the bottle of MUTZIG of the total volume of 65cl.
- 2) On the label of the bottle of AGASHYA JUICE we find that **dilution 1:5**. Explain this ratio and explain also the purpose of diluting substances.

11.1. Definition of standard solution and primary standard solution.

Activity 11.1

1. You have a bag full of rice. How do you determine its weight?
2. You have a jerrycan half-full of a liquid substance, how are you going to proceed to know the exact quantity of the liquid?
3. You are given a basic solution, NaOH (aq), and you are requested to determine its concentration. What do you need to do that?

In analytical chemistry, a standard solution is a solution containing a precisely known concentration of an element or a substance and used to determine the unknown concentration of other solutions. A known weight of solute is dissolved to make a specific volume. It is prepared using a standard substance, such as a primary standard.

A **primary standard** is defined as a substance or compound used to prepare standard solutions by actually weighing a known mass, dissolving it, and diluting to a definite volume.

Or a substance, which is chemically stable in aqueous solution and its concentration remains constant with change in time such that it can be used to standardize other solutions.

Some important examples of primary standard are;

- Sodium Carbonate, Na_2CO_3
- Potassium dichromate, $\text{K}_2\text{Cr}_2\text{O}_7$
- Benzoic acid, $\text{C}_6\text{H}_5\text{COOH}$
- Oxalic acid, $\text{H}_2\text{C}_2\text{O}_4$
- Iodine, I_2
- Sodium oxalate, $\text{Na}_2\text{C}_2\text{O}_4$
- Butanedioic acid, $\text{C}_3\text{H}_7\text{COOH}$
- Sodium tetraborate, Borax, $\text{Na}_2\text{B}_4\text{O}_7$
- Potassium chloride, KCl
- Arsenic(III)oxide, As_2O_3
- Silver nitrate, AgNO_3

Standard solutions are normally used in titrations to determine unknown concentration of another substance.

Checking up 11.1

Differentiate between standard solution and primary standard solution

11.2. Properties of a primary standard solution.

Activity 11.2

Do research and find out the role and characteristics of a good primary standard.

A good primary standard meets the following criteria:

- High level of purity
- High stability
- Be readily soluble in water
- High equivalent weight (to reduce error from mass measurements)
- Not hygroscopic (to reduce changes in mass in humid versus dry environments)
- Non-toxic
- Inexpensive and readily available
- React instantaneously, stoichiometrically and irreversibly with other substances i.e. should not have interfering products during titration.
- It should not get affected by carbon dioxide in air

Molar concentrations are the most useful in chemical reaction calculations because they directly relate the moles of solute to the volume of solution.

The formula for molarity is:

$$\text{Molarity} = \frac{\text{moles of solute}}{\text{volume of solution}}$$

Checking up 11.2

Discuss the properties of a good primary standard

11.3. Preparation of standard solutions

Activity 11.3

Describe how you would prepare 1L of a 1M solution of sodium chloride. The gram formula weight of sodium chloride is 58.5g/mol

The preparation of the solution requires a reagent that is so to say the quantity to be weighed for mass if the reagent is in solid state. The volume to be pipetted using pipette if the solute is a liquid and then after dissolve it in water, so the solution can be prepared by two methods such as **dissolution method and dilution method**.

In the preparation of solution, glasses, volumetric flask, pipette, glass rod, measuring cylinder, analytical balance, spatula, beakers, magnetic stirrer and other laboratory devices are used.

11.3.1. Preparation of standard solution by dissolution of solids

Activity 11.3.1

Preparation of 250 mL of 1M NaOH solution

Materials

- | | | |
|--------------------|-----------|--------------------------|
| - Beaker | - balance | - sodium hydroxide solid |
| - Spatula | - funnel | - glass rod |
| - Volumetric flask | - stopper | - distilled water |

Procedure:

- (i) Calculate the mass of sodium hydroxide needed (m_1)
- (ii) Weigh a clean beaker, and record its mass (m_2); with a clean spatula, add sodium hydroxide until the combined mass of weighing beaker and sodium hydroxide is ($m_1 + m_2$).
- (iii) Add about 50 cm³ of distilled water, stir with a glass rod until all solids have dissolved.
- (iv) Pour all the solution carefully through a funnel into a volumetric flask; wash all the solution out of the beaker and off the glass rod.
- (iv) Add distilled water until the level is about 2 cm³ below the graduation mark on the graduated flask. Add the rest of distilled water from a washing

bottle until the bottom of the meniscus is at the level of mark when viewed at eye level.

(vi) Insert the stopper of the flask and invert the flask several times to mix the solution.

(vii) Label the solution.

Scope: This method is applied for solute in solid state and you should be able to determine the mass required from calculation to be weighed and provide distilled water to dissolve the solute.

Example:

- 1) Describe in details how you can prepare the following solution: 50 mL of NaOH, 10%.

Answer:

10% means that in 100 mL of solution only 10 g are pure in NaOH, so 50 mL of NaOH will be prepared by taking mass of NaOH.

$$\text{Mass of NaOH} = \frac{10\text{g} \times 50\text{ml}}{100\text{ml}} = 5\text{g of NaOH}$$

Procedure:

- Weigh 5g of NaOH accurately using glass watch, spatula and analytical balance.
- Dissolve it in a volumetric flask of 50 mL containing already little water and mix using a baguette and shake till you get homogeneous mixture (you should take care since it is an exothermic reaction).
- Top up using distilled water and shake again and cover your solution.
- Label your solution: NaOH10%; 50 mL and the date of preparation.

- 2) Describe in details how you can prepare 250 cm³ of 0.1M Na₂CO₃ solution.

Solution:

Step 1: Calculations

Calculate the amount of anhydrous sodium carbonate required to be dissolved in 250cm³ of solution. i.e.:

Molar mass of Na₂CO₃ = (23 x 2) + 12 + (16 x 3) = 106 g/mol

Thus, 1 mole of Na₂CO₃ has a mass of 106 g.

0.1 mole of Na₂CO₃ solution will have a mass = 106g/mol x 0.1 mol = 10.6 g.

1000cm³ of 0.1M Na₂CO₃ solution contains 10.6 g.

$$250\text{ cm}^3 \text{ of } 0.1\text{M Na}_2\text{CO}_3 = \frac{10.6\text{g} \times 250}{1000} = 2.65\text{g}$$

Step 2: Weighing

- Weigh a clean empty beaker and record its mass, m_1 (g)
 - Using a clean spatula add the mass of pure anhydrous sodium carbonate equal to the calculated mass. Let it be m_2 (g).
 - Actual mass of the carbonate transferred into the beaker = $(m_2 - m_1)$ g
- Note:** Not the entire sample gets transferred into the beaker since part of it sticks on the walls of the weighing bottle.

Step 3: Procedure

- Using a wash bottle, carefully add about 100cm^3 of distilled water. Stir using a glass rod until the entire solid has dissolved.
 - Carefully pour all the solution through a filter funnel into a volumetric flask. Wash off all the solution out of the beaker and off the glass rod; ensure that all the washings run into the volumetric flask.
 - Add distilled water until the level of the volumetric is about 2cm^3 below the 250cm^3 mark. Add the rest of the distilled water drop by drop using a dropping pipette until the bottom of the meniscus is level with the 250cm^3 mark when viewed at eye level.
 - Insert the stopper of the flask and invert the flask several times to mix the solution.
- Note:** Since the concentration of Na_2CO_3 solution has been determined, thus the solution prepared is a standard solution.

Checking up 11.3.1

Describe in details, how can you prepare the following solutions:

- 1L of KMnO_4 0.1M
- 250 mL acidified potassium dichromate 1N
- 100 mL oxalic acid 5g/L.

11.3.2. Preparation of standard solution by dilution

Activity 11.3.2

Preparation of 250 cm^3 of 0.5M H_2SO_4 solution from concentrated H_2SO_4 98%; density = 1.84

Materials

- Measuring cylinder
- Volumetric flask
- Stopper
- Concentrated H_2SO_4 98%
- Distilled water

Notice: Take care when mixing water and acid. When you mix acid with water, it is extremely important to add the acid to the water rather than the other way around. It is because acid and water react in a vigorous exothermic reaction, releasing heat, sometimes boiling the liquid. If you add acid to water, the water is unlikely to splash up, but even if it

did, it is less likely to hurt you than if you add water to acid. When water is added to acid, the water boils and the acid may splatter and splash.

Procedure

- (i) Calculate the volume of the concentrated acid needed (V_1) cm^3 .
- (ii) Using a clean measuring cylinder take V_1 of concentrated acid and transfer it carefully into 150 cm^3 of water into a 250 cm^3 volumetric flask and shake.
- (iii) Make the solution up to the mark with distilled water.
- (iv) Insert the stopper, shake, invert and label.

Formula related to dilution: $M_1V_1 = M_2V_2$ and $M_1 = \frac{\text{Percentage} \times \text{density}}{\text{Molar mass}} \times 10$

Where M_1 , V_1 are molarity and volume before dilution

M_2 , V_2 are molarity and volume after dilution

Apart from, dissolution method, we can prepare a solution by dilution from the stock solution. This consists of reducing the concentration of a concentrated stock solution to less concentrated solution by adding water.

The rationale is how we can prepare the desired solution of concentration C , with the volume V , from the stock solution whose concentration is C_0 . The question consists of determination of the volume let V_0 , to be pipetted from stock solution and diluted using X ml of water to get V . So, from the conservation principle of matter, the quantity of the solute before and after dilution should be the same.

n (before dilution) = n (after dilution)

$n_0 = c_0V_0$ (before dilution)

$n = cV$ (after dilution)

Thus $C_0V_0 = CV$ and $V_0 = \frac{cV}{C_0}$

But, $C_0V_0 = C(V_0 + x)$, solving with respect to x , we get

$x = \frac{C_0 - C}{C}V_0$ but $C_0 > C$ and x represents the volume of water to be added to V_0 .

Note: 1) The dilution factor is the concentration ratio or volume ratio defined as the number by which the solution is diluted. It is given by: $d_f = \frac{C_0}{C} = \frac{V}{V_0} > 1$

2) The mixture of two solutions S_1 and S_2 of the same substance with different concentration let C_1 and C_2 give the final solution S with intermediate concentration let C . So, $C_1 < C < C_2$. Hence, from conservation rule of matter $C_1V_1 + C_2V_2 = CV$,

$$C = \frac{C_1V_1 + C_2V_2}{V_1 + V_2}$$

Example:

- 1) Describe how you can prepare 1L a solution 1M in H₂SO₄ from the stock solution that is labeled as follow: d = 1.84; 98%; Mw = 98 g/mol.

Answer:

Let us consider determine the volume required to be pipetted from stock solution and d = 1.84; p = 98%; Mw = 98 g/mol

Being diluted; by definition, molarity of such solution is given by:

$$M = \frac{10 \times d \times p}{Mw} = \frac{10 \times 1.84 \times 98}{98} = 18.4M$$

The concentration of sulphuric acid is 18.4M

From dilution law, we have $M_0V_0 = MV$, $V_0 = \frac{MV}{M_0} = \frac{1M \times 1L}{18.4M} = 0.05435L = 54.35 \text{ mL}$

That is required to be pipetted from 18.4M

Volume of water = 1000 mL - 54.35 mL = 945.65 mL **Procedure:**

- Pipette only 54.35 ml of sulphuric acid accurately using a pipette from a stock solution.
- Pour them gently in the flatted balloon of 1L containing already little water and shake. Note that you should take much care since the reaction is exothermic and sulphuric acid is harmful to skin **remember that we pour acid to water not water to acid that is A-W not W-A.**
- Top up to 1L using distilled water and shake again in order to homogenize the solution.
- Cover the solution, then label it: H₂SO₄ 1M and date of preparation.

- 2) Calculate the volume of 15M H₂SO₄ that would be required to prepare 150cm³ of 2MH₂SO₄.

Answer:

Using $M_1V_1 = M_2V_2$, then

$$15 \times V_1 = 2 \times 150$$

$$V_1 = \frac{300}{15} = 20\text{cm}^3$$

Volume of 15M H₂SO₄ required 20 cm³

OR

1000cm³ of diluted acid contain 2mol

$$150\text{cm}^3 \text{ of diluted acid will contain} = \frac{2 \times 150 \text{ mol}}{1000} = 0.3 \text{ mol}$$

But, 15moles of concentrated H₂SO₄ are contained in 1000 cm³,

$$\text{Then, } 0.3\text{moles of concentrated H}_2\text{SO}_4 \text{ will be contained in } \frac{1000 \times 0.3}{15} = 20 \text{ cm}^3$$

Volume of 15M H₂SO₄ required 20 cm³.

Checking up 11.3.2

A 0.2N solution was diluted by addition of 200 mL of water.

Calculate the dilution factor if the solution is diluted from 0.2N to 0.05N.

Determine the final volume of the solution after dilution.

11.4. Simple acid-base titrations

Activity 11.4

You are provided with S₁: solution of HCl (aq) 0.1 M

S₂: solution of NaOH (aq)

Materials

- Burette
- Measuring cylinder
- Conical flask
- Retort stand
- Indicator (phenolphthalein)
- Washing bottle
- Beakers
- Funnel

Procedure

- a) Using a pipette, transfer 10 mL of S₂ into a conical flask.
- b) Add three drops of phenolphthalein indicator and titrate it with S₁ from the burette.
- c) Repeat the titration until you obtain consistent values.
- d) Record your readings in the table below:

Experiment number	1	2	3
Final burette readings in cm ³			
Initial burette readings in cm ³			
Volume of S ₁ used in cm ³			

- a) Calculate the average volume of S₁ used.
- b) Calculate the number of moles of HCl that react with S₂.
- c) Calculate the molarity of S₂ in 10 mL.

Titration is the controlled addition and measurement of the amount of a solution of known concentration required to react completely with a measured amount of a solution of unknown concentration.

Acid-base titration

It is the determination of the concentration of an acid or base by exactly neutralizing the acid or base of known concentration

Alkalimetry and acidimetry

- **Alkalimetry** is the specialized analytic use of acid-base titration to determine the concentration of a basic substance.
- **Acidimetry** is the same concept of specialized analytic use of acid-base titration to determine the concentration of an acidic substance.

Equivalence point

The point at which the two solutions used in a titration are present in chemically equivalent amount is the equivalence point. At this point the moles of two solutions will be equal.

Therefore, $n_a M_b V_b = n_b M_a V_a$,

Where M_a =Molarity of acid; M_b =Molarity of the base

V_b =Volume of base; n_a = stoichiometric number of acid

V_a =Volume of acid; n_b = stoichiometric number of acid

Indicators and pH-meters can be used to determine the equivalence point. The point in a titration at which an indicator changes color is called the **end-point** of the titration.

Equipments and set up (Figure 11.1) of materials for Titration

The common equipment used in a titration are:

- Burette
- Pipette
- pH-indicator/acid-base indicator
- White tile: used to see a color change in the solution(a white paper can also be used)
- Conical flask (Erlenmeyer flask)
- Titrant: a standard solution of known concentration
- Analyte: a solution of unknown concentration

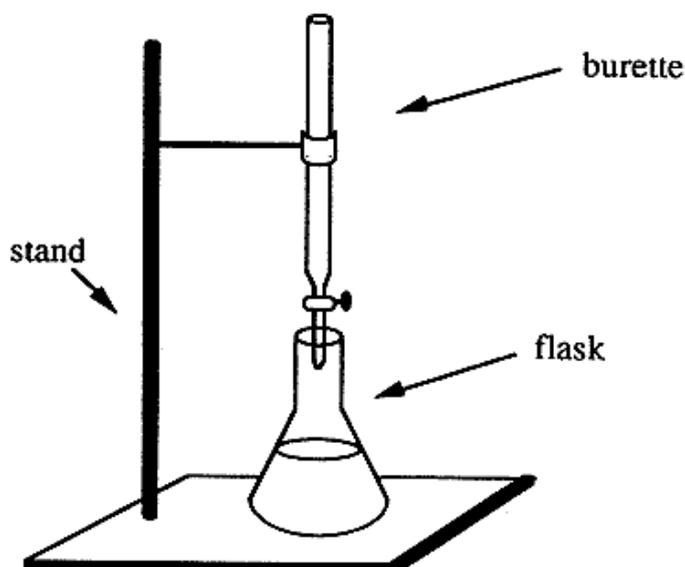

Figure 11.1: Setup of titration

How to perform titrations

Knowing the use of pipette and burettes and how to handle them, the following points are useful in order for a correct titration to be done:

1. The apparatus should be arranged as shown in the above Figure.

2. The burette tap is opened with the left hand and the right hand is used to shake the conical flask.
3. The equivalence-point is reached when the indicator just changes permanently the colour.
4. At the end-point, the level of the titrant is read on the burette
5. The titration is now repeated, three more times are recommended. Towards the end-point, the titrant is added dropwise to avoid overshooting.

Notice: Before titration, check if the tip of the burette is filled with the titrant, and doesn't contain bulb of air. If there is a bulb of air, a quick opening and closing of the tap will expel the air out of the burette.

Choice of indicators in acid-base titrations

When the technique of acid-base titration is extended to a wide variety of acidic and alkaline solution, care needs to be taken about the choice of indicator for any given reaction.

The choice of an inappropriate indicator would lead to an incorrect results, and it is therefore extremely important that the indicator is chosen carefully.

The principle on which a choice of indicator is made concerns the strength of the acid or base involved in the reaction. Note that the strength of an acid or base is not to be confused with the concentration of its solution. Example of strong and weak acids and bases and choice of indicator are given in the Table below.

Table 11.1. Examples of strong/weak acids and bases

Acids		Base	
Strong	Weak	Strong	Weak
Hydrochloric acid, HCl	Ethanoic acid, CH ₃ COOH	Sodium hydroxide, NaOH	Ammonia, NH ₃
Nitric acid, HNO ₃	Methanoic acid, HCOOH	Potassium hydroxide, KOH	
Sulphuric acid, H ₂ SO ₄	Carbonic acid, H ₂ CO ₃	Sodium carbonate, Na ₂ CO ₃	

Indicators which are suitable for particular types of acid-base titrations are given in the Table 11.2.

Table 11.2. Examples of indicators

Acid-base titration	Example	Choice of indicator
Strong acid/strong base	H ₂ SO ₄ and NaOH	Any indicator
Weak acid/strong base	CH ₃ COOH and KOH	Phenolphthalein
Strong acid/weak base	HCl and NH ₃	Methyl orange
Weak acid/weak base	CH ₃ COOH and NH ₃	No satisfactory indicator available

The results are summarized in a table as shown below.

Table 11.3. Sample results

Experiment number	1	2	3
Final burette reading / cm ³	25.50	34.00	29.10
Initial burette reading / cm ³	0.00	10.00	5.00
Volume of solution used / cm ³	25.50	24.00	24.10

Notice:

- Burette readings should be written to two decimal places (for burette having precision up to hundredth)
- Average titre should be obtained using values which differ not by more $\pm 0.10\text{cm}^3$

(Consistent values) for example, $\frac{24.00 + 24.10}{2} = 24.05 \text{ cm}^3$

Examples:

1) Suppose 20.00 mL of $5.0 \times 10^{-3} \text{ M}$ NaOH is required to reach the end-point in the titration of 10.0 mL of HCl of unknown concentration. How can these titration data be used to determine the molarity of the acidic solution.

Answer:

Begin with the balanced neutralization reaction equation. From the equation, determine the chemically equivalent amount of HCl and NaOH.

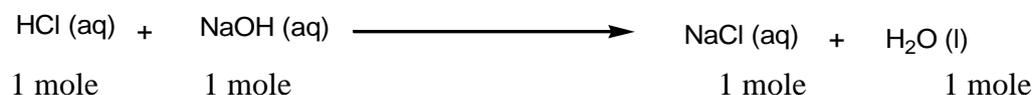

Calculating the number of moles of NaOH used in the titration;

$$\begin{aligned} \text{Molarity} &= n/v; & n &= \text{Molarity} \times \text{Volume} \\ n &= 5.0 \times 10^{-3} \text{ M} \times 20.0 \times 10^{-3} \text{ L} = 10^{-4} \text{ moles of NaOH.} \end{aligned}$$

Because one mole of NaOH is needed to neutralize one mole of HCl, the amount of HCl in the titration must be 10^{-4} moles of HCl.

The molarity of the HCl can now be calculated.

At the end-point: $M_a V_a = M_b V_b$ because $n_a = n_b = 1$

M_a = Molarity of acid HCl M_b = Molarity of base NaOH

V_a = Volume of acid HCl V_b = Volume of base NaOH.

$$M_a = \frac{M_b V_b}{V_a} = \frac{0.005 \text{ mol/l} \times 0.020 \text{ l}}{0.010 \text{ l}} = 10^{-2} \text{ mol/L}$$

$$M_a = 10^{-2} \text{ mol/L or } M_a = 10^{-2} \text{ M or } M_a = 0.01 \text{ M of HCl}$$

2) 20.0 cm³ of 0.10 M sodium carbonate completely reacted with 25.0 cm³ of hydrochloric acid using methyl orange indicator.

a. Write the equation of reaction taking place.

b. Calculate:

- i) The number of moles of sodium carbonate that reacted.
- ii) The number of moles of hydrochloric acid that reacted.
- iii) The concentration of hydrochloric acid in mole.dm⁻³.

Answer

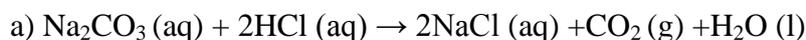

b) i) Moles of Na_2CO_3 used = $\frac{20.0 \times 0.10}{1000} = 0.002$ moles

ii) Reaction ratio Na_2CO_3 : $\text{HCl} = 1 : 2$

Moles of $\text{HCl} = 0.002 \text{ mole} \times 2 = 0.004$ moles

iii) 25.0 cm³ of solution contain 0.004 moles

1000 cm³ of solution contain $\frac{0.004 \times 1000}{25.0} = 0.16$ moles

Molarity of hydrochloric acid = 0.16 M

3) Standardization of sodium hydroxide using 0.1M Hydrochloric acid.

Reagents provided

- FA₁ is 0.1M hydrochloric acid solution
- NaOH pellets
- Phenolphthalein indicator
- Distilled water.

Procedure:

Weigh accurately 1.0 g of sodium hydroxide pellets in a weighing bottle and transfer into a 250cm³ volumetric flask. Add a little distilled water and shake to dissolve. Make up the solution to the mark with distilled water. Label the solution FA₂. Pipette 20 cm³ (or 25cm³) of FA₂ into a conical flask, add 2-3 drops of phenolphthalein indicator and titrate with FA₁ from the burette. Record your results in the spaces provided below.

Specimen results:

Mass of weighing container + NaOH pellets = 11.30 g

Mass of weighing container alone = 10.30 g

Mass of NaOH pellets = 11.30 g – 10.30 g = 1.00 g

Masses should be recorded to at least two decimal places (Table 11.4)

Volume of pipette used =

Table 11.4. Burette readings

Experiment number	1	2	3
Final burette reading (cm ³)	36.20	25.10	30.80
Initial burette reading (cm ³)	10.80	0.00	5.60
Volume of FA ₁ used (cm ³)	25.40	25.10	25.20

Each value or entry in the table must be recorded or written to two decimal places. Different initial readings should be used. Initial reading in each experiment should be correctly subtracted from the final reading.

Questions:

- Determine the values used to calculate average volume, and calculate the average volume of FA₁ used.
- Write the equation of the reaction between NaOH and HCl
- Calculate the number of moles of FA₁ used.
- Calculate the concentration of FA₂ in mol.dm⁻³.
- Calculate the concentration of FA₂ in g/L.

Answer:

Volume of pipette used = 25.0 cm³

- a) The values used to calculate average volume are 25.10 cm³ and 25.20 cm³

$$\text{Average volume} = \frac{25.10 + 25.20}{2} \text{cm}^3 = 25.15 \text{cm}^3$$

- b) Equation: NaOH(aq) + HCl(aq) → NaCl(aq) + H₂O(l)

- c) Number of moles of FA₁ used:

All working (calculation) should be done from first principles:

1000 cm³ of FA₁ solution contain 0.1 mole of HCl

$$25.15 \text{cm}^3 \text{ of FA}_1 \text{ solution used will contain} = \frac{0.1 \times 25.15 \text{ mol}}{1000} = 0.002515 \text{ mol}$$

Number of moles of FA₁ = 0.002515 mol.

- d) Concentration of FA₂ in mol.dm⁻³

From the equation of the reaction in (a);

1mole of HCl neutralizes 1mole of NaOH

Number of moles of FA₂ used (reacted) = 0.002515 moles of NaOH.

25.0 cm³ of FA₂ used contain 0.002515 mol

$$1000 \text{cm}^3 \text{ of FA}_2 \text{ will} = \frac{0.002515 \times 1000}{25} = 0.1006 \text{mol.dm}^{-3}$$

Concentration of FA₂ (NaOH) = 0.1006mol.dm⁻³

- e) Concentration of FA₂ in g/L (Na = 23, O =16, H=1)

Molecular mass of NaOH = 23+16+1= 40g/mol

Thus 1 mole of NaOH weighs 40 g

0.1006 mole of NaOH will weigh = 40 x 0.1006g = 4.024

Concentration of FA₂ in g/l = 4.024g/L

Checking up 11.4

- 20.00cm³ of 0.4M HCl was used to neutralize 40cm³ of Ba(OH)₂. Determine the molar concentration of Ba(OH)₂.
- 25.0cm³ of sodium hydroxide solution is neutralized by 15.0cm³ of a solution of hydrochloric acid of concentration 0.25M. Find the concentration of the sodium hydroxide solution.
- Practical: Acid-base titration**

You are provided with the following:

- BA₁, which is a 0.1 M H₂SO₄ solution
- BA₂, which is a solution of NaOH with unknown concentration

Procedure

- Pipette 20.0 cm³ of BA₂ into a conical flask. Add three drops of methyl orange indicator.
- Titrate with BA₁ from burette
- Repeat the titration until you obtain consistent values.
- Record your results in the table below:

Experiment number	1	2	3
Final burette readings in cm ³			
Initial burette readings in cm ³			
Volume of BA ₁ in cm ³			

Title values used for calculating average volume of BA₁ are:

Average volume of BA₁ used:

Questions

- The equation of the reaction is:
- Calculate the number of moles of H₂SO₄ reacted with NaOH.
- Calculate the number of moles of NaOH reacted with H₂SO₄.
- Calculate the molarity of BA₂.
- Calculate the concentration of BA₂ in g/L.

11.5. Titration involving redox reactions

Activity 11.5

- What does differentiate redox reactions from other reactions?
- Balance the following redox equations using half-equation method:
 - $\text{KMnO}_4 + \text{H}_2\text{C}_2\text{O}_4 + \text{H}_2\text{SO}_4 \rightarrow \text{MnSO}_4 + \text{CO}_2 + \text{K}_2\text{SO}_4 + \text{H}_2\text{O}$
 - $\text{KMnO}_4 + \text{FeSO}_4 + \text{H}_2\text{SO}_4 \rightarrow \text{MnSO}_4 + \text{Fe}_2(\text{SO}_4)_3 + \text{K}_2\text{SO}_4 + \text{H}_2\text{O}$
 - $\text{KMnO}_4 + \text{H}_2\text{O}_2 + \text{H}_2\text{SO}_4 \rightarrow \text{MnSO}_4 + \text{O}_2 + \text{K}_2\text{SO}_4 + \text{H}_2\text{O}$

11.5.1. Titrations with potassium manganate (VII); KMnO₄

Potassium manganate (VII), KMnO_4 , is a useful oxidizing agent in a sufficiently acidic medium normally used in the reactions such as:

- Oxidation of iron (II) to iron III
- Oxidation of ethanedioate (oxalates) or oxalic acid to carbon dioxide.
- Oxidation of nitrites to nitrates
- Oxidation of hydrogen peroxide to oxygen, etc.

During the reactions, the manganate (VII) ions, MnO_4^- , which is purple, is reduced to manganese(II), Mn^{2+} , which is pale pink but practically colorless.

Thus, titrations involving potassium manganate (VII), do not require an indicator. KMnO_4 acts as its own indicator.

The end-point of titration is detected when the solution shows a permanent faint pink color, which is as a result of slightly excess of potassium manganate (VII).

For reduction of the potassium manganate (VII) to be complete, sufficient acid should be used and the solution added slowly, not rapidly. Use of insufficient acid results in precipitation of manganese (IV) oxide, MnO_2 , which appears as a brown precipitate.

The suitable acid for this process is sulphuric acid. Hydrochloric acid is unsuitable because the MnO_4^- ion is a stronger oxidizing agent than Cl_2 ; it oxidizes the chloride ion in the acid to molecular chlorine.

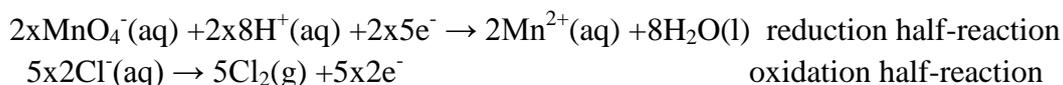

Nitric acid is also not used to acidify the solution of potassium manganate (VII) since it is also a powerful oxidizing agent. In potassium manganate (VII) titrations, an indicator is used only when the reducing agent forms a colorless solution which makes it difficult to observe the pink color.

11.5.1. Titration of Fe^{2+} by Potassium manganate (VII), KMnO_4

Activity 11.5.1

Balance the following redox equations using half-equations method:



(ii) Determine the oxidizing and reducing agents in the above equation

(iii) What is the colour of MnO_4^- , Mn^{2+} and Fe^{2+} ?

Most redox titration labs utilize an iron (II) salt, frequently **iron (II) sulphate heptahydrate**. This compound is used for two reasons. First, it has a large molar mass, making it a good (but not the best) primary standard. Second, its solution is near colorless, so the pink/purple endpoint is easy to detect. Color proves to be an issue when dealing with many other

compounds. Iron (II) salts are an excellent choice for a titration utilizing potassium permanganate.

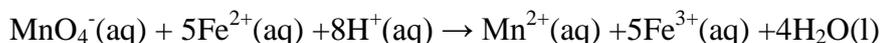
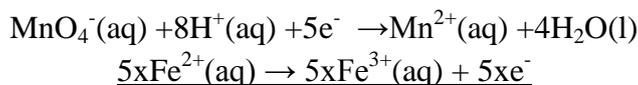

Reaction ratio $\text{Mn}^{2+} : \text{Fe}^{2+}$ is 1: 5

Examples

- 1) Calculate the percentage purity of Fe^{2+} in 5 g of Fe^{2+} dissolved in 1dm^3 of solution which 50cm^3 was used to titrate 15cm^3 of 0.02 M KMnO_4 acidified with sulphuric acid.

Answer:

Write balanced equation:

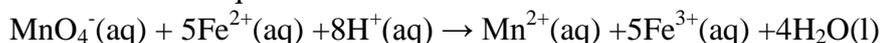

Moles of $\text{MnO}_4^- = 0.02 \times 15 \times 10^{-3} = 0.3 \times 10^{-3} \text{mol}$

Molar ratio between $\text{MnO}_4^- : \text{Fe}^{2+} = 1:5$

Number of mole of Fe^{2+} :

1mole of MnO_4^- used to titrate 5 moles of Fe^{2+}

$0.3 \times 10^{-3} \text{mole of MnO}_4^- = 0.3 \times 10^{-3} \times 5 = 1.5 \times 10^{-3} \text{mole of Fe}^{2+}$ in 50cm^3

50cm^3 of Fe^{2+} contain $1.5 \times 10^{-3} \text{mole of Fe}^{2+}$

Therefore, 1000cm^3 contain $= \frac{1000 \times 0.0015}{50} = 3.0 \times 10^{-2} \text{mole of Fe}^{2+}$

Mass of 1mole of $\text{Fe}^{2+} = 56 \text{g}$

Mass of 0.03 mole of $\text{Fe}^{2+} = 0.03 \times 56 = 1.68 \text{g of Fe}^{2+}$

% of pure $\text{Fe}^{2+} = \frac{1.68 \times 100}{5} = 33.6\%$

- 2) 1.40g of sample of an iron wire was dissolved in dilute sulphuric acid and the solution made to 250cm^3 with distilled water. If 25cm^3 of this solution required 25.37cm^3 of a solution containing 2.33g of potassium permanganate per litre, calculate the percentage of iron in the sample.

Answer:

Iron dissolves in dilute sulphuric acid by the reaction equation:

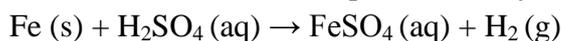

Then Fe^{2+} is oxidized by acidified MnO_4^- according to the equation:

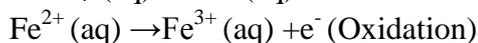

Balancing the above half-equations, we get

Redox equation:

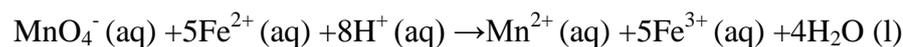

Mole ratio is 1:5 for MnO_4^- and Fe^{2+}

Molecular equation is the following:



$$\text{. Molarity of KMnO}_4 = \frac{m}{M \times V} = \frac{2.33}{158 \times 1} = 0.0147\text{M}$$

$$\text{. Number of moles of MnO}_4^- = 0.0147\text{M} \times 25.37 \times 10^{-3}\text{L} = 3.73 \times 10^{-4} \text{ moles}$$

$$\text{. Number of moles of Fe}^{2+} = 3.73 \times 10^{-4} \text{ moles} \times 5 = 1.865 \times 10^{-3} \text{ mole contained in } 25\text{cm}^3$$

$$\text{. In } 250\text{cm}^3 \text{ will contain} = \frac{0.001865 \times 250}{25} = 1.865 \times 10^{-2} \text{ mole}$$

$$\text{. The mass of Fe}^{2+} = 1.865 \times 10^{-2} \text{ mole} \times 56\text{g/mole} = 1.0444\text{g}$$

$$\text{. The percentage of Iron in the sample} = \frac{1.0444 \times 100}{1.40} = 74.6\%$$

Checking up 11.5.1

25 cm³ of solution containing Iron (II) and Iron (III) ions was acidified with dilute sulphuric acid and titrated with 0.02M KMnO₄. 20cm³ of potassium manganite (VII) was needed to reach end point. A second 25cm³ of the mixture was first reduced with zinc powder and then on titration with 0.02M potassium manganite (VII) solution, 24cm³ was required to reach the end point.

- Calculate the concentration of iron (II) in the mixture in mole dm⁻³
- Calculate the concentration of Iron (III) in the mixture in mole dm⁻³.

11.5.2. Titration of oxalic acid or oxalates by potassium manganate (VII)

Activity 11.5.2

In a redox reaction involving manganate (VII) ions, 25.0cm³ of FA₂ was pipetted then acidified. The resultant acid mixture required 25.0cm³ of FA₁ for complete reaction. If FA₁ is a solution containing 2.38 g/L of manganate (VII) ions and, FA₂ is a contaminated solution containing 30.60g of Iron (II) sulphate.

Calculate the:

- Molar concentration of Fe²⁺ in FA₂.
- Mass of pure iron (II) sulphate in 1dm³ of FA₂. (Molar mass of Iron (II) sulphate = 278 g/mole).
- Percentage purity of the sample used for making solution FA₂.

The reducing agent is the oxalate ion, C₂O₄²⁻. Oxalic acid is a white crystalline solid of formula H₂C₂O₄.2H₂O

The reaction between the oxalate ion and manganate (VII) ion is kinetically slow at temperature below 60⁰C. Titrations at room temperature take too long time for the purple color of the manganate (VII) ion to disappear. In the oxalate ion, carbon has (III) oxidation

state; when reacted with potassium permanganate the oxidation state changes into (IV). Titrations involving the oxalates are a little more involved, but the results were very good. The reaction below describes the overall redox reaction:

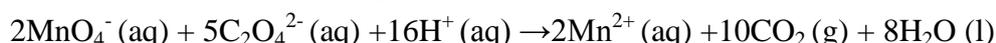

The reaction ratio is $\text{MnO}_4^- : \text{C}_2\text{O}_4^{2-} = 2: 5$

Example 1:

0.9875 g of an impure potassium manganate (VII) was dissolved and the solution made up to 250 cm³. To 20.0 cm³ of the resultant solution was added 5 cm³ of 2 M sulphuric acid, warmed and titrated against sodium oxalate made by dissolving 1.675 g of anhydrous sodium oxalate to make 250 cm³ of solution and 24.40 cm³ of the oxalate solution was used. ($\text{Na}_2\text{C}_2\text{O}_4 = 134$ and $\text{KMnO}_4 = 158$). Calculate the percentage purity of potassium manganite (VII).

Answer:

Overall equation is:

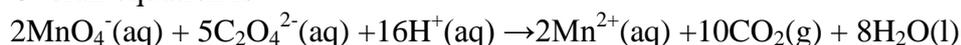

$$\text{Mass of Na}_2\text{C}_2\text{O}_4 \text{ in } 1 \text{ dm}^3 = \frac{1.675 \times 1000}{250} = 6.7 \text{ g}$$

$$\text{Molarity of Na}_2\text{C}_2\text{O}_4 = \frac{6.7}{134} = 0.05 \text{ M}$$

$$\text{Number of moles of oxalate used} = \frac{0.05 \times 24.40}{1000} = 1.22 \times 10^{-3} \text{ mol}$$

$$\text{Number of moles of MnO}_4^- \text{ used} = \frac{2}{5} \times \text{Number of moles of C}_2\text{O}_4^{2-}$$

$$\text{i.e.: } \frac{2}{5} \times 0.00122 = 4.88 \times 10^{-4} \text{ mol}$$

$$\text{Number of moles of MnO}_4^- \text{ in } 250 \text{ cm}^3 \text{ solution} = \frac{250 \times 0.000488}{20} = 0.0061 \text{ mol}$$

$$\begin{aligned} \text{Mass of KMnO}_4 \text{ in } 250 \text{ cm}^3 \text{ solution} &= \text{Number of moles} \times \text{molar mass} \\ &= 0.0061 \times 158 = 0.9638 \text{ g} \end{aligned}$$

$$\text{Percentage purity} = \frac{0.9638 \times 100}{0.9875} = 97.6\%$$

Example 2:

Determination of the purity of calcite: Calcium carbonate which is impure

Procedure:

- (i) A fixed mass 2.4 g of calcite is weighed and dissolved in dilute hydrochloric acid
- (ii) To this solution is then added ammonia solution until the solution is alkaline and this is followed by addition of ammonium ethanedioate (oxalate) to precipitate all calcium ions as calcium oxalate
- (iii) The precipitate is then filtered off, washed and then dissolved in a minimum dilute sulphuric acid solution and then solution made up to 250 cm³ in a volumetric flask with distilled water.
- (iv) 25.0 cm³ of the resultant solution in (iii) is pipetted and to it is added 20 cm³ of diluted sulphuric acid and the mixture is heated to about 70 °C.
- (v) The hot solution is then titrated with 0.02M potassium permanganate solution

Results: 25.0 cm³ of the oxalate solution required 24.10 cm³ of 0.02M KMnO₄ solution for complete reaction which is detected by the intense purple colour.

- (a) Write down the overall equation for the above sequence of analysis
- (b) Calculate the percentage of purity of calcite

Answer:

- a) **Step1:** Calcite CaCO₃ dissolves in HCl to give CaCl₂ and CO₂ given off

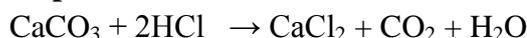

- Step2:** The Ca²⁺ is then reacted with oxalate ion to precipitate as calcium oxalate



- Step3:** After washing, the precipitate is dissolved in H₂SO₄

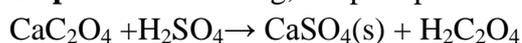

- Step4:** The titration of H₂C₂O₄ by KMnO₄ after acidifying with H₂SO₄.

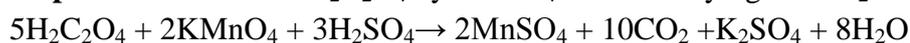

The overall equation is obtained by combining the above reaction equations and get:



- b) Number of moles of MnO₄⁻ that reacted = 0.02 x 24 x 10⁻³ moles = 4.82 x 10⁻⁴ moles

Since 2 moles of MnO₄⁻ react with 5 moles of C₂O₄²⁻, therefore,

$$\text{-Number of moles of C}_2\text{O}_4^{2-} = \frac{5}{2} \times 4.82 \times 10^{-4} \text{ moles} = 1.205 \times 10^{-3} \text{ mole in } 25\text{cm}^3$$

$$250\text{cm}^3 \text{ will contain} = \frac{0.001205 \text{ mole} \times 250\text{cm}^3}{25\text{cm}^3} = 1.205 \times 10^{-2} \text{ moles}$$

-This means that number of moles of calcium is 1.205 x 10⁻² moles and is equal to the number of moles of pure calcium carbonate (CaCO₃). Thus,

$$\text{-Mass of calcium carbonate} = 1.205 \times 10^{-2} \text{ moles} \times 100 \text{ g/mole} = 1.205 \text{ g}$$

$$\text{-Percentage purity of calcite in a sample} = \frac{1.205}{2.4} \times 100 = 50.208\%$$

Checking up 11.5.2

FA₁ is a solution containing 9.40g of a mixture of anhydrous ethanedioic acid and sodium ethanedioate in a volume of litre of solution.

FA₂ is 0.1M sodium hydroxide.

FA₃ is 0.02M potassium manganite (VII).

On titration 25.0cm³ of acidified FA₁ required 35.60cm³ of FA₃ and, 25.0cm³ of FA₁ required 24.0cm³ of FA₂ for complete neutralization.

Determine the:

- Molar concentration of ethanedioic acid.
- Percentage of sodium ethanedioate in FA₁.

11.5.3. Titration of hydrogen peroxide by Potassium manganate (VII), KMnO₄

Activity 11.5.3

6 g of CaC₂O₄ was dissolved to make up 1dm³ of solution. 20 cm³ of the resultant solution titrated 27.5 cm³ of 0.02M KMnO₄ acidified with H₂SO₄. Calculate the percentage purity of Ca²⁺ in CaC₂O₄.

Hydrogen peroxide is a powerful reducing agent in the presence of a strong oxidizing agent such as potassium permanganate. For this reason dilute concentrations of both compounds must be used. A common laboratory experimentally determines the concentration of commercially sold hydrogen peroxide (about 3%) via titration with potassium permanganate (usually prepared to be approximately 0.02 M). Concentrated solutions of these reactants will react explosively and must be avoided.

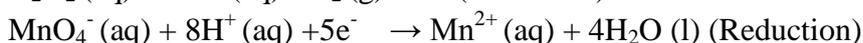

Overall equation is:

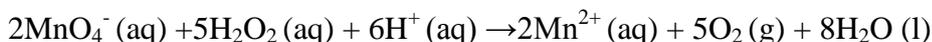

Reaction ratio is $\text{MnO}_4^- : \text{H}_2\text{O}_2 = 2 : 5$

The concentration of H₂O₂ solution is usually expressed in terms of volume of oxygen measured at s.t.p, available from a fixed amount (or mass) of H₂O₂.

This unit of concentration is called **volume strength or volume concentration**.

Thus, volume strength is defined as, the volume of oxygen available from a unit volume of the H₂O₂ solution measured at s.t.p.

Therefore, a volume solution of H₂O₂ is one, which yields 1 volume of O₂ for each volume of the H₂O₂ solution decomposed, example: 1cm³ of 100 volume H₂O₂ decomposes to yield 100cm³ of O₂ measured at s.t.p. from the equation:



By definition; 2moles of H_2O_2 produces 1mole of O_2 which has volume strength of 22.4 litres at s.t.p.

1mole of H_2O_2 has volume strength of 11.2 litres at s.t.p or 22.4 volume solution contains 68g/l H_2O_2 .

Example:

100 cm^3 of H_2O_2 was dissolved in 1 dm^3 of solution. 25 cm^3 of the solution was titrated with 44 cm^3 of 0.02M KMnO_4 acidified with H_2SO_4 .

- Calculate the concentration of H_2O_2 solution in mol dm^{-3} .
- Calculate the volume of oxygen produced.

Answer:

Write the balanced equation

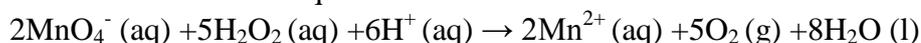

- a) Moles of $\text{MnO}_4^- = 44 \times 10^{-3} \times 0.02 = 0.88 \times 10^{-3}$ mole

Molar ratio, $\text{MnO}_4^- : \text{H}_2\text{O}_2 = 2:5$

2moles of MnO_4^- titrate 5moles of H_2O_2

0.88×10^{-3} moles of $\text{MnO}_4^- = \frac{5}{2} \times 0.88 \times 10^{-3}$ moles = 2.2×10^{-3} moles of H_2O_2 in 25 cm^3

1000 cm^3 of H_2O_2 contain = $\frac{1000 \times 0.0022}{25} = 0.088\text{M}$

- b) Volume of oxygen:

Mole of O_2 : 1Mole H_2O_2 decomposes to give $\frac{1}{2}$ mole of O_2

0.088 Mole of $\text{H}_2\text{O}_2 = 0.088 \text{ Mole} \times 0.5 = 0.044$ moles of O_2

But 1mole of O_2 occupies 22.4 dm^3

0.044 mole of $\text{O}_2 = 0.044 \text{ mole} \times 22.4 \text{ dm}^3/\text{mole} = 0.9856 \text{ dm}^3 = 985.6 \text{ cm}^3$

Note: The advantages of potassium permanganate as oxidizing agent are:

- It acts as its own indicator (i.e. purple color)
- The crystals are obtained at high state of purity
- The crystals are anhydrous and not deliquescent
- It has a fairly high relative molecular mass
- A wide range of substances can be oxidized by it.

However, potassium permanganate has disadvantages:

- The crystals are not very soluble in water
- The compound is decomposed by the light
- The compound is reduced by water and organic matter from atmosphere
- The meniscus of the solution may be difficult to see.

Checking up 11.5.3

5.0 cm³ of a solution of hydrogen peroxide was diluted to 250cm³ with water. 25.0 cm³ of this solution required 24.6 cm³ of 0.02M of potassium manganate (VII) solution for complete oxidation. Calculate:

- Concentration in mol.dm⁻³ of the original hydrogen peroxide
- The volume strength of the hydrogen peroxide.

11.5.4. Titration with potassium dichromate (VI), K₂Cr₂O₇

Activity 11.5.4

Discuss the advantages and disadvantages of using KMnO₄ as an oxidizing agent in titration.

Potassium dichromate (VI) unlike potassium manganate (VII) is a primary standard. In the titration of potassium dichromate (VI), the color change is from **orange** to **green** and this makes it not possible to detect the sharp end-point.

Thus, an indicator is necessary for this reaction. Therefore redox indicator such as barium diphenylamine sulphonate must be used, which changes its colour to blue at the end point.

Potassium dichromate (VI) is a weaker oxidizing agent than potassium manganate (VII). As such it cannot oxidize the chloride ion to chlorine, and therefore hydrochloric acid in addition to sulphuric acid can be used to acidify solution of potassium dichromate (VI).

The reactions of potassium dichromate (VI) are similar to those of potassium manganate (VII), however at the end-point the color is **green due to the presence of chromium (III) ions** that is;

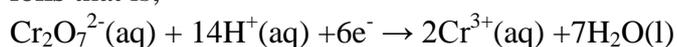

In volumetric analysis, K₂Cr₂O₇ is commonly used in:

a) Determination of the concentration of iodide ions.

Since iodide ions can be oxidized to molecular iodine by dichromate (VI) ion, potassium dichromate (VI) can be used as a primary standard in this reaction.

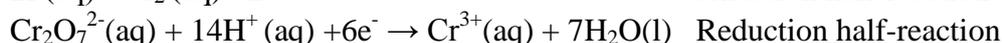

Overall reaction equation is:

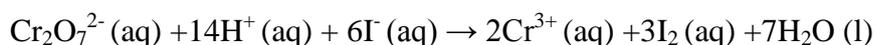

The amount of iodine liberated in the reaction is determined by titrating it against a standard solution of sodium thiosulphate using starch indicator.

b) Analysis of iron (II) salts



Overall equation is:

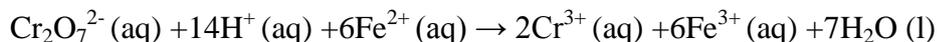

c) Analysis of nitrite salts



d) Analysis of tin (II) salts



Advantages of $\text{K}_2\text{Cr}_2\text{O}_7$ over KMnO_4

Unlike KMnO_4 , $\text{K}_2\text{Cr}_2\text{O}_7$ is used as a primary standard i.e. it can always be obtained pure; it is stable under ordinary conditions, its aqueous solution can be stored for long time if sufficiently protected from evaporation.

Examples:

1) 4.0 g of hydrated ammonium ferrous sulphate $(\text{NH}_4)_2\text{SO}_4 \cdot \text{FeSO}_4 \cdot 6\text{H}_2\text{O}$ (Mohr's salt) are dissolved in 25.0 cm^3 of 2 M H_2SO_4 and made up to 250.0 cm^3 with distilled water. 25.0 cm^3 of the resultant solution required 15.0 cm^3 of potassium dichromate (VI) during the titration. Calculate concentration of potassium dichromate (VI).

Answer:

Molar mass of ammonium ferrous sulphate = 392 g/mol

$$\text{Mass of iron (II) salt in } 1 \text{ dm}^3 = \frac{4.0 \times 1000}{250} = 16.0 \text{ g}$$

$$\text{Molarity of iron (II) salt} = \frac{16.0}{392} = 0.04 \text{ M}$$

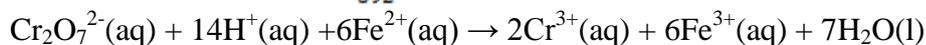

$$\text{Number of moles of Fe}^{2+} \text{ in } 25.0 \text{ cm}^3 = \frac{0.04 \times 25.0}{1000} = 0.001 \text{ mol}$$

$$\text{Number of moles of Cr}_2\text{O}_7^{2-} = \frac{1}{6} \times \text{number of moles of Fe}^{2+}$$

$$\text{i.e.: } \frac{1}{6} \times 0.001 = 0.000167 \text{ mol}$$

$$\text{Concentration of Cr}_2\text{O}_7^{2-} = \frac{0.000167 \times 1000}{15} = 0.01 \text{ M}$$

- 2) 6 g of FeSO₄ was dissolved in 1dm³ of solution. 50cm³ of this solution was titrated with 20 cm³ 0.01666M Cr₂O₇²⁻. Diphenylamine was used as indicator in phosphoric acid. Calculate the percentage of the purity of ions in the FeSO₄ sample.

Answer:

Write balanced equation

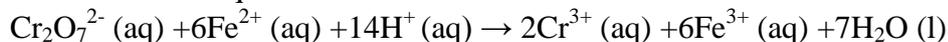

Moles of Cr₂O₇²⁻ = 20 x 10⁻³ x 0.01666 moles = 0.0003332 moles

Molar ratio Cr₂O₇²⁻:Fe²⁺ = 1:6

1mole of Cr₂O₇²⁻ reacts with 6 moles of Fe²⁺

0.0003332 mole = 0.0003332 x 6 moles = 0.001992 moles of Fe²⁺ in 50cm³

Number of moles of Fe²⁺ in 1000 cm³ = $\frac{0.001992 \times 1000}{50}$ = 0.038984 mole of Fe²⁺

Mass of Fe²⁺ = 0.038984 mole x 56 g/mole = 2.239 g

% Fe²⁺ = $\frac{2.239 \text{g} \times 100}{6}$ = 37.3%

Checking up 11.5.4

Steel is one of the alloys of iron. 1.40g of a sample of steel was dissolved in dilute acid to convert all the iron into Fe²⁺(aq). The solution was made up to 100cm³ using distilled water. 10cm³ of this solution were acidified and titrated with 0.0167M potassium dichromate (K₂Cr₂O₇) using a suitable indicator. 24.4cm³ of potassium dichromate were required to reach end point. The reduction of dichromate ions is represented by the equation:

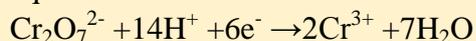

- What is meant by the term ‘alloy’?
- Write an equation to show the oxidation of Fe²⁺
- Write the overall balanced equation for the reaction between acidified Cr₂O₇²⁻ and Fe²⁺.
- Calculate the number of moles of Cr₂O₇²⁻ in 24.4cm³ of the dichromate solution.
- Calculate the number of moles of Fe²⁺ in 100cm³ of the original solution.
- Calculate the percentage of iron in the sample of steel (Atomic mass of Fe = 56)

11.5.5. Titrations involving sodium thiosulphate and iodine

Activity 11.5.5

In aqueous acidic solution the dichromate (VI) ion, Cr₂O₇²⁻, is a powerful oxidizing agent. The oxidation of iron(II) ions by dichromate (VI) ions may be represented by:

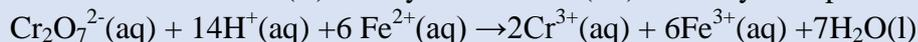

- Deduce the change in oxidation state of chromium in this reaction.
- Calculate the number of moles of Fe²⁺(aq) in 25.00cm³ of acidic aqueous iron (II) sulphate containing 12.15g/L of iron (II) sulphate, FeSO₄, (RM=152).
- Calculate the volume of aqueous potassium dichromate (VI) of concentration 0.02M that will completely oxidize the number of moles of iron in (b) (RM= 294g/mol)

Sodium thiosulphate is a white crystalline solid with the formula $\text{Na}_2\text{S}_2\text{O}_3 \cdot 5\text{H}_2\text{O}$. It is not a primary standard as the water content of the crystals is variable.

The solid acts as a reducing agent in a redox reaction and the reducing agent being the thiosulphate ion, $\text{S}_2\text{O}_3^{2-}$.

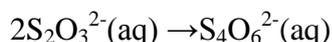

However, the thiosulphate ion is very sensitive to acid (weak or strong). In presence of an acid (hydrogen ions), it decomposes to sulphur dioxide and elemental sulphur (which settles as a yellow precipitate).

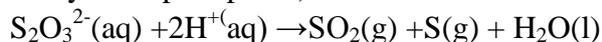

Therefore, solutions of sodium thiosulphate should never be acidified.

The thiosulphate ions reduce iodine according to the reaction below:

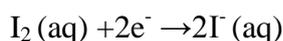

Overall equation is:

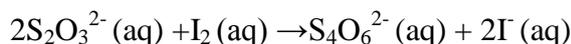

a) Detection of the end point:

In titrations involving iodine and sodium thiosulphate, starch is normally used as an indicator.

Addition of the starch produces iodine-starch complex which is **blue**. Further drop by drop addition of the thiosulphate solution is continued until the solution **turns colorless** which marks the end point of titration.

Thiosulphate titration has important applications in the laboratory and water treatment plants.

Potassium iodate (V), potassium dichromate (VI), iodine, potassium manganate (VII) solutions can be used to standardize sodium thiosulphate solutions.

For example, potassium iodate (V) reacts with iodide ions in presence of an acid to liberate iodine.

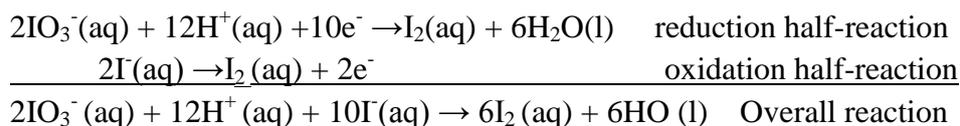

The liberated iodine is then titrated against standard sodium thiosulphate using the starch indicator.

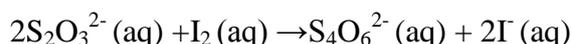

b) Preparation of starch solution:

0.5g of soluble starch powder is mixed with water into a thin smooth paste which is then poured into 300cm³ of boiling water. The mixture is then boiled after for about a minute. The solution is then cooled and used when still fresh.

But starch solution may be preserved by addition of few crystals of mercuric iodide.

Examples:

1) 1 g of solid potassium iodate V was dissolved and made up to 250 cm³ of solution. 25.0 cm³ of the resultant solution is pipetted into a conical flask containing a mixture of 10% solution potassium iodide and 10 cm³ of 2 M sulphuric acid. The solution in the flask is then titrated with sodium thiosulphate in the presence of starch indicator. This solution required 20.0 cm³ of thiosulphate solution. Calculate the concentration of the thiosulphate solution in g/dm³.

Answer:

Molar mass of KIO₃ = 214.1 g/mol

$$\text{Mass of KIO}_3 \text{ in } 1 \text{ dm}^3 = \frac{1.0 \times 1000}{250} = 4.0 \text{ g}$$

$$\text{Molarity of KIO}_3 = \frac{4.0}{214.1} = 0.0187 \text{ M}$$

$$\text{Number of moles of KIO}_3 \text{ in } 25 \text{ cm}^3 = \frac{0.0187 \times 25}{1000} = 0.0004675 \text{ mol}$$

Reactions:

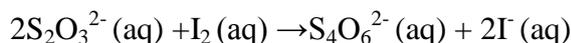

Combining the above equations with elimination of iodine (I₂) we get:

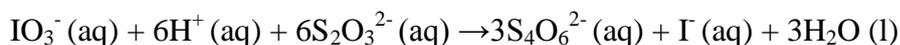

Number of moles of thiosulphate = 6 x number of moles of IO₃⁻

i.e.: 6 x 0.0004675 = 0.002805 moles

$$\text{Concentration of thiosulphate} = \frac{0.002805 \times 1000}{20.0} = 0.14025 \text{ M}$$

Molar mass of Na₂S₂O₃.5H₂O = 248 g/mole

Concentration in g.dm⁻³ = Molarity x molar mass

$$= 0.14025 \times 248$$

$$\text{i.e.: } 34.782$$

$$\text{or } 34.8 \text{ g.dm}^{-3} = 34.8 \text{ g.dm}^{-3}$$

2) A weighed sample of impure solid potassium iodate (V) of 0.80g is dissolved in water and made up to 250cm³ of solution in a volumetric flask. 25.0cm³ of this solution is reacted with excess potassium iodide solution, to liberate iodine. Find the percentage of the purity of potassium iodate (V). In the titration, 20.00cm³ of 0.1M sodium thiosulphate were needed to react with the liberated iodine.

Answer:

Write balanced equations:

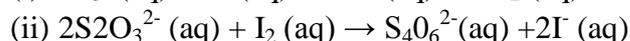

Number of moles of $\text{S}_2\text{O}_3^{2-} = 20.00\text{cm}^3 \times 0.1\text{M} = 0.002 \text{ mole}$

I_2

Molar ratio in equation (ii) $\text{S}_2\text{O}_3^{2-} : \text{I}_2 = 2 : 1$

0.002 moles of $\text{S}_2\text{O}_3^{2-}$ titrate $= \frac{0.002 \times 1}{2} = 0.001$ moles of iodine in 25cm³

Number of moles of iodine in 250cm³ $= \frac{0.001 \times 250}{25} = 0.01$ moles

In equation (i), molar ratio $\text{I}_2 : \text{IO}_3^- = 3 : 1$

3 moles of I_2 are produced from 1 mole of IO_3^-

0.01mole of I_2 is from $= \frac{0.001 \times 1}{3} = 0.00333$ moles of IO_3^-

Mass of 1 mole of $\text{KIO}_3 = 214 \text{ g}$

Mass of potassium iodate (V) in 0.00333 mole $= 0.00333\text{mole} \times 214\text{g/mole} = 0.7126\text{g}$

Percentage purity of $\text{KIO}_3 = \frac{0.7126 \times 100}{0.8} = 89.07\%$

c) Finding the percentage of copper in copper ore or in its salt

There are two possible methods depending on the copper ore (or salts).

(a) In the first method which is applicable to any copper salt, a solution of excess potassium iodide is added to a solution of the copper salt. A dark brown mixture is produced (white precipitate stained brown). The brown colour is due to iodine liberated.

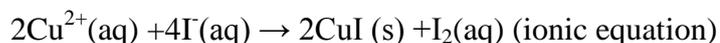

The iodine liberated in the reaction is now titrated with a standard solution of sodium thiosulphate in the second reaction according to the following equation.

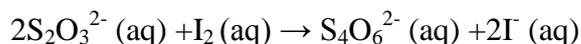

(b) The second applicable method is to liberate iodine from iodate (V) ions, then titrate it with thiosulphate ions as indicated by the following equations:

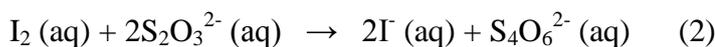
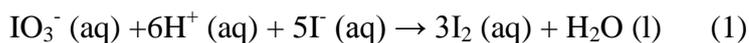

Examples:

1) An experiment was carried out in a laboratory to determine the percentage of copper in sample of impure copper metal. Nitric acid was added to a sample of impure copper metal. The resulting copper (II) nitrate was reacted with excess of potassium iodide. The iodine liberated was titrated with a solution of sodium thiosulphate of concentration 0.480M. The volume of sodium thiosulphate required was 23.7 cm³. Use the following equations in your calculations.

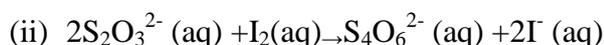

- Calculate the number of moles of thiosulphate ions in 23.7 cm³ of solution.
- Deduce the number of moles of Cu²⁺ in the copper (II) nitrate solution.
- The mass of the impure copper was 0.900g. Calculate the percentage of copper in the sample of impure copper (Cu = 63.5).
- Give the oxidation number and the electronic configuration of copper in CuI (Atomic number of Cu = 29).

Answer:

a) Number of moles of S₂O₃²⁻ = $\frac{23.7 \times 0.48}{1000} = 11.376 \times 10^{-3}$ moles

b) Number of moles of Cu²⁺

In equation (2), molar ratio between S₂O₃²⁻ : I₂ = 2:1

2 moles of S₂O₃²⁻ react with 1 mole of I₂

11.376×10^{-3} moles of S₂O₃²⁻ = $\frac{11.376 \times 0.001 \times 1}{2} = 5.688 \times 10^{-3}$ moles I₂

In equation (1), molar ratio I₂ : Cu²⁺ = 1: 2

1 mole of I₂ is produced by 2 moles of Cu²⁺

5.688×10^{-3} moles of I₂ is from $5.688 \times 10^{-3} \times 2 = 11.376 \times 10^{-3}$ moles of Cu²⁺

c) Mass of Cu²⁺ = 11.376×10^{-3} moles \times 63.5g/mole = 0.72

Percentage of Cu²⁺ = $\frac{0.72 \times 100}{0.9} = 80\%$

d) Oxidation number of copper in CuI

$$X - 1 = 0$$

$$X = +1$$

Electronic configuration of copper, in CuI is:

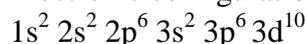

d) Determination of the percentage of available chlorine in a liquid

The method consists of measuring a fixed volume of the original liquid and then dilute it to 250cm³ with distilled water. Aliquot portions of this solution is pipetted and added to an excess of KI solution acidified with ethanoic acid.

The iodine liberated is then titrated, for example, with a standard solution of sodium thiosulphate. This is a displacement (redox) reaction in which, aqueous potassium iodide reacts with chlorine to form potassium chloride and iodine. The equation for the reaction is:

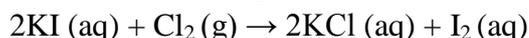

Examples:

1) Concentration of chlorine in treated water for domestic use can be monitored by testing water samples. In one such test, excess potassium iodide (KI) was added to 1000cm³ sample of water.

The liberated iodine reacted with 14.00cm³ of 0.00100M sodium thiosulphate solution.

- Calculate the number of moles of sodium thiosulphate used in the reaction and hence the number of moles of iodine liberated.
- Write an equation for the reaction between Cl₂ (aq) and I⁻ (aq) ions. Identify the reducing agent in this reaction.
- Calculate the number of moles of Cl₂ and hence the mass of chlorine molecule in the original sample of water (Cl= 35.5).
- Write an equation for the reaction between Cl₂ and water and show that this is a disproportionation reaction.
- Give the name of a suitable indicator to use in the titration of iodine solution with thiosulphate solution.

Answer:

a) Number of moles of S₂O₃²⁻ = $\frac{0.00100 \times 14.00}{1000} = 0.000014 \text{ mol}$

Number of moles of I₂:

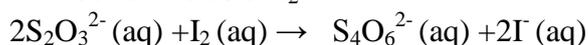

Mole ratio between S₂O₃²⁻: I₂ = 2:1

2 moles of S₂O₃²⁻ titrate 1 mole of I₂

0.000014 moles of S₂O₃²⁻ titrate $\frac{0.000014 \times 1}{2} = 0.000007 \text{ mol}$

b) Equation for the reaction between Cl₂ and I⁻ ions.

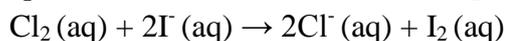

Reducing agent is I⁻ (iodide ions)

c) Equations:

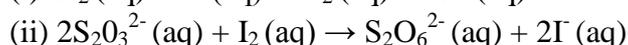
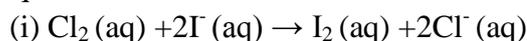

Step1: Number of moles of S₂O₃²⁻ = $\frac{0.001 \times 14}{1000} = 0.000014 \text{ mol}$

Step2: Number of moles of I₂:

Mole ratio between S₂O₃²⁻: I₂=2:1

2 moles of S₂O₃²⁻ react with 1mole of I₂

0.000014 moles of S₂O₃²⁻ react with $\frac{0.000014 \times 1}{2} = 0.000007$ moles of I₂

Step3: Number of moles of Cl₂

Mole ratio between I₂: Cl₂= 1:1

1mole of I₂ is produced by 1mole of Cl₂

0.000007 moles of I₂ is from $\frac{0.000007 \times 1}{1} = 0.000007$ moles of Cl₂

Mass of chlorine = molar mass x number of moles

=0.000007x71g= 0.00049g of Cl₂

d)

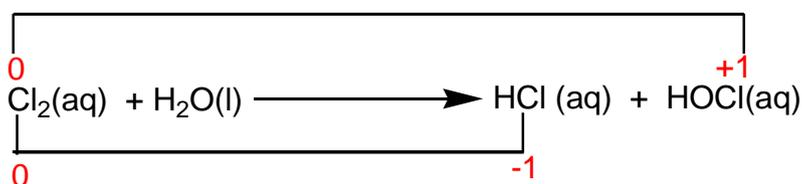

In the above reaction, chlorine underwent both oxidation and reduction, hence it is a disproportionation reaction.

(e) Starch solution, which changes colour from white to blue black.

3) Determination of the percentage of available chlorine in bleaching powder.

Procedure:

Solution FA₁ was made by weighing 2.5g of bleaching powder. This is stirred in a little water and the supernatant milk suspension poured into 250cm³ volumetric flask. The solid residue is then mixed again with little water and the fine suspension decanted into the volumetric flask.

This process is continued until most of the sample has been transferred.

The solution is then made up to 250cm³ mark.

The flask is then shaken vigorously and immediately 25 cm³ of the suspension in pipetted into a clean conical flask. 20 cm³ of 2M sulphuric acid or 2M ethanoic acid is added followed by 10 cm³ of 0.5M potassium iodide. The liberated iodine is then titrated with solution FA₂ which is 0.1M sodium thiosulphate solutions using starch indicator.

Specimen results:

Experiment number	1	2
Final burette reading in cm ³	29.03	31.94
Initial burette reading	3.43	6.30

in cm ³		
Volume of FA2 used in cm ³	25.60	25.64

$$\text{Average volume of FA2} = \frac{25.60 + 25.64}{2} = 25.62 \text{ cm}^3$$

Calculations:

- (a) Calculate the number of moles of available chlorine in 250 cm³.
 (b) Calculate the mass of the available chlorine in the sample of bleaching powder weighed.
 (c) Hence calculate the percentage of available chlorine bleaching powder.

Theory:

In the presence of H⁺, bleaching powder releases chlorine by the following equation of reaction:

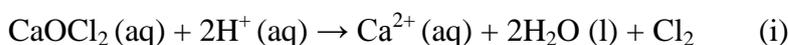

Chlorine being more electronegative than iodine, it displaces iodine from KI:



The iodine produced is then titrated with S₂O₃²⁻ and reacts following the equation:



Note: Since 1 mole of Cl₂ produces 1 mole of I₂

Number of moles of iodine is equal to the amount of chlorine set free.

Answers:

(a) 1000cm³ of FA2 contain 0.1 moles of S₂O₃²⁻

(b) 25.62cm³ of FA2 contain $\frac{0.1 \times 25.62 \text{ moles}}{1000} = 0.002562$ moles of S₂O₃²⁻

Since the mole ratio between I₂ and S₂O₃²⁻ = 1:2

Number of moles of I₂ which reacted = $\frac{1 \times 0.002562}{2} = 0.00128$ mol

Since number of mole of I₂ = number of mole of Cl₂

25cm³ of FA₁ contain 0.00128 mole of free chlorine

250cm³ of FA₁ contain = $\frac{0.00128 \times 250}{25} = 0.0128$ moles of free chlorine

250cm³ of FA₁ contain 0.0128 mole of available chlorine

(c) The mass of available chlorine = 0.0128 × 71g = 0.91g

(d) Percentage of available chlorine = $\frac{0.91 \times 100}{2.5} = 36.35\%$

Checking up 11.5.5

1) 25.0cm³ of 0.05M iodine solution required 25.5 cm³ of 0.1M sodium thiosulphate solution for complete reduction using 1% starch indicator. Determine the concentration

of iodine in:

a) mol.dm⁻³

b) g.dm⁻³

2) A solution of NaXO₃ was prepared by dissolving 1.6236 g of the salt in one litre of solution. 25.0 cm³ of this solution liberated iodine when reacted with excess iodide ions in acidic medium. The iodine liberated required 24.6 cm³ of 0.05M sodium thiosulphate solution. Determine the:

a) Molar concentration of XO₃⁻

b) Relative atomic mass of X in NaXO₃

3) 10.0 cm³ of a stock solution of hydrogen peroxide were diluted to 250 cm³ in a volumetric flask. 25.0 cm³ of this diluted solution required, after reaction with excess potassium iodide and acid, 28.0 cm³ of 0.1M sodium thiosulphate solution to reduce the liberated iodine. Determine:

a) The concentration of the stock solution of hydrogen peroxide.

b) The volume strength of hydrogen peroxide.

4) A sample of impure copper of mass 2.00 g consists of copper with small quantities of tin and zinc as impurities. You are required to find the percentage of copper in the coin. The coin was dissolved in moderately concentrated nitric acid to form a solution of copper (II) nitrate. The solution was made up to 250 cm³. A 25.0 cm³ portion was titrated and added to an excess of potassium iodide solution. Iodine was liberated according to the following equation.

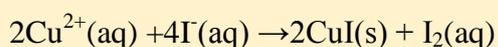

The liberated iodine required 30.0 cm³ of 0.100M sodium thiosulphate solution in a titration.

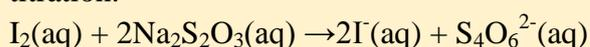

a) Which indicator could be used in the titration?

b) What amount in moles of sodium thiosulphate was used in the titration?

c) What amount in moles of iodine was titrated?

d) What mass in grams of copper was present in the coin?

e) Calculate the percentage of copper in the coin.

11.6. Back titration

Activity 11.6

Do research and explain the term back titration and discuss the applications of back titration.

This is a technique of determining the concentration of an unknown substance by calculating backwards. In this case a known amount of a titratable reagent (substance) X in excess amount is reacted with an unknown amount of substance Y to give products and at the end of the reaction, the excess of X is titrated with a standard solution of substance Z and this allows to determine the amount of Y that has reacted.

Applications of back titration:

- 1) Analysis of calcium carbonate materials (Examples: limestone, marble.....)
- 2) Determination of percentage of ammonia in an ammonium salt.
- 3) Determination of concentration of chromates and iodides in redox titration.

Examples:

- 1) A sample containing CaCO_3 was added to 200 cm^3 of 0.12 M HCl which was in excess. 25 cm^3 of the resultant solution require 20 cm^3 0.05 M KOH for the complete neutralisation. What is the mass of CaCO_3 in the sample?

Answer:

Step 1: Write balanced equations

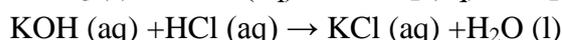

Step 2: Calculate initial number of moles of HCl

$$= 200 \times 10^{-3} \text{ dm}^3 \times 0.12 \text{ mol dm}^{-3} = 0.024 \text{ mol}$$

Step 3: Calculate number of HCl in excess solution

$$\text{Number of moles of KOH} = 20 \times 10^{-3} \times 0.05 = 0.001 \text{ mol}$$

Molar ratio for KOH: HCl = 1:1

As molar ratio is 1:1 we have 0.001 moles HCl excess in 25 cm^3 of the resultant solutions.

$$\text{Number of moles of HCl in } 200 \text{ cm}^3 = \frac{200 \times 0.001}{25} = 0.008 \text{ mol}$$

Step 4: Moles of HCl which reacts = $0.024 - 0.008 = 0.016 \text{ mol}$

$$\text{Initial moles of reactants} = 0.024 \text{ mol}$$

$$\text{Number of moles in excess} = 0.008 \text{ mol}$$

Step 5: Number of moles of HCl which react with $\text{CaCO}_3 = 0.016 \text{ mol}$

Molar ratio for HCl: $\text{CaCO}_3 = 2:1$

$$\text{Number of moles of } \text{CaCO}_3 = \frac{0.016 \times 1}{2} = 0.008 \text{ moles of } \text{CaCO}_3$$

$$\text{Number of mole} = \frac{\text{mass}}{\text{relative molecular mass}}$$

So, mass = relative molecular mass x number of moles

$$\text{Relative molecular mass of } \text{CaCO}_3 = 40 + 12 + 48 = 100 \text{ g/mol}$$

$$\text{Mass of } \text{CaCO}_3 = 0.008 \times 100 \text{ g} = 0.8 \text{ g}$$

- 2) 50cm³ of 0.45M hydrochloric acid solution were added to 25.0cm³ of sodium hydroxide solution and the resultant solution on titration required 23.0cm³ of 0.2M sodium hydroxide solution for complete reaction. Calculate the:
- Number of moles of hydrochloric acid that reacted with original sodium hydroxide solution.
 - Molarity of the original sodium hydroxide solution.

Answer:

- a) Equation of reaction between HCl and NaOH:

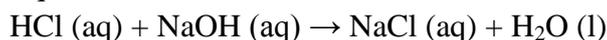

1000cm³ of NaOH solution contain 0.2mol

23.0cm³ of NaOH solution will contain = $\frac{0.2 \times 23}{1000}$ mol = 0.0046mol

Number of moles of NaOH used = 0.0046mol

From equation, 1mole of NaOH reacts with 1mole of HCl

Number of excess moles of HCl = 0.0046mol

Total number of moles of HCl:

1000cm³ of original HCl contain 0.45mol

50cm³ of original HCl solution contain = $\frac{0.45 \times 50}{1000}$ mol = 0.0225mol

Total number of moles of HCl = 0.0225mol

Thus; Number of moles of HCl that reacted with original NaOH

$$= 0.0225\text{mol} - 0.0046\text{mol} = 0.0179\text{mol}$$

- b) Initially, HCl reacts with original NaOH as:

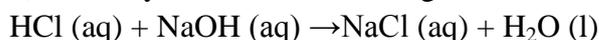

Since, 1mole of HCl reacts with 1mole of original NaOH;

. Number of moles of NaOH in original solution = 0.0179mol

But, 25.0cm³ of original solution of NaOH contain 0.0179mol

1000cm³ of original solution of NaOH will contain = $\frac{0.0179 \times 1000}{25}$ = 0.716M

Molarity of original NaOH = 0.716mol dm⁻³

- 3) 5.88g of impure ammonium chloride were placed in a conical flask and 150cm³ of 1M sodium hydroxide solution were added. The mixture was boiled until all the ammonia was expelled (tested using red litmus). The resultant solution was transferred into a 250cm³ volumetric flask and the solution made to the mark with distilled water. 25.0cm³ of this solution required 23.9cm³ of 0.2M hydrochloric acid for complete neutralisation. Calculate the:
- Number of moles of NaOH that reacted with HCl.
 - Number of moles of NaOH that reacted with NH₄Cl.
 - Percentage of the impurity in the salt.
 - Percentage of NH₃ in the salt.

Answer:

a) Equation:

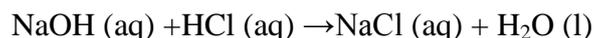

1000cm³ of HCl contain 0.2mol

$$23.90\text{cm}^3 \text{ of HCl will contain } = \frac{0.2 \times 23.90}{1000} \text{ mol} = 0.00478\text{mol}$$

. Number of moles of HCl used = 0.00478mol

From the equation above, 1mole of NaOH reacts with 1mole of HCl

. Number of moles of NaOH that reacted with HCl = 0.00478mol

b) 25cm³ of the resultant solution contain 0.00478mole of NaOH

$$250\text{cm}^3 \text{ of the resultant solution will contain } = \frac{0.00478 \times 250}{25} = 0.0478\text{mol}$$

. Number of moles of NaOH in 250cm³ of solution = 0.0478mol

Calculate the total number of moles of NaOH:

1000cm³ of original solution of NaOH contain 1mol

$$150\text{cm}^3 \text{ of original solution of NaOH will contain } \frac{1 \times 150}{1000} = 0.15\text{mol NaOH}$$

So, the total number of moles of NaOH = 0.15mol

. Number of moles of NaOH that reacted with NH₄Cl

$$= 0.15\text{mol} - 0.00478\text{mol} = 0.1022\text{mol}$$

c) NaOH reacts with NH₄Cl as shown below:



(1mol) (1mol) (1mol)

From the reaction above, 1mole of NaOH reacts with 1mole of NH₄Cl

Hence, number of moles of NH₄Cl used = 0.1022mol

But the molar mass (Mr) of NH₄Cl = 14+ 4+ 35.5= 53.5

Thus, 1mole of NH₄Cl weighs 53.5g

0.1022mol of NH₄Cl weighs = 53.5g x 0.1022 = 5.49g

. Mass of pure NH₄Cl = 5.49g

Mass of impurity = (5.88 – 5.49)g = 0.39g

$$\text{Percentage of impurity} = \frac{0.39 \times 100}{5.88} = 6.6\%$$

d) From the reaction in (c) above

1mole of NaOH expels 1mole of NH₃ i.e. ratio of NaOH: NH₃=1:1

Hence, moles of ammonia expelled = 0.1022mol

Mr of NH₃ = 14+3= 17g i.e. 1mole of Ammonia weighs 17g

0.1022moles of NH₃ will weigh = 17g x 0.1022= 1.737g

Mass of NH₃ in the salt = 1.737g

$$\text{Percentage of NH}_3 = \frac{1.737 \times 100}{5.88} = 29.5\%$$

Checking up 11.6

1) 0.78g of metallic oxide was dissolved in 50cm³ of 1M hydrochloric acid. The resultant solution was transferred to a 250cm³ volumetric flask and made up to the mark

with distilled water. 25cm^3 of this solution on titration required 22.1cm^3 of 0.1M sodium hydroxide solution for complete neutralization. Calculate the:

- Number of moles of HCl that reacted with NaOH .
- Number of moles of HCl that reacted with the oxide.
- Relative atomic mass of the metal in the oxide.
($\text{O} = 16$, The metal is divalent).

2) A student was asked to determine the mass, in grams, of calcium carbonate present in a 0.125 g sample of chalk.

The student placed the chalk sample in a 250 mL conical flask and added 50.00 mL of 0.200 mol L^{-1} HCl using a pipette.

The excess HCl was then titrated with 0.250 mol L^{-1} NaOH .

The average NaOH titre was 32.12 mL

Calculate the mass of calcium carbonate, in grams, present in the chalk sample.

11.7. Applications of titration

11.7.1. Determination of the number of moles of water of crystallization

Activity 11.7.1

Do research and explain the term water of crystallization

Water of crystallization is defined as that definite amount of water which a substance associate with on crystallizing out of an aqueous solution. Many crystals cannot form without the presence of water i.e. water of hydration.

Examples of some hydrated substances

$\text{BaCl}_2 \cdot 2\text{H}_2\text{O}$: Barium chloride

$\text{CuSO}_4 \cdot 5\text{H}_2\text{O}$: Copper (II) sulphate

$\text{Na}_2\text{CO}_3 \cdot 10\text{H}_2\text{O}$: Sodium carbonate

$\text{Na}_2\text{S}_2\text{O}_3 \cdot 5\text{H}_2\text{O}$: Sodium thiosulphate

Water of crystallization can be determined by using two different methods.

a) Weighing method

This method is preferably used when the crystals are neutral, and they cannot react with acid or basic solution.

Procedure:

(For example, $\text{CuSO}_4 \cdot x\text{H}_2\text{O}$)

- Weigh the mass of a clean dry crucible with lid.

- Two or three grams of hydrated $\text{CuSO}_4 \cdot x\text{H}_2\text{O}$ are added and the whole set up is weighed.
- The crucible, lid and the content are heated on a pipe-clay triangle on a tripod stand, gently at first and later strongly, to drive off water of crystallization.
- The set up is allowed to cool in a desiccator (to exclude moisture) and reweighed.
- Heat again the crucible, lid and content and then cool as before and weigh again.
- Repeat the process of heating, cooling and reweighing until a constant mass is reached which shows that all water has been expelled.
- Using calculations, it is possible to get x moles of water of crystallization found in one mole of substance. See the following example:

Example:

4.99g of hydrated copper (II) sulphate, $\text{CuSO}_4 \cdot x\text{H}_2\text{O}$ was strongly heated until all water of crystallization was eliminated. The mass of anhydrous copper sulphate was found to be 3.19g. Calculate the number of moles of water of crystallization contained in one mole of $\text{CuSO}_4 \cdot x\text{H}_2\text{O}$ (Cu = 63.5, S = 32, O = 16, H = 1)

Answer:

$$\text{Mass of water} = 4.99\text{g} - 3.19\text{g} = 1.8\text{g}$$

$$\text{Mr for CuSO}_4 = 63.5 + 32 + 64 = 159.5$$

$$\text{Number of moles of anhydrous CuSO}_4 = \frac{3.19}{159.5} = 0.02 \text{ mol}$$

$$\text{Number of moles of water} = \frac{1.8}{18} = 0.1 \text{ mol}$$

Number of moles of water of crystallization

$$= \frac{0.1}{0.02} = 5$$

So, we may write: $\text{CuSO}_4 \cdot 5\text{H}_2\text{O}$.

b) Using titration

Titration is used for crystals substance which are either basic or acidic for example $\text{H}_2\text{C}_2\text{O}_4 \cdot x\text{H}_2\text{O}$, $\text{Na}_2\text{CO}_3 \cdot x\text{H}_2\text{O}$. This method obeys all the titration principles used in acid-base titration.

Example:

5.0 g hydrated compound $\text{P} \cdot n\text{H}_2\text{O}$ are dissolved and made up to 250 cm^3 of solution. A 25.0 cm^3 of the solution requires 26.0 cm^3 of 0.1 mol dm^{-3} hydrochloric acid for complete neutralization. (One mole of the compound reacts completely with two moles of hydrochloric acid; P = 201.2)

Calculate the value of n.

Answer

$$\text{Moles of hydrochloric acid that reacted} = \frac{0.1 \times 26.0}{1000} = 0.0026 \text{ mol}$$

$$\text{Moles of P} \cdot n\text{H}_2\text{O} \text{ that reacted} = \frac{1}{2} \times 0.0026 = 0.0013 \text{ mol}$$

25.0 cm^3 of solution contain 0.0013 moles of the compound

$$1000 \text{ cm}^3 \text{ of solution contain} = \frac{0.0013 \times 1000}{25.0} = 0.052 \text{ M}$$

$$\text{Mass of P.nH}_2\text{O in } 1000 \text{ cm}^3 = \frac{5.0 \times 1000}{250} = 20 \text{ g}$$

$$\begin{aligned} \text{Molar mass of P.nH}_2\text{O} &= \frac{\text{concentration in g/l}}{\text{concentration in mol/l}} \\ &= \frac{20}{0.052} = 384.6 \text{ g/mol} \end{aligned}$$

Now $\text{P.nH}_2\text{O} = 384.6$ or

$$201.2 + 18n = 384.6$$

$$18n = 384.6 - 201.2$$

$$18n = 183.4$$

$$n = 10$$

Checking up 11.7.1

Barium chloride crystallizes from water to form a hydrate with the formula $\text{BaCl}_2 \cdot x \text{H}_2\text{O}$. On heating, the hydrate loses water to form anhydrous barium chloride. A solution of barium chloride is colorless.

- Barium chloride solution reacts with aqueous silver nitrate to form silver chloride. Write the equation for the reaction showing physical states.
- 3.05g of $\text{BaCl}_2 \cdot x \text{H}_2\text{O}$ were dissolved in water to make 250 cm^3 of solution in a graduated flask. 20 cm^3 of this solution were titrated with 0.1M silver nitrate solution. It was found that 20.0 cm^3 were required.
 - Calculate the value of x in $\text{BaCl}_2 \cdot x \text{H}_2\text{O}$.
 - Write the equation for the reaction of heat on hydrated barium chloride.
(Ar: Ba =137, Cl=35.5).

11.7.2. Determination of atomic masses

Activity 11.7.2

4.99g of hydrated copper (II) sulphate, $\text{CuSO}_4 \cdot x \text{H}_2\text{O}$ was strongly heated until all water of crystallization was eliminated. The mass of anhydrous copper sulphate was found to be 3.19g. Determine the number of moles of water of crystallization(x).

It is possible to find the atomic mass of the metal atom in titrating a basic compound which reacts with acidic solution.

Example:

1.0 g of metal hydroxide X (OH)₂ was dissolved and made up to 250 cm³ of solution. A 25.0 cm³ of the solution required 27.0 cm³ of 0.1 mol dm⁻³ hydrochloric acid for complete neutralization using methyl orange indicator. Calculate the value of m_x the relative atomic mass of X and suggest the formula of that metal hydroxide

Answer:

Number of moles of HCl that reacted = $\frac{27 \times 0.1}{1000} = 0.0027 \text{ mol}$

Reaction ratio is X (OH)₂ : HCl = 1 : 2

Number of moles of metal hydroxide in 25 cm³ = $\frac{1}{2} \times 0.0027 = 0.00135 \text{ mol}$

Number of moles of metal hydroxide in 1000 cm³ = $\frac{1.35 \times 1000}{25 \times 1000} = 0.054 \text{ M}$

Mass of metal hydroxide in 1000 cm³ = $\frac{1.0 \times 1000}{250} = 4.0 \text{ g}$

Molar mass of metal hydroxide = $\frac{4.0}{0.054} = 74.1 \text{ g/mol}$

The molar mass of X(OH)₂ = 74.1 or

$$m_x + 34 = 74.1$$

$$m_x = 40.1$$

The relative molecular mass value of X is 40.1, so X is Ca and the formula of the hydroxide is Ca (OH)₂.

Checking up 11.7.2

1. Sodium carbonate crystals 27.8230 g were dissolved in water and made up to 1dm³. 25.00cm³ of the solution was neutralized by 48.8 cm³ of hydrochloric acid of concentration 0.10M. Find x in the formula NaCO₃.x H₂O.
2. 8g of a group I hydroxide was neutralized by 100 cm³ of 2M HCl. Which hydroxide was used in the titration?

11.8. END UNIT ASSESSMENT

- 1) Explain the following terms:
 - a) Standard solution
 - b) Primary standard.
- 2) Describe the characteristics of a primary standard.
- 3) A solution is made by dissolving 5.00g of impure sodium hydroxide in water and making it up to 1dm³ of solution. 25cm³ of this solution are neutralized by 30.0cm³ of hydrochloric acid of concentration 0.102M. Calculate the percentage purity of the sodium hydroxide.
- 4) You are provided with a white powder containing a mixture of sodium carbonate and magnesium nitrate and 1M nitric acid.

Make a solution using 10g of the powder and 47.3cm³ of water. You need 0.05dm³ of the acid to fully react with the solution. What is the percentage composition of magnesium nitrate in the powder?
- 5) 13.0g of an impure sample of iron (Fe) is completely dissolved in sulphuric acid. The distilled water is added to form 1dm³ of the solution; this solution contains Fe²⁺ ions. 20.0cm³ of the solution is completely oxidized by 45.0cm³ of 0.02M KMnO₄ solution.
 - (a) Explain the double role of sulphuric acid in the above procedure of analysis.
 - (b) Potassium manganate (VII) is a powerful oxidizing agent. Explain the advantages and disadvantages of potassium manganate (VII) in the titration.
 - (c) Give the name of the indicator that you can use.
 - (d) Write the equation of the reaction that occurs.
 - (e) Calculate the percentage of pure iron in the sample.
(Ar of Fe = 56)
- 6) To determine the value of x, y, z, and n in the oxalate K_xH_y(C₂O₄)_z.nH₂O.

Procedure: Solution FA₁ is 8.0g of the oxalate K_xH_y(C₂O₄)_z.nH₂O in 1dm³ of solution. Solution FA₂ is 0.1M of sodium hydroxide. FA₃ is a solution of KMnO₄ 0.02M. 25cm³ of FA₁ is pipetted in a clean conical flask, 2 or 3 drops of phenolphthalein indicator is added and then the solution titrated with 23.8cm³ of FA₂. The burette is then rinsed and filled with FA₃. 25cm³ of FA₁ is pipetted and is added to 25cm³ of 2M H₂SO₄. This solution is then heated to about 70°C, the resultant is then titrated with 31.75cm³ of FA₃ while hot.

 - (a) Calculate the value of x in the formula
 - (b) Calculate the value of y in the formula
 - (c) Calculate the value of z in the formula
 - (d) Calculate the molecular mass of the oxalate
 - (e) Calculate the number of water of crystallization n.

7) Determination of the volume strength of a given solution of hydrogen peroxide.

Procedure: Solution **FA**₁ contains 2.41 g of potassium manganite (VII)

Per litre. Solution **FA**₂ is a solution of hydrogen peroxide made by diluting 10.0cm³ of the original H₂O₂ (20 volumes of H₂O₂ to 250 cm³).

10.0cm³ of **FA**₂ are pipetted in a clean conical flask, then 20.0cm³ of 1M H₂SO₄ is added and the mixture is titrated with **FA**₁. 17.5cm³ of **FA**₁ was used to get persistent purple color. Calculate:

- The molarity of **FA**₁
- The original molarity of H₂O₂ in **FA**₂
- The concentration in g/L of original H₂O₂
- Hence, calculate the volume strength of H₂O₂ solution.

8) (a) In volumetric estimation of reducing agents, potassium dichromate (VI) is preferred to potassium permanganate (KMnO₄) as an oxidizing agent.

Explain why?

(b) 3.8 g of solder containing tin, was dissolved in excess HCl acid, the solution was made up to 250 cm³. 25cm³ of this solution required 23.5cm³ of 0.01M of potassium dichromate (VI) solution for complete reaction.

- Write the half equation for the potassium dichromate acting as an oxidizing agent in acid medium.
- Calculate the number of moles of potassium dichromate used.
- Calculate the number of moles of tin (Sn) in 250 cm³ of solution.
- Determine the percentage by mass of tin in the solder.
(Atomic mass of tin = 119)

9) 20.0cm³ of sample of household bleach was diluted to 250 cm³. 25.0cm³ portion of the diluted solution was then added to an excess of potassium iodide solution in the presence of ethanoic acid.

The iodine produced required 14.8 cm³ of 0.2M of sodium thiosulphate solution.

- Calculate the concentration in mol.dm⁻³ of the original bleach solution.
- Calculate the concentration in g.dm⁻³ of sodium chlorate in the bleach.
- Calculate the percentage of available chlorine in the bleach.

10) Practical: Determination of atomic mass in a compound.

You are provided with the following:

BA which is a solution of MCO₃ Prepared by dissolving 0.5g of MCO₃ in 25 cm³ of 1M hydrochloric acid solution. (M is a divalent metal).

1M sodium hydroxide (NaOH) solution

Procedure:

- Pipette 25 cm³ of **BA** into a conical flask and add 2 drops of phenolphthalein indicator.
- Titrate the resultant solution by 1M sodium hydroxide from a burette.
- Record your results in the table below:

Volume of the pipette used:

Final burette readings in cm ³	1	2	3
Initial burette readings in cm ³			
Volume of NaOH in cm ³			

Average volume of 1M NaOH used =

- Calculate the total number of moles of HCl used to prepare **BA** solution
- Give the equation of the reaction between MCO₃ and HCl and show the physical states of the reactants and the products.
- Calculate the number of moles of 1M NaOH that reacted with excess HCl.
- Give the equation of the reaction between NaOH and HCl and show the physical states of the reactants and the products.
- Give the mole ratio of NaOH: HCl.
- Therefore, calculate the number of moles of the excess of HCl.
- Calculate the number of moles of HCl that reacted with MCO₃
- Determine the mole ratio of MCO₃: HCl.
- Calculate the number of moles of MCO₃ that reacted with hydrogen chloride acid.
- The molar mass = $\frac{\text{mass in g}}{\text{number of moles}}$

Therefore, calculate the molar mass of MCO₃.

- Calculate the atomic mass (Ar) of M.

11) Practical: Determination of the number of moles of water of crystallization by titration.

Procedure:

- Dissolve 6.3 g H₂C₂O₄.xH₂O (oxalic acid or ethane dioic acid) to make 1.0 litter of solution and prepare 0.1 M of solution of sodium hydroxide.
- Pipette 25 cm³ of H₂C₂O₄.xH₂O into a conical flask and add two drops of phenolphthalein indicator.
- Titrate with 0.1 M NaOH from burette
- Record your results in the table below:

Number of experiment	1	2	3
Final burette readings in cm³			

Initial readings in cm³			
Volume of 0.1 M NaOH used			

Average volume of NaOH used =

To determine the number of moles of water of crystallization in $\text{H}_2\text{C}_2\text{O}_4 \cdot x\text{H}_2\text{O}$

a) Write the chemical equation of reaction taking place.

b) Calculate the number of moles of NaOH that reacted

c) Mole ratio of $\text{H}_2\text{C}_2\text{O}_4$: NaOH = :

d) Calculate the number of moles of $\text{H}_2\text{C}_2\text{O}_4$ that reacted

e) Molarity of $\text{H}_2\text{C}_2\text{O}_4$ =

f) Relative molecular mass of $\text{H}_2\text{C}_2\text{O}_4 \cdot x\text{H}_2\text{O}$ =

$$\text{Molarity} = \frac{\text{concentration in g/l}}{\text{relative molecular mass}}$$

g) Calculate the number of moles of water of crystallization in one mole of $\text{H}_2\text{C}_2\text{O}_4 \cdot x\text{H}_2\text{O}$.

12) 5.35g of an ammonium salt NH_4X (where X is an acid radical) were dissolved in water and then made up to 1dm^3 . 25.0cm^3 of this solution were boiled with 50cm^3 of 0.1M sodium hydroxide solution until no more ammonia was evolved. It was found that the excess sodium hydroxide required 25.0cm^3 of 0.1M hydrochloric acid for neutralization. Calculate:

a) The number of moles of NaOH that reacted with NH_4X .

b) The number of moles of NH_3 produced during the reaction between NH_4X and NaOH.

13) 3.40g of an impure sample of barium hydroxide was reacted with 100cm^3 of 0.4M hydrochloric acid. All the barium hydroxide reacted and the excess acid required 10.90cm^3 of 0.2M sodium hydroxide solution for neutralization. Calculate the percentage purity of the sample of barium hydroxide. (Ar for Ba =137, O =16, H=1)

UNIT 12: CONDUCTIVITY OF SOLUTIONS

Key unity competence: To be able to: Explain the effect of different factors on the molar conductivity of different electrolytes and the applications of conductivity measurements.

Learning objectives:

- *Explain the conductivity of solutions.*
- *State and explain the factors that affect molar conductivity of solutions.*
- *State Kohlrausch's law of individual molar conductivity.*
- *Use Kohlrausch's law to calculate the molar conductivity of an electrolyte.*
- *Interpret a graph of molar conductivity against concentration for both weak and strong electrolytes.*
- *Compare and contrast metallic conductivity and electrolytic conductivity.*
- *Develop a team approach and responsibility in performing experiments.*
- *Appreciate the contributions of other scientists like Kohlrausch's law in calculation of molar conductivity of solutions.*
- *Respect the procedure in performing experiment.*

12.1. Conductance of electrolytic solutions

Introductory activity

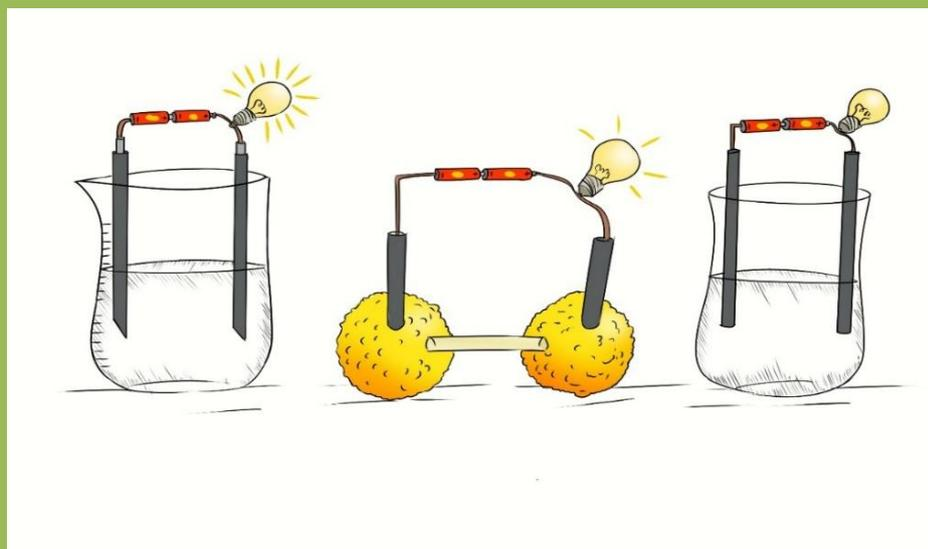

The above set up is made by

1. Solution of sodium hydroxide
2. Oranges containing citric acid
3. Solution of sugar

Carry out the three experiments as illustrated on the picture and answer to the related questions

1. Compare the intensities of lights in set up 1,2 and 3
2. Why there is no light in set up three
3. What do you think are the main cause of bulbs light in set up 2
4. Why the light in the setup 1 and 2 are different?

Activity 12.1:

You have certainly heard about people being accidentally electrocuted when bathing at home; can you explain?

The conductance of material or solution is the property of materials due to which a material allows the flow of ions or electrons through itself and thus conducts electricity. It is generally defined as the **reciprocal of resistance** of that material.

SI unit of conductance is Ω^{-1} or S (Siemens), named after the 19th century German engineer and industrialist **Ernst Werner von Siemens**. It used to be called the **mho**, which is just **ohm** written backwards because the resistance is expressed in Ω (**Ohm**). The symbol for conductance is L or G. Thus $G = 1/R$. $R = V/I$ so conductance is just the inverse of R: $G = I/V$.

Meaning that $G = \frac{1}{R} = \frac{I}{V}$ where R= Resistance (Ω , **Ohm**), I= Current Intensity (**A**, **Amperes**) and V=Voltage (**V**, **Volts**)

The conductance of a material depends on the nature of material, number of valence electrons for a material and temperature. Metals are good conductors of electricity due to number and the mobility of their valence electrons. We observe that the conductance of materials decreases with increase in temperature.

Water in its pure state is known to be nonconductor because there are very little ions (H^+ and OH^-). The presence of electrolytes further enhances the conductivity as they supply their ions to the solution. The conductance of electricity by ions present in the solutions is called **electrolytic or ionic conductance**.

The conductance is the inverse of resistance, therefore it is determined by calculating the resistance of the electrolytic solution or using the conductance cell (Figure 12.1)

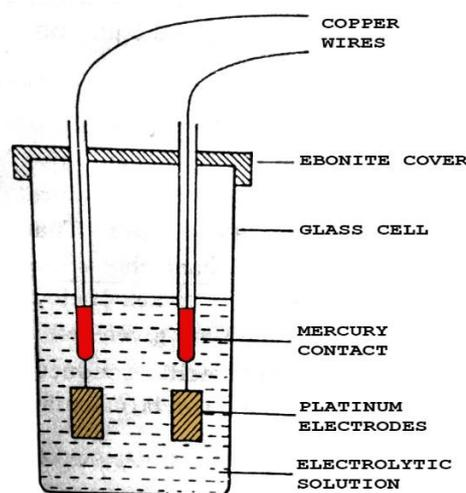

Figure 12.1. Conductance cell,

Source B.S, Bahl essentials of physical chemistry, page 476

Equivalent conductance is again called conductivity (Λ) which is the ability of a solution to conduct electric charges, it is measured in $S\text{m}^2\text{mol}^{-1} = \text{ohm}^{-1}\text{mol}^{-1}$ (Table 12.1)

Table 12.1: Electrochemical properties, their symbols and units

Property	Symbol	Unit
----------	--------	------

Resistance	R	Ohm Ω
Resistivity or specific resistance	ρ	OhmCm or Ωcm
Conductance	G or 1/R	Ω^{-1} or Siemens
Specific conductance	κ (kappa)	$\text{Ohm}^{-1}\text{Cm}^{-1}$
Equivalent conductance /conductivity	Λ	$\text{Ohm}^{-1}\text{Cm}^2\text{mol}^{-1}$ $\text{Sm}^2\text{mol}^{-1}$, where S is Siemens = ohm^{-1}

Source: B.S B AHL(2000),*essentials of physical chemistry*, Page 697

Checking up 12.1

- Define conductivity
- What is the difference between conductance and resistance?

Conductivity: Definition and description

Conductivity of a substance is defined as 'the ability or power to conduct or transmit heat, electricity, or sound'. Its units are Siemens per meter [S/m] in SI and milliohms per centimeter [m mho/cm] in U.S. customary units.

12.2. Measurement of conductivity of solutions

Activity 12.2

- Refer to daily activity usage in electricity domain what are the objects used to measure the voltage?
- Refer to introductory activity above, how will you know that a solution is conducting or not?

The conductivity is the reciprocal of the resistance (1/R) and is measured in Siemens or mhos. Conductivity measurements are used routinely in many industrial and environmental applications as a fast, inexpensive and reliable way of measuring the ionic content in a solution. For example, the measurement of conductivity is a typical way to monitor and continuously trend the performance of water purification systems.

Electrical conductivity meter

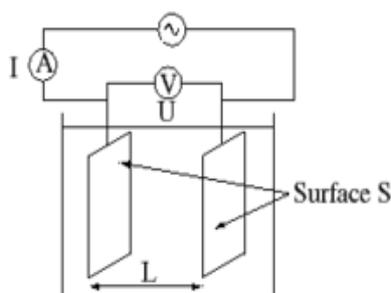

Principle of the measurement

The electrical conductivity of a solution of an electrolyte is measured by determining the resistance of the solution between two flat or cylindrical electrodes separated by a fixed distance. An alternating voltage is used in order to avoid electrolysis. The resistance is measured by a conductivity meter. Typical frequencies used are in the range 1–3kHz. The dependence on the frequency is usually small, but may become appreciable at very high frequencies.

A wide variety of instrumentation is commercially available. There are two types of cell, the classical type with flat or cylindrical electrodes and a second type based on induction. Many commercial systems offer automatic temperature correction. Tables of reference conductivities are available for many common solutions.

The conductivity of an electrolyte is the conductance of a volume of solution containing one mole of dissolved electrolyte placed between two parallel electrodes 1dm apart and large enough to contain between them all the solution; the conductivity is affected by temperature.

Checking up 12.2

Describe the functioning of conductivity meter and derive the formula of calculation of conductivity

12.3. Specific conductivity of solutions

Activity 12.3:

1. Define resistivity
2. Establish a relation between conductivity and resistivity and among the following substances, which ones are conductors and non-conductors, for each you have to explain why they are or not conductors: pure water, sugar, iron plate, clothes, plastic bags, ammonia solution, salt solution, etc...

Specific Conductivity (better known as specific conductance) is the measure of the ability of that material to conduct electricity. It is represented by the symbol “**K**”. Hence, by definition, the specific conductance (specific conductivity), κ (kappa) is the reciprocal of the specific resistance. The SI unit of conductivity is **Siemens per meter (S/m)**.

Conductivity $\kappa = \frac{1}{\rho} = \frac{\ell}{A} \times \frac{1}{R}$ thus Conductance $G = \frac{1}{R} = \frac{1}{\rho} \times \frac{A}{\ell}$,

Where $\frac{1}{\rho}$ is the electrical conductivity or specific conductance.

ρ = Specific resistance or resistivity

ℓ = length

A = area of the cross section of the plaque

The conductivity of an electrolyte (Λ) indicates how well an electrolyte conducts electricity.

The quantity $\frac{\ell}{A}$ is called **cell constant** and is expressed in cm^{-1}

The cell constant is calculate using the following expression:

$$\text{Cell constant, } x = \frac{\text{specific conductance}}{\text{observed conductance}}$$

Specific conductivity or **conductivity** of an electrolytic solution at any given concentration is **the conductance of one unit volume of solution kept between two platinum electrodes with the unit area of cross section and at a distance of unit length.**

What is the difference between Conductance and Conductivity?

- Conductance depends on the dimensions of the conductor, but conductivity does not depend on the dimensions.
- Conductance is measured in Siemens while conductivity is measured in Siemens per meter

Checking up 12.3

1. The specific conductance of solution, of KCl at 25⁰C, is 0.002765mho. If the resistance of the cell containing this solution is 400ohms what is the cell constant
2. The resistance of decinormal solution of a salt occupying a volume between two platinum electrodes 1.80cm apart and 5.4cm² in area was found to be 32ohms. Calculate the equivalence conductance of the solution
3. A conductance cell on being filled with 0.02molar solution of KCl at 25⁰C showed a resistance of 165ohms. The specific conductance of KCl solution used is 2.77x10⁻³ mho cm⁻¹. The same cell containing 0.01molar NaCl solution gave an electrical resistance of 384ohms calculate the specific and equivalent conductance of NaCl solution

12.4. Molar conductivity of solutions

Activity 12.4:

Refer to experiment done in the activity one (introductory activity) repeat the same experiment at different concentration 1M of NaCl and 2M of NaCl, explain how the intensity of light change with concentration

The molar conductivity of a solution at any given concentration is the conductance of the volume of solution containing one mole of electrolyte kept between two electrodes with the unit area of cross section and distance of unit length. In general terms, it is defined as the **ratio of specific conductivity and the concentration** of the electrolyte.

The symbol Λ_m denotes it. $\Lambda_m = K/c$

Where, K = specific conductivity

c = molar concentration of electrolyte

Molar conductivity of electrolytes increases with dilution. Friedrich Kohlrausch, in 1900, experimentally found that: $\Lambda = \Lambda_\infty - b\sqrt{c}$; where Λ and Λ_∞ are the molar conductivity at a given concentration and at infinite dilution respectively, b is a constant depending on the viscosity of the solvent and c is the concentration.

Example:

Table 12.1: Variation of conductivity in terms of concentration at different temperatures

Concentration in M	Conductivity, 273K	Conductivity, 291K	Conductivity, 298K
1.0	6.5117	9.7840	11.1900
0.1	0.7140	1.1166	1.2890
0.01	0.0774	0.1221	0.1413

This table shows that the conductivity increases with increasing concentration and temperature.

12.4.1. Strong electrolytes

For strong electrolyte, molar conductivity increases steadily with dilution until it reaches the maximum value at infinite dilution (at high concentration, the lower conductivity values are due to ionic interference. The formation of ionic pairs or triplet and symmetrical spheres greatly reduces the mobility of ions however as the dilution increases, there is reduced ionic interference as result of many solvent molecules surrounding the oppositely charged ions thus an increase in molar conductivity

At infinite, there is independent migration of ions that is ions experience negligible ionic interference and move independent of each other.

The molar conductivities of **strong electrolytes are high**. This is because, by nature, strong electrolytes are highly dissociated when molten or when in solution into large number of ions. These ions are mobile, hence they migrate to the electrodes, resulting in the high

conduction of electricity: *the higher the number of ions are free in solution, the higher the conductivity.*

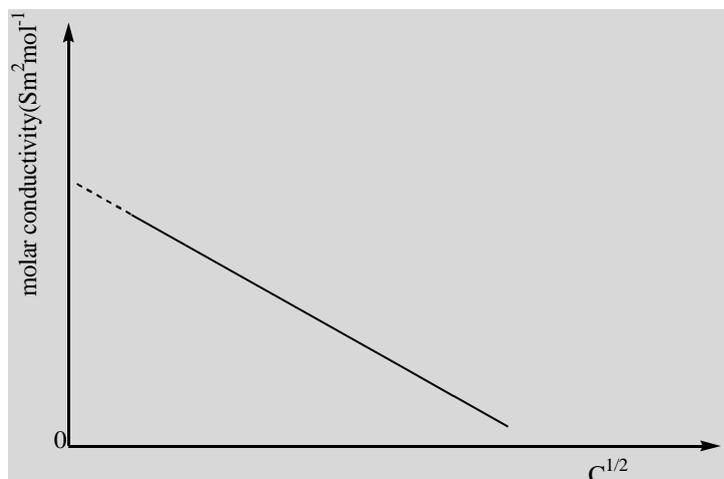

This graph can be obtained by **extrapolation of the graph to zero concentration.**

12.4.2. Weak electrolytes

Weak electrolytes show partial dissociation in solution, producing few ions, which results in low conduction of electricity.

A weak electrolyte dissociates to a much lesser extent so its conductance is lower than that of a strong electrolyte at the same concentration.

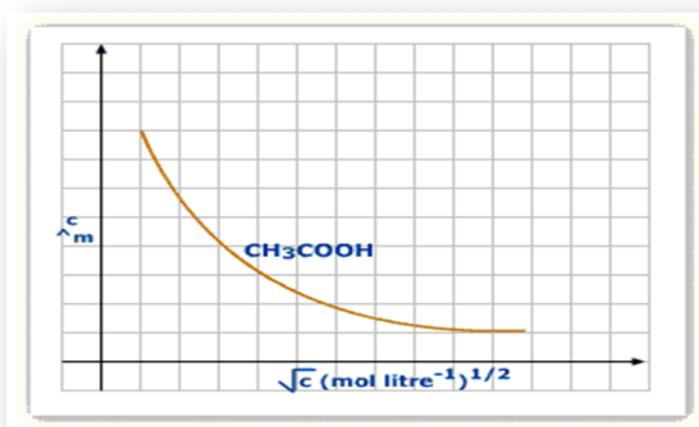

The very large increase at infinite dilution is because the ionization increases and so the number of ions in solution increases. The *value of Λ and Λ_{∞} cannot be obtained by extrapolation as can be seen on the graph.* It is obtained by applying Kohlrausch's law (see later)

Summary:

- The higher the number of ions per unit volume in solution, the greater the conductivity of the electrolytic solution. This means that the conductivity increases with concentration of ions in solution up to an optimum level over which it starts decreasing.
- On the other hand when the conductivity has decreased due to very high concentration of ions, it can be increased with dilution (i.e. lower concentrations) up to its optimum, beyond which further dilution will decrease conductivity.
- The decrease or increase of conductivity by concentrating or diluting the solution is sharp in strong electrolytes while it is gradual in weak electrolytes. The following graph shows

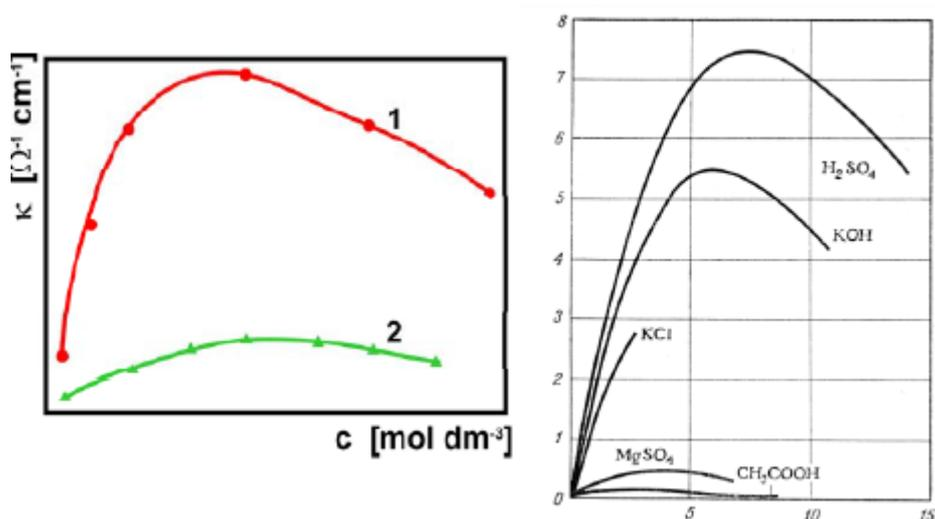

- Λ values for strong electrolytes are larger than weak electrolytes for the same concentration.
- Increase Λ for strong electrolyte is quite small as compared to that for weak electrolyte towards dilution.

The table below shows the trend in conductivity with dilution for a strong and a weak acid.

Table 12.2. Trends in conductivity

Concentration in Moles/dm ³	Conductance at 25°C/Mhos	
	HCl (strong acid)	CH ₃ COOH (weak acid)
1.0	333	-
0.1	391	5
0.01	413	16
0.001	421	91
0.0001	426	391

Explanation of Increase in Conductivity with Dilution:

With increase in dilution (decrease in concentration), ions become farther apart, and inter-ionic forces (i.e. forces of attraction between unlike ions and forces of repulsion between like ions) decrease considerably, so that greater number of ions are able to migrate to the electrodes. In addition, due to change in equilibrium, the electrolyte undergoes further ionization from the same mass in solution (in order to balance the effect). Hence, more ions (conducting species) are introduced into the solution

12.5. Molar conductivity at infinite dilution

Kohlrausch's law of independent migration of ions states that "*at infinite dilution, where ionization of all electrolytes is complete and where all interionic effects are absent, the molar conductivity of an electrolyte is the sum of the molar conductivities of its constituent ions at constant temperature*".

According to the law, the molar conductivity of KCl at infinite dilution (Λ_{∞} or λ_{m}^{∞}) is presented as:

$$\Lambda_{\infty}(\text{KCl}) = \Lambda_{\infty}(\text{K}^+) + \Lambda_{\infty}(\text{Cl}^-)$$

Some values of conductivity at infinite dilution ($\text{Sm}^2\text{mol}^{-1}$)

Ions/ Cations	H_3O^+	Na^+	Ag^+	NH_4^+	$\frac{1}{2}\text{Mg}^{2+}$	$\frac{1}{2}\text{Cu}^{2+}$	$\frac{1}{2}\text{Al}^{3+}$	Li^+	$\frac{1}{2}\text{Ca}^{2+}$
$10^4 \Lambda_{\infty}$	349.8	50.1	61.9	73.4	53.1	53.6	69.0	38.6	59.5

Ions/ Anions	OH^-	Cl^-	I^-	NO_3^-	H_2PO_4^-	$\frac{1}{3}\text{PO}_4^{3-}$	CH_3CO_2^-	$\frac{1}{2}\text{HPO}_4^{2-}$	$\frac{1}{2}\text{SO}_4^{2-}$
$10^4 \Lambda_{\infty}$	199.2	76.3	77.0	71.4	36.0	92.8	40.9	57.0	80

Example 1

The molar conductivity of chloride ion is $1.264 \times 10^{-2} \text{ S m}^2 \text{ mol}^{-1}$. What is the molar conductivity of sodium ions given that the molar conductivity of NaCl is $1.264 \times 10^{-2} \text{ S m}^2 \text{ mol}^{-1}$?

Solution

According to Kohlrausch's law,

$$\Lambda_{\infty}(\text{NaCl}) = \Lambda_{\infty}(\text{Na}^+) + \Lambda_{\infty}(\text{Cl}^-)$$

$$\Lambda_{\infty}(\text{Na}^+) = \Lambda_{\infty}(\text{NaCl}) - \Lambda_{\infty}(\text{Cl}^-)$$

$$= 1.264 \times 10^{-2} - 7.63 \times 10^{-3}$$

$$= \mathbf{5.01 \times 10^{-3} \text{ Sm}^2 \text{ mol}^{-1}}$$

Example 2

The molar conductivities at infinite dilution of KCl, KNO_3 and AgNO_3 at 298K are $0.01499 \text{ Sm}^2 \text{ mol}^{-1}$; $0.01450 \text{ Sm}^2 \text{ mol}^{-1}$ and $0.01334 \text{ Sm}^2 \text{ mol}^{-1}$ respectively, calculate the molar conductivity of AgCl at infinite dilution at this temperature.

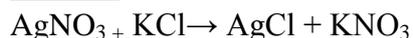
Answer:

$$\Lambda_{\infty} \text{AgCl} + \Lambda_{\infty} \text{KNO}_3 = \Lambda_{\infty} \text{AgNO}_3 + \Lambda_{\infty} \text{KCl}$$

$$\Leftrightarrow \Lambda_{\infty} \text{AgCl} = \Lambda_{\infty} \text{AgNO}_3 + \Lambda_{\infty} \text{KCl} - \Lambda_{\infty} \text{KNO}_3$$

$$(0.01334 + 0.01499 - 0.01450) \text{Sm}^2 \text{mol}^{-1} = 0.01383 \text{Sm}^2 \text{mol}^{-1} = \mathbf{138.3 \text{Scm}^2 \text{mol}^{-1}}$$

Example 3

Calculate the molar conductance of aqueous BaSO_4 solution at infinite dilution. Given

$$\Lambda_{m(\text{Ba}(\text{NO}_3)_2)}^0 = 270.08 \times 10^{-4} \text{Sm}^2 \text{mol}^{-1}, \Lambda_{m(\text{H}_2\text{SO}_4)}^0 = 859.20 \times 10^{-4} \text{Sm}^2 \text{mol}^{-1}$$

$$\Lambda_{m(\text{HNO}_3)}^0 = 421.24 \times 10^{-4} \text{Sm}^2 \text{mol}^{-1}.$$

$$\Lambda_{\text{BaSO}_4} = \Lambda_{m(\text{Ba}(\text{NO}_3)_2)}^0 + \Lambda_{m(\text{H}_2\text{SO}_4)}^0 - 2\Lambda_{m(\text{HNO}_3)}^0$$

$$\Lambda_{\text{BaSO}_4} = (270.08 \times 10^{-4} + 859.20 \times 10^{-4} - 2 \times 421.24 \times 10^{-4}) \text{Sm}^2 \text{mol}^{-1} = 268.80 \times 10^{-4} \text{Sm}^2 \text{mol}^{-1}$$

Checking up 12.4

1. A cell with electrodes of 0.0002m^2 of area and 0.1m apart is filled with 0.1M aqueous solution of NaCl . The molar conductance is $106.7 \times 10^{-4} \text{Sm}^2 \text{mol}^{-1}$ at 298K . If the applied emf across section is 50 volts, calculate the current in ampere flowing through the cell.
2. A conductivity cell was filled with 0.01M KCl which was known to have a specific conductivity of 0.1413S.cm^{-1} at 298K . It is measured resistance at 298K was 94.3ohms . When the cell filled with 0.02M AgNO_3 its resistance was 50.3ohms . Calculate:
 - (i) The cell constant
 - (ii) The specific conductance of AgNO_3 solution.

12.6. Factors that affect molar conductivity of solutions**Activity 12.5.**

Compare the conductivities of the following solutions and explain why they are different

- a) 1M HCl and 0.1M HCl
- b) 0.12M CH_3COOH and 0.0002M of CH_3COOH

1) Temperature

The increase of temperature decreases inter-ionic attractions and increases kinetic energy of ions and their speed. Thus, Λ_m increases with temperature.

2) Concentration of the solution

The concentrated solutions of strong electrolytes have significant interionic attractions which reduce the speed of ions and lower the value of Λ_m . The dilution decreases such attractions and increases the value of Λ_m .

3) Nature of electrolyte

The strong electrolytes like KNO_3 , KCl , NaOH , etc are completely ionized in aqueous solution and have high values of molar conductivity. The weak electrolytes are ionized to a lesser extent in aqueous solution and have lower values of molar conductivity. Solvents of high dielectric constant yield more conducting solution. The viscosity is inversely proportional to the conductance.

4) Ionic charge and size

Generally, the ions move at very low speeds. The velocities of *hydrogen ions* and *hydroxyl ions* are relatively high. They contribute greatly to high conductivities of aqueous solutions of strong acids and alkalis.

The differences in speeds of ions under similar conditions are as a result of their difference in charge and size.

a) Ionic charge

Multiple charged ions get strongly attracted to the oppositely charged electrode. This increases their speeds compared to singly charged ions.

b) Ionic size

Velocities of smaller ions are higher than those of larger ions of the same charge. This is because larger ions meet many obstacles compared to small ones. However, as ions exist in aqueous solution in a solvated form, the radius of the hydrated ion is considerably larger than the crystal radius. Small ions get more hydrated than larger ones due to high charge density. This reverses the expected order of ionic velocities. Thus for group 1 cations, the ionic radius increases in the order $\text{Li}^+ < \text{Na}^+ < \text{K}^+ < \text{Rb}^+ < \text{Cs}^+$ and the electric mobility increases in the same order ($\text{Li}^+ < \text{Na}^+ < \text{K}^+ < \text{Rb}^+ < \text{Cs}^+$). This is because of the effect of hydration. This explains why lithium ions have a *lower molar ionic conductivity* than potassium ions.

5) Pressure

The molar conductance increases slightly with increase in pressure.

6) Effect of high voltage

At high voltages, the ions move quite fast in solution and are free from influence of oppositely charged ions. The conductance, therefore, increases and approaches a limiting value for infinite dilution

Checking up 12.5

Given the following substances and materials in aqueous solution

- NH_4Cl
- PbSO_4

- c) Mg metal
 - d) MgSO₄ 0.1M
 - e) MgSO₄ 0.001M
 - f) Acetic acid 1M
 - g) HCl 1M
 - h) CH₃OH
 - i) CH₃CH₂OH
- a) Group the above substances into 2 categories : conductor and nonconductor of electricity then explain your classification
- b) Among the conductors, did all of them conduct in the same way or not?; if not explain why

Experiment

- Take two Irish potatoes and wash them
- In each you have to fix the nail after you have to fix the Irish potatoes on the bench by using the glue
- Take a bulb (with two electrodes positive and negative)
- Fix also the bulb with connecting wires on the bench using also the glue
- Take the second extremity of each wire (because the first is connected on the bulb) and connect it on the nail fixed in the Irish potatoe
- Observe the phenomenon that will happen.

12.6. Kohlrausch's law of individual molar conductivity

Activity 12.6.

- a) Given the following substances CaCl₂, CH₃COOH, NaOH, NH₄Cl, H₂SO₄. Order those substances in their level of conductivity
- b) among the conductors how can you compare the conductivities

Remember that the molar conductivity, Λ_m is the **ratio of specific conductivity and the concentration** of the electrolyte.

Λ and Λ_∞ are the molar conductivity at a given concentration and at infinite dilution respectively.

12.6.1. Molar conductivity at a given concentration (Λ or Λ_m^c)

$\Lambda_m = \mathbf{Kc}$ Where, \mathbf{K} = specific conductivity and \mathbf{c} = concentration of electrolyte.

From the equation $\kappa = \frac{1}{\rho} = \frac{1}{R A} l$, we get $\kappa = \frac{1}{R} \times (\text{cell constant})$

$$\kappa = (\text{conductance}) \times (\text{cell constant}) \Rightarrow \frac{l}{A} = \text{cell constant} = \frac{\kappa}{\text{conductance}}$$

The molar conductance is then obtained $\Lambda_m = \frac{\kappa}{C}$

Example 1

A solution of $0.108 \text{ mol dm}^{-3}$ of ethanoic acid has a conductivity of $4.95 \times 10^{-2} \Omega \text{ m}^{-1}$. What is the molar conductivity of this solution?

Solution

$$\Lambda = \kappa / C$$

$$C = 0.108 \text{ mol dm}^{-3} = (0.108 \times 1000) \text{ mol m}^{-3}$$

$$\Lambda = 4.95 \times 10^{-2} / 0.108 \times 1000 = \mathbf{4.58 \times 10^{-4} \Omega^{-1} \text{ m}^2 \text{ mol}^{-1}}$$

Note: Molar conductivity is often expressed as **Siemens centimeter squared per mole** in CGS unit.

12.6.1. Relation between molar conductivity, degree of ionization and ionization constant

Activity 12.6.1

1. Define the following terms:

a) Degree of ionization

b) Ionization constant

2. Establish the relation of calculation of ionization constant

3. Explain why there is a relation between ionization constant and the molar conductivity

At infinite dilution, the electrolyte is completely ionized and all the ions take part in conducting the current. At appreciable concentration, only a fraction of the electrolyte is ionized and the degree of ionization α of the electrolyte is given as:

$$K_a = \frac{\alpha^2 C}{1 - \alpha} \text{ where } C \text{ is the concentration of electrolyte.}$$

$$\text{Solving the above quadratic equation for } \alpha \text{ we obtain } \alpha = \frac{K_a}{2C} \left[\left(1 + \frac{4C}{K_a} \right)^{\frac{1}{2}} - 1 \right]$$

If the molar conductivity of the hypothetical fully ionized electrolyte is, Λ_{∞} since only a fraction α is actually present as ions in the actual solution, the measure of molar conductivity given by Λ . At infinite dilution the weak electrolyte is said to be completely ionized and all the ions take part in conducting the current, the **degree of ionization** of the weak electrolyte is given as:

$$\alpha = \frac{\Lambda}{\Lambda_{\infty}} \text{ (conductance ratio, the degree of ionization)}$$

Having the degree of ionization α , the *dissociation constant* K_a can be obtained as:

$$K_a = \frac{\alpha^2 C}{1 - \alpha}$$

From the above equations, also the pH of the solution can be calculated. For example, for a weak acid such as ethanoic acid,

$$pH = \frac{1}{2} pK_a - \frac{1}{2} \log C_{acid}$$

Note that: $pK_a = -\log K_a$

Checking up 12.6

1. The resistance of 0.02M solution of an organic acid in a cell (cell constant = 0.2063 cm⁻¹) was found to be 888 Ω .
 - a) What is the degree of ionization of that organic acid at this concentration given that its molar conductivity at infinite dilution is 387.9 x 10⁻⁴ Sm²mol⁻¹
 - b) Calculate pK_a for that organic acid.
 - c) Calculate the pH of that solution

12.7. Use of conductivity measurement in titration and solubility product

Activity 12.7.

1. What do you understand by the term titration?
2. While titrating a solution of sodium hydroxide with hydrochloric acid, explain how the concentration of ions change in the mixture.
3. What is solubility?
4. Define solubility product.

You have a glass of water. You add sugar or salt to dissolve. What will happen if you continue to add sugar or salt? Can you explain?

1. What are the factors that influence solubility of a substance
2. Give an example of a substance which is insoluble or sparingly soluble
3. What is the relation between solubility of a substance and concentration
4. Explain at which degree a sparingly soluble substance conduct electricity

12.7.1. Using conductivity to find the end point of a titration

The end-point in titration experiment can be determined using conductivity. The procedure of the technique is:

At the start of this titration the conical flask contains a strong alkali that is fully ionized in water. If electrodes are placed inside the conical flask the ions in the water will conduct electricity and a current will flow.

The more ions there are the better the conductivity and the higher the current will be.

The current can be measured using an **ammeter**. As acid is added to the alkali hydrogen ions and hydroxide ions react together to form water molecules.

The number of ions in the conical flask starts to decrease and the current flowing through the solution will decrease. At neutralization all of the hydrogen ions and hydroxide ions have reacted together to form water molecules.

The neutral solution contains only salt ions dissolved in water molecules. The solution will still conduct electricity because of the salt ions but the current will be at a minimum. As more acid is added the current will start to increase because there will now be unreacted hydrogen ions in the solution as well as the salt ions. The solution is now no longer neutral but has become acidic.

If you draw a graph of current against the amount of acid added you can see where the minimum is. This is *the end point of the titration* at neutralization.

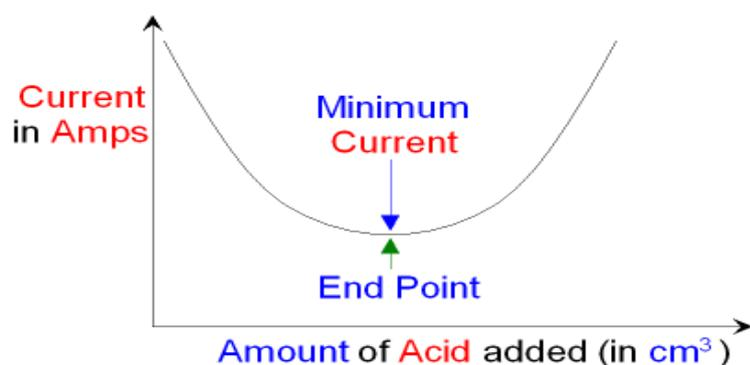

12.7.2. Determination of solubility product by conductivity measurement

Solubility product, K_{sp} , is the mathematical **product** of its dissolved ion concentrations raised to the power of their stoichiometric coefficients. **Solubility products** are relevant when a sparingly soluble ionic compound releases ions into solution.

That is the product of the concentration of ions in the solution which are in equilibrium with the solid ion. These concentrations can be determined via conductivity measurements, consider the following examples

$PbSO_4$.



Assume concentration of solid is a constant.

Concentration of Pb^{2+} = concentration of SO_4^{2-} = C

$$K_{sp} = [\text{Pb}^{2+}_{aq}] [\text{SO}_4^{2-}_{aq}]$$

$$K_{sp} = C^2$$

Example 2



Let $[\text{Ca}^{2+}] = x$

$$[\text{F}^-] = 2x$$

$$K_{sp} = [\text{Ca}^{2+}][\text{F}^-]^2 = x(2x)^2 = 4x^3 = 4C^3$$

The measurement of conductivity will depend on the value of K_{sp} for the sparingly soluble substances.

The measurement of the specific conductivity, K of the saturated solution leads to a value of the concentration.

Example 1 of a 1:1 ration as BaSO_4

$$\text{i.e. } C = K / \Lambda_0$$

$$\text{As, } K_{sp} = C^2$$

$$K_{sp} = (K / \Lambda_0)^2$$

$$\Lambda_0 \text{ for } \text{PbSO}_4 = 3.02 \times 10^{-2} \text{ m}^2\text{Smol}^{-1}$$

Λ_0 = Molar conductivity at infinite dilution

Example

The specific conductance of saturated aqueous solution of barium sulfate at 298K is $1.84 \times 10^{-4} \text{ Sm}^{-1}$ and that of water is $1.60 \times 10^{-4} \text{ Sm}^{-1}$. The ionic conductivities at infinite dilution of Ba^{2+} and SO_4^{2-} ions at 298 K are $63.6 \times 10^{-4} \text{ Sm}^2\text{mol}^{-1}$ and $79.8 \times 10^{-4} \text{ Sm}^2\text{mol}^{-1}$ respectively.

Calculate the solubility and solubility product of barium sulphate at 298K

Answer: $S = 1.171 \times 10^{-4} \text{ mol/l}$; $K_{sp} = 1.370 \times 10^{-8} \text{ M}^2$

Checking up 12.7.

1. The conductivity of a saturated solution of a sparingly soluble salt MX in water at 298K is $1.88 \times 10^{-4} \text{ Sm}^{-1}$. The molar conductivity of MX at infinite dilution at this temperature is $138.3 \times 10^{-4} \text{ Sm}^{-1}$. Calculate the solubility and the solubility product of MX at this temperature.
2. a) Explain how the solubility product affect the conductivity,

12.18. Difference between metallic conductivity and electrolytic conductivity

Activity. 12.8

Make an experiment by connecting a bulb to the batteries by using an electric wire

After you have attempted that experience, compare the results seen and the results you're the introductory activity and answer to the following questions.

- What do you think are conductors of electricity in the two experiments (separately)
- Compare the reaction after 20 minutes, what is the difference between the intensity of lights in the two experiments

The substances, which allow the passage of electric current, are called **conductors**. The best metal conductors are such as copper, silver, tin, etc. On the other hand, the substances, which do not allow the passage of electric current through them, are called **non-conductors** or **insulators**. Some common examples of insulators are rubber, wood, wax, etc.

The conductors are broadly classified into two types, Metallic and electrolytic conductors.

Metallic conduction	Electrolytic conduction
(i) It is due to the flow of electrons.	(i) It is due to the flow of ions.
(ii) It is not accompanied by decomposition of the substance.(Only physical changes occurs)	(ii) It is accompanied by decomposition of the substance. (physical as well as chemical change occur)
(iii) It does not involve transfer of matter.	(iii) It involves transfer of matter in the form of ions.
(iv) Conductivity decreases with increase in temperature.	(iv) Conductivity increases with increases in temperature and degree of hydration due to decreases in viscosity of medium.

The *electrolyte* may, therefore, be defined as ***the substance whose aqueous solution or fused state conducts electricity accompanied by chemical decomposition.*** The conduction of current through electrolyte is due to the movement of ions.

On the contrary, substances, which in the form of their solutions or in their molten state do not conduct electricity, are called *non-electrolytes*.

Checking up 12.8

In the experiment, a student was investigating the intensity of light

In the beaker A where there was HCl solution the intensity of light was high

In beaker B where there was ethanol there was no light

Using the plastic bag there was no light but using the copper wires there was the intensity of light. Explain why the change in intensities of light in the above experiment

12.9. End unity assessment.

- Define the terms with their unity
 - Specific conductance

- b) Equivalent conductivity
 c) Cell constant
- The equivalent conductance at infinite dilution (Λ_0) of HCl, CH₃COONa and NaCl are 426.16, 91.0 and 126.45ohm⁻¹cm²g equ⁻¹ respectively calculate Λ_0 of acetic acid.
 - Among the following substances state those which are good conductors, NH₄OH, H₂SO₄, sugar, oil and explain why.
 - (a) Explain what is meant by the term
 - Electrolytic conductivity
 - Molar conductivity
 (b) A solution of electrolyte of concentration 0.02mol dm⁻³ has a resistance of 0.357ohm in a cell with a cell constant of 1.50m⁻¹, calculate the molar conductivity of the electrolyte
 (c) (i) state and explain two factors that determine the magnitude of electrolytic conductivity of sodium Chloride.
 (ii) Explain the effect of increasing temperature on electric conductivity of weak electrolyte solution
 - The graph shows the variation of molar conductivity of different electrolytes with concentration .

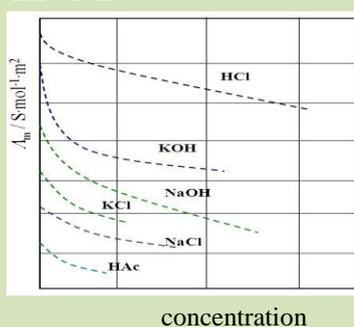

- a)
- Explain the shape of the graph for the case of HCl
 - State the two applications of the graph.
 - On of the same axes, sketch and explain the shape of the graph if ethanoic acid was used instead of hydrochloric acid.
- b) The table below shows the variation in molar conductivity of sodium hydroxide with concentration

Molar conductivity in Ohm ⁻¹ cm ² mol ⁻¹	238	230	224	217	210	202
Concentration moldm ⁻³	0.01	0.04	0.09	0.16	0.25	0.36

- Plot a graph of molar conductivity against square root of concentration and explain the shape of your plot
- Determine the value of molar conductivity at infinite dilution for sodium hydroxide
- On the same axes, show how the molar conductivity of ethanoic acid varies and explain the shape of your graph
- State and explain two factors that would affect the magnitude of the molar

conductivity of sodium hydroxide.

- e) The atomic radii and molar conductivity at infinite dilution at 18°C of Li⁺ and Cs⁺ are given below:

Ion (n)	Li ⁺	Cs ⁺
Ionic radius (nm)	0.06	0.17
Molar conductivity $\Omega\text{cm}^2\text{mol}^{-1}$	33.5	68.0

Explain why the molar conductivity of Li⁺ is lower than that of Cs⁺

6. (a) State the Kehlrausch's law of migration of ions and show how it can be used to obtain the molar conductivity of weak electrolyte
(b) The molar conductivity at infinite dilution at 18°C of HNO₃, NaNO₃, and CH₃CH₂COONa are 413, 108 and 87 $\Omega\text{cm}^2\text{mol}^{-1}$ respectively. The molar conductivity of 18°C of 0.0025M solutions of propionic acid is 48.6 $\Omega\text{cm}^2\text{mol}^{-1}$

Calculate the molar conductivity at infinite dilution of propionic acid.

7. Explain what is meant by the following term:
(a) Degree of ionization
(b) The molar conductivity of infinite dilution at 25 °C for the following electrolytes: strontium chloride, strontium hydroxide and methylamine hydrochloride are 189.2, 228.6 and 117.3 $\Omega\text{cm}^2\text{mol}^{-1}$, respectively. If the molar conductivity of 0.001M aqueous solution of methyl amine at 25 °C is 94.8 $\Omega\text{cm}^2\text{mol}^{-1}$, calculate at 25°C ($K_w = 1 \times 10^{-14}$)
(i) The degree of ionization of methyl amine
(ii) Ionization constant of methyl amine
8. (a) What meant by conductimetric titration?
(b) Sketch the graph to show the variation in conductivity of the following conductimetric titrations and explain the shape of each graph of the following reactions
1. titration of solution of HCl against NaOH
 2. sodium hydroxide against ethanoic acid
 3. Ammonia solution against hydrochloric acid
 4. Silver nitrate against sodium chloride solution
- c) The electrolytic conductivity of a saturated solution of silver chloride at 23°C is $6.43 \times 10^{-5} \Omega\text{cm}^2\text{mol}^{-1}$
And that of water at the same temperature is $3.82 \times 10^{-5} \Omega\text{cm}^2\text{mol}^{-1}$, if the molar conductivity of silver chloride at 23 °C, is $533 \times 10^{-1} \Omega\text{cm}^2\text{mol}^{-1}$, calculate the solubility of silver chloride solution at 23 °C in gram per liter

UNIT 13: ELECTROLYSIS

Key unit competence: Predict the products of given electrolytes during electrolysis and work out quantitatively to determine how much is liberated at a given electrode using Faraday's law.

Learning Objectives:

- Define electrolysis, cathode and anode.
- Explain the electrolysis of different substances.
- State Faraday's laws and define the Faraday's constant.
- Develop practical experimental skills related to electrolysis, interpret results, and draw valid conclusions.
- Carry out a practical activity to explain the phenomenon of electrolysis.
- Compare the electrolysis of dilute solutions and concentrated solutions.
- Calculate the masses and volumes of substances liberated during electrolysis.
- Relate the nature of electrode, reactivity of metal ion in solution to the products of electrolysis.
- Perform electroplating of graphite by copper metal

Introductory activity

Observe carefully the figure below and answer the following question. Record your answer and discuss them.

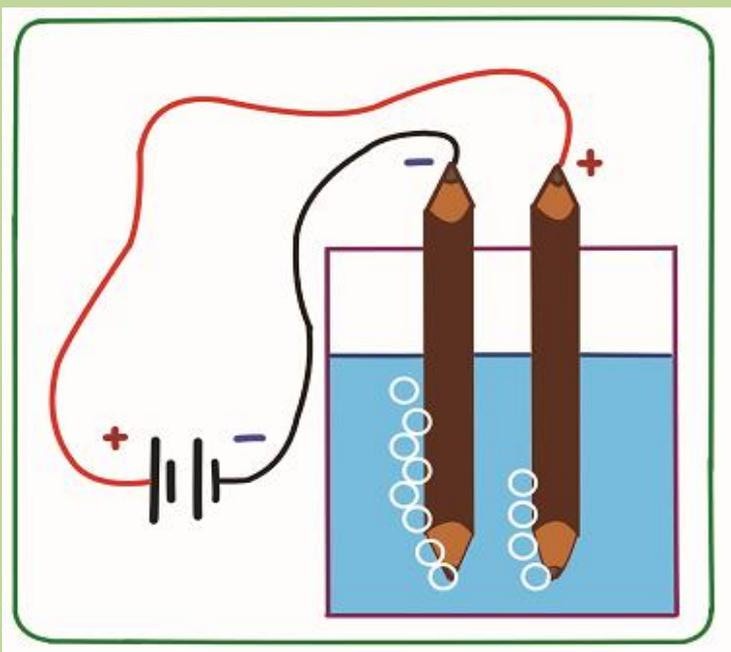

1. Label the set up and give the name of this Experiment.
2. Suggest how water can be decomposed into hydrogen and oxygen?

13.1. Definition of electrolysis and Description of electrolytic cells.

Activity 13.1:

- A) (1) In one case, you have a source of water at the top of a hill and you want to supply water to a community in the valley down the hill
(2) In another case, you have a community at the top of a hill and you want to supply water to the community from a source located in the valley down.
Students in groups discuss how they would proceed to supply water to the communities in the above two cases.
- B) Why do we cook food by heating?
C) What is the difference between a spontaneous reaction and a non-spontaneous reaction?
D) Have you heard about electrolysis? If yes, can you say what it is about?

1. Definition of electrolysis.

A **spontaneous reaction** is a **reaction** that favors the formation of products without external energy. It is a process that will occur on its own. For example, a ball will roll down an incline, water will flow downhill, radioisotopes will decay, and iron will rust. No intervention is required because these processes are thermodynamically favorable.

A **non spontaneous reaction** (also called an unfavorable **reaction**) is a chemical **reaction** that necessitates external energy to occur. **For example**, without an external energy source, water will remain water forever. Under the right conditions, using electricity (direct current) will help to produce hydrogen gas and oxygen gas from water. Cooking foods is not spontaneous reaction that is why heat is used.

Electrolyte: Sodium chloride is an ionic compound in which ions arrange themselves in a rigid cubic lattice when in solid state. In this state, it cannot allow electric current to pass through it. However, when it is melted, or dissolved in water, the rigid lattice is broken, ions are free to move and electric current can pass. Therefore, it is classified as an **electrolyte**.

Substances which cannot allow the flow of electric current when in molten or in solution are referred to as **non-electrolytes**. When electric current (direct current) flows through an electrolyte, it decomposes it. This phenomenon is called **electrolysis**.

Thus electrolysis is the decomposition of an electrolyte by passage of an electric current through it. Therefore for electrolysis to take place, there must be a source of direct current. The direct current is conveyed from its source to the electrolyte by means of a metallic conductor and electrodes. The electrode connected to the positive terminal of the direct current is called the **anode** and the one connected to the negative terminal is the **cathode**. By convention, the electric current enters the electrolyte by the anode and leaves by the cathode.

When the current passes through an electrolytic solution, ions migrate and electrons are gained or lost by ions on the electrodes surface. Electrode that is positively charged has deficit of electrons is called anode and the other electrode negatively charged has excess of electrons and is called cathode. Chemical changes at the electrodes due to the passage of electric current are called electrolysis.

2. Description of electrolytic cells.

An **electrolytic cell** is an **electrochemical cell** that drives a non-spontaneous redox reaction through the application of external electrical energy. They are often used to decompose chemical compounds, in a process called **electrolysis**. The Greek word **lysis** means *to break up*.

Important examples of electrolysis are the decomposition of water into hydrogen and oxygen, production of sodium metal, Na, from molten NaCl, production of aluminium and other chemicals. Electroplating (e.g. of copper, silver, nickel or chromium) is done using an electrolytic cell.

An electrolytic cell has three component parts: an **electrolyte** and two electrodes (a cathode and an anode). The **electrolyte** is usually a solution of water or other solvents in which ions are dissolved. Molten salts such as sodium chloride are also electrolytes. When driven by an external voltage applied to the electrodes, the ions in the electrolyte are attracted to an electrode with the opposite charge, where charge-transferring (also called faradaic or redox) reactions can take place. Only with an external **electrical potential** (i.e. voltage) of correct polarity and sufficient magnitude can an electrolytic cell decompose a normally stable, or inert chemical compound in the solution. The electrical energy provided can produce a chemical reaction which would not occur spontaneously otherwise.

The main components required to achieve electrolysis are:

- An **electrolyte substance** containing free ions which are the carriers of electric current in the electrolyte. If the ions are not mobile, as in a solid salt then electrolysis cannot occur.
- A direct current (DC) supply: provides the energy necessary to create or discharge the ions in the electrolyte. Electric current is carried by electrons in the external circuit. Electrolysis depends on controlling the voltage and current. Alternating current (AC) would not be appropriate for electrolysis. Because the "cathode" and "anode" are constantly switching places, AC produces explosive mixtures of hydrogen and oxygen.
- Two electrodes: an electrical conductor which provides the physical interface between the electrical circuit providing the energy and the electrolyte.

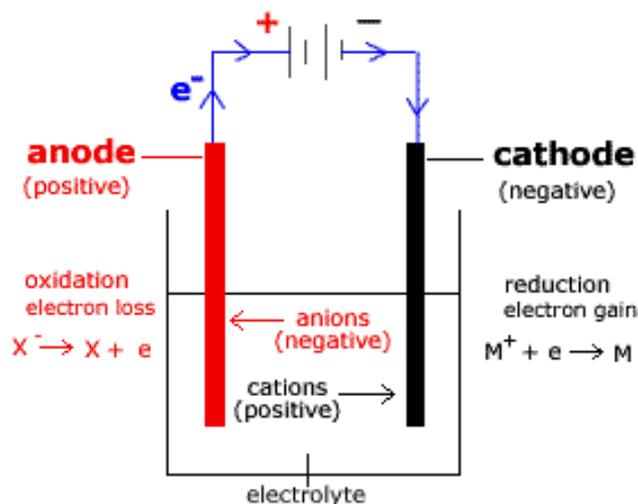

Figure 13.1.: Electrolytic cell

13.2. Electrolysis of sodium chloride

Activity 13.2: Investigating the effect of concentration on the products formed during electrolysis of concentrated sodium chloride solution.

Materials: Carbon or graphite rods, connecting wire, U-tube, dry cell, glass syringes, concentrated sodium chloride, cork and switch.

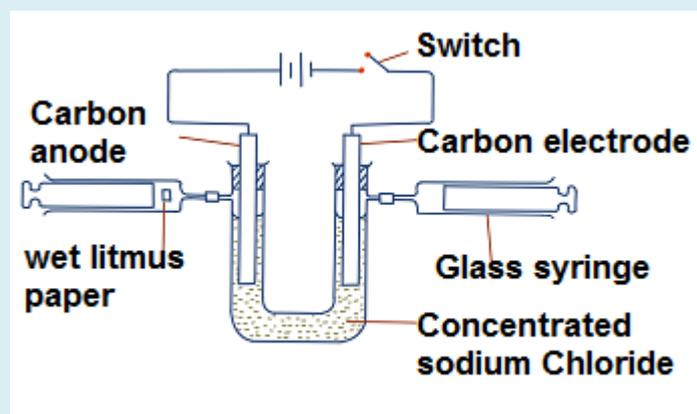

Figure 13.2.1: Electrolysis of concentrated sodium chloride solution

Procedure:

1. Add 10g of sodium chloride to 100cm³ of distilled water.
2. Warm the mixture and continue adding sodium chloride until a saturated solution is formed.
3. Put the saturated solution in U-tube and fit it with carbon rods and glass syringes.
4. Level the brine solution in the two arms and switch on the circuit. Record any observations made after some time. Identify any gases collected in the syringe.

Questions:

- a) Identify the gases formed by testing them using litmus papers.
- b) Using ionic equations, explain how the products are formed.

Sodium chloride may be in different forms that can be electrolytes. It may be in its molten state, dilute solution or concentrated solution. In each case, the products of electrolysis differ because of different factors.

13.2.1. Electrolysis of molten sodium chloride

The molten salt is introduced in a container called *electrolytic cell* (or electrolysis cell) in which there are two inert electrodes (platinum or graphite). Electrodes are connected to a DC generator.

- Cations (Na^+) move toward the cathode (negative electrode), where they take electrons and are reduced. On cathode metallic sodium is deposited: $\text{Na}^+ + 1 \text{e}^- \rightarrow \text{Na}$
- Anions (Cl^-) move towards the anode (positive electrode), where they give up electrons and are oxidized. On the anode Cl_2 is released: $2 \text{Cl}^- - 2 \text{e}^- \rightarrow \text{Cl}_2$

The overall reaction is the addition of half reactions at electrodes:

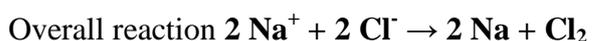
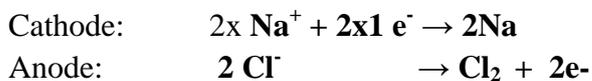

The cathode provides electrons so it is a reducing site.

The anode takes electron, so it is an oxidizing site.

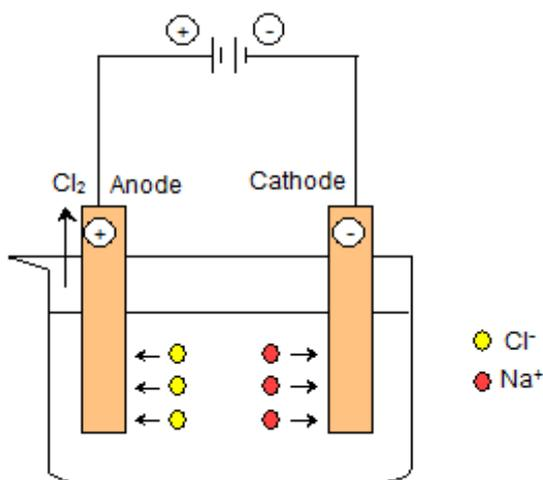

Figure 13.2.2: Electrolysis of molten sodium chloride solution

13.2.2. Electrolysis of Dilute Sodium Chloride Solution

An aqueous solution of sodium chloride contains four different types of ions. They are

Ions from sodium chloride: Na^+ (aq) and Cl^- (aq)

Ions from water: H^+ (aq) and OH^- (aq)

When dilute sodium chloride solution is electrolysed using inert electrodes, the Na^+ and H^+ ions are attracted to the cathode. The Cl^- and OH^- ions are attracted to the anode.

Table 13.2: Standard reduction potentials.

Reduction Half-Reaction	Standard Reduction Potential (V)
$\text{F}_2(\text{g}) + 2\text{e}^- \rightarrow 2\text{F}^-(\text{aq})$	+2.87
$\text{S}_2\text{O}_8^{2-}(\text{aq}) + 2\text{e}^- \rightarrow 2\text{SO}_4^{2-}(\text{aq})$	+2.01

Reduction Half-Reaction	Standard Reduction Potential (V)
$\text{O}_2(\text{g}) + 4\text{H}^+(\text{aq}) + 4\text{e}^- \rightarrow 2\text{H}_2\text{O}(\text{l})$	+1.23
$\text{Br}_2(\text{l}) + 2\text{e}^- \rightarrow 2\text{Br}^-(\text{aq})$	+1.09
$\text{Ag}^+(\text{aq}) + \text{e}^- \rightarrow \text{Ag}(\text{s})$	+0.80
$\text{Fe}^{3+}(\text{aq}) + \text{e}^- \rightarrow \text{Fe}^{2+}(\text{aq})$	+0.77
$\text{I}_2(\text{l}) + 2\text{e}^- \rightarrow 2\text{I}^-(\text{aq})$	+0.54
$\text{Cu}^{2+}(\text{aq}) + 2\text{e}^- \rightarrow \text{Cu}(\text{s})$	+0.34
$\text{Sn}^{4+}(\text{aq}) + 2\text{e}^- \rightarrow \text{Sn}^{2+}(\text{aq})$	+0.15
$\text{S}(\text{s}) + 2\text{H}^+(\text{aq}) + 2\text{e}^- \rightarrow \text{H}_2\text{S}(\text{g})$	+0.14
$2\text{H}^+(\text{aq}) + 2\text{e}^- \rightarrow \text{H}_2(\text{g})$	0.00
$\text{Sn}^{2+}(\text{aq}) + 2\text{e}^- \rightarrow \text{Sn}(\text{s})$	-0.14
$\text{V}^{3+}(\text{aq}) + \text{e}^- \rightarrow \text{V}^{2+}(\text{aq})$	-0.26
$\text{Fe}^{2+}(\text{aq}) + 2\text{e}^- \rightarrow \text{Fe}(\text{s})$	-0.44
$\text{Cr}^{3+}(\text{aq}) + 3\text{e}^- \rightarrow \text{Cr}(\text{s})$	-0.74
$\text{Zn}^{2+}(\text{aq}) + 2\text{e}^- \rightarrow \text{Zn}(\text{s})$	-0.76
$\text{Mn}^{2+}(\text{aq}) + 2\text{e}^- \rightarrow \text{Mn}(\text{s})$	-1.18
$\text{Na}^+(\text{aq}) + \text{e}^- \rightarrow \text{Na}(\text{s})$	-2.71
$\text{Li}^+(\text{aq}) + \text{e}^- \rightarrow \text{Li}(\text{s})$	-3.04

The table shown below is simply a table of standard reduction potentials in decreasing order. The species at the top have a greater likelihood of being reduced while the ones at the bottom have a greater likelihood of being oxidized. Therefore, when a species at the top is coupled with a species at the bottom, the one at the top will be easily reduced while the one at the bottom will be oxidized.

- **At the cathode:**

The H^+ and Na^+ ions are attracted to the platinum cathode. H^+ ions gain electrons from the cathode to form hydrogen gas. (The hydrogen ions accept electrons more readily than the sodium ions. As a result, H^+ ions are discharged as hydrogen gas, which bubbles off. Explanation why H^+ ions are preferentially discharged will be given later.)



- **At the anode:**

OH^- and Cl^- are attracted to the platinum anode. OH^- ions give up electrons to the anode to form water and oxygen gas.

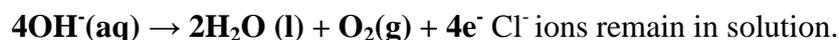

Adding the two reactions and balancing the terms:

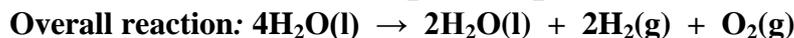
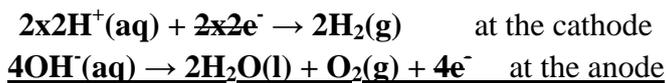

If we remove 2 molecule of water on both sides, we get: $2\text{H}_2\text{O}(\text{l}) \rightarrow 2\text{H}_2(\text{g}) + \text{O}_2(\text{g})$

Note:

- ▶ Since water is being removed (by decomposition into hydrogen and oxygen), the concentration of sodium chloride solution increases gradually. The overall reaction shows that the **electrolysis of dilute sodium chloride solution is equivalent to the electrolysis of water.**
- ▶ Another important thing to note is that **twice as much hydrogen is produced as oxygen.** Thus the volume of hydrogen produced is twice that of oxygen. Refer to the equations above and note the number of electrons involved to help you understand.

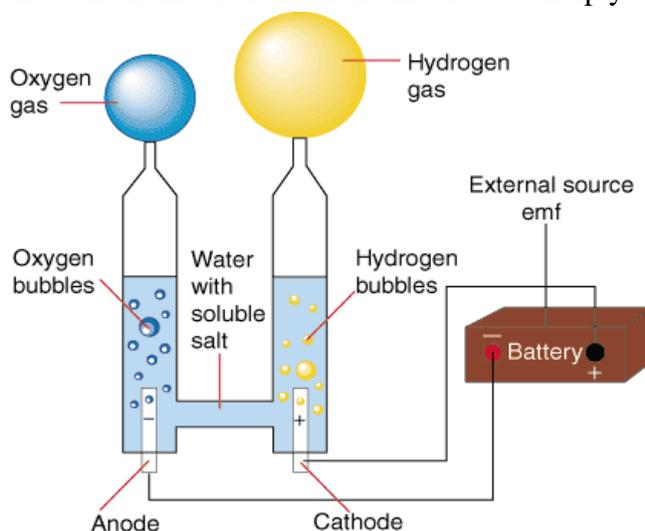

Figure 13.2.3: Electrolysis of dilute sodium chloride solution

13.2.3. Electrolysis of Concentrated Sodium Chloride Solution

The only difference with dilute NaCl solution is that at the anode, Cl^- ions are more numerous than OH^- ions. Consequently, Cl^- ions are discharged as chlorine gas, which bubbles off.

A half-equation shows you what happens at one of the electrodes during electrolysis.

- ❖ Anode: $2\text{Cl}^- - 2\text{e}^- \rightarrow \text{Cl}_2$ (oxidation)
- ❖ Cathode: $2\text{H}^+ + 2\text{e}^- \rightarrow \text{H}_2$ (reduction).

Sodium ions Na^+ and hydroxide OH^- are also present in the sodium chloride solution. They are not discharged at the electrodes. Instead, they make **sodium hydroxide** solution.

These products are reactive, so it is important to use inert (unreactive) materials for the electrodes.

One volume of hydrogen gas is given off at the cathode and **one volume** of chlorine gas is produced at the anode. The resulting solution becomes **alkaline** because there are more OH^- than H^+ ions left in the solution.

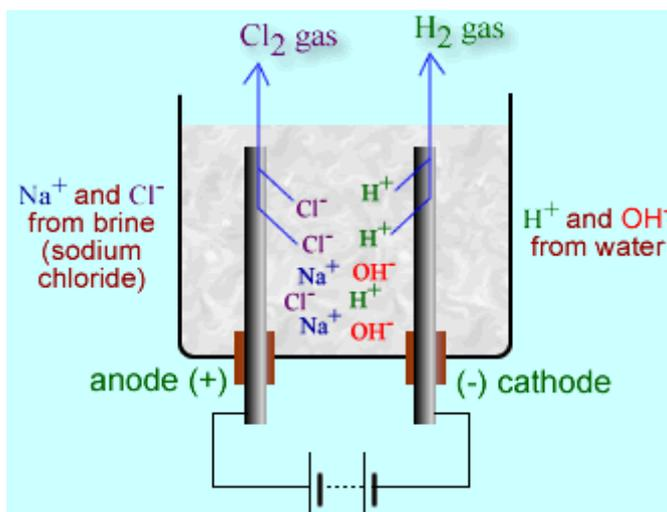

Figure 13.2.3: electrolysis of concentrated sodium chloride solution

Checking up 13.2: With the help of equations of reactions which occur at each electrode, outline what happens during electrolysis of dilute aqueous sodium chloride. What happens to the pH of the solution as electrolysis continues?

13.3. Electrolysis of water

Activity 13.3: Investigate the products formed during the electrolysis of water

Materials:

- Distilled water
- Tap water
- 2 silver-colored thumb tacks
- 9V battery
- Small, clear plastic container
- 2 test tubes
- Stopwatch
- Baking soda
- Table salt
- Lemon
- Dishwashing detergent

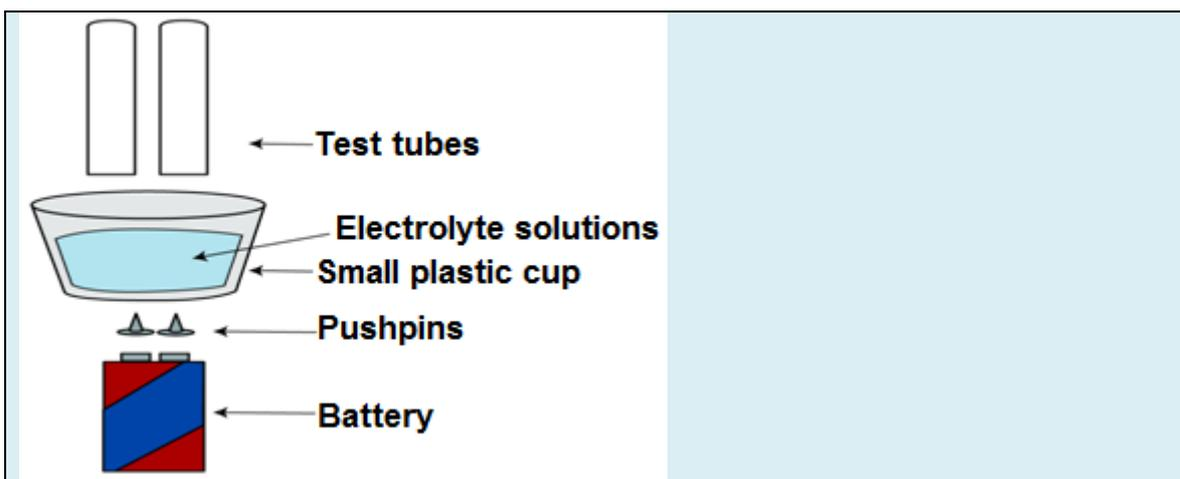

Procedure:

1. Insert the thumb tacks into the bottom of the plastic container so that the points push up into the container. Space them so that they're the same distance apart as the two terminals of the 9V battery. Be careful not to harm yourself!
2. Place the plastic container with the terminals of the battery. If the cup is too large to balance on the battery, be sure thumb tacks are connect to positive and negative pushpins and do no touch each other.
3. Slowly fill the container with distilled water. If the tacks move, go ahead and use this opportunity to fix them before you proceed. Will distilled water conduct electricity on its own? Try it!
4. Add a pinch of baking soda.
5. Hold two test tubes above each push pin to collect the gas being formed. Record your observations. **What happens? Does one tube have more gas than the other? What gases do you think are forming?**
6. Discard the solution, and repeat the procedure with a different combination:
 - Distilled water and lemon juice
 - Distilled water and table salt
 - Distilled water and dish detergent
 - Distilled water (no additive)
 - Tap water (**Does tap water works? If so, why?**)

Question: During the electrolysis of water, which electrolyte conducts electricity the best?

Water can be decomposed by passing an electric current through it. When this happens, the electrons from the electric current cause an oxidation-reduction reaction. At one electrode, called the cathode, electrons cause a reduction. At the other electrode, called the anode, electrons leave their ions completing the circuit, and cause an oxidation.

In order to carry out electrolysis the solution must conduct electric current. Pure water is a very poor conductor. To make the water conduct better we can add an electrolyte (NaCl) to the water. The electrolyte added must not be more electrolyzable than water. Many electrolytes that we add electrolyze more easily than water. Sulfate ions do not electrolyse as easily as water, so sulfates are often used to enhance the conductivity of the water

Water may be electrolyzed in the apparatus shown below. Pure water is however a very poor conductor of electricity and one has to add dilute sulphuric acid in order to have a significant current flow.

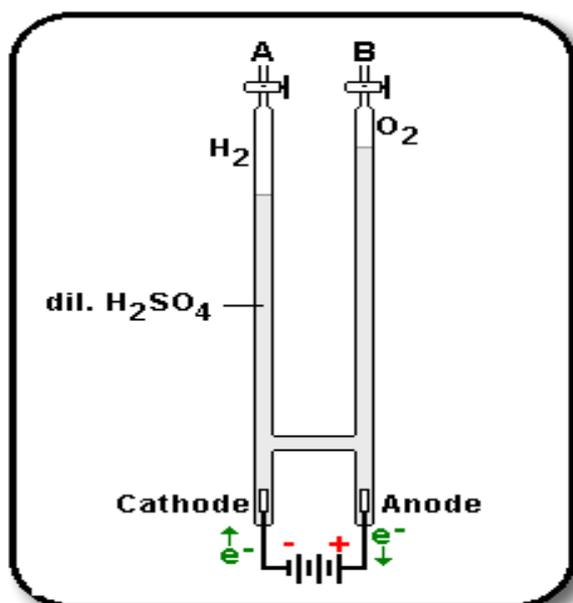

The electrodes consist of **platinum foil**. The electrolyte is **dilute sulphuric acid**.

Hydrogen gas is evolved at the cathode, and oxygen at the anode.

The ratio, by volume, of **hydrogen to oxygen**, is exactly **2:1**.

Remember that *electron flow in the circuit is opposite to the conventional current flow*.

The reaction at the cathode (tube A) is the reduction of protons:

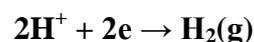

Oxidation takes place at the anode (tube B). There are two anions competing to give up their electrons, namely sulphate (SO_4^{2-}) from sulphuric acid, and hydroxide (OH^-) from the ionization of water. Here, the activity series is used to know the ion to be discharged.

The oxidation of OH^- according to the reaction:

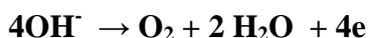

In pure water at the negatively charged cathode, a **reduction** reaction takes place, with electrons (e^-) from the cathode being given to hydrogen cations to form hydrogen gas. The **half reaction**, balanced with acid, is:



At the positively charged anode, an **oxidation** reaction occurs, generating oxygen gas and giving electrons to the anode to complete the circuit:

Oxidation at anode: $2 \text{H}_2\text{O} (l) \rightarrow \text{O}_2 (g) + 4 \text{H}^+ (aq) + 4\text{e}^-$

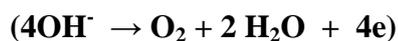

Cathode (reduction): $2 \text{H}_2\text{O}(l) + 2\text{e}^- \rightarrow \text{H}_2(g) + 2 \text{OH}^-(aq)$

Anode (oxidation): $4 \text{OH}^-(aq) \rightarrow \text{O}_2(g) + 2 \text{H}_2\text{O}(l) + 4 \text{e}^-$

Combining either half reaction pair yields the same overall decomposition of water into oxygen and hydrogen:



The number of hydrogen molecules produced is thus twice the number of oxygen molecules. Assuming equal temperature and pressure for both gases, the produced hydrogen gas has therefore twice the volume of the produced oxygen gas.

Checking up 13.3

I understand the process of water electrolysis, that water as an electrolyte can be decomposed into hydrogen and oxygen via an external energy source (an electrical current). I know that the reduction of hydrogen takes place on the cathode and the oxidation reaction takes place on the anode. I also know that water, already partially split into H^+ and OH^- (though there are very few of these ions in pure water).

1. Electric current (direct current) electrolyzes water. Discuss this statement.
2. Why alternative current are not used for the same process?

13.4. Electrolysis of concentrated copper (II) sulphate solution using inert electrode

Activity 13.4: Investigating what happens when a solution of copper (II) sulphate is electrolysed using carbon and copper electrodes.

Apparatus and chemicals: Glass cell, Carbon rod, 2M copper (II) sulphate solution, connecting wires, dry cells, copper plates, propanone and litmus paper.

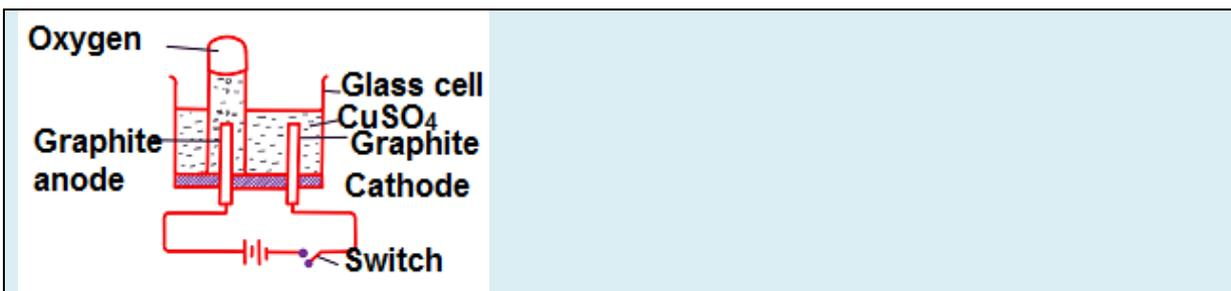

Figure 13.4.1: Electrolysis of copper (II) sulphate solution using carbon electrodes

Procedure:

1. Determine the mass of the graphite rods and record it.
2. Put 0.5M of copper (II) sulphate solution in a glass cell with the carbon (graphite) rods and set up the apparatus. Carefully observe all the changes taking place at the electrodes and the solution. Test the resulting solution with blue litmus paper.
3. After some time, switch off the current, remove the electrodes, wash them in propanone, dry them and then weigh them.
4. Repeat the experiment using clean strips of copper metal as electrodes. Weigh them and then complete the circuit using freshly prepared copper (II) sulphate solution. Record your observations.

Questions:

1. Explain the changes observed during the electrolysis of copper (II) sulphate using :
 - a) Carbon electrodes
 - b) Copper electrodes
2. Outline the changes that occur in the solution from the beginning to the end of the experiment.

The products of electrolysis of copper sulphate solution with inert electrodes (carbon/graphite or platinum) are copper metal and oxygen gas.

Simple apparatus to investigate the electrolysis of aqueous solutions

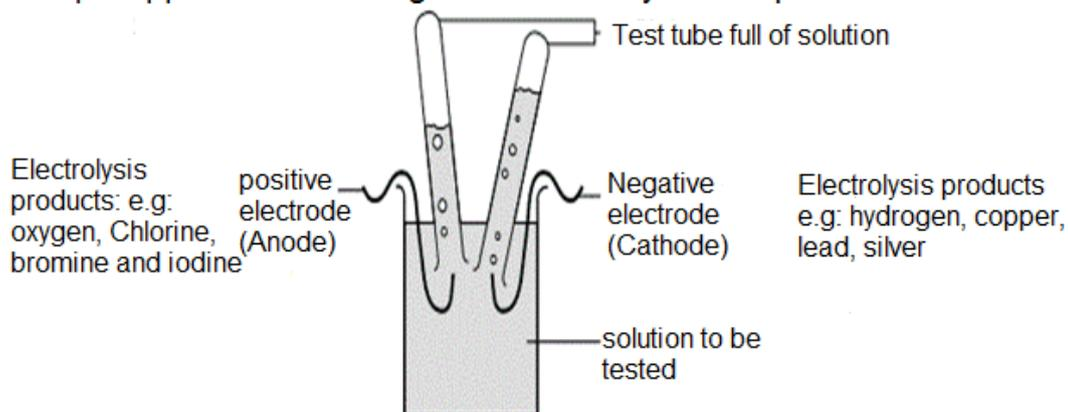

Figure 13.4.1: Simple apparatus to investigate the electrolysis of aqueous solutions

Using the simple apparatus (diagram above) and inert carbon (graphite) electrodes, you can observe the products of the electrolysis of copper sulfate solution are a **copper deposit** on the negative cathode electrode and **oxygen gas** at the positive anode electrode. This anode reaction differs if you use copper electrodes. You have to fill the little test tubes with the electrolyte (dilute copper sulphate solution), hold the liquid in with your finger and carefully invert them over the nearly full electrolysis cell. The simple apparatus (above) can be used with two inert wire electrodes.

The blue colour fades as more and more copper is deposited, depleting the concentration of blue copper ion Cu^{2+} in solution.

Diagram for the electrolysis of copper (II) sulphate solution with carbon electrodes.

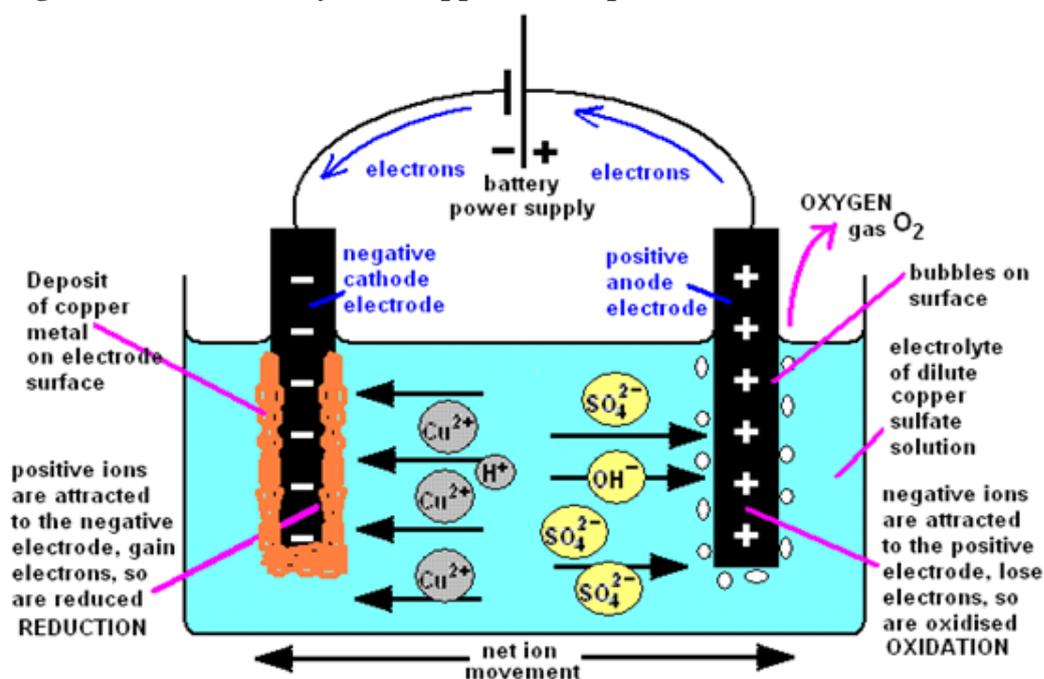

Figure 13.4.2: The electrolysis of copper (II) sulphate solution with carbon electrodes.

The electrode reactions and products of the electrolysis of the electrolyte copper sulphate solution (with inert carbon-graphite electrodes) are illustrated by the diagram above

(a) The electrode products from the electrolysis of copper sulphate with inert graphite (carbon) electrodes

The negative cathode electrode attracts Cu^{2+} ions (from copper sulphate) and H^+ ions (from water). Only the copper ion is discharged, being reduced into copper metal. The less reactive a metal, the more readily its ion is reduced on the electrode surface.

A copper deposit forms as the positive copper ions are attracted to the negative electrode (cathode)

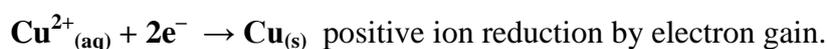

The traces of hydrogen ions are not discharged, so you do not see any gas collected above the negative electrode. The blue colour of the copper ion will fade as the copper ions are converted into the copper deposit on the cathode

At the positive anode reaction with graphite electrodes

Oxygen gas is formed at the positive electrode, an oxidation reaction (electron loss).

The negative sulphate ions (SO_4^{2-}) or the traces of hydroxide ions (OH^-) are attracted to the positive electrode. But the sulphate ion is too stable and nothing happens. Instead hydroxide ions are discharged and oxidised to form oxygen.



negative ion oxidation by electron loss



molecule oxidation by electron loss

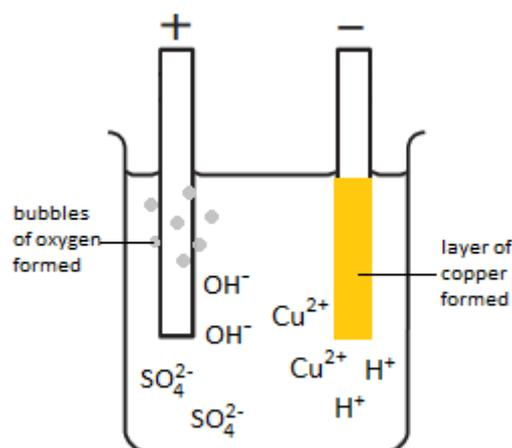
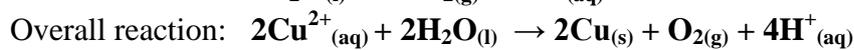
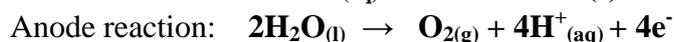
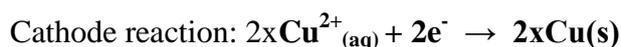

Figure 13.4.3: Electrolysis of copper(II) sulphate

Checking up 13.4

1. Name the product at the cathode and anode during electrolysis of:
 - a) Molten lead bromide with inert electrode.
 - b) Acidified copper sulphate solution with inert electrodes.
 - c) Acidified water with inert electrode.
 - d) Dilute hydrochloric acid with inert electrode.
 - e) Concentrated hydrochloric acid with inert electrode.

2. Predict the products formed when the following molten compounds are electrolysed using carbon electrodes;
- Lead(II) bromide
 - Magnesium oxide

13.5. Electrolysis of concentrated copper (II) sulphate solution using copper electrodes

The products of electrolysis of copper sulfate solution with copper electrodes are copper metal and copper ions (the copper anode dissolves).

The electrolysis of copper (II) sulphate solution using copper electrodes is shown below.

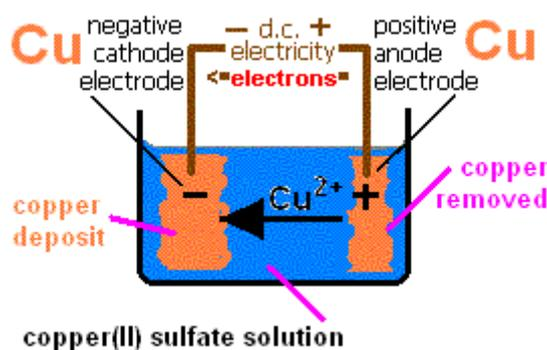

Figure 13.5.1: Electrolysis of copper (II) sulphate

Using the simple apparatus and two copper electrodes the products of the electrolysis of copper sulphate solution are **a copper deposit** on the negative cathode electrode and **copper dissolves**, Cu^{+2} , at the positive anode electrode. This copper anode reaction differs from the one when you use an inert graphite electrode for the anode.

When Copper (II) sulphate is electrolysed with a copper anode electrode (the cathode can be carbon or copper), the copper deposit on the cathode (–) equals the copper dissolves at the anode (+). Therefore the blue colour of the Cu^{2+} ions stays constant because Cu deposited = Cu dissolved. Both involve a two electron transfer so it means mass of Cu deposited = mass of Cu dissolving for the same quantity of current flowing (flow of electrons). You can check this out by weighing the **dry** electrodes before and after the electrolysis has taken place.

The experiment works with a carbon anode and you see the blackness of the graphite change to the orange-brown colour of the copper deposit.

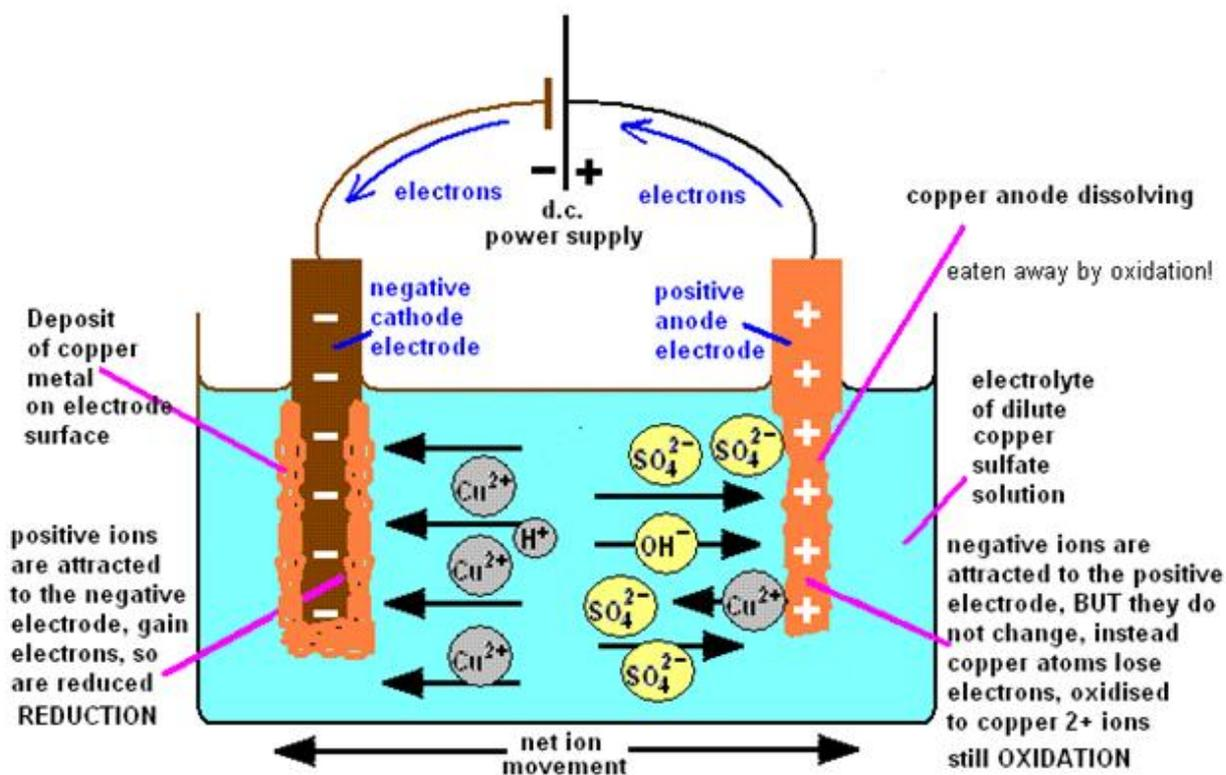

Figure 13.5.2: The electrolysis of copper (II) sulphate solution with a copper anode and a copper cathode.

The electrode reactions and products of the electrolysis of copper sulphate solution (with a copper anode) are illustrated by the diagram above.

(b) The electrode products from the electrolysis of copper sulphate with copper electrodes

The negative cathode electrode attracts Cu^{2+} ions (from copper sulphate) and H^+ ions (from water). Only the copper ion is discharged, being reduced to copper metal. A **reduction** electrode reaction at the negative cathode: $\text{Cu}^{2+}_{(\text{aq})} + 2\text{e}^- \rightarrow \text{Cu}_{(\text{s})}$ (copper deposit, reduction 2 electrons gained) reduction by electron gain

The positive anode reaction with copper electrodes

It's the copper anode that is the crucial difference than electrolysing copper sulphate solution with an inert carbon (graphite) or platinum electrode.

The negative sulphate ions SO_4^{2-} (from copper sulphate) or the traces of hydroxide ions OH^- (from water) are attracted to the positive electrode. But both the sulphate ion and hydroxide ion are too stable and nothing happens to them because the copper anode is preferentially oxidised to discharge Cu^{2+} copper ions.

An **oxidation** electrode reaction at the positive anode: copper dissolves, two electrons are lost following the half reaction:

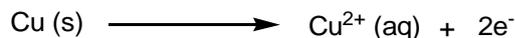

Copper atoms oxidised to copper (II) ions: dissolving of copper in its electrolytic purification or electroplating (must have positive copper anode).

Copper (II) ions reduced to copper atoms: deposition of copper in its electrolytic purification or electroplating using copper (II) sulphate solution, so the electrode can be copper or other metal to be plated or any other conducting material.

This means for every copper atom that gets oxidised, one copper ion is reduced, therefore when copper electrodes are used in the electrolysis of copper sulphate solution, the mass loss of copper from the positive anode electrode should equal to the mass of copper gained and deposited on the negative cathode electrode.

You can show this by weighing both electrodes at the start of the experiment. After the current has passed for some time, carefully extract the electrodes from the solution, wash them, dry them and reweigh them. The gain in mass of the cathode should be the same as the loss of mass from the anode.

Checking up 13. 5

- Predict the products formed (i) at the cathode, (ii) at the anode, when copper (II) sulphate solution is electrolysed using carbon electrodes.
 - Describe the colour changes in the electrolyte.
- What will you observe
 - At cathode
 - At anode
 - In electrolytic, during the electrolysis of copper (II) sulphate solution with copper electrode.
- Write equations for the reaction taking place at cathode and at anode during the electrolysis of:
 - Acidified copper sulphate solution with copper electrode.
 - Acidified water with inert electrode.
 - Molten lead bromide with inert electrode.
- Using a table, highlight the similarities and differences between using graphite electrodes and copper electrode for the electrolysis of copper sulphate.

13.6. Faraday's Laws

Activity 13.6

Comparison of the amounts of different substances liberated by the same quantity of electricity.

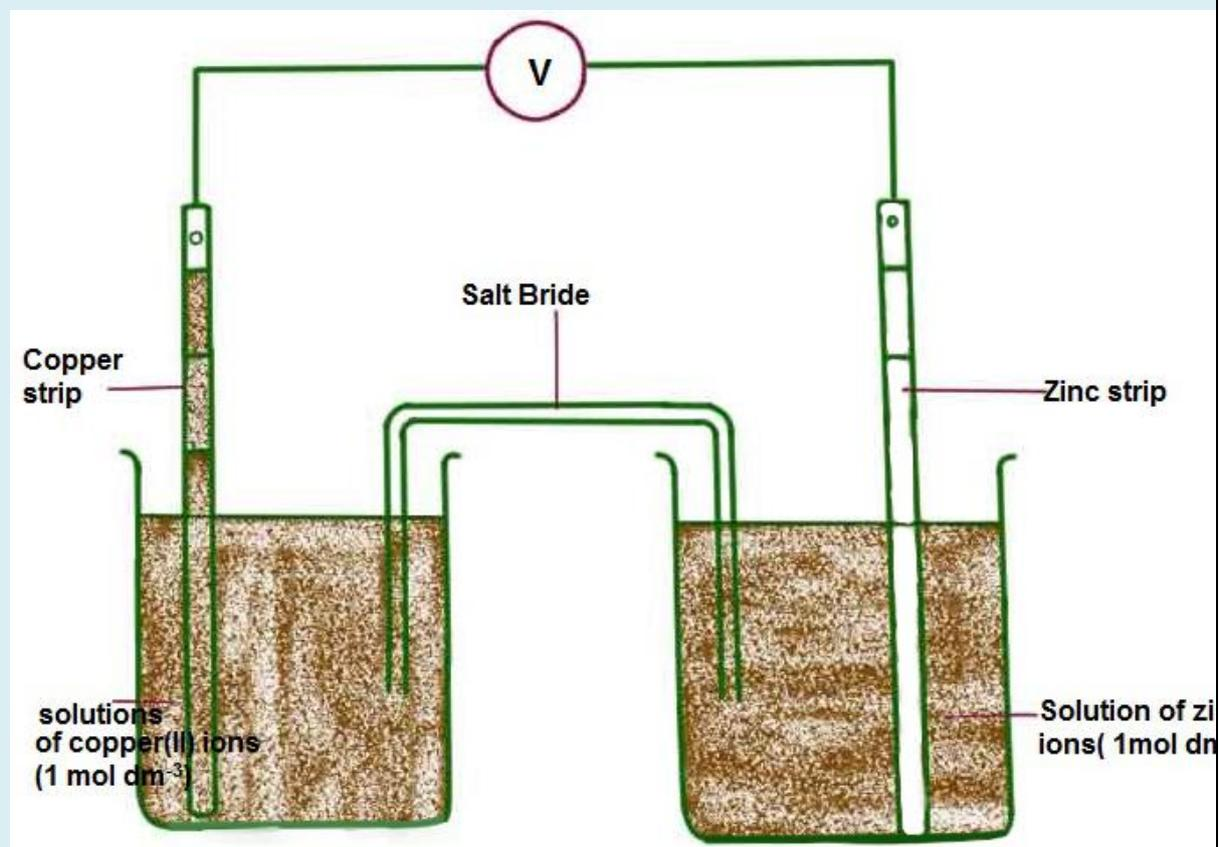

Figure 13.6: Comparison of the amounts of different substance liberated by the same quantity of electricity

Set up the circuit containing a copper voltmeter and a silver voltmeter (a voltmeter is a vessel containing two electrodes immersed in a solution of ions through which a current is to be passed.)

Identify the copper and silver cathodes, clean and dry them, and after weighing them return them in their respective voltmeters. Pass a current of about 0.5 A for 20 or 30 minutes, after which the cathodes should be removed, cleaned and dried, and reweighed.

Compare the masses of copper and silver deposited. Note that care must be taken in removing the silver cathode from the solution as the metal does not always adhere well to

the cathode.

The relationship between the mass of product formed at an electrode and the quantity of electricity passed through an electrolyte is given by Faraday's laws of electrolysis. Michael Faraday (1791-1867) did the first work on electrolysis and formulated what is known today as **Faraday's laws of electrolysis**.

These laws express the quantitative results of electrolysis. They assert that the amount (expressed in moles) of an element liberated during electrolysis depends upon:

1. The time of passing the steady current, t
2. The magnitude of the steady current passed, I
3. The charge of the ions

13.6.1. Faraday's first law

According to this law, "*The amount of substance liberated at an electrode is directly proportional to the quantity of electricity passed*".

or, $M \propto Q$

Where M = amount of substance liberated in gram.

Q = quantity of electricity passed in Coulomb.

Since $Q = I \cdot t$

Where I = Current in Ampere

and t = time in seconds

Hence $M \propto I t$ or $M = Z \cdot I \cdot t = ZQ$

Where Z = proportionality constant, called **electrochemical equivalent**.

If $I = 1$ ampere and $t = 1$ second then $Z = M$. Therefore electrochemical equivalent may be defined as, ***“The mass of substance (in grams) liberated at the electrode on passing current of 1 ampere for 1 second or on passing 1 coulomb of electricity is called electrochemical equivalent of the substance”***.

$$Z = \frac{\text{Atomic mass}}{n \times 96500} \quad [n = \text{number of electrons exchanged}]$$

$$1F = 96500 \text{ coulomb}$$

So, 1 Faraday [96500 coulomb] of electricity will produce 1 gm equivalent of Ag, Cu and Al at cathode.

13.6.2. Faraday’s second law

According to this law, ***“if same quantity of electricity is passed through different electrolytes, then the amount of substances liberated at the respective electrodes are in the ratio of their equivalent masses”***.

Or

When the same quantity of electricity passes through solutions of different electrolytes, the amounts of the substances liberated at the electrodes are directly proportional to their chemical equivalents.

$$\frac{M_1}{M_2} = \frac{E_1}{E_2}$$

Suppose three cells containing HCl, AgNO_3 and CuSO_4 solutions are connected in series. If the same quantity of electricity is passed through these cells, then the amount of hydrogen, silver and copper deposited at the respective cathodes is in the ratio of their equivalent mass.

Hence,

$$\frac{\text{Amount of substance liberated}}{\text{Equivalent mass of the substance}} = \frac{\text{Mass of copper}}{\text{Equivalent mass of copper}}$$

Equivalent mass is the **mass** of a substance especially in grams that combines with or is chemically **equivalent** to eight grams of oxygen or one gram of hydrogen; the atomic or molecular Mass divided by the valence.

Example: Calculate the amount of electric charge in coulombs which can deposit 5.2g of aluminium when a current was passed through a solution of aluminium sulphate for some time.

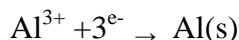
Solution:

3 moles of electrons are needed to deposit 1 mole of aluminium (24g of aluminium)

1g of aluminium is deposited by $\frac{3}{24}$ moles of electrons

5.2g are deposited by $\frac{3}{24} \times 5.2$ moles of electrons

Number of coulombs required = $\frac{3}{24} \times 5.2 \times 96500 \text{ C} = 62725\text{C}$

Checking up 13.6

1. A current of 0.65A was passed through sulphate solution of metal X for 35 minutes between platinum electrodes. If 0.449 g of the metal is deposited at the cathode, calculate the charge on the element X (atomic mass is 63.5)
2. When a constant current was passed through an aqueous solution of copper (II) nitrate for one hour the mass of the copper cathode increased by 15.24 g. Calculate the current in amperes which was used($F = 96500$ $\text{Cu} = 63.5$)

13.7. Factors affecting Electrolysis**Activity13.7: Investigating how the nature of electrodes affects the discharge of ions during electrolysis.****Apparatus and chemicals:**

- Beaker (100 cm³)
- 6V Battery
- 2 connecting wires with crocodile clips
- 2 carbon electrodes
- 2 copper electrodes
- CuSO₄ solution

Caution: Do not allow the electrodes to touch each other while the power supply is switched on, otherwise this may damage the equipment.

A. Electrolysing of copper (II) sulphate solution using Carbon electrodes.

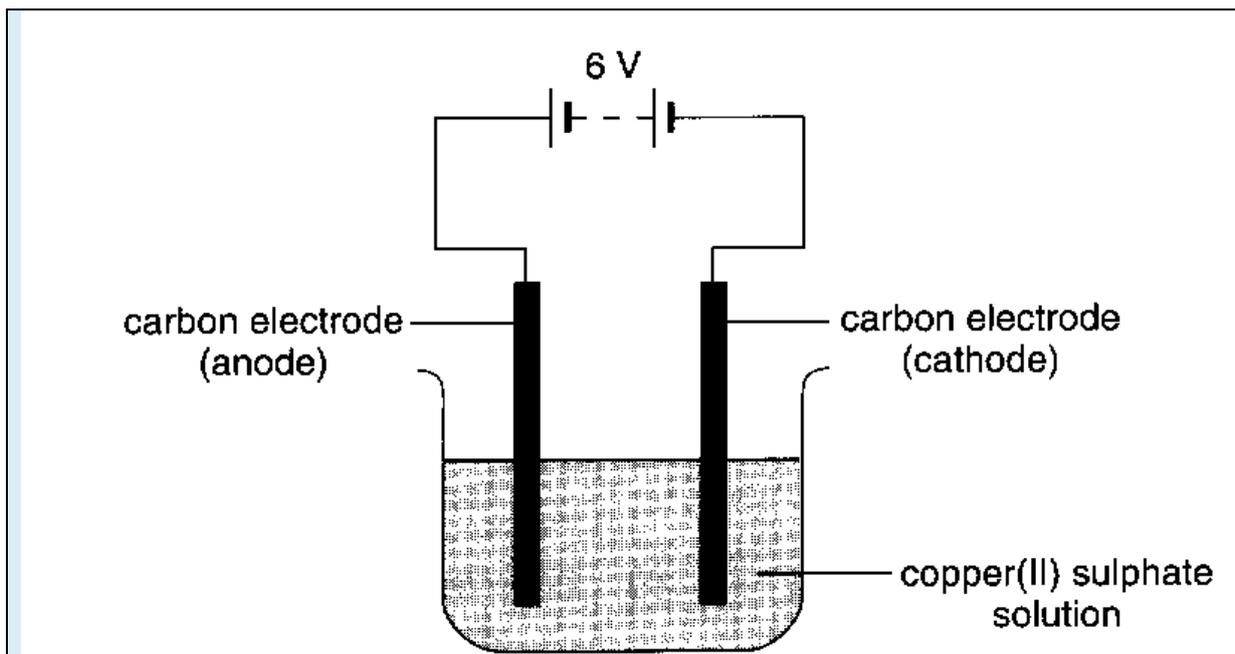

Figure 13.7.1: Electrolysis of copper (II) sulphate solution using carbon electrodes.

Procedure: let the current flow for 5 minutes

Observe what happens at each electrode

Questions:

1. What product is formed on the cathode?
2. What product is formed at the anode?
3. Has the colour of the solution changed?
4. Explain the observations in 3.

B. Electrolysing of copper(II) sulphate solution using Copper electrodes.

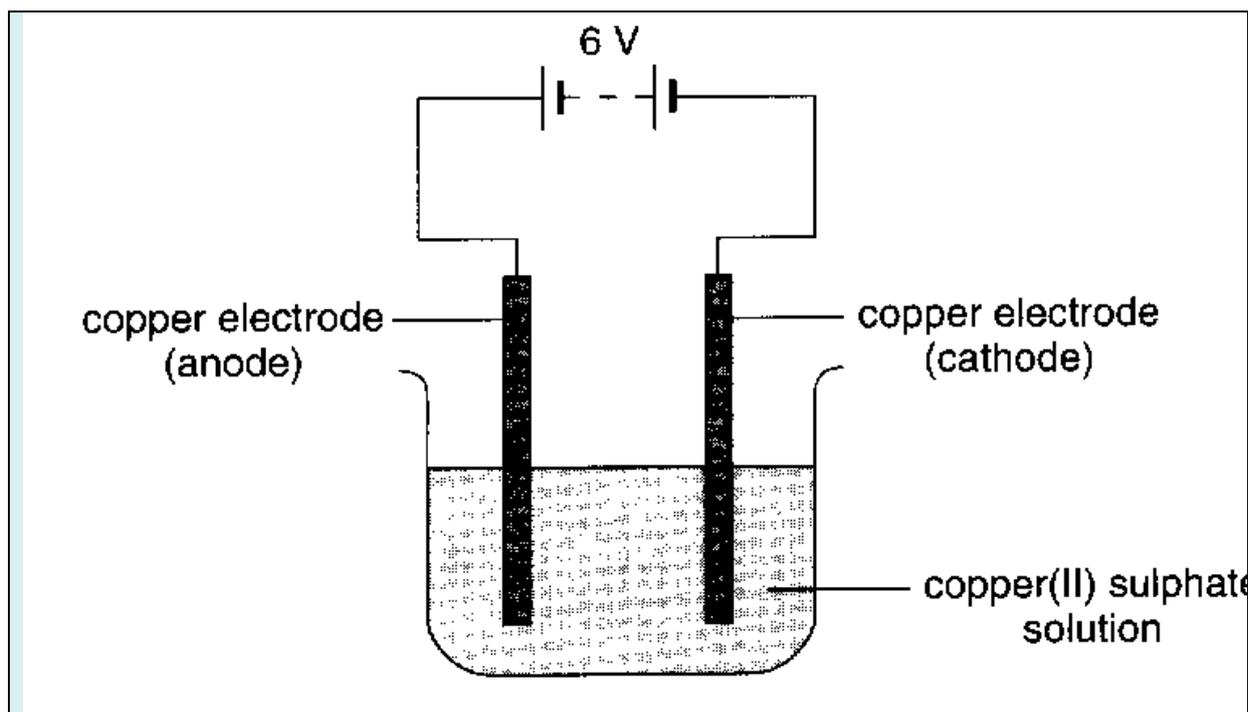

Figure 13.7.2: Electrolysis of copper (II) sulphate solution using copper electrodes

Procedure: let the current flow for 5 minutes

Observe what happens at each electrode

Questions:

1. What product is formed on the cathode?
2. What product is formed at the anode?
3. Has the colour of the solution changed?
4. Explain the observations in 3.

In an electrolysis where there are more than one species which can be discharged at the same electrode, only one of them is discharged at a time; for example, in an aqueous sodium chloride solution, we have four species that is, Na^+ and Cl^- ions from sodium chloride and H^+ and OH^- ions from water.

During electrolysis Na^+ ions and H^+ ions migrate to the cathode while Cl^- ions and OH^- migrate to the anode.

Now the question is, which species of ions will be discharged at the cathode and which ones will be discharged at the anode first?

The factors which decide the selective discharge of ions are:

- Nature of electrodes
- Position of the ion in electrochemical series

- Concentration
- The state of the electrolyte

13.7.1. Nature of Electrodes

In the electrolysis of sodium chloride solution using a platinum cathode, H^+ ions are discharged first in aqueous solution.



However, if the cathode is mercury, sodium is discharged. The sodium atom discharged combines with mercury cathode to form sodium amalgam.

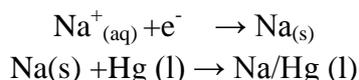

Electrolysis of copper sulphate using copper anode

In this electrolysis, the anions, SO_4^{2-} and OH^- migrate to the anode but none of them is discharged. Instead the copper atoms of the anode ionise and enter the solution.



The copper (II) ions are attracted to the cathode and copper is deposited as a brown layer. The use of platinum anode gives oxygen as the product due to the reaction;



13.7.2. Position of ion in Electrochemical Series

When solving for the standard cell potential, the species oxidized and the species reduced must be identified. This can be done using the activity series. The table 13.2 is simply a table of standard reduction potentials in decreasing order. The species at the top have a greater likelihood of being reduced while the ones at the bottom have a greater likelihood of being oxidized. Therefore, when a species at the top is coupled with a species at the bottom, the one at the top will become reduced while the one at the bottom will become oxidized.

During electrolysis of solution containing a mixture of ions, the ion lower in electrochemical series is discharged first in preference to the one high in the series.

Let us look at the role of water in electrolysis products.

Water molecules to a small extent (degree) ionize as



Due to the above ionization, aqueous solutions of electrolytes contain two sets of ions that is those from the salt dissolved and the H^+ and OH^- ions from water molecules.

Example:

Electrolysis of aqueous copper (II) sulphate solution using platinum electrodes.

Ions present in solution:

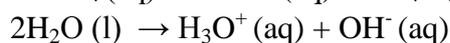
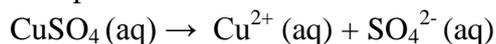

Cathode

Cu^{2+} and H_3O^+ ions migrate to the cathode. Cu^{2+} ions being lower than H_3O^+ ions in electrochemical series are discharged in preference to hydrogen ions.

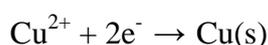

The cathode gets coated with a brown layer of copper as the solution loses its blue colour.

Anode

Hydroxyl ions (OH^-) being lower than sulphate ions (SO_4^{2-}) in the electrochemical series are discharged at the anode. Oxygen is evolved.



13.7.3. Concentration of electrolyte solution

Increase of concentration of an ion tends to promote its discharge, for example in concentrated hydrochloric acid, containing OH^- (from water) and Cl^- as negative ions, the highly concentrated Cl^- is discharged in preference.

However, if the acid is very dilute, some discharge of OH^- will also occur. It is important to know that as the acid is diluted, there will not be a point at which chlorine ceases to be produced and oxygen replaces it. Instead a mixture of the two gases will come off, with the proportion of oxygen gradually increasing.

Another case in which the order of discharge according to the electrochemical series is reversed by a concentration effect is that of sodium chloride solution.

In concentrated solution of sodium chloride called **brine**, the following reactions occur.



At the cathode, the hydroxyl ions OH^- from water are attracted by Na^+ ions to form NaOH solution.

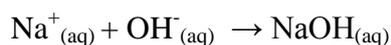

However, when sodium chloride solution is dilute, oxygen and hydrogen are formed in accordance with the electrochemical series.

At the anode: OH^- is oxidized in preference to chloride ions;



At the cathode: H^+ is reduced in preference to sodium ions;

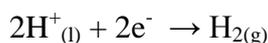

So in the electrolysis of dilute sodium chloride, water is decomposed into its elements rather than NaCl being decomposed. This theory is applied in dilute solutions of the electrolytes such as dilute H₂SO₄, dilute HCl and dilute NaOH.

13.7.4. The state of the electrolyte

The half reactions taking place at the electrode depends on whether the electrolyte is in a molten or an aqueous state, and if in aqueous state its concentration. For example, the electrode reactions that take place during the electrolysis of molten potassium iodide are:

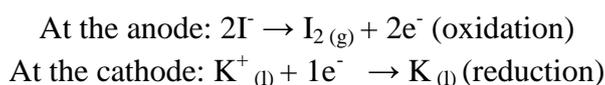

However, if aqueous potassium iodide is used, the following electrode reactions take place:

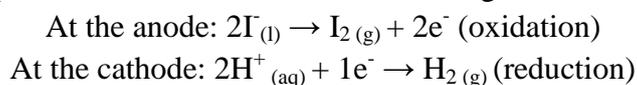

Electrode signs and reactions

Sign	Electrolytic cell		Electrochemical cell	
	Anode	Cathode	Anode	Cathode
	+	-	-	+
Reaction	Oxidation	Reduction	Oxidation	Reduction

Checking up 13.7

QUESTION 1

A student set up the following experiment. How would the rate of electrolysis in beaker 2 compare to that in beaker 1?

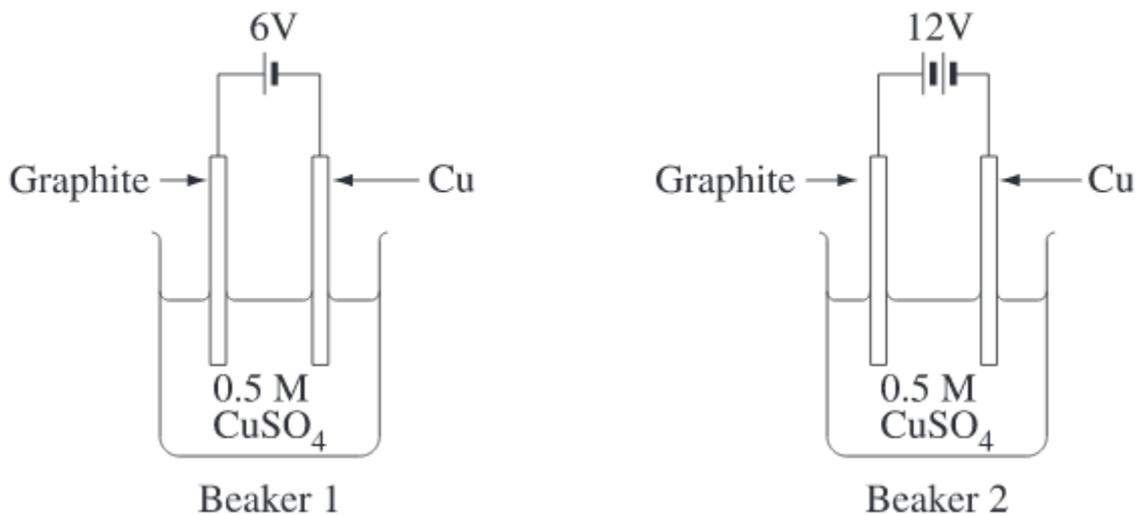

Figure 13.7.3: Experiment

- a) It would be faster
- b) It would be slower
- c) There would be no difference
- d) There is not enough information to answer this question

QUESTION 2

Which of the following factors affect which reactions dominate in an electrolytic cell.

1. Temperature
2. The concentration of reactants
3. The voltage used
4. The nature of the cathode

- A) 1 & 2
- B) 2 & 3
- C) 1,2 & 3
- D) 1,2,3 & 4

Question 3

A university student set up three different electrolytic cells. The substances that were electrolysed were NaCl (l), 0.05 M NaCl (aq) and 5.0 M NaCl (aq). Which of the following statements correctly describes the results of the experiment?

- a) The reactions occurring for the aqueous solutions will produce the same products at the anode and cathode.

- b) Chlorine gas is the major product when molten NaCl (aq) and 0.05 M NaCl (aq) are electrolysed.
- c) The pH at the cathode increases when solutions of NaCl are electrolysed.
- d) The only means by which different products can be produced for varying concentrations of NaCl is to alter the voltage.

13.8. Application of electrolysis

Activity 13.8

Copper-Plated Key

Materials:

- 1.5-volt D battery with battery holder
- Two alligator clip leads or insulated wire
- Beaker or glass
- Copper sulphate
- Copper electrode (or coil of copper wire)
- Brass key
- Safety equipment

Procedure:

1. Prepare the key for copper-plating by cleaning it with toothpaste or soap and water. Dry it off on a paper towel.
2. Stir copper sulphate into some hot water in a beaker until no more will dissolve. Your solution should be dark blue. Let it cool.
3. Use one alligator clip to attach the copper electrode to the positive terminal of the battery (this is now the anode) and the other to attach the key to the negative terminal (now called the cathode).
4. Partially suspend the key in the solution by wrapping the wire lead loosely around a pencil and placing the pencil across the mouth of the beaker. The alligator clip should not touch the solution.
5. Place the copper strip into the solution, making sure it doesn't touch the key and the solution level is below the alligator clip. An electrical circuit has now formed and current is flowing.
6. Leave the circuit running for 20-30 minutes, or until you are happy with the amount of copper on the key.

Question: Observe carefully electrolysis process and records what happened during the electrolysis process.

Electrolysis has a number of important industrial applications. These include the extraction and purification of metals, electroplating and anodizing and the manufacture of other chemicals for example sodium hydroxide (NaOH).

Extraction of metals

Metals in group I and II of the periodic table cannot be reduced by chemical reducing agents; they are extracted from their fused halides by electrolysis. Sodium is obtained by electrolysis of molten sodium chloride in the Dawncell. Magnesium is obtained by electrolysis of $MgCl_2$, generated from dolomite and sea water.

Extraction of aluminium

The chief ore of aluminium is **bauxite**, $Al_2O_3 \cdot 2H_2O$, it contains silica and iron (III) oxide as impurities. Bauxite is dissolved in a strong solution of sodium hydroxide:

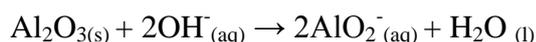

The impurities are not affected by the presence of sodium hydroxide because they are not amphoteric and they are thus filtered off. The solution is diluted, cooled and seed by adding a few crystals of pure $Al(OH)_3$.

On seeding, the aqueous tetrahydroxoaluminate is precipitated as pure $Al(OH)_3$ from the solution:



The precipitate is filtered off, washed, dried and heated strongly $1000^{\circ}C$ to form the pure oxide.

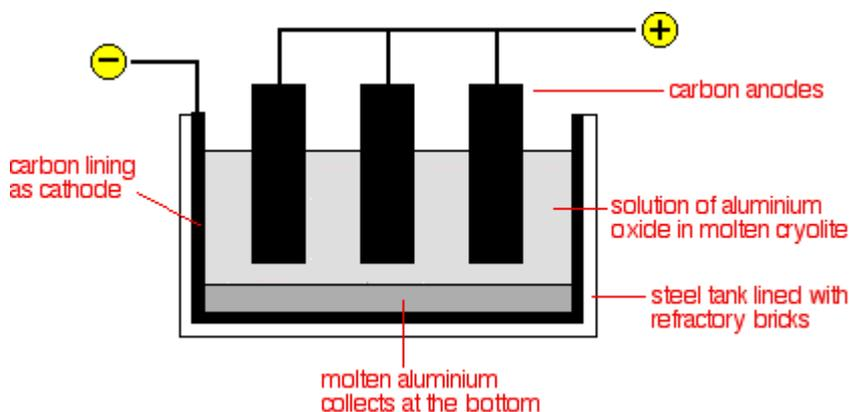
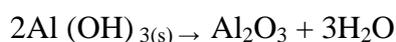

The electrolytic cell is an iron tank lined with carbon, which acts as the cathode. The anodes are blocks of carbon dipped into the electrolyte. The electrolyte is a solution of molten aluminum oxide in molten cryolite. Cryolite acts as a solvent to dissolve aluminium oxide and as an impurity to lower the melting point of aluminium oxide. The electrolytic cell is maintained at around 900°C

Electrodes: Carbon

Ions present in electrolyte: Al^{3+} , O^{2-}

Reaction at cathode: $\text{Al}^{3+}_{(l)} + 3\text{e}^- \rightarrow \text{Al}_{(l)}$

Reaction at anode: $2\text{O}^{2-}_{(l)} \rightarrow \text{O}_{2(g)} + 4\text{e}^-$

Aluminium ions are discharged at the cathode, forming a pool of molten aluminium at the bottom of the tank.

At high temperature, oxygen reacts with the carbon anode to form carbon dioxide gas. Hence, the anodes are slowly burnt away as carbon dioxide gas and needs to be replaced frequently.

Manufacture of NaOH and extraction of Cl_2 and H_2 gas in Downcell

Construction of Down's cell

- Down's cell consists of a rectangular container of steel.
- Inside of the tank is lined with firebricks.
- Anode is a graphite rod which projects centrally up through the base of the cell.
- Cathode is a ring of iron, which surrounds the anode.
- The anode and cathode are separated from each other by a cylindrical steel gauze diaphragm; so that **Na** and **Cl_2** are kept apart.
- A bell like hood is submerged over the anode.

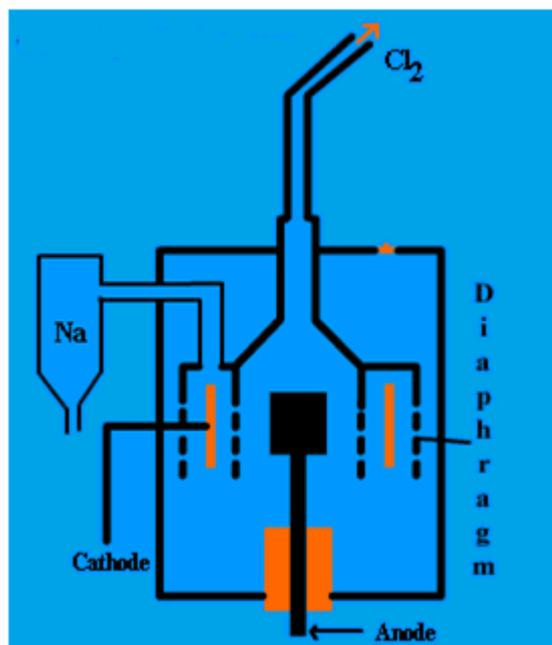
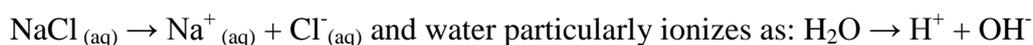

Figure 13.8.1: Down cell

When an electric current is passed through the molten mixture of NaCl and CaCl₂, NaCl decomposes into Na⁺ and Cl⁻ ions. Na⁺ ions migrate towards the cathode while Cl⁻ ions migrate towards the anode. The molten sodium collects in the cathode compartment where it rises to the top and is tapped off by a pipe. Chlorine is collected at the anode.

These are manufactured by electrolysis of concentrated sodium chloride, called brine. Hydrogen is also obtained as a by-product. In solution, sodium chloride ionizes:



Using carbon electrodes, the products of electrolysis are chlorine at the anode and hydrogen at the cathode. Hydrogen is discharged in preference to sodium.

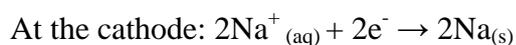

The sodium discharged at the mercury cathode forms a solution of sodium amalgam in mercury. The sodium amalgam is collected in a reservoir in which it reacts with water to form sodium hydroxide solution and hydrogen gas. Mercury is also recovered and returned to the electrolytic cell to pass through the process again.



The sodium hydroxide produced is crystallized. It is used in:

- Manufacture of soap
- The paper industry-wood contains lignin, which is a nitrogenous compound, in addition to cellulose. Wood chips are converted into pulp by boiling the chips with

sodium hydroxide solution to remove the lignin. The digested material is bleached with chlorine.

Purification of metals

Metals such as copper, zinc and aluminium can be purified by electrolysis. The purification of metals is known as **refining**. The copper obtained after the reduction process is not very pure. It contains small amounts of impurities such as iron. This copper is called **blister copper** and is refined by an electrolytic method. It is cast into bars which are used as anodes in acidified copper (II) sulphate solution.

The cathode is made of thin pure copper. During the electrolysis, Cu^{2+} ions are transferred from the anode to the cathode where they are discharged and copper is deposited.

At the anode: $\text{Cu(s)} \rightarrow \text{Cu}^{2+}(\text{aq}) + 2\text{e}^-$ impure copper

At the cathode: $\text{Cu}^{2+}(\text{aq}) + 2\text{e}^- \rightarrow \text{Cu(s)}$ pure copper

The net effect is to dissolve the anode made of impure copper and thicken the cathode (pure copper) with more pure copper.

Electroplating

This is a process of coating a metal with another of interest mainly to prevent it from rusting, or/ and to improve its appearance, for example, in silver plating articles as cake dishes, made of base alloy, for example cupronickel, are made the cathode in plating bath of potassium (or sodium) dicyanoargentate(I), KAg(CN)_2 solution. This contains some silver ions, Ag^+ . The anode is pure silver. When direct current passes, the following reactions occur.

- At cathode: $\text{Ag}^+(\text{aq}) + \text{e}^- \rightarrow \text{Ag(s)}$ (silver deposits)
- At anode: $\text{Ag(s)} \rightarrow \text{Ag}^+(\text{aq}) + \text{e}^-$ (silver dissolves)

In general;

- The metal being coated is made the cathode and the metal coating is the anode
- The solution used is made of the ions of a metal that is coating, so that the anode can dissolve. Anode is the pure plating metal.

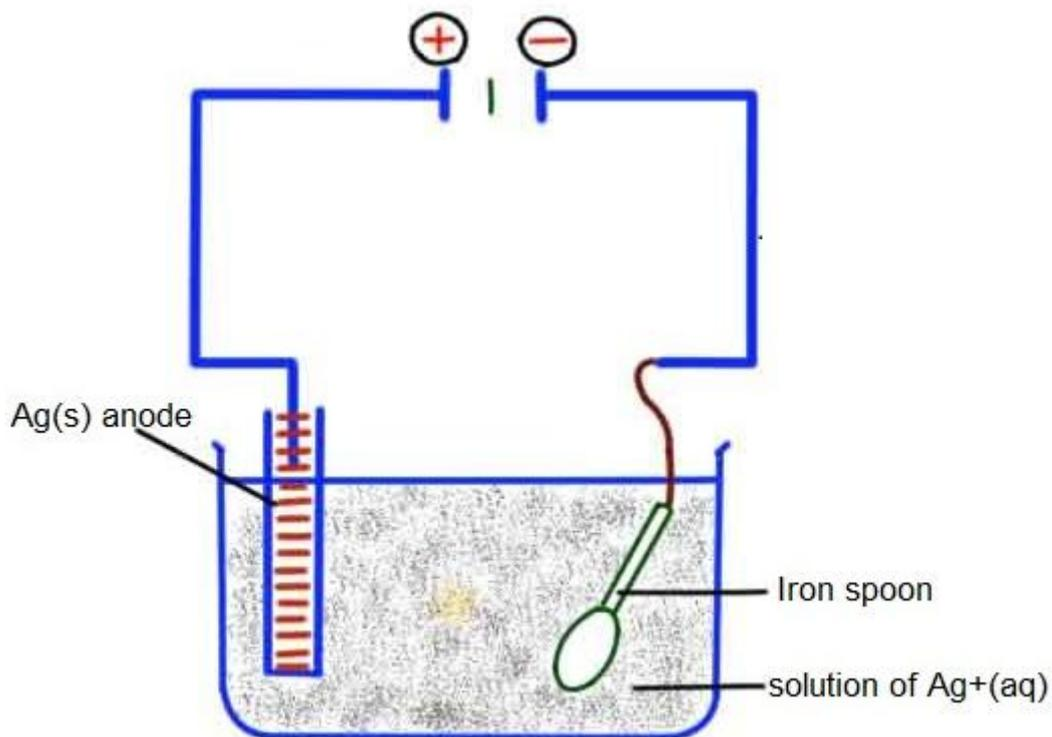

Figure 13.8.2: set up for silver plating spoon

A good electroplating requires steady electric current, appropriate concentration of electrolyte and temperature. The metal to electroplate must be clean.

Checking up 13.8

1. a) What is the difference between electrolytic extraction of a metal and electroplating?
b) Draw a set up used to electroplate a spoon by silver.
2. What is the material for cathode and anode during electro refining of impure copper?
3. Electrometallurgy is the process of reduction of metals from metallic compounds to obtain the pure form of metal.
Given elements: aluminium, lithium, sodium, potassium, magnesium, calcium, Zinc, Iron and copper which ones can be reduced by chemical agents such as carbon and which ones are produced by electrolysis only?

13.9. End Unit Assessment

1. Choose from a list of words and fill in the missing words in the text below:
electrolysis, cathode and anode

When the current passes through an electrolytic solution, ions migrate and electrons are gained or lost by ions on the electrodes surface. Electrode that is positively charged has deficit of electrons is called.....and other negatively charged has excess of electrons is called..... chemical changes at the electrodes due to the passage of electric current are called

2. Answer by true or false
- The Avogadro (1791-1867) did the first work on electrolysis and formulated what is known today as faraday's laws of electrolysis.
 - Electroplating is a process of coating a metal with another of interest mainly to prevent it from rusting, and to improve its appearance.
 - A non electrolyte is a solution or molten compound which cannot be decomposed by an electric current.
 - An ion is an atom or a group of atoms (radical) which has an electric charge.
 - An anode is the negative electrode through which electrons leave the electrolyte and a cathode is the positive electrode through which electrons enter the electrolyte or leave the external circuit.
3. Which of the following involves electrolysis?
- Photosynthesis and Respiration
 - Purification of Copper and Sea Water
 - Purification of copper and extraction of reactive metals
 - Extraction of reactive metals and Respiration
4. Which of the following is not an inert electrode?
- Carbon
 - Copper
 - Platinum
 - Mercury
5. What ions are present in the electrolysis of aqueous Copper (II) Sulfate with Copper electrodes?
- Copper (II) ions, Sulfate ions
 - Hydrogen ions, Oxygen ions, Copper (II) ions
 - Copper (II) ions
 - Hydrogen ions, Hydroxide ions, Copper (II) ions, Sulfate ions

6. What happens during the electrolysis of a diluted sodium chloride solution?
- Hydrogen ions and chlorine ions are discharged.
 - Hydrogen ions and hydroxide ions are discharged.
 - Sodium ion and chlorine ions are discharged.
 - Sodium ions and hydroxide ions are discharged.
7. State three applications of electrolysis on a large scale and describe one of them briefly.
8. Describe how the factor of concentration affects electrolysis.
9. Calculate the amount of electricity required (in Faradays) to deposit one mole of lead ions if a current of 2.5A was passed for 20 minutes through molten lead (II) bromide and 3.20 g of lead metal was deposited.
10. An element X has a relative atomic mass of 88. When a current of 0.5A is passed through the molten chloride of X for 32 minutes and 10 seconds, 0.44 g of X deposited at the electrode.
- Calculate the number of Faradays needed to liberate 1 mol of X.
 - Write the formula of the ion of X ($1F = 96500C$).
11. What volumes of $H_2(g)$ and $O_2(g)$ at STP are produced from the electrolysis of water by a current of 2.50 A in 15.0 min?
12. What volume of F_2 gas, at $25^\circ C$ and 1.00 atm, is produced when molten KF is electrolyzed by a current of 10.0 A for 2.00 h? What mass of potassium metal is produced? At which electrode does each reaction occur?
13. Electrolysis of an alkaline earth metal chloride using a current of 5.00 A for 748 s deposits 0.471 g of metal at the cathode. What is the identity of the alkaline earth metal chloride?
14. An unknown metal M is electrolyzed. It took 74.1 s for a current of 2.00 A to plate out 0.107 g of the metal from a solution containing $M(NO_3)_3$. Identify the metal.
15. It took 2.30 min using a current of 2.00 A to plate out all the silver from 0.250 L of a solution containing Ag^+ . What was the original concentration of Ag^+ in the solution?

Unit 14: Enthalpy change of reactions

Key unit competency:

To be able to design an experimental procedure to verify the enthalpy changes in a chemical reaction

Learning objectives

- *Define heat of reaction, standard enthalpy change of combustion, enthalpy of neutralisation, enthalpy of solution, enthalpy of hydration and lattice enthalpy*
- *Describe an experimental procedure in determination of heat of combustion*
- *Explain the relationship between quantity of heat produced and mass of substance in combustion reaction*
- *State Hess's law of constant heat summation*
- *State and explain the factors that affect the magnitude of lattice energy*
- *Describe bond breaking as endothermic and bond making as exothermic*
- *Develop practical experimental skills about enthalpy changes of reactions, interpreting results and drawing valid conclusions.*
- *Carry out practical activities to determine enthalpy change of reactions (enthalpy change of combustion of ethanol, enthalpy change of neutralization).*
- *Calculate the enthalpy change of combustion, neutralization and dissolution from experimental data*
- *Deduce how Hess's law is applied to Born-Haber cycle.*
- *Construct Hess's energy cycles and Born-Haber cycles from data obtained experimentally or provided.*
- *Calculate the enthalpy changes of reactions using Hess's law.*
- *Use the standard bond energy to determine the standard enthalpy of reaction.*
- *Relate the heat of hydration and lattice energy to heat of solution.*
- *Respect of procedure during experiments of combustion and neutralization.*
- *Appreciate the contributions of other scientists such as Hess, Born and Haber's work.*

Introductory activity

Observe the pictures below, analyze them and answer the questions that follow.



Airplane in flight



Cooking stove



Burning wood



Functioning of a vehicle's engine



Spacecraft launching



Bunsen burner

- 1) What is the origin of the energy used for the flight of airplanes, the functioning of vehicle's engines or some machines used in factories, launching of spacecrafts, energy used by our bodies, the energy released by a burning wood, Bunsen burner or a burning match or an exploding dynamite, etc?
- 2) What are the chemical reactions that are involved in the processes above?
- 3) How the energy used may be determined?

14.1. Definition of standard enthalpy of different reactions

Activity 14.1

Referring to the concept of energy changes and energy profile diagrams for chemical reactions:

- 1) Recall the definition of:
 - a) enthalpy change
 - b) thermochemical equation
- 2) State the rules governing thermochemical equations.
- 3) By conducting your own research, differentiate the types of enthalpy change of reactions.

In thermodynamics, it is shown how energy, work, and heat are related. Every chemical reaction occurs *with a concurrent change in energy*. Before to embark the explanation of these chemical changes, some key terms have to be defined as follows.

(i) Enthalpy change (ΔH)

In thermodynamics, the heat of reaction also known as enthalpy of reaction is the change in the enthalpy (H) of a chemical reaction that occurs at a constant pressure. Enthalpy, H is a state function used to describe the heat changes that occur in a reaction under constant pressure. It is a state function as it is derived from pressure, volume, and internal energy, all of which are state functions. The enthalpy is a measurement of the amount of energy per mole either released or produced in a reaction.

When a reaction is taking place in an open container, a quantity of heat which is proportional to the quantity of the matter present, will be released or absorbed.

The flow of heat is the **enthalpy change** noted ΔH . The units of ΔH are kJ/mol or kcal/mol.

(ii) Thermochemical equation

A thermochemical equation is a balanced equation that includes the amount of heat exchanged (produced or absorbed).

Examples

$\text{NH}_4\text{NO}_3 (s) + 25 \text{ kJ} \rightarrow \text{NH}_4\text{NO}_3 (aq)$, 25 kJ is the energy absorbed for the reaction to take place.

$\text{NaOH}(s) \rightarrow \text{NaOH}(aq) + 44.2 \text{ kJ}$, 44.2 kJ is the energy released by the reaction.

Another way to express the heat change is the use of ΔH notation; the heat change for the system is shown outside the equation.

Examples

$\text{NH}_4\text{NO}_3(s) \rightarrow \text{NH}_4\text{NO}_3(aq) \quad \Delta H = +25\text{kJ/mol}$

$\text{NaOH}(s) \rightarrow \text{NaOH}(aq) \quad \Delta H = -44.2\text{kJ/mol}$

The rules of enthalpy change of reaction:

- a) The enthalpy change of a reaction is proportional to the amount of reactants that are involved in the reaction.

Examples: $2\text{NO} (g) \rightarrow \text{N}_2 (g) + \text{O}_2 (g) \quad \Delta H = -180 \text{ kJ}$

$6\text{NO} (g) \rightarrow 3\text{N}_2 (g) + 3\text{O}_2 (g) \quad \Delta H = -540 \text{ kJ}$

- b) In a chemical reaction, reversing a reaction automatically changes the sign of ΔH .

Example:

For the reaction: $\text{N}_2 (g) + \text{O}_2 (g) \rightarrow 2\text{NO} (g)$, its enthalpy change is $\Delta H = +180 \text{ kJ}$

If the reaction is reversed, we have:

$2\text{NO} (g) \rightarrow \text{N}_2 (g) + \text{O}_2 (g)$ and the enthalpy change becomes $\Delta H = -180 \text{ kJ}$

- c) The enthalpy change of a reaction depends on the physical states of the reactants and the products.

Example

$\text{CH}_4(g) + \frac{1}{2} \text{O}_2(g) \rightarrow \text{CO}_2(g) + \frac{1}{2} \text{H}_2\text{O}(l) \quad \Delta H = -890.4 \text{ kJ/mol}$

$\text{CH}_4(g) + \frac{1}{2} \text{O}_2(g) \rightarrow \text{CO}_2(g) + \frac{1}{2} \text{H}_2\text{O}(g) \quad \Delta H = -802.4 \text{ kJ/mol}$

(iii) Types of enthalpy changes

There are various types of enthalpy change. Some examples of the types of enthalpy changes are given below.

a) The enthalpy of formation (ΔH_f) of a substance is the heat change (heat released or absorbed) for the chemical reaction in which one mole of the substance is formed from its constituent elements under given conditions of temperature T and pressure P.

The **standard enthalpy of formation (ΔH_f°)** of a substance is the change in enthalpy for the reaction that forms one mole of the substance from its elements in their most stable form with all reactants and products at the pressure of 1 atm and usually at the temperature of 298 K.

Note: For any element in its stable state at 1 atm and 298 K, $\Delta H_f^\circ = 0$

The Standard conditions are:

Pressure = 1 atmosphere (1 atm)

Temperature = 25 °C = 298 K (remember that 0 °C = 273 K).

The concentration of solutions = 1 mol/dm³.

The **standard enthalpy change of a reaction ΔH_r°** is the enthalpy change that occurs in a system when matter is transformed by a given chemical reaction when all reactants and products are taken in their standard states (at 1 atm and 298 K).

Consider a general reaction:

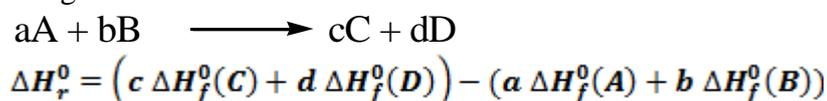

The standard enthalpy change for any reaction can be calculated from the standard enthalpies of formation of the reactants and the products in the reaction:

$$\Delta H_r^\circ = \sum n \Delta H_f^\circ(\text{products}) - \sum m \Delta H_f^\circ(\text{reactants})$$

Example:

Determine the enthalpy of the reaction: $3\text{Fe}_2\text{O}_3(\text{s}) + \text{CO}(\text{g}) \rightarrow 2\text{Fe}_3\text{O}_4(\text{s}) + \text{CO}_2(\text{g})$ using the following data.

Species	ΔH_f° (kJ/mol)
$\text{Fe}_2\text{O}_3(\text{s})$	-824
$\text{CO}(\text{g})$	-111
$\text{Fe}_3\text{O}_4(\text{s})$	-1118
$\text{CO}_2(\text{g})$	-394

Answer:

$$\Delta H_r^\circ = [2 \times (-1118) + 1 \times (-394)] - [3 \times (-824) + 1 \times (-111)] = -47 \text{ kJ}$$

b) Enthalpy of combustion

The **enthalpy of the combustion** of a substance (element or compound) ΔH°_c , is the enthalpy change which occurs when one mole of a substance undergoes complete combustion with oxygen in excess at 298 K and 1 atm.

Examples:

Reaction	Standard enthalpy of combustion/ kJmol^{-1}
$\text{C}(\text{graphite}) + \text{O}_2(\text{g}) \rightarrow \text{CO}_2(\text{g})$	-394
$\text{CH}_4(\text{g}) + 2\text{O}_2(\text{g}) \rightarrow \text{CO}_2(\text{g}) + 2\text{H}_2\text{O}(\text{g})$	-890
$\text{H}_2(\text{g}) + \frac{1}{2} \text{O}_2(\text{g}) \rightarrow \text{H}_2\text{O}(\text{l})$	-286
$\text{C}_3\text{H}_8(\text{g}) + 5\text{O}_2(\text{g}) \rightarrow 3\text{CO}_2(\text{g}) + 4\text{H}_2\text{O}(\text{l})$	-2220

c) Enthalpy of neutralization

The **standard enthalpy of neutralization**, ΔH°_n is the enthalpy change which occurs when one gram equivalent of an acid is neutralized by one gram equivalent of a base to produce a salt and water under the standard conditions of temperature and pressure. The equation of the neutralization reaction is: $\text{H}^+(\text{aq}) + \text{OH}^-(\text{aq}) \rightarrow \text{H}_2\text{O}(\text{l})$

Example:

Enthalpy change for the neutralisation of sodium hydroxide by hydrochloric acid is $57 \text{ kJ}\cdot\text{mol}^{-1}$.

The enthalpy of neutralisation is the heat evolved for the reaction between the H^+ ions given by the acid with the OH^- ions given by the base to form one mole of H_2O .

d) Enthalpy of displacement

The **displacement enthalpy** is the enthalpy change of a reaction in which an element displaces another in a chemical reaction.

For example, zinc is more reactive than copper, so when zinc is added to copper (II) sulphate solution, copper is displaced.

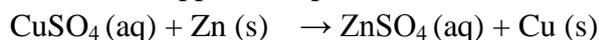

The reaction is associated with an enthalpy change converted into the heat energy equals to 217 kJ mol^{-1} .

e) Enthalpy of solution

The **enthalpy of solution** of a compound is the heat energy change at constant pressure when one mole of a compound is completely dissolved in a specific amount of water as solvent.

However, if a large volume of the solvent is used till further addition of the solvent does not produce any more heat change it is called **enthalpy of solution at infinite dilution**. The symbol **(aq)** is used to represent the solvent at large dilution.

Examples:

The enthalpy of solution of sodium chloride solid:



The enthalpy of solution of calcium fluoride solid ($\Delta H_{\text{sol}} \text{CaF}_2(\text{s}) = +13.4 \text{ kJ}\cdot\text{mol}^{-1}$)

f) Enthalpy of atomisation

The **atomisation enthalpy** ΔH_{at} is the enthalpy change when one of gaseous atoms of the element is formed from the element in its standard state and in standard conditions. The enthalpy change of atomisation is always positive.

For a diatomic molecule, the atomisation enthalpy is equal to a half of the bond dissociation energy.

Examples:

Atomisation energy of sodium, $\Delta H_{\text{at}}(\text{Na}) = +107 \text{ kJ mol}^{-1}$

Atomisation enthalpy of chlorine, $\Delta H_{\text{at}}(\text{Cl}_2) = +122 \text{ kJ mol}^{-1}$

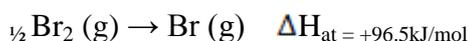
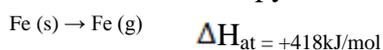

g) Lattice enthalpy

Lattice enthalpy is the enthalpy change that occurs when one mole of an ionic crystal is formed from its gaseous constituents.

Examples:

Lattice enthalpy of sodium chloride, $\Delta H_{\text{LE}}(\text{NaCl}) = -786 \text{ kJ mol}^{-1}$

Lattice enthalpy of magnesium oxide, $\Delta H_{\text{LE}}(\text{MgO}) = -3890 \text{ kJ mol}^{-1}$

h) Hydration enthalpy

Hydration enthalpy is the enthalpy change when one mole of gaseous ions dissolves in sufficient water to give an infinitely dilute solution.

Examples:

Hydration enthalpy of sodium ions, $\Delta H_{\text{(hyd)}}(\text{Na}^+) = -406 \text{ kJ mol}^{-1}$

Hydration enthalpy of chloride ions, $\Delta H_{\text{(hyd)}}(\text{Cl}^-) = -364 \text{ kJ mol}^{-1}$

i) Bond dissociation enthalpy is the needed energy to break a single bond such as N-H in an ammonia molecule.

Examples:

Bond dissociation enthalpy of chlorine, $\Delta H_{\text{dis}}(\text{Cl-Cl}) = +244 \text{ kJ mol}^{-1}$

Bond dissociation enthalpy of oxygen, $\Delta H_{\text{dis}}(\text{O=O}) = +598 \text{ kJ mol}^{-1}$

Checking up 14.1

- 1) Write an equation representing the formation of each of the following compounds from its constituent elements.
 - a) hexane
 - b) nitric acid
 - c) methanol
 - d) potassium bromide
 - e) butanoic acid
- 2) Which of the following reactions do not represent the standard enthalpy of formation?

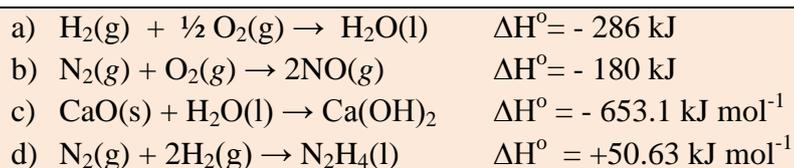

- 3) Write the equations that represent the standard enthalpy of combustion of:
- hydrogen
 - methane
 - sulphur
 - propanol
- 4) Write equations for which the enthalpy of atomisation is measured.
- potassium
 - nitrogen
 - iodine

14.2. Relationship between temperature and heat

Activity 14.2

To investigate the relationship between heat and temperature

Requirements

- Weighing balance
- Thermometer
- Insulated plastic beaker(calorimeter)
- Measuring cylinder
- Sodium hydroxide pellets
- Distilled water

Procedure

- Measure 100mL of water and transfer into the plastic beaker (calorimeter). Record the initial temperature T_1 .
- Weigh 2g of sodium hydroxide pellets and transfer in the beaker containing water. Stir gently with a thermometer and record the highest temperature reached, T_2 .
- Is the reaction exothermic or endothermic?
- Repeat steps 1 through 2 using, 3, 4, 5, 6, 7, 8, 9, 10g of sodium hydroxide pellets and record the results in the table below.

Volume of water/ mL	Initial temperature/ $^\circ\text{C}$	Mass of NaOH/g	Final temperature/ $^\circ\text{C}$	Temperature change
100		2		
		3		
		4		
		5		

		6		
		7		
		8		
		9		
		10		

Interpretation

- Mass of the solution = m
- Change in temperature = ΔT
- Specific heat capacity of the solution $C = 4.18 \text{ J/g}^\circ\text{C}$ (Assumption)
- Relate the rise in temperature to the mass of sodium hydroxide.

Heat is the exchange of thermal energy between the system and the surroundings that results in the temperature difference. Heat flows from matter with high temperature to matter with low temperature until both objects reach the same temperature. The quantity of heat is symbolized by “q”.

When a system absorbs heat its temperature increases. The increase in temperature is directly proportional to the amount of heat absorbed.

The **heat capacity**, C of a substance is the amount of heat required to raise the temperature of a substance by 1°C . The **heat capacity** is expressed in J°C or J/K .

The **molar heat capacity** is the amount of heat energy required to raise the temperature of one mole of a substance by 1°C . It is expressed in Joules per mole per degrees Celsius (or Kelvin), ($\text{J/mol}^\circ\text{C}$ or J/mol. K).

For example, the molar heat capacity of lead is $26.65 \text{ J/mol}^\circ\text{C}$, which means that it takes 26.65 Joules of heat to raise 1 mole of lead by $^\circ\text{C}$.

The **specific heat capacity** is the amount of heat needed to increase the temperature of one gram of a substance by one degree. It is expressed in Joules per gram per degree Celsius ($\text{J/g}^\circ\text{C}$). Water has a very high specific heat, $4.18 \text{ J/g}^\circ\text{C}$.

The high specific heat of water allows it to absorb a lot of heat energy without large increase in temperature keeping ocean coasts and beaches cool during hot seasons. It allows it to be used as an effective coolant to absorb heat.

The relationship between heat and temperature is given by:

$$q = m \times C \times \Delta T$$

Where: q = quantity of heat

m = mass of substance

C = specific heat and

ΔT = change in temperature

Note: Heat capacity, C, can never be negative for a mass or a substance, and similarly the specific heat of a substance can never be negative. Therefore, if the change in temperature is negative, the initial temperature is higher than the final temperature.

The heat capacity of an object depends on its mass: 200 g of water requires twice as much heat to raise its temperature by 1°C than 100 g of water. It also depends on the type of

material: 1000 J of heat energy will raise the temperature of 100 g of sand by 12°C, but only raise the temperature of 100 g of water by 2.4°C.

Checking up 14.2

- 1) Calculate the amount of heat needed to increase the temperature of 250g of water from 20°C to 56°C.
- 2) Calculate the specific heat capacity of copper given that 204.75 J of energy raises the temperature of 15g of copper from 25°C to 60°C.

14.3. Experimental methods for finding the standard enthalpy of combustion reactions

Activity 14.3

To investigate the enthalpy of combustion of ethanol

Requirements

- spirit burner (containing ethanol)
- thermometer
- copper can
- measuring cylinder
- retort stand and accessories
- balance
- breeze shield

Safety precautions

- Ethanol is highly flammable and the main risk is from burns.
- Since a small amount is burned the build-up of any products of incomplete combustion is negligible.
- Wear eye protection.
- Ensure the spirit burner is always sitting in a stable position.
- If you have to re-fill the spirit burner, allow it to cool and then fill it away from sources of ignition.

Procedure

- (1) Weigh the spirit burner (already containing ethanol) with its cap on and record its mass. (The cap should be kept on to cut down the loss of ethanol through evaporation)
- (2) Using the measuring cylinder, measure out 100 cm³ of water into the copper can.
- (3) Set up the apparatus as directed by your teacher.
- (4) Measure and record the temperature of the water.
- (5) Remove the cap from the spirit burner and immediately light the burner.

- (6) Slowly and continuously stir the water with the thermometer.
- (7) When the temperature has risen by about 10 °C, recap the spirit burner, measure and record the maximum temperature of the water.
- (8) Reweigh the spirit burner and record its mass.

Calculations

- a) The heat energy gained by the water (q) can be calculated using the formula:

$$q = c m \Delta T$$
- b) The difference in the initial and final masses of the spirit burner gives us the mass of ethanol burned (say x g) and so the heat energy we calculate is equal to that released by burning x g of ethanol. It is assumed that all the heat energy released by the burning ethanol is absorbed only by the water.
- b) We can work out the mass of one mole of ethanol and knowing how much heat energy is released when x g of ethanol is burned we can calculate the heat energy released when one mole of ethanol is burned. This will be equal to the enthalpy of combustion of ethanol.

A calorimeter is a device used to measure the amount of heat energy exchanged (released or absorbed) in a reaction. If a calorimetry experiment is carried out under a constant pressure, the heat transferred provides a direct measure of the enthalpy change of the reaction. Simple determination of enthalpy of combustion can use a simple calorimeter described by the Figure 14.1 below.

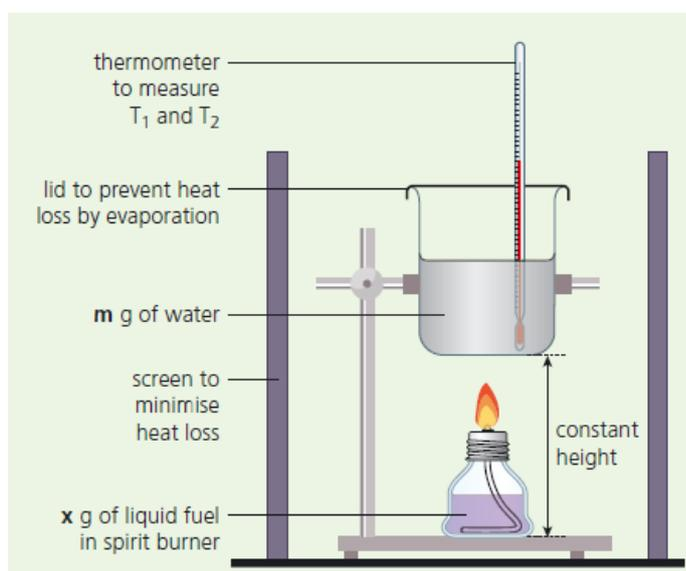

Figure 14.1. Diagram of a simple calorimeter

The energy produced by the combustion of the fuel is used to heat a known mass (m) of water. Therefore, the heat provided by the fuel is equal to the heat received by water. Its amount may be calculated using the relation: $q = m \times C_s \times \Delta T$
 Where: m is the mass of water

C_s is the specific heat capacity of water

ΔT is the temperature change

Knowing the mass of the fuel used, its enthalpy of combustion may be calculated.

Example:

200 cm³ of water were heated by burning ethanol in a spirit burner. The following mass measurements were recorded:

Mass of spirit burner and ethanol (before burning) = 58.25 g

Mass of spirit burner and ethanol (after burning) = 57.62 g

The initial temperature of the water was 20.7 °C and the highest temperature recorded was 41.0°C. The specific heat capacity of water is 4.18 J g⁻¹ K⁻¹.

Calculate the value of the standard enthalpy change of combustion of ethanol in kJ mol⁻¹.

Answer:

$$\Delta T = T_2 - T_1 = 41.0 - 20.7 = 20.3 \text{ }^\circ\text{C}$$

$$m = 200 \text{ g of water}$$

$$x = \text{mass of ethanol burned} = 58.25 - 57.62 = 0.63 \text{ g}$$

$$n = \frac{\text{mass}}{M_m} = \frac{0.64}{46} = 0.01370 \text{ mol}$$

$$q = m \times C_s \times \Delta T = 200 \times 4.18 \times 20.3 = 16970.8 \text{ J}$$

$$\text{Heat energy change per mol of ethanol burned} = \frac{16970.8}{0.01370} = 1,238,744.526 \text{ J mol}^{-1}$$

$$\text{Standard enthalpy of combustion of ethanol is } 1,238.744526 \text{ kJ mol}^{-1}$$

A more accurate method of determining the enthalpy of combustion is the use of a bomb calorimeter (Figure 14.2). It is based on the same principle as the simple experiment involving fuel burners, but it is more accurate because the heat loss is reduced to zero.

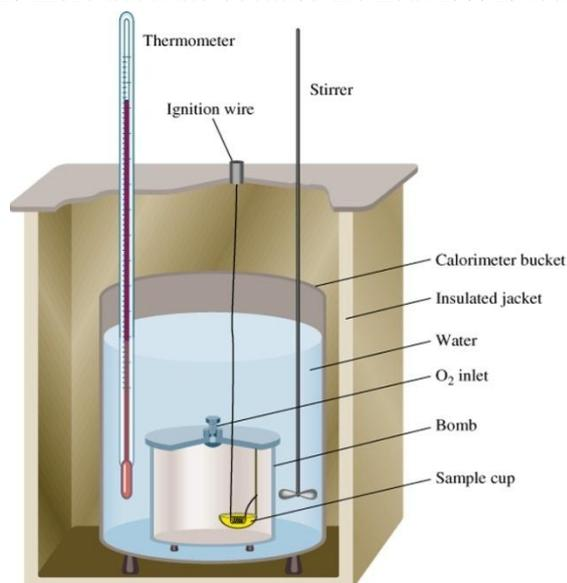

Figure 14.2 Schematic diagram of a bomb calorimeter

In a bomb calorimeter, a sample of a compound is electrically ignited and the heat energy obtained by combustion heats the water in the calorimeter.

Checking up 14.3

- 1) When 0.18 g of hexane underwent complete combustion, it raised the temperature of 100 g (0.1 kg) of water from 22 °C to 47 °C. Calculate its enthalpy of combustion.
- 2) The enthalpy of combustion of benzene is $-3270 \text{ kJ mol}^{-1}$
 - a) How much heat energy will be released if 30 g of C_6H_6 is burned in air?
 - b) How many grams of carbon dioxide will be produced if 8800 kJ heat energy was released?

14.4. Experimental methods for finding the standard enthalpy of neutralisation reactions

Activity 14.4

To investigate the enthalpy of neutralization of hydrochloric acid by sodium hydroxide.

Requirements:

Each group will be provided with:

- 2 plastic beakers
- 50 mL of 1 M HCl
- 50 mL of 1 M NaOH
- Thermometer
- Scale
- Weigh boats

Procedure:

- (1) Weigh an empty plastic beaker. Record the mass.
- (2) With a graduated cylinder, measure 50 mL of 1 M HCl and pour it into the plastic beaker.
- (3) With a thermometer, measure the temperature (T_1) of the HCl.
- (4) Rinse the graduated cylinder and measure 50 mL of 1 M NaOH.
- (5) Measure the temperature (T_2) of the NaOH.
- (6) Pour the NaOH into the plastic beaker and stir gently with the thermometer.
- (7) Record the highest temperature (T_3) that the thermometer reaches.
- (8) Weigh the plastic beaker and the liquid.

Discussion questions

- (1) Was the reaction exothermic or endothermic? How do you know?
- (2) Describe the flow of energy in the system.
- (3) Calculate the amount of heat the reaction gave off using $q = m \times C_s \times \Delta T$ ($C_s = 4.18$)
- (4) Calculate the number of moles of HCl and NaOH that reacted.
- (5) Calculate the molar enthalpy change, ΔH of this reaction
- (6) If the solutions used were more concentrated, would the value of q calculated be higher or lower?
- (7) If the solutions used were more concentrated, is the value of ΔH calculated higher or lower?

Calorimetry is also used to determine the enthalpy change of a reaction taking place in solution. For an exothermic reaction, the heat energy released increases the temperature of the water in solution while for an endothermic reaction, the heat energy absorbed is derived from water in the solution and the temperature of the solution falls.

When hydrochloric acid reacts with sodium hydroxide, the temperature of the mixture rises and the heat is transferred to the plastic beaker, the process is exothermic.

Example:

Consider the results from an experiment similar to the one described above:

The initial temperature: $26.7\text{ }^{\circ}\text{C}$

Final temperature: $33.5\text{ }^{\circ}\text{C}$

Temperature rise, $\Delta T = 33.5\text{ }^{\circ}\text{C} - 26.7\text{ }^{\circ}\text{C} = 6.8\text{ }^{\circ}\text{C}$

The mass of the solution = 100 g

Heat generated is used to heat the solution,

Enthalpy change = mass of the solution \times specific heat capacity \times temperature rise

$$\Delta H = m \times C_s \times \Delta T$$

$$\Delta H = 100 \times C_s \times \Delta T \text{ Joules}$$

But 50mL of 1M HCl has 0.05mol and 50mL of 1M NaOH also has 0.05mol

$$\text{Molar heat of the reaction} = \frac{-100 \times C_s \times \Delta T \text{ joules}}{0.05}$$

$$\Delta H = 2000 \times C_s \times \Delta T \text{ (J mol}^{-1}\text{)}$$

If the solutions used are more concentrated, the temperature increases and the amount of heat exchanged also increases. However, the molar enthalpy of neutralisation remains the same because when the concentration increases, the density increases as well as the number of moles.

$$\text{Heat energy released} = q = m \times c \times \Delta t = 100 \times 4.18 \times 6.8 = 2842.4\text{ J}$$

$$\text{Moles of acid used} = 1\text{ mol dm}^{-3} \times 50 \times 10^{-3} \text{ dm}^{-3} = 0.05 \text{ mol}$$

Molar heat energy released in the neutralisation of 1 mole of the acid:

$$\Delta H_{\text{neut}} = 2842.4 \text{ J} / 0.05 \text{ mol} = 56,848 \text{ J mol}^{-1} = 56.848 \text{ kJ mol}^{-1}$$

The standard enthalpy of neutralisation between a strong acid and a strong base is approximately the same because a strong acid/base is completely dissociated in water.

The overall reaction of neutralization between a strong acid and a strong base is:

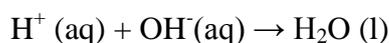

However, the reaction between a strong base and sulphuric acid releases more than $57 \text{ kJ}\cdot\text{mol}^{-1}$. The addition of the base to sulphuric acid results in the dilution of the acid and this process (dilution of H_2SO_4) is exothermic.

The standard enthalpy of neutralisation involving weak acid or weak bases is less than 57 kJ because they are partially dissociated.

For example:



When NaOH is added, the OH^- reacts with H^+ to yield H_2O following the reaction:



The equilibrium will shift to the right side and more HCN will be dissociated. As the dissociation of HCN is endothermic, the total heat evolved will be less than 57 kJ mol^{-1} .

The standard enthalpy of neutralisation of HF (aq) (a weak acid) by a strong base is smaller than -57 kJ . $\text{HF}(\text{aq}) + \text{NaOH}(\text{aq}) \rightarrow \text{NaF}(\text{aq}) + \text{H}_2\text{O}(\text{l})$ $\Delta H = -68.6 \text{ kJ mol}^{-1}$ (*heat released greater than 57 kJ mol^{-1}*) because the dissociation enthalpy of HF is negative due to the high hydration enthalpy of the fluoride ion which has a small radius. Therefore the overall heat evolved is more than 57 kJ mol^{-1} .

Checking up 14.4

- 1) An experiment was conducted to find out the enthalpy of neutralization of a weak acid, HX. 30 cm^3 of 1 M HX solution were mixed with 40 cm^3 of 1 M KOH (in excess) in a polystyrene cup. The temperature in the reaction was $5.0 \text{ }^\circ\text{C}$. Calculate the enthalpy change for the neutralization of the weak acid.
- 2) A student carried out an experiment to determine the enthalpy of the reaction when NaHCO_3 reacts with dilute hydrochloric acid. The student added 3.71 g of NaHCO_3 to 30 cm^3 of 1 M hydrochloric acid (excess) in a polystyrene cup. The temperature of the acid fell by $8.5 \text{ }^\circ\text{C}$. Calculate the enthalpy change of the reaction.

14.5. Hess's law or Law of constant heat summation

Activity 14.5

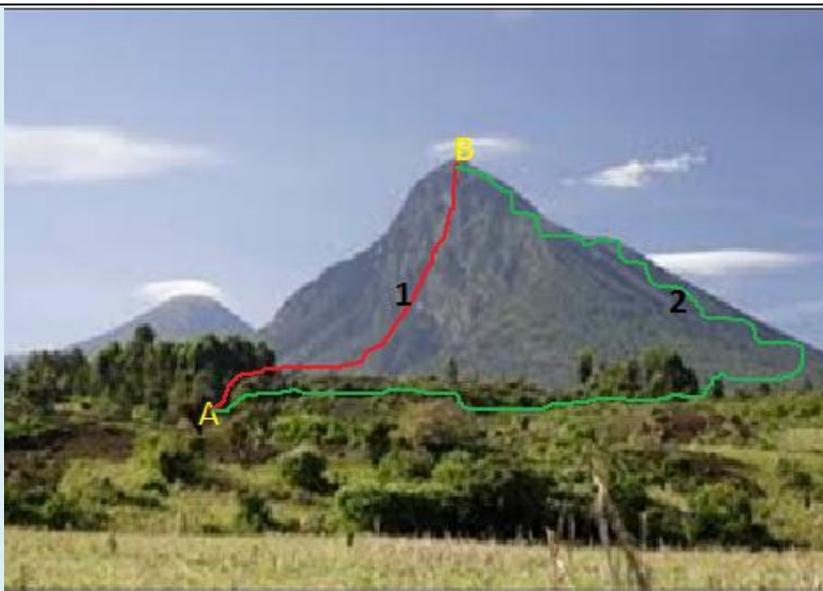

Observe the above image and answer the following questions.

- 1) In which case a person climbing by foot, Karisimbi volcano from point A to point B:
 - a) Travels a greater distance?
 - b) Has more difficulties to reach point B?
- 2) In which case a person who climbs Karisimbi volcano from A to B, the gain in gravitational energy is the highest?
- 3) Can you give a different example to illustrate the same phenomenon?
- 4) What conclusion to draw from the two examples?
- 5) Is any relation between the conclusion and the heat exchanged in a chemical reaction? Illustrate your opinion with examples and come up with a general conclusion.
- 6) Compare your ideas to the first law of thermodynamics.

The increase in gravitational potential energy that occurs when a person climbs from the base to the top of a volcano like Karisimbi or someone who is elevated from the first to the fourth floor of a building is independent of the pathway taken.

That gain in gravitational potential is a state function that is analogous to a thermodynamic state function.

Remember that the enthalpy (heat of reaction) is a state function. This means that a change in enthalpy does not depend on how the change was made, but only on the initial state and final state of the system; it is independent of the pathway.

In 1840, the Russian chemist Germain Henri Hess, a professor at the University of St. Petersburg, discovered from his thermochemical studies that the enthalpy change is a state function. The result from his experiment was known as **Hess's law** or Law of Constant Heat Summation. This law states that "*the heat evolved or absorbed in a chemical process is the same whether the process takes place in one or in several steps*"

In other words, no matter how you go from a given set of reactants to a set of products, the enthalpy change for the overall chemical reaction is the same whether the reaction takes place in one step or in a series of steps.

The enthalpy change is independent of the pathway of the process and the number of intermediate steps in the process.

Hess's law can be illustrated by the following reaction:

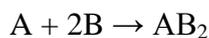

The reaction can be decomposed into two steps. The two steps and the overall process are represented by the following thermochemical equations.

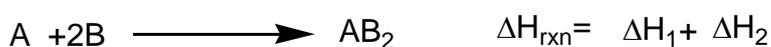

The two processes can be represented in a thermochemical cycle. This diagram is known as the *Hess's principle* (Figure 14.3).

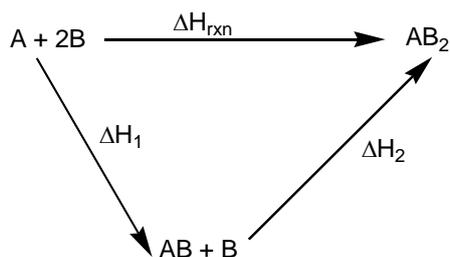
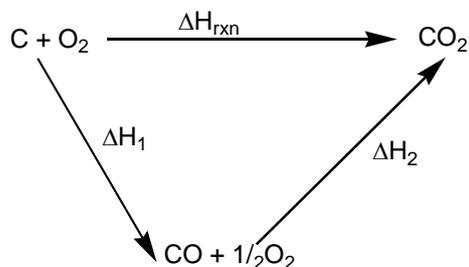

Figure 14.3: Illustration of the Hess's principle

Examples:

1) Determination of the enthalpy change for the complete combustion of carbon.

The direct reaction of carbon with oxygen yields carbon dioxide. However, in the first step carbon gives carbon monoxide which is then oxidised to carbon dioxide during the second step. The two-step reactions corresponding to Hess's law diagram for the formation of carbon dioxide are shown as follows.



According to Hess's law: $\Delta H_{\text{rxn}} = \Delta H_1 + \Delta H_2$

- 2) Determination of the standard enthalpy of formation of propanone, $\text{CH}_3\text{COCH}_3(\text{l})$ given the standard enthalpy changes of combustion of carbon, hydrogen and propanone.

The representation of Hess's law follows the steps below:

- (i) The general reaction is:

$$3\text{C}(\text{s}) + 3\text{H}_2(\text{g}) + \frac{1}{2}\text{O}_2(\text{g}) \rightarrow \text{CH}_3\text{COCH}_3(\text{l})$$
- (ii) Based on Hess's law and the reaction, the enthalpy changes of combustion are given by the following three equations:

$$\text{C}(\text{s}) + \text{O}_2(\text{g}) \rightarrow \text{CO}_2(\text{g}) \quad (1)$$

$$\text{H}_2(\text{g}) + \frac{1}{2} \text{O}_2(\text{g}) \rightarrow \text{H}_2\text{O}(\text{l}) \quad (2)$$

$$\text{CH}_3\text{COCH}_3(\text{l}) + 4\text{O}_2(\text{g}) \rightarrow 3\text{CO}_2(\text{g}) + 3\text{H}_2\text{O}(\text{l}) \quad (3)$$
- (iii) The substances that do not appear in the main or general equation but do appear in the above three equations are $\text{CO}_2(\text{g})$ and $\text{H}_2\text{O}(\text{l})$.
- (iv) These compounds are link substances that allow to draw the following Hess's law diagram.

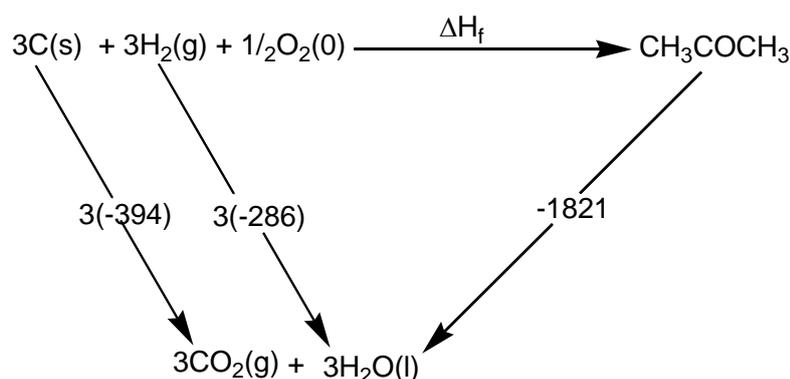

The standard enthalpy of formation of propanone can be calculated from the reactants to $\text{CO}_2(\text{g})$ and $\text{H}_2\text{O}(\text{l})$ and then reversing the combustion reaction of propanone.

Note: The enthalpy change can be calculated by adding equations corresponding to the different combustion to obtain the main equation. Then, the enthalpy change is obtained by addition of the corresponding enthalpy change values multiplied by appropriate coefficient and if necessary, some of them are reversed.

Main equation:

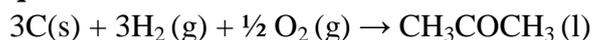

Equation corresponding to the different combustions

3 moles of $\text{C}(\text{s})$ react in the main equation so the first equation is multiplied by 3,

3 moles of $\text{H}_2(\text{g})$ react in the main equation so the second equation is multiplied by 3,

1 mole of propanone is formed in the main equation so the third equation should be reversed.

Checking up 14.5

1) Construct a thermochemical cycle to show how the enthalpy of formation of propan-1-ol may be determined using the combustion enthalpy values of carbon, hydrogen and propan-1-ol.

2) Show how the enthalpy change for the following reaction
 $2\text{S}(\text{s}) + 3\text{O}_2(\text{g}) \rightarrow 2\text{SO}_3(\text{g})$ could be determined using Hess's law.

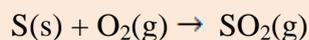

3) Show how the following heat of formation/combustion information can be used to estimate the standard heat of formation of methane CH_4 .

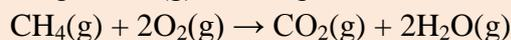
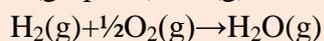
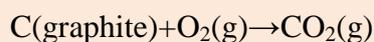

14.6. Application of Hess's law

Activity 14.6

- 1) State the Hess's law?
- 2) Describe how enthalpy of formation of propan-1-ol, hexane, sulphuric acid, can be determined.

The Hess's law can be applied to calculate enthalpies of reactions that are difficult or impossible to measure.

Hess's law states that **if a reaction is carried out in a series of steps, ΔH of the reaction will be equal to the sum of enthalpy changes for the steps provided that the initial and the final conditions are the same.** (Or *the total enthalpy change is independent of the route*).

Examples:

- 1) Calculate the enthalpy for the decomposition reaction of $\text{NaHCO}_3(\text{s})$ using the data in the following table:

Compound	Enthalpy of formation/ kJ mol^{-1}
$\text{Na}_2\text{CO}_3(\text{s})$	- 1131
$\text{NHCO}_3(\text{s})$	948

CO ₂ (g)	394
H ₂ O(l)	286

Answer

Equation of the reaction:

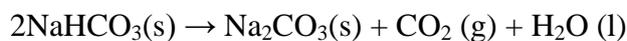

Drawing a cycle using energies of formation

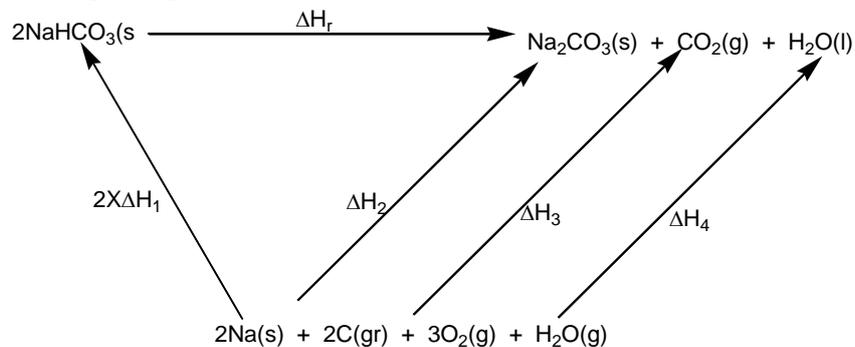

$$2 \times \Delta H_1 + \Delta H_r = \Delta H_2 + \Delta H_3 + \Delta H_4$$

$$\Delta H_r = \Delta H_2 + \Delta H_3 + \Delta H_4 - 2 \times \Delta H_1$$

$$\Delta H_r = -1131 - 394 - (-286) - 2(-948)$$

$$= +85 \text{ kJ mol}^{-1}$$

Alternatively, when using enthalpies of formation the following equation can be used:

$$\Delta H_r^\circ = \sum n \Delta H_f^\circ(\text{products}) - \sum m \Delta H_f^\circ(\text{reactants})$$

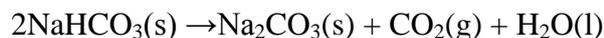

$$\begin{array}{cccc} -943 & & & \\ -1131 & -394 & & -286 \end{array}$$

$$\Delta H_r^\circ = [-1131 + (-394) + (-286) - 2(-948)]$$

$$\Delta H_r^\circ = -1811 - (-1896)$$

$$\Delta H_r^\circ = +85 \text{ kJ mol}^{-1}$$

2) Use the following data and calculate the enthalpy of formation of octane.

Enthalpy of combustion of carbon: - 393.5 kJ

Enthalpy of combustion of hydrogen: - 286 kJ

Enthalpy of octane: - 5471 kJ

Solution

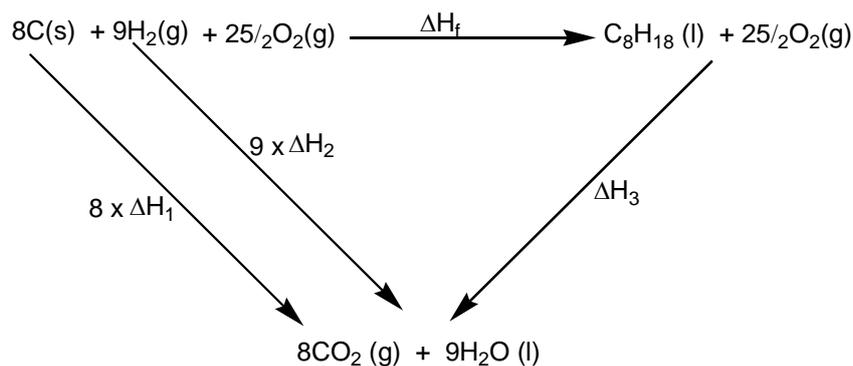

According to Hess's law:

$$8 \times \Delta H_1 + 9 \times \Delta H_2 = \Delta H_f + \Delta H_3$$

$$\Delta H_f = 8 \times \Delta H_1 + 9 \times \Delta H_2 - \Delta H_3$$

$$\Delta H_f = 8 \times (-393.5) + 9 \times (-286) - (-5470) = -251 \text{ kJ mol}^{-1}$$

3) Calculate the enthalpy change for the reaction: $\text{NH}_3\text{(g)} + \text{HBr(g)} \rightarrow \text{NH}_4\text{Br(s)}$ given that the enthalpies (in kJ mol^{-1}) of formation of ammonia, hydrogen bromide, and ammonium bromide are -46, -36, and -271, respectively.

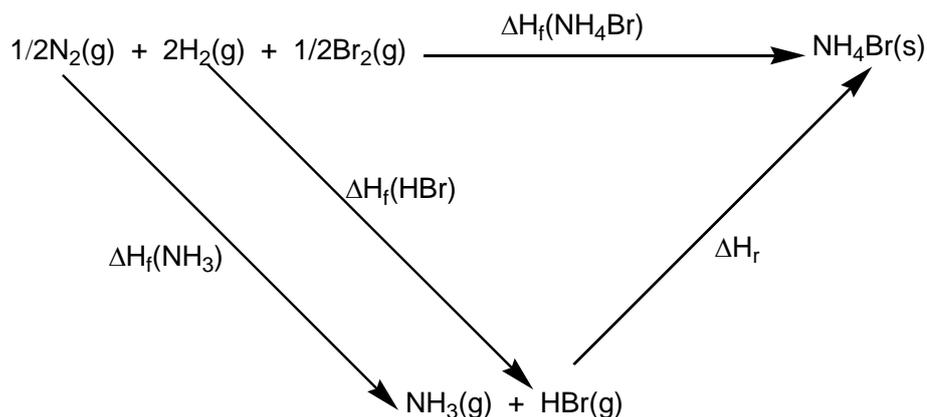

According to Hess's law:

$$\Delta H_f(\text{NH}_3) + \Delta H_f(\text{HBr}) + \Delta H_r = \Delta H_f(\text{NH}_4\text{Br})$$

$$\Delta H_r = \Delta H_f(\text{NH}_4\text{Br}) - \Delta H_f(\text{NH}_3) - \Delta H_f(\text{HBr})$$

$$\Delta H_r = -271 - (-46) - (-36) = -189 \text{ kJ mol}^{-1}$$

Checking up 14.6

1) The standard enthalpy of formation of pentane relates to the equation:

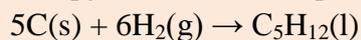

The standard enthalpy changes of combustion for the three substances in the equation are:

C(s)	-394 kJ mol^{-1}
H ₂ (g)	-286 kJ mol^{-1}
C ₅ H ₁₂ (l)	-3509 kJ mol^{-1}

Calculate the standard enthalpy of formation of pentane.

- 2) Use the following data to determine the enthalpy change (ΔH_{rxn}) for the conversion of methanol to formaldehyde and hydrogen.

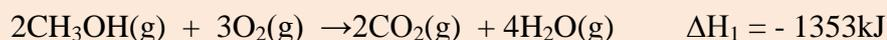

- 3) Enthalpy of hydrogenation of ethene using enthalpy of combustion of ethene and that of ethane using the following data.

Enthalpy of combustion of ethene: -1411 kJ

Enthalpy of combustion of ethane: -1560 kJ

Enthalpy of combustion of hydrogen: -285.8 kJ

- 4) Calculate ΔH for the reaction $4\text{NH}_3(\text{g}) + 5\text{O}_2(\text{g}) \rightarrow 4\text{NO}(\text{g}) + 6\text{H}_2\text{O}(\text{g})$, from the following data.

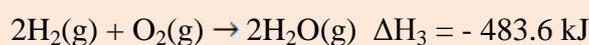

- 5) Find ΔH° for the reaction: $2\text{H}_2(\text{g}) + 2\text{C}(\text{s}) + \text{O}_2(\text{g}) \rightarrow \text{C}_2\text{H}_5\text{OH}(\text{l})$, using the following thermochemical data.

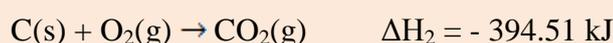
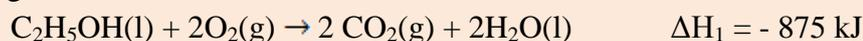

- 6) Calculate ΔH for the reaction $2\text{Al}(\text{s}) + 3\text{Cl}_2(\text{g}) \rightarrow 2\text{AlCl}_3(\text{s})$ from the following data:

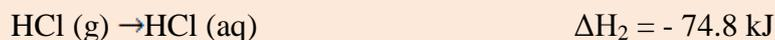
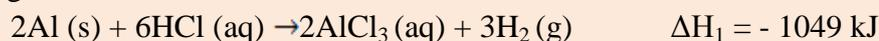

14.7. Lattice enthalpy

Activity 14.7

Referring to what you have learned so far in chemistry, attempt the following questions.

- 1) What is meant by ionic bond?

2) Explain the main steps in the formation of an ionic bond showing clearly the energy change involved in each step.

Lattice enthalpy or **Lattice formation enthalpy** (ΔH_{LE} or (ΔH_{lat})) corresponds to the enthalpy change when one mole of an ionic crystal is formed from its isolated gaseous ions (Figure 14.4).

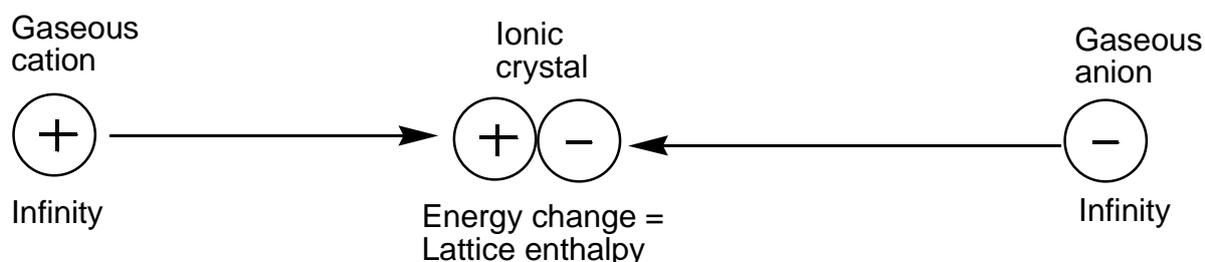
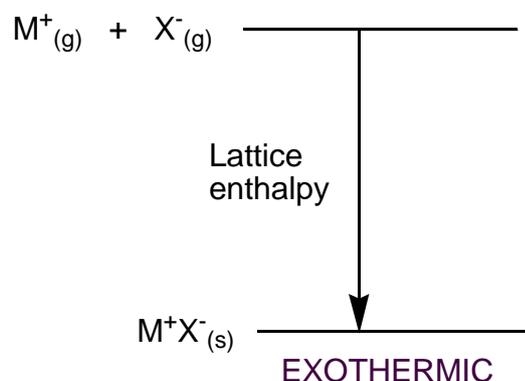

Figure 14.4: Electrostatic attraction between gaseous ions during the formation of an ionic compound

A lot of energy is released as the ionic bond is formed. The reaction is highly exothermic because there are strong electrostatic attractions between ions of opposite charges. The relative values of lattice enthalpy are governed by the charge density of the ions.

Example:

Consider the reaction: $M^+(g) + X^-(g) \rightarrow M^+X^-(s) \Delta H_{LE}$



Examples:



The value of lattice formation enthalpy cannot be measured directly; it is calculated using the Born-Haber cycle. The greater the charge densities of the ions, the more they attract each other and the larger the lattice enthalpy.

The more exothermic the lattice enthalpy, the higher is the melting point.

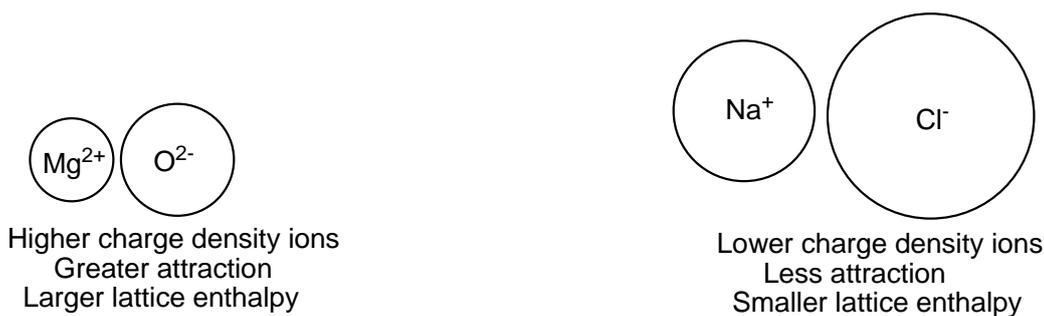
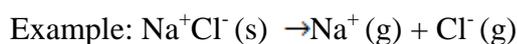
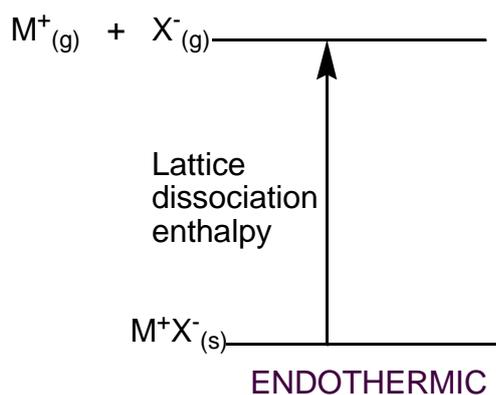

Figure 14.5: Size effect on the lattice enthalpy

The heat exchanged during the reverse process is referred to as **lattice dissociation enthalpy**.

Lattice dissociation enthalpy is the enthalpy change when one mole of an ionic lattice dissociates into isolated gaseous ions. Since there is a strong electrostatic attraction between ions of opposite charge, a lot of energy must be supplied to overcome the attraction.



Thermal stability and lattice enthalpy

Oxides

The thermal stability of Group II oxides decreases down the group as shown in the examples below (Table 14.1).

Table 14.1: Lattice enthalpies of group 2 oxides

	$Mg^{2+}O^{2-}$	$Ca^{2+}O^{2-}$	$Sr^{2+}O^{2-}$	$Ba^{2+}O^{2-}$
Lattice enthalp($kJmol^{-1}$)	-3889	-3513	-3310	-3152
Melting point($^{\circ}C$)	2853	2613	2430	1918

As M^{2+} cationic size increases down the Group, the ionic bonds become weaker, hence, less energy is needed to break the bonds and a low melting point is expected.

Magnesium oxide is used as a refractory lining material in industrial furnaces because it has a high melting point (2853°C). The high melting point is a result of the large lattice enthalpy due to the strong attraction between ions of high charge density.

Carbonates

The thermal stability of group II carbonates increases down the group (Table 14.2).

MgCO_3 decomposes much easier than BaCO_3 , but the lattice enthalpy of MgCO_3 is higher.

Table 14.2: Relationship between lattice enthalpies and melting points for group 2 carbonates

	MgCO_3	CaCO_3	SrCO_3	BaCO_3
Decomposes at	350°C	832°C	1340°C	1450°C
Lattice enthalpy (kJmol^{-1})	-3123	-2814	-	-2556

Mg^{2+} ions are smaller and have a higher charge density; this makes them more highly polarizing. They distort the CO_3^{2-} ions and weaken the attraction between ions and as a result is, the lattice is not as strong.

The decrease in polarising power of the Group I/II metal ions down the group must have a greater effect than the decrease in lattice enthalpy.

Checking up 14.7

- Explain the term "lattice enthalpy"
 - Write the chemical equation for the reaction whose enthalpy represents the lattice enthalpy of:
 - potassium chloride
 - sodium sulphide
- Which of the following substances has a greater lattice enthalpy?
 - NaCl or KCl
 - MgCl_2 or NaCl
 - NaF or NaCl

d) MgO or MgCl₂

14.8. Born-Haber cycle

Activity 14.8

- 1) Refer to the trends in physical properties of chemical elements and chemical bonding, explain each of the following terms.
 - a) Ionization enthalpy
 - b) Electron affinity
 - c) Atomization enthalpy
 - d) Dissociation enthalpy
 - e) Sublimation energy
 - f) Enthalpy of formation
- 2) State the Hess's law.
- 3) Can the Hess's law apply or not to the formation of an ionic compound? Justify your answer using an example.

In the previous sections, the Hess's law and Lattice energy were discussed. Recall that the Hess's law of Constant Heat Summation states that *the enthalpy change is independent of the pathway of the process and the number of intermediate steps in the process.*

Lattice formation enthalpy is the enthalpy change when one mole of an ionic compound is formed from its gaseous ions at the standard temperature and pressure. Because all the bonds in the ionic lattice are broken, it is an endothermic process.

To determine directly the lattice energy of an ionic solid experimentally is not easier.

However, an indirect process known as *Born-Haber cycle* can be used based on Hess's law.

A **Born-Haber cycle** is thermodynamic cycle which relates the lattice energy of an ionic compound to its enthalpy of formation and other measurable quantities. Lattice enthalpies of ionic compounds give a good indication as to the strength of the ionic bonding in the lattice. Born-Haber cycle provides a useful way to account for the relative stabilities of the chemical compounds and the relative stability of the compound is determined by the lattice enthalpy of a compound. The lattice enthalpy of an ionic compound is determined by breaking up the formation of an ionic compound into a series of steps and then, all the steps will be added for the overall reaction. In general, Born-Haber cycles are enthalpy cycles that show how ionic compounds are formed from their elements.

Examples of enthalpy changes that are commonly used in Born-Haber cycles are the following:

- (i) Enthalpy change of formation
- (ii) Atomisation enthalpies
- (iii) Ionisation enthalpy

(iv) Electron affinity

The following diagram represents a general illustration of the Born-Haber cycle.

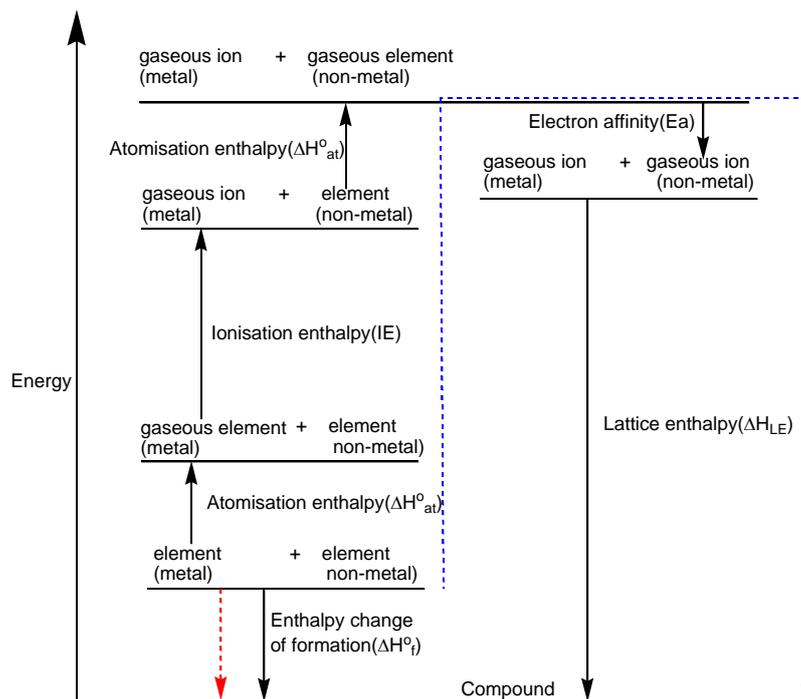

Figure 14.6: Illustration of steps involved in the formation of an ionic compound

The application of Hess's law to this cycle made possible the calculation of the lattice enthalpy.

The arrows pointing upwards represent the endothermic changes while those pointing downwards show the exothermic changes.

From the Born-Haber Cycle, the enthalpy change associated with the route depicted by the red arrow is equal to the enthalpy change of the route shown by the blue arrow.

Examples:

1) *Born-Haber cycle for lithium fluoride*

- To obtain the lattice enthalpy of LiF, solid lithium fluoride is considered as being formed from the elements by two different ways, as shown in the Figure 14.7. In one route, LiF(s) is formed directly from the elements, Li(s) and $\frac{1}{2}$ F₂(g). The enthalpy change for this reaction is ΔH_f , which is equal to - 616 kJ per mole of LiF.
- The second route consists of five steps:
 - (i) *Atomisation (Sublimation of lithium)*: metallic lithium is vaporized to a gas of lithium atoms (atomised). The enthalpy change for this process, measured experimentally, is equal to +159 kJ per mole of lithium.

- (ii) *Atomisation of fluorine*: fluorine molecules are dissociated into atoms. The enthalpy change for F-F bond dissociation energy is + 158 kJ per mole of bonds and the atomisation of fluorine is 79 kJ per mole of F atoms.
- (iii) *Ionization of lithium*: lithium atoms are ionized to Li^+ ions. The enthalpy change is essentially the ionization energy of atomic lithium, which equals +520 kJ per mole of Li.
- (iv) *Formation of fluoride ion*: the electrons from the ionization of lithium atoms are transferred to fluorine atoms. The enthalpy change corresponds to the electron affinity of atomic fluorine and equals - 328 kJ per mole of fluorine atoms.
- (v) *Formation of $\text{LiF}(s)$ from ions*: the ions Li^+ and F^- formed in Steps 3 and 4 combine to give solid lithium fluoride. The enthalpy change is the **lattice energy**. If ΔH_5 is the lattice energy, the enthalpy change for Step 5 is ΔH_5 .

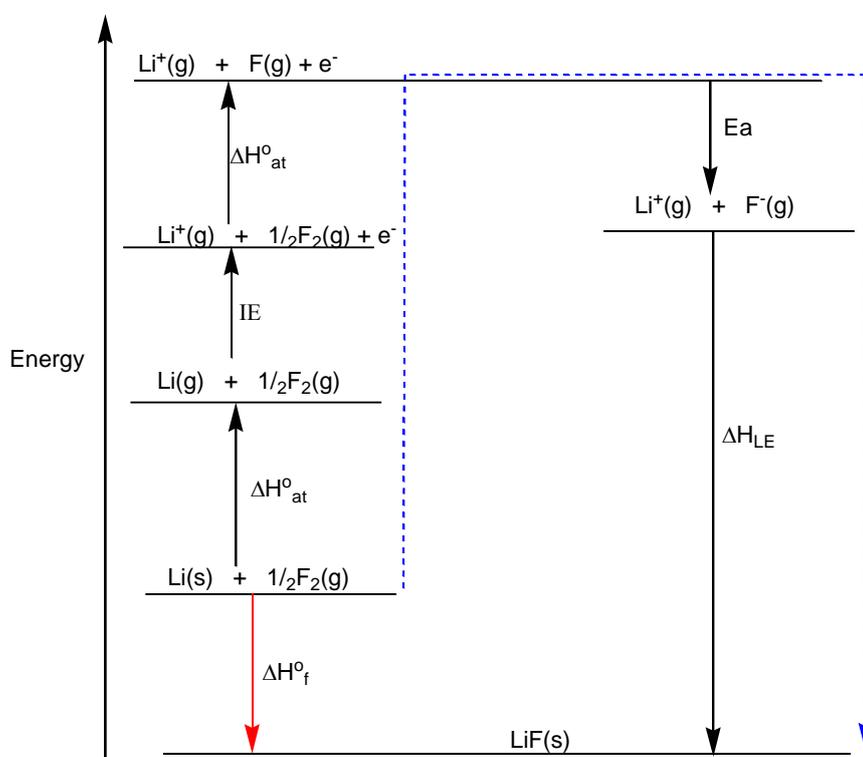

Figure 14.7: The stepwise energy changes for the formation of LiF

2) Born-Haber cycle for magnesium chloride (MgCl_2)

The first and the second ionisation energies of magnesium are needed as magnesium forms a dipositive ion. As two chlorine atoms are involved, atomisation enthalpy values and electron affinity values are doubled.

The Born-Haber cycle for magnesium chloride (MgCl_2) is shown by the Figure 14.8 below.

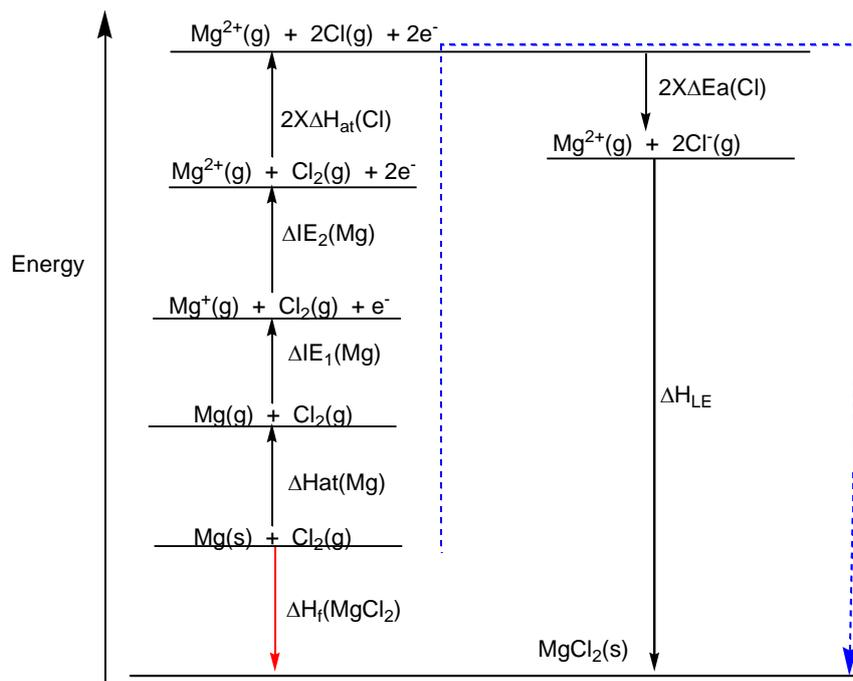

Figure 14.8: The stepwise energy changes for the formation of MgCl_2

3) Born-Haber cycle for potassium oxide (K_2O) is shown in the Figure 14.9

The first electron affinity of oxygen is negative and the second is positive as an electron is being added to an already negatively charged chemical species, explaining an inclination downward at the top of the cycle. Since oxygen form O^{2-} , the sum of the first and the second electron affinities is used and two times the first ionisation energy of potassium is used since 2K^+ are required.

The Born-Haber cycle for potassium oxide (K_2O) is shown in the Figure 14.16

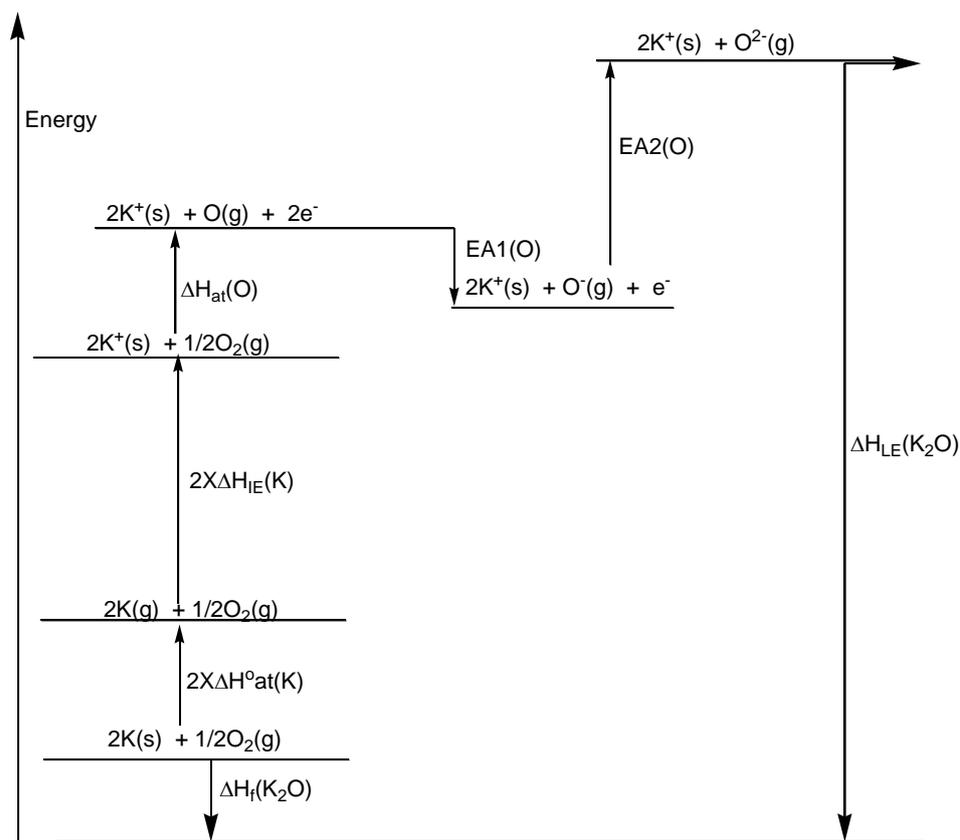

Figure 14.9: The stepwise energy changes for the formation of K_2O

Checking up 14.8

- 1) Construct and interpret a Born-Haber cycle for calcium fluoride showing clearly the enthalpy changes involved.
- 2) a) Write an equation for the standard enthalpy of formation of aluminium oxide.
b) Construct and interpret a Born-Haber cycle for aluminium oxide and explain how it would be used to calculate the lattice enthalpy of aluminium oxide.

14.9. Born-Haber cycle: Calculations of the lattice enthalpy

Activity 14.9

- 1) Construct a Born-Haber cycle for the formation of an ionic compound MX.
- 2) Explain how the cycle can be used to calculate the lattice enthalpy of the compound mentioned in 1).

Examples:

1) **Determining the lattice enthalpy of lithium fluoride using the Born-Haber cycle**

Using the Born-Haber cycle constructed previously for lithium fluoride, its lattice enthalpy can be calculated as follow.

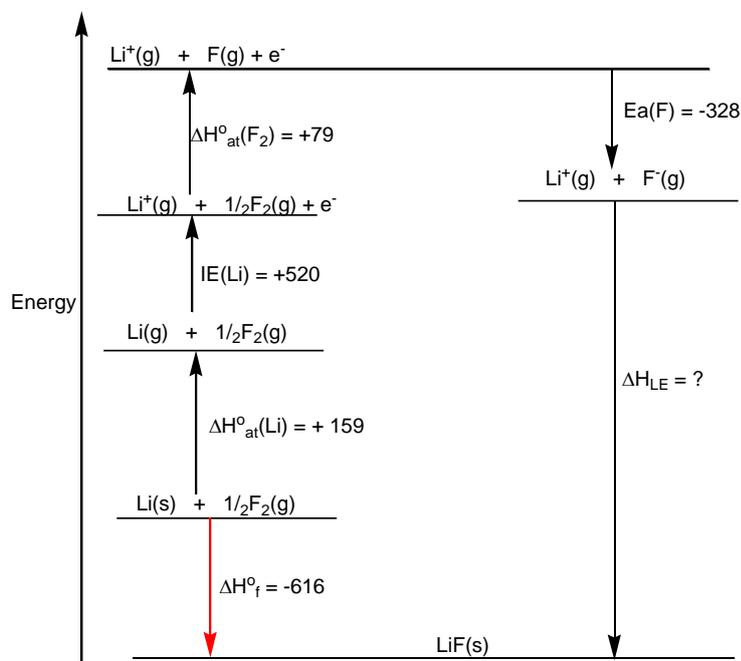

According to Hess's law, $\Delta H_f^\circ = \Delta H_{\text{at}}^\circ(\text{Li}) + \text{IE}^\circ(\text{Li}) + \Delta H_{\text{at}}^\circ(\text{F}_2) + \text{EA}(\text{F}) + \Delta H_{\text{LE}}$

$$-616 \text{ kJ} = 159 \text{ kJ} + 520 \text{ kJ} + 79 \text{ kJ} - 328 \text{ kJ} + \Delta H_{\text{LE}}$$

$$\Delta H_{\text{LE}} = -616 \text{ kJ} - 159 \text{ kJ} - 520 \text{ kJ} - 79 \text{ kJ} + 328 \text{ kJ}$$

$$\Delta H_{\text{lattice}} = -1046 \text{ kJ}$$

2) **Determination of the first electron affinity of oxygen**

A Born-Haber cycle for the formation of calcium oxide is shown below.

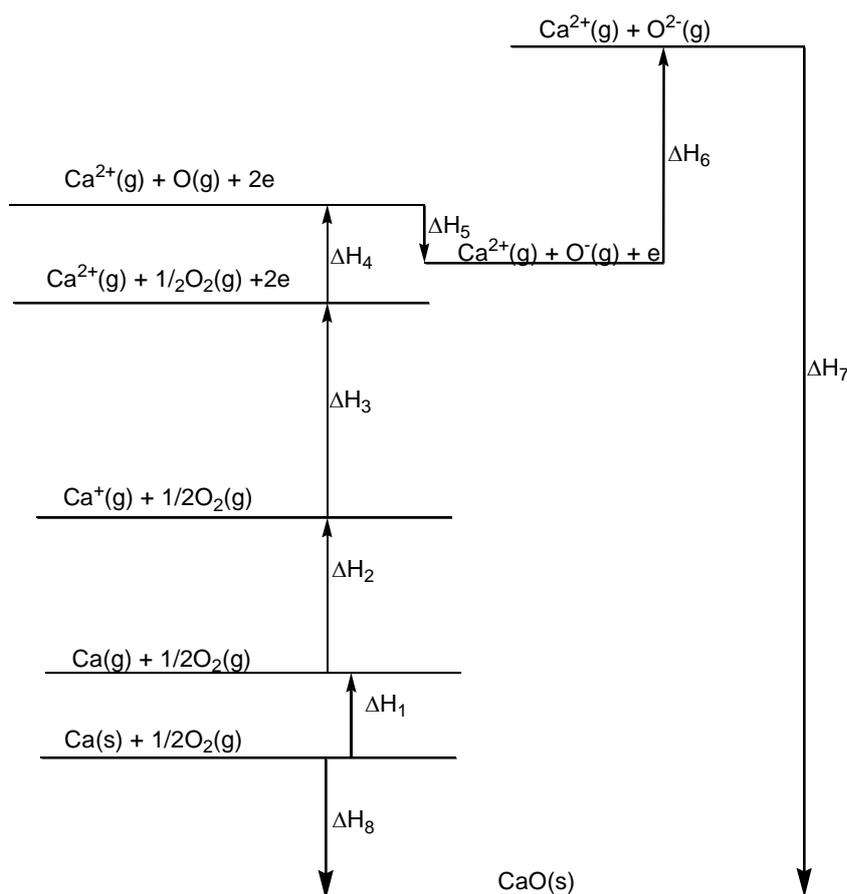

Data: $\Delta H/\text{kJ mol}^{-1}$:

$$\Delta H_1 = +193; \Delta H_2 = 590; \Delta H_3 = +1150; \Delta H_4 = +248;$$

$$\Delta H_6 = +840; \Delta H_7 = -3513; \Delta H_8 = -635$$

- Identify the change which represents the lattice enthalpy of CaO.
- Use the data above to calculate the first electron affinity of oxygen.

Solution:

a) The change that represents the lattice enthalpy of CaO is ΔH_7 .

b) According to Hess's law,

$$\Delta H_8 = \Delta H_1 + \Delta H_2 + \Delta H_3 + \Delta H_4 + \Delta H_5 + \Delta H_6 + \Delta H_7$$

$$\Delta H_5 = \Delta H_8 - \Delta H_1 - \Delta H_2 - \Delta H_3 - \Delta H_4 - \Delta H_6 - \Delta H_7$$

$$\Delta H_5 = -635 - 193 - 590 - 1150 - 248 - 840 + 3513$$

$$\Delta H_5 = -143 \text{ kJ mol}^{-1}$$

Checking up 14.9

- By using Born-Haber cycle for the formation of silver chloride, calculate the lattice enthalpy of silver chloride from the following data:
 - Enthalpy change for the formation of silver chloride(s): -127 kJ mol^{-1}
 - Atomization enthalpy of silver(solid): $+284 \text{ kJ mol}^{-1}$
 - First ionization energy of silver: $+731 \text{ kJ mol}^{-1}$
 - Atomization enthalpy of chlorine: $+122 \text{ kJ mol}^{-1}$
 - First electron affinity of chlorine: -349 kJ mol^{-1}
- Given the following information for magnesium, oxygen, and magnesium oxide

calculate the second electron affinity of oxygen.

- Atomization enthalpy of magnesium = + 148 kJ mol⁻¹
- Atomization enthalpy of oxygen = + 249 kJ mol⁻¹
- First ionization energy for magnesium = + 738 kJ mol⁻¹
- First electron affinity enthalpy for oxygen = -141 kJ mol⁻¹
- Second ionization energy for magnesium = +1450 kJ mol⁻¹
- Lattice enthalpy for magnesium oxide = -3890 kJ mol⁻¹
- Enthalpy of formation for magnesium oxide (s), = -602 kJ mol⁻¹

14.10. Hydration energy

Activity 14.10

Experiment on solubility of ionic compounds

Requirements: test tubes

Spatula

Distilled water

Sodium chloride

Sodium hydroxide

Potassium bromide

Silver chloride

Sodium carbonate

Potassium hydroxide

Magnesium hydroxide

Magnesium sulphate

Barium hydroxide

Barium sulphate

Procedure

- (1) Put 10mL of distilled water in a test tube
- (2) Add a half spatula end full of sodium chloride and shake
- (3) Record all your observations
- (4) Repeat steps 1-3 using the different salts

(5) Record your findings in the table below.

Compound	Soluble, sparingly soluble, insoluble	Release or absorption of heat

(6) Compare the lattice enthalpy of compounds of soluble compounds to those of sparingly soluble or insoluble compounds and deduce the general trends.

(7) What term is given to the interactions between solute and solvent?

Some ionic compounds such as sodium hydroxide and sodium chloride are very soluble while others like magnesium carbonate, are sparingly soluble or insoluble (calcium carbonate, magnesium hydroxide, barium sulphate). The dissolution of some compounds such as sodium hydroxide release the heat energy and the process is exothermic.

If a pair of oppositely charged gaseous ions are placed together, they are attracted to each other. The energy change (lattice enthalpy) is highly exothermic. If the ions were placed in water, they would be attracted to the polar water molecules leading to the energy change (hydration enthalpy) which is highly exothermic. In both cases, the greater the charge density of the ions, the more exothermic will be the process.

The enthalpy change when one mole of a gaseous ion dissolves in water (excess) to give an infinitely dilute solution is called **enthalpy change of hydration (ΔH_{hyd})**.

The solvent-solute interactions are referred as “**solvation**”.

When an ionic compound dissolves in water, the process can either be exothermic or endothermic.

The enthalpy of solution of a compound is the heat energy change at constant pressure when one mole of a compound dissolves completely in water.

For example when sodium chloride dissolves in water, the overall process is represented as:

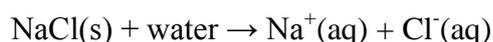

The first step is to separate the ions in the crystal. This requires energy to overcome the attractive forces between oppositely charged ions. The corresponding lattice dissociation energy according to the dissociation of the compound is:



The second step involves the hydration of the ions:





The hydration is an exothermic process as the ions form bonds with the water molecules. The enthalpy of solution of an ionic compound can be calculated from the lattice enthalpy and the enthalpies of hydration.

Example: Calculate the enthalpy of solution of sodium chloride (NaCl)

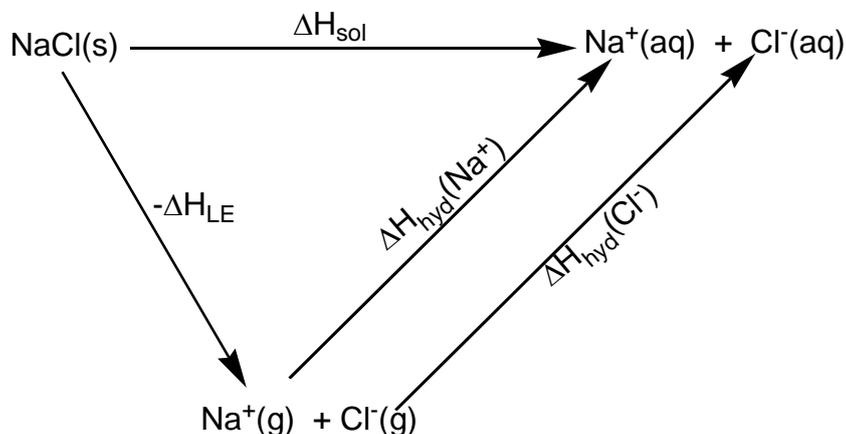

By applying Hess's law, we obtain: $\Delta H_{\text{sol}} = -\Delta H_{\text{LE}} + \Delta H_{\text{hyd}}(\text{Na}^+) + \Delta H_{\text{hyd}}(\text{Cl}^-)$

Where ΔH_1 = enthalpy of solution

ΔH_2 = lattice dissociation enthalpy (-lattice enthalpy) = + 771 kJ mol⁻¹

ΔH_3 = hydration enthalpy of sodium ions = - 406 kJ mol⁻¹

ΔH_4 = hydration enthalpy of chloride ions = - 364 kJ mol⁻¹

Enthalpy of solution for sodium chloride = 771 - (406 + 364) = +1 kJ mol⁻¹

Checking up 14.10

1) The enthalpy of solution of CaF₂(s) is +13.4 kJ mol⁻¹.

a) Draw a cycle to show the enthalpy changes involved by dissolving CaF₂ in water.

b) Describe and explain the change in solubility of CaF₂ as the temperature increases.

2) The standard enthalpies of hydration for three Group I metal ions are given in the Table below.

Explain the trends in these values.

Table 14.2: Hydration enthalpies of some group I cations

Ion	Li ⁺	Na ⁺	K ⁺
$\Delta H_{\text{hyd}} \text{ kJ mol}^{-1}$	-520	-406	-320

3) Calculate the enthalpy of solution for AgCl given that the lattice enthalpy is + 905 kJ mol⁻¹ and the enthalpies of hydration of Ag⁺(g) and Cl⁻(g) are - 446 kJ mol⁻¹ and - 346 kJ mol⁻¹, respectively.

14.11. Average standard bond enthalpy

Activity 14.11

Using internet or textbooks do research and answer the following questions.

- 1) Explain the term covalent bond and describe the formation of a covalent bond.
- 2) What are the factors that affect the strength of a covalent bond?
- 3) Relate the bond strength to the reactivity of a covalent compound.

1) Formation of a covalent bond

The covalent bond is a bond formed when atoms share a pair of electrons to complete the octet. The covalent bonds mostly occur between non-metals or between molecules formed by the same (or similar) elements. Two atoms with similar electronegativity do not exchange an electron from their outermost shell; the atoms instead share electrons and their valence electron shell is filled.

The build-up of electron density between two nuclei occurs when a valence atomic orbital of one atom overlaps with that of another atom, each orbital containing a single electron.

The orbitals share a region of space, i.e. they overlap. The overlap of orbitals allows two electrons of opposite spin to share the common space between the nuclei, forming a covalent bond.

2) Factors influencing the strength of a covalent bond

(i) Size of the atoms

Small atoms have shorter bond length and thus have better overlap of orbitals while larger atoms tend to have more diffused orbitals, resulting in less effective overlap

(ii) Number of bonds between atoms

Bond strength: triple bond > double bond > single bond

“>”: “stronger than”

Species with more electrons to share form more bonds between atoms, resulting in atoms held closer together.

(iii) Polarity of bond

Polar bond is generally stronger than non-polar bond; the extra electrostatic attraction between partial charges gives rise to a stronger bond.

(iv) Presence of neighbouring lone pair electrons

Atoms which are very small in size and have lone pairs in close proximity will result in excessive repulsion that weakens the covalent bond.

3) Bond enthalpy

Bond enthalpy (energy) is the amount of energy required to break one mole of gaseous bonds to form gaseous atoms. It is known as the **bond dissociation enthalpy**.

Bond energy may also be defined as the amount of energy released when two atoms are linked together by a covalent bond. It is expressed in kJ mol^{-1} or Kcal mol^{-1} . The bond energy is a measure of the strength of a chemical bond. The smaller the bond enthalpy the weaker the bond and the easier is to break the bond.

The process of breaking a bond is endothermic while the bond-formation is an exothermic process.

For example, the bond energy of an O-H single bond is 463 kJ mol^{-1} . This means that it requires 463 kJ of energy to break one mole of O-H **bonds**.

Note: For diatomic gas molecules, the bond enthalpy is equal to two times the enthalpy of atomization.

The exact bond enthalpy of a particular chemical bond depends on the environment of the bond in the compound. Therefore, the bond enthalpy values given are averaged values (Table 14.3).

Table 14.3: Examples of some values of average bond enthalpy.

Bond	Bond enthalpy / kJmol^{-1}	Bond	Bond enthalpy / kJmol^{-1}	Bond	Bond enthalpy / kJmol^{-1}
H-H	436	H-F	562	N-N	163
C-C	346	H-Cl	431	N=N	409
C=C	611	H-Br	366	N \equiv N	944
C \equiv C	837	H-I	299	P-P	172
C-O	360	H-N	388	F-F	158
C=O	743	H-O	463	Cl-Cl	242
C-H	413	H-S	338	Br-Br	193
C-N	305	H-Si	318	I-I	151
C-F	484	P-H	322	S-S	264
C-Cl	338	O-O	146	Si-Si	176

The bond enthalpy values are used to:

- compare the strengths of bonds
- estimate the enthalpy change of a reaction
- explain the mechanisms of reaction

- explain the structure and bonding

Checking up 14.11

- 1) a) Explain the term “mean bond enthalpy”.
b) Which bond in the reaction $\text{H}_2(\text{g}) + \text{Br}_2(\text{g})$ breaks first? Justify your answer.
- 2) Which bond in each of the following pairs of bonds is the strongest? Give reasons.
 - a) C–C or C=C
 - b) C–N or C≡N
 - c) C≡O or C=O
 - d) H–F or H–Cl
 - e) C–H or O–H
 - f) C–N or C–O

14.12. Calculating enthalpy change of reaction using average bond enthalpies

Activity 14.12

- 1) Define the term **average bond enthalpy**.
- 2) Consider the following reactions:
 - (i) $\text{CH}_4 + \text{Cl}_2 \rightarrow \text{CH}_3\text{Cl} + \text{HCl}$
 - (ii) $\text{CH}_3\text{CH}_2\text{CH}_2\text{CH}_3 + \text{O}_2 \rightarrow 4\text{CO}_2 + \text{H}_2\text{O}$
 - (iii) $\text{CH}_3\text{CH}_2\text{OH} + \text{CH}_3\text{COOH} \rightarrow \text{CH}_3\text{CH}_2\text{OCOCH}_3 + \text{H}_2\text{O}$
 - a) Explain how the enthalpy change of each of them may be determined.
 - b) During chemical reactions, bonds are broken in the reactants and new bonds are formed in the products. When bonds are broken, there is a release of heat energy known as the bond dissociation energy. When bonds are formed energy is released. Do research and show the relationship between average bond dissociation enthalpy values and the heat exchanged during a chemical process.

Breaking chemical bonds requires energy (endothermic), and forming chemical bonds releases energy (exothermic). To determine if a chemical reaction is endothermic or exothermic depends on whether or not breaking the old chemical bonds requires more energy than the energy released from the new chemical bonds formed.

When the standard enthalpy change for a reaction cannot be measured, an approximate value is obtained by using average standard bond enthalpies. During a chemical reaction, the energy is provided to break bonds of the reactants, and energy released when the new bonds of the products are formed.

The standard enthalpy of reaction is the difference between the sum of average bond enthalpies of the products and the sum of average standard bond enthalpies of the reactants.
 $\Delta H_r = \sum (\text{mean bond enthalpies of bonds broken}) - \sum (\text{mean bond enthalpies of bonds formed})$

Examples

- 1) Calculate the enthalpy change for the hydrogenation of ethene.

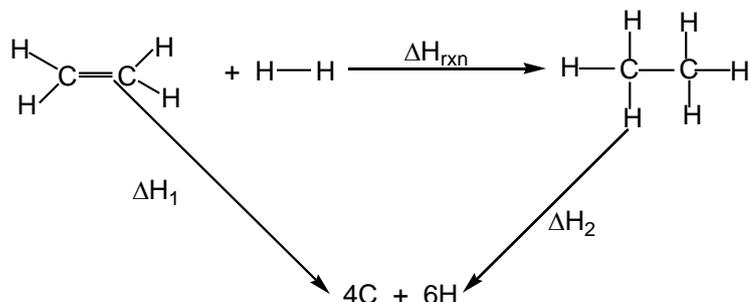

$$\Delta H_1 \quad 1 \times \text{C} = \text{C} \text{ bond} \quad 1 \times 611 = 611 \text{ kJ}$$

$$4 \times \text{C-H bonds} \quad 4 \times 413 = 1652 \text{ kJ}$$

$$1 \times \text{H-H bond} \quad 1 \times 436 = 436 \text{ kJ}$$

Total energy to break bonds of reactants = 2699 kJ

$$\Delta H_2 \quad 1 \times \text{C-C bond} \quad 1 \times 346 = 346 \text{ kJ}$$

$$6 \times \text{C-H bonds} \quad 6 \times 413 = 2478 \text{ kJ}$$

Total energy to break bonds of products = 2824 kJ

Applying Hess's Law, $\Delta H_r = \Delta H_1 - \Delta H_2 = (2699 - 2824) = -125 \text{ kJ}$

- 2) Calculate a value for the standard enthalpy of combustion of butan-1-ol $\text{C}_4\text{H}_9\text{OH}(\text{g})$ using the following mean bond enthalpies.

Bond	Mean bond enthalpy/kJ mol ⁻¹
C-C	348
C-H	412
O-H	463
C-O	360
O=O	496
C=O	803

Solution

Equation for combustion of butan-1-ol

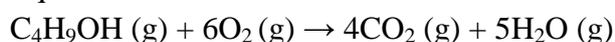

Structural equation showing all the moles of covalent bonds:

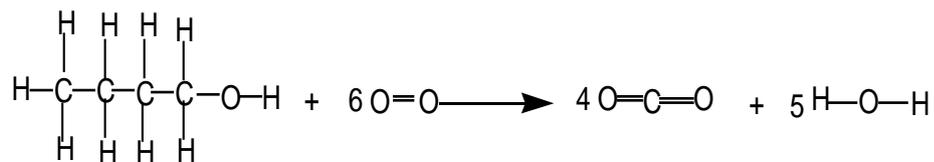

Calculate the energy required for moles of bonds broken in the reactants:

$$3 \text{ moles of C-C} = 3(348)$$

$$9 \text{ moles of C-H} = 9(412) = 3708$$

$$1 \text{ mole of C-O} = 360$$

$$1 \text{ mole of O-H} = 463$$

$$6 \text{ moles of O=O} = 6(496) = 2976$$

Total energy required for bonds broken = 8551 kJ mol⁻¹

Calculate the energy released for moles of bonds formed in the products:

$$8 \text{ C=O} = 8 \times (803) = 6424$$

$$10 \text{ O-H} = 10 \times (463) = 4630$$

Total energy released for bonds made = 11 054 kJ mol⁻¹

$\Delta H_r = \sum (\text{mean bond enthalpies of bonds broken}) - \sum (\text{mean bond enthalpies of bonds formed})$

$$\Delta H_r = 8551 - 11054 = -2504 \text{ kJ mol}^{-1}$$

Checking up 14.12

- 1) Using the values of bond enthalpies, calculate the enthalpies change of the hydrochlorination of ethene.

$$\text{H-Cl} = 432 \text{ kJ mol}^{-1}$$

- 2) Calculate the enthalpy of the reaction :



Using the following the following bond enthalpy values (in kJ mol⁻¹)

$$\text{N}\equiv\text{N}: 942 \quad \text{N-H}: 391 \quad \text{O-H}: 463 \quad \text{H-Cl}: 431 \quad \text{O-Cl}: 200$$

14.13. End unit assessment

- 1) a) Define the term *enthalpy change*.
b) Define the term *standard enthalpy change of reaction*, using the following equation as an illustration:
- $$2\text{C}_2\text{H}_6(\text{g}) + 7\text{O}_2(\text{g}) \rightarrow 4\text{CO}_2(\text{g}) + 6\text{H}_2\text{O}(\text{l}) \quad \Delta H = -3120 \text{ kJ mol}^{-1}$$
- c) This reaction shows the combustion of ethane, but the standard enthalpy change of combustion of ethane is *not* $-3120 \text{ kJ mol}^{-1}$. Define the term *standard enthalpy change of combustion*, and explain why the standard enthalpy change of combustion of ethane isn't $-3120 \text{ kJ mol}^{-1}$.
- 2) 50.0 cm^3 of 0.500 M NaOH and 50.0 cm^3 of 0.500 M HNO_3 both at 20.0°C were mixed and stirred in a calorimeter with negligible heat capacity. The temperature of the mixture rose to 23.2°C .
- a) Calculate the change in enthalpy for the neutralization.
b) Calculate the change in enthalpy per mole of water formed.
- 3) The standard enthalpy of combustion of propane is $-2202 \text{ kJ mol}^{-1}$. Given that 0.015 mol of propane are burned completely and the fuel is used to heat 200 g of water (specific heat capacity $4.18 \text{ J g}^{-1} \text{ K}^{-1}$), calculate the theoretical temperature change which would be measured.
- 4) 25.0 cm^3 of 1 M HCl at 21.5°C were placed in a polystyrene cup. 25.0 cm^3 of 1 M NaOH at 21.5°C were added. The mixture was stirred, and the temperature rose to 28.2°C . The density of each solution = 1.00 g cm^{-3} , and the specific heat capacity of each solution = $4.18 \text{ J K}^{-1} \text{ g}^{-1}$. Calculate the standard molar enthalpy of neutralization.
- 5) In an experiment to find the enthalpy change in a reaction, 25 cm^3 of 0.5 M copper sulphate solution was placed in a polystyrene cup and the temperature recorded. Excess zinc powder was added and the mixture stirred. The increase in temperature was 21°C . The equation for the reaction is : $\text{CuSO}_4(\text{aq}) + \text{Zn}(\text{s}) \rightarrow \text{ZnSO}_4(\text{aq}) + \text{Cu}(\text{s})$
- a) Why was excess zinc used in the reaction?
b) Calculate the heat energy (in joules) released in the reaction
c) Calculate the number of moles of copper sulphate used in the reaction.
d) Hence calculate the molar enthalpy change for the reaction.
e) Give the main source of error in this experiment and suggest two methods of reducing this error.
- 6) Calculate the standard enthalpy for the reduction of hydrazine, N_2H_4 , to ammonia:
- $$\text{N}_2\text{H}_4(\text{l}) + \text{H}_2(\text{g}) \rightarrow 2\text{NH}_3(\text{g})$$
- Use the values:
- $$\text{N}_2(\text{g}) + 2\text{H}_2(\text{g}) \rightarrow \text{N}_2\text{H}_4(\text{l}) \quad \Delta H = + 50.63 \text{ kJ mol}^{-1}$$
- $$\text{N}_2(\text{g}) + 3\text{H}_2(\text{g}) \rightarrow 2\text{NH}_3(\text{g}) \quad \Delta H = - 92.22 \text{ kJ mol}^{-1}$$
- 7) Calculate ΔH for the reaction $4 \text{ NH}_3 (\text{g}) + 5 \text{ O}_2 (\text{g}) \rightarrow 4 \text{ NO} (\text{g}) + 6 \text{ H}_2\text{O} (\text{g})$, from the following data.
- a) $\text{N}_2 (\text{g}) + \text{O}_2 (\text{g}) \rightarrow 2 \text{ NO} (\text{g}) \quad \Delta H = - 180.5 \text{ kJ}$
b) $\text{N}_2 (\text{g}) + 3 \text{ H}_2 (\text{g}) \rightarrow 2 \text{ NH}_3 (\text{g}) \quad \Delta H = - 91.8 \text{ kJ}$



8) Use the following reactions and enthalpy changes to predict the standard enthalpy change for $2\text{NO}_2(\text{g}) + 2\text{H}_2\text{O}(\text{g}) \rightarrow 3\text{O}_2(\text{g}) + \text{N}_2\text{H}_4(\text{g})$



9) Use the following data to calculate the standard enthalpy change for the complete combustion of cycloheptane.



10) Given the following data, construct the Born-Haber cycle and use it to

i. Calculate the enthalpy of formation of Mg^+O^- and $\text{Mg}^{2+}\text{O}^{2-}$

ii. State and explain which of the two magnesium oxides is more stable

Atomisation enthalpy of magnesium: $+153 \text{ kJ mol}^{-1}$

First ionisation energy of magnesium: $+738 \text{ kJ mol}^{-1}$

Second ionisation enthalpy of magnesium: $+1451 \text{ kJ mol}^{-1}$

Atomisation enthalpy of oxygen: $+248 \text{ kJ mol}^{-1}$

First electron affinity of oxygen: -141 kJ mol^{-1}

Second electron affinity of oxygen: $+856 \text{ kJ mol}^{-1}$

Lattice enthalpy for Mg^+O^- : $-1246 \text{ kJ mol}^{-1}$

Lattice enthalpy for $\text{Mg}^{2+}\text{O}^{2-}$: $-3933 \text{ kJ mol}^{-1}$

11) a) Explain why it is difficult to obtain an experimental value for the standard enthalpy of the reaction for the combustion of methane to carbon monoxide:



b) Calculate a value, given the following data:



12) The following values are $\Delta H^\circ_f / \text{kJ mol}^{-1}$ at 298K:

Compound	$\Delta H^\circ_f / \text{kJ mol}^{-1}$	Compound	$\Delta H^\circ_f / \text{kJ mol}^{-1}$
$\text{CH}_4(\text{g})$	-76	$\text{NH}_3(\text{g})$	-46.2
$\text{CO}_2(\text{g})$	-394	$\text{C}_2\text{H}_5\text{OH}(\text{l})$	-278
$\text{H}_2\text{O}(\text{l})$	-286	$\text{C}_8\text{H}_{18}(\text{l})$	-210
$\text{H}_2\text{O}(\text{g})$	-242	$\text{C}_2\text{H}_6(\text{g})$	-85

Calculate the standard enthalpies changes at 298K for the reactions:

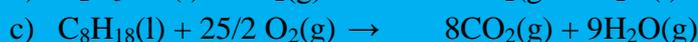
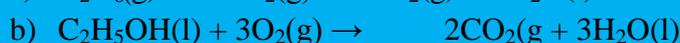
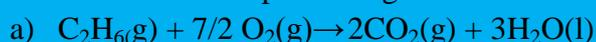

13) Construct a Born-Haber cycle, and use it to find the standard lattice enthalpy of

Cadmium (II) iodide.

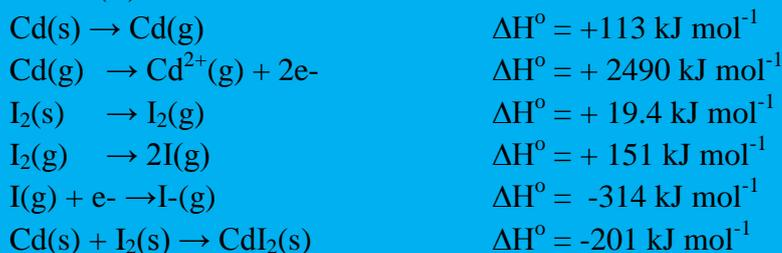

14) a) Define the term **lattice enthalpy**.

b) Using the following data, construct a Born-Haber cycle for sodium fluoride and from it determine the lattice enthalpy of sodium fluoride.

Process	The value of the energy change/ kJ mol^{-1}
$\text{Na(g)} \rightarrow \text{Na}^+(\text{g}) + \text{e}^-$	+494
$\text{F}_2(\text{g}) \rightarrow 2\text{F}(\text{g})$	+158
$\text{F}(\text{g}) + \text{e}^- \rightarrow \text{F}^-(\text{g})$	-348
$\text{Na(s)} + \frac{1}{2} \text{F}_2(\text{g}) \rightarrow \text{NaF(s)}$	-569
$\text{Na(s)} \rightarrow \text{Na(g)}$	+109

c) The table below gives some information about the hydroxides of the Group 2 element.

Hydroxide	Lattice enthalpy/ kJ mol^{-1}	Hydration enthalpy/ kJ mol^{-1}	Solubility in water/g per 100g of water
Magnesium hydroxide	-2383	-2380	-0.9×10^{-4}
Calcium hydroxide	-2094	-2110	156×10^{-4}
Strontium hydroxide	-1894	-1940	800.0×10^{-4}
Barium hydroxide	-1768	-1820	3900×10^{-4}

(i) Explain why energy is required to break up an ionic lattice.

(ii) Suggest why the lattice enthalpies of hydroxides of Group 2 metals become more exothermic from $\text{Ba}(\text{OH})_2$ to $\text{Mg}(\text{OH})_2$.

(iii) Suggest why lattice enthalpy of beryllium hydroxide, $\text{Be}(\text{OH})_2$, cannot be predicted from the data in the table.

(iv) Explain why energy is released when ions are hydrated.

(iv) Hence, account for the trend in solubilities from $\text{Ba}(\text{OH})_2$ to $\text{Mg}(\text{OH})_2$.

15) Vanadium metal can be obtained from ore using calcium metal. The reaction is

represented by the equation:

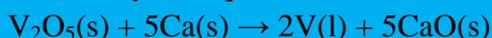

- a) Use the standard enthalpies of formation in the table below to calculate a value for the standard enthalpy change of this reaction.

	$\text{V}_2\text{O}_5(\text{s})$	$\text{Ca}(\text{s})$	$\text{V}(\text{l})$	$\text{CaO}(\text{s})$
$\Delta H_f^\circ / \text{kJmol}^{-1}$	-1551	0	+23	-635

- 16) The equation for the combustion of pentane is



- a) Use the mean bond enthalpy values given below to calculate the ΔH value for the combustion reaction. $\Delta H^\circ / \text{kJmol}^{-1}$ C-C = 348; C-H = 412; O-H = 463; O=O = 496; C=O = 743
- b) Use the following enthalpy of formation data to calculate the ΔH value for the combustion reaction. $\Delta H_f^\circ / \text{kJmol}^{-1}$ $\text{C}_5\text{H}_{12}(\text{l}) = -146$; $\text{CO}_2(\text{g}) = -394$; $\text{H}_2\text{O}(\text{g}) = -242$
- c) Explain why the answers in a) and b) have different values.

- 17) a) Given the following data

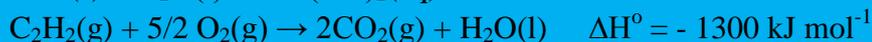

Calculate the enthalpy of the reaction: $\text{CaC}_2(\text{s}) + 2\text{H}_2\text{O}(\text{l}) \rightarrow \text{Ca}(\text{OH})_2(\text{aq}) + \text{C}_2\text{H}_2(\text{g})$

- b) The main reaction above is about the preparation of acetylene from calcium carbide(CaC_2)
1. What is the oxidation state of carbon in calcium carbide?
 2. Calculate the enthalpy of combustion of acetylene using the following data about bond dissociation energies in kJmol^{-1} .
 $\text{C}\equiv\text{C} = +835$; C-H = +413; O-H = 463; C=O = 799; O=O = 498;
- c) (i) Write an equation of the reaction between acetylene and bromine in tetrachloromethane.
- (ii) Write an equation of the reaction between acetylene and bromine in tetrachloromethane.
- (iii) Write an equation of the reaction between acetylene and water in the presence of sulphuric acid and mercury sulphate
- (iv) What is the homologous series does the product of the reaction in (i) belong to?
- (v) Construct a Hess's cycle illustrating the reaction in (i) and calculate the corresponding enthalpy change using the following data
 $\Delta H_f^\circ(\text{C}_2\text{H}_2) = +227 \text{ kJ mol}^{-1}$; $\Delta H_f^\circ(\text{H}_2\text{O}) = -286 \text{ kJ mol}^{-1}$, $\Delta H_f^\circ(\text{CH}_3\text{CHO}) = -187 \text{ kJ mol}^{-1}$

UNIT 15: ENTROPY AND FREE ENERGY

Key unit competence: To be able to Predict the feasibility of chemical reactions.

Learning Objectives

By end of this unit a learner should be able to:

- Explain the term entropy
- State the second law of thermodynamics
- State if the value of free energy for a reaction will be positive or negative.
- Relate the entropy changes to the changes in degree of disorder
- Predict the spontaneity of reactions using the Gibbs free energy values
- Develop a team approach, responsibility and self-confidence in group activities and presentation
- Respect of other's opinion during group discussions

INTRODUCTORY ACTIVITY

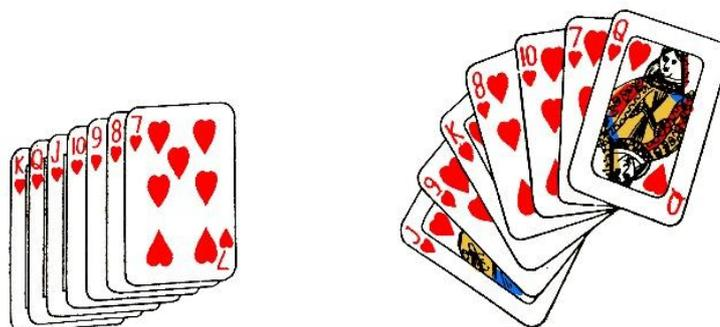

Observe the images above of playing cards and answer to the related questions.

1. What is the difference between the two organizations of playing cards
2. In which conditions (arrangement) to play card is easy? Explain
3. Why people toss cards before playing them

15.1. Definition of entropy and change in entropy

Activity 15.1 Investigation of entropy of a substance.

1. Take three beakers and label them by A, B, and C
2. In beaker A add 50 grams of ice
3. In beaker B add 50 mL of water
4. In beaker C add 25 mL of water and heat it up to transformation to liquid state (vapors)

5. Pour the container of beaker A and B, then compare it to the movement of vapors in C
 - a) In which beaker, A, B or C where the molecules move easily (high speed)?
 - b) In which beaker A, B or C where the molecules move slowly (low speed)?
 - c) Order the beakers to the order of mobility of the container.
 - d) Explain why the mobility of molecules in beakers A, B and C varies.
 - e) Which factor that make the variation of water in different states to move differently in the beakers A, B and C?

15.1.1. Definition of entropy

Entropy is a thermodynamic function that describes the *number of arrangements* (positions and/or energy levels) that are *available to a system* existing in a given state. Entropy is a quantitative measure of microscopic disorder for a system. It is defined as the degree of disorder or randomness of a system. The entropy of a system increases as the disorder of the system increases. When we focus on the molecular motion of a system, adding heat to this system increases the disorder because the heat increases the randomness of the molecular motion. So, the entropy of the system increases. The effect of adding heat to a system increases the molecular motion, and this results in more disorder of the system. Entropy is derived from the second law of thermodynamics, which states that “***all systems tend to reach a state of equilibrium***”. Based on the state of matter, the entropy increases in the order: **Solids < liquids < gases** substances (Figure 15.1). If we consider three substances such as solid, liquid and a gas. A mole of a substance has a much smaller volume in the solid state than it does in the gaseous state. In the solid state, the molecules are close together, with relatively few positions available to them; in the gaseous state, the molecules are far apart, with many more positions available to them. The liquid state is closer to the solid state than it is to the gaseous state in these terms.

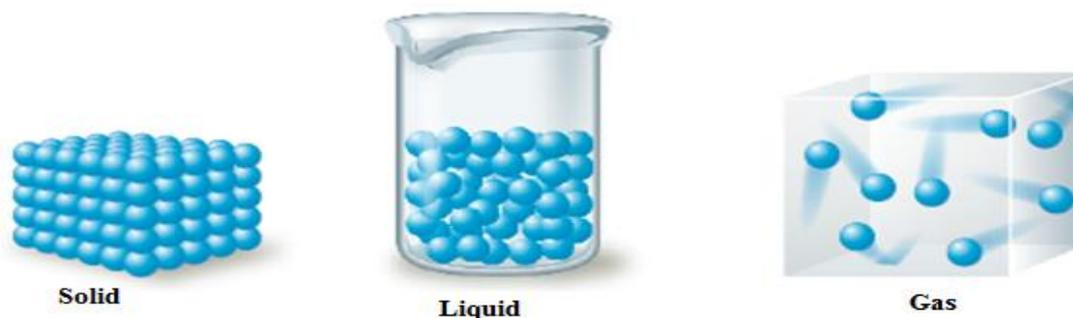

Figure 15.2. Representation of molecules in different states of matter.

In the above Figure, the molecules are closely packed in the solid state, in the liquid state; the molecules are not very closed while in a gas the molecules are far apart which increase the entropy in gas than liquid or solid.

The following Tables 15.1 and 15.2 show the relationship between the state of a substance and its entropy:

Table 15.1. Entropy variation with state of a substance

State of substance	Relative Entropy (S)
Gas	Highest
Aqueous	Highest
Liquid	Medium
Solid	Lowest

Table 15.2. Typical entropy values of some substances

Substance/ state	Entropy/ $\text{Jmol}^{-1} \text{K}^{-1}$
Diamond (solid)	2.4
Graphite (solid)	5.7
Aluminium (solid)	28.3
Water (liquid)	69.9
Mercury (liquid)	76.8
Nitrogen (gas)	191.5
Carbon monoxide (gas)	197.6
Carbon dioxide	213.6
Argon	154.7
C_2H_2	200.8
Oxygen gas O_2	205.0

Source: (B.S.BAHL, essentials of physical chemistry, page 253)

In the above Table 15.2, the element argon has a greater entropy value than the carbon element (graphite) because argon is a gas with greater disorder and random particle movement than the solid state of carbon.

The *entropy* of a perfect crystal at *absolute zero* is exactly equal to *zero*. At *absolute zero* (*zero kelvin*), the system must be in a state with the minimum possible energy. As the temperature increases, the particles vibrate more and the disorder increases.

Melting is associated with an increase in entropy (disorder), however, boiling is associated with a large increase in entropy: gases are associated with considerable random particle in movement and disorder.

15.1.2. Change in entropy

Entropy, like temperature, pressure, and enthalpy, is also a state property and is represented in the literature by the symbol "**S**". The entropy **change is represented by ΔS** .

It is known that the main purpose of chemistry is the study of chemical reactions. In this section, it is important to consider the entropy changes accompanying chemical reactions that occur under conditions of constant temperature and pressure. The entropy changes in the *surroundings* are determined by the transfer of heat that occurs when the reaction takes place. However, the entropy changes in the *system* (the reactants and products of the reaction) are determined by positional probability.

For example, consider the reaction of production of ammonia in the Haber process:



It is seen that four molecules of reactants yield two molecules of ammonia product which lead to less disorder in the system. If the number of molecules of the gaseous products is greater than the number of molecules of the gaseous reactants, positional entropy typically increases, and ΔS will be positive for the reaction.

The calculation of the entropy change of a reaction is given by applying the formula:

$$\Delta S = S_{(\text{final})} - S_{(\text{initial})}$$

When $S_{(\text{final})} > S_{(\text{initial})}$, then ΔS is positive.

For a chemical reaction which involves the reactants and the products, the change in entropy is calculated as follows.

$$\Delta S = \Sigma S_{(\text{products})} - \Sigma S_{(\text{reactants})}$$

Any reaction that results in the formation of a gas, an increase in the number of gaseous moles, results in the increase of the disorder. Entropy change, ΔS , relates to *increasing disorder of a process*, either arising through *physical change* (e.g. melting, evaporation) or *chemical change* (e.g. dissolution, evolution of CO_2 from hydrogen carbonates with acid) or both.

Application examples:

1. Calculate the entropy change for the reaction $\text{C}(\text{s}) + \text{CO}_2 (\text{g}) \rightarrow 2\text{CO} (\text{g})$

$$\Delta S = 2(197.6) - 213.6 - 5.7 = 175.9 \text{ J mol}^{-1} \text{K}^{-1}$$

- If ΔS is **positive**, a reaction is possible.
- If ΔS is negative, a reaction is questionable.

The chemical reactions are favored if they are accompanied by an increase in entropy.

2. Consider the thermal decomposition of solid calcium carbonate, predict the sign of the standard entropy ΔS° .



In this reaction, a solid reactant produces a molecule of gas, the positional entropy increases, and ΔS^0 is positive.

3. Consider the oxidation of SO_2 in air; predict the sign of ΔS^0 of the reaction.



For this reaction, three molecules of gaseous reactants become two molecules of gaseous products. Because the number of gas molecules produced decreases, the entropy decreases also, and ΔS^0 is negative.

Note: (i) Many endothermic reactions proceed spontaneously under normal conditions because there is an increase in entropy.

(ii) Some exothermic reactions do not proceed spontaneously because there is a decrease in entropy. In a system with *perfect order, the entropy is equal to zero*. An example of perfect order is found in a crystalline substance at the absolute zero of temperature, where atomic and molecular motion cease. The entropy of **pure, perfect crystal** can be taken to be **zero at 0 K**.

Checking up 15.1

1. Define the term “entropy”.
2. Classify the increasing order of entropy among solid, liquids and gases substances.
3. Referring to the Table 15.1, calculate the entropy of the following reaction:



15.2. Second law of thermodynamics

Activity 15.2

1. State and explain the first law of thermodynamics
2. What is the relation between the first law of thermodynamics and thermochemistry?

In chemistry, thermodynamics deals with the energy and work of a system. There are three laws in thermodynamics: first, second and third law. The first law establish the relationship between the different forms of energy present in a system (kinetic and potential), the work done by the system and the energy or heat transferred. The second law of thermodynamics is dealing with entropy which describes the disorder of the system. The Second law of thermodynamics states that *in any spontaneous process, the state of entropy of the entire universe, as an isolated system always increases over time. It also states that the changes in the entropy in the universe can never be negative.*

Within this law, the change in entropy ΔS is equal to the heat transfer ΔQ divided by the temperature T .

$$\Delta S = \text{entropy} = \frac{\Delta Q}{T}$$

Following are the statements of second law of thermodynamics:

- a) All spontaneous process are **irreversible** in nature.

- b) The net entropy of the universe in any natural process **always increases and tends to acquire the maximum value.**
- c) In a reversible process, the sum of entropies of the system and surroundings remains constant but in an irreversible process, the total entropy of the system and surroundings increases.

Thus, the change in the entropy of the universe can be represented as:

$$\Delta S_{(\text{universe})} = \Delta S_{\text{syst}} + \Delta S_{\text{surr}}$$

Where: ΔS_{syst} and ΔS_{surr} represent the changes in entropy that occur in the system and surroundings, respectively.

To predict whether a given process will be spontaneous, the sign of $\Delta S_{(\text{universe})}$ must be known. If $\Delta S_{(\text{universe})}$ is positive, the entropy of the universe increases, and the process is spontaneous in the direction written. If $\Delta S_{(\text{universe})}$ is negative, the process is spontaneous in the *opposite* direction. If $\Delta S_{(\text{universe})}$ is equal to zero, there is no tendency of the process to occur, and the system is at the equilibrium state. To predict whether a process is spontaneous, the entropy changes that occur both in the system and in the surroundings must be added and analyze the value obtained depending on its sign.

In general, the information derived from the second law of thermodynamics are:

- (i) When an irreversible spontaneous process occurs, the entropy of the system and the surrounding increases ($\Delta S_{(\text{universe})} > 0$), $S_f > S_i$ (f and i denote initial and final states of the system).
- (ii) When a reversible process occurs, the entropy of the system remains constant ($\Delta S_{(\text{universe})} = 0$), $S_f = S_i$.
- (iii) Since the entire universe is undergoing spontaneous change, the second law can be generally and concisely stated as that the entropy of the system is constantly increasing.

In the surroundings, there are two important characteristics of the entropy changes that can occur: (a) *the sign of ΔS_{surr}* depends on the direction of the heat flow. At constant temperature, an exothermic process in the system causes the heat to flow into the surroundings, the random motions increase and thus the entropy of the surroundings increases ($\Delta S_{\text{surr}} > 0$).

In the case of an endothermic process, $\Delta S_{\text{surr}} < 0$ in a system at constant temperature.

(b) *The magnitude of ΔS_{surr}* depends on the temperature. The transfer of a given quantity of energy as heat produces a much greater percent change in the randomness of the surroundings at a low temperature than it does at a high temperature. Thus ΔS_{surr} depends directly on the quantity of heat transferred and inversely on temperature. In other words, the tendency for the system to lower its energy becomes a more important driving force at lower temperatures.

Note: For a process to be spontaneous, ΔS_{univ} and ΔS_{syst} must be positive. A process for which ΔS_{syst} is negative can be spontaneous if the associated ΔS_{surr} is both larger and positive.

In the case of an exothermic process:
$$\Delta S_{\text{surr}} = + \frac{\text{quantity of heat}(J)}{\text{Temperature}(K)}$$

For an endothermic process: $\Delta S_{surr} = -\frac{\text{quantity of heat}(J)}{\text{Temperature}(K)}$

Checking up 15.2

1. Explain the variation in entropy for reversible and irreversible reactions
2. How the reversibility and spontaneity affect the entropy change?
3. Consider the reaction



Explain the variation of the entropy of the above reaction.

15.3. Free energy, the deciding factor

Activity 15.3

Observe the representations below and answer to the related questions.

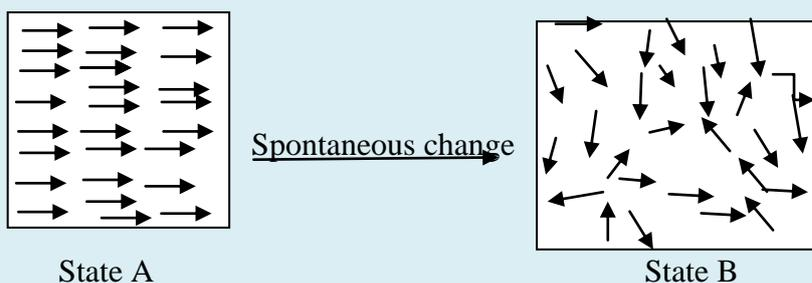

1. Explain in which state (A or B) where the entropy is high or low.
2. Explain and attribute how the spontaneity relates to the disorder of the reaction.

The entropy has been discussed in the previous sections, it is a state function that deals with the spontaneity of a process. In thermodynamics, another function related to the spontaneity and dealing with the temperature dependence of spontaneity is called the free energy.

The free energy of a system is defined as *the energy that is free to do work at constant temperature and pressure*. It is symbolized by "G", $G = H - TS$

Where: H is the enthalpy, T is the Kelvin temperature, and S is the entropy.

Whether or not a reaction proceeds, it depends on a **balance between entropy (S) and enthalpy (H)**.

All the quantities, entropy, enthalpy and free energy refer to the system.

For a process that occurs at constant temperature, the change in free energy (ΔG) is given by the following equation. $\Delta G = \Delta H - T\Delta S$

From the relation of the change in entropy, the relation of free energy relating to the spontaneity can be expressed.

$$\Delta S_{univ} = \Delta S_{sys} + \Delta S_{surr} \quad (1)$$

Remember that at constant temperature and pressure, we have: $\Delta S_{surr} = -\frac{\Delta H}{T}$ (2)

$$\Delta S_{univ} = \Delta S_{sys} - \frac{\Delta H}{T} \Rightarrow T\Delta S_{univ} = T\Delta S_{sys} - \Delta H_{sys} \quad (3)$$

Replacing the equation (2) into (1), we obtain:

$$\Delta S_{univ} = \Delta S_{sys} - \frac{\Delta H}{T} \Rightarrow T\Delta S_{univ} = T\Delta S_{sys} - \Delta H_{sys} \quad (3)$$

The equation (3) can be rewritten as:

$$-T\Delta S_{univ} = T\Delta S_{sys} + \Delta H_{sys} \quad (4)$$

We have seen that: $\Delta G = \Delta H - T\Delta S$

From the equation (4), it is deduced that:

$$-T\Delta S_{univ} = \Delta G$$

And

$$\Delta G = \Delta H - T\Delta S \quad (5)$$

Where:

- ΔG is change in free energy
- ΔH is the variation in enthalpy
- T is the temperature in Kelvin (K)
- S is the entropy of the system.

We can also calculate the change in free energy ΔG in the same way as for the change in enthalpy or entropy:

$$\Delta G = G(\text{products}) - G(\text{reactants})$$

Change in **free energy** ΔG is a **deciding factor**.

According to the equation (5), if H and S favor the opposite processes, the spontaneity will depend on the temperature in such a way that the exothermic direction will be favored at low temperatures.

Examples of standard enthalpy change and free energy change for some reactions are given in the Table 15.2 (ΔG^0 and ΔH^0 have the same units, kJ mol^{-1} . And the values are measured at standard condition of 298 K and 1 atm.

Table 15.2 Standard enthalpy change and free energy change for some reactions

Reaction	Equation	$\Delta G^0/$ kJ mol^{-1}	$\Delta H^0/\text{kJmol}^{-1}$
Burning carbon	$\text{C} + \text{O}_2 \longrightarrow \text{CO}_2$	-394.4	-393.5
Condensing steam	$\text{H}_2\text{O}_{(g)} \longrightarrow \text{H}_2\text{O}_{(l)}$	-8.6	-44.1
Freezing water	$\text{H}_2\text{O} (g) \longrightarrow \text{H}_2\text{O} (s)$	+0.6	-6.01
Burning magnesium	$2\text{Mg} (s) + \text{O}_2 (g) \longrightarrow 2\text{MgO} (s)$	-1138.8	-1204
Reaction of zinc	$\text{Zn} + \text{Cu}^{+2} \longrightarrow \text{Zn}^{2+} +$	-212.1	-216.7

with copper ion	Cu		
Making ammonia	$\text{N}_2 + 3\text{H}_2 \longrightarrow 2\text{NH}_3$	-33.4	-92.0
Formation of water	$\text{H}_2 + \text{O}_2 \longrightarrow \text{H}_2\text{O}$	-457.2	-483.6
Dissolving ammonium chloride	$\text{NH}_4\text{Cl} \xrightarrow{\text{H}_2\text{O}} \text{NH}_4^+(\text{aq}) + \text{Cl}^-(\text{aq})$	-6.7	+16

(Source: GRAHAM, *chemistry in context*, page 347)

Note:

- (i) The second law of thermodynamics establishes that all spontaneous or natural processes increase the entropy of the universe. For a spontaneity process, we get:

$$\Delta S_{\text{univ}} = \Delta S_{\text{sys}} + \Delta S_{\text{surr}} > 0$$

- (ii) The spontaneity of a process depends on the temperature.
 (iii) When $\Delta G < 0$, the process is *exergonic* and will proceed spontaneously in the forward direction to form more products.
 (iv) When $\Delta G > 0$, the process is *endergonic* and is not spontaneous in the forward direction. Instead, it will proceed spontaneously in the reverse direction to make more starting materials (reactants).
 (v) When $\Delta G = 0$, the system is in equilibrium and the concentrations of the products and reactants will remain constant.
 (vi) When the process is exothermic ($\Delta H_{\text{system}} < 0$) and the entropy of the system increases ($\Delta S_{\text{system}} > 0$), thus, the process is always spontaneous.
 (vii) When the process is endothermic, ($\Delta H_{\text{system}} > 0$, and the entropy of the system decreases, ($\Delta S_{\text{system}} < 0$, the sign of ΔG is positive at all temperatures and the process is non-spontaneous.

For other combinations of ΔH_{system} and ΔS_{system} , the spontaneity of a process depends on the temperature.

Exothermic reactions, ($\Delta H_{\text{system}} < 0$) that decrease the entropy of the system ($\Delta S_{\text{system}} < 0$) are spontaneous at low temperatures.

Endothermic reactions, ($\Delta H_{\text{system}} > 0$) that increase the entropy of the system ($\Delta S_{\text{system}} > 0$) are spontaneous at high temperatures.

Checking up: 15.3

1. a. Use the data below to calculate the standard enthalpy and entropy change for the reaction.
- b) Calculate the maximum temperature at which this reaction is feasible.
- c) Deduce the effect of an increase in temperature on the position of the equilibrium in this reaction.

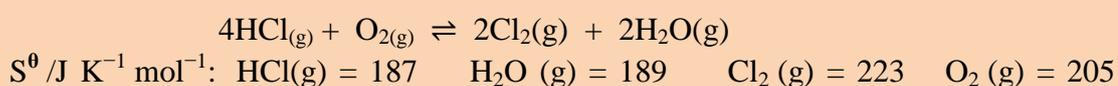

$$\Delta H_f^\circ / \text{kJ mol}^{-1}: \text{HCl(g)} = -92 \quad \text{H}_2\text{O(g)} = -242 \quad \text{Cl}_2(\text{g}) = 0 \quad \text{O}_2(\text{g}) = 0$$

2. Use the data below to calculate the lowest temperature at which the following reaction becomes feasible.

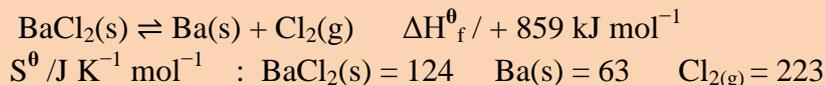

3. Calculate the entropy change when one mole of ethanol is evaporated at 351K the molar heat of vaporization of ethanol is $39.84 \text{ kJ mol}^{-1}$

15.4. Feasibility of chemical reactions: relationship between free energy, enthalpy and entropy feasibility

- Activity 15.4.**
1. Define exothermic and endothermic reaction
 2. What is the relation between enthalpy change and entropy of the reaction?
 3. Explain how a reaction is favored by the entropy.
 4. How the entropy and enthalpy make the reaction to be possible.

A spontaneous change is a change that happens naturally without any external factor. Some of the spontaneous processes proceed with a decrease in energy ($-\Delta H$). These reactions are exothermic (produces heat) and they proceed under the normal or standards conditions (at 25°C and 1 atm). The reactions that are endothermic (involving heat) are non-spontaneous at room temperature and they become spontaneous at higher temperatures.

There is a relationship between free energy, enthalpy, and entropy. We know that: $\Delta G = \Delta H - T\Delta S$, and a reaction is only thermodynamically favored when $\Delta G < 0$. If $\Delta G < 0$ the reaction may still not occur at a measurable rate because it has too high an activation energy. Like enthalpy, entropy is a state function as stated previously. It does not depend on how the substance arrived at the given state.

Therefore for a chemical reaction, the change in entropy (ΔS) under standard conditions is calculated as:

$$\Delta S_{\text{reaction}}^\circ = \sum \Delta S_f^\circ \text{ products} - \sum \Delta S_f^\circ \text{ reactants}$$

In other words, the standard entropies, ΔS° and free energy ΔG° are analogous to standard enthalpies of formation, ΔH_f°

$$\Delta H_{\text{reaction}}^\circ = \sum \Delta H_f^\circ \text{ products} - \sum \Delta H_f^\circ \text{ reactants}$$

And,

$$\Delta G_{\text{reaction}}^\circ = \sum \Delta G_f^\circ \text{ products} - \sum \Delta G_f^\circ \text{ reactants}$$

A relationship between entropy, enthalpy and free energy is given by the relation:

$$\Delta G^\circ = \Delta H^\circ - T\Delta S^\circ$$

ΔH° , ΔS° , and ΔG° may all be calculated from tables of standard values, from Hess' law or from the Gibb's equation. ΔH° and ΔG° are typically given in kJ mol^{-1} whereas ΔS° is typically given in $\text{JK}^{-1} \text{mol}^{-1}$.

The Table 15.3 shows the conditions of free energy in relation to enthalpy and entropy.

Table15.3. Relationship between entropy, enthalpy and free energy

Enthalpy Change (ΔH)	Entropy Change (ΔS)	Free energy change (ΔG)
Exothermic ($\Delta H < 0$)	Increase ($\Delta S > 0$)	Spontaneous at all the temperatures for $\Delta G < 0$
Exothermic ($\Delta H < 0$)	Decrease ($\Delta S < 0$)	Spontaneous at low temperature $ T\Delta S < \Delta H $
Endothermic ($\Delta H > 0$)	Increase ($\Delta S > 0$)	Spontaneous only at high temperatures if $T\Delta S > \Delta H$
Endothermic ($\Delta H > 0$)	Decrease ($\Delta S < 0$)	Non-spontaneous, $\Delta G > 0$ at all the temperatures

From the second law of thermodynamics, it can be deduced that all spontaneous reactions must result in an increase in entropy.

For the condition of feasibility, a reaction will be feasible when ΔG is negative (i.e. $\Delta G < 0$).

Note: The important application of the enthalpy change of reactions is to predict if the reaction is spontaneous or not, feasible or not.

- ✓ A *spontaneous reaction is one that occurs without extra energy being supplied to the system at a particular temperature*. For example ammonium nitrate dissolves in water at 298 K.
- ✓ A *feasible reaction is one that is thermodynamically possible but it might not occur spontaneously because there is very large activation energy to the reaction*. For example the formation of magnesium oxide is highly exothermic and ΔG has a high negative value, but magnesium does not burn spontaneously at 298 K because the reaction has high activation energy. The magnesium must be supplied with energy in the form of heat before it burns.

To determine if a reaction is feasible or not, the following relation is applied:

$$\Delta G^\circ = \Delta H^\circ - T\Delta S^\circ$$

If $\Delta G^\circ < 0$, the reaction is feasible and if $\Delta G^\circ > 0$, the reaction is unfeasible.

The feasibility of a reaction is affected by the temperature T, dictated by its enthalpy H and entropy S values.

If you know the entropy change and enthalpy change of the system, you can then calculate whether any reaction is feasible at any given temperature by using the equation below.

$$\Delta G^\circ = \Delta H^\circ - T\Delta S^\circ \gg \Delta H^\circ = \Delta G^\circ + T\Delta S^\circ$$

$$\Delta S^\circ = (\Delta H^\circ - \Delta G^\circ)/T$$

$$T = (\Delta H^0 - \Delta G^0) / \Delta S^0$$

To calculate temperature point of 'first' feasibility,

To determine if the reaction is feasible T is calculated when $\Delta G^0 = 0$

$$\Delta H^0_{\text{sys}} - T\Delta S^0_{\text{sys}} = 0,$$

If $\Delta G^0 = 0$, T can be deduced from the relation:

$$T = \frac{\Delta H^0_{\text{sys}} - \Delta G^0_{\text{sys}}}{\Delta S^0_{\text{sys}}} \Rightarrow T = \frac{\Delta H^0_{\text{sys}}}{\Delta S^0_{\text{sys}}}$$

Examples:

1. When gases come into contact, they diffuse to form a homogenous mixture. Instead of tidy arrangement of different molecules in different containers, the molecules become mixed up in a random arrangement. The pattern is that mass tends to become more disordered.
2. Potassium chloride dissolves endothermically. The solid is highly ordered arrangement of potassium ions and chloride ions. When it dissolves, this regular arrangement of potassium is replaced by a random distribution of ions in solution.

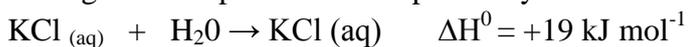

3. Predict whether ΔG will be positive, negative, probably positive, probably negative for the following types of reactions:
 - (a) exothermic accompanied by an increase in entropy of the reactant
 - (b) endothermic accompanied by an increase in entropy of the reactants
 - (c) exothermic accompanied by a decrease in entropy of the reactant
 - (d) endothermic accompanied by a decrease in entropy of the reactant
 - (e) can a change in temperature affect the sign of ΔG in 4 cases above

Answers: here we refer to the relation between the entropy free energy and enthalpy

- (a) negative because both ΔH and $(-T\Delta S)$ are negative
- (b) could be negative or positive because ΔH is negative and $(-T\Delta S)$ is negative
- (c) could be negative or positive because ΔH is negative and $(-T\Delta S)$ is positive
- (d) positive because both $(-T\Delta S)$ and ΔH are positive
- (e) in (a) no, ΔH and $(-T\Delta S)$ both are negative at all temperatures

In (b) yes at high T $(-T\Delta S)$ has high negative value and may have a positive ΔH

In (c) yes, negative ΔH could be positive $(-T\Delta S)$ at high temperature

In (d) no, ΔH and $(-T\Delta S)$ are both positive at all temperatures

Checking up 15.4

It requires 3.49 kJ of heat energy to convert 1.53 g of liquid water into steam at 373 K and 100 kPa.

- (i) Use the following data to calculate the enthalpy change, ΔH :
One mol of liquid water forms one mol of steam at 373 K and 100 kPa.
- (ii) Write an expression to express the relationship between free-energy change, ΔG , enthalpy change, ΔH , and entropy change, ΔS .
- (iii) For the conversion of liquid water into steam at 373 K and 100kPa, $\Delta G = 0 \text{ kJ mol}^{-1}$

Calculate the value of ΔS for the conversion of one mole of water into steam under these conditions. State the units.

15.5. End unit assessment

1. Explain the term entropy
Give the unit used to express the entropy
2. The sketch graph below shows how the entropy of a sample of water varies with temperature.

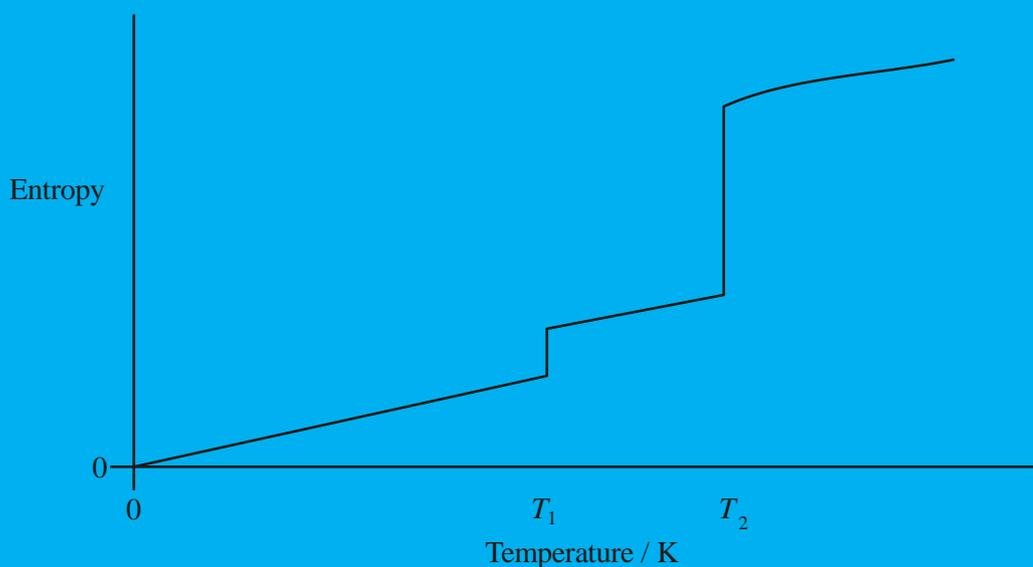

- (a) Suggest why the entropy of water is zero at 0 K.
- (b) What change of state occurs at temperature T_1 ?
- (c) Explain why the entropy change, ΔS , at temperature T_2 is much larger than that at temperature T_1 .

3.

(a) (i) Draw a fully-labelled Born–Haber cycle for the formation of solid barium chloride, BaCl_2 , from its elements. Include state symbols for all species involved.

(ii) Use your Born–Haber cycle and the standard enthalpy data given below to calculate a value for the electron affinity of chlorine.

Enthalpy of atomisation of barium	+180 kJ mol^{-1}
Enthalpy of atomisation of chlorine	+122 kJ mol^{-1}
Enthalpy of formation of barium chloride	-859 kJ mol^{-1}
First ionisation enthalpy of barium	+503 kJ mol^{-1}
Second ionisation enthalpy of barium	+965 kJ mol^{-1}
Lattice formation enthalpy of barium chloride	-2056 kJ mol^{-1}

- (b) Use data from part (a) (ii) and the entropy data given below to calculate the lowest temperature at which the following reaction becomes feasible.



	BaCl ₂ (s)	Ba(s)	Cl ₂ (g)
$S^\circ / \text{J K}^{-1} \text{ mol}^{-1}$	124	63	223

- 4) a) The following reaction occurs in the high-temperature preparation of titanium (IV) chloride.



- (i) Use the data given below to calculate the standard enthalpy change and the standard entropy change for this reaction.

Substance	TiO ₂ (s)	C(s)	Cl ₂ (g)	TiCl ₄ (l)	CO ₂ (g)
$\Delta H_f^\circ / \text{kJ mol}^{-1}$	-940	0	0	-804	-394
$S^\circ / \text{J K}^{-1} \text{ mol}^{-1}$	49.9	5.7	223	252	214

- (ii) Calculate the temperature at which this reaction ceases to be feasible.

- 5) Use the data in the table below to answer the questions which follow.

Substance	Fe ₂ O ₃ (s)	Fe(s)	C(s)	Co(g)	CO ₂ (g)
$\Delta H_f / \text{J mol}^{-1}$	-824.2	0	0	-110.5	-393.5
$S^\circ / \text{J K}^{-1} \text{ mol}^{-1}$	87.4	27.3	5.7	197.6	213.6

- (a) The following equation shows one of the reactions which can occur in the extraction of iron.



- (i) Calculate the standard enthalpy change and the standard entropy change for this reaction.
- (ii) Explain why this reaction is feasible at all temperatures.

- (b) The reaction shown by the following equation can also occur in the

standard free-energy change, ΔG° for the reaction **2** at 298 K.

	CH ₃ COCl(l)	C ₂ H ₅ OH(l)	CH ₃ COOC ₂ H ₅ (l)	HCl(g)
S° / JK	201	161	259	187

8) The equations for two industrial equilibrium reactions are given below.

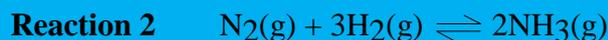

(a) Use the information in the table below to calculate the temperatures at which the free-energy change for each reaction is equal to zero.

	CH ₄	H ₂ O	CO	H ₂	N ₂	NH ₃
ΔH_f°	-74.8	-241.8	-110.5	0	0	-46.1
$S^\circ / J K^{-1} mol^{-1}$	186.2	188.7	197.6	130	191.6	192.3

(b) In industry, **Reaction 1** and **Reaction 2** are carried out at high temperatures. State how, using temperatures higher than those calculated in part (a), the yields of products are altered in **Reaction 1** and in **Reaction 2**. In each case, explain why a high temperature is used in practice.

9) (a) The reaction given below does not occur at room temperature.



Use the data given below to calculate the lowest temperature at which this reaction becomes feasible.

	C(s)	CO(g)	CO ₂ (g)
$\Delta H^\circ / kJ mol^{-1}$	0	-110.5	-393.5
$S^\circ / J K^{-1} mol^{-1}$	5.7	197.6	213.6

When an electrical heating coil was used to supply 3675 J of energy to a sample of water which was boiling at 373 K, 1.50 g water were vaporised. Use this information to calculate the entropy change for the process.

Bibliography

Chang, R. (2005). *Chemistry, Eighth Edition*. New York: McGraw-Hill.

Dakin, H., & West, R. (1928). *A general reaction of amino acids*. II. *Journal of Biological Chemistry*, 745-756. Retrieved Mars 25, 2018, from <http://www.jbc.org/content/78/3/745.citation>

Schmitz, A. (2018, March 25). *Introduction to Chemistry: General, Organic, and Biological* (v. 1.0). Retrieved from 18.1 Properties of Amino Acids: <https://2012books.lardbucket.org/books/introduction-to-chemistry-general-organic-and-biological/s21-01-properties-of-amino-acids.html>

Kazemi, F., Kiasat, A.R. and Mombaini, B. (2007). Simple preparation of symmetrical carboxylic acid anhydrides by means of $\text{Na}_2\text{CO}_3/\text{SOCl}_2$. *An International Journal for Rapid Communication of Synthetic Organic Chemistry*, 37(18): 3219-3223

E.N.Ramsden. (2000). *A-level chemistry*. United Kingdom: Nelson Thornes Ltd.

Holman, G. H. (1995). *Chemistry in context*. UK: Thomas Nelson and sons Ltd.

Petr Cann, P. H. (2002). *Chemistry for advanced level*. London: John Murray Ltd.

Daniel R.Bloch (2012), *Organic chemistry DeMYSTiFieD*, second edition, McGrawHill.

Graham Hill, J. H. (2000). *Chemistry in context, fifth edition*. Nerson Thornes.

Obot, K. (2003). *Organic chemistry for Advanced level*.

Rwanda Education Board. (2015). *Advanced level chemistry syllabus*. Kigali: PRINTEX.

Bruice, P. Y. (n.d.). *Organic Chemistry fourth Edition*.

COLLIN, A. (2008). *Advanced organic chemistry: exercises, eighth edition*.

D.Mukama, S. a. (2013). *Chemistry for Rwanda Secondary Schools, Advanced Level Senior 5*. Fountain.

Silver Obonyo, D. M. (2013). *Chemistry for Secondary Schools*. Fountain .

<http://www.zygia.com/study/book>

www.markedbyteachers.com

www.citycollegiate.com

<http://www.google.rw>

<https://www.chemguide.co.uk>