

Contents

Introduction	
A Complete Interconnect Solution	2-2
Markets and Applications	2-2
Range Overview	2-3
EPX® EN4644 and QM Quick Multipin	
EPX® EN4644	2-4
QM Quick Multipin	2-5
Mechanical and Environmental Characteristics	2-6
Inserts Arrangements for LuxCis® ARINC 801 Contact	2-6 to 2-8
How to Order Inserts	2-9
NSX ARINC 600	
Standards	2-10
Features and Benefits	2-10
Mechanical and Environmental Characteristics	2-10
Inserts Arrangements	2-10
How to Order Inserts	2-11
QUADRAX Adapters for LuxCis® ARINC 801 Contacts	2-12
R8 Series: MIL-DTL-38999 Type	
Standards	2-13
Features and Benefits	2-13
Mechanical and Environmental Characteristics	2-14
Shell Dimensions	2-14
Inserts Arrangements	2-15 to 2-16
How to Order R8 Connectors	2-17
R9 Series: Hermetic MIL-DTL-38999 Type	
Applications	2-18
Standards	2-18
Features and Benefits	2-18
Product Range	2-18
Mechanical and Environmental Characteristics	2-19
Shell Dimensions	2-19
LxC-R® Series: Single Channel	
Standards	2-20
Features and Benefits	2-20
Mechanical and Environmental Characteristics	2-21
Shell Dimensions	2-21
How to Order LxC-R® Connectors	2-22
Custom Design Connectors	2-23
Harnesses and Optical System Capability	2-23

Introduction

A COMPLETE INTERCONNECT SOLUTION

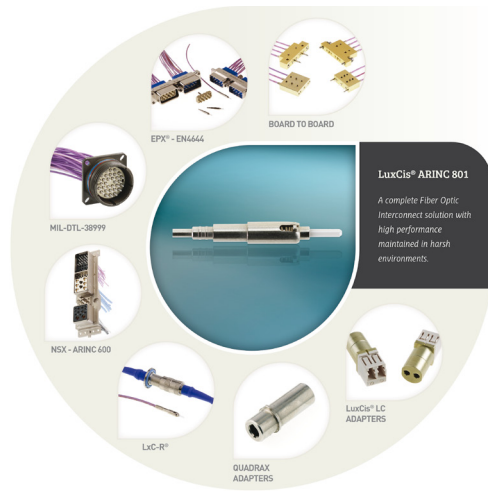

Radiall is recognized in the aerospace and defense industries for offering one of the broadest innovative product portfolios for interconnect solutions. The benefit of Radiall's experience with ARINC connectors and the high quality of the LuxCis® ARINC 801 contact enable Radiall to provide customers with strong and global solutions.

The combination of Radiall multipin connectors and LuxCis® ARINC 801 fiber optic contacts is the optimal solution for high and consistent performances in harsh environments.

MARKETS AND APPLICATIONS



Civil Aerospace

Airframe avionics, IFE (In-Flight Entertainment), HUD (Heads Up Display), power & flight management, pressurized and unpressurized area transmissions

Military Aerospace

Avionics, radar, weapons system, power & flight management

Data Transmissions

High speed data networking, including wavelength multiplexing, broadcast, radio signal

Radars

Remote antennas, phase array radar, military radio networking, satellite

Test Equipment

Modulator, repeater, transceivers, RF splitters and switches, measurement and test equipment in laboratories

Navy & Shipboard

Radar and missile system, communication

Geophysics

Oil & gas, mining, exploration with streamers arrays, roofers and shearing equipment

Sensors

Structural, environmental and airborne sensors



Introduction

RANGE OVERVIEW

Rectangular Connectors:



EPX® EN4644

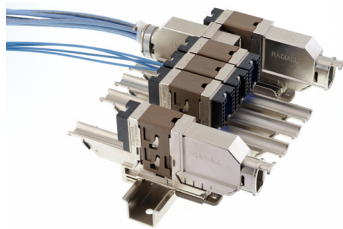

QM Quick Multipin



NSX ARINC 600

Circular Connectors:



R8 MIL-DTL-38999 type

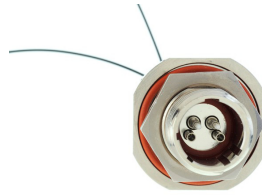

R9 Hermetic MIL-DTL-38999 type



LxC-R® single channel

Custom Design Connectors:

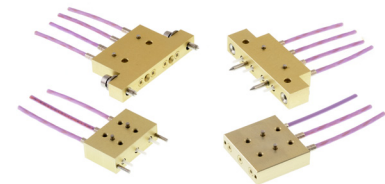

Board to board and custom design

Harnesses and Optical System Capability



Refer to the multipin catalog for more information on Radiall's wide multipin connector range.

EPX® EN4644 and QM Quick Multipin



EPX® EN4644 SERIES FOR LUXCIS® ARINC 801 CONTACTS

The EPX® EN4644 series offers a wide range of solutions based on two insert sizes with a large variety of shells, contacts and configurations. This product range provides an excellent trade-off between the number of available contacts and the space used. The EPX® series is completely modular and expandable.

STANDARDS

- RoHS compliant
- Compliant with EN4644 standard



FEATURES AND BENEFITS

- Designed and qualified for PC, UPC and APC (Angle Physical Contact) termination
- Optimized alignment of fiber optic contacts

High Density Solution

- Slim shell design with high contact density
- Higher density compared to circular MIL-spec connectors

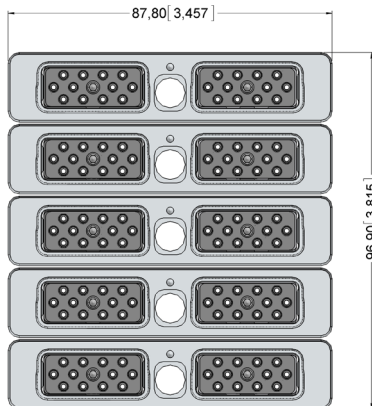

EPXB:

- 5 shells #2 with 2*12 LuxCis® ARINC 801 contacts
- Number of contacts: 120
- Total surface: $96.90 \times 87.80 = 8507.82 \text{ mm}^2$
- => Gives $70.90 \text{ mm}^2/\text{contact}$

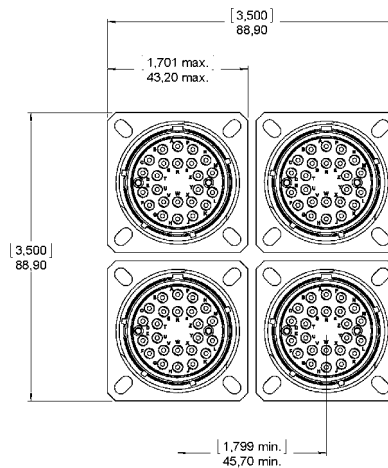

MIL-DTL-38999:

- 4 shells #23 with 24 LuxCis® ARINC 801 contacts
- Number of contacts: 96
- Total surface: $88.90 \times 88.90 = 7903.21 \text{ mm}^2$
- => Gives $82.32 \text{ mm}^2/\text{contact}$

Cost Saving & Convenient Solution

- Inserts can be easily installed and removed from the shell
- Inserts and shells are keyed to prevent mis-mating
- Standard MIL spec tools for contact crimping and contact insertion/extraction
- Vibration resistant self-locking threads
- Various options available to withstand harsh environments

Modular Concept

- Shell can accommodate a large variety of inserts for signal, power, coax, data bus, fiber optic and high frequency BMA contacts, providing various hybrid configurations
- EPX® inserts can also be used in the Radiall QM connectors
- Easy inspection, cleaning and manipulation of fiber optic contacts

EPX® EN4644 and QM Quick Multipin

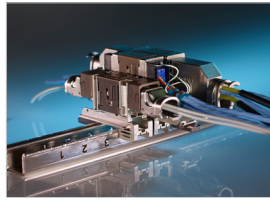

QM QUICK MULTIPIN SERIES FOR LUXCIS® ARINC 801 CONTACTS

A modular and tool less connector

Radiall QM connectors are designed for use with in-line disconnect applications on commercial airplanes. Radiall QM series offers outstanding performances and is designed with environmental and mechanical characteristics that provide long lasting durability needed for the most severe aerospace applications.

Two connector sizes are available in the QM series to optimize disconnect applications in terms of weight and density in an aircraft wiring system.

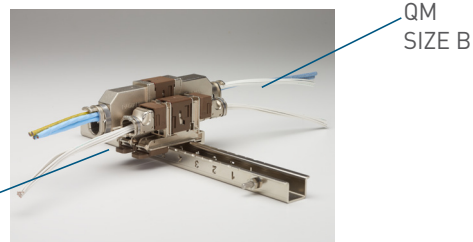

STANDARDS

- RoHS compliant



FEATURES AND BENEFITS

Using EPX® inserts, the QM series offers a wide array of arrangements that covers all contact technologies. It is manufactured under US patent App. No 11/614.642 and is available worldwide.

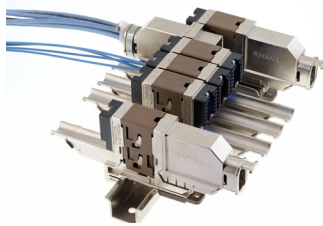

- Designed and qualified for APC (Angle Physical Contact) termination
- Optimized alignment of fiber optic contacts
- High conductive rails
- Save weight with composite connector
- Simplify the wiring design as no panel cut-out is needed
- Save time during wiring with a tool less connector

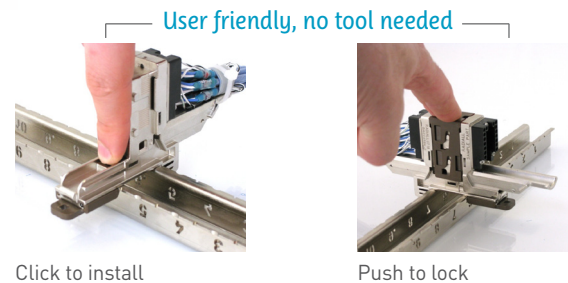

MECHANICAL AND ENVIRONMENTAL CHARACTERISTICS

Test	Standard	LuxCis® in EPX® EN4644 connectors	LuxCis® in QM connectors
Thermal cycling	SAE AS 13441 method 1003.1	-55°C/+125°C (cable dependent)	-55°C/+125°C (cable dependent)
Temperature endurance	TIA/EIA 455-4	1000 h @ 125°C (cable dependent)	1000 h @ 125°C (cable dependent)
Vibration	TIA/EIA 455-11	27 Grms	27 Grms
Shocks	TIA/EIA 455-14	50 G, 11 ms	50 G, 11 ms
Durability (mating/unmating)	TIA/EIA 364-09	100 cycles	50 cycles
Maintenance aging (Insertion/extraction)	SAE AS 13441 method 2002.1	10 cycles	10 cycles
Cable retention 1.88 mm diameter	SAE AS 13441 method 2009.1	68 N	68 N
Cable retention 0.9 mm diameter	SAE AS 13441 method 2009.1	7 N	7 N
Humidity	TIA EIA 455-5	10 cycles/24 h; 90% RH; -25°C/+65°C	10 cycles/24 h; 90% RH; -25°C/+65°C
Salt spray	SAE AS 13441 method 1001.1	96 h	96 h

Note: The LuxCis® ARINC 801 product range has passed many qualifications, including customer driven qualifications. Not all the tests performed on LuxCis® ARINC 801 products are described in the table above. Request for information on a test not mentioned in the table or harsher conditions shall be addressed to your local Radiall representative.

Our Most Important Connection is with You.™

EPX® EN4644 and QM Quick Multipin

INSERTS ARRANGEMENTS FOR LUXCIS® ARINC 801 CONTACT

Full size inserts arrangements are compliant with EN4644. Two sizes of inserts are available:

- EPXA inserts are size A
- EPXB inserts are size B

EPXA inserts fit in any QM size A connector

QM size A connector

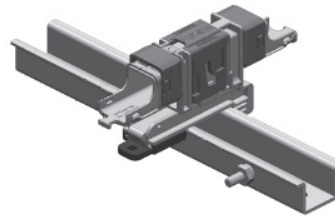

EPXB inserts fit in any EPXB and QM size B connector

QM Size B connector

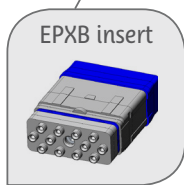
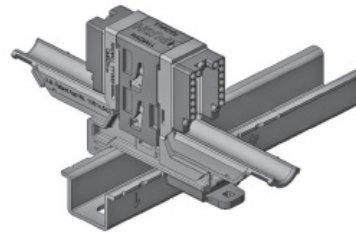

EPXB connectors for disconnect applications



EPXB1



EPXB2

EPXB connectors for rack & panel applications



EPXB1



EPXB2



EPXB3



EPXB4

EPX® EN4644 and QM Quick Multipin

ENVIRONMENTAL INSERTS

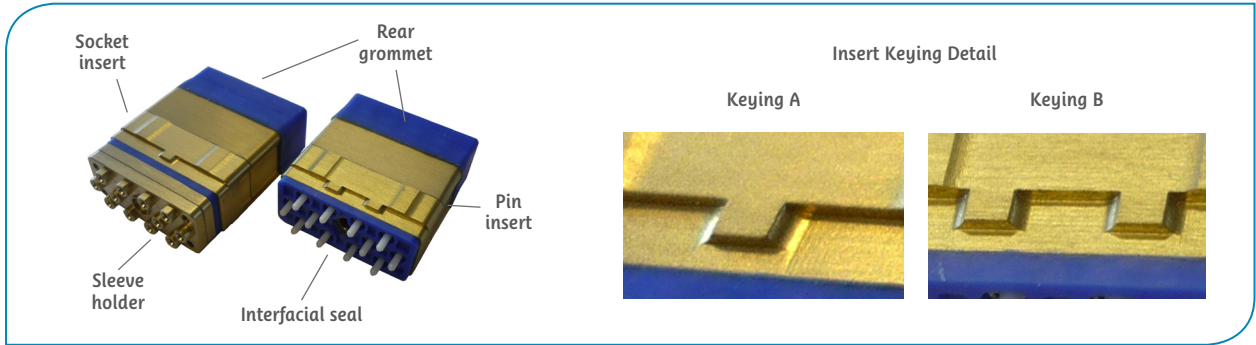

Notes: Inserts are designed for rear release and rear removable contacts.
Pin and socket inserts can be pre-installed in either plug or receptacle shells.

- For EPXB1, EPXB3 and EPXB4 shells, use only insert keyed A
- For EPXB2 shells, use one insert keyed A and one insert keyed B
- For QM size A and B connector, use only insert keyed A

HYBRID INSERTS

Due to specifically designed inserts, EPX® EN4644 and QM connectors enable the combination of LuxCis® ARINC 801 contacts and electrical contacts in the same shell cavity.

LuxCis® ARINC 801 fiber optic contacts

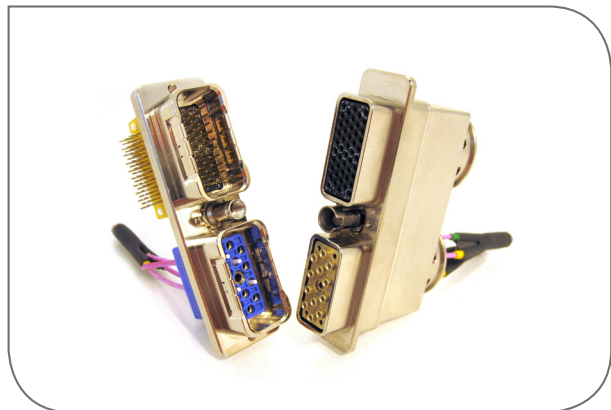
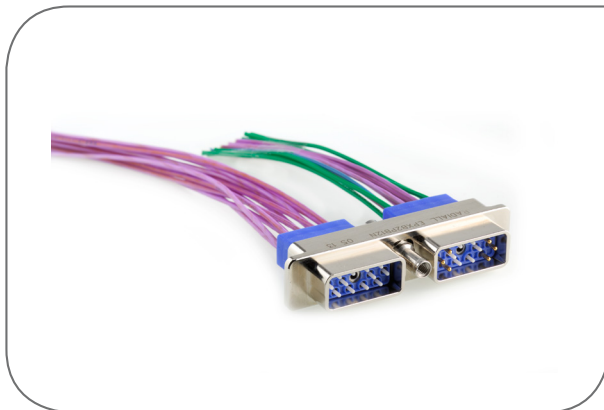
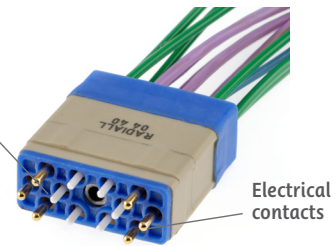

EPX® EN4644 and QM Quick Multipin

HOW TO ORDER INSERTS

LuxCis® ARINC 801 in EPX® and QM connectors requires standard EPX® or QM shells and dedicated LuxCis® ARINC 801 inserts.

Available part numbers for inserts to be mounted inside QM size A connectors:

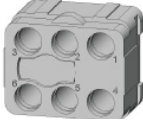
Insert Arrangement	Insert Type	Part Number
Insert F6: Full optic 6 LuxCis® ARINC 801 contacts 	Pin Inserts	EPXAEF6PA
	Socket Inserts	EPXAEF6SA

Available part numbers for inserts to be mounted inside EPXB or QM size B connectors:

	Insert Arrangement	Insert Type	Part Number for Keying A	Part Number for Keying B
	Insert F12C: full optic 12 LuxCis® ARINC 801 contacts	Pin insert	EPXBEF12CPA	EPXBEF12CPB
		Socket insert	EPXBEF12CSA	EPXBEF12CSB
	Insert 12F6: hybrid 6 LuxCis® ARINC 801 contacts and 6 electrical contacts	Pin insert	EPXBE12F6PA	EPXBE12F6PB
Socket insert		EPXBE12F6SA	EPXBE12F6SB	

Notes: Socket inserts are always supplied with a sleeve holder.

Pin inserts are not provided with sleeve holders.

Pin and socket inserts can be pre-installed in plug or receptacle shells.

All fiber optic inserts are also described in the ARINC 801 or EN4639 documents.

For more information on EPX® and QM connectors please refer to the latest version of the multipin catalog.

NSX ARINC 600



NSX ARINC 600 CONNECTORS FOR LUXCIS® ARINC 801 CONTACTS

Radiall's NSX ARINC 600 rack and panel connectors have been entrusted by the major aircraft manufacturers for many decades.

Used to connect high performance equipment in the aircraft's avionics bay, it features multiple LuxCis® ARINC 801 specific inserts, along with solutions to allow turning existing Quadrax cavities into LuxCis® ARINC 801 fiber optic cavities.

STANDARDS

- RoHS compliant
- Compliant with ARINC 600 standard



FEATURES AND BENEFITS

- Optimized alignment of fiber optic contacts
- High contact density
- Wide range of contact types and arrangements, including hybrid insert configurations
- Numerous shell polarization possibilities which give maximum security when mating the equipment in the rack
- Low mating forces
- EMI/RFI shielding option provided by shell to shell conductivity
- Convenient adapters that turn Quadrax cavities into LuxCis® ARINC 801 cavities to allow an easy evolution of electrical to optical

MECHANICAL AND ENVIRONMENTAL CHARACTERISTICS

Test	Standard	LuxCis® in NSX ARINC 600 Connectors
Thermal cycling	SAE AS 13441 method 1003.1	-55°C/+125°C (cable dependent)
Temperature endurance	TIA/EIA 455-4	1000 h @ 125°C (cable dependent)
Vibration	TIA/EIA 455-11	16.4 Grms
Shocks	TIA/EIA 455-14	50 G, 11 ms
Durability	TIA/EIA 364-09	500 cycles
Maintenance aging	SAE AS 13441 method 2002.1	10 cycles
Cable retention 1.88 mm diameter	SAE AS 13441 method 2009.1	68 N
Cable retention 0.9 mm diameter	SAE AS 13441 method 2009.1	7 N
Humidity	TIA/EIA 455-5	10 cycles/24 h; 90% RH; -25°C/+65°C
Salt spray	SAE AS 13441 method 1001.1	48 h

Note: The LuxCis® ARINC 801 product range has passed many qualifications, including customer driven qualifications. Not all the tests performed on LuxCis® ARINC 801 products are described in the table above. Request for information on a test not mentioned in the table or harsher conditions shall be addressed to your local Radiall representative.

NSX ARINC 600

INSERTS ARRANGEMENTS

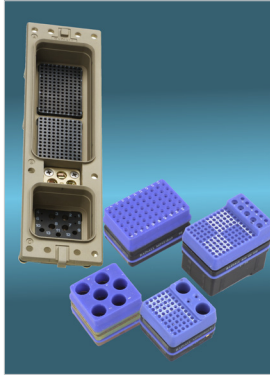

With more than 40 inserts available, 3 plating possibilities and a large number of accessories and options, Radiall's NSX range offers the widest choice of ARINC 600 connector configurations on the market to answer all types of requirements. Available for sizes 1 to 3, it features Environmental and Non-Environmental versions for rear and front removable contacts.

Offering from size 1 to size 22 crimp or PC tailed contacts - including signal, coax, triax and Quadrax - the NSX range allows mixing of fiber optic and signal channels within the same connector.

The NSX product range includes specific inserts that can accommodate up to 36 LuxCis® ARINC 801 contacts per cavity. Quadrax inserts can also accommodate LuxCis® ARINC 801 fiber optic contacts with a specific adapter in order to address a wide array of distinct needs.

HOW TO ORDER INSERTS

Insert Name	Shell Size	Cavity	Number of LuxCis® Contacts	Number of Quadrax Contacts	Other Contacts	Picture
12F5C2	2 or 3	C	5	-	1 contact #16 4 contacts #12 2 contacts #5	
12F12	1	C	12	-	-	
17F12Q2	2 or 3	C	12	2	3 contacts #16	
20F12Qw8	2 or 3	A or B	12	8	-	
62F12	2 or 3	C	12	-	50 contacts #22	
36F36	2 or 3	A or B	36	-	-	

Notes: The sleeve holder is delivered already installed on the insert on the receptacle side.

For more information on NSX ARINC 600 inserts please refer to the latest version of the multipin catalog.

NSX ARINC 600



QUADRAX ADAPTERS FOR LUXCIS® ARINC 801 CONTACTS

Adapters for NSX ARINC 600 connectors' cavities allow evolution of existing connectors. Now, a high speed connection with a connector that used to be equipped with Quadrax contacts is available. Quadrax/LuxCis® adapters will turn a size 8 Quadrax cavity into a LuxCis® ARINC 801 cavity. This solution offers the following characteristics:

- Compliant with any ARINC 600 and Quadrax cavity
- Compatible with ML and MT LuxCis® ARINC 801 designs
- Compatible with Quadrax insertion and extraction tool
- Available for MultiMode applications

HOW TO ORDER QUADRAX/LUXCIS® ADAPTERS

Description	Part Number	Picture
Pin Quadrax adapter for LuxCis® contact in Quadrax FR type cavity with sleeveholder	620 946 001	
Pin Quadrax adapter for LuxCis® contact in Quadrax RR type cavity with sleeveholder	620 946 002	
Socket Quadrax adapter for LuxCis® contact in Quadrax RR type cavity	620 946 003	
Sleeve holder for pin Quadrax adapter	620 946 004	

TOOLS

Part Number	Description
F780 858 000	Key for Quadrax sleeve holder removal
282 549 001	Extraction tool for Quadrax adapter; RR type (MIL-PRF-81969/28-03)
282 549 009	Extraction tool for Quadrax adapter FR type

RR: Rear Release

FR: Front Release

R8 Series: MIL-DTL-38999 Type



MIL-DTL-38999 TYPE CONNECTORS FOR LUXCIS® ARINC 801 CONTACTS

Radiall MIL-DTL-38999 for LuxCis® ARINC 801 fiber optic contact is a multi-channel connector that complies with the ARINC 801 specifications and 38999 Series III standards for the shells. This connector is available in various configurations, sizes and materials to deliver high performance in harsh environments.

Radiall MIL-DTL-38999 connector is a fiber optic solution for all defense and aerospace applications.

STANDARDS

- RoHS compliant (except for Aluminum olive drab cadmium finish)
- Compliant with ARINC 801 specifications
- Compliant with EN4645 standard



FEATURES AND BENEFITS

- Designed and qualified for PC, UPC and APC (Angled Physical Contact) termination
- Three stages of alignment:
 - Shell-to-shell keys
 - Alignment pins
 - Ceramic alignment sleeves
- Shell and locking mechanism compliant to MIL-DTL-38999 Series III standard:
 - Scoop-proof
 - Self-locking
 - Threaded coupling
- Rear grommet for direct sealing on the cable
- High contact density layouts available
- Wide range of accessories available to withstand harsh environments (backshells, protective caps, etc.)
- Hybrid versions
- Hermetic versions
- Easy inspection, cleaning and manipulation of fiber optic contacts with removable sleeve holders
- EMI shielding capability, with anodized aluminum

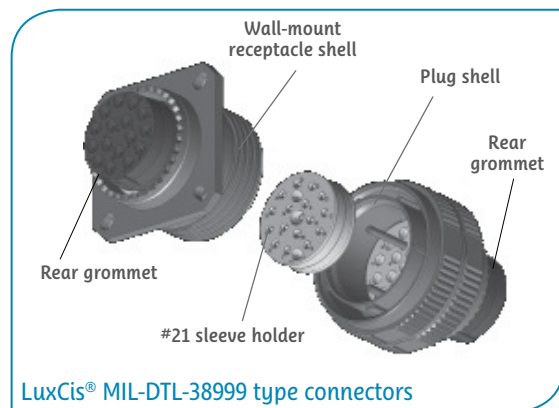

R8 Series: MIL-DTL-38999 Type

MECHANICAL AND ENVIRONMENTAL CHARACTERISTICS

Test	Standard	LuxCis® in R8 MIL-DTL-38999 Connectors
Thermal cycling	SAE AS 13441 method 1003.1	-55°C/+125°C (cable dependent)
Temperature endurance	TIA/EIA 455-4	1000 h @ 125°C (cable dependent)
Vibration	TIA/EIA 455-11	43 Grms 60 G sinus
Shocks	TIA/EIA 455-14	300 G, 3 ms
Durability	TIA/EIA	500 cycles
Maintenance aging	SAE AS 13441 method 2002.1	10 cycles
Cable retention 1.88 mm diameter	SAE AS 13441 method 2009.1	68 N
Cable retention 0.9 mm diameter	SAE AS 13441 method 2009.1	7 N
Humidity	TIA/EIA 455-5	10 cycles/24 h; 90% RH; -25°C/+65°C
Salt spray	SAE AS 13441 method 1001.1	2000 h

Note: The LuxCis® ARINC 801 product range has passed many qualifications, including customer driven qualifications. Not all the tests performed on LuxCis® ARINC 801 products are described in the table above. Request for information on a test not mentioned in the table or harsher conditions shall be addressed to your local Radiall representative.

SHELL DIMENSIONS

Square Flange and Jam Nut Receptacle Dimensions

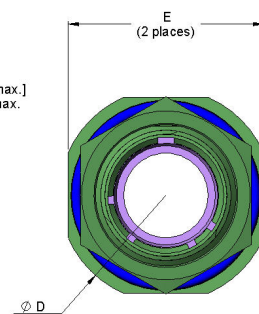
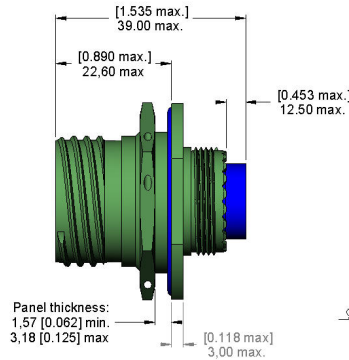
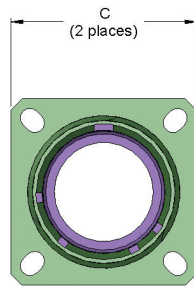
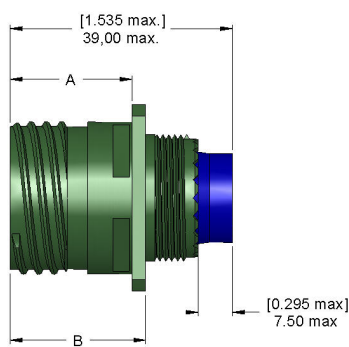

Fig. 1 Square flange receptacle

Fig. 2 Jam nut receptacles

Shell Size	Figure 1				Figure 2		
	A max. mm (inch)		B max. mm (inch)		C max. mm (inch)	Dia. D max. mm (inch)	E max. mm (inch)
	Metallic Shell	Composite Shell	Metallic Shell	Composite Shell			
11	20.83 [0.820]	19.69 [0.775]	23.15 [0.911]	23.19 [0.913]	26.50 [1.043]	35.20 [1.386]	32.20 [1.268]
13					28.90 [1.137]	38.40 [1.512]	35.30 [1.390]
15					31.30 [1.232]	41.60 [1.638]	38.50 [1.516]
17					33.70 [1.323]	44.80 [1.764]	41.70 [1.642]
19					36.90 [1.449]	49.50 [1.949]	46.40 [1.827]
21	20.07 [0.790]	18.92 [0.745]	23.14 [0.911]	23.14 [0.911]	40.10 [1.575]	52.70 [2.075]	49.60 [1.953]
23					43.30 [1.701]	55.90 [2.200]	52.80 [2.079]
24					45.70 [1.800]	59.10 [2.323]	56.00 [2.205]
25					46.40 [1.823]	59.00 [2.323]	56.00 [2.205]

R8 Series: MIL-DTL-38999 Type

Panel Cut-Out Dimensions Square Flange Receptacle

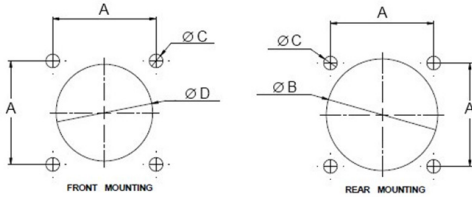

Shell Size	A max. mm (inch)	Dia. B max. mm (inch)	Dia. C max. mm (inch)	Dia. D max. mm (inch)
11	20.62 [0.812]	20.22 [0.796]	3.12 [0.123]	18.26 [0.719]
13	23.01 [0.906]	23.42 [0.922]	3.12 [0.123]	20.62 [0.812]
15	26.97 [0.969]	26.59 [1.047]	3.12 [0.123]	23.01 [0.906]
17	24.61 [0.062]	30.96 [1.219]	3.12 [0.123]	24.61 [0.969]
19	29.36 [1.156]	32.94 [1.297]	3.12 [0.123]	26.97 [1.062]
21	31.75 [1.250]	36.12 [1.422]	3.12 [0.123]	29.36 [1.156]
23	34.93 [1.375]	39.29 [1.547]	3.78 [0.149]	31.75 [1.250]
25	38.10 [1.500]	42.47 [1.672]	3.78 [0.149]	34.93 [1.375]

Jam Nut Receptacle

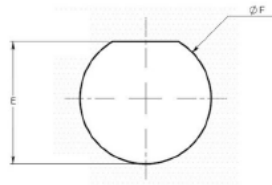
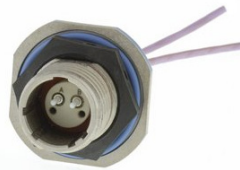

Shell Size	Dia. E max. mm (inch)	Dia. F max. mm (inch)
11	19.28 [0.729]	20.88 [0.822]
13	24.01 [0.945]	25.58 [1.007]
15	27.28 [1.074]	28.80 [1.134]
17	30.43 [1.198]	31.98 [1.259]
19	33.61 [1.323]	35.15 [1.384]
21	36.81 [1.449]	38.28 [1.507]
23	39.99 [1.574]	41.50 [1.634]
25	43.16 [1.699]	44.68 [1.759]

Plug Dimensions

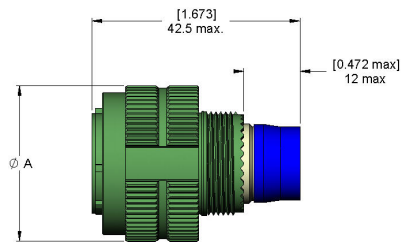

Shell Size	Dia. A max. mm (inch)
11	25.00 [0.984]
13	29.40 [1.157]
15	32.50 [1.280]
17	35.70 [1.405]
19	38.50 [1.516]
21	41.70 [1.642]
23	44.90 [1.768]
25	48.00 [1.890]

R8 Series: MIL-DTL-38999 Type

INSERT ARRANGEMENTS

Optical Insert Arrangements

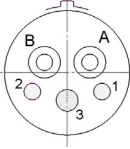
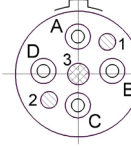
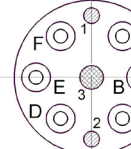
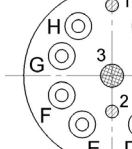
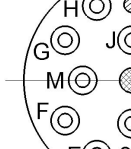
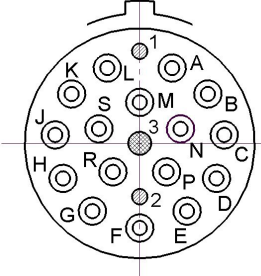
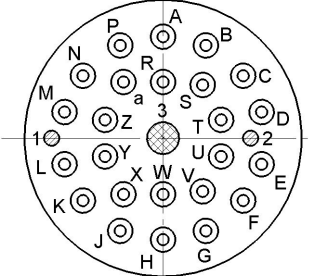
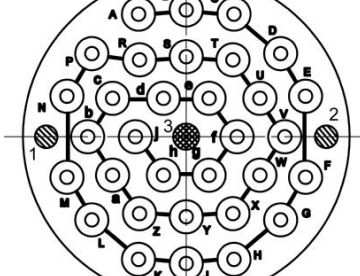
				
Size 11 for 2 LuxCis® contacts	Size 13 for 4 LuxCis® contacts	Size 15 for 6 LuxCis® contacts	Size 17 for 8 LuxCis® contacts	Size 19 for 12 LuxCis® contacts
				
Size 21 for 16 LuxCis® contacts	Size 23 for 24 LuxCis® contacts	Size 25 for 32 LuxCis® contacts		

All views show the front face of a plug.

Hybrid Insert Arrangements

The LuxCis® ARINC 801 product range also includes hybrid connectors, mixing electrical and optical contacts. Hybrid connectors are available in various sizes. For any additional information, please contact your local Radiall representative.

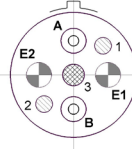
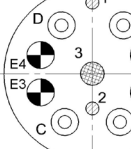
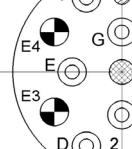
		
Size 13 for 2 electrical contacts and 2 LuxCis® contacts	Size 17 for 4 electrical contacts and 4 LuxCis® contacts	Size 19 for 4 electrical contacts and 8 LuxCis® contacts

Legend:

1 & 2: Alignment pins

3: Sleeve-holder screw

A & B: Optical cavities

E1 & E2: Electrical cavities (Refer to Technical Data Sheet to see the exact marking on the connector)

R8 Series: MIL-DTL-38999 Type

HOW TO ORDER R8 CONNECTORS

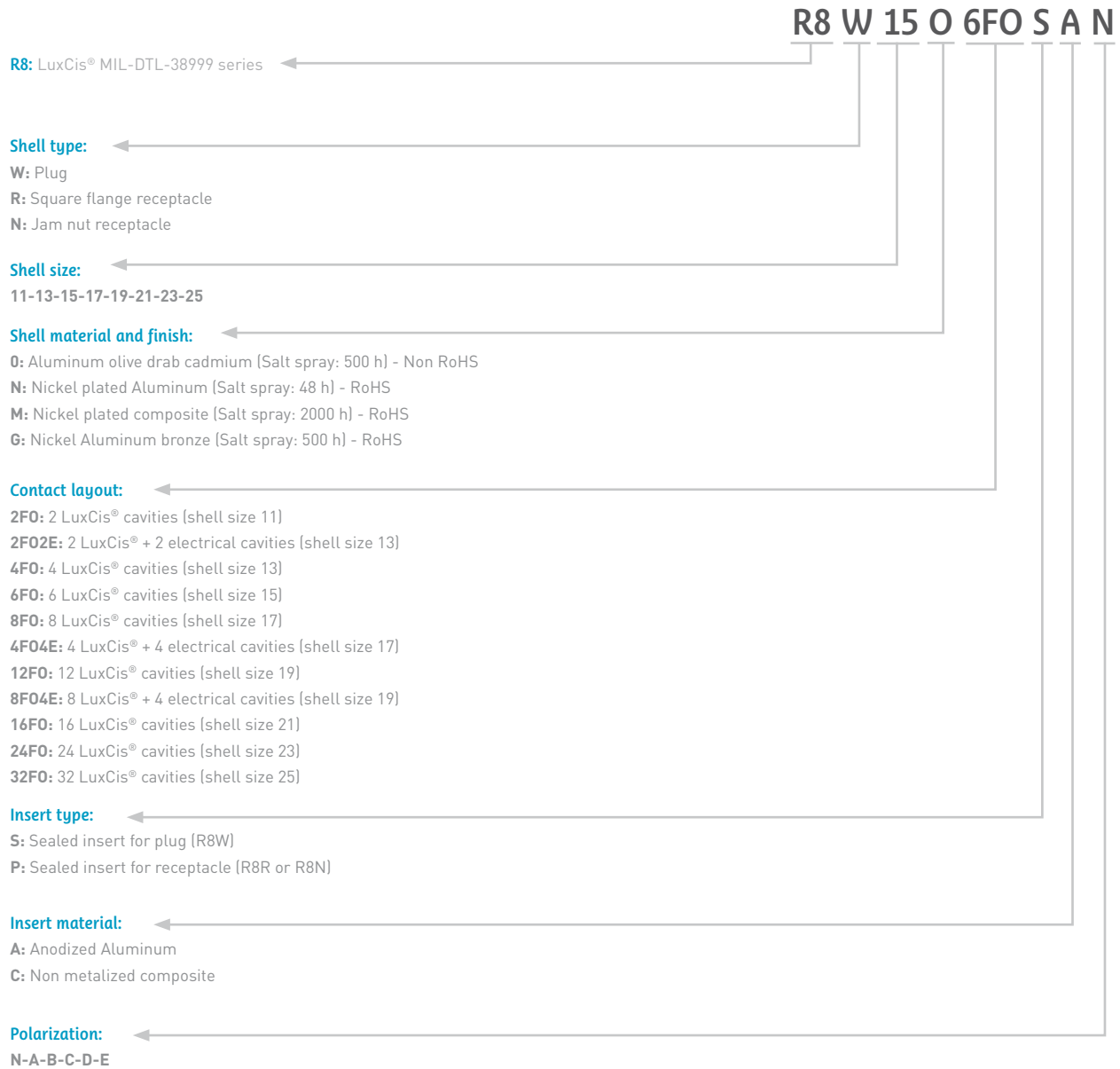

All connectors are supplied with a plastic cap. All connectors are delivered without contacts.

Plugs are delivered with sleeve holders.

Accessories such as backshells or metalized caps must be ordered separately.

Material and weight information are available upon request.

Don't hesitate to contact us for specific requirements such as custom configurations.

Radiall can support your cable assembly needs. Refer to Section 9 for our cable and harness assemblies.

R9 Series: Hermetic MIL-DTL-38999 Type



HERMETIC MIL-DTL-38999 TYPE CONNECTORS FOR LUXCIS® ARINC 801 CONTACTS

The LuxCis® ARINC 801 product range also includes an hermetic version of the proven 38999 multi-channel connector. Radiall's R9 series provides high level of hermeticity and complies with ARINC specifications and 38999 series III dimensions.

APPLICATIONS

For harsh environment applications, the LuxCis® hermetic MIL-DTL-38999 type connectors are an optimal solution when secure and hermetic connection is required:

- Pressurized/unpressurized transitions
- Sensors in specific gas environments
- Pressurized box

STANDARDS

- Compliant with ARINC 801 specifications
- RoHS compliant



FEATURES AND BENEFITS

HERMETICITY: 10⁻⁷ bar.cm³/s

- Designed on MIL-DTL 38999 type connector parameters
- Sealed and robust connection
- Optimized alignment of fiber optic contacts
- Designed and qualified for PC, UPC and APC terminations
- Material: Nickel Plated Aluminum
- Resists to moisture ingress and operates at high altitudes, under extreme atmospheric pressure and in fast changing temperature conditions

PRODUCT RANGE

- Available in pigtail solution to mate with all MIL-DTL-38999 type connector sizes 11, 13, 15 and 21
- Various pigtail lengths available
- A bulkhead feed through adapter solution is also available

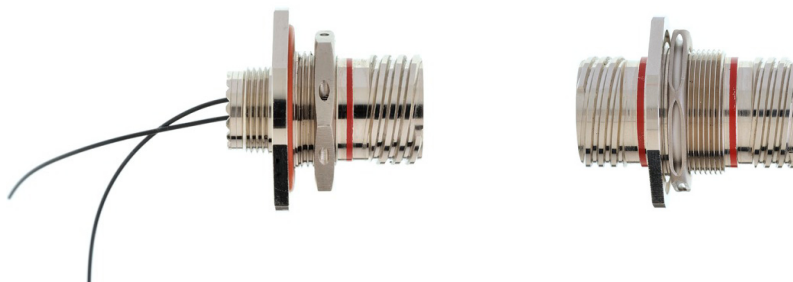

R9 Series: Hermetic MIL-DTL-38999 Type

MECHANICAL AND ENVIRONMENTAL CHARACTERISTICS

Test	Standard	LuxCis® in R9 Hermetic pigtailed MIL-DTL-38999 Connector
Thermal cycling	EIA-364-32C test condition 1	-55°C/+100°C
Salt spray	EIA-364-26B test condition A	96 hours
Temperature life	TIA/EIA-455-4C, code 3, condition D	1000 h at 85°C
Connector durability	EIA-364-09C, 100 cycles	100 mating cycles
Random vibration	TIA/EIA-455-11, condition C	23.1 Grms
Shocks	TIA/EIA-455-14, condition A	300 G, 3 ms
Humidity	TIA/EIA-455-5C	96 h, +40°C, relative humidity 95%
Air leakage	TIA/EIA-464-12-15A	He 10-7 bar.cm3/s

SHELL DIMENSIONS

R9 jam nut hermetic pigtailed receptacle

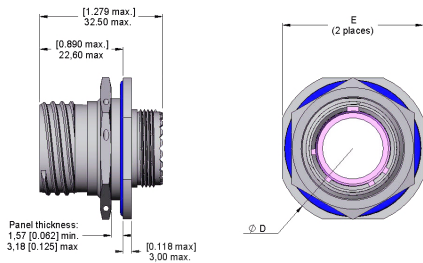

Shell Size	E max. mm (inch)	Dia. D max. mm (inch)
11	32.20 (1.268)	35.20 (1.386)
13	35.30 (1.390)	38.40 (1.512)
15	38.50 (1.516)	41.60 (1.638)
21	49.60 (1.953)	52.70 (2.075)

Panel cut out

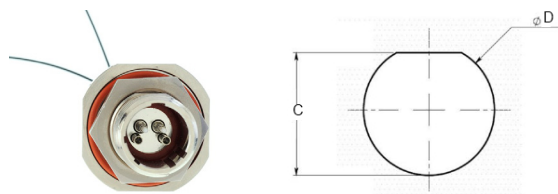

Shell Size	C max. mm (inch)	Dia. D max. mm (inch)
11	19.28 (0.729)	20.88 (0.822)
13	24.01 (0.945)	25.58 (1.007)
15	27.28 (1.074)	28.80 (1.134)
21	36.81 (1.449)	38.28 (1.507)

For any additional information, please contact your local Radiall representative.

LxC-R® Series: Single Channel

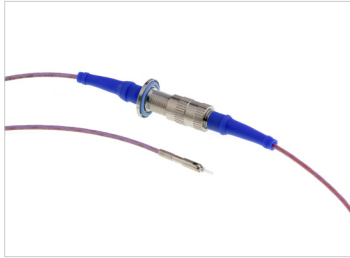

Miniature and robust, this unique single channel connector is ideally suited for applications requiring a single high-performance transmission in extreme environments such as in aerospace and military equipment. Specifically designed to be compatible with the industry standard LuxCis® ARINC 801 fiber optic contact, the LxC-R® is qualified to withstand high levels of vibrations and shocks.

The flexibility of the LuxCis® ARINC 801 contact allows the use of either MultiMode or SingleMode fibers for both PC and APC terminations. The LxC-R® product range includes plugs, square flange and jam nut receptacles, as well as hermetic configurations.

STANDARDS

- RoHS compliant



FEATURES AND BENEFITS

High Performance

- Optimized alignment of LuxCis® ARINC 801 fiber optic contacts
- Designed and qualified for PC, UPC and APC terminations
- Hermetic version available

Direct Sealed Connection: IP67 Level

- Interfacial gasket: shell to shell sealing
- Jam nut receptacle with O-ring for panel sealing
- Sealing boot: environmental grommet also guiding the fiber at the rear of the connector

Easy to Install

- Screwing locking mechanism
- Easy insertion/extraction of the LuxCis® ARINC 801 contact using M81969/14-03 standardized tool (Radiall PN 282 515)

Robust Single Connection

- Full pull-proof design with loose structure cable
- Anti-vibration coupling mechanism
- Two polarization keys available: 90° or 120°
- Small form factor

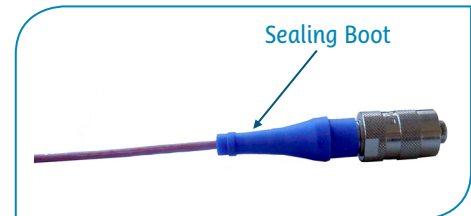
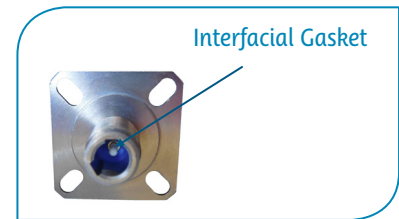

LxC-R® AND SIZE 9 MIL-DTL-38999 CONNECTOR COMPARISON:

Connector's front view

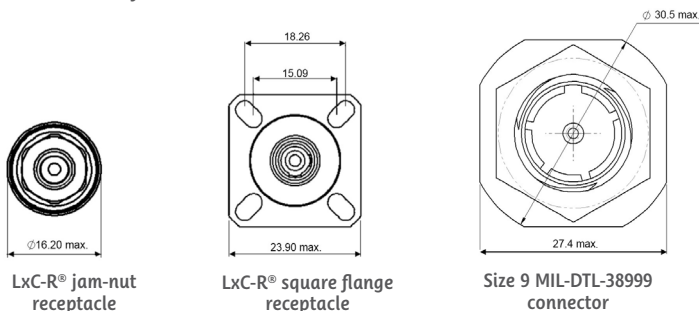

LxC-R® Series: Single Channel

MECHANICAL AND ENVIRONMENTAL CHARACTERISTICS

Test	Standard	LuxCis® in LxC-R® Connectors
Thermal cycling	SAE AS 13441 method 1003.1	-65°C/+155°C (cable dependent)
Temperature endurance	TIA/EIA 455-4	1000 h @ 125°C (cable dependent)
Vibration	TIA/EIA 455-11	50 Grms
Shocks	TIA/EIA 455-14	300G, 3 ms
Durability	TIA/EIA 364-09	500 cycles
Maintenance aging	SAE AS 13441 method 2002.1	10 cycles
Cable retention 1.8 mm diameter 900 µm diameter	SAE AS 13441 method 2009.1	68 N 7 N
Humidity	TIA/EIA 455-5	10 cycles/24 h; 90% RH; -25°C/+65°C
Salt spray	SAE AS 13441 method 1001.1	96h for LXCRxxxxxAxx 500h for LXCRxxxxxLxx

SHELL DIMENSIONS

Plug Dimensions

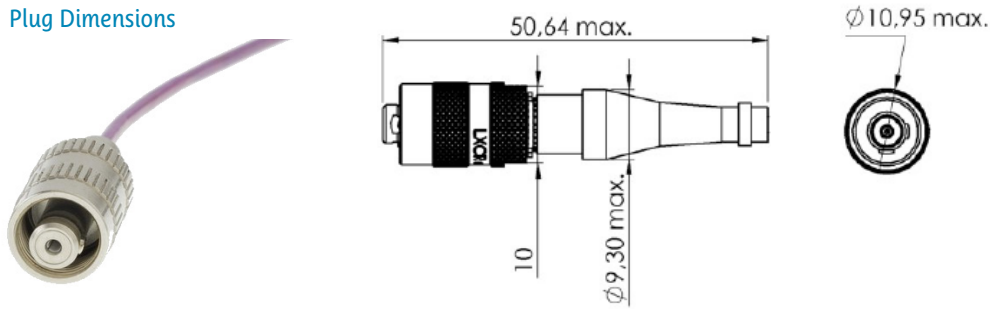

Square Flange Receptacle Dimensions

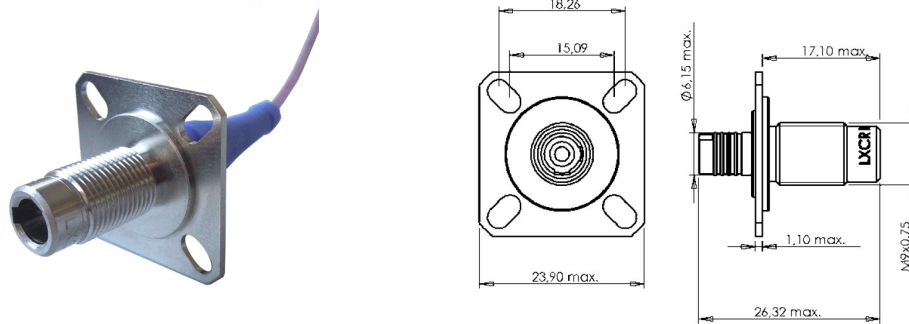

Mounting Dimensions

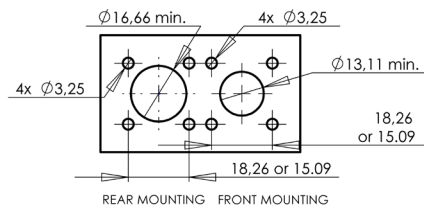

LxC-R® Series: Single Channel

Jam Nut Receptacle Dimensions

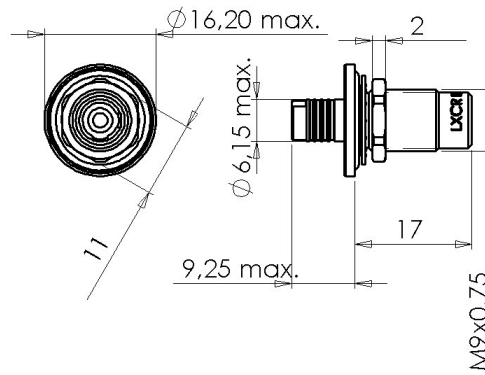

Mounting Dimensions

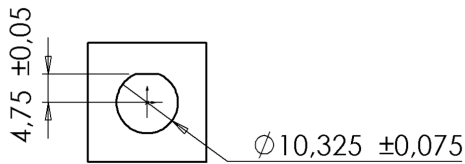

HOW TO ORDER LxC-R® CONNECTORS

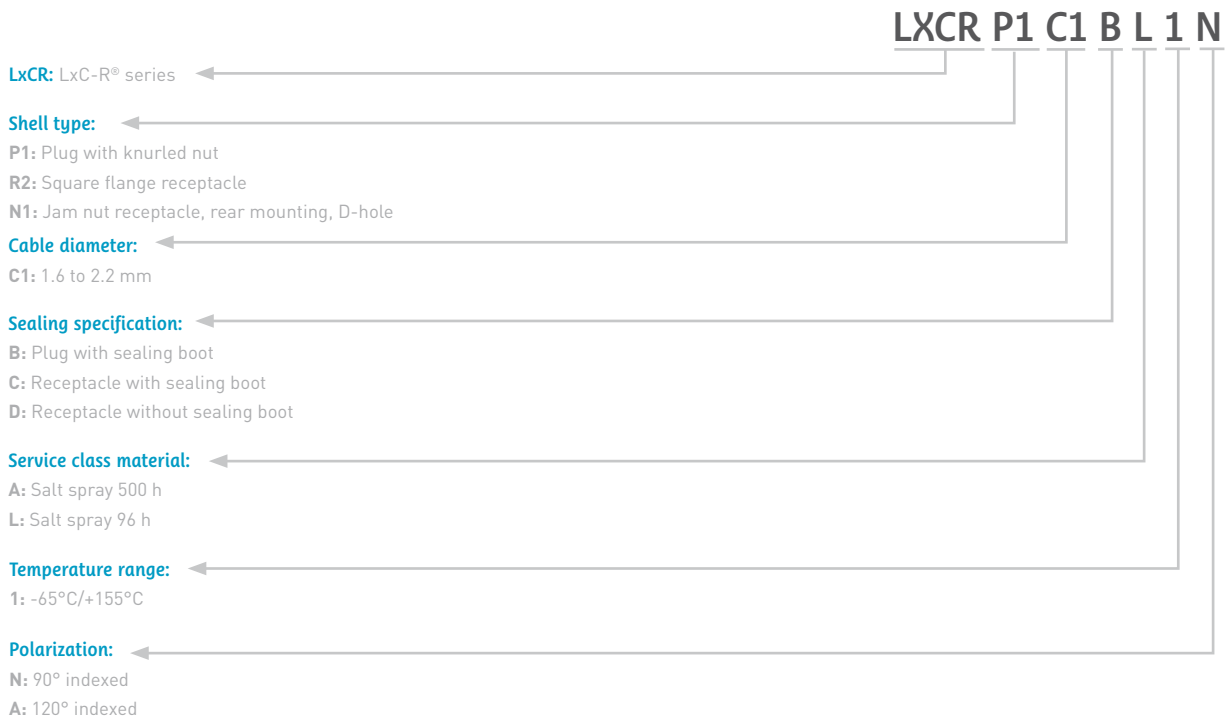

Notes: Plugs and receptacles are delivered with plastic caps. Metallic caps and other accessories are available on upon request

Custom Design Connectors

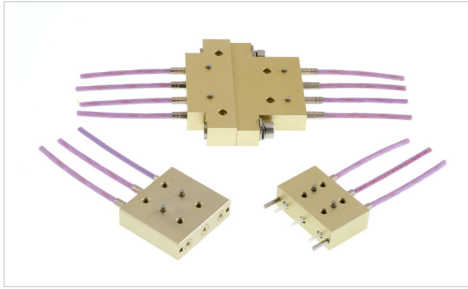

Radiall also designs LuxCis® ARINC 801 connectors to meet customers' footprints and space on the board, in the box or at the box interface.

Each connector integrates a number of LuxCis® ARINC 801 cavities and the locking mechanism depends on the application and the environment required by the customer.

Please contact your sales representative for a custom LuxCis® ARINC 801 connector.

Harnesses and Optical System Capability

OPTICAL SYSTEM CAPABILITY

Radiall's design and manufacturing expertise, together with its wide interconnect product offerings, enable Radiall to meet customers' needs for custom harness solutions. We can provide support for optical links requiring excellent performance and ease of installation, as well as develop application specific accessories or interconnect solutions when required.

Radiall is able to support a wide range of requirements, from simple contact and connector solutions to the most complex fiber optic based harnesses or sub systems for harsh environments.



Refer to Section 9 for more information on Radiall's optical systems, harnesses and cable assembly capabilities. For any additional information, please contact your local Radiall representative