

- Navigation Lites
- Steering/ Controls
- Hardware/ Fasteners
- Covers/ Windshield
- Pumps/ Int. Lite
- Electric/ Battery
- Trolling Motor
- Gauges
- Electronics/ Radios
- Fuel
- Lube/ Motor Care
- Aux. Brkts/ Tilt/Trim
- Spark Plug/ Starters
- Props
- Seats/ Pedestals
- Anchor/ Rod Holder
- Winches/ Jacks
- Lites/ Tie Downs
- Tires/ Couplers
- Boat Care
- Misc./ Flooring
- Ski's/Tubes
- Floatation
- Ladders
- Water Front
- Fenders/ Dock Lines



Spoked



Modular



Tire and Wheel Assemblies

| Conversion Chart | |
|------------------|-------------|
| A78-13.....(NLA) | ST165 |
| B78-13..... | ST175/80D13 |
| C78-13..... | ST185/80D13 |
| F78-14..... | ST205/75D14 |
| G78-14..... | ST215/75D14 |
| H78-15..... | ST225/75D15 |

| Ply Equivalency Chart | |
|-----------------------|----------|
| A= 2 ply | C= 6 ply |
| B= 4 ply | D= 8 ply |

| LOAD STAR <small>High Speed Trailer Tires</small> | | Tire Size | Range | Rim | Hole Pattern | Order No. | Retail |
|---|-----------------------------|-----------|----------|----------|-----------------------------|-----------------------------|---------|
| Highway Trailer Bias Tires & Wheels (White Rims) | | 4.80 x 8 | B | Standard | 4 | 16008 ^{THF} | \$45.99 |
| | | 4.80 x 8 | B | Standard | 5 | 16012 ^{THF} | 45.99 |
| | | 5.70 x 8 | C | Standard | 4 | 16016 ^{THF} | 70.49 |
| | | 5.70 x 8 | C | Standard | 5 | 16020 ^{THF} | 70.49 |
| | | 4.80 x 12 | B | Spoked | 4 | 16069 ^{THF} | \$74.99 |
| | | 4.80 x 12 | B | Spoked | 5 | 16070 ^{THF} | 74.49 |
| | | 4.80 x 12 | B | Modular | 5 | 16033 ^{THF} | 74.49 |
| | | 5.30 x 12 | C | Spoked | 4 | 16024 ^{THF} | 87.99 |
| | | 5.30 x 12 | C | Spoked | 5 | 16029 ^{THF} | 87.49 |
| | | 5.30 x 12 | C | Modular | 5 | 16026 ^{THF} | 87.49 |
| | 215/60 x 8 (18.5/8.5 x 8) | C | Standard | 5 | 16023 ^{THF} | \$92.99 | |
| | 205/65 x 10 (20.5/8.0 x 10) | E | Standard | 5 | 16027 ^{THF} | 135.99 | |

| LOAD STAR <small>High Speed Trailer Tires</small> | | Tire Mfg. | Tire Size | Range | Rim | Holes | Order No. | Retail |
|---|--|-----------|--------------|-------|---------|-------|-----------------------------|----------|
| Metric Bias Tires And Wheels (White Rims) | | Load Star | ST175/80D-13 | B | Spoked | 4 | 16088 ^{THF} | \$113.99 |
| | | Load Star | ST175/80D-13 | B | Spoked | 5 | 16066 ^{THF} | 113.99 |
| | | Load Star | ST175/80D-13 | B | Modular | 5 | 16067 ^{THF} | 113.99 |
| | | Load Star | ST175/80D-13 | C | Spoked | 4 | 16089 ^{THF} | 119.99 |
| | | Load Star | ST175/80D-13 | C | Spoked | 5 | 16073 ^{THF} | 119.99 |
| | | Load Star | ST185/80D-13 | C | Spoked | 5 | 16062 ^{THF} | 139.99 |
| | | Load Star | ST205/75D-14 | C | Spoked | 5 | 16068 ^{THF} | 154.99 |
| | | Load Star | ST215/75D-14 | C | Spoked | 5 | 16072 ^{THF} | 180.49 |
| | | Load Star | ST225/75D-15 | D | Spoked | 5 | 16071 ^{THF} | 204.49 |
| | | Load Star | ST225/75D-15 | D | Spoked | 6 | 16083 ^{THF} | 205.49 |

|  | | Directional Silver Wheels w/Black Rivets | | | |  | |
|---|---|--|-------|---------------------------|--------|---|----------|
| | | Tire Size | Range | Rim | Holes | Order No. | Retail |
| | | ST175/80D13 | C | Directional | 5 | 16302 ^T | \$106.99 |
| | | ST175/80R13 | C | Directional | 5 | 16303 ^T | 123.99 |
| | | ST205/75R14 | C | Directional | 5 | 16304 ^T | 150.99 |
| ST215/75R14 | C | Directional | 5 | 16306 ^T | 169.99 | | |

Tire and Wheel Assemblies



Spoked



Modular

Metric Radial Tires And Wheels (White Rims)

| Tire Size | Range | Rim | Holes | Order No. | Retail |
|--------------|-------|--------|-------|--------------------------|----------|
| ST175/80R-13 | C | Spoked | 5 | 16187_T | \$162.99 |
| ST185/80R-13 | C | Spoked | 5 | 16188_T | 171.99 |
| ST205/75R-14 | C | Spoked | 5 | 16190_T | 194.99 |
| ST215/75R-14 | C | Spoked | 5 | 16192_T | 211.99 |

| Tire Size | Range | Rim | Holes | Order No. | Retail |
|--------------|-------|---------|-------|--------------------------|----------|
| ST175/80R-13 | C | Modular | 5 | 16194_T | \$162.99 |
| ST185/80R-13 | C | Modular | 5 | 16196_T | 171.99 |
| ST205/75R-14 | C | Modular | 5 | 16198_T | 194.99 |
| ST215/75R-14 | C | Modular | 5 | 16200_T | 211.99 |



Silver Painted Wheels - used on Shoreland'r - 2001-2007

| Tire Mfg. | Tire Size | Range | Rim | Holes | Order No. | Retail |
|-----------|--------------|-------|-------------|-------|----------------------------|----------|
| Load Star | 4.80 x 12 | B | Modular | 5 | 16242_{THF} | \$74.49 |
| Load Star | 5.30 x 12 | C | Modular | 5 | 16244_{THF} | 87.49 |
| Load Star | 5.30 x 12 | C | Blade | 5 | 16028_{THF} | 87.49 |
| GoodYear | 175/80R13ST | C | Directional | 5 | 16248_T | \$157.99 |
| GoodYear | 185/80R13ST | C | Directional | 5 | 16250_T | 166.99 |
| GoodYear | ST205/75R-14 | C | Directional | 5 | 16251_T | 196.99 |
| GoodYear | 215/75R14ST | C | Directional | 5 | 16252_T | 210.99 |



LOAD STAR
High Speed Trailer Tires



Silver Painted
Used on
Karavan



Galvanized
Used on
Karavan

Metric Bias

| Tire Size | Range | Rim | Holes | Order No. | Retail |
|-------------|-------|--------|-------|----------------------------|---------|
| 4.80 x 12 | C | Spoked | 5 | 16049_{THF} | \$75.99 |
| 5.30 x 12 | C | Spoked | 5 | 16052_{THF} | 87.49 |
| ST175/80D13 | B | Spoked | 5 | 16047_{THF} | 113.99 |
| ST175/80D13 | C | Spoked | 5 | 16050_{THF} | 119.99 |
| ST185/80D13 | C | Spoked | 5 | 16046_{THF} | 139.99 |
| ST205/75D14 | C | Spoked | 5 | 16051_{THF} | 154.99 |
| ST215/75D14 | C | Spoked | 5 | 16053_{THF} | 180.49 |

| Tire Size | Range | Rim | Holes | Order No. | Retail |
|-----------|-------|-------|-------|----------------------------|---------|
| 215/60-8 | C | Solid | 5 | 16060_{THF} | \$95.99 |
| 205/65-10 | D | Solid | 5 | 16061_{THF} | 135.99 |

| Tire Size | Range | Rim | Holes | Order No. | Retail |
|-------------|-------|--------|-------|----------------------------|---------|
| 4.80 x 12 | C | Spoked | 5 | 16054_{THF} | \$87.99 |
| 5.30 x 12 | C | Spoked | 5 | 16055_{THF} | 99.49 |
| ST175/80D13 | C | Spoked | 5 | 16056_{THF} | 136.49 |
| ST185/80D13 | C | Spoked | 5 | 16059_{THF} | 156.49 |
| ST205/75D14 | C | Spoked | 5 | 16057_{THF} | 176.49 |
| ST215/75D14 | C | Spoked | 5 | 16058_{THF} | 201.99 |

- Navigation Lites
- Steering/ Controls
- Hardware/ Fasteners
- Covers/ Windshield
- Pumps/ Int. Lite
- Electric/ Battery
- Trolling Motor
- Gauges
- Electronics/ Radios
- Fuel
- Lube/ Motor Care
- Aux. Brkts/ Tilt/Trim
- Spark Plug/ Starters
- Props
- Seats/ Pedestals
- Anchor/ Rod Holder
- Winches/ Jacks
- Lites/ Tie Downs
- Tires/ Couplers
- Boat Care
- Misc./ Flooring
- Ski's/Tubes
- Floatation
- Ladders
- Water Front
- Fenders/ Dock Lines

Navigation Lites
Steering/ Controls
Hardware/ Fasteners
Covers/ Windshield
Pumps/ Int. Lite
Electric/ Battery
Trolling Motor
Gauges
Electronics/ Radios
Fuel
Lube/ Motor Care
Aux. Brkts/ Tilt/Trim
Spark Plug/ Starters
Props
Seats/ Pedestals
Anchors/ Rod Holder
Winches/ Jacks
Lites/ Tie Downs
Tires/ Couplers
Boat Care
Misc./ Flooring
Ski's/Tubes
Floatation
Ladders
Water Front
Fenders/ Dock Lines



"V-5 MAG" Silver Wheels and **Carlisle** Metric Radial Tires as used on EZ-Loader

| Tire Size | Range | Rim | Holes | Order No. | Retail |
|-------------|-------|---------|-------|--------------------------|----------|
| ST175/80R13 | C | V-5 MAG | 5 | 16280_T | \$175.99 |
| ST185/80R13 | C | V-5 MAG | 5 | 16282_T | 184.99 |
| ST205/75R14 | C | V-5 MAG | 5 | 16284_T | 224.99 |
| ST215/75R14 | C | V-5 MAG | 5 | 16286_T | 235.99 |



Directional Chrome Wheels w/Black Rivets and **Goodyear** Metric Radial Tires

| Tire Size | Range | Rim | Holes | Order No. | Retail |
|-------------|-------|-------------|-------|--------------------------|----------|
| 205/75R14ST | C | Directional | 5 | 16274_T | \$239.99 |
| 215/75R14ST | C | Directional | 5 | 16276_T | 256.99 |



Metric Radial Tires
Silver Painted or Galvanized Spoked Wheels as used on Karavan

| Tire Mfg. | Tire Size | Range | Rim | Hole | Order No. | Retail |
|-----------|--------------|-------|--------------|------|----------------------------|----------|
| Load Star | ST175/80R-13 | C | Silver Paint | 5 | 16074_{THF} | \$137.49 |
| Load Star | ST205/75R-14 | C | Silver Paint | 5 | 16077_{THF} | 177.99 |
| Load Star | ST215/75R-14 | C | Silver Paint | 5 | 16078_{THF} | 197.49 |
| Load Star | ST175/80R-13 | C | Galvanized | 5 | 16079_{THF} | \$153.99 |
| Load Star | ST215/75R-14 | C | Galvanized | 5 | 16081_{THF} | 220.49 |

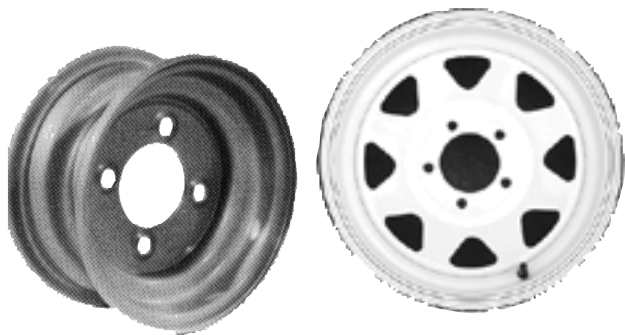

Trailer Wheels Only - White Color

| Size | Description | Order No. | Retail |
|------|---------------|----------------------------|---------|
| 12" | 4-hole spoked | 16090_{THF} | \$29.99 |
| 12" | 5-hole spoked | 16092_{THF} | 29.99 |
| 13" | 5-hole spoked | 16100_{THF} | 35.99 |
| 14" | 5-hole spoked | 16102_{THF} | 49.99 |

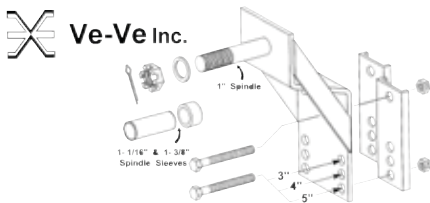

Spare Hub & Tire Carrier
Accommodates hub assemblies with 1", 1-1/16" and 1-3/8" bearings. Includes 3 sleeves, slotted nut, washer and cotter key.

Fits frames up to 3" x 5".

Mfg #SM-99
Order No. 64619_T \$69.95



Lug Bolts and Nuts
• 1/2" - 20 threads
• 5/Card

Mfg #81170 Bolts
Order No. 62665 \$5.99

Mfg #81172 Nuts
Order No. 62667 \$5.99



Wheel Chock
Keep your trailer in place.
Includes rope attachment.

Mfg #44472
Order No. 30834 \$5.99

Replacement Tires Only



Bias Highway/Trailer



| Tire Size | Range | Order No. | Retail |
|-----------|-------|----------------------|---------|
| 4.80 x 8 | B | 16035 ^{THF} | \$28.49 |
| 5.70 x 8 | C | 16036 ^{THF} | 52.49 |
| 4.80 x 12 | B | 16037 ^{THF} | 45.99 |
| 5.30 x 12 | C | 16044 ^{THF} | 58.49 |

| Tire Size | Range | Order No. | Retail |
|-----------|-------|----------------------|---------|
| B78-13 | B | 16040 ^{THF} | \$79.49 |
| B78-13 | C | 16043 ^{THF} | 85.49 |
| C78-13 | C | 16041 ^{THF} | 104.99 |
| F78-14 | C | 16042 ^{THF} | 106.49 |
| G78-14 | C | 16048 ^{THF} | 131.99 |

LOAD STAR Metric Bias

Goodyear Metric Radial

| Tire Size | Range | Order No. | Retail |
|--------------|-------|----------------------|---------|
| ST175/80D-13 | B | 16040 ^{THF} | \$79.49 |
| ST175/80D-13 | C | 16043 ^{THF} | 85.49 |
| ST185/80D-13 | C | 16041 ^{THF} | 104.99 |
| ST205/75D-14 | C | 16042 ^{THF} | 106.49 |
| ST215/75D-14 | C | 16048 ^{THF} | 131.99 |

| Tire Size | Range | Order No. | Retail |
|--------------|-------|--------------------|----------|
| ST175/80R-13 | C | 16212 ^T | \$122.99 |
| ST185/80R-13 | C | 16214 ^T | 131.99 |
| ST205/75R-14 | C | 16216 ^T | 153.99 |
| ST215/75R-14 | C | 16218 ^T | 165.99 |
| ST225/75R-15 | D | 16220 ^T | 183.99 |



Plastic Fenders w/step
Used on Spartan Trailers 1997 and older

This fender attaches with 2 bolts and 1 screw per end. The bolts are vertical from the step through the bracket, the screw is horizontal from the front of the step into the bracket.

| Description | Color | Length | Width | Height | Order No. | Retail |
|-------------|-------|--------|-------|--------|-----------|---------|
| 14" Fender | White | 40" | 9.50" | 11.75" | 54686 | \$47.99 |

Marlex



Replacement Plastic Fenders

| Description | Gray Fender Order No. | White Fender Order No. | Black Fender Order No. | Retail |
|--------------------|-----------------------|------------------------|------------------------|---------|
| 12" Fender | ----- | 07777 | 07782 | \$39.99 |
| 13" Fender w/Steps | 07773 | ----- | 07783 | 61.99 |
| 14" Fender w/Steps | 07774 | ----- | 07784 | 72.99 |



Replacement Plastic Fenders and Brackets

Small Fender: 8" - 12" wheels - width 7-3/4", length 21", height 5"
Large Fender: 13" - 15" wheels - width 11-3/8", length 45", height 11"

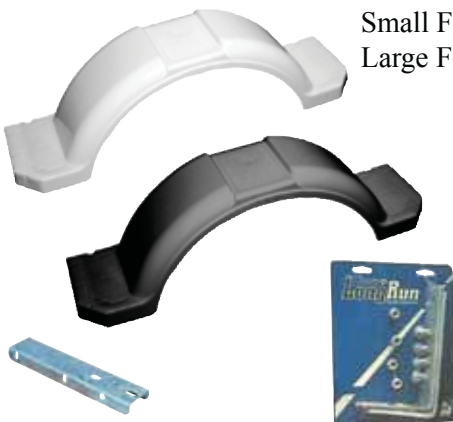

| Mfg. # | Description | Order No. | Retail |
|--------|-----------------------------------|-----------|---------|
| 17026 | Small White Fender | 62530 | \$18.99 |
| 17033 | Small Black Fender | 62532 | 18.99 |
| 44332 | Large White Fender | 62555 | 64.99 |
| 44331 | Large Black Fender | 62557 | 64.99 |
| 81231 | Small Plastic Fender Bracket-pair | 62689 | 18.99 |
| 44141 | Large Plastic Fender Bracket-each | 62550 | 15.49 |

- Navigation Lites
- Steering/ Controls
- Hardware/ Fasteners
- Covers/ Windshield
- Pumps/ Int. Lite
- Electric/ Battery
- Trolling Motor
- Gauges
- Electronics/ Radios
- Fuel
- Lube/ Motor Care
- Aux. Brkts/ Till/Trim
- Spark Plug/ Starters
- Props
- Seats/ Pedestals
- Anchor/ Rod Holder
- Winches/ Jacks
- Lites/ Tie Downs
- Tires/ Couplers
- Boat Care
- Misc./ Flooring
- Ski's/Tubes
- Floatation
- Ladders
- Water Front
- Fenders/ Dock Lines

Navigation Lites
Steering/ Controls
Hardware/ Fasteners
Covers/ Windshield
Pumps/ Int. Lite
Electric/ Battery
Trolling Motor
Gauges



Plastic Fenders



Used on Spartan, Triton, Karavan and Hawkeye Trailers

This fender bolts on horizontally with two bolts at each end. Bolts from the inside of fender to the bracket.

| Mfg # | Description | Color | Length | Width | Height | Order No. | Retail |
|-------|------------------------|-------|--------|-------|--------|--------------|---------|
| 8549 | 8-12" Fender (no step) | White | 22.3" | 7.35" | 6.5" | 66332 | \$22.49 |
| 8572 | 12" Fender w/step | White | 33.5" | 7.50" | 8.75" | 66330 | 35.99 |
| 8582 | 12" Fender w/step | Black | 33.5" | 7.50" | 8.75" | 66333 | 35.99 |
| 8573 | 13" Fender w/step | White | 40.0" | 9.00" | 12.0" | 66334 | \$46.99 |
| 8583 | 13" Fender w/step | Black | 40.0" | 9.00" | 12.0" | 66335 | 46.99 |
| 8574 | 14" Fender w/step | White | 43.4" | 9.70" | 12.75" | 66336 | 52.99 |
| 8584 | 14" Fender w/step | Black | 43.4" | 9.70" | 12.75" | 66337 | 52.99 |

Electronics/ Radios
Fuel
Lube/ Motor Care
Aux. Brkts/ Tilt/Trim
Spark Plug/ Starters
Props
Seats/ Pedestals
Anchors/ Rod Holder
Winches/ Jacks
Lites/ Tie Downs



JSC MARKETING

Plastic Fenders

Used on Spartan, Karavan, Tritan and Warrior Trailers

This fender attaches from the bottom with 4 screws on each end. Vertically from the bracket up into the fender.



Bracket Kit Only
Order No. 16122
Retail \$25.99

| Mfg # | Description | Color | Length | Width | Height | Order No. | Retail |
|------------|-------------------|--------|--------|-------|--------|--------------|---------|
| ----- | 8-12" Fender | Black | 20.38" | 6.75" | 6.08" | 54682 | \$14.99 |
| F9P37S9W | 12" Fender w/step | White | 37.5" | 9.0" | 9.5" | 16112 | 38.99 |
| F9P37S9B | 12" Fender w/step | Black | 37.5" | 9.0" | 9.5" | 16114 | 38.99 |
| F10P40S10W | 13" Fender w/step | White | 40.09" | 10.0" | 11.65" | 16115 | \$54.99 |
| F10P40S10S | 13" Fender w/step | Silver | 40.09" | 10.0" | 11.65" | 16116 | 54.99 |
| F10P40S10B | 13" Fender w/step | Black | 40.09" | 10.0" | 11.65" | 16117 | 54.99 |
| F11P43S11W | 14" Fender w/step | White | 43.0" | 11.0" | 12.89" | 16118 | \$59.99 |
| F11P43S11S | 14" Fender w/step | Silver | 43.0" | 11.0" | 12.89" | 16119 | 59.99 |
| F11P43S11B | 14" Fender w/step | Black | 43.0" | 11.0" | 12.89" | 16120 | 59.99 |

Tires/ Couplers
Boat Care
Misc./ Flooring
Ski's/Tubes
Floatation
Ladders
Water Front
Fenders/ Dock Lines



Hex Head Bolts

Use for mounting brackets, couplers, and winch stands. Zinc plated grade 5 Steel. Pack includes 4-bolts, washers and Nyloc nuts

| Mfg. # | Description | Order No. | Retail |
|--------|---------------|--------------|--------|
| 86253 | 3/8" x 3" | 62582 | \$9.99 |
| 86254 | 3/8" x 4" | 62583 | 9.99 |
| 86255 | 3/8" x 1" | 62584 | 9.99 |
| 86256 | 7/16" x 1" | 62585 | 9.99 |
| 86257 | 1/2" x 3-1/2" | 62586 | 11.99 |



Hub Retaining Hardware

| Mfg. # | Description | Order No. | Retail |
|------------|---------------------|--------------|--------|
| 290-001405 | Axle nut retainer | 07760 | \$1.99 |
| 290-010452 | Axle hub nut 13/16" | 07761 | 1.99 |
| 290-010827 | Tongue axle washer | 07762 | 4.09 |
| 290-023390 | D-shape axle washer | 07763 | 1.49 |

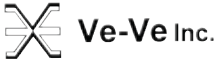

High Mount Spare Tire Carriers

- Fits 3", 4" and 5" Frames
- Fits 4 or 5 Hole Rims
- Has Lock-Tab for Optional Padlock



| Mfg # | Description | Order No. | Retail |
|-------|--|--------------------------|---------|
| SM-96 | 13" Max. tire & wheels | 64624_T | \$44.95 |
| SM-97 | Tires up to 16" - holds tire at an angle | 64626_T | 62.50 |
| SM-98 | Tires up to 16" - holds tire straight | 64627_T | 62.50 |



Spare Tire Carrier

This bracket extends the tire up and away from trailer and boat. Fits wheels Up to 14".



| Mfg # | Description | Order No. | Retail |
|-------|--------------|--------------|---------|
| 22120 | Zinc plated | 17498 | \$38.99 |
| 22121 | Black coated | 17499 | 37.99 |



Heavy Duty Spare Tire Carrier

Fits Tires up to 16". Provides 4-3/4" of lift and 7" of offset to mount tire up and out of the way. Universal mounting system fits frames up to 3" x 5". Zinc plated.



| | |
|------------------------|----------------|
| Mfg #HDSTC | |
| Order No. 22691 | \$54.99 |

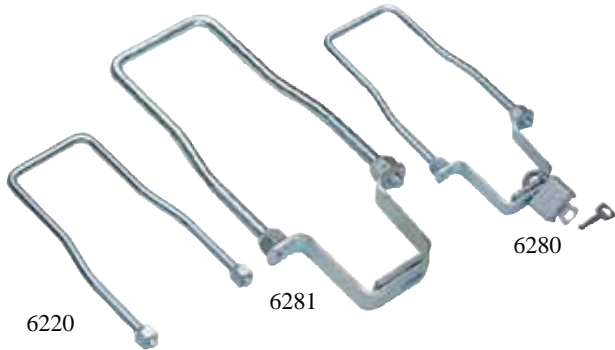

U-Bolt Spare Tire Holders

For 8-12" wheels. Fits 4 or 5 hole rims.

| Mfg # | Description | Order No. | Retail |
|-------|----------------------------|--------------|---------|
| 6220 | U-Bolt Tire Carrier - Pkg. | 17500 | \$13.49 |
| 6281 | Carrier w/lock brackets | 17550 | 23.99 |
| 6280 | Carrier w/brackets & lock | 17508 | 34.99 |



Lock NOT Included

U-Bolt Style Tire Carrier
Mounts tire in any position on tongue or trailer frame. Fits frames to 3-1/2" x 4" rectangular in size. Fits 4 or 5-hole rims 8" to 15" tires.

| | |
|------------------------|----------------|
| Mfg #11090-3 | |
| Order No. 09270 | \$12.99 |

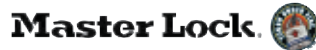

Spare Tire Lock
Chrome plated, lug nut enclosing keyed lock.

| | |
|--------------------------------------|---------------|
| Mfg #262DAT | |
| Order No. 37915_{THF} | \$9.49 |



Trailer Wheel Lock
1/2" x 20 cone seat. For steel or alloy wheels. Hardened, triple-nickel chrome plated steel. 2 Locks per pkg.

| | |
|--------------------------------------|----------------|
| Mfg #74042 | |
| Order No. 35818_{THF} | \$21.99 |

- Navigation Lites
- Steering/ Controls
- Hardware/ Fasteners
- Covers/ Windshield
- Pumps/ Int. Lite
- Electric/ Battery
- Trolling Motor
- Gauges
- Electronics/ Radios
- Fuel
- Lube/ Motor Care
- Aux. Brkts/ Till/Trim
- Spark Plug/ Starters
- Props
- Seats/ Pedestals
- Anchors/ Rod Holder
- Winches/ Jacks
- Lites/ Tie Downs
- Tires/ Couplers
- Boat Care
- Misc./ Flooring
- Ski's/Tubes
- Floatation
- Ladders
- Water Front
- Fenders/ Dock Lines

| | U-Bolts | Mfg # | Stock | "B" | "C" | "D" | Order No. | Retail |
|---------------------|--|---------|-------|---------|----------|--------|-----------|-----------|
| Navigation Lites | Square bend-style U-bolts. | 86219 | 3/8" | 1-5/8" | 3-9/16" | 1-3/4" | 62718 | \$5.49/ea |
| Steering/ Controls | Made of solid zinc-plated steel. Packaged with washers and nuts. | 86208 | 3/8" | 2-1/8" | 4" | 1-3/4" | 62708 | 12.99/pr |
| Hardware/ Fasteners | | 86209 | 3/8" | 3-1/8" | 3" | 1-3/4" | 62709 | 11.99/pr |
| | | 86210 | 3/8" | 3-1/8" | 4" | 1-3/4" | 62710 | 11.99/pr |
| Covers/ Windshield | | 86211 | 3/8" | 4-1/8" | 3" | 1-3/4" | 62711 | 12.49/pr |
| | | 11434-3 | 7/16" | 3-1/8" | 3" | 2" | 06672 | 9.99/ea |
| Pumps/ Int. Lite | | 11436-3 | 7/16" | 4-1/8" | 3" | 2" | 06674 | 9.99/ea |
| Electric/ Battery | | 86213 | 1/2" | 1-9/16" | 4-1/16" | 2" | 62712 | 7.99/ea |
| | | 86214 | 1/2" | 3-1/16" | 3-13/16" | 1-1/2" | 62713 | 7.99/ea |
| Trolling Motor | | 86215 | 1/2" | 2-1/16" | 4-13/16" | 2" | 62714 | 8.49/ea |
| Gauges | | 86205 | 1/2" | 3-1/8" | 3" | 1-1/2" | 62705 | 11.49/pr |
| | | 86206 | 1/2" | 3-1/8" | 4" | 2" | 62706 | 11.99/pr |
| Electronics/ Radios | | 86207 | 1/2" | 4-1/8" | 3" | 2" | 62707 | 11.99/pr |

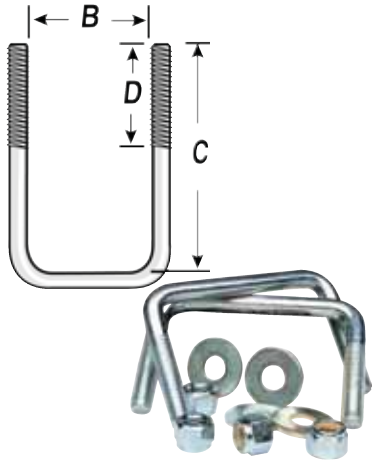

Fuel

Lube/ Motor Care

Aux. Brkts/ Tilt/Trim

Spark Plug/ Starters

Props



Replacement Cap for Tie Down Hub Kits

Mfg #48339A

Order No. 62629 \$14.99

MASTER TOOL CO. INC.



Plastic Shackle Bushings

.875 Outside diameter.
1/2" inside diameter.

Mfg #355 *Order in multiples of 12*

Order No. 38104 \$1.49

Anchors/ Rod Holder

Winches/ Jacks

Lites/ Tie Downs



Wheel Bearing Kits

- 2-bearings
- 2-races
- 1-seal
- 1-cotter pin.



| Mfg # | Application | Order No. | Retail |
|---------|-----------------|-----------|---------|
| 11057-3 | 1-1/16" Spindle | 06911 | \$23.99 |

Tires/ Couplers

Boat Care

Misc./ Flooring



Ski's/Tubes

Floatation

Ladders

Water Front

Fenders/ Dock Lines







Vortex Hub Kit

High Performance

100,000 Mile Lubrication System

- "No Touch" lubrication system
- No need for periodic regreasing or inspection
- Reusable dust cap is threaded for easy removal
- Hub kits are filled with Lucas Marine Grease

| Mfg # | Application | Order No. | Retail |
|-------|-----------------------------|--|---------|
| 81016 | 1" Bearings |  62534 _T | \$87.99 |
| 81017 | 1-1/16" Bearings |  62536 _T | 87.99 |
| 81022 | 1-3/8" inner, 1-1/16" outer |  62538 _T | 109.99 |



Bearing Seal

- 1-3/8" Bearings
- 2/Pack

| | | | |
|------------|----------|------------------------|---|
| Mfg #81323 | 1.68" ID | Order No. 62540 |  \$5.99/pk |
| Mfg #81324 | 2.13" ID | Order No. 62542 |  \$8.99/pk |

genuine Bearing Buddy®
The original... and still the best!
Millions of bearings owe their lives to it



Bearing Buddy® Selection Chart

| BB Model | Outer Bearing Cone | Outer Bearing Cup |
|----------|-------------------------------|-------------------|
| 1980 | L44643, L44649, L44640 | L44610 |
| 1980A | | |
| 1781 | LM11949 | LM11910 |
| 2328 | LM67048, hub not counterbored | LM67010 |
| 1810 | LM67049 | LM12711 |
| 1938 | O9067 | O9194, 95, 96 |
| 1968 | M12649, O7100 | M12610, O7196 |
| 1980T | All internally threaded hubs | |
| 2047 | Various | O7204 |
| 2080 | 900 Series | 900 Series |
| 2240 | 1700 Series | 1729 |
| 2441 | LM67048, hub counterbored | LM67010 |
| | 15123 and others | 15245 |
| 2562 | 48548 | 48510 |
| 2717 | 14124, 14125A | 14276 |

| Model | Order No. | Retail |
|-------|--------------|---------|
| 1980 | 05061 | \$25.99 |
| 1781 | 05065 | 23.99 |
| 2328 | 05069 | 27.99 |
| 1810 | 05073 | 23.99 |

| Model | Order No. | Retail |
|-------|--------------|---------|
| 1938 | 05077 | \$25.99 |
| 2441 | 05085 | 35.99 |
| 2047 | 05067 | 25.99 |

genuine Bearing Buddy®
The original... and still the best!
Millions of bearings owe their lives to it



1980 Bearing Buddy w/Auto Check
When the hub is full of grease the blue auto check ring rests about 1/8" outward from steel retaining ring. 1.980" Hub

Mfg #1980A
Order No. 05060 \$26.99



genuine Bearing Buddy®
The original... and still the best!
Millions of bearings owe their lives to it

Bearing Buddy w/Bra

Mfg #42101 1.980" Hub
Order No. 05062 \$26.99

Mfg #41201 1.781" Hub
Order No. 05066 \$25.99

genuine Bearing Buddy®
The original... and still the best!
Millions of bearings owe their lives to it



The Bearing Buddy Bra
Keeps grease from flying out on to wheels. 2/pack

| Bearing Buddy® Bra | |
|--------------------|---------------------------|
| Model | Fits Bearing Buddy® Model |
| 17B | 1781, 1810 |
| 19B | 1980, 1938, 1968, 2047 |
| 23B | 2328, 2441, 2717, |

| Model | Order No. | Retail |
|-------|--------------|--------|
| 19-B | 05130 | \$3.99 |
| 17-B | 05127 | 3.99 |
| 23-B | 05132 | 3.99 |

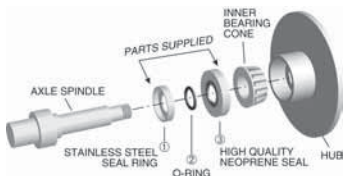

Spindle Seal
For use with bearing buddy on trailer axles with brakes or as a replacement seal system.

| Mfg # | Order No. | Retail |
|-------|--------------|---------|
| #1 | 05089 | \$14.99 |
| #2 | 05093 | 14.99 |
| #3 | 05097 | 14.99 |
| #4 | 05103 | 14.99 |
| #5 | 05107 | 14.99 |

| Mfg # | Order No. | Retail |
|-------|--------------|---------|
| #7 | 05111 | \$14.99 |
| #8 | 05115 | 14.99 |
| #9 | 05119 | 14.99 |
| #10 | 05123 | 14.99 |
| #11 | 05124 | 25.49 |

genuine Bearing Buddy®
The original... and still the best!

SPINDLE SEAL by Bearing Buddy® Selection Chart

| Model Number | Use with Bearing Buddy® | Inner Bearing Cone | Seal Diameter |
|--------------|-------------------------|--------------------|---------------|
| 1 | 1.980 | L44643 | 1.98" |
| 2 | 1.980, 1.968, 2.562 | LM48548, L68149 | 2.56" |
| 3 | 1.980 | LM29749 | 2.56" |
| 4 | 1.938, 1.980T | 15123 | 2.63" |
| 5 | 1.980 | L44649 | 1.98" |
| 7 | 1.781 | LM67048 | 2.33" |
| 8 | 2.328 | LM67048 | 2.33" |
| 9 | 1.938, 1.980T | 15123 | 2.50" |
| 10 | 1.810 | L68149 | 2.36" |
| 11 | 2.441 | 25580 | 3.38" |

FULTON



Wheel Bearing Protectors

- Provides permanent protection against damage from water and dirt entering the wheel bearings.
- Automatically maintains the correct internal pressure
- Made of chrome plated steel
- Installs quickly and fits tightly on to the hubs

| Mfg # | Description | Order No. | Retail |
|--------|-----------------------------|--------------|--------|
| BB1980 | 1.980" Protector Cover 1-pr | 22521 | \$4.99 |

Navigation Lites
Steering/ Controls
Hardware/ Fasteners
Covers/ Windshield
Pumps/ Int. Lite
Electric/ Battery
Trolling Motor
Gauges
Electronics/ Radios
Fuel
Lube/ Motor Care
Aux. Brkts/ Tilt/Trim
Spark Plug/ Starters
Props
Seats/ Pedestals
Anchors/ Rod Holder
Winches/ Jacks
Lites/ Tie Downs
Tires/ Couplers
Boat Care
Misc./ Flooring
Ski's/Tubes
Floatation
Ladders
Water Front
Fenders/ Dock Lines

Navigation Lites
Steering/ Controls
Hardware/ Fasteners
Covers/ Windshield
Pumps/ Int. Lite
Electric/ Battery
Trolling Motor
Gauges
Electronics/ Radios
Fuel
Lube/ Motor Care
Aux. Brkts/ Tilt/Trim
Spark Plug/ Starters
Props
Seats/ Pedestals
Anchors/ Rod Holder
Winches/ Jacks
Lites/ Tie Downs
Tires/ Couplers
Boat Care
Misc./ Flooring
Ski's/Tubes
Floatation
Ladders
Water Front
Fenders/ Dock Lines



Super Lube Dust Caps

| Mfg # | Application | Order No. | Retail |
|-------|-----------------|-----------|---------|
| 81168 | 1.980" Dust cap | 62660 | \$10.99 |
| 81174 | Rubber cover | 62559 | 3.99 |



Bearing Protectors

Includes 2-dust caps with grease zirk and pressure relief valve. Zinc plated finish. Packed with vinyl covers

| Mfg # | Application | Order No. | Retail |
|-------|-------------|-----------|---------|
| 6332 | 1.980" Hub | 17492 | \$19.49 |



Reliable Oil Bath Hub Kits - as used on EZ Loader Trailers
Aluminum screw-on dust cap. Includes rubber o-ring. 1.980"



| Mfg # | Application | Order No. | Retail |
|--------|--|----------------------|---------|
| 031620 | Dust Cap - 2.11" (1.980) | 07789 | \$16.49 |
| 031621 | Reliable Oil Bath Dust Cap 2.48" OD | 07790 | 21.49 |
| 015973 | Spring Bushing Kit | 07798 | 17.99 |
| 029533 | Reliable Oil Bath Hub Kit - 5hole, 1-1/16x1-1/16 | 07766 ^{THF} | 64.99 |
| 029534 | Reliable Oil Bath Hub Kit - 5hole, 1-3/8x1-1/16 | 07768 ^{THF} | 69.99 |



Axle Tie Plate Kit

• Kit includes 4-U-Bolts, 8-Lock Nuts, 2-Tie Plates

| Mfg # | Application | Order No. | Retail |
|-------|---------------|-----------|---------|
| 86525 | 1-3/4" Square | 62608 | \$21.99 |
| 86522 | 1-3/4" Round | 62605 | 19.99 |
| 86523 | 2-3/8" Round | 62606 | 21.99 |
| 86524 | 2" Square | 62607 | 19.99 |
| 86526 | 3" Round | 62609 | 24.99 |



Cast Replacement Hub

- Greased And Assembled

| Pattern | Inner Brg | Outer Brg | Order No. | Retail |
|---------|-----------|-----------|-----------|---------|
| 4 Bolt | 1" | 1" | 16000 | \$50.99 |
| 5 Bolt | 1" | 1" | 16004 | 50.99 |
| 4 Bolt | 1-1/16" | 1-1/16" | 16001 | 44.49 |
| 5 Bolt | 1-1/16" | 1-1/16" | 16005 | 44.49 |
| 5 Bolt | 1-3/8" | 1-1/16" | 16006 | 55.99 |



Trailer Springs

• Heavy Duty spring steel • Includes 9/16" ID Nylon Bushings





| Mfg. # | Description | Order No. | Retail |
|--------|---|-----------|---------|
| 81187 | 2-Leaf 500# 24-5/8" - Slipper Spring Flat End | 62544 | \$31.59 |
| 81188 | 4-Leaf 1,000# 24-5/8" - Slipper Spring Flat End | 62545 | 39.99 |
| 81189 | 2-Leaf 1,000# 30" - Slipper Spring Radius End | 62546 | 41.79 |
| 81191 | 4-Leaf 1,850# 30" - Slipper Spring Radius End | 62548 | 74.29 |
| 81192 | 4-Leaf 2,500# 25-1/4" - Double Eye End | 62549 | 59.99 |







Axle Spindles with Nut, Washer and Cotter Pin

| Mfg. # | Spindle Desc. | Bearing Surface | Order No. | Retail |
|--------|-------------------------------|------------------|-----------|---------|
| 80055 | 1-1/4" x 7" | 1" | 62600 | \$22.99 |
| 80060 | 1-1/4" x 7" | 1-1/16" | 62603 | 22.99 |
| 80235 | 1-3/4" x 8-1/4" | 1-1/16" & 1-3/8" | 62610 | 29.99 |
| 81169 | Nut, Washer & Cotter Pin only | | 62661 | 4.99 |

| | Mfg # | Spindle/Size | O.E. No. | Order No. | Retail | |
|--|---|--------------|----------|--|-------------------|-----------|
| Bearings  | 11050 | 3/4" | LM11949 |  62639 | \$5.79/ea | |
| | 81150 | 1" | L44643 |  62640 | 5.99/ea | |
| | 81151 | 1-1/16" | L44649 |  62641 | 5.99/ea | |
| | 125TN | 1-1/4" | LM67048 |  62642 | 8.29/ea | |
| | 81160 | 1-3/8" | L68149 |  62645 | 5.99/ea | |
| Races  | 11051 | 3/4" | LM11910 |  62649 | \$ 2.79/ea | |
| | 81161 | 1" & 1-1/6" | L44610 |  62650 | 2.49/ea | |
| | 11057 | 1-1/4" | LM67010 |  62651 | 6.79/ea | |
| | 81163 | 1-3/8" | L68111 |  62655 | 2.99/ea | |
| | ---- | 1-3/8" | L68110 | 62656 | 12.19/ea | |
| Dust Caps  | 1925 | 1.986 | N/A | 66250 | \$3.99/ea | |
| | 1926 | 2.332 | N/A | 66254 | 4.49/ea | |
| | 1927 | 2.448 | N/A | 66258 | 4.49/ea | |
| | 1928 | 1.785 | N/A | 66262 | 3.99/ea | |
| | Seals  | | | O/D | Shaft Dia. | |
| 6423 | | 3/4" | 1.784 | 1.125 | 17564 | \$2.79/ea |
| 6420 | | 1" & 1-1/16" | 1.983 | 1.250 | 17561 | 2.69/ea |
| 6421 | | 1-1/4" | 2.332 | 1.500 | 17562 | 3.59/ea |
| 6422 | | 1-3/8" | 2.565 | 1.719 | 17563 | 2.89/ea |
| Seals-w/Spring  | 3253 | 1" & 1-1/16" | 1.983 | 1.250 | 54761 | \$7.09/ea |
| | 9909 | 1-1/16" | 1.983 | 1.500 | 17560 | 3.39/ea |
| | 3551 | 1-3/8" | 2.565 | 1.500 | 54762 | 11.59/ea |
| | 3631 | 1-3/8" | 2.565 | 1.719 | 54763 | 8.19/ea |
| | 168233TB | 1-3/8" | 2.328 | 1.688 | 54755 | 8.09/ea |

Navigation Lites
Steering/ Controls
Hardware/ Fasteners
Covers/ Windshield
Pumps/ Int. Lite
Electric/ Battery
Trolling Motor
Gauges
Electronics/ Radios
Fuel
Lube/ Motor Care
Aux. Brkts/ Tilt/Trim
Spark Plug/ Starters
Props
Seats/ Pedestals

| Bearing Sets | | | | | | |  | | | |
|--------------|------------------|----------------|------------------------|------------------------|---------------|---------------|---|--------------------------|--|---------|
| Model No. | Spindle O.D. | Outer Hub I.D. | Outer Bearing Cone No. | Inner Bearing Cone No. | Outer Cup No. | Inner Cup No. | Mfg # | Application | Order No. | Retail |
| 6500* | 3/4" | 1.781 | LM11949 | Same | LM11910 | Same | 6501 | 3/4" spindle | 17581 | \$37.99 |
| 6501 | 3/4" | 1.938 | 09067 | Same | 09195 | Same | 6502 | 1" spindle |  17582 | 16.99 |
| 6502 | 1" | 1.980 | L44643 | Same | L44610 | Same | 6503 | 1-1/16" spindle |  17583 | 16.99 |
| 6503 | 1-1/16" | 1.980 | L44649 | Same | L44610 | Same | 6506 | 1-1/4" x 3/4" spindle | 17586 | 18.99 |
| 6504 | 1-1/4" | 2.328 | LM67048 | Same | LM67010 | Same | 6507 | 1-3/8" x 1-1/16" spindle |  17587 | 16.99 |
| 6505 | 1-1/16" x 3/4" | 1.781 | LM11949 | L44649 | LM11910 | L44610 | 6508 | 1-3/8" x 1-1/16" spindle | 17579 | 23.49 |
| 6506 | 1-1/4" x 3/4" | 1.781 | LM11949 | LM67048 | LM11910 | LM67010 | | | | |
| 6507 | 1-3/8" x 1-1/16" | 1.980 | L44649 | L68149 | L44610 | L68111 | | | | |
| 6508 | 1-3/8" x 1-1/16" | 1.980 | L44649 | L68149 | L44610 | L68110 | | | | |

anchors/ Rod Holder
Winches/ Jacks
Lites/ Tie Downs
Tires/ Couplers
Boat Care
Misc./ Flooring
Ski's/Tubes

|  | | | | Seal Kits - Kits contain 2-Seals and 2-Cotter pins. | | | | | | |
|--|--------------|----------------|--|---|---------------|---------------|-------|----------------------|--------------|--------|
| Model No. | Spindle O.D. | Outer Hub I.D. | Outer Bearing Cone No. | Inner Bearing Cone No. | Outer Cup No. | Inner Cup No. | Mfg # | Application | Order No. | Retail |
| 6511 | 1-1/16" | 1.980 | Set of 2 ea. seals #203106 & 2 ea. Cotter keys #203814 for kits # 6202, 6203, 6205, 6502, 6503 & 6505. | | | | 6511 | 1" & 1-1/16" spindle | 17591 | \$7.99 |
| 6512 | 1-1/4" | 2.320 | Set of 2 ea. seals #203122 & 2 ea. Cotter keys #203814 for kits # 6204, 6206, 6504 & 6506. | | | | 6512 | 1-1/4" spindle | 17592 | 7.99 |
| 6513 | 1-3/8" | 2.561 | Set of 2 ea. seals #203684 & 2 ea. Cotter keys #203814 for kits # 6207, 6208, 6507 & 6508 | | | | 6513 | 1-3/8" spindle | 17593 | 7.99 |
| 6514 | 3/4" | 1.781 | Set of 2 ea. seals #203612 & 2 ea. Cotter keys #203814 for kits # 6200 & 6501. | | | | 6514 | 3/4" spindle | 17594 | 7.99 |
| 6515 | 3/4" | 1.938 | Set of 2 ea. seals #203100 & 2 ea. Cotter keys #203814 for kits # 6201 & 6501. | | | | | | | |

Floatation
Ladders
Water Front
Fenders/ Dock Lines



BEARINGS



RACES



SEALS W/SPRINGS

| | 1-1/16" Outer | 1-1/16" Inner | | |
|---------------|---------------|---------------|--------|--|
| | OE/Mfg # | Order No. | Retail | |
| Inner Bearing | L44649 | 62641 | \$5.99 | |
| Outer Bearing | L44649 | 62641 | 5.99 | |
| Inner Race | L44610 | 62650 | 2.49 | |
| Outer Race | L44610 | 62650 | 2.49 | |
| Seal | 12192TB | 54761 | 7.09 | |

| | 1-1/16" Outer | 1-3/8" Inner | | |
|------------|---------------|--------------|--------|--|
| | OE/Mfg # | Order No. | Retail | |
| L68149 | 62645 | \$5.99 | | |
| L44649 | 62641 | 5.99 | | |
| L68111 | 62655 | 2.99 | | |
| L44610 | 62650 | 2.49 | | |
| 152563TB** | 54762 | 11.59 | | |
| 171255TB | 54763 | 8.19 | | |

** Spartan Trailers Only



| | 1-1/16" Outer | 1-1/16" Inner | | |
|-------------------|---------------|---------------|--------|--|
| | OE/MFG # | Order No. | Retail | |
| Inner Bearing | L44649 | 62641 | \$5.99 | |
| Outer Bearing | L44649 | 62641 | 5.99 | |
| Inner Race | L44610 | 62650 | 2.49 | |
| Outer Race | L44610 | 62650 | 2.49 | |
| Seal (Turbo Lube) | 12194TC | 54758 | 5.89 | |

| | 1-1/16" Outer | 1-3/8" Inner | | |
|----------|---------------|--------------|--------|--|
| | OE/MFG # | Order No. | Retail | |
| L68149 | 62645 | \$5.99 | | |
| L44649 | 62641 | 5.99 | | |
| L68111 | 62655 | 2.99 | | |
| L44610 | 62650 | 2.49 | | |
| 168255TC | 54759 | 5.89 | | |



| | 1-1/16" Outer | 1-1/16" Inner | | |
|---------------|---------------|---------------|--------|--|
| | OE/Mfg # | Order No. | Retail | |
| Inner Bearing | L44649 | 62641 | \$5.99 | |
| Outer Bearing | L44649 | 62641 | 5.99 | |
| Inner Race | L44610 | 62650 | 2.49 | |
| Outer Race | L44610 | 62650 | 2.49 | |
| Seal | 127194TB | 54756 | 10.39 | |

| | 1-1/16" Outer | 1-3/8" Inner | | |
|----------|---------------|--------------|--------|--|
| | OE/Mfg # | Order No. | Retail | |
| L68149 | 62645 | \$5.99 | | |
| L44649 | 62641 | 5.99 | | |
| L68111 | 62655 | 2.99 | | |
| L44610 | 62650 | 2.49 | | |
| 174253TB | 54757 | 6.59 | | |



| Mfg # | Description | Order No. | Retail |
|----------|---|-----------|--------|
| 168233TB | Seal w/Spring NOK #AD2527EO; Spindle size: 1-3/8"; O.D. 2.328; Shaft dia: 1.688 | 54755 | \$8.09 |
| 171255UC | Coated Seal; O.D. 2.565; Shaft dia: 1.719 | 62668 | 5.49 |



| Mfg # | Application | Order No. | Retail |
|-------|--|-----------|---------|
| 81105 | 3/4" Bearing (2ea LM11949) | 62634 | \$21.99 |
| 81110 | 1" Bearing (2ea LM44643) | 62635 | 17.99 |
| 81115 | 1-1/16" Bearing (2ea L44649) | 62636 | 17.99 |
| 81120 | 1-1/16" x 3/4" Bearing (L44649/LM11949) | 62670 | 19.99 |
| 81125 | 1-1/4" Bearing (2ea LM67048) | 62637 | \$20.99 |
| 81130 | 1-1/4" x 3/4" Bearing (LM67048/LM11949) | 62671 | 20.99 |
| 81140 | 1-3/8" x 1-1/16" Bearing (L68149/L44649, 2.3612" Race) | 62672 | 18.49 |
| 81142 | 1-3/8" x 1-1/16" Bearing (L68149/L44649, 2.328" Race) | 62673 | 18.99 |

Navigation Lites
Steering/ Controls
Hardware/ Fasteners
Covers/ Windshield
Pumps/ Int. Lite
Electric/ Battery
Trolling Motor
Gauges
Electronics/ Radios
Fuel
Lube/ Motor Care
Aux. Brkts/ Tilt/Trim
Spark Plug/ Starters
Props
Seats/ Pedestals
Anchors/ Rod Holder
Winches/ Jacks
Lites/ Tie Downs
Tires/ Couplers
Boat Care
Misc./ Flooring
Ski's/Tubes
Floatation
Ladders
Water Front
Fenders/ Dock Lines



Marine Corrosion Control And Trailer Bearing Grease
 Special water-insoluble formula ideal for marine applications. Provides excellent corrosion protection against severe operating conditions caused by salt water, salt air, and atmospheric chemicals. Use on wheel bearings, including disc brake wheel bearings, and to protect swivel hinges, pins, winches and anchor chain reels from corrosion.

| Mfg # | Description | Order No. | Retail |
|---------|-----------------------------|--------------|---------|
| 30-190 | 3-oz Gun w/grease | 35137 | \$31.49 |
| LM11399 | 2-pack of 3-oz Grease cart. | 35141 | 7.99 |
| LM11400 | 4-pack of 3-oz Grease cart. | 35144 | 13.49 |
| LM11406 | 8 oz. Tube | 35222 | 8.99 |

Sierra
 Marine Engines and Drive Parts

Pro Performance Marine Bearing Grease

- Formulated for marine applications
- Premium lithium formula for corrosion protection
- Ideal for universal joints and outdrive pivots

Marine Extreme Pressure Waterproof Grease

- Aluminum complex grease for all bearing/bushing applications
- Corrosion protection
- Will not melt, run or wash out

| Mfg # | Description | Order No. | Retail |
|-----------|-----------------|----------------|--------|
| 18-9200-0 | 8 oz Tube | 892000N | \$8.89 |
| 18-9200-1 | 15 oz Cartridge | 892001N | 6.99 |
| 18-9700-2 | 2ea-3oz cart. | 897002N | 11.19 |

| Mfg # | Description | Order No. | Retail |
|----------|----------------|---------------|--------|
| 99710CG3 | 3oz cartridge | 08248N | \$4.31 |
| 99710CG | 14oz cartridge | 08250N | 10.05 |
| 99540TB | 16oz Tub | 08252N | 10.99 |



Bulk Grease and Accessories

| Mfg # | Description | Order No. | Retail |
|---------|----------------------------|--------------|--------|
| LM11404 | 1-lb. Tub of Marine Grease | 35145 | \$9.49 |

14-oz. Cartridge and Guns

| Mfg # | Description | Order No. | Retail |
|---------|---------------------------|--------------|--------|
| LM11402 | 14-oz Cartridge of Grease | 35143 | \$7.99 |
| 30-300 | Pistol-Matic Grease Gun | 35157 | 23.99 |



Sport Trailer Guard™
 Protect your equipment from rocks and road debris. The Sport Trailer Guard has two 24" rubber flaps which are attached to tubular arms that adjust from 69" to 77". The Sport Trailer Guard attaches securely and can be removed quickly and easily using hitch pins. Fits tow vehicles with 2" class 3 receiver hitches. Black powder coat finish.

| | | |
|-------------|-------------------------|----------|
| Mfg #SG-224 | Order No. 64600T | \$174.95 |
|-------------|-------------------------|----------|

Center Skirt
 Option for the "Sport Trailer Guard". 36" wide by 18" long skirt that fastens to the center tube of the Sport Trailer Guard. Allows safety chains and wire to pass through easily.

| | | |
|-------------|--------------------------|---------|
| Mfg #SG-230 | Order No. 64601TF | \$79.95 |
|-------------|--------------------------|---------|

- Navigation Lites
- Steering/ Controls
- Hardware/ Fasteners
- Covers/ Windshield
- Pumps/ Int. Lite
- Electric/ Battery
- Trolling Motor
- Gauges
- Electronics/ Radios
- Fuel
- Lube/ Motor Care
- Aux. Brkts/ Tilt/Trim
- Spark Plug/ Starters
- Props
- Seats/ Pedestals
- anchors/ Rod Holder
- Winches/ Jacks
- Lites/ Tie Downs
- Tires/ Couplers
- Boat Care
- Misc./ Flooring
- Ski's/Tubes
- Floatation
- Ladders
- Water Front
- Fenders/ Dock Lines



10" x 2-1/4" Standard Freebacking
Backing Plate Assembly - Complete
• 3,750 lb axle rating 70 sq. in. Swept Area.

| Mfg # | Description | Order No. | Retail |
|---------|-------------|---------------------|---------|
| 4071500 | Right Side | 16177 _{TF} | \$56.99 |
| 4071600 | Left Side | 16176 _{TF} | 56.99 |



10" x 2-1/4" Uni-Servo
Backing Plate Assembly - Complete
• 3,750 lb axle rating 71 sq. in. Swept Area

| Mfg # | Description | Order No. | Retail |
|---------|-------------|---------------------|---------|
| 1878700 | Right Side | 16175 _{TF} | \$55.99 |
| 1878800 | Left Side | 16174 _{TF} | 55.99 |



10" x 2-1/4" Hub and Drum
w/Cups and Studs
• Includes bearing cups
• No bearings included (1-3/8" x 1-1/16")

Mfg #1554400CB042
Order No. 16179_{TF} \$64.99



Hydraulic Brake Fitting
and Tubing Kit
• Single torsion axle application

Mfg #4829900
Order No. 16180_{TF} \$106.99

Disc Brake End Kit - 10" 3500lb Rating

A complete kit to replace drum or disc brakes as an assembly.

Kit includes:

- Hub and Rotor
- Caliper
- Bearings w/Bearing Buddy
- Mounting Bracket
- Bracket Hardware
- Spindle Seal

Mfg #4843000
Order No. 16182_{TF} \$145.99

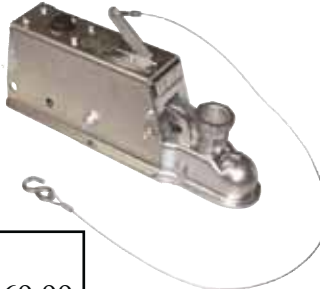

Titan/Dico
Hydraulic Drum Brake Actuator

- 6000#
- 1-7/8" & 2" Ball

Mfg #4339700
Order No. 16150_{TF} \$169.99



Model 60 Leverlock Actuator
6,000lb capacity, 600lb tongue load.

- Disc Brakes
- 3" tongue
- 1-7/8" or 2" ball



Mfg #4715410
Order No. 16149_{TF} \$194.99



Brake Shoes & Wheel Cylinders



Uni-Servo

Free Backing

| Mfg # | Description | Order No. | Retail |
|---------|--|---------------------|---------|
| 4445900 | 10" Front pad for Uni-Servo | 16164 _{TF} | \$29.99 |
| 4437100 | 10" Front pad for Free Backing | 16166 _{TF} | 28.99 |
| 4437200 | 10" Back pad for Uni-Servo or Free Backing | 16168 _{TF} | 28.99 |
| 0977700 | Left hand wheel cylinder assy. | 16170 _{TF} | \$21.99 |
| 0977600 | Right hand wheel cylinder assy. | 16172 _{TF} | 21.99 |



Brake Coupler and Repair Parts

Using the diagram pick the kit that best fits your needs.

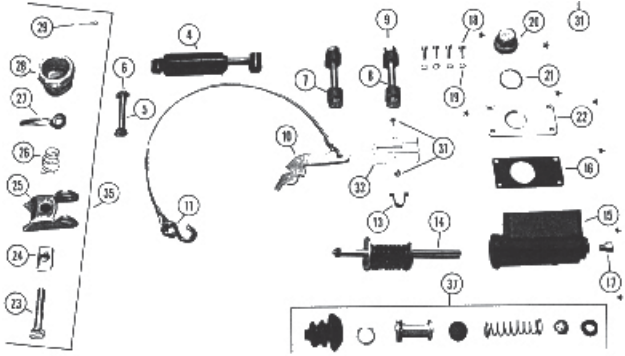

| Description | Order No. | Retail |
|---------------------------------------|---------------------|---------|
| Coupler repair kit #35 (turn down) | 16151 _{TF} | \$21.99 |
| Coupler repair kit #35 (snap down) | 16155 _{TF} | 97.99 |
| Coupler lock #27 | 16153 _{TF} | 1.99 |
| Ball latch #25 | 16163 _{TF} | 6.99 |
| Shock absorber #4 | 16152 _{TF} | 41.99 |
| Brake cable, cover & S-hook #10,11,32 | 16154 _{TF} | 15.09 |
| Fill cap & gasket #20,21 | 16156 _{TF} | 8.59 |
| Master cylinder repair kit #37 | 16160 _{TF} | 25.99 |
| Master cylinder kit #15 thru #22 | 16162 _{TF} | 80.99 |
| Brass connector #17 | 16161 _{TF} | 4.49 |



Brake Coupler And Repair Parts

Using the diagram pick the kit that best fits your needs.

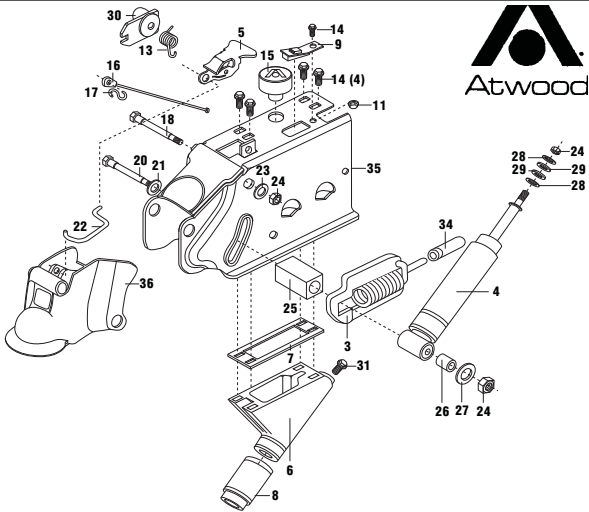

| Description | Order No. | Retail |
|---|-----------|---------|
| Shock Absorb kit #4,24-2ea,28-2ea,29-2ea. | 07603 | \$59.99 |
| Boot Replacement kit #8 | 07604 | 12.99 |
| Push rod kit #3,6,7,8,9,11,14-5ea,16,17,24-2ea,34 | 07617 | 142.99 |
| Cap replacement kit #15 | 07615 | 8.99 |
| Master cylinder kit #6,7,4ea 14 | 07605 | 82.99 |
| Shoulder bolt kit #20,21,24-2ea,25,26,27 | 07607 | 14.99 |
| Release handle kit #5,13,18,22,24-3ea,30 | 07609 | 17.99 |
| Stop & sprg kit #9,11,14,24 | 07611 | 19.99 |
| Push rod assy. #3,7,11,14-5ea,16,17,24-2ea,34,8,9 | 07613 | 45.99 |
| Master cyl. brass elbow (not shown) | 07619 | 4.99 |



Hydraulic Drum Brake Actuator

- 6000# • 2" Ball



Mfg #84132
Order No. 07601 \$274.99

Reverse Lock Out Solenoid

A reverse lockout solenoid should be installed at the actuator (if not already installed) before installation of disc brakes. Can be used on drum brakes as well.



Mfg #81103
Order No. 62632_T \$86.99



Model 660 Hydraulic Drum Brake Actuator

- 6600#
- 2" Ball
- 3" Tongue
- Drop N Go auto latch coupler



Mfg #82401
Order No. 62620_{TF} \$189.99



Model 660 Hydraulic Drum Brake Actuator

- 6600#
- 2" Ball
- 3" Tongue
- Drop N Go auto latch coupler
- Includes solenoid



Mfg #82400
Order No. 62617_{TF} \$210.59

Navigation Lites
 Steering/ Controls
 Hardware/ Fasteners
 Covers/ Windshield
 Pumps/ Int. Lite
 Electric/ Battery
 Trolling Motor
 Gauges
 Electronics/ Radios
 Fuel
 Lube/ Motor Care
 Aux. Brkts/ Tilt/Trim
 Spark Plug/ Starters
 Props
 Seats/ Pedestals
 Anchors/ Rod Holder
 Winches/ Jacks
 Lites/ Tie Downs
Tires/ Couplers
 Boat Care
 Misc./ Flooring
 Ski's/Tubes
 Floatation
 Ladders
 Water Front
 Fenders/ Dock Lines

Navigation Lites
Steering/ Controls
Hardware/ Fasteners
Covers/ Windshield
Pumps/ Int. Lite
Electric/ Battery



10" Vented Rotor Brake Installation Kit
Complete kit to replace or upgrade from drum brakes to trailer disc brakes. 66/800 Disc brake actuator features cast ball clamp, Drop N Go auto coupler latch, oversized master cylinder, back flow style solenoid installed. Includes vented rotor disc brakes, disc brake actuator, brake line kit, brake hoses, brass fittings and attachment hardware. Fits 13", 14", 15" wheels.



Mfg #82405
Order No. 62623_{TF} \$579.99



Trolling Motor
Gauges
Electronics/ Radios
Fuel
Lube/ Motor Care
Aux. Brkts/ Tilt/Trim
Spark Plug/ Starters



D/L couplers are die formed. They are easily and quickly unlocked by a trigger action release.



| Mfg # | Description | Order No. | Retail |
|--------|--|-----------|---------|
| 970P | 1-7/8" Class I coupler 3" housing (bulk) | 17413 | \$16.49 |
| 980P | 2" Class II coupler 3" housing (bulk) | 17417 | 23.99 |
| 6256-1 | 1-7/8" Coupler repair kit | 17420 | \$19.99 |
| 6257-1 | 2" Coupler repair kit | 17424 | 26.99 |
| 303011 | Coupler safety pin and chain | 17615 | 1.99 |

Props
Seats/ Pedestals
Anchors/ Rod Holder
Winches/ Jacks
Lites/ Tie Downs



Fas-Lok Straight Tongue Couplers
Zinc Plated



| Mfg # | Description | Order No. | Retail |
|--------|--|-----------|---------|
| 11-200 | 1-7/8" Class I coupler, 2" housing - 2,000 lb cap. | 22671 | \$21.99 |
| 22-200 | 2" Class II coupler, 2" housing - 3,500 lb cap. | 22675 | 24.99 |
| 22-300 | 2" Class II coupler, 3" housing - 3,500 lb cap. | 22676 | 24.99 |

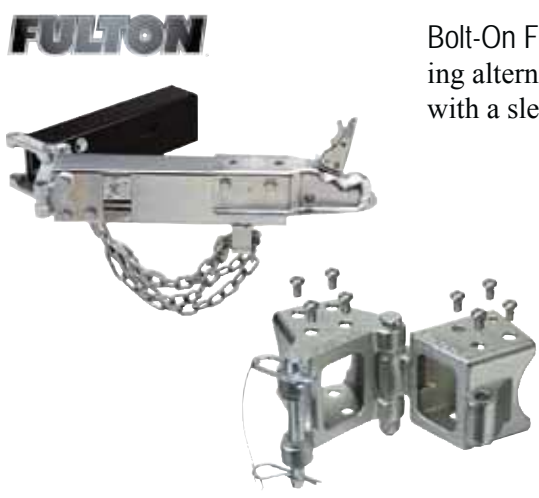

Tires/ Couplers

Boat Care
Misc./ Flooring
Ski's/Tubes
Floatation
Ladders
Water Front
Fenders/ Dock Lines



Bolt-On Fold Away Tongue Kit - The Fold-Away™ couplers provide space saving alternatives for easy storage. The cast hinge design offers strength coupled with a sleek appearance. Rated at SAE Class II (3500#) for 2" ball size.

| Mfg # | Description | Order No. | Retail |
|---------|-----------------------------|--------------------|----------|
| HDPB 33 | 3" x 3" - Hinge kit only | 22682 _T | \$104.99 |
| HDPB 34 | 3" x 4" - Hinge kit only | 22683 _T | 119.99 |
| 500334 | Pin & clip for 3" hinge kit | 22685 | \$16.99 |
| 500335 | Pin & clip for 4" hinge kit | 22686 | 17.99 |

| Mfg # | Description | Order No. | Retail |
|------------|-----------------------|--------------|---------|
| 290-031981 | Pin & clip 5/8" x 5" | 07793 | \$11.49 |
| 290-031982 | Pin & clip 5/8" x 6" | 07794 | 12.99 |
| 290-024383 | Locking Pin 5/8" x 6" | 07795 | 23.99 |
| 290-024384 | Lock for 6" pin | 07796 | \$29.99 |
| 290-002650 | Hog ring | 07785 | 1.19 |
| PB0725 | Reverse lockout key | 07792 | 5.29 |



Coupler Safety Pin
1/4" dia. steel shaft pin,
1-1/2" clearance.



| Mfg # | Description | Order No. | Retail |
|-------|-------------|--------------|--------|
| 59400 | Square clip | 05370 | \$2.99 |
| 59401 | Round clip | 05371 | 2.99 |

Coupler Locking Pin
Fits 2" & 3" couplers. Bar fits through coupler release handle to provide security and safety. Zinc plated steel.



| | |
|------------------------|---|
| Mfg #11029-6 |  |
| Order No. 09279 | \$4.99 |



7/8" Span Coupler Lock

| | |
|--------------------------------------|---|
| Mfg #1475DAT |  |
| Order No. 37942_{THF} | \$17.49 |





3-1/2" Span Coupler Lock
Fits: Atwood & Unique Functional

| | |
|--------------------------------------|---|
| Mfg #1471DAT |  |
| Order No. 37935_{THF} | \$17.49 |





Specialty Coupler Lock
Fits Atwood and Dico brake actuators

| | |
|--------------------------------------|---|
| Mfg #7LJ |  |
| Order No. 37909_{THF} | \$11.99 |



Coupler Lock - 1 Piece
For maintenance free trailer security. Solid brass with rust-proof stainless steel shackle pin. 1/4" diameter shackle.



| | |
|--------------------------------------|---|
| Mfg #12044-6 |  |
| Order No. 06894_{THF} | \$19.99 |



Armorlock
• Fits openings 9/32" or larger in diameter.



| | |
|--------------------------------------|---|
| Mfg #37DAT |  |
| Order No. 37903_{THF} | \$16.49 |



Coupler Lock
• 7/8" long shackle
• Hardened steel



| | |
|--------------------------------------|---|
| Mfg #2878DAT |  |
| Order No. 37933_{THF} | \$8.99 |



Coupler Lock
• Nickel-plated, zinc die-cast body
• Front access key-way
• Ratcheting shaft
• Fits 1-7/8" and 2" couplers.



| | |
|--------------------------------------|---|
| Mfg #379DAT |  |
| Order No. 37922_{THF} | \$31.49 |

Navigation Lites
Steering/ Controls
Hardware/ Fasteners
Covers/ Windshield
Pumps/ Int. Lite
Electric/ Battery
Trolling Motor
Gauges
Electronics/ Radios
Fuel
Lube/ Motor Care
Aux. Brkts/ Tilt/Trim
Spark Plug/ Starters
Props
Seats/ Pedestals
Anchors/ Rod Holder
Winches/ Jacks
Lites/ Tie Downs
Tires/ Couplers
Boat Care
Misc./ Flooring
Skis/Tubes
Floatation
Ladders
Water Front
Fenders/ Dock Lines

Navigation Lites
 Steering/ Controls
 Hardware/ Fasteners
 Covers/ Windshield
 Pumps/ Int. Lite
 Electric/ Battery
 Trolling Motor
 Gauges
 Electronics/ Radios
 Fuel
 Lube/ Motor Care
 Aux. Brkts/ Tilt/Trim
 Spark Plug/ Starters
 Props
 Seats/ Pedestals
 Anchors/ Rod Holder
 Winches/ Jacks
 Lites/ Tie Downs
 Tires/ Couplers
 Boat Care
 Misc./ Flooring
 Ski's/Tubes
 Floatation
 Ladders
 Water Front
 Fenders/ Dock Lines

Master Lock 



Coupler Latch Lock

- Stainless steel
- Coupler locks from 9/16" to 2-3/4"

Mfg #2847DAT
Order No. 37930_{THF} \$10.49

Master Lock 



Receiver Lock & Coupler Latch Lock

- Fits 1/2" & 5/8" receivers
- Coupler locks from 9/16" to 2-3/4"

Mfg #2848DAT
Order No. 37931_{THF} \$25.99

Master Lock 



Receiver Lock

- Stainless Steel Barbell™ lock
- Fits 5/8" receiver openings
- Push to Lock™ locking mechanism
- Class III/IV; 10,000lb. Load rating

Mfg #1480DAT
Order No. 37939_{THF} \$26.99

FULTON



Receiver Lock

Helps prevent theft. Easy to use quick lock mechanism. Fits 2" and 2½" receivers. Plated steel hitch pin.

Mfg #63223 5/8" Pin
Order No. 22749 \$13.99

Master Lock 



Receiver Lock

- Fits both 1/2" & 5/8" receivers
- Water tight cap protects lock from moisture and dirt

Mfg #2866DAT
Order No. 37929_{THF} \$16.99

Master Lock 



Extended Length Receiver Lock

- Fits 5/8" receivers
- Usable length is 3-1/2"
- Swivel head
- Push to lock

Mfg #1469DAT
Order No. 37936_{THF} \$28.99

Master Lock 



Receiver Lock

- Removable cable
- 2-3/4" receiver pin
- Fits 1/2" & 5/8" receivers

Mfg #1470DAT
Order No. 37934_{THF} \$28.49

Master Lock 



Locking Cable

- 6' cable
- 100% steel braid
- Vinyl sleeve

Mfg #8428DPS
Order No. 37944_{THF} \$31.99

Master Lock 



Receiver Hitch Pin
• Chrome Plated

| Mfg # | Description | Order No. | Retail |
|---------|-------------|----------------------|--------|
| 1492DAT | 1/2" Pin | 37924 _{THF} | \$4.99 |
| 1495DAT | 5/8" Pin | 37927 _{THF} | 4.99 |

Master Lock 



5/8" Hitch Pin with Clip

| | | |
|-------------|-----------------|--------|
| Mfg #371DAT | Order No. 37918 | \$3.99 |
|-------------|-----------------|--------|

Master Lock 



SST Receiver Hitch Pin
5/8" Stainless Steel "Pivot Lock".
Pull and turn end to lock or release hitch pin.

| | | |
|--------------|--------------------------------|--------|
| Mfg #1465DAT | Order No. 37926 _{THF} | \$9.99 |
|--------------|--------------------------------|--------|

TRAC

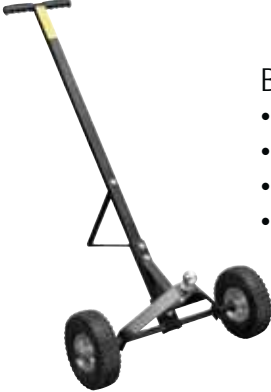

Boat and Trailer Dolly

- Heavy duty construction
- Large, pneumatic rubber tires
- Works in spaces vehicles can't go
- 600lb. Max • 1-7/8" ball

| | | |
|-------------|------------------------------|---------|
| Mfg #T10046 | Order No. 58042 _T | \$59.99 |
|-------------|------------------------------|---------|



CURT Manufacturing
www.curtmfg.com

Reducer Bushing
Reduces ball mount hole size from 1" to 3/4".

| | | |
|------------|-----------------|--------|
| Mfg #21101 | Order No. 13468 | \$4.99 |
|------------|-----------------|--------|

CURT Manufacturing
www.curtmfg.com

Reversible Ball Mount

- 1-7/8" ball on one side
- 2" ball on the reverse side
- Powder Coated



| | | |
|-------------|------------------------------|---------|
| Mfg #D45643 | Order No. 13453 _T | \$66.99 |
|-------------|------------------------------|---------|

DRAW-TITE

Easy Load Ball Mounts
Featuring a revolutionary tapered shank design, easy to load ball mounts provide an easy connection to the receiver.
Black powder coat finish over e-coat.



| Mfg # | Description | Order No. | Retail |
|-------|--------------------------------------|-----------|---------|
| 36051 | 1-1/4" Square, 1-1/4" Drop, 3500 GTW | 22778 | \$32.99 |
| 40342 | 2" Square, 2" Drop, 7500 GTW | 22780 | 18.99 |
| 40344 | 2" Square, 4" Drop, 7500 GTW | 22782 | 21.99 |
| 40346 | 2" Square, 6" Drop, 6000 GTW | 22784 | 27.99 |

DRAW-TITE

Class III Standard Towing Starter Kit

- Includes pin and clip
- Black powder coat over e-coat
- 6000 GTW Rating



| Mfg # | Description | Order No. | Retail |
|-----------|-----------------------------|-----------|---------|
| 40583-002 | 2" Square, 2" Drop, 2" Ball | 22786 | \$25.99 |
| 40644-002 | 2" Square, 4" Drop, 2" Ball | 22788 | 30.99 |

Navigation Lites
Steering/ Controls
Hardware/ Fasteners
Covers/ Windshield
Pumps/ Int. Lite
Electric/ Battery
Trolling Motor
Gauges
Electronics/ Radios
Fuel
Lube/ Motor Care
Aux. Brkts/ Tilt/Trim
Spark Plug/ Starters
Props
Seats/ Pedestals
Anchors/ Rod Holder
Winches/ Jacks
Lites/ Tie Downs
Tires/ Couplers
Boat Care
Misc./ Flooring
Skis/Tubes
Floatation
Ladders
Water Front
Fenders/ Dock Lines

Navigation Lites
Steering/ Controls
Hardware/ Fasteners
Covers/ Windshield
Pumps/ Int. Lite
Electric/ Battery
Trolling Motor
Gauges
Electronics/ Radios
Fuel
Lube/ Motor Care
Aux. Brkts/ Tilt/Trim
Spark Plug/ Starters
Props
Seats/ Pedestals
Anchors/ Rod Holder
Winches/ Jacks
Lites/ Tie Downs
Tires/ Couplers
Boat Care
Misc./ Flooring
Ski's/Tubes
Floatation
Ladders
Water Front
Fenders/ Dock Lines



Chrome Plated Trailer Balls
Clam Packaged
Machined from cold drawn steel bars.



| Mfg # | Ball Size | Class | Description | Order No. | Retail |
|---------|-----------|-------|-----------------------|-----------|---------|
| DL26314 | 1-7/8" | I | 3/4" x 1-3/4" shank | 17430 | \$12.49 |
| DL26318 | 2" | II | 3/4" x 1-11/16" shank | 17431 | 13.49 |
| DL26302 | 2" | III | 1" x 2" shank | 17386 | 15.99 |
| DL26306 | 2-5/16" | 6000# | 1" x 2" shank | 17387 | 20.49 |



Hitch Ball - Chrome

- Solid steel hitch balls manufactured to meet all Safety requirements of VESC regulation V-5
- Cold forged for superior strength



| Description | Order No. | Retail |
|--|-----------|---------|
| 1-7/8" Ball, 3/4"x2-3/8" Shaft, 2000# Cap. | 22770 | \$13.49 |
| 1-7/8" Ball, 1"x2-1/8" Shaft, 2000# Cap. | 22772 | 12.49 |
| 2" Ball, 1"x2-1/8" Shaft, 7500# Cap. | 22774 | 12.99 |

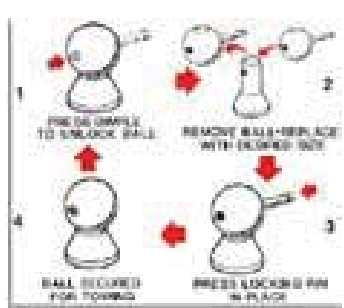

CONVERT-A-BALL™
HITCH SYSTEM PRODUCTS

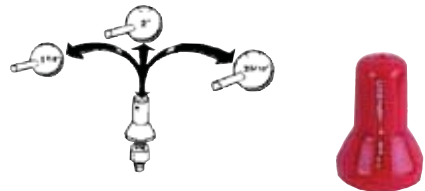

Convert-A-Ball is your answer to multi-need trailer connections. No more wrenches, no more busted knuckles.

| Mfg. # | Description | Order No. | Retail |
|---------|--|--------------------|---------|
| 944-800 | 1-7/8" & 2" set - 3/4" long shank | 15192 _T | \$45.49 |
| 944-900 | 1-7/8", 2" & 2-5/16" set - 1" std. shank | 15195 _T | 66.99 |
| 944-901 | 1-7/8" & 2" set - 1" standard shank | 15197 _T | 47.99 |
| 944-102 | 1" Standard Shank | 15177 _T | \$20.49 |
| 944-300 | 1-7/8" Replacement ball | 15180 _T | 14.49 |
| 944-400 | 2" Replacement ball | 15183 _T | 16.49 |
| 944-600 | 2-5/16" Replacement ball | 15186 _T | 20.99 |
| 944-004 | 3 Ball storage box | 15205 _T | 13.49 |
| 944-005 | Vinyl shank cover | 15210 _T | 1.49 |

