

- Navigation Lites
- Steering/ Controls
- Hardware/ Fasteners
- Covers/ Windshield
- Pumps/ Int. Lite
- Electric/ Battery
- Trolling Motor
- Gauges
- Electronics/ Radios
- Fuel
- Lube/ Motor Care
- Aux. Brkts/ Tilt/Trim
- Spark Plug/ Starters
- Props
- Seats/ Pedestals
- Anchor/ Rod Holder
- Winches/ Jacks
- Lites/ Tie Downs
- Tires/ Couplers
- Boat Care
- Misc./ Flooring
- Ski's/Tubes
- Floation
- Ladders
- Water Front
- Fenders/ Dock Lines



Spoked



Modular

Tire and Wheel Assemblies

Conversion Chart	
A78-13.....(NLA)	ST165
B78-13.....	ST175/80D13
C78-13.....	ST185/80D13
F78-14.....	ST205/75D14
G78-14.....	ST215/75D14
H78-15.....	ST225/75D15

LOAD STAR <small>High Speed Trailer Tires</small>		Tire Size	Range	Rim	Hole Pattern	 Order No.	Retail
Highway Trailer Bias Tires & Wheels (White Rims)		4.80 x 8	B	Standard	4	16008 ^{THF}	\$41.99
		4.80 x 8	B	Standard	5	16012 ^{THF}	41.99
		5.70 x 8	C	Standard	4	16016 ^{THF}	65.99
		5.70 x 8	C	Standard	5	16020 ^{THF}	65.99
		4.80 x 12	B	Spoked	4	16069 ^{THF}	\$69.99
		4.80 x 12	B	Spoked	5	16070 ^{THF}	71.99
		4.80 x 12	B	Modular	5	16033 ^{THF}	68.99
		5.30 x 12	C	Spoked	4	16024 ^{THF}	81.99
		5.30 x 12	C	Spoked	5	16029 ^{THF}	82.99
		5.30 x 12	C	Modular	5	16026 ^{THF}	81.99
	215/60 x 8 (18.5/8.5 x 8)	C	Standard	5	16023 ^{THF}	\$87.99	
	205/65 x 10 (20.5/8.0 x 10)	E	Standard	5	16027 ^{THF}	124.99	

LOAD STAR <small>High Speed Trailer Tires</small>		Tire Mfg.	Tire Size	Range	Rim	Holes	 Order No.	Retail
Metric Bias Tires And Wheels (White Rims)		Load Star	ST175/80D-13	B	Spoked	4	16088 ^{THF}	\$102.99
		Load Star	ST175/80D-13	B	Spoked	5	16066 ^{THF}	101.99
		Load Star	ST175/80D-13	B	Modular	5	16067 ^{THF}	100.99
		Load Star	ST175/80D-13	C	Spoked	4	16089 ^{THF}	114.99
		Load Star	ST175/80D-13	C	Spoked	5	16073 ^{THF}	114.99
		Load Star	ST185/80D-13	C	Spoked	5	16062 ^{THF}	126.99
		Load Star	ST205/75D-14	C	Spoked	5	16068 ^{THF}	149.99
		Load Star	ST215/75D-14	C	Spoked	5	16072 ^{THF}	160.99
		Load Star	ST225/75D-15	D	Spoked	5	16071 ^{THF}	185.99
		Load Star	ST225/75D-15	D	Spoked	6	16083 ^{THF}	189.99



Directional Silver Wheels w/Black Rivets

LOAD STAR <small>High Speed Trailer Tires</small>		Tire Mfg.	Tire Size	Range	Rim	Holes	 Order No.	Retail
		Arisun	ST175/80D13	C	Directional	5	16302 ^T	\$114.99
		Trailer King	ST175/80R13	C	Directional	5	16303 ^T	132.99
		Trailer King	ST205/75R14	C	Directional	5	16304 ^T	162.99
		Trailer King	ST215/75R14	C	Directional	5	16306 ^T	182.99

Tire and Wheel Assemblies



Spoked



Modular

Metric Radial Tires And Wheels (White Rims)

Tire Mfg.	Tire Size	Range	Rim	Holes	Order No.	Retail
Trailer King	ST175/80R-13	C	Spoked	5	16224_T	\$121.99
Rainier	ST185/80R-13	D	Spoked	5	16226_T	152.99
Trailer King	ST205/75R-14	C	Spoked	5	16228_T	155.99
Trailer King	ST215/75R-14	C	Spoked	5	16230_T	174.99

Tire Mfg.	Tire Size	Range	Rim	Holes	Order No.	Retail
GoodYear	ST215/75R-14	C	Modular	5	16200_T	\$211.99

Navigation
Lites

Steering/
Controls

Hardware/
Fasteners

Covers/
Windshield

Pumps/
Int. Lite

Electric/
Battery

Trolling
Motor

Gauges

Electronics/
Radios

Fuel

Lube/
Motor Care

Aux. Brkts/
Tilt/Trim

Spark Plug/
Starters

Props

Seats/
Pedestals

Anchor/
Rod Holder

Winches/
Jacks

Lites/
Tie Downs

Tires/
Couplers

Boat
Care

Misc./
Flooring

Ski's/Tubes

Floatation

Ladders

Water
Front

Fenders/
Dock Lines

Silver Painted Wheels - used on Shoreland'r - 2001-2007



Tire Mfg.	Tire Size	Range	Rim	Holes	Order No.	Retail
Load Star	4.80 x 12	B	Modular	5	16242_{THF}	\$66.99
Load Star	5.30 x 12	C	Modular	5	16244_{THF}	81.99
Load Star	5.30 x 12	C	Blade	5	16028_{THF}	81.99
Trailer King	175/80R13ST	C	Directional	5	16232_T	\$131.99
Trailer King	185/80R13ST	D	Directional	5	16234_T	155.99
Trailer King	ST205/75R-14	C	Directional	5	16236_T	161.99
Trailer King	215/75R14ST	C	Directional	5	16238_T	181.99
Trailer King	ST205/75R15	D	Directional	5	16239_T	189.99



LOAD STAR
High Speed Trailer Tires

Metric Bias

Tire Size	Range	Rim	Holes	Order No.	Retail
4.80 x 12	C	Spoked	5	16049_{THF}	\$68.99
5.30 x 12	C	Spoked	5	16052_{THF}	80.99
ST175/80D13	B	Spoked	5	16047_{THF}	103.99
ST175/80D13	C	Spoked	5	16050_{THF}	116.99
ST185/80D13	C	Spoked	5	16046_{THF}	127.99
ST205/75D14	C	Spoked	5	16051_{THF}	140.99
ST215/75D14	C	Spoked	5	16053_{THF}	151.99

Tire Size	Range	Rim	Holes	Order No.	Retail
215/60-8	C	Solid	5	16060_{THF}	\$87.99
205/65-10	E	Solid	5	16061_{THF}	124.99

Tire Size	Range	Rim	Holes	Order No.	Retail
4.80 x 12	C	Spoked	5	16054_{THF}	\$80.99
5.30 x 12	C	Spoked	5	16055_{THF}	93.99
ST175/80D13	C	Spoked	5	16056_{THF}	133.99
ST185/80D13	C	Spoked	5	16059_{THF}	144.99
ST205/75D14	C	Spoked	5	16057_{THF}	166.99
ST215/75D14	C	Spoked	5	16058_{THF}	176.99

Boat
Care

Misc./
Flooring

Ski's/Tubes



Floatation

Ladders

Water
Front

Fenders/
Dock Lines

Silver Painted
Used on
Karavan

Galvanized
Used on
Karavan



Navigation Lites
Steering/ Controls
Hardware/ Fasteners
Covers/ Windshield
Pumps/ Int. Lite
Electric/ Battery
Trolling Motor
Gauges
Electronics/ Radios
Fuel
Lube/ Motor Care
Aux. Brkts/ Tilt/Trim
Spark Plug/ Starters
Props
Seats/ Pedestals
Anchors/ Rod Holder
Winches/ Jacks
Lites/ Tie Downs
Tires/ Couplers
Boat Care
Misc./ Flooring
Ski's/Tubes
Floatation
Ladders
Water Front
Fenders/ Dock Lines



"V-5 MAG" Silver Wheels and Metric Radial Tires as used on EZ-Loader

Tire Mfg.	Tire Size	Range	Rim	Holes	Order No.	Retail
Trailer King	ST175/80R13	C	V-5 MAG	5	16213 _T	\$92.99
Rainier	ST185/80R13	C	V-5 MAG	5	16215 _T	98.99
Trailer King	ST205/75R14	C	V-5 MAG	5	16217 _T	109.99
Trailer King	ST215/75R14	C	V-5 MAG	5	16219 _T	129.99



Directional Chrome Wheels w/Black Rivets and **Trailer King** Metric Radial Tires

Tire Size	Range	Rim	Holes	Order No.	Retail
205/75R14ST	C	Directional	5	16240 _T	\$206.99
215/75R14ST	C	Directional	5	16241 _T	252.99



Metric Radial Tires - Silver Painted or Galvanized Spoked Wheels as used on Karavan

Tire Mfg.	Tire Size	Range	Rim	Hole	Order No.	Retail
Load Star	ST145/R-12	E	Silver Paint	5	16082 _{THF}	\$121.99
Load Star	ST175/80R-13	C	Silver Paint	5	16074 _{THF}	126.99
Load Star	ST205/75R-14	C	Silver Paint	5	16077 _{THF}	162.99
Load Star	ST215/75R-14	C	Silver Paint	5	16078 _{THF}	167.99
Load Star	ST175/80R-13	C	Galvanized	5	16079 _{THF}	\$142.99
Load Star	ST215/75R-14	C	Galvanized	5	16081 _{THF}	193.99



Trailer Wheels Only - White Color

Size	Description	Order No.	Retail
12"	4-hole spoked	16090 _{THF}	\$29.99
12"	5-hole spoked	16092 _{THF}	28.99
13"	5-hole spoked	16100 _{THF}	30.99
14"	5-hole spoked	16102 _{THF}	48.99



Lug Bolts and Nuts
• 1/2" - 20 threads
• 5/Card

Mfg #81170 Bolts
Order No. 62665 \$8.49

Mfg #81172 Nuts
Order No. 62667 \$6.49



Nesting Wheel Chock
Keep your trailer in place. Durable plastic with UV inhibitors. for tires to 26". 1-pr/pack.

Mfg #44418
Order No. 30833 \$6.99



Wheel Chock
Keep your trailer in place. Includes rope attachment.

Mfg #44472
Order No. 30834 \$5.99



Replacement Tires Only



Metric Bias	Tire Size	Range	Order No.	Retail
	ST175/80D-13	B	16040 _{THF}	\$69.99
	ST175/80D-13	C	16043 _{THF}	82.99
	ST185/80D-13	C	16041 _{THF}	93.99
	ST205/75D-14	C	16042 _{THF}	102.99
	ST215/75D-14	C	16048 _{THF}	111.99

Navigation Lites
Steering/ Controls
Hardware/ Fasteners
Covers/ Windshield
Pumps/ Int. Lite
Electric/ Battery
Trolling Motor
Gauges
Electronics/ Radios

LOAD STAR Bias Highway/Trailer

Tire Size	Range	Order No.	Retail	Tire Size	Range	Order No.	Retail
4.80 x 8	B	16035 _{THF}	\$27.99	B78-13	B	16040 _{THF}	\$69.99
5.70 x 8	C	16036 _{THF}	47.99	B78-13	C	16043 _{THF}	82.99
4.80 x 12	B	16037 _{THF}	41.99	C78-13	C	16041 _{THF}	93.99
5.30 x 12	C	16044 _{THF}	54.99	F78-14	C	16042 _{THF}	102.99
				G78-14	C	16048 _{THF}	111.99

Fuel
Lube/ Motor Care
Aux. Brkts/ Tilt/Trim
Spark Plug/ Starters
Props

Plastic Fenders w/step
Used on Spartan Trailers 1997 and older

Marlex



This fender attaches with 2 bolts and 1 screw per end. The bolts are vertical from the step through the bracket, the screw is horizontal from the front of the step into the bracket.



Description	Color	Length	Width	Height	Order No.	Retail
14" Fender	White	40"	9.50"	11.75"	54686	\$47.99

Seats/ Pedestals
Anchors/ Rod Holder
Winches/ Jacks
Lites/ Tie Downs



Replacement Plastic Fenders

Description	Gray Fender Order No.	Black Fender Order No.	Retail
12" Fender	----	07782	\$44.49
13" Fender w/Steps	07773	07783	68.49
14" Fender w/Steps	07774	07784	79.99



Tires/ Couplers

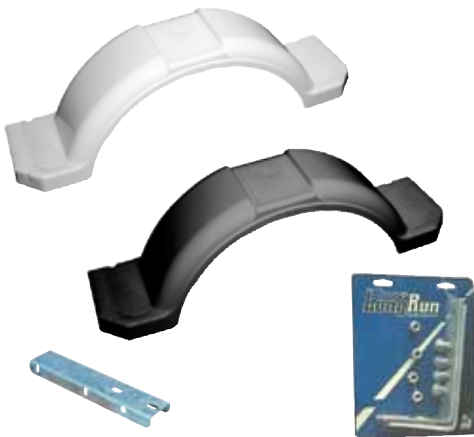

Replacement Plastic Fenders and Brackets

Small Fender: 8" - 12" wheels - width 7-3/4", length 21", height 5"
Large Fender: 13" - 15" wheels - width 11-3/8", length 45", height 11"

Mfg. #	Description	Order No.	Retail
17033	Small Black Fender	62532	\$18.99
44332	Large White Fender	62555	64.99
44331	Large Black Fender	62557	64.99
81231	Small Plastic Fender Bracket-pair	62689	18.99
44141	Large Plastic Fender Bracket-each	62550	14.49

Boat Care
Misc./ Flooring
Ski's/Tubes
Floatation
Ladders
Water Front
Fenders/ Dock Lines

Navigation Lites
Steering/ Controls
Hardware/ Fasteners
Covers/ Windshield
Pumps/ Int. Lite
Electric/ Battery
Trolling Motor
Gauges



Plastic Fenders

Used on Spartan, Triton, Karavan and Hawkeye Trailers

This fender bolts on horizontally with two bolts at each end. Bolts from the inside of fender to the bracket.

Mfg #	Description	Color	Length	Width	Height	Order No.	Retail
8572	12" Fender w/step	White	33.5"	7.50"	8.75"	66330	\$39.99
8582	12" Fender w/step	Black	33.5"	7.50"	8.75"	66333	39.99
8573	13" Fender w/step	White	40.0"	9.00"	12.0"	66334	\$49.99
8583	13" Fender w/step	Black	40.0"	9.00"	12.0"	66335	49.99
8574	14" Fender w/step	White	43.4"	9.70"	12.75"	66336	54.99
8584	14" Fender w/step	Black	43.4"	9.70"	12.75"	66337	54.99

Electronics/ Radios
Fuel
Lube/ Motor Care
Aux. Brkts/ Tilt/Trim
Spark Plug/ Starters
Props
Seats/ Pedestals
Anchors/ Rod Holder
Winches/ Jacks
Lites/ Tie Downs

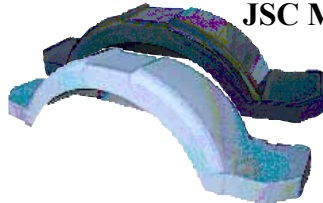

JSC MARKETING

Plastic Fenders

Used on Spartan, Karavan, Tritan and Warrior Trailers

This fender attaches from the bottom with 4 screws on each end. Vertically from the bracket up into the fender.



Bracket Kit Only
Order No. 16122
Retail \$25.99

Mfg #	Description	Color	Length	Width	Height	Order No.	Retail
-----	8-12" Fender	Black	20.38"	6.75"	6.08"	54682	\$14.99
F9P37S9W	12" Fender w/step	White	37.5"	9.0"	9.5"	16112	38.99
F9P37S9B	12" Fender w/step	Black	37.5"	9.0"	9.5"	16114	38.99
F10P40S10W	13" Fender w/step	White	40.09"	10.0"	11.65"	16115	\$54.99
F10P40S10S	13" Fender w/step	Silver	40.09"	10.0"	11.65"	16116	54.99
F10P40S10B	13" Fender w/step	Black	40.09"	10.0"	11.65"	16117	54.99
F11P43S11W	14" Fender w/step	White	43.0"	11.0"	12.89"	16118	\$59.99
F11P43S11S	14" Fender w/step	Silver	43.0"	11.0"	12.89"	16119	59.99
F11P43S11B	14" Fender w/step	Black	43.0"	11.0"	12.89"	16120	59.99

Tires/ Couplers
Boat Care
Misc./ Flooring
Ski's/Tubes
Floatation
Ladders
Water Front
Fenders/ Dock Lines

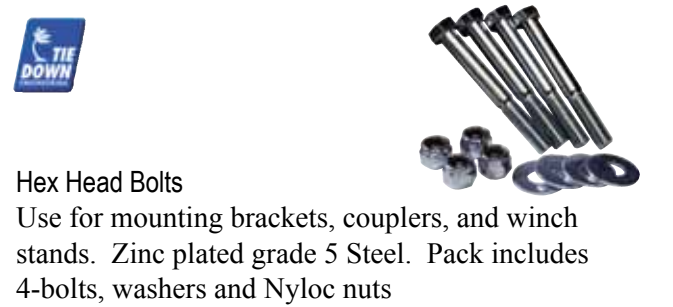

Hex Head Bolts
Use for mounting brackets, couplers, and winch stands. Zinc plated grade 5 Steel. Pack includes 4-bolts, washers and Nyloc nuts

Mfg. #	Description	Order No.	Retail
86253	3/8" x 3"	62582	\$9.99
86254	3/8" x 4"	62583	10.99
86255	3/8" x 1"	62584	7.49
86256	7/16" x 1"	62585	8.49
86257	1/2" x 3-1/2"	62586	13.49



Mfg. #	Description	Order No.	Retail
290-001405	Axle nut retainer	07760	\$2.15
290-010452	Axle hub nut 13/16"	07761	2.15
290-010827	Tongue axle washer	07762	4.59
290-023390	D-shape axle washer	07763	1.59

Hub Retaining Hardware

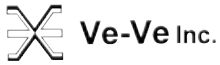

High Mount Spare Tire Carriers

- Fits 3", 4" and 5" Frames
- Fits 4 or 5 Hole Rims
- Has Lock-Tab for Optional Padlock



Mfg #	Description	Order No.	Retail
SM-96	13" Max. tire & wheels	64624 _T	\$44.99
SM-97	Tires up to 16" - holds tire at an angle	64626 _T	62.49
SM-98	Tires up to 16" - holds tire straight	64627 _T	62.49



Spare Tire Carrier

This bracket extends the tire up and away from trailer and boat. Fits wheels Up to 14".



Mfg #	Description	Order No.	Retail
22120	Zinc plated	17498	\$38.99
22121	Black coated	17499	37.99



Heavy Duty Spare Tire Carrier

Fits Tires up to 16". Provides 4-3/4" of lift and 7" of offset to mount tire up and out of the way. Universal mounting system fits frames up to 3" x 5". Zinc plated.



Mfg #HDSTC	
Order No. 22691	\$58.99

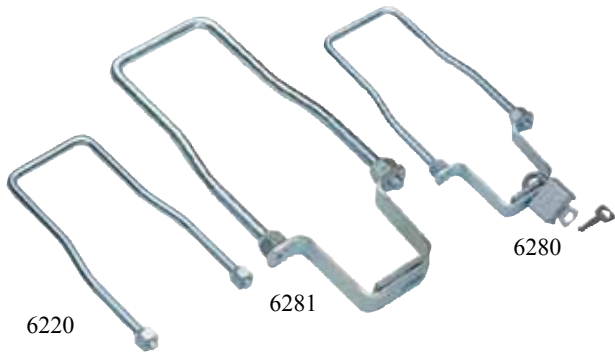

U-Bolt Spare Tire Holders

For 8-12" wheels. Fits 4 or 5 hole rims.

Mfg #	Description	Order No.	Retail
6220	U-Bolt Tire Carrier - Pkg.	17500	\$13.49
6281	Carrier w/lock brackets	17550	23.99
6280	Carrier w/brackets & lock	17508	34.99

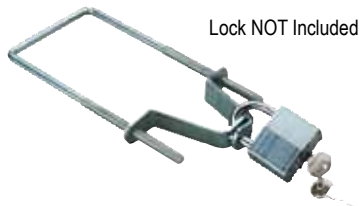

Lock NOT Included

U-Bolt Style Tire Carrier

Mounts tire in any position on tongue or trailer frame. Fits frames to 3-1/2" x 4" rectangular in size. Fits 4 or 5-hole rims 8" to 15" tires.

Mfg #11090-3	
Order No. 09270	\$12.99

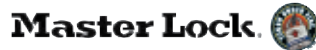

Spare Tire Lock

Chrome plated, lug nut enclosing keyed lock.

Mfg #262DAT	
Order No. 37915 _{THF}	\$9.49



Trailer Wheel Lock

1/2" x 20 cone seat. For steel or alloy wheels. Hardened, triple-nickel chrome plated steel. 2 Locks per pkg.

Mfg #74042	
Order No. 35818 _{THF}	\$22.99

- Navigation Lites
- Steering/ Controls
- Hardware/ Fasteners
- Covers/ Windshield
- Pumps/ Int. Lite
- Electric/ Battery
- Trolling Motor
- Gauges
- Electronics/ Radios
- Fuel
- Lube/ Motor Care
- Aux. Brkts/ Tilt/Trim
- Spark Plug/ Starters
- Props
- Seats/ Pedestals
- Anchors/ Rod Holder
- Winches/ Jacks
- Lites/ Tie Downs
- Tires/ Couplers
- Boat Care
- Misc./ Flooring
- Ski's/Tubes
- Floatation
- Ladders
- Water Front
- Fenders/ Dock Lines

	U-Bolts	Mfg #	Stock	"B"	"C"	"D"	Order No.	Retail
Navigation Lites	Square bend-style U-bolts.	86219	3/8"	1-5/8"	3-9/16"	1-3/4"	62718	\$5.49/ea
Steering/ Controls	Made of solid zinc-plated steel. Packaged with washers and nuts.	86208	3/8"	2-1/8"	4"	1-3/4"	62708	12.99/pr
Hardware/ Fasteners		86209	3/8"	3-1/8"	3"	1-3/4"	62709	10.99/pr
		86210	3/8"	3-1/8"	4"	1-3/4"	62710	11.49/pr
Covers/ Windshield		86211	3/8"	4-1/8"	3"	1-3/4"	62711	\$12.49/pr
		290-002422	3/8"	3"	4"		07750	4.59/ea
Pumps/ Int. Lite		290-028823	3/8"	4"	4"		07752	4.45/ea
Electric/ Battery		11434-3	7/16"	3-1/8"	3"	2"	06672	\$11.49/ea
		11436-3	7/16"	4-1/8"	3"	2"	06674	11.49/ea
Trolling Motor								
Gauges		86213	1/2"	1-9/16"	4-1/16"	2"	62712	\$7.99/ea
		86214	1/2"	3-1/16"	3-13/16"	1-1/2"	62713	7.99/ea
Electronics/ Radios		86215	1/2"	2-1/16"	4-13/16"	2"	62714	7.99/ea
		86205	1/2"	3-1/8"	3"	1-1/2"	62705	11.49/pr
Fuel		86206	1/2"	3-1/8"	4"	2"	62706	11.99/pr
		86207	1/2"	4-1/8"	3"	2"	62707	11.99/pr

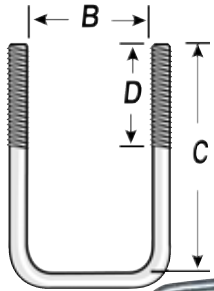

TIE DOWN logo

Replacement Cap for Tie Down Turbo Lube Hub Kits

Mfg #48399A	Order No. 62629	\$14.99
-------------	-----------------	---------

MASTER TOOL CO. INC.

Plastic Shackle Bushings

.875 Outside diameter.
1/2" inside diameter.

Mfg #355	Order in multiples of 12
Order No. 38104	\$1.49

TIE DOWN logo

Vortex Hub Kit
High Performance 100,000 Mile Lubrication System
• "No Touch" lubrication system • No need for periodic re-greasing or inspection • Reusable dust cap is threaded for easy removal • Hub kits are filled with Lucas Marine Grease

Mfg #	Application	Order No.	Retail
81016	1" Bearings	62534 _T	\$87.99
81022	1-3/8" inner, 1-1/16" outer	62538 _T	109.99

TIE DOWN logo

Bearing Seal

- 1-3/8" Bearings
- 2/Pack

Mfg #	Description	Order No.	Retail
81323	1.68" ID	62540	\$5.99/pk
81324	2.13" ID	62542	8.99/pk

attwood logo

Wheel Bearing Kits

- 2-bearings
- 2-races
- 1-seal
- 1-cotter pin.

Mfg #	Application	Order No.	Retail
11057-3	1-1/16" Spindle	06911	\$24.99

genuine Bearing Buddy®
The original... and still the best!
Millions of bearings owe their lives to it.



Bearing Buddy® Selection Chart

BB Model	Outer Bearing Cone	Outer Bearing Cup
1980	L44643, L44649, L44640	L44610
1980A		
1781	LM11949	LM11910
2328	LM67048, hub not counterbored	LM67010
1810	LM67049	LM12711
1938	O9067	O9194, 95, 96
1968	M12649, O7100	M12610, O7196
1980T	All internally threaded hubs	
2047	Various	O7204
2080	900 Series	900 Series
2240	1700 Series	1729
2441	LM67048, hub counterbored	LM67010
	15123 and others	15245
2562	48548	48510
2717	14124, 14125A	14276

Model	Order No.	Retail
1980	05061	\$25.99
1781	05065	23.99
2328	05069	27.99
1810	05073	23.99

Model	Order No.	Retail
1938	05077	\$25.99
2441	05085	35.99
2047	05067	25.99

genuine Bearing Buddy®
The original... and still the best!
Millions of bearings owe their lives to it.



1980 Bearing Buddy w/Auto Check
When the hub is full of grease the blue auto check ring rests about 1/8" outward from steel retaining ring. 1.980" Hub

Mfg #1980A
Order No. 05060 \$26.99



genuine Bearing Buddy®
The original... and still the best!
Millions of bearings owe their lives to it.

Bearing Buddy w/Bra

Mfg #42101 1.980" Hub
Order No. 05062 \$26.99

Mfg #41201 1.781" Hub
Order No. 05066 \$25.99

genuine Bearing Buddy®
The original... and still the best!
Millions of bearings owe their lives to it.



The Bearing Buddy Bra
Keeps grease from flying out on to wheels. 2/pack

Bearing Buddy® Bra	
Model	Fits Bearing Buddy® Model
17B	1781, 1810
19B	1980, 1938, 1968, 2047
23B	2328, 2441, 2717,

Model	Order No.	Retail
19-B	05130	\$3.99
17-B	05127	3.99
23-B	05132	3.99

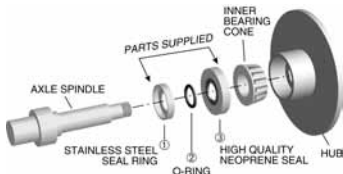

Spindle Seal
For use with bearing buddy on trailer axles with brakes or as a replacement seal system.

Mfg #	Order No.	Retail
#1	05089	\$14.99
#2	05093	14.99
#3	05097	14.99
#4	05103	14.99
#5	05107	14.99

Mfg #	Order No.	Retail
#7	05111	\$14.99
#8	05115	14.99
#9	05119	14.99
#10	05123	14.99
#11	05124	25.49

genuine Bearing Buddy®
The original... and still the best!

SPINDLE SEAL by Bearing Buddy® Selection Chart

Model Number	Use with Bearing Buddy®	Inner Bearing Cone	Seal Diameter
1	1.980	L44643	1.98"
2	1.980, 1.968, 2.562	LM48548, L68149	2.56"
3	1.980	LM29749	2.56"
4	1.938, 1.980T	15123	2.63"
5	1.980	L44649	1.98"
7	1.781	LM67048	2.33"
8	2.328	LM67048	2.33"
9	1.938, 1.980T	15123	2.50"
10	1.810	L68149	2.36"
11	2.441	25580	3.38"

FULTON



Wheel Bearing Protectors

- Provides permanent protection against damage from water and dirt entering the wheel bearings.
- Automatically maintains the correct internal pressure
- Made of chrome plated steel
- Installs quickly and fits tightly on to the hubs

Mfg #	Description	Order No.	Retail
BB1980	1.980" Protector Cover 1-pr	22521	\$5.49

Navigation Lites
Steering/ Controls
Hardware/ Fasteners
Covers/ Windshield
Pumps/ Int. Lite
Electric/ Battery
Trolling Motor
Gauges
Electronics/ Radios
Fuel
Lube/ Motor Care
Aux. Brkts/ Tilt/Trim
Spark Plug/ Starters
Props
Seats/ Pedestals
Anchors/ Rod Holder
Winches/ Jacks
Lites/ Tie Downs
Tires/ Couplers
Boat Care
Misc./ Flooring
Ski's/Tubes
Floatation
Ladders
Water Front
Fenders/ Dock Lines

Navigation Lites
Steering/ Controls
Hardware/ Fasteners
Covers/ Windshield
Pumps/ Int. Lite
Electric/ Battery
Trolling Motor
Gauges
Electronics/ Radios
Fuel
Lube/ Motor Care
Aux. Brkts/ Tilt/Trim
Spark Plug/ Starters
Props
Seats/ Pedestals
Anchors/ Rod Holder
Winches/ Jacks
Lites/ Tie Downs
Tires/ Couplers
Boat Care
Misc./ Flooring
Ski's/Tubes
Floatation
Ladders
Water Front
Fenders/ Dock Lines



Super Lube Dust Caps

Mfg #	Application	Order No.	Retail
81168	1.980" Dust cap	62660	\$11.99
81174	Rubber cover	62559	4.99



Bearing Protectors

Includes 2-dust caps with grease zirk and pressure relief valve. Zinc plated finish. Packed with vinyl covers

Mfg #	Application	Order No.	Retail
6332	1.980" Hub	17492	\$19.49



Reliable Oil Bath Hub Kits - as used on EZ Loader Trailers
Aluminum screw-on dust cap. Includes rubber o-ring. 1.980"



Mfg #	Application	Order No.	Retail
031620	Dust Cap - 2.11" (1.980)	07789	\$25.49
031621	Reliable Oil Bath Dust Cap 2.48" OD	07790	31.49
015973	Spring Bushing Kit	07798	19.39
029533	Reliable Oil Bath Hub Kit - 5hole, 1-1/16x1-1/16	07766 ^{THF}	79.99
029534	Reliable Oil Bath Hub Kit - 5hole, 1-3/8x1-1/16	07768 ^{THF}	79.99

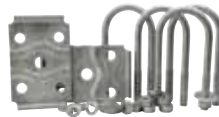

Axle Tie Plate Kit

• Kit includes 4-U-Bolts, 8-Lock Nuts, 2-Tie Plates

Mfg #	Application	Order No.	Retail
86525	1-3/4" Square	62608	\$23.99
86522	1-3/4" Round	62605	22.49
86523	2-3/8" Round	62606	24.99
86524	2" Square	62607	22.49
86526	3" Round	62609	28.49



Cast Replacement Hub

- Greased And Assembled

Pattern	Inner Brg	Outer Brg	Order No.	Retail
4 Bolt	1"	1"	16000	\$47.99
5 Bolt	1"	1"	16004	47.99
4 Bolt	1-1/16"	1-1/16"	16001	47.99
5 Bolt	1-1/16"	1-1/16"	16005	48.99
5 Bolt	1-3/8"	1-1/16"	16006	52.99



Trailer Springs

• Heavy Duty spring steel • Includes 9/16" ID Nylon Bushings



Mfg. #	Description	Order No.	Retail
81187	2-Leaf 500# 24-5/8" - Slipper Spring Flat End	62544 ^T	\$30.49
81188	4-Leaf 1,000# 24-5/8" - Slipper Spring Flat End	62545 ^T	39.49
81189	2-Leaf 1,000# 30" - Slipper Spring Radius End	62546 ^T	42.49
81191	4-Leaf 1,850# 30" - Slipper Spring Radius End	62548 ^T	69.99
81192	4-Leaf 2,500# 25-1/4" - Double Eye End	62549 ^T	55.99



Axle Spindles
with Nut, Washer and Cotter Pin

Mfg. #	Spindle Desc.	Bearing Surface	Order No.	Retail
80055	1-1/4" x 7"	1"	62600 ^T	\$21.99
80060	1-1/4" x 7"	1-1/16"	62603 ^T	21.99
80235	1-3/4" x 8-1/4"	1-1/16" & 1-3/8"	62610 ^T	28.99
81169	Nut, Washer & Cotter Pin only		62661	5.99

	Mfg #	Spindle/Size	O.E. No.	Order No.	Retail
Bearings 	11050	3/4"	LM11949	62639	\$6.99/ea
	81150	1"	L44643	62640	5.99/ea
	81151	1-1/16"	L44649	62641	5.99/ea
	125TN	1-1/4"	LM67048	62642	8.99/ea
	81160	1-3/8"	L68149	62645	5.99/ea
Races 	11051	3/4"	LM11910	62649	\$ 2.99/ea
	81161	1" & 1-1/6"	L44610	62650	2.49/ea
	11057	1-1/4"	LM67010	62651	4.49/ea
	81163	1-3/8"	L68111	62655	3.49/ea
	----	1-3/8"	L68110	62656	12.49/ea
Dust Caps 	1925	1.986	N/A	66250	\$3.99/ea
	1926	2.332	N/A	66254	4.99/ea
	1927	2.448	N/A	66258	4.49/ea
	1928	1.75		66262	3.99/ea
	Seals 	TCM11174VB	3/4"	O/D 1.780 I/D 1.080 Depth .469	17564
TCM12192VB		1" & 1-1/16"	1.979 1.210 .250	17561	2.69/ea
TCM15234VB		1-1/4"	2.328 1.455 .406	17562	3.59/ea
TCM171255VB		1-3/8"	2.561 1.685 .500	17563	2.89/ea
Double Lip Seals-w/Spring 		TCM12192TB	1"	1.979 1.205 .250	54761
	TCM127194TB	1"	1.983 1.225 .437	54756	10.49/ea
	TCM15192TB	1-1/16"	1.983 1.445 .250	17560	3.39/ea
	TCM12194TC	1" & 1-1/16"	1.979 1.205 .406	54758	6.25/ea
	TCM152563TB	1-3/8"	2.561 1.435 .313	54762	11.79/ea
	TCM171255TB	1-3/8"	2.561 1.685 .500	54763	\$8.19/ea
	TCM168233TB	1-3/8"	2.328 1.625 .313	54755	8.29/ea
	TCM174253TB	1-3/8"	2.561 1.690 .312	54757	6.79/ea
	TCM168255TC	1-3/8"	2.561 1.625 .500	54759	6.25/ea
	TCM171255UC	1-3/8"	2.561 1.650 .500	62668	5.49/ea

Navigation Lites
Steering/ Controls
Hardware/ Fasteners
Covers/ Windshield
Pumps/ Int. Lite
Electric/ Battery
Trolling Motor
Gauges
Electronics/ Radios
Fuel
Lube/ Motor Care
Aux. Brkts/ Tilt/Trim
Spark Plug/ Starters
Props
Seats/ Pedestals
Anchors/ Rod Holder
Winches/ Jacks
Lites/ Tie Downs

Tires/ Couplers

Boat Care
Misc./ Flooring
Ski's/Tubes
Floatation
Ladders
Water Front
Fenders/ Dock Lines



Wheel Bearing Kits Precision Tapered Roller Bearing Kits include: 2-Cone Bearings, 2-Races, Seal & Cotter Pin. Retail packaged.

Mfg #	Application	Order No.	Retail
81105	3/4" Bearing (2ea LM11949)	62634	\$21.99
81110	1" Bearing (2ea LM44643)	62635	18.99
81115	1-1/16" Bearing (2ea L44649)	62636	18.99
81120	1-1/16" x 3/4" Bearing (L44649/LM11949)	62670	19.99
81125	1-1/4" Bearing (2ea LM67048)	62637	\$20.99
81130	1-1/4" x 3/4" Bearing (LM67048/LM11949)	62671	20.99
81140	1-3/8" x 1-1/16" Bearing (L68149/L44649, 2.3612" Race)	62672	19.99
81142	1-3/8" x 1-1/16" Bearing (L68149/L44649, 2.328" Race)	62673	18.99

Navigation Lites
Steering/ Controls
Hardware/ Fasteners
Covers/ Windshield
Pumps/ Int. Lite
Electric/ Battery
Trolling Motor
Gauges
Electronics/ Radios
Fuel
Lube/ Motor Care
Aux. Brkts/ Tilt/Trim
Spark Plug/ Starters
Props
Seats/ Pedestals
Anchors/ Rod Holder
Winches/ Jacks
Lites/ Tie Downs
Tires/ Couplers
Boat Care
Misc./ Flooring
Ski's/Tubes
Floatation
Ladders
Water Front
Fenders/ Dock Lines



Bearing Sets

Mfg #	Spindle OD	Outer Hub ID	Outer Bearing	Inner Bearing	Outer Cup	Inner Cup
6502	1"	1.980"	L44643	L44643	L44610	L44610
6503	1-1/16"	1.980"	L44649	L44649	L44610	L44610
6506	1-1/4" x 3/4"	1.781"	LM11949	LM67048	LM11910	LM67010
6507	1-3/8" x 1-1/16"	1.980"	L44649	L68149	L44610	L68111
6508	1-3/8" x 1-1/16"	1.980"	L44649	L68149	L44610	L68110

Mfg #	Application	Order No.	Retail
6502	1" axle	17582	\$16.99
6503	1-1/16" axle	17583	16.99
6506	1-1/4" x 3/4" axle	17586	18.99
6507	1-3/8" x 1-1/16" axle	17587	16.99
6508	1-3/8" x 1-1/16" axle	17579	23.49



Seal Kits - Kits contain 2-Seals and 2-Cotter pins.

6511	1-1/16"	1.980	Set of 2 ea. seals #203106 & 2 ea. Cotter keys #203814 for kits # 6202, 6203, 6205, 6502, 6503 & 6505.
6512	1-1/4"	2.320	Set of 2 ea. seals #203122 & 2 ea. Cotter keys #203814 for kits # 6204, 6206, 6504 & 6506.
6513	1-3/8"	2.561	Set of 2 ea. seals #203684 & 2 ea. Cotter keys #203814 for kits # 6207, 6208, 6507 & 6508
6514	3/4"	1.781	Set of 2 ea. seals #203612 & 2 ea. Cotter keys #203814 for kits # 6200 & 6501.
6515	3/4"	1.938	Set of 2 ea. seals #203100 & 2 ea. Cotter keys #203814 for kits # 6201 & 6501.

Mfg #	Application	Order No.	Retail
6511	1" & 1-1/16" spindle	17591	\$7.99
6512	1-1/4" spindle	17592	7.99
6513	1-3/8" spindle	17593	7.99
6514	3/4" spindle	17594	7.99



Stainless Steel Bearing Protector Kit
 • 1.980" OD
 • Bra included

Mfg #	Application	Order No.	Retail
K71-034-00	Kit w/Bra	63419 _{TF}	\$47.49
K71-017-00	Bra Only - 2/pk	63418 _{TF}	6.49



Spindle Hardware Kit - Includes 2/ea

- O-ring
- 1.25" Stainless Wear Ring
- 1.38" Stainless Wear Ring
- D-Washer
- Spindle Nuts
- Nut Retainer
- Cotter Pin



Mfg #	Application	Order No.	Retail
K71-065-00	Hardware Kit	63400 _{TF}	\$18.49



"The Vault" Hybrid Lubrication System

"The Vault" combines the benefits of oil and grease lubricating and protecting your bearings in a sealed pressurized chamber impenetrable by outside elements.

- Stainless Steel components
- Hybrid oil continuously replenishes the lubricant to the bearings.
- Bearings run cooler due to reduced friction



Mfg #	Application	Order No.	Retail
K71-030-00	Vault Bearing Protector Kit	63424 _{TF}	\$125.99
PA0290A	Bearing Protector - 1/ea	63422 _{TF}	\$34.99
PA0290OR	O-Ring Only - 1/ea	63423	3.49
088-014-00	1-Quart Lube	63408 _{TF}	46.49
088-013-00	14-oz Lube	63410 _{TF}	20.99



Marine Corrosion Control And Trailer Bearing Grease

Special water-insoluble formula ideal for marine applications. Provides excellent corrosion protection against severe operating conditions caused by salt water, salt air, and atmospheric chemicals. Use on wheel bearings, including disc brake wheel bearings, and to protect swivel hinges, pins, winches and anchor chain reels from corrosion.

Mfg #	Description	Order No.	Retail
30-190	3-oz Gun w/grease	35137	\$31.49
LM11399	2-pack of 3-oz Grease cart.	35141	7.99
LM11400	4-pack of 3-oz Grease cart.	35144	13.49
LM11406	8 oz. Tube	35222	8.99
LM11404	1-lb tub	35145	\$9.49
LM11402	14-oz cartridge	35143	7.99
30-300	14-oz Pistol-Matic grease gun	35157	23.99

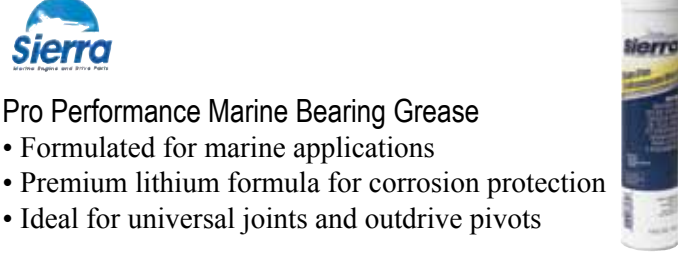

Pro Performance Marine Bearing Grease

- Formulated for marine applications
- Premium lithium formula for corrosion protection
- Ideal for universal joints and outdrive pivots

Mfg #	Description	Order No.	Retail
18-9200-0	8 oz Tube	892000_N	\$7.49
18-9200-1	15 oz Cartridge	892001_N	9.99
18-9700-2	2ea-3oz cart.	897002_N	11.24

Marine Extreme Pressure Waterproof Grease

- Aluminum complex grease for all bearing/bushing applications
- Corrosion protection
- Will not melt, run or wash out



Mfg #	Description	Order No.	Retail
99710CG3	3oz cartridge	08248	\$4.49
99710CG	14oz cartridge	08250	10.49
99540TB	16oz Tub	08252_{THF}	10.49



Marine Grease - Boat Trailer & 4X4 Grease

Excellent water resistance. NLGI-2 aluminum complex base for 4WD and Boat trailer wheel bearings. Drop point 500° F.

Mfg #	Description	Order No.	Retail
SL3120	14-oz Cartridge	10236_T	\$6.99
SL3184	3-oz Cartridge 3/pk	10237_T	8.29



Sport Trailer Guard™

Protect your equipment from rocks and road debris. The Sport Trailer Guard has two 24" rubber flaps which are attached to tubular arms that adjust from 69" to 77". The Sport Trailer Guard attaches securely and can be removed quickly and easily using hitch pins. Fits tow vehicles with 2" class 3 receiver hitches. Black powder coat finish.

Center Skirt

Option for the "Sport Trailer Guard". 36" wide by 18" long skirt that fastens to the center tube of the Sport Trailer Guard. Allows safety chains and wire to pass through easily.

Mfg #	Description	Order No.	Retail
SG-224	Sport Trailer Guard	64600_T	\$179.99
SG-230	Center Skirt	64601_{TF}	79.99

Navigation Lites

Steering/ Controls

Hardware/ Fasteners

Covers/ Windshield

Pumps/ Int. Lite

Electric/ Battery

Trolling Motor

Gauges

Electronics/ Radios

Fuel

Lube/ Motor Care

Aux. Brkts/ Tilt/Trim

Spark Plug/ Starters

Props

Seats/ Pedestals

Anchors/ Rod Holder

Winches/ Jacks

Lites/ Tie Downs

Tires/ Couplers

Boat Care

Misc./ Flooring

Ski's/Tubes

Floatation

Ladders

Water Front

Fenders/ Dock Lines

Navigation
Lites
Steering/
Controls
Hardware/
Fasteners
Covers/
Windshield
Pumps/
Int. Lite

A-75 Actuator - 7,500 lb, 2" Ball - Drum Brake System
 Unique to the A-75 actuator is a hole at the top of the ball socket acting as a visual indicator ensuring the ball is properly seated.
 • 3x3" or 3x4" tongue



Mfg #	Description	Order No.	Retail
099-075-00	Inner member	63440 _{TF}	\$124.99
099-075-01	Weld on, 17.5" long	63442 _{TF}	153.99
099-075-04	Bolt on, Top mount 14.5" long	63444 _{TF}	154.99

Electric/
Battery
Trolling
Motor
Gauges
Electronics/
Radios
Fuel

A-60 Actuator - 7,500 lb, 2" Ball - Drum Brake System
 The unique over the center latch mechanism will only engage when the actuator is fully seated.
 • 3x3" or 3x4" tongue



Mfg #	Description	Order No.	Retail
099-060-00	Inner member	63432 _{TF}	\$156.49
099-060-01	Weld on, 17.5" long	63434 _{TF}	224.99
099-060-04	Bolt on, Top mount 14.5" long	63438 _{TF}	193.49

Lube/
Motor Care
Aux. Brkts/
Tilt/Trim
Spark Plug/
Starters
Props
Seats/
Pedestals

A-60 Actuator - 7,500 lb, 2" Ball - Disc Brake System
 The unique over the center latch mechanism will only engage when the actuator is fully seated.
 • 3x3" or 3x4" tongue



Mfg #	Description	Order No.	Retail
099-060-20	Inner member	63430 _{TF}	\$192.49
099-060-24	Bolt on, Top mount 14.5" long	63436 _{TF}	229.49

Anchors/
Rod Holder
Winches/
Jacks
Lites/
Tie Downs
Tires/
Couplers
Boat
Care
Misc./
Flooring



Emergency Cable Replacement Kit
 • A-60 Actuator
 Mfg #K71-760-00
Order No. 63377_{TF} \$33.49



Emergency Cable Replacement Kit
 • A-75 Actuator
 Mfg #K71-761-00
Order No. 63379_{TF} \$33.49



Latch Replacement Kit
 • A-75 Actuator
 Mfg #K71-766-00
Order No. 63389_{TF} \$34.99

Ski's/Tubes
Floatation
Ladders
Water
Front
Fenders/
Dock Lines



Brake Actuator Cap
 • A-60/75 Actuator
 Mfg #PA0020A
Order No. 63373 \$3.49



Consumer Lock-Out Kit
 • A-60/75 Actuator
 Mfg #K71-769-00
Order No. 63375_{TF} \$6.49



Latch Replacement Kit
 • A-60 Actuator
 Mfg #PA9002
Order No. 63391_{TF} \$44.99



Complete Wheel End Kit

- 3750lb Hub/Rotor w Caliper
- 2-Seals (ID-1.68", ID-1.71")
- Inner Bearing L68149
- Outer Bearing L44649
- Stainless Bearing Protector w/bra

New

Mfg #K71-077-05	
Order No. 63402TF	\$159.99



Caliper Replacement Kit

- 3,500 - 7000 lb Axle Rating
- Caliper Assembly - Zinc
- Bolts w/threadlock coating

New

Mfg #	Description	Order No.	Retail
K71-773-01	Left Hand	63404TF	\$89.99
K71-773-02	Right Hand	63405TF	89.99



Brake Pad Replacement Kit

- 4-Universal Brake Pad inner/outer
- 4-Pad seat, stainless steel
- 2-Retainer, wire form
- 2-Dust boot
- 2-Piston seals
- 4-Slider pin bolt boot
- 4-Slider pin bolt plug
- 4-Bolts w/threadlock coating



New

Mfg #K71-779-00	
Order No. 63406TF	\$45.49



Roller Pin & Pad Kit

- 2-Zinc roller pins
- 2-Rear roller pin washers
- 2-Front roller pin washers
- 4-Retaining ring
- 2-Rear rollers
- 2-Front rollers
- Top wear pad
- 6-Side thin wear pads
- 3-Top/bottom thick wear pads



New

Mfg #K71-759-00	
Order No. 63385TF	\$35.49



Master Cylinder Replacement Kit

- Disc Brakes
- With reverse lock-out solenoid



New

Mfg #K71-757-00	
Order No. 63393TF	\$101.99



Master Cylinder Replacement Kit

- Disc Brakes
- Without reverse lock-out solenoid



New

Mfg #PA0015	
Order No. 63394TF	\$81.99



Hitch Pin

- A-60 (Long Pin)
- A-75 (Short Pin)



New

Mfg #	Description	Order No.	Retail
K71-764-00	A60 Coupler	63381TF	\$9.49
K71-765-00	A75 Coupler	63383TF	7.99



Reverse Lock-Out Solenoid

- Disc Brakes
- Solenoid w/Drain tube



New

Mfg #K71-757-00	
Order No. 63387TF	\$67.49

Navigation Lites

Steering/ Controls

Hardware/ Fasteners

Covers/ Windshield

Pumps/ Int. Lite

Electric/ Battery

Trolling Motor

Gauges

Electronics/ Radios

Fuel

Lube/ Motor Care

Aux. Brkts/ Tilt/Trim

Spark Plug/ Starters

Props

Seats/ Pedestals

Anchors/ Rod Holder

Winches/ Jacks

Lites/ Tie Downs

Tires/ Couplers

Boat Care

Misc./ Flooring

Ski's/Tubes

Floatation

Ladders

Water Front

Fenders/ Dock Lines



10" x 2-1/4" Standard Freebacking
Backing Plate Assembly - Complete
• 3,750 lb axle rating 70 sq. in. Swept Area.

Mfg #	Description	Order No.	Retail
023-545-00	Right Side	16177 _{TF}	\$63.49
023-544-00	Left Side	16176 _{TF}	63.49



10" x 2-1/4" Uni-Servo
Backing Plate Assembly - Complete
• 3,750 lb axle rating 71 sq. in. Swept Area

Mfg #	Description	Order No.	Retail
023-609-00	Right Side	16175 _{TF}	\$62.99
023-608-00	Left Side	16174 _{TF}	62.99



10" x 2-1/4" Hub and Drum
w/Cups and Studs
• Includes bearing cups
• No bearings included (1-3/8" x 1-1/16")

Mfg #008-438-08
Order No. 16179_{TF} \$69.99



Hydraulic Brake Fitting
and Tubing Kit
• Single torsion axle application

Mfg #071-B18-00
Order No. 16180_{TF} \$119.99

Disc Brake End Kit - 10" 3500lb Rating

A complete kit to replace drum or disc brakes as an assembly.

Kit includes:

- Hub and Rotor
- Caliper
- Bearings w/Bearing Buddy
- Mounting Bracket
- Bracket Hardware
- Spindle Seal

Mfg #	Description	Order No.	Retail
4843000	Brake End Kit	16182 _{TF}	\$149.99
071-B31-00	Caliper Pads	16183 _{TF}	29.99

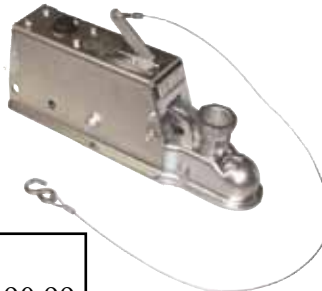

Titan/Dico
Hydraulic Drum Brake Actuator

- 6000#
- 1-7/8" & 2" Ball

Mfg #068-139-00
Order No. 16150_{TF} \$190.99



Model 60 Leverlock Actuator
6,000lb capacity, 600lb tongue load.

- Disc Brakes
- 3" tongue
- 1-7/8" or 2" ball



Mfg #068-196-02
Order No. 16149_{TF} \$219.99



Brake Shoes & Wheel Cylinders



Uni-Servo



Free Backing

Mfg #	Description	Order No.	Retail
040-420-00	10" Front pad for Uni-Servo	16164 _{TF}	\$30.49
040-411-00	10" Front pad for Free Backing	16166 _{TF}	29.99
040-422-00	10" Back pad for Uni-Servo or Free Backing	16168 _{TF}	29.99
054-064-00	Left hand wheel cylinder assy.	16170 _{TF}	\$22.49
054-065-00	Right hand wheel cylinder assy.	16172 _{TF}	22.49



Brake Coupler and Repair Parts

Using the diagram pick the kit that best fits your needs.

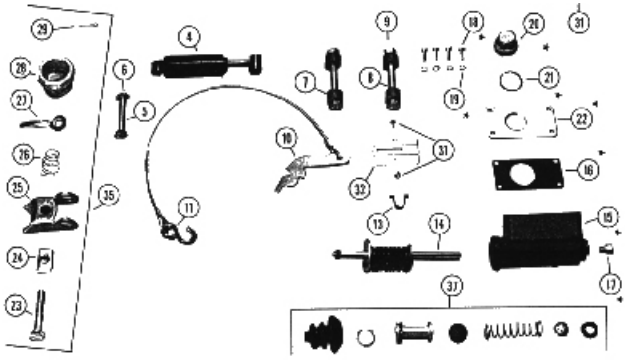

Description	Order No.	Retail
Coupler repair kit #35 (turn down)	16151 _{TF}	\$22.99
Coupler repair kit #35 (snap down)	16155 _{TF}	71.49
Coupler lock #27	16153 _{TF}	1.79
Ball latch #25	16163 _{TF}	7.99
Shock absorber #4	16152 _{TF}	42.99
Brake cable, cover & S-hook #10,11,32	16154 _{TF}	16.99
Fill cap & gasket #20,21	16156 _{TF}	9.99
Master cylinder repair kit #37	16160 _{TF}	25.99
Master cylinder kit #15 thru #22	16162 _{TF}	83.99



Brake Coupler And Repair Parts

Using the diagram pick the kit that best fits your needs.

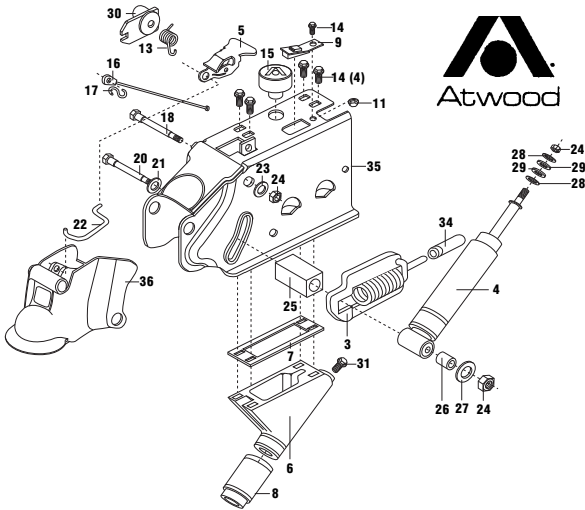

Description	Order No.	Retail
Shock Absorb kit #4,24-2ea,28-2ea,29-2ea.	07603	\$59.99
Push rod kit #3,6,7,8,9,11,14-5ea,16,17,24-2ea,34	07617	142.99
Cap replacement kit #15	07615	8.99
Shoulder bolt kit #20,21,24-2ea,25,26,27	07607	14.99
Release handle kit #5,13,18,22,24-3ea,30	07609	29.99
Stop & sprg kit #9,11,14,24	07611	19.99
Push rod assy. #3,7,11,14-5ea,16,17,24-2ea,34,8,9	07613	45.99
Master cyl. brass elbow (not shown)	07619	4.99



Hydraulic Drum Brake Actuator

• 6000# • 2" Ball



Mfg #84132
Order No. 07601 \$274.99

Reverse Lock Out Solenoid

A reverse lockout solenoid should be installed at the actuator (if not already installed) before installation of disc brakes. Can be used on drum brakes as well.



Mfg #81103
Order No. 62632_{TF} \$54.99



Model 660 Hydraulic Drum Brake Actuator

• 6600#
 • 2" Ball
 • 3" Tongue
 • Drop N Go auto latch coupler



Mfg #82401
Order No. 62620_{TF} \$214.99



Model 660 Hydraulic Disc Brake Actuator

• 6600#
 • 2" Ball
 • 3" Tongue
 • Drop N Go auto latch coupler
 • Includes solenoid



Mfg #82400
Order No. 62617_{TF} \$239.99

- Navigation Lites
- Steering/ Controls
- Hardware/ Fasteners
- Covers/ Windshield
- Pumps/ Int. Lite
- Electric/ Battery
- Trolling Motor
- Gauges
- Electronics/ Radios
- Fuel
- Lube/ Motor Care
- Aux. Brkts/ Tilt/Trim
- Spark Plug/ Starters
- Props
- Seats/ Pedestals
- Anchors/ Rod Holder
- Winches/ Jacks
- Lites/ Tie Downs
- Tires/ Couplers
- Boat Care
- Misc./ Flooring
- Ski's/Tubes
- Floatation
- Ladders
- Water Front
- Fenders/ Dock Lines

Navigation Lites
Steering/ Controls
Hardware/ Fasteners
Covers/ Windshield
Pumps/ Int. Lite



10" Vented Rotor Brake Installation Kit

Complete kit to replace or upgrade from drum brakes to trailer disc brakes. 66/800 Disc brake actuator features cast ball clamp, Drop N Go auto coupler latch, oversized master cylinder, back flow style solenoid installed. Includes vented rotor disc brakes, disc brake actuator, brake line kit, brake hoses, brass fittings and attachment hardware. Fits 13", 14", 15" wheels.



Mfg #	Description	Order No.	Retail
82405	Disc Brake Kit	62623 _{TF}	\$669.99

Electric/ Battery
Trolling Motor
Gauges
Electronics/ Radios
Fuel
Lube/ Motor Care



D/L couplers are die formed. They are easily and quickly unlocked by a trigger action release.

Mfg #	Description	Order No.	Retail
970P	1-7/8" Class I coupler 3" housing (bulk)	17413	\$16.49
980P	2" Class II coupler 3" housing (bulk)	17417	23.99
6256-1	1-7/8" Coupler repair kit	17420	\$19.99
6257-1	2" Coupler repair kit	17424	26.99
303011	Coupler safety pin and chain	17615	1.99

Aux. Brkts/ Tilt/Trim
Spark Plug/ Starters
Props
Seats/ Pedestals
Anchors/ Rod Holder



Fas-Lok Straight Tongue Couplers - Zinc Plated

Mfg #	Description	Order No.	Retail
11200	1-7/8" Class I coupler, 2" housing - 2,000 lb cap.	22671	\$23.99
22200	2" Class II coupler, 2" housing - 3,500 lb cap.	22675	26.99
22300	2" Class II coupler, 3" housing - 3,500 lb cap.	22676	26.99

Winches/ Jacks
Lites/ Tie Downs
Tires/ Couplers
Boat Care



2" Coupler Kit

- "A Little Overpriced but kinda cute don't you think"
- 3x3" or 3x4" tongue
- Holes are down 3/4"



Mfg #	Description	Order No.	Retail
074-008-00	2" Coupler	63446 _{TF}	\$54.49

Misc./ Flooring
Ski's/Tubes
Floatation
Ladders
Water Front
Fenders/ Dock Lines



Bolt-On Fold Away Tongue Kit - The Fold-Away couplers provide space saving alternatives for easy storage. The cast hinge design offers strength coupled with a sleek appearance. Rated at SAE Class II (3500#) for 2" ball size.

Mfg #	Description	Order No.	Retail
HDPB 33	3" x 3" - Hinge kit only	22682 _T	\$114.99
HDPB 34	3" x 4" - Hinge kit only	22683 _T	129.99
500334	Pin & clip for 3" hinge kit	22685	\$18.49
500335	Pin & clip for 4" hinge kit	22686	18.99



Mfg #	Description	Order No.	Retail
290-031981	Pin & clip 5/8" x 5"	07793	\$12.59
290-031982	Pin & clip 5/8" x 6"	07794	13.89
290-002650	Hog ring	07785	1.39
PB0725	Reverse lockout key	07792	5.49



Coupler Safety Pin
1/4" dia. steel shaft pin,
1-1/2" clearance.

Mfg #59400	Square Clip	Order No. 05370	\$2.99
Mfg #59401	Round Clip	Order No. 05371	\$2.99



Coupler Safety Pin
Electrogalvanized Steel

Mfg #751010	1/4" Pin	Order No. 53690	\$3.69
Mfg #751011	5/16" Pin	Order No. 53692	\$3.99



Coupler Locking Pin
Fits 2" & 3" couplers. Bar fits through coupler release handle to provide security and safety. Zinc plated steel.

Mfg #11029-6	Order No. 09279	\$5.19
--------------	------------------------	--------



7/8" Span Coupler Lock

Mfg #1475DAT	Order No. 37942	THF \$17.49
--------------	------------------------	-------------



3-1/2" Span Coupler Lock
Fits: Atwood & Unique Functional

Mfg #1471DAT	Order No. 37935	THF \$17.49
--------------	------------------------	-------------



Specialty Coupler Lock
Fits Atwood and Dico brake actuators

Mfg #7LJ	Order No. 37909	THF \$11.99
----------	------------------------	-------------



Coupler Lock - 1 Piece
For maintenance free trailer security. Solid brass with rust-proof stainless steel shackle pin. 1/4" diameter shackle.

Mfg #12044-6	Order No. 06894	THF \$19.99
--------------	------------------------	-------------



Armorlock
• Fits openings 9/32" or larger in diameter.

Mfg #37DAT	Order No. 37903	THF \$16.49
------------	------------------------	-------------



Coupler Lock
• 7/8" long shackle
• Hardened steel

Mfg #2878DAT	Order No. 37933	THF \$8.99
--------------	------------------------	------------



Coupler Lock
• Nickel-plated, zinc die-cast body
• Front access key-way
• Ratcheting shaft
• Fits 1-7/8" and 2" couplers.

Mfg #379DAT	Order No. 37922	THF \$31.49
-------------	------------------------	-------------

Navigation Lites
Steering/Controls
Hardware/Fasteners
Covers/Windshield
Pumps/Int. Lite
Electric/Battery
Trolling Motor
Gauges
Electronics/Radios
Fuel
Lube/Motor Care
Aux. Brkts/Tilt/Trim
Spark Plug/Starters
Props
Seats/Pedestals
Anchors/Rod Holder
Winches/Jacks
Lites/Tie Downs
Tires/Couplers
Boat Care
Misc./Flooring
Ski's/Tubes
Floatation
Ladders
Water Front
Fenders/Dock Lines

Navigation Lites
 Steering/ Controls
 Hardware/ Fasteners
 Covers/ Windshield
 Pumps/ Int. Lite
 Electric/ Battery
 Trolling Motor
 Gauges
 Electronics/ Radios
 Fuel
 Lube/ Motor Care
 Aux. Brkts/ Tilt/Trim
 Spark Plug/ Starters
 Props
 Seats/ Pedestals
 Anchors/ Rod Holder
 Winches/ Jacks
 Lites/ Tie Downs
Tires/ Couplers
 Boat Care
 Misc./ Flooring
 Ski's/Tubes
 Floatation
 Ladders
 Water Front
 Fenders/ Dock Lines

Master Lock 



Coupler Latch Lock

- Stainless steel
- Coupler locks from 9/16" to 2-3/4"

Mfg #2847DAT
Order No. 37930_{THF} \$10.49

Master Lock 



Receiver Lock & Coupler Latch Lock

- Fits 1/2" & 5/8" receivers
- Coupler locks from 9/16" to 2-3/4"

Mfg #2848DAT
Order No. 37931_{THF} \$25.99

Master Lock 



Receiver Lock

- Stainless Steel Barbell™ lock
- Fits 5/8" receiver openings
- Push to Lock™ locking mechanism
- Class III/IV; 10,000lb. Load rating

Mfg #1480DAT
Order No. 37939_{THF} \$26.99

FULTON 



Receiver Lock

Helps prevent theft. Easy to use quick lock mechanism. Fits 2" and 2½" receivers. Plated steel hitch pin.

Mfg #63223 5/8" Pin
Order No. 22749 \$14.99

Master Lock 



Receiver Lock

- Fits both 1/2" & 5/8" receivers
- Water tight cap protects lock from moisture and dirt

Mfg #2866DAT
Order No. 37929_{THF} \$18.49

Master Lock 



Extended Length Receiver Lock

- Fits 5/8" receivers
- Usable length is 3-1/2"
- Swivel head
- Push to lock

Mfg #1469DAT
Order No. 37936_{THF} \$28.99

Master Lock 



Receiver Lock

- Removable cable
- 2-3/4" receiver pin
- Fits 1/2" & 5/8" receivers

Mfg #1470DAT
Order No. 37934_{THF} \$28.49

Master Lock 



Locking Cable

- 6' cable
- 100% steel braid
- Vinyl sleeve

Mfg #8428DPS
Order No. 37944_{THF} \$31.99

Master Lock 

Receiver Hitch Pin
• Chrome Plated



Mfg #	Description	Order No.	Retail
1492DAT	1/2" Pin	37924 ^{THF}	\$5.49
1495DAT	5/8" Pin	37927 ^{THF}	4.99

Master Lock 

5/8" Hitch Pin with Clip



Mfg #	Description	Order No.	Retail
371DAT	5/8" Pin w/Clip	37918	\$3.99
OP75106	Spare Clip	53694	1.29

Master Lock 

SST Receiver Hitch Pin
5/8" Stainless Steel
"Pivot Lock".
Pull and turn end to lock
or release hitch pin.



Mfg #1465DAT	Order No. 37926^{THF}	\$9.99
--------------	--------------------------------------	--------

TRAC

Boat and Trailer Dolly
• Heavy duty construction
• Large, pneumatic rubber tires
• Works in spaces vehicles can't go
• 700lb. Max • 1-7/8" ball



Mfg #T10046	Order No. 58042^T	\$149.99
-------------	------------------------------------	----------

DRAW-TITE

Reducer Bushing
Reduces ball mount hole
size from 1" to 3/4".



Mfg #80100	Order No. 27790	\$7.49
------------	------------------------	--------

CURT Manufacturing
www.curtmfg.com

Reversible Ball Mount
• 1-7/8" ball on one side
• 2" ball on the reverse side
• Powder Coated



Mfg #D45643	Order No. 13453^T	\$66.99
-------------	------------------------------------	---------

DRAW-TITE

Easy Load Ball Mounts
Featuring a revolutionary tapered shank
design, easy to load ball mounts provide
an easy connection to the receiver. Black
powder coat finish over e-coat.





Mfg #	Description	Order No.	Retail
36051	1-1/4" Square, 1-1/4" Drop, 3500 GTW	22778	\$36.99
40342	2" Square, 2" Drop, 7500 GTW	22780	19.99
40344	2" Square, 4" Drop, 7500 GTW	22782	23.99
40346	2" Square, 6" Drop, 6000 GTW	22784	29.99

DRAW-TITE

Class III Standard Towing Starter Kit
• Includes pin and clip • Black powder coat over e-coat
• 6000 GTW Rating



Mfg #	Description	Order No.	Retail
40583-002	2" Square, 2" Drop, 2" Ball	 22786	\$30.99
40644-002	2" Square, 4" Drop, 2" Ball	 22788	32.99

Navigation Lites
Steering/ Controls
Hardware/ Fasteners
Covers/ Windshield
Pumps/ Int. Lite
Electric/ Battery
Trolling Motor
Gauges
Electronics/ Radios
Fuel
Lube/ Motor Care
Aux. Brkts/ Tilt/Trim
Spark Plug/ Starters
Props
Seats/ Pedestals
Anchors/ Rod Holder
Winches/ Jacks
Lites/ Tie Downs
Tires/ Couplers
Boat Care
Misc./ Flooring
Ski's/Tubes
Floatation
Ladders
Water Front
Fenders/ Dock Lines

Navigation
Lites
Steering/
Controls
Hardware/
Fasteners
Covers/
Windshield
Pumps/
Int. Lite
Electric/
Battery
Trolling
Motor
Gauges
Electronics/
Radios
Fuel
Lube/
Motor Care
Aux. Brkts/
Tilt/Trim
Spark Plug/
Starters
Props
Seats/
Pedestals
Anchors/
Rod Holder
Winches/
Jacks
Lites/
Tie Downs
Tires/
Couplers
Boat
Care
Misc./
Flooring
Ski's/Tubes
Floatation
Ladders
Water
Front
Fenders/
Dock Lines



Hitch Ball - Chrome

- Solid steel hitch balls manufactured to meet all Safety requirements of VESC regulation V-5
- Cold forged for superior strength

Description	Order No.	Retail
1-7/8" Ball, 3/4"x2-3/8" Shaft, 2000# Cap.	22770	\$14.99
1-7/8" Ball, 1"x2-1/8" Shaft, 2000# Cap.	22772	13.49
2" Ball, 1"x2-1/8" Shaft, 7500# Cap.	22774	13.99



Chrome Plated Trailer Balls

Clam Packaged

Machined from cold drawn steel bars.



Mfg #	Ball Size	Class	Description	Order No.	Retail
DL26314	1-7/8"	I	3/4" x 1-3/4" shank	17430	\$12.49
DL26318	2"	II	3/4" x 1-11/16" shank	17431	13.49
DL26302	2"	III	1" x 2" shank	17386	15.99
DL26306	2-5/16"	6000#	1" x 2" shank	17387	20.49

Tow Ready hitch ball systems accommodate towing multiple trailers with ease! Change solid-steel hitch ball sizes in seconds without any special tools.

Interchangeable Hitch Ball Sets



Mfg. #	Description	Order No.	Retail
63801	1-7/8" & 2" set - 3/4" shank	22620T	\$49.99
63802	1-7/8" & 2" set - 1" shank	22622T	52.99
63803	1-7/8", 2", 2-5/16" set - 1" shank	22624T	72.99
63804	2" & 2-5/16" set - 1" shank	22626T	58.99
63805	1-7/8" Replacement ball	22628T	\$15.49
63806	2" Replacement ball	22630T	20.49
63807	2-5/16" Replacement ball	22632T	19.99
63808	3/4" Replacement shank	22634T	38.99
63809	1" Replacement shank	22636T	39.99

**CONVERT-A-BALL™
HITCH SYSTEM PRODUCTS**

Convert-A-Ball is your answer to multi-need trailer connections. No more wrenches, no more busted knuckles.

Mfg. #	Description	Order No.	Retail
944-300	1-7/8" Replacement ball	15180T	\$14.49
944-400	2" Replacement ball	15183T	16.49
944-600	2-5/16" Replacement ball	15186T	20.99
944-005	Vinyl shank cover	15210T	1.49

