

Activation of Peroxidic Oxygen

by John Tin Wing Man

A thesis presented in
partial fulfilment of the requirements for the
Doctor of Philosophy Degree
of the University of London

Department of Chemistry,
University College.

Submitted August 1993

ProQuest Number: 10045765

All rights reserved

INFORMATION TO ALL USERS

The quality of this reproduction is dependent upon the quality of the copy submitted.

In the unlikely event that the author did not send a complete manuscript and there are missing pages, these will be noted. Also, if material had to be removed, a note will indicate the deletion.

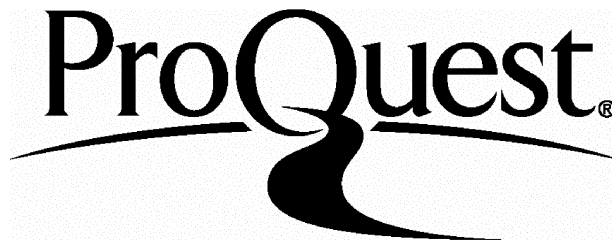

ProQuest 10045765

Published by ProQuest LLC(2016). Copyright of the Dissertation is held by the Author.

All rights reserved.

This work is protected against unauthorized copying under Title 17, United States Code.
Microform Edition © ProQuest LLC.

ProQuest LLC
789 East Eisenhower Parkway
P.O. Box 1346
Ann Arbor, MI 48106-1346

Abstract

Hydroperoxides are convenient rather mild oxidising agents. The aim of this work was to examine new ways of enhancing their oxidising power to provide the basis for a new peroxide-based oxidation system for application in industrial processes and an approach to a new low-temperature household bleaching system.

The reactivity of alkyl hydroperoxides has been previously shown to be enhanced by geminal alkylation to give dialkyl peroxonium ions.

This work examines the reaction of the cyclic bromohydroperoxides 5-bromocycloocten-1-yl hydroperoxide, 6-bromocycloocten-1-yl hydroperoxide and 5-bromocyclohepten-1-yl hydroperoxide with silver trifluoroacetate to form dialkyl peroxonium ions. These hydroperoxides were readily prepared from their parent alkenes by singlet oxygenation. Formation of the expected bicyclic ethers from these hydroperoxides with concomitant oxidation of phenyl methyl sulphoxide provides evidence for the intermediacy of the dialkyl peroxonium ion in these cases.

The synthesis of ortho halomethyl benzyl hydroperoxides by homolytic and heterolytic methods was examined the aim here was the preparation of an ortho halomethyl substituted cumene hydroperoxide. This work led to a synthesis of the hydroperoxide 2-bromomethyl alpha methoxy benzyl hydroperoxide by ozonolysis. The reaction of this hydroperoxide with silver salts was examined.

We presumed that the principles relied upon to activate hydroperoxides could be further extended to the activation of a peroxyacid by preparation of precursors capable of forming an acyl alkyl peroxonium ion and ortho halomethyl substituted benzoic acids and their related peresters were prepared. The results of this study suggest that intramolecular ring closure to form an acyl alkyl peroxonium ion is a disfavoured process compared to intermolecular substitution in this type of system.

There is, of course, no logical way leading to the establishment of a theory, but only groping, constructive attempts controlled by careful considerations of factual knowledge.

A. Einstein

Contents

	Page
<u>Chapter 1 Introduction</u>	13
1.1 Biological & Industrial Importance of Oxygen	13
1.2 Metal Based Activation	16
1.3 Alteration of leaving group	18
1.4 Alteration of hydrogen bonding in the transition state	22
1.5 Dialkylperoxonium Ions & Related Species	24
1.5.1 Vicinal Peroxonium Ions	24
1.5.2 Dioxygen Ylids & Related Species	26
1.5.3 Dioxiranes	28
1.5.4 Gem Dialkylperoxonium Ions	29
1.6 Activation of Metal Persalts	33
1.7 Overview of proposed research	37
<u>Chapter 2 Dialkylperoxonium ions</u>	38
2.1 Preparation of the hydroperoxide precursors	38
2.2 - 2.4 Results & Discussion	44
2.2 Characterisation of the hydroperoxides	47
2.2.1 Spectroscopy	
2.2.2 Preparation of derivatives and authentic materials	58
2.2.2.1 Alcohol ketone and triphenylmethanol derivatives	58
2.2.2.2 Bicyclic ether synthesis	60

2.3 Reactions of the hydroperoxides	64
2.3.1 Hydroperoxides with silver salt and no oxidisable substrate	64
2.3.2 Hydroperoxides with silver salt and sulphoxide	65
2.3.3 The difference in the apparent efficiency of the dialkyl peroxonium ions	67
2.3.4 Enhancement of oxygen transfer ability of hydroperoxides by protonation	68
2.4 Summary	69
2.5 Experimental	71
Chapter 3 <u>Ortho halomethyl benzyl hydroperoxides</u>	95
3.1 Introduction	95
3.2 - 3.4 Results & Discussion	96
3.2 Synthesis & Reaction of 2-isopropyl benzoic acid	96
3.3 Heterolytic methods	99
3.4 Ozonolysis	104
3.5 Experimental	108

Chapter 4	The preparation of ortho halomethyl peroxyacids	118
4.1 Introduction		118
4.2 - 4.6 Results & Discussion		120
4.2 Overview of peroxyacid preparation		120
4.2.1 Direct peroxidation		120
4.2.2 Exchange reactions		121
4.2.3 Perhydrolysis		121
4.2.3.1 Perhydrolysis of acyl halides		121
4.2.3.2 Alkaline alcoholysis of diaroyl peroxide		123
4.2.3.3 Imidazolides		124
4.3 The potential problem with ortho halomethyl peroxybenzoic acids		126
4.4. Autoxidation of aldehydes		127
4.5 Hemiacetalised hydrogen peroxide		131
4.6 t-butyl perester preparation		131
4.7 Summary		132
4.8 Experimental		135

	Page
<u>Chapter 5</u> <u>Reactions of <i>ortho</i> halomethyl peroxy acids and related compounds</u>	144
5.1 - 5.5 Results & Discussion	144
5.1 Reactions of the <i>t</i> -butyl peresters	144
5.2 Peroxyacid evaluation: wash tests	146
5.3 Peroxyacid evaluation: chemical substrates	147
5.4 Reactions with alkenes	148
5.5 The reactions of <i>ortho</i> hydroxymethyl bezenemethylamine	151
5.6 Conclusions	152
5.7 Experimental	153
<u>References</u>	160

Acknowledgements

Special thanks to Dr John Bloodworth and Professor Alwyn Davies for their ideas, advice and encouragement and their painstaking proofreading, Dr Neil Mortimer of British Petroleum for a reverse phase HPLC separation and Mr Steve Corker for other HPLC work and general HPLC advice. Thanks also to Dr P. K. G. Hodgson my industrial supervisor. For a CASE award I thank the Science & Engineering Research Council and British Petroleum. I am grateful to Professor David Crich for experimental advice on thiohydroxamate chemistry and Drs Hale and Garratt for the Friday synthetic sessions. I thank the present and past members of the Bloodworth group in particular Aneela and Neil. I thank Claude for helping me through the 'late shift'. Finally I give thanks to my parents for helping me through the difficult times over the past three years, it is to them that I dedicate this thesis.

STANDARD LIST OF ABBREVIATIONS

bp	boiling point
br	broad (spectral)
°C	degrees Celsius
calcd	calculated
δ	chemical shift in parts per million downfield from tetramethylsilane
DCC	N,N-dicyclohexylcarbodiimide
DMAP	4-(dimethylamino)pyridine
DMF	dimethylformamide
DMS	dimethyl sulphide
DMSO	dimethyl sulphoxide
EI	electron impact (in mass spectrometry)
FAB	fast atom bombardment (in mass spectrometry)
g	gram(s)
h	hour(s)
HPLC	high-performance liquid chromatography
Hz	Hertz
IR	infrared
J	coupling constant (in NMR)
L	litre(s)
m	multiplet (spectral), metre(s), milli
mCPBA	m-chloroperoxybenzoic acid
m/e	mass to charge ratio (in mass spectrometry)
MHz	megahertz
min	minute(s)
mol	mole(s)
NBS	N-bromosuccinimide
NCS	N-chlorosuccinimide
NMR	nuclear magnetic resonance
Nu	nucleophile
PCC	pyridinium chlorochromate
MMPP	magnesium monoperoxyphthalate
ot	oven temperature (Kugelrohr distillation)
ppm	parts per million (in NMR)
q	quartet (spectral)
R _f	retention factor (in chromatography)

r.p.m.	revolutions per minute
s	singlet (NMR); second(s)
SFORD	single frequency off resonance decoupling
SN1	unimolecular nucleophilic substitution
SN2	bimolecular nucleophilic substitution
t	triplet (spectra)
TBHP	tert-butyl hydroperoxide
TFA	trifluoroacetic acid
THF	tetrahydrofuran
TLC	thin layer chromatography
TMS	tetramethylsilane
Tr	trimethylphenyl (trityl)
Ts	tosyl, p-toluenesulphonyl
TS	transition state
tR	retention time
TAED	N,N,N,N-tetraacetyl ethylene diamine
TACu	Tetraacetylglucuril

1 Introduction

1.1 Biological & industrial importance of oxygen

Molecular oxygen, one of the most abundant elements on earth, has until now scarcely been used for the selective oxidation of organic substrates. The reason for this is that oxygen has a triplet ground state, whose direct interaction with singlet-state organic molecules is a spin-forbidden process. Oxygen-transfer reactions are, however, of importance in two areas.

In biochemistry, oxygenases effect monooxygenations, e.g. hydroxylations of hydrocarbons, epoxidations of olefins and arenes, and lactonisation of ketones, or dioxygenations. Since most oxygenases contain transition metals as their active centre, the last few years has seen considerable progress in the understanding of the interaction of dioxygen with transition metal complexes and many models have been found and discussed^{1,2}.

The second area is industry where there is a need for mild selective single step oxidations of hydrocarbons as a variety of products are prepared by oxidative routes.

Common oxidants used for hydroxylations such as the oxidation of arenes to phenols or alkenes to diols include molecular oxygen, osmium tetroxide, sodium periodate and sodium chlorite. Direct use of oxygen has only been possible in restricted cases such as the autoxidation of cumene to produce phenol **1** and acetone **2**.(Scheme 1.1)^{3,4}.

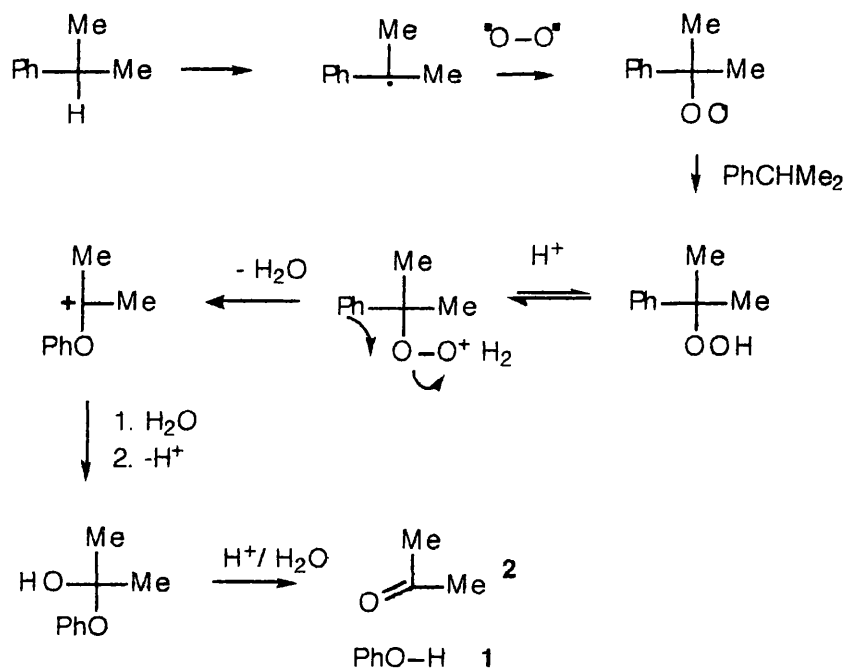

Scheme 1.1 Autoxidation of cumene

It would be highly desirable to be able to oxidise benzene to phenol directly in an efficient manner but this goal has so far eluded chemists. Direct use of oxygen is also possible in other cases. For example ethylene can be oxidised partially to ethylene oxide with silver catalysts^{5,6}.

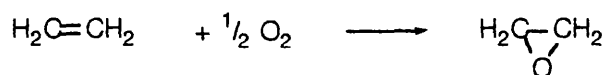

Scheme 1.2

Two side reactions exist which are even more exothermic

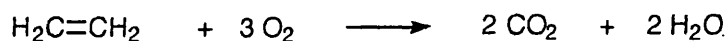

Scheme 1.3

and

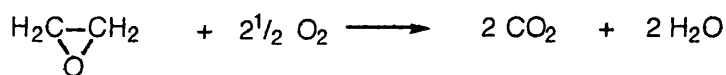

Scheme 1.4

A selectivity of 65-70% ethylene oxide has been achieved. In this case oxygen activation takes place on the metal surface of a silver based catalyst by adsorption of oxygen followed by reaction with ethylene. The catalytic silver

surface is then regenerated by reaction with more ethylene to produce carbon monoxide, carbon dioxide and water. (Scheme 1.5)

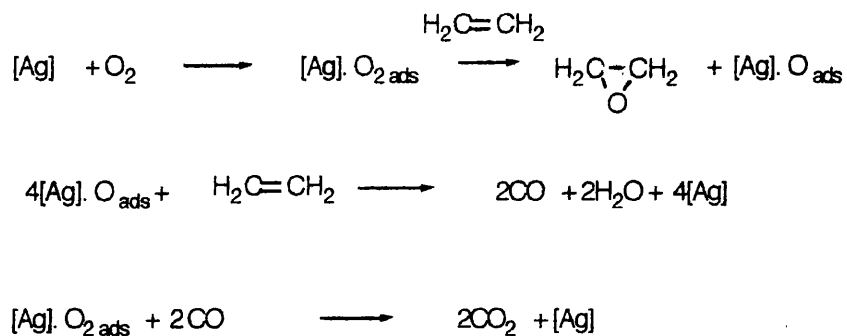

Scheme 1.5

In all ethylene oxide processes inhibitors are added to prevent overoxidation.

Another direct oxidation process is the production of acrolein from propene^{5,6}

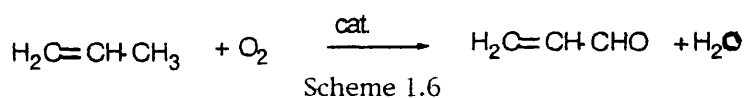

This is a catalysed gas phase oxidation based on Cu₂O or Cu and selectivity is 75-84% based on C₃H₆. The byproducts include acetaldehyde, and acrylic and acetic acids.

Another direct oxidation^{5,6} is that of butene to produce maleic anhydride/maleic acid

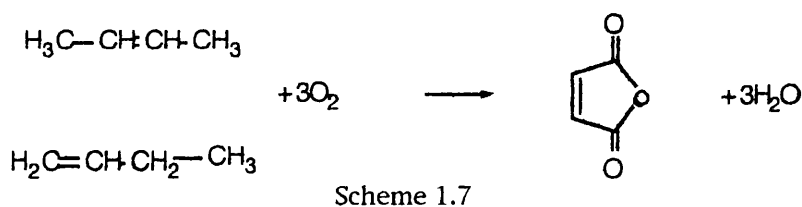

Typically vanadium or phosphoric oxide based catalysts modified with oxides of Ti, Mo or Sb are used. The oxidation takes place at 350-450 °C at 2-3 bar with a selectivity of only 50-60%. Byproducts of the reaction include CO, CO₂, acetic, acrylic, fumaric and glyoxylic acids as well as formaldehyde. The commercial attractiveness of the process depends on the relative cheapness of C₄ feedstocks to aromatic fractions.

In each of these cases the process is viable because there is only one reaction pathway (or one favoured pathway).

An easy and cheap way to activate molecular oxygen is to transform it into organic or inorganic reactive peroxides. One method of increasing reactivity has been to employ a different oxidising reagent to that conventionally used for example the replacement of air or oxygen by hydrogen peroxide. Because hydrogen peroxide is usually not electrophilic enough to oxidise organic compounds on its own, one approach has been its fixation to a transition metal carrier making oxygen transfer to a coordinated organic substrate possible. One reason for the use of peroxide reagents is the hope that these reagents will improve the selectivity of oxidation processes.

1.2 Metal based activation

Direct epoxidation of an alkene is typically accomplished by using a combination of an organic peroxide and a metal catalyst. In this regard the high valent d₀ transition metals have had particular utility. The acidic oxides MoO₃ and WO₃ and compounds of selenium, arsenic and boron are thought to act either by the production of inorganic peroxo acids, such as peroxoselenic acid **3**^{7,8} or a heterodioxirane type species **4**⁹ (Schemes 1.8-1.10)

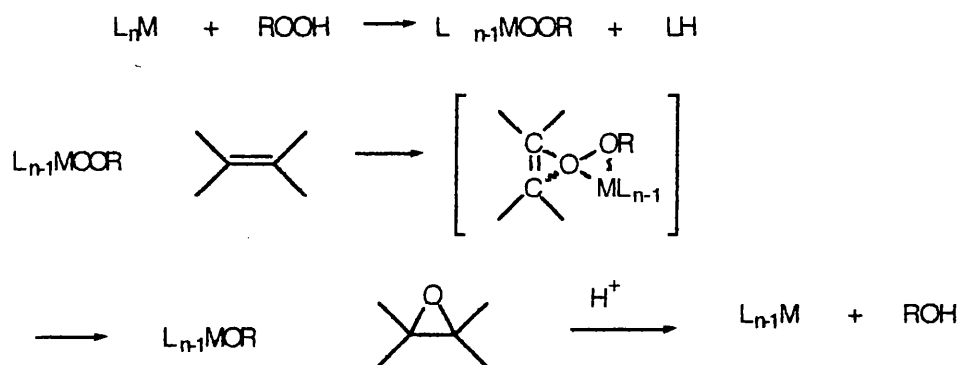

Scheme 1.8 Metal catalysed epoxidation with alkyl hydroperoxides

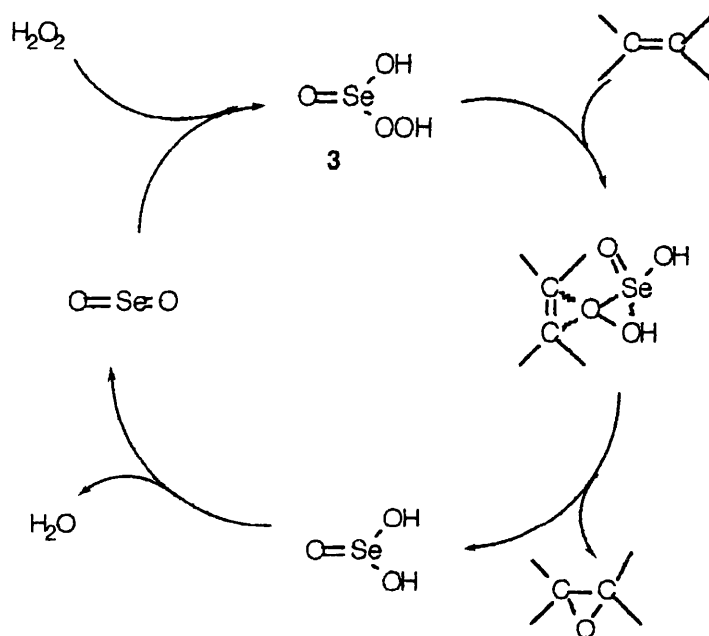

Scheme 1.9 Selenium dioxide catalysed epoxidation

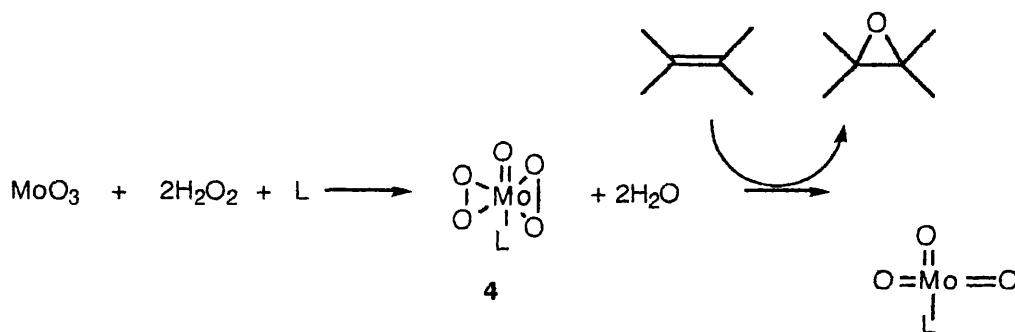

Scheme 1.10 Molybdenum catalysed epoxidation with hydrogen peroxide

Hydroxylation of arenes can be achieved either by free radical mechanisms such as autoxidation or non-radical electrophilic hydroxylations. Of the free radical reactions those using classical ferrous ion (Fenton) chemistry⁷ producing hydroxyl radical and ferric ion (Scheme 1.11) and those processes producing ferryl ion FeO_2^+ species have been particularly thoroughly studied. The classical Fenton type chemistry is rather poorly yielding in the required phenols and the competing biaryl compounds are formed along with other products¹⁰ (Scheme 1.12). There is also a requirement for large amounts of ferrous ion (typically in quantities much greater than stoichiometric). This last problem has, however, been overcome. Tagamaki¹¹ has employed Fenton type chemistry in the hydroxylation of benzene. With Fe^{3+} and hydrogen peroxide, with quinone as a cocatalyst, the reaction is catalytic in iron. The mechanism is thought to be similar to that of conventional Fenton chemistry. The quinone reducing agent is

thought to transform the oxidised iron species back to its reduced form. An alternative method of generating HO^\bullet has been developed by Richter¹² using the free radical chain decomposition of hydrogen peroxide with 5-methyl phenazinium ion.

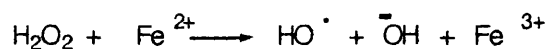

Scheme 1.11 Fenton reagent

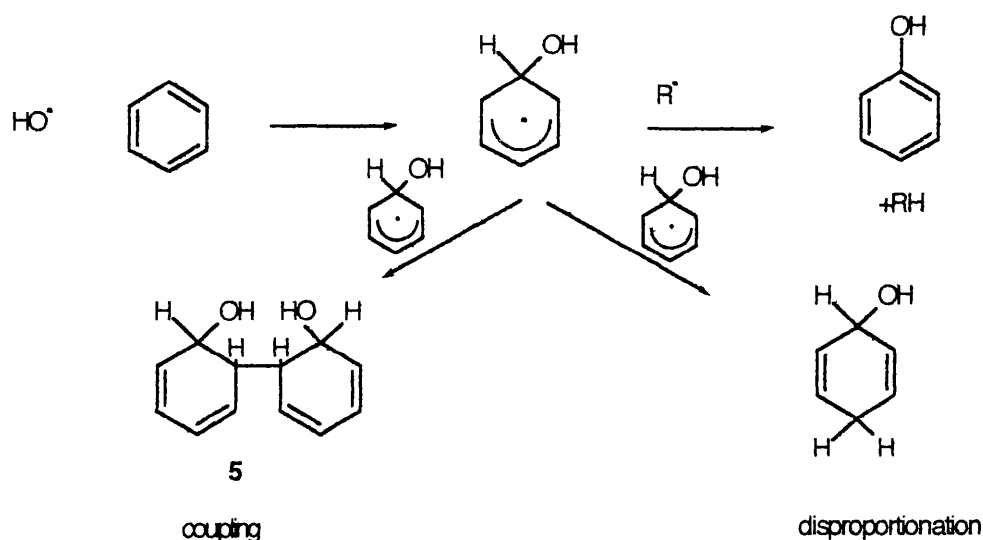

Scheme 1.12 Phenol and byproduct formation in the use of Fenton based reagents

1.3 Alteration of the leaving group

The use of electrophilic aromatic substitution reactions such as nitration, halogenation and alkylation dates back to the last century, however the concept of electrophilic aromatic hydroxylation is a relatively recent idea. The necessary electrophile would presumably be the hydroxyl cation (hydroxonium ion) or its equivalent and this might be expected to behave in a similar fashion to NO_2^+ in nitration or R^+ in alkylation. Hydrogen peroxide would appear to be the logical precursor to OH^+ as protonation of hydrogen peroxide followed by heterolytic cleavage will yield the desired electrophile.

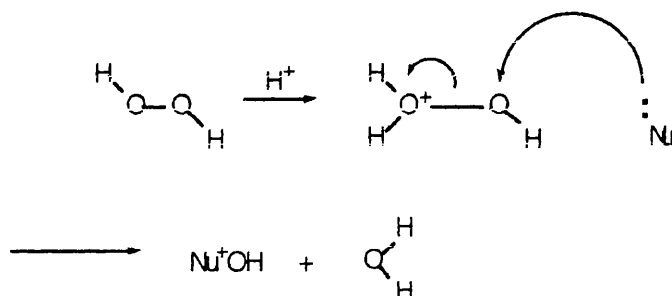

Scheme 1.13 Protonation of hydrogen peroxide followed by heterolytic cleavage yields "OH⁺" capable of nucleophilic oxidation.

Hydrogen peroxide is calculated to be 1% protonated in 10 molar acid. Derbyshire and Waters¹³ have treated mesitylene with a mixture of concentrated hydrogen peroxide in acetic and sulfuric acid to give mesitol in high yield. One problem that subsequent workers^{14,15} overcame by careful selection of substrates is the possible further reaction of the products produced in the oxidation. The products of an electrophilic aromatic hydroxylation are typically much more easily oxidised than the arenes from which they were derived.

This initial approach has centred on the activation of hydrogen peroxide itself. An alternative approach is to employ hydroperoxides. The reaction conditions required for epoxidations employing protonated hydroperoxides are typically much less drastic than those required for hydrogen peroxide itself. In this case the leaving group has also been improved. (Scheme 1.8)



Scheme 1.14 Nucleophilic oxidation by protonated hydroperoxides

A logical progression employing both these concepts of improved leaving group and the use of hydrogen peroxide would be the use of a peracid in conjunction with hydrogen peroxide in an acid/peracid exchange reaction (Scheme 1.15). Employing such an equilibrium into a workable process has not yet been achieved because the equilibrium between acid and peracid is in most cases firmly in favour of the acid.

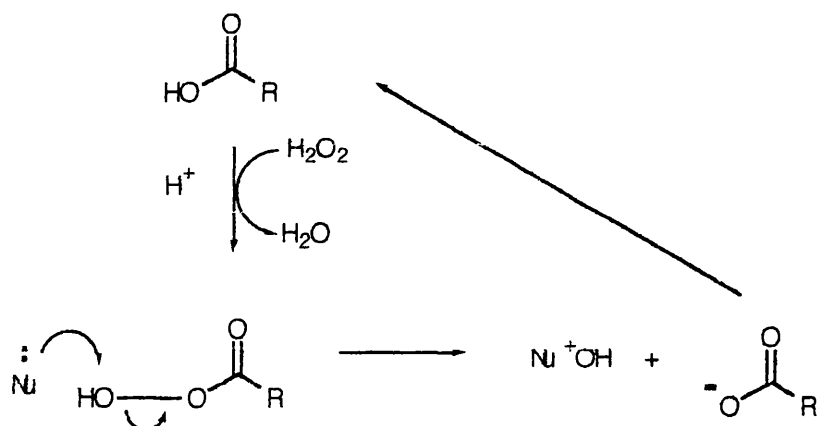

Scheme 1.15 Nucleophilic oxidation by peracids in a catalytic cycle

The factors involved in the reaction of peroxyacids with nucleophilic alkenes the so called Prilezhaev reaction have been extensively reviewed by Plesnicar¹⁶. The enhancement of reactivity of the peroxyacid is attributed to the acidity of the departing carboxylic acids $\text{pK}_a = 4 - 5$ which is greater than the pK_a of an alcohol; the leaving group with a protonated hydroperoxide^{17,18}. Two schools of thought exist on the exact reaction intermediate. The mechanism proposed by Bartlett involves nucleophilic attack of the olefin at the terminal electrophilic oxygen atom of the hydroperoxide group to form a butterfly transition state **6**. Subsequently this collapses to the epoxide and carboxylic acid. Evidence in support of the Bartlett mechanism has been proposed by Ogata and Tabushi¹⁹.

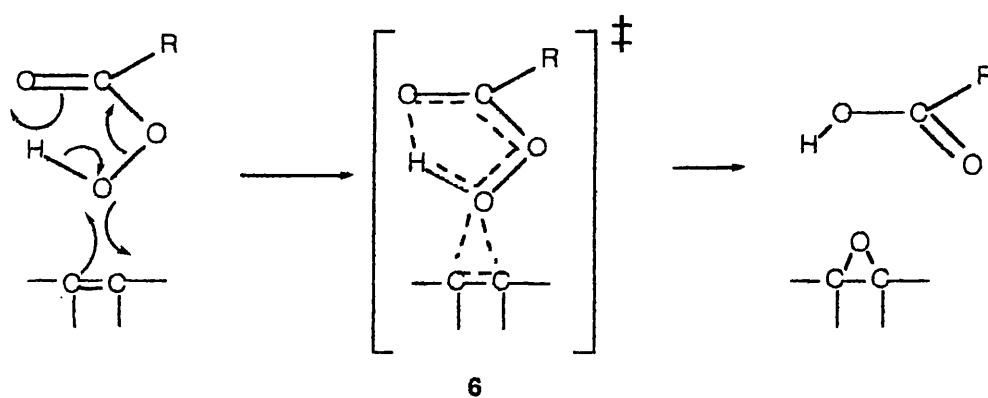

Scheme 1.16 Bartlett mechanism for olefin epoxidation by peracids

The Bartlett mechanism is preferred to the one proposed by Kwart²⁰. Kwart considers a peroxy acid as a hydroxy substituted dioxirane **7** (Scheme 1.17). Epoxidation with **7** involves a 1,3 dipolar cycloaddition of the peroxyacid in its zwitterionic form to the olefinic double bond to form cyclic peroxide **8** which can then decompose to the epoxide and carboxylic acid as before.

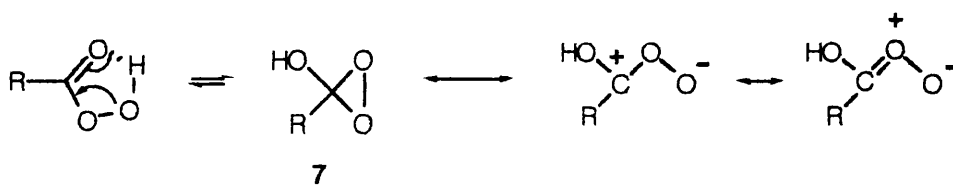

Scheme 1.17

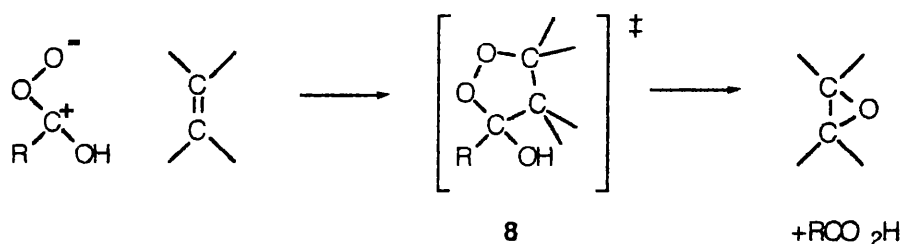

Scheme 1.18 Kwart's mechanism for the epoxidation of olefin by peracids

The main points in favour of the Bartlett mechanism are as follows. The epoxidation of alkenes has a particularly low steric requirement as evidenced by the epoxidation of highly hindered substrates or by use of highly hindered peracids²¹⁻²³ and using the endocyclic restriction test^{24,25} gives results that are only consistent with transition state **6**.

Although hydrogen peroxide is not itself sufficiently reactive to epoxidise a non conjugated double bond its reactivity can be markedly enhanced by placing the hydroperoxide moiety in conjugation with a polarised multiple bond. This principle is exemplified by structures **9** to **13**. In principle any species which can convert one of the hydroxyl groups of H₂O₂ into a good leaving group will generate a reactive epoxidising reagent.

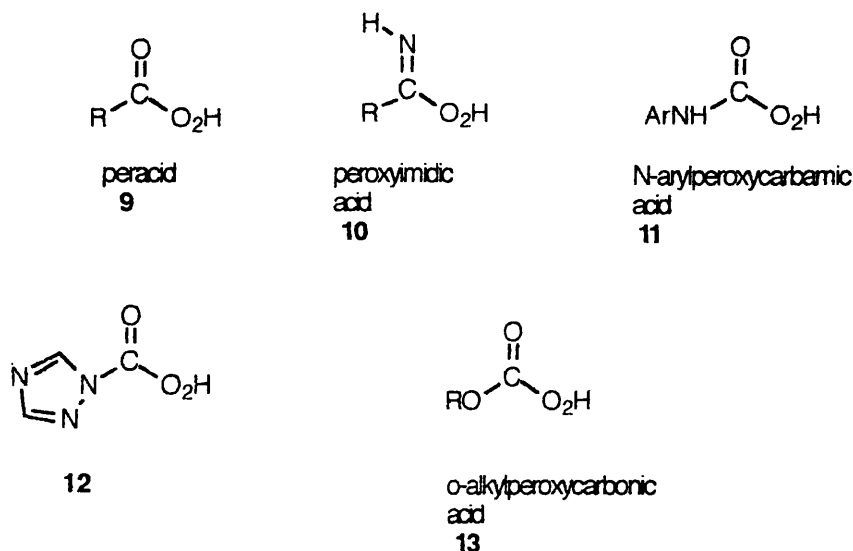

Scheme 1.19 Reactive epoxidising reagents.

The so called Payne reagent **10**²⁶ based on epoxidations with a nitrile and hydrogen peroxide has found widespread use, a particular advantage is the avoidance of acid conditions. The reactivity of the peroxyimidic acids is attributed to the formation of the stable amide carboxyl group.

More recently it has been shown that a trichloromethyl group enhances nitrile reactivity. The peroxyoxycarboximides show a similar reactivity profile to mCPBA or MMPP but are less chemoselective than these reagents²⁷.

1.4 Alteration of hydrogen bonding in the transition state.

A number of variants on the theme of altered hydrogen bonding in the peracid transition state have been disclosed. Alpha azohydroperoxides have been shown to have high reactivity in oxygen atom transfer reactions. A mechanism similar to that of the peroxyacids and heteroatom containing hydroperoxides has been proposed. Intramolecular transfer of the hydroperoxy proton to the azo functionality produces an acceleration of the epoxidation rate. The transition state **14** is proposed to account for these effects²⁸.

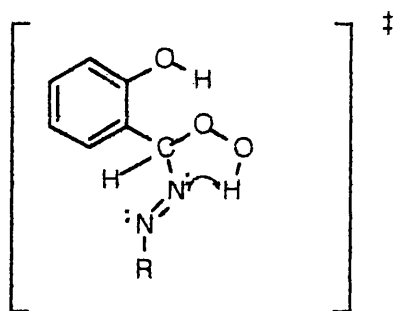

14

A difference in reactivity attributed to hydrogen bonding is also observed with compounds **15** and **16**. Compound **15** cannot epoxidise under conditions in which **16** gives high yields of epoxides. Given the similar reactivity of both reagents to oxygen nucleophiles they both should react readily with hydrogen peroxide. The explanation for enhanced reactivity of the triazole compound with hydrogen peroxide is that it may adopt a conformation in which the altered hydrogen bonding pattern shown exists. Transition state **18** rather than transition state **17** is proposed. It is suggested that carbon dioxide extrusion is more facile from **18** rather than **17**. This extrusion is similar to that predicted for

the epoxidation of compounds with compound **20**. It should be noted that N,N-carbonyl diimidazole is itself very reactive. Treatment of **15** with 90% hydrogen peroxide affords a species that can epoxidise an alkene at rates one hundred times faster than mCPBA^{21,29}.

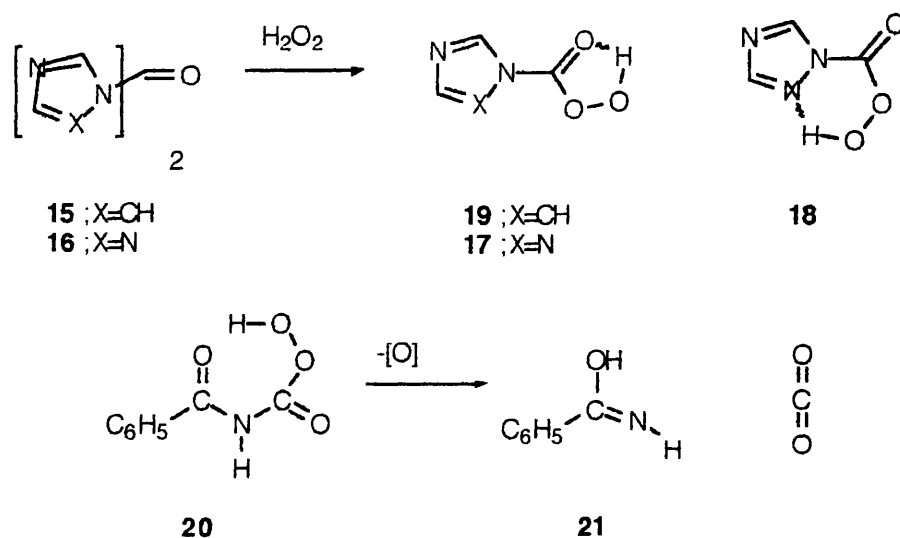

Scheme 1.20 Conformations of reactive epoxidising agents..

The hydrogen bonding pattern predicted in the carbodiimide and cyanate epoxidations is shown (Scheme 1.15). As in the peracids an intramolecular hydrogen bond exists and the remaining π bonding permits generation of a neutral substance after oxygen transfer.

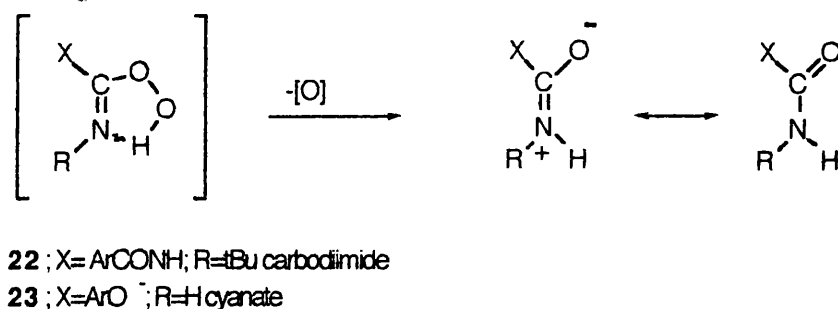

Scheme 1.21

Recently Rodriguez³⁰ has reported that Vilsmier reagent in conjunction with 30% hydrogen peroxide generates the extremely reactive hydroperoxymethylene compound **24**. This can either oxidise the hydrogen chloride formed during its preparation or can act as a powerful epoxidising reagent with the strongly electrophilic character of **24** and the driving force of DMF formation accounting for the reactivity of the species

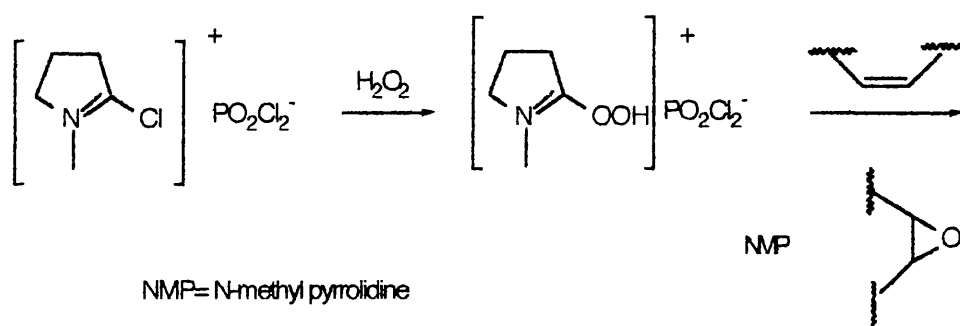
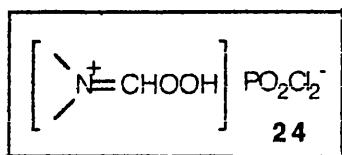

Scheme 1.22 Vilsmeier reagent and hydrogen peroxide

1.5 Dialkylperoxonium ions and related species

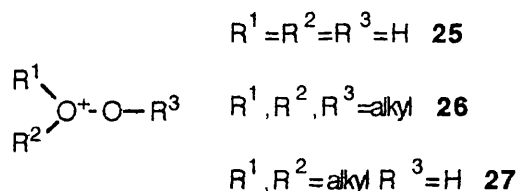

Scheme 1.23

The existence of protonated hydrogen peroxide in the form shown as structure **25** has been demonstrated by Olah et al. by ^{17}O NMR spectroscopy³¹. Protonated hydrogen peroxide is a powerful but unselective oxidising agent capable of oxidising benzene and cyclohexane at room temperature. It should be possible to design peroxides where two or all of the groups R1- R2 have been replaced by alkyl groups to prepare species of the type **26** and **27**. In theory it should be possible to attenuate or tune the activity of these species by variation of the R group to perform synthetically useful oxidations.

1.5.1 Vicinal dialkylperoxonium ions

Dialkylperoxonium ions can be obtained by alkylation of hydroperoxides. Alkylation can take place on the hydroxy oxygen of the hydroperoxide to

afford a vicinal peroxonium ion. This can deprotonate to give a dialkyl peroxide **28** (Scheme 1.23).

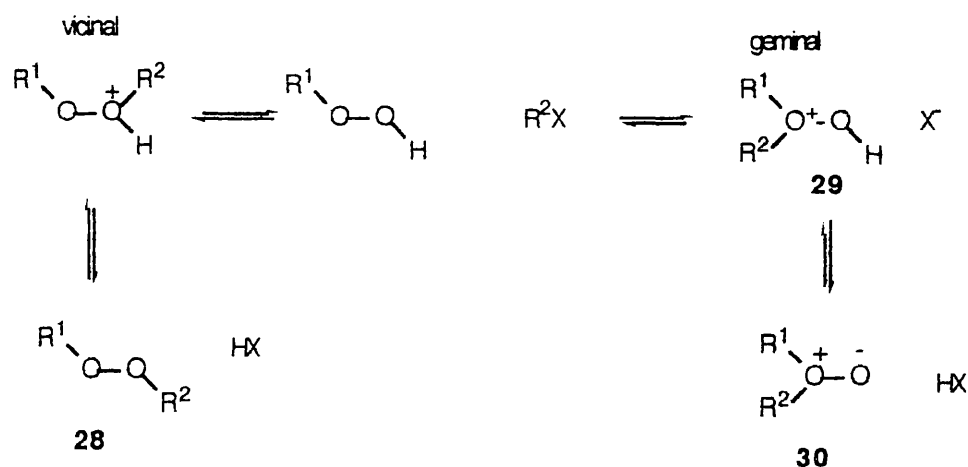

These alkylations are very common in the peroxide literature. An example of the vicinal alkylation using silver salt assisted intramolecular cyclisation of hydroperoxy bromides was demonstrated by Porter and Gilmore³² (Scheme 1.24). They described the reaction of the bromides **31** and **33** obtained from hydrogen peroxide and silver trifluoroacetate. For the two stereoisomeric bromohydroperoxides the course of reaction is dramatically different and suggests that the reaction occurs with via an intramolecular S_N2 type transition state with inversion of configuration at the carbon centre undergoing substitution. Hence the *cis* dibromide give the *trans* bromohydroperoxide **31** which is then converted to the endoperoxide **32**. The *trans* dibromide gives the *cis* bromohydroperoxide **33** which cannot be converted to **32** because of the backside displacement geometric requirement and hence the dihydroperoxide is formed.

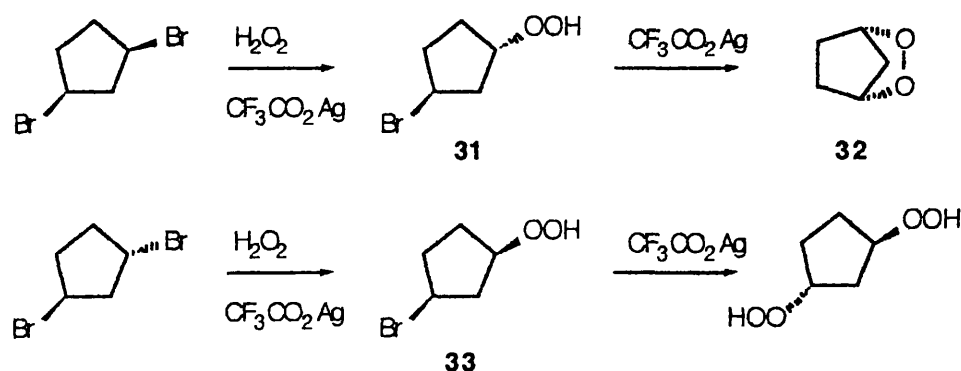

Adam³³ subsequently confirmed this course of events by taking the preformed bromohydroperoxides **31** and **33** and treating them with silver acetate to give the endoperoxide **32** and hydroperoxyacetate **34** (Scheme 1.25).

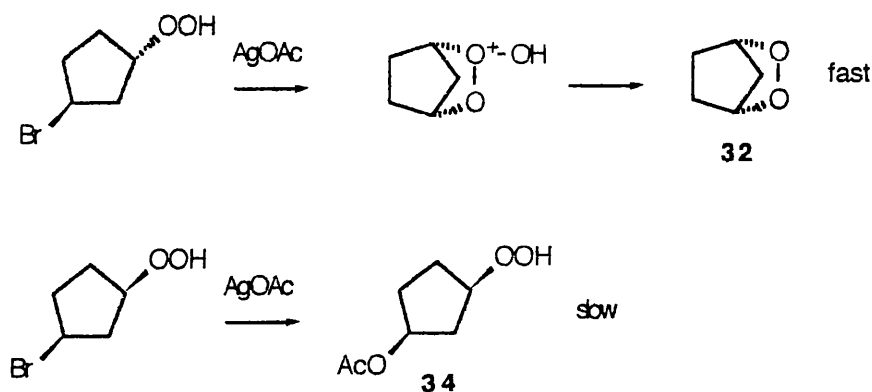

Scheme 1.25

1.5.2 Dioxygen ylids and related species

Until 1983 geminal alkylation to give the peroxonium ion **29** had not been reported. Examples of the deprotonated dioxygen ylid **30** are however well known. The perepoxide intermediate **35** is postulated in the singlet oxygenation of diadamantylidene. It was observed that this oxygenation afforded two products. Bartlett proposed that $^1\text{O}_2$ adds to form a perepoxide as the initial intermediate (dioxygen ylid **35**) and this can rearrange to give the expected dioxetane **37**. More unusually he reported that the epoxide **36** is also formed and he proposed that this is formed by the addition of a second equivalent of singlet oxygen to the perepoxide with loss of ozone. (Scheme 1.26)

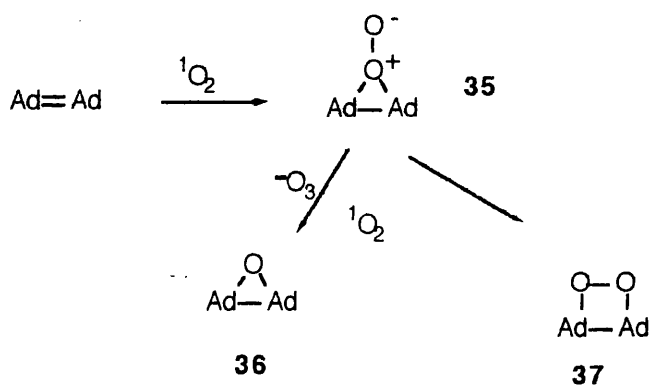

Scheme 1.26 Singlet oxygenation of diadamantylidene

The perepoxide mechanism for the addition of singlet oxygen to alkenes is not without controversy and at least two other viable reaction intermediates have been proposed, namely the biradical and the zwitterion³⁴⁻⁴³.

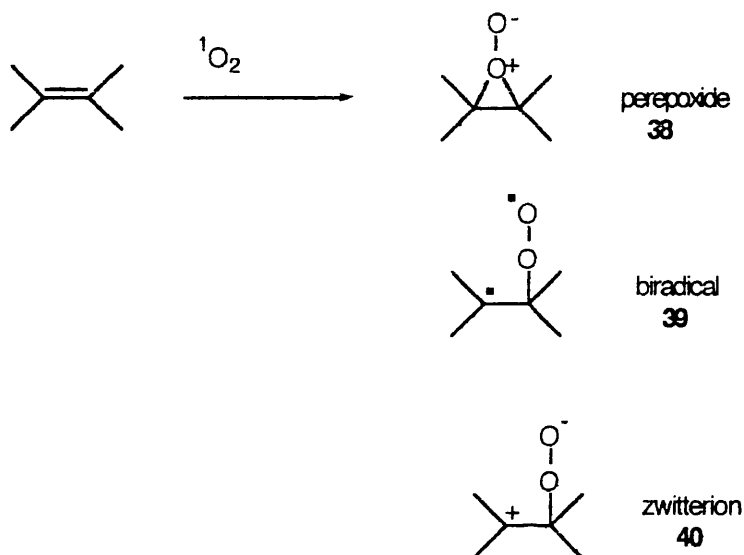

Scheme 1.27 Proposed intermediates in singlet oxygenation.

Estimates have been made of the energetics of the zwitterion **40**, biradical **39** and perepoxide **38** and seem to suggest that $^1\text{O}_2$ addition occurs in a *stepwise* fashion via the zwitterion or biradical rather than the perepoxide.

Kopecky⁴⁴ and others have examined the reactions of 1,2-bromohydroperoxides **41** and **42** with methanolic sodium hydroxide from which they obtained not dioxetane but products resulting from peroxy migration and elimination, **43** and **44**, suggesting that intermediate perepoxides collapsed to give the observed ene product (Scheme 1.28).

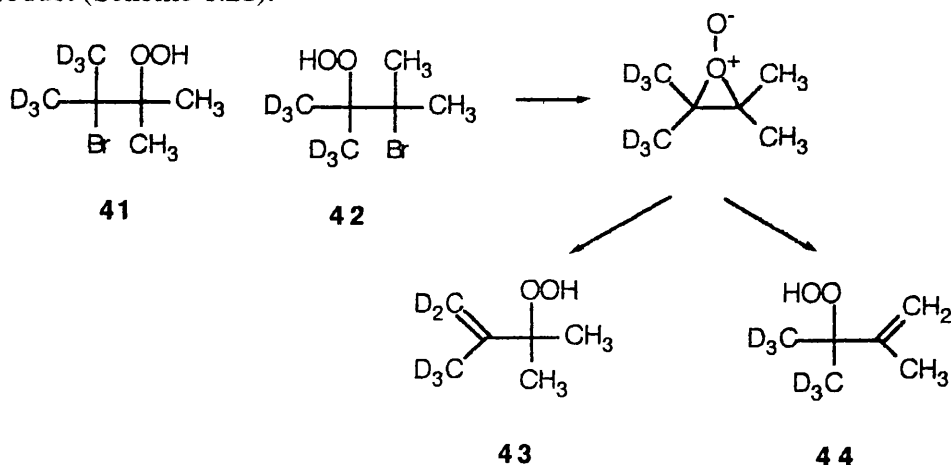

Scheme 1.28 Reactions of 1,2 bromohydroperoxides with methanolic sodium hydroxide

A species related to the peroxide is the carbonyl oxide. Carbonyl oxides **45** have been proposed as the intermediates in the ozonolysis of alkenes (Scheme 1.29). Ozone acting as a 1,3 dipole adds to the alkene dipolarophile in a $2\pi + 4\pi$ cycloaddition yielding the molozonide (primary ozonide) **46**. This then cleaves in a cycloreversion to give a stable carbonyl compound and the carbonyl oxide **45** which recombines with the internally generated carbonyl compound to give the final ozonide **47** in a second cycloaddition reaction.

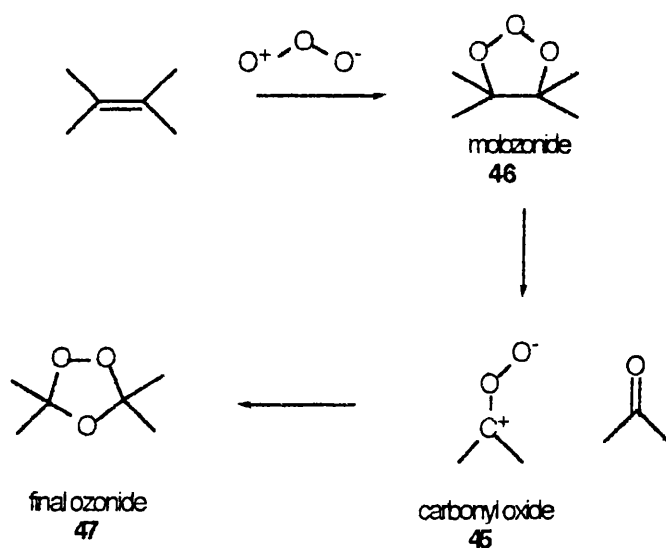

Scheme 1.29 Intermediates in the ozonolysis of alkenes.

1.5.3 Dioxiranes

Dioxirane, the other species isomeric with peroxide, is a powerful and versatile oxidant produced by the treatment of ketones with Caroate. It has been subsequently isolated in ketone solutions. The reactivity of this species has been extensively reviewed and it has been shown to be an extremely versatile oxidant⁴⁵ (Scheme 1.24).

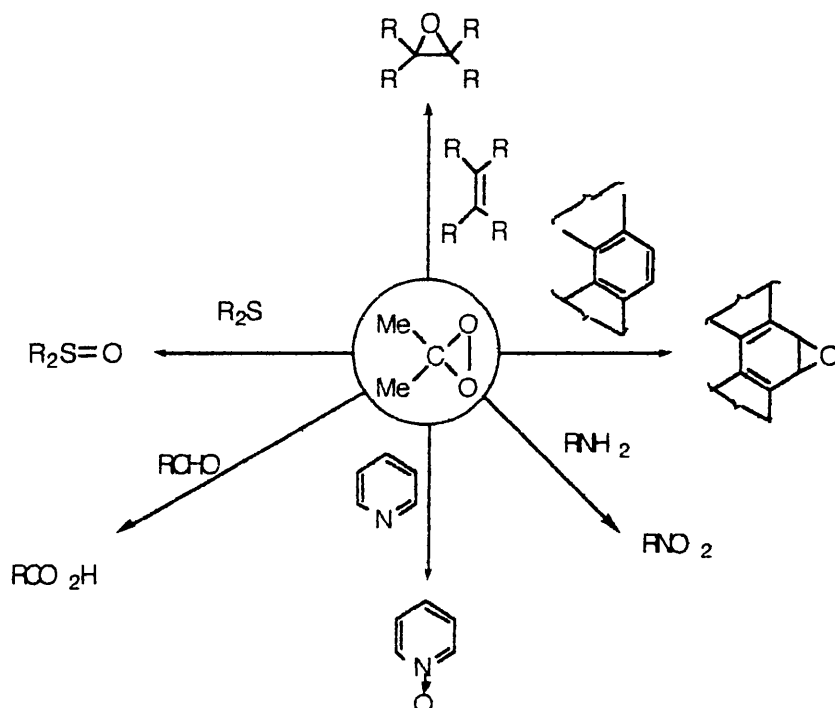

Scheme 1.30 Some reactions of dimethyl oxirane.

At one time it was thought that dioxirane, dioxymethane and dioxymethane biradical would exhibit similar chemistry from studies of the liquid phase ozonolysis of ethylene but recent work suggests that the respective barriers for their interconversion are sufficiently great that they exhibit different chemical behaviour when independently generated⁴⁶.

1.5.4 Geminal dialkylperoxonium ions

Trialkylperoxonium ions **25** were first reported by Mitchell and Porter³². They investigated the reactions of dialkyl peroxy bromides **48** with a variety of Lewis acids to produce products consistent with the intermediacy of the trialkylperoxonium ion. The products of the reaction depended critically on both chain length and the nucleophilic character of the solvent. The common peroxonium ion is trapped by a nucleophile **49**→**50** or rearranges to give a cyclic peroxide in non nucleophilic media **51**. The difference in nucleophilicity of the two oxygens competing for ring closure is dictated by the preference for the kinetically favoured five membered ring formation.

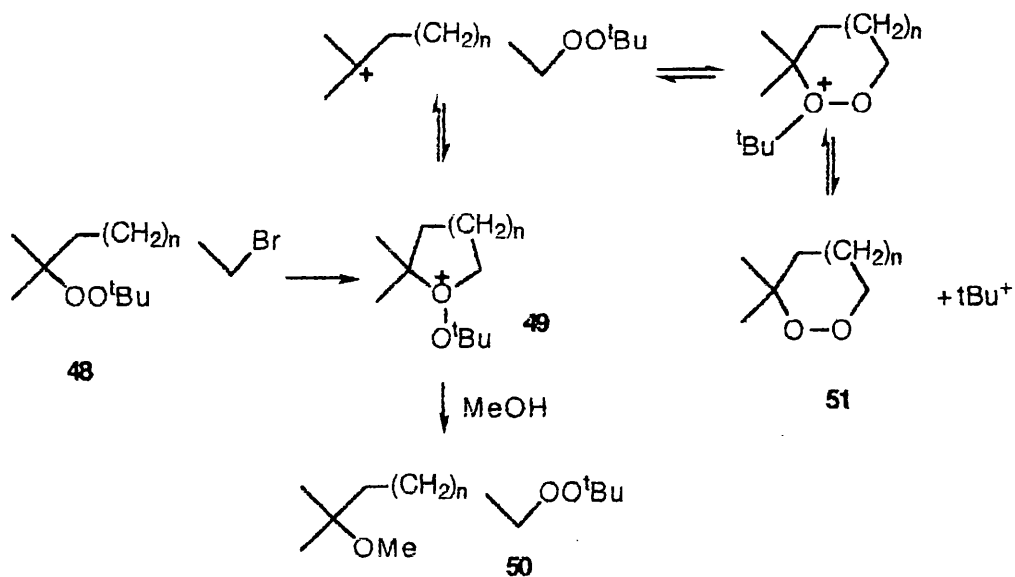

n	Silver salt	solvent	product composition %	
			51	50
1	AgTFA	CH ₂ Cl ₂	71	...
1	AgBF ₄	CH ₂ Cl ₂ /MeOH		>85
2	AgBF ₄	MeOH	40	
2	AgBF ₄	CH ₂ Cl ₂		70

Scheme 1.31

In related work Mitchell and Heaton⁴⁷ examined the silver mediated ring closure of 1-bromomethyl-8-(t-butylperoxy)methylnaphthalene **52** which yields naphthopyran **54** and trapped 2-methoxy-2-propyl cation **55**. A mechanistic scheme explaining the naphthopyran formation is shown.

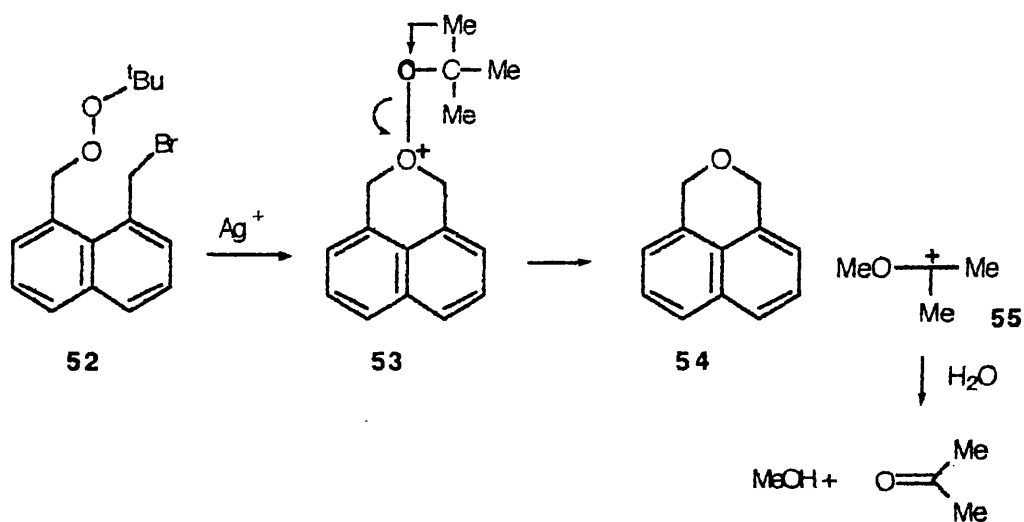

Scheme 1.32

Bloodworth, Courtneidge and Eggelte⁴⁸ examined the reactivity of 5-*t*-butylperoxycyclooctene which on treatment with NBS affords bicyclic ethers. In this case Baeyer-Villiger type O-O cleavage with 1.2 nucleophilic migration also took place.

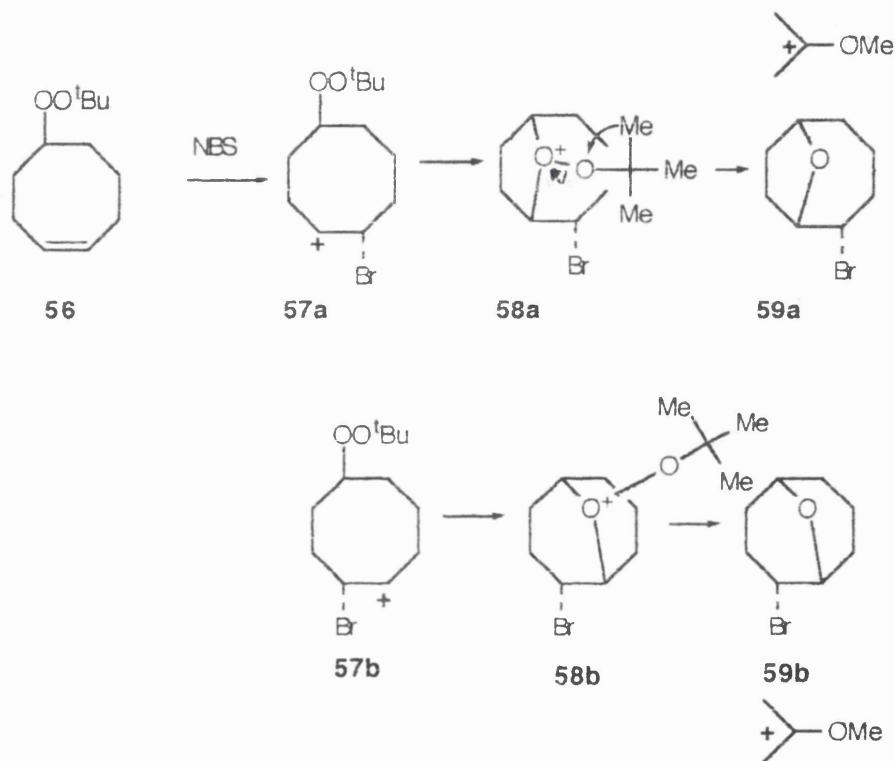

Scheme 1.33

Work on the related 5-hydroperoxy cyclooctene showed that internal nucleophilic attack at oxygen is not required for O-O cleavage. When **60** was treated with NBS under similar conditions to **56** the same product distribution of **63a** and **63b** was observed. This result suggested that peroxonium ions from hydroperoxy precursors might be sources of electrophilic OH.

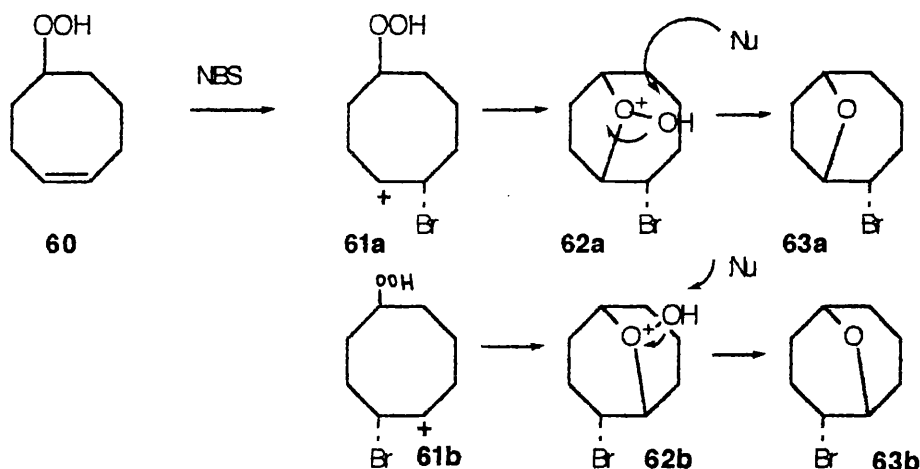

Scheme 1.34

The logical extension of the results described for the hydroperoxy cyclooctenes and the work of Mitchell on the dialkyl peroxy bromides is the use of hydroperoxy bromides. On treatment with silver salt we can envisage the following processes occurring.

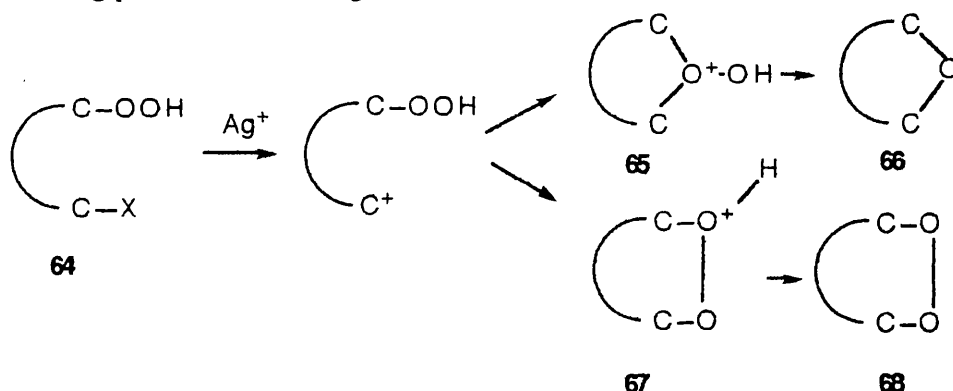

Scheme 1.35

Formation of the gem dialkylperoxonium ion **65** as opposed to the vic dialkylperoxonium ion **67** will depend on enthalpic/entropic effects. In systems hitherto disclosed a preference for the 'kinetic' ring closure with the formation of three and five membered rings is observed. This preference has been critical in the selection of systems to generate a gem dialkylperoxonium ion with the oxygen exocyclic rather than endocyclic vic dialkylperoxonium ion yielding the dialkyl peroxide **68**.

Systems so far examined where a geminal intermediate has been implicated in an oxygen transfer reaction are 1,8-bis(bromomethyl)naphthalene **69** with silver salt

and hydrogen peroxide, 5-hydroperoxy cyclooctene **60** with NBS and hydrogen peroxide and the acyclic 5-bromo-2-hydroperoxy-2-methylpentane **70** with silver salts and hydrogen peroxide. In each of the cases an oxidisable substrate (sulfoxide) was oxidised under conditions in which the hydroperoxide did not effect oxidation. Ether formation itself is evidence for the intermediacy of the dialkylperoxonium ion but, more importantly, with **60** and **70** the yield of oxidised substrate can be correlated with the amount of ether / bicyclic ether formed.

Furthermore, the results of a Hammett study⁴⁹ confirmed the electrophilic nature of the species **65** and the lack of evidence for deprotonation to the corresponding ylid **30**. Evaluation of the character of oxygen transfer with thianthrene 5-oxide⁴⁹ also provided evidence for the electrophilic nature of the dialkylperoxonium ion.

1.6 Activation of sodium perborate

Domestic laundry involves the removal/deconjugation of a wide variety of stains from fabric. These stains interact strongly with the fabric fibres, and bleaching, which involves the chemical degradation of the chromophores, takes place at the fabric surface.

Traditional bleachable stains are natural substances such as theaflavins **71** and anthocyanins **72** present in red wine and tea ; these highly conjugated molecules are built up of phenolic groups which are readily ionisable under the conditions used in the laundry process⁵⁰.

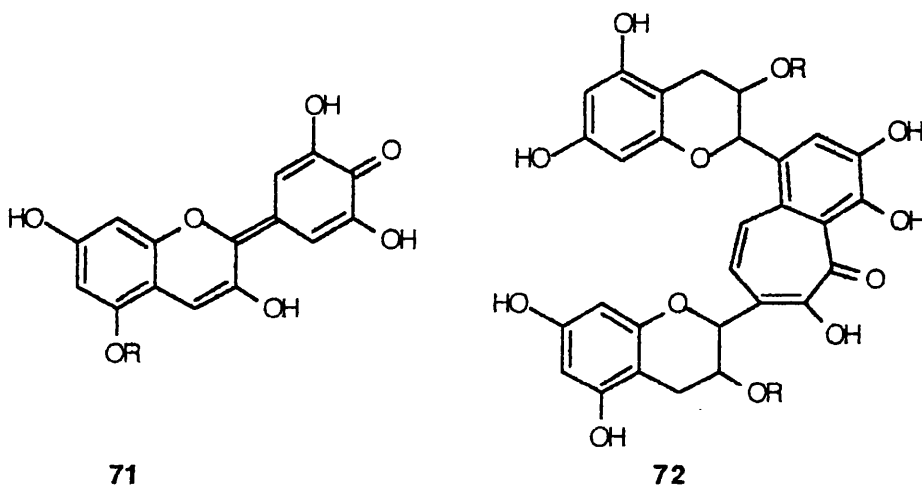

Most European washing compositions have contained an alkali metal persalt such as sodium perborate or sodium percarbonate. In aqueous solution at or near the boiling point of water, this effectively acts as an in situ source of hydrogen peroxide and is a highly efficient, non destructive laundry bleaching agent. However, at somewhat lower temperatures, the bleaching effectiveness rapidly deteriorates and at 50-60°C is only barely significant⁵⁰.

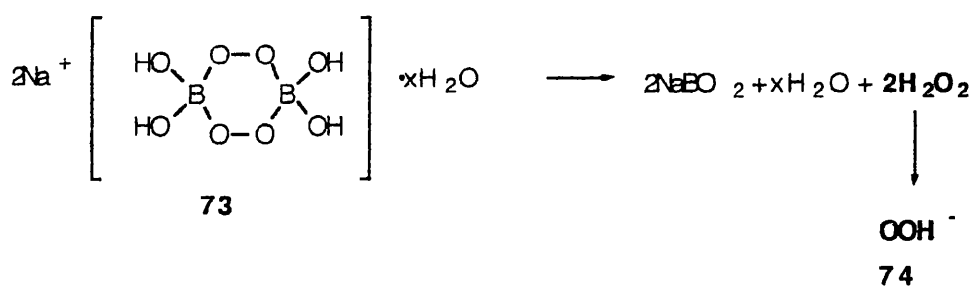

Scheme 1.36 Generation of perhydroxyl anion by sodium perborate

Current thinking suggests that the active oxidising species in the reaction is not hydrogen peroxide itself but the perhydroxyl anion **74**. This is to be expected as sodium perborate adds to the alkalinity of the solution and bleaching effectiveness has been shown to be enhanced at high pH. (pH of a 1% solution is 10.2).

Recently the impetus has been towards lower wash temperatures and shorter wash times. This trend has created the need for an oxidising species which is more reactive at these lower temperatures. As discussed earlier hydrogen peroxide can be activated in a number of ways, including the generation of radicals, singlet oxygen, metal peroxy species and peracids. The detergents industry has focussed principally on the use of organic peracids for low-temperature bleaching. An additional factor here is that stains tend to be electron rich and are more readily attacked by an electrophilic bleaching species.

This led to the development of persalt activators. The persalt activator is an organic compound containing at least one acyl group, RCO-, which is capable of reacting with the perhydroxyl anion generated from sodium perborate (or other alkali metal persalt) to form a peracid, RCO₃H in situ. One activator that has been used is TAGU **75** which generates peracetic acid. The perhydroxyl anion **74** can attack the acetyl group of TAGU to give peracetic acid which dissociates to give the active bleaching species peracetate anion **76**. Similarly TAED **77** reacts to form diacetyl ethylene diamine on perhydrolysis. TAED is

superior to TAGU in terms of the ratio of molecular weight to the amount of peracetic acid released, TAED is the current commercial market leader. The perhydrolysis of TAED is rapid even at temperatures as low as 20°C. Like other persalt activators the rate of reaction is almost independent of the source of available oxygen.

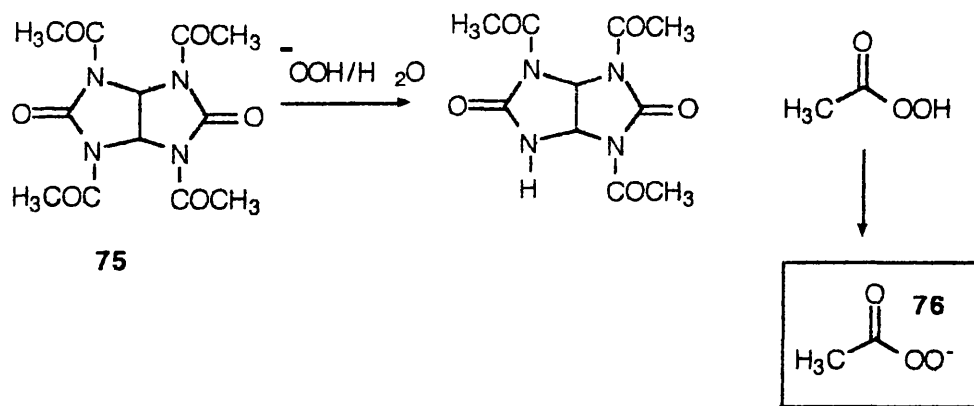

Scheme 1.37 Generation of peracetic acid anion with TAGU

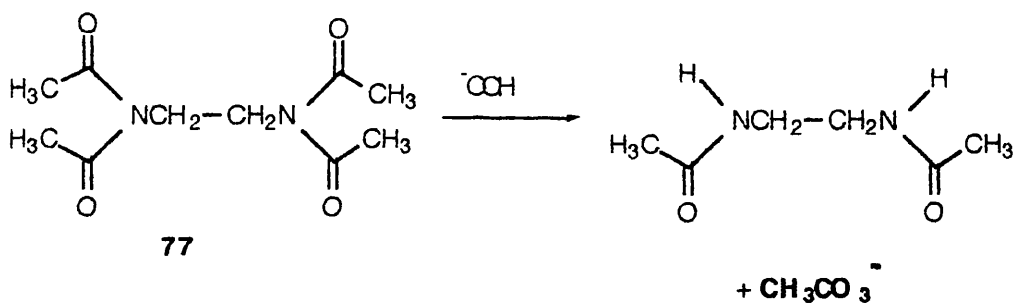

Scheme 1.38 TAED as a persalt activator

The use of activators requires the dissolution of both the activator and the bleach, followed by rapid reaction in order to generate the peracid in situ in the time span of the wash cycle. Wasteful reactions such as alkaline hydrolysis in competition with perhydrolysis of the activator, diacyl peroxide formation, and the decomposition of the hydrogen peroxide by enzymes or metal ions, all reduce the efficiency of the peracid generation.

In the presence of an activator, the key reaction is no longer the release of free hydrogen peroxide to the solution but rather the formation of a more reactive peracid or its anion. At lower temperature, the new peracid is more effective as a bleach than hydrogen peroxide from sodium perborate.

One problem with the more facile release of active bleaching agent at lower temperatures is the tendency to decompose much more readily even before garment washing has started. Moisture, storage temperature and the time the activator spends in the detergent pack can all lead to premature decomposition, in the extreme leading to release of acetic acid with those activators designed to release peracetic acid. Alteration of product formulation for example the granulation technology used in the TAED product Mykon 'A'TM 51 has ameliorated this problem, to some extent.

Perborate activators that yield functionalised peroxyacids have also received attention. The isatoic anhydrides **78** on perhydrolysis yield the active bleaching species shown **79** 52.

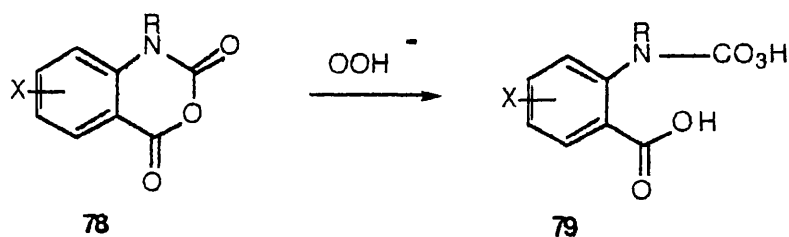

Scheme 1.39 Isatoic anhydrides as bleach activators

Although activation is expensive this is offset by the requirement for less perborate in the detergent formulation typically from 20% to 12% perborate. Manufacturers also place a premium on the increased bleaching effectiveness of the bleach activator at lower temperature.

One other problem particularly in a short wash cycle is that the reaction of perborate and activator may not go to completion. To overcome this problem it has been suggested that preformed peracids or their salts are employed. These are known to release their active oxygen with much greater facility than similar amounts of hydrogen peroxide from which they are usually prepared. One such compound has been introduced by Interlox as H48TM which is magnesium monoperoxyphthalate **80**. This compound has already demonstrated its utility in typical reactions of use to the synthetic chemist.⁵³ Other functionalised peracids which are claimed to have improved physical characteristics include the N-alkyl phthalimido percarboxylic acids **81** as adjuncts/ replacements for perborate.

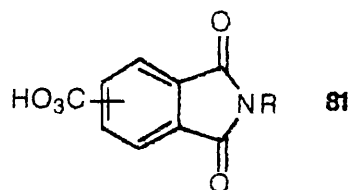
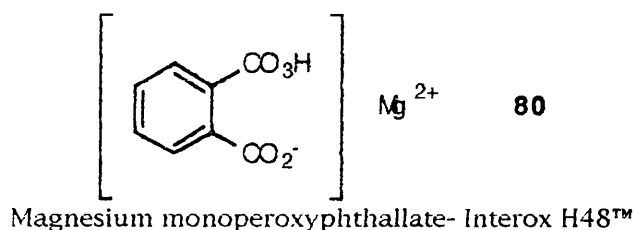

N-alkylphthalimido percarboxylic acid an example of a functionalised peracid as an adjunct to perborate

1.7 Overview of proposed research

This research aimed to evaluate the oxygen transfer ability of gem-dialkyl peroxonium ions **29** with the long term objective of developing a new highly active bleaching system.

The first target was the discovery of more readily available precursors to gem dialkyl peroxonium ions. To this end we presumed that bromoalkenes would be good sources of the desired hydroperoxides. These are readily obtained from alkenes by singlet oxygenation. We also felt that autoxidation of suitably configured bromo substituted tertiary hydrocarbons might afford another source of precursors to cyclic peroxonium ions given the literature precedent and commercial success of the autoxidation of cumenes. Finally we investigated the reaction of ortho substituted perbenzoic acids. Given that Mitchell had prepared trialkyl peroxonium ions **26** and Melvin dialkylperoxonium ions **27** we felt that this approach might make accessible the hitherto unknown acyl alkyl peroxonium ions (scheme 4.2 page 119).

2. Dialkylperoxonium ions.

In Chapter 1 we discussed the evidence for the intermediacy of the dialkyl peroxonium ion. Although these species have been produced and well characterised the preparation of their precursors is somewhat protracted. It occurred to us that the precursors for an industrial process would need to be obtained from readily available starting materials with the minimum of synthetic effort.

We proposed to generate the peroxonium ion precursors by the singlet oxygenation of cyclic bromoalkenes to produce allylic hydroperoxides with suitably positioned bromine substituents. Photosensitised (singlet) oxygenation of alkenes gives hydroperoxides in high yield. Other non photochemical methods of singlet oxygen generation involve the reaction between H₂O₂ and NaOCl or between ozone and triethyl phosphite⁵⁴⁻⁵⁶.

2.1 Preparation of the hydroperoxide precursors

The starting point for our work was the bromoalkene 5-bromocyclooct-1-ene **82**. Bloodworth, Melvin and Mitchell⁵⁷ had shown previously that 4-cycloocten-1-yl hydroperoxide **83** when treated with NBS gave the peroxonium ions **84X** and **84Y** (Scheme 2.1). Oxygen transfer to an oxidisable substrate (sulfoxide) had been demonstrated.

83 is rather inaccessible requiring four steps (19% yield) from 4-cycloocten-1-ol **85**. Compound **85** itself requires a further two steps for its preparation from cycloocta-1,5-diene **86**.

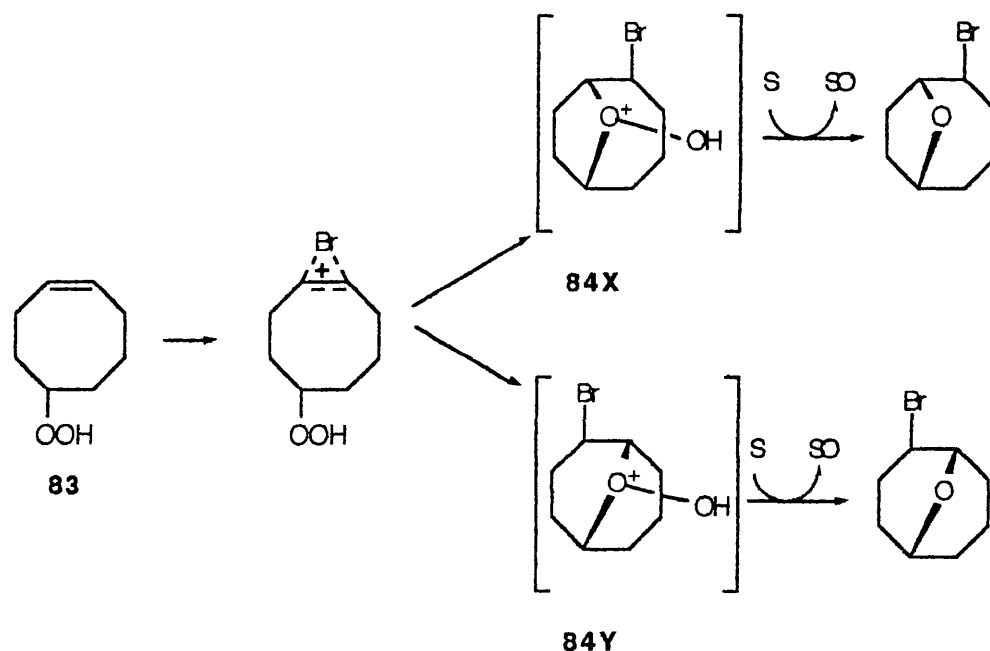

Scheme 2.1 Dialkylperoxonium ions from cyclooctenyl hydroperoxide

5-Bromocyclooct-1-ene **82** was prepared by addition of hydrogen bromide in glacial acetic acid to cycloocta-1,5-diene **86**⁵⁸. We expected that photooxygenation of **82** would give the mixture of hydroperoxides **87** and **88**.

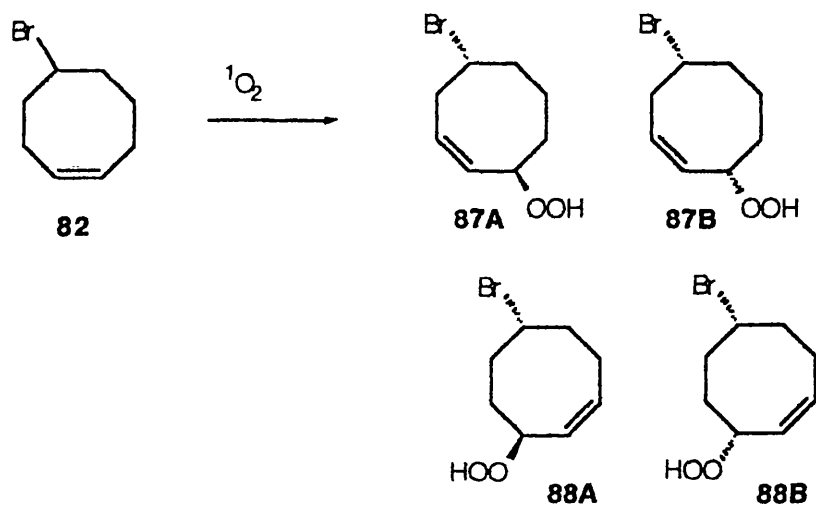

Scheme 2.2 Hydroperoxide preparation from 5-bromocyclooct-1-ene

This reaction mixture proved inseparable by column chromatography or flash chromatography and early in the investigation we were unsure as to whether the mixture would be separable. In the event HPLC conditions were found by S. J.

Corker under which the hydroperoxide mixture could be separated into its constituent components.

For this reason we also decided to prepare the seven membered bromoalkene 5-bromocyclohept-1-ene **89**. Although much less accessible than **82** singlet oxygenation affords a mixture of only the *cis* and *trans* hydroperoxides **90A** and **90B**. Because of the plane of symmetry through the bromine and the double bond of **89** no positional isomerism is possible in the derived hydroperoxides **90**.

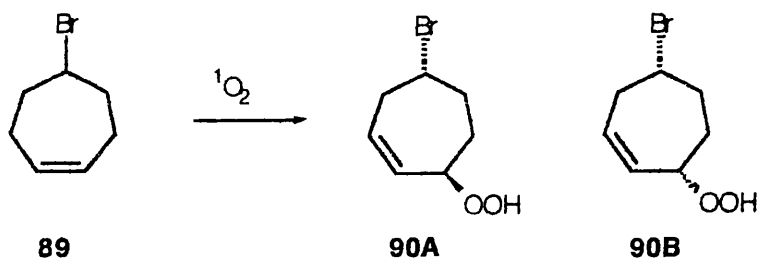

Scheme 2.3 Hydroperoxide preparation from 5-bromocyclohept-1-ene

Our early work on the system was with a mixture of the hydroperoxides although subsequently N. Mortimer of British Petroleum separated the hydroperoxides into their constituent components by reverse phase HPLC. A further advantage is that only one bicyclic ether **92** can be formed from a Lewis acid assisted ring closure involving the dialkylperoxonium ion intermediate **91A** (Scheme 2.4). In contrast the bromocyclooctenyl hydroperoxides in principle can form two dialkylperoxonium ion intermediates **93A** and **95A** and hence two bicyclic ethers **94** and **96** (scheme 2.5). Given that we expected only the *trans* hydroperoxides to be capable of ring closure analysis of the final product mixture of the eight membered ring system was likely to be difficult.

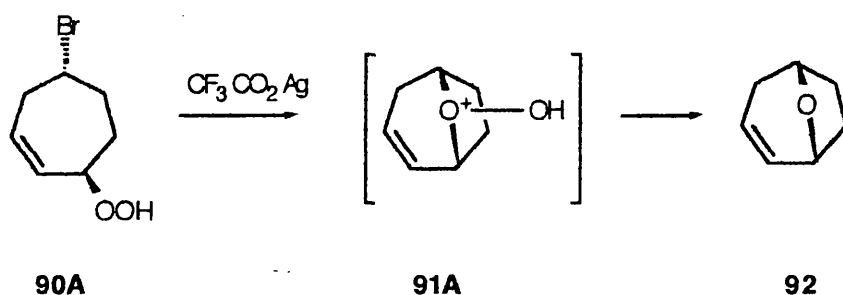

Scheme 2.4

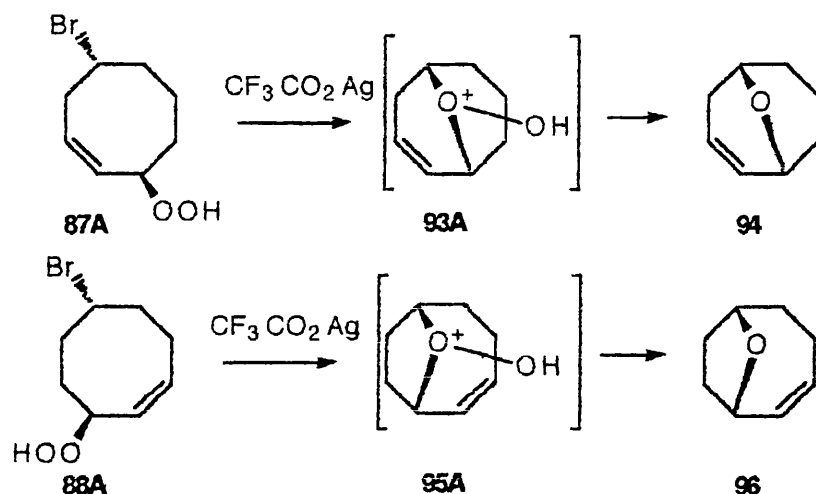

Scheme 2.5

4-Cyclohepten-1-yl bromide **89** was prepared from 4-cyclohepten-1-yl carboxylic acid **101**. Compound **101** was prepared by the ring enlargement sequence of Stork and Landesman⁵⁹(scheme 2.6). Treatment of cyclopentanone **97** with pyrrolidine afforded the enamine **98** which, after isolation, was treated with acrolein to provide the bicyclic amino ketone **99**. Quaternisation with methyl iodide gave **100** and hydrolysis with strong base with Grob fragmentation afforded the carboxylic acid **101** which was recrystallised from pentane. A report appeared in the literature in which pyrrolidine was replaced by dimethylamine to improve the yield of enamine⁶⁰. Dimethylamine is very expensive and instead of using the gas directly we attempted to make the enamine dimethylamino cyclopentene by preparing dimethylamine from its hydrochloride salt, liquefying it and adding to cyclopentene as directed by Marquardt⁶⁰. We found however that the reaction rate was much slower than expected and that raising the reaction temperature caused much of the dimethylamine to boil off. Because of these difficulties we reverted to the procedure of Stork and Landesman⁵⁹.

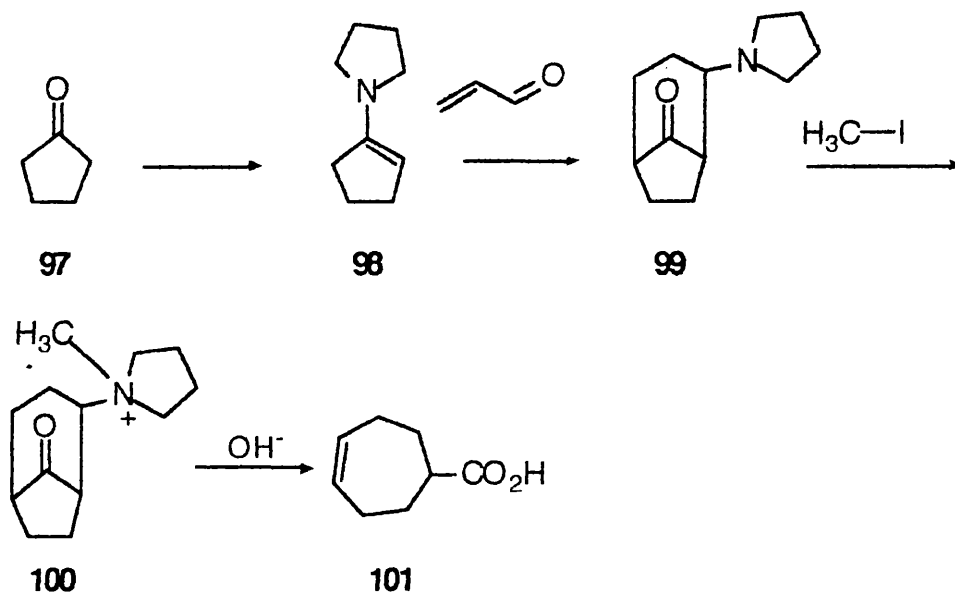

Scheme 2.6 Preparation of 4-cyclohept-1-yl carboxylic acid

The literature route⁶¹ for obtaining the bromide from the carboxylic acid involves the decarboxylation of the acid with lead tetraacetate.

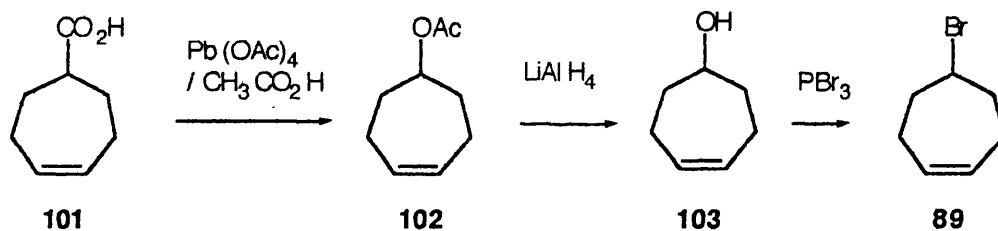

Scheme 2.7 Cope's route to 5-bromocyclohept-1-ene

Reduction of the acetate **102** gives the alcohol **103** and treatment of the alcohol with phosphorus tribromide gives the desired product **89**.

This reaction sequence was not high yielding in our hands. We were unable to dry the glacial acetic acid effectively to ensure that the decarboxylation proceeded cleanly in the reported yield using lead tetraacetate. Secondly we obtained 1,4-dibromocycloheptane, as well as the desired bromoalkene **89** when we attempted to treat the alcohol with phosphorus tribromide (probably due to hydrolysis of the phosphorus tribromide with water to give hydrogen bromide). In spite of the low yields for this reaction the route was still of importance for the production of the authentic bicyclic ether 8-oxabicyclo{3.2.1} oct-2-ene **92** from **103**.

An alternative route for the conversion **101**→**89** using the thiohydroxamate methodology of Barton⁶²⁻⁶⁶ was employed. Walton⁶⁷ has previously reported the synthesis of **89** from acid chloride **104** using thermal conditions with the isolation of the intermediate thiohydroxamate ester **105**. We felt that we could improve the yield of the reaction by not isolating the intermediate ester **105** which is both light and air sensitive. This improved the yield of the bromide **89** to 48% compared to the 37% of Walton.

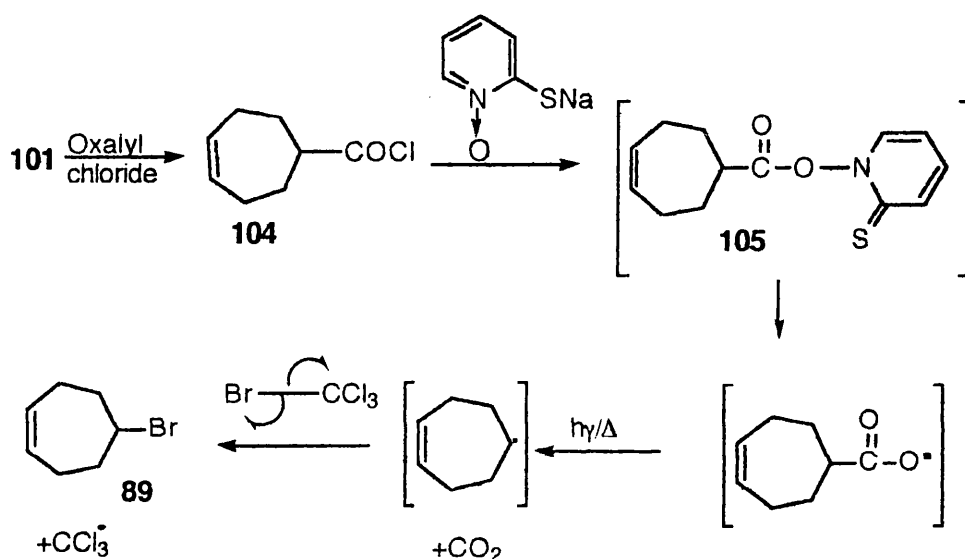

Scheme 2.8 Thiohydroxamate route to **89**.

The byproduct of this reaction was 2,5-dibromo-1-trichloromethyl cycloheptane **106**. We propose that this product is formed by the addition of the $\text{CCl}_3\cdot$ radical to the olefin functionality. An explanation for its formation is that as the 4-cyclohepten-1-yl bromide accumulates it competes with the intermediate thiohydroxamate ester for CCl_3 radicals. We presumed that we might overcome this problem by using milder photolytic conditions. The yield of product **89** stayed unchanged at 48%. We noted that only one pair of the expected isomers of **106** is formed in this reaction.

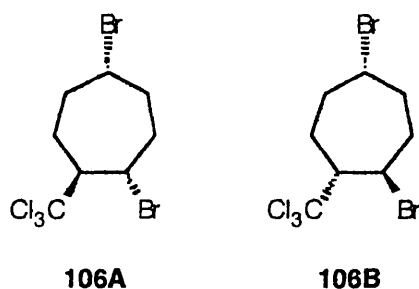

In general

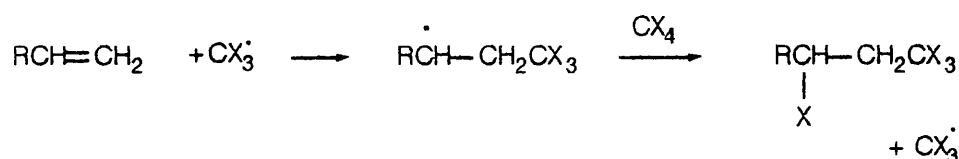

Scheme 2.9

Normally the initial attack by the CX_3 radical is to the least substituted carbon of the double bond. In this case both carbons are equivalent so we would expect compound **106A** and **106B** to be formed with compound **106A** predominating if the bromine at C5 exerts its effect from its 'remote' position. The bromine atom which is abstracted to complete the addition would be expected to add *trans* to the trichloromethyl moiety because of steric bulk, hence the assignment of the product as *2-trans-5-trans*-dibromo-1-trichloromethylcycloheptane **106A** and *2-trans-5-cis*-dibromo-1-trichloromethyl cycloheptane **106B**.

2.2 Characterisation of the hydroperoxides

As expected a mixture of four hydroperoxides resulted from the irradiation of **82** in the presence of oxygen and the sensitiser tetraphenylporphine. The ^{13}C NMR confirms that the hydroperoxides formed have the characteristic chemical shifts expected (see ^{13}C NMR figure 2.1). The chemical shifts of the eight alkenyl carbons are in the region 125-135 ppm, the chemical shifts of the four carbons attached to the hydroperoxide moiety are in the region 81-84 ppm, the chemical shifts of the four carbons attached to the bromine atom are in the region 53-55 ppm and those for the sixteen CH_2 carbons in the region 20-38 ppm.

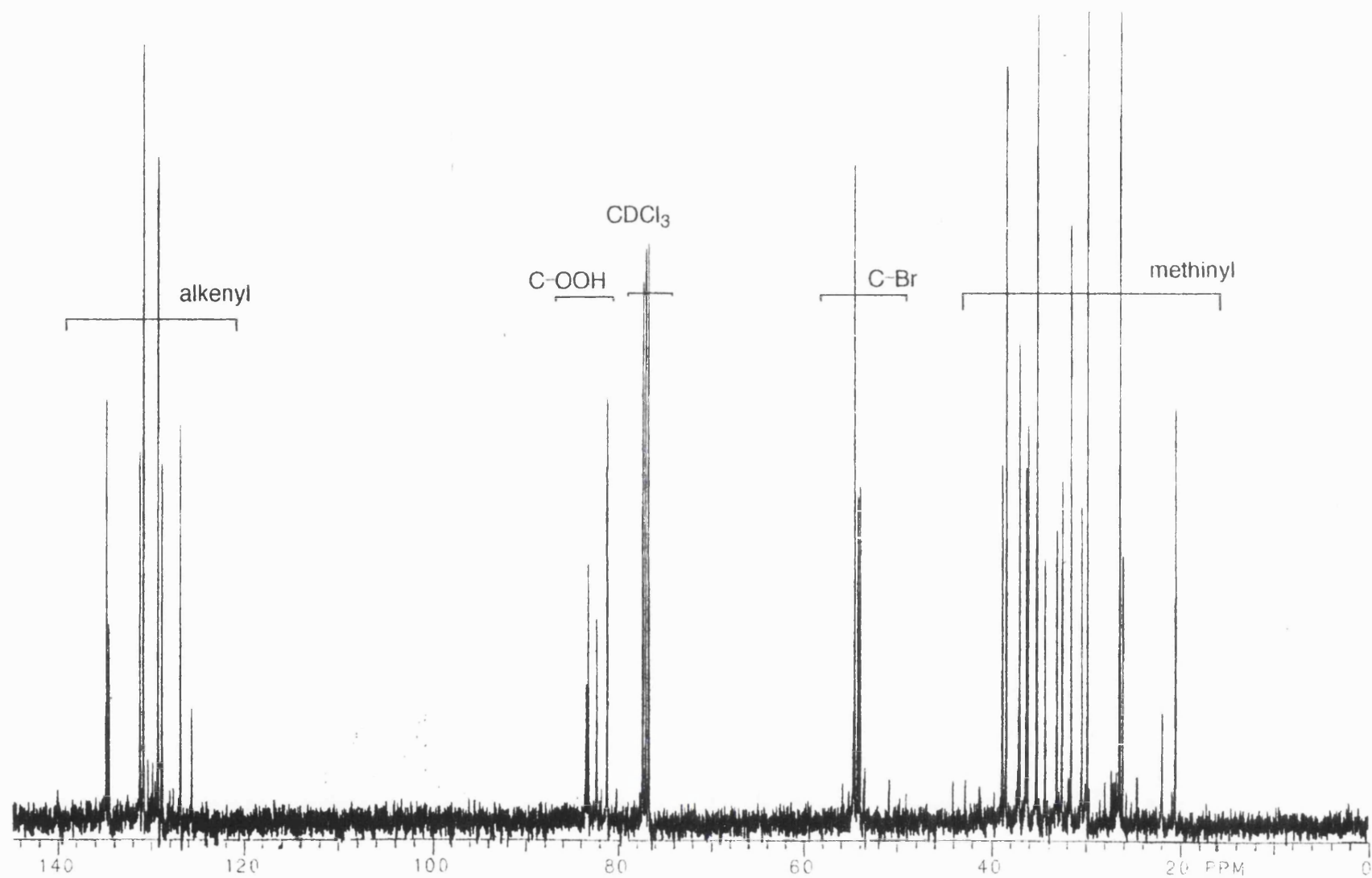

Figure 2.1 ^{13}C NMR of the mixture of hydroperoxides **87** and **88**

The formation of these hydroperoxides **87A**, **87B**, **88A** and **88B** (scheme 2.2) was relatively slow and required prolonged reaction times in an immersion cell reactor. (see experimental) Our cyclooctenyl hydroperoxides **87A**, **87B**, **88A** and **88B** were not amenable to separation by gravity or flash chromatography but were separable by normal phase (ethyl acetate/hexane/SiO₂) HPLC (figure 2.2). The separation resulted in the collection of five fractions; the expected hydroperoxides and a fraction **4A** shown to be the ketone **110** or **111**. Subsequent HPLC (figure 2.3) on a freshly prepared sample of the hydroperoxide mixture showed fraction **4A** to be an artifact. Compound **110** or **111** is likely to have arisen from the Hock fragmentation (acid catalysed carbonyl forming dehydration) (+ H⁺- H₂O) of the hydroperoxide **87A** or **87B** (OR **88A** or **88B**). The ketones **110** and **111** have been prepared but only as a mixture. This mixture of ketones had not been separated although comparison ¹H NMR of the mixture **110** and **111** with this fraction **4A** shows identifies this sample unambiguously

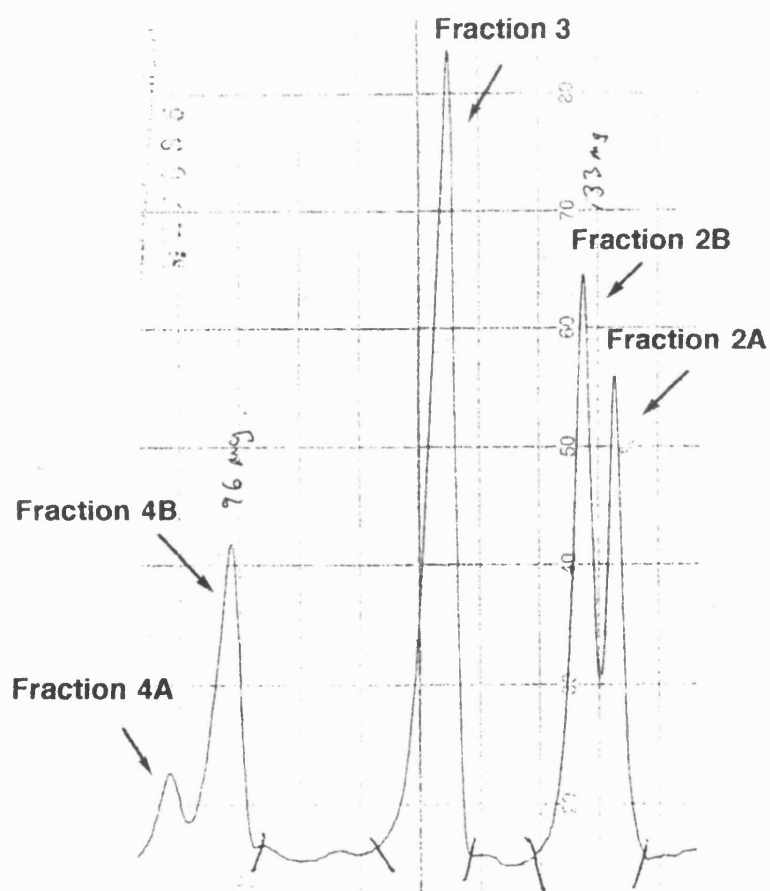

Figure 2.2 HPLC chromatogram for separation of a sample of stored bromocyclooctenyl hydroperoxides **87** and **88**.

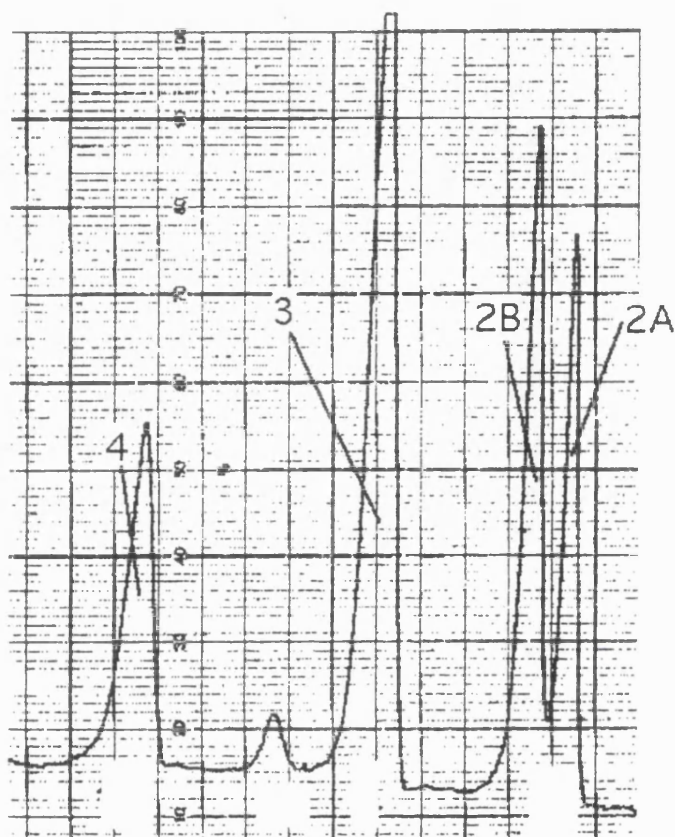
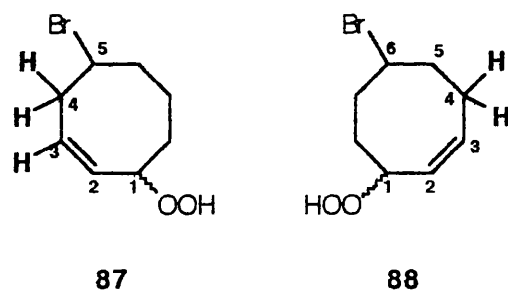

Figure 2.3 HPLC chromatogram of a sample of freshly prepared bromocyclooctenyl hydroperoxides **87** and **88**.

2.2.1 Spectroscopy

Proton single frequency off-resonance decoupling experiments established the positional isomerism of each of the hydroperoxides but not their stereochemistry.

To distinguish between 5-bromocyclooct-2-en-1-yl hydroperoxides **87** and 6-bromocyclooct-2-en-1-yl hydroperoxides **88** the allylic C^4H_2 protons were examined. For structure **87** but not structure **88** these are coupled to **both** $C^5H(Br)$ and $C^3H=C^2$.



This condition was found for HPLC fractions **2B** and **4B** where the chemical shifts were C^4H_2 δ 2.7, C^3H δ 5.62, C^2H δ 5.75, $C^5H(Br)$ δ 4.35 and $C^1H(OOH)$ δ 4.75.

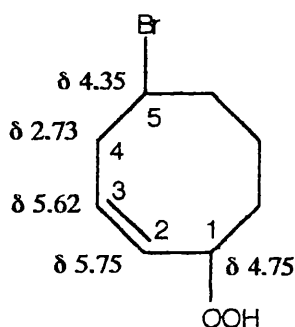

Irradiation at δ 5.62 (figure 2.4b) or δ 4.35 (figure 2.4d) caused the multiplet at δ 2.73 to collapse to the AB part of an ABX system. The assignment of C^5H and C^1H are confirmed since irradiation at δ 5.75 collapsed the signal at δ 4.75 but not the signal at δ 4.35.

This condition was not found for HPLC fractions **2A** or **3** which are therefore assigned structure **88**. Incidentally the allylic protons C^4H_2 are now at higher field namely δ 2.35 (compare figures 2.4(NMR of 2A and figure 2.5 (NMR of 2B))

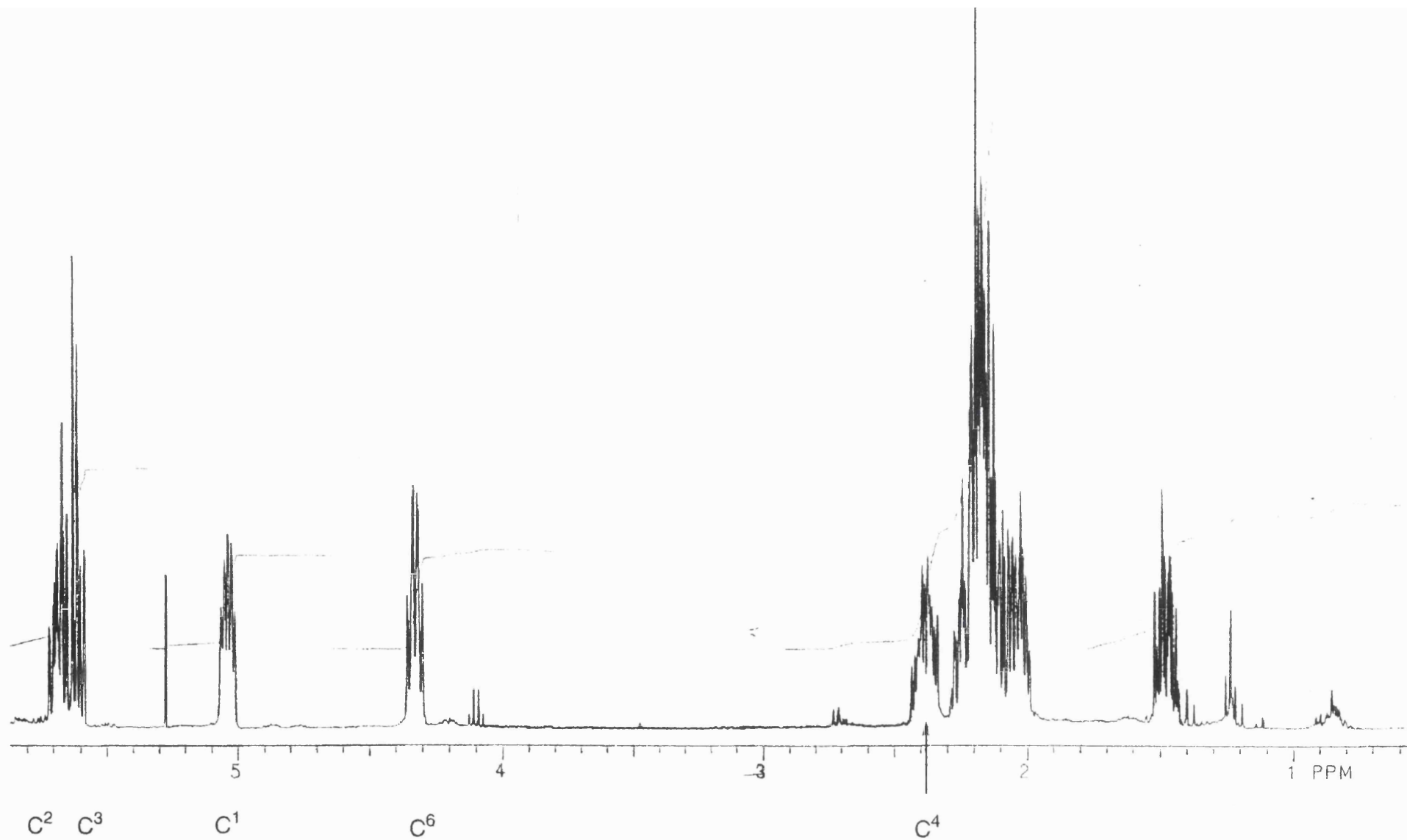

Figure 2.4 ^1H NMR of Fraction 2A assigned as 88A

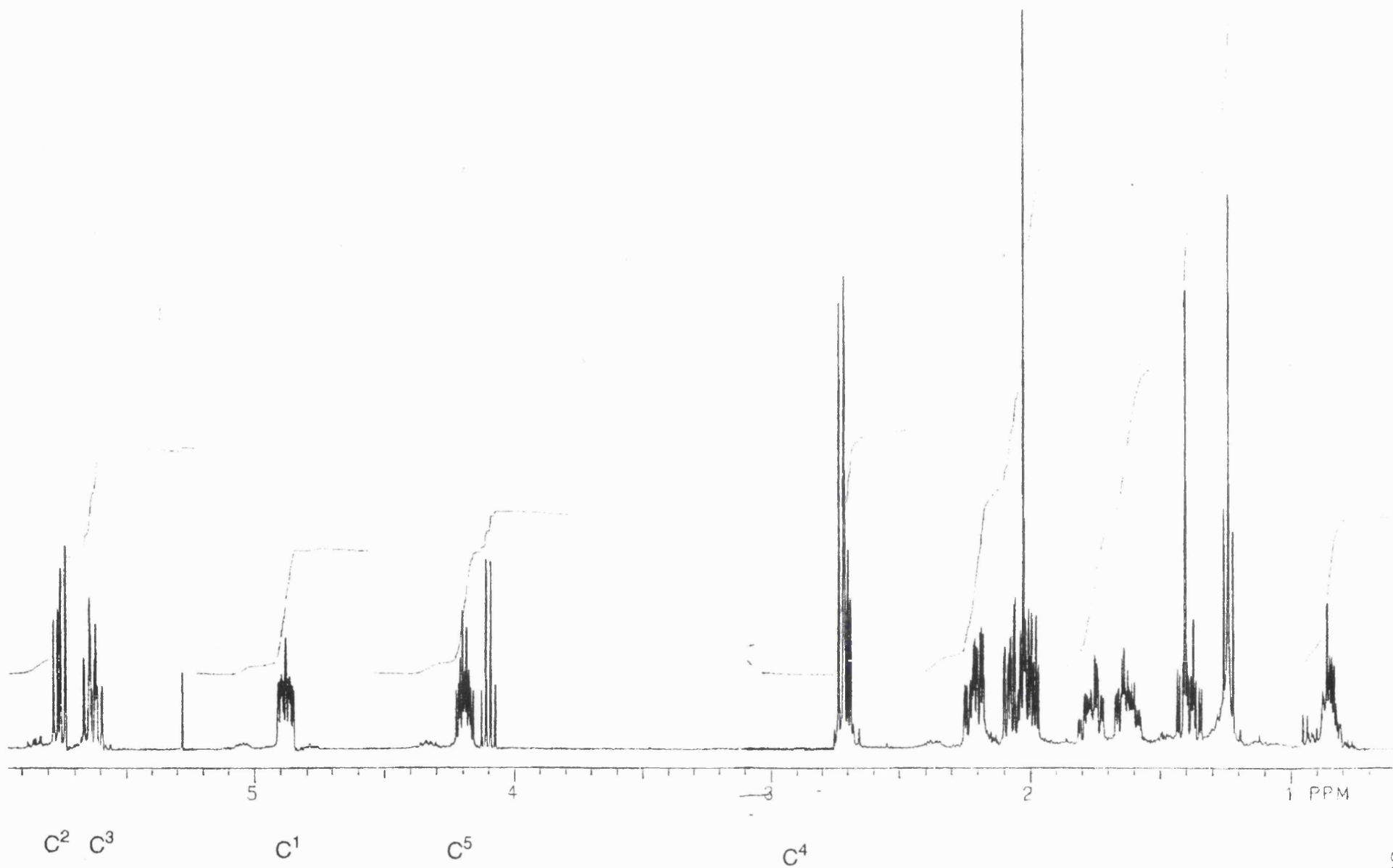

Figure 2.5 ^1H NMR of Fraction 2B assigned as **87A**

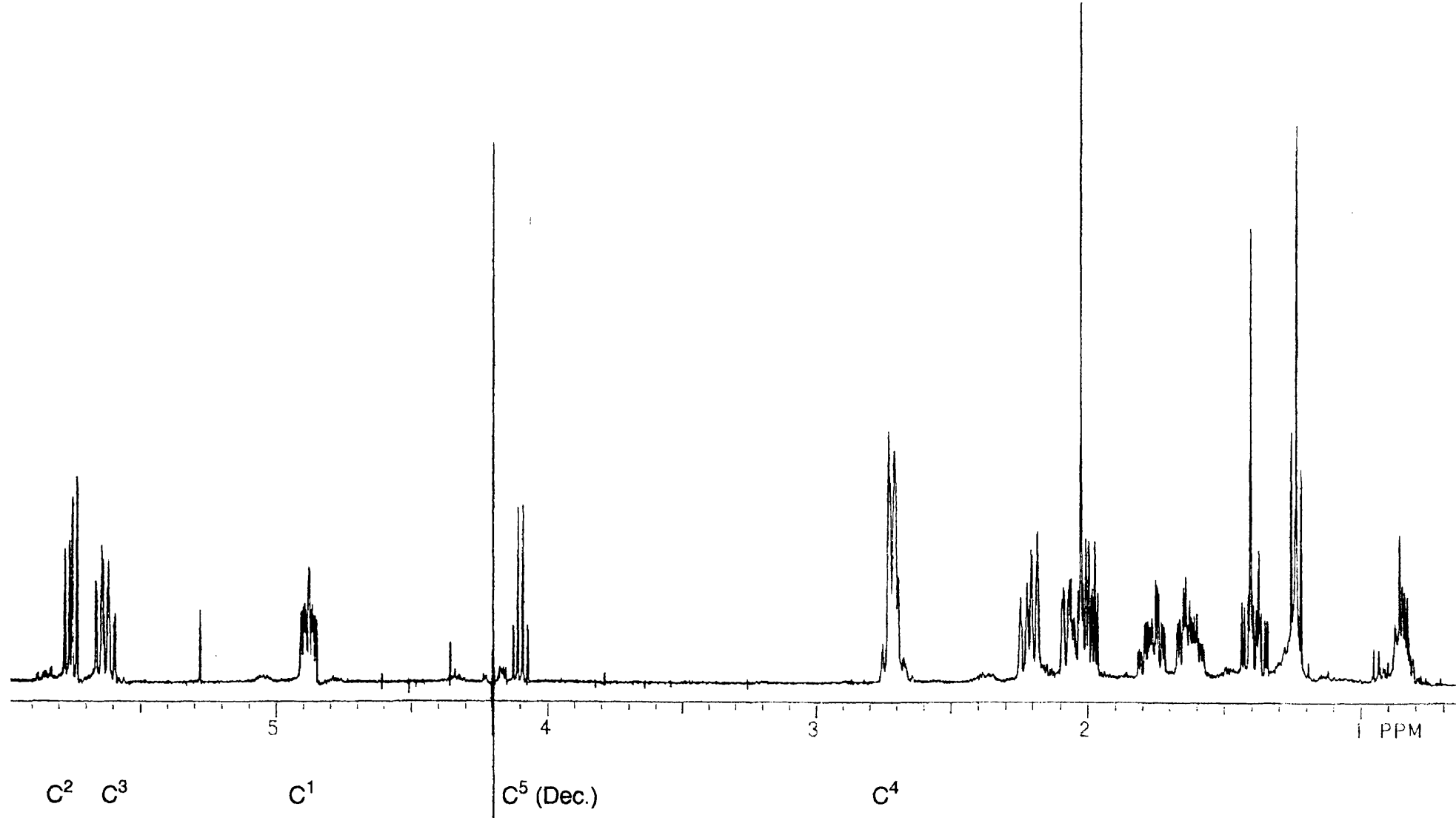

Figure 2.6 ^1H NMR of Fraction 2B assigned as **87A**
Irradiation at δ 4.20 C^5 simplifies the multiplet
at δ 2.73 C^4

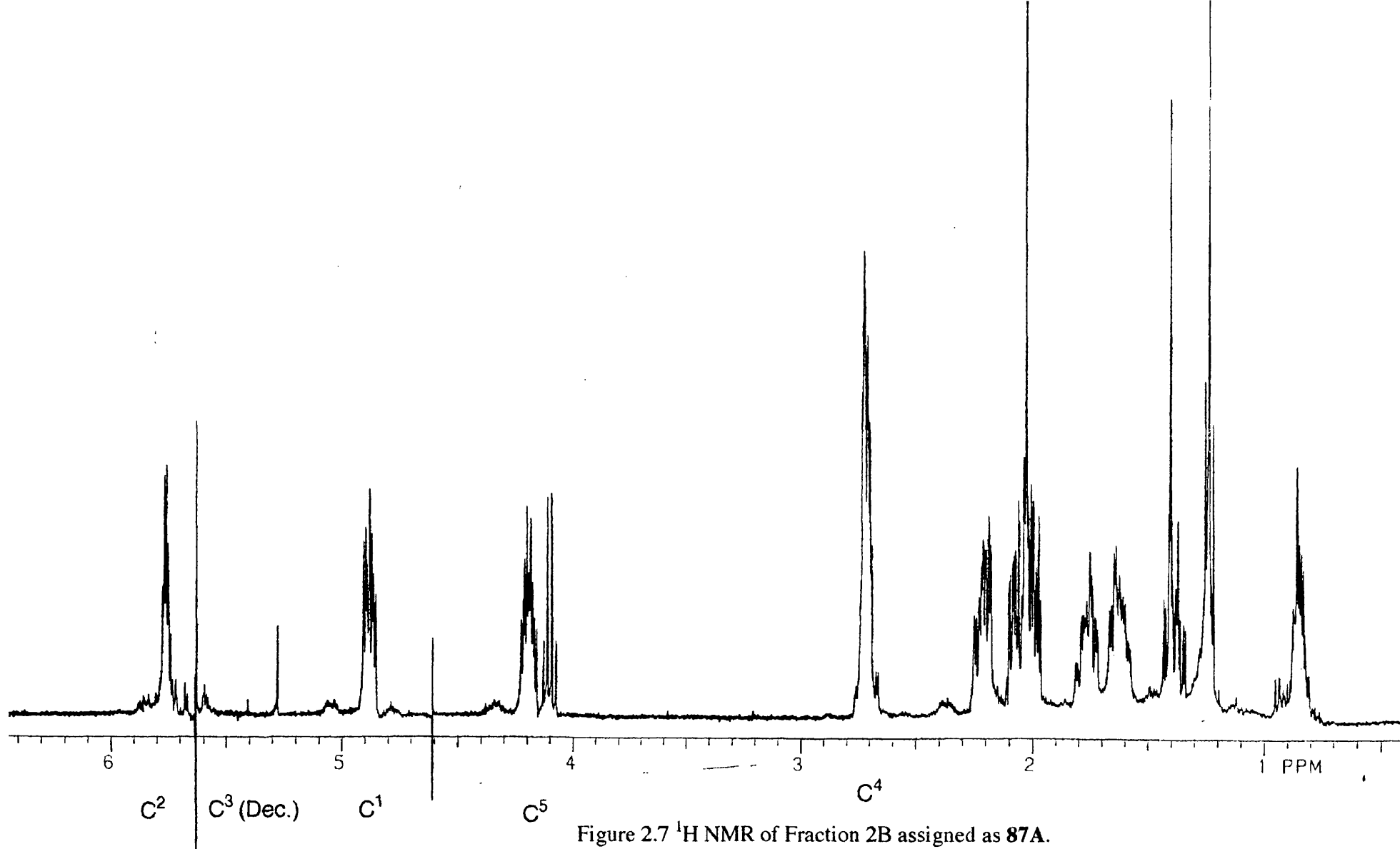

Figure 2.7 ¹H NMR of Fraction 2B assigned as 87A.
Irradiation of δ 5.62 C³ simplifies the multiplet
at C⁴ δ 2.72

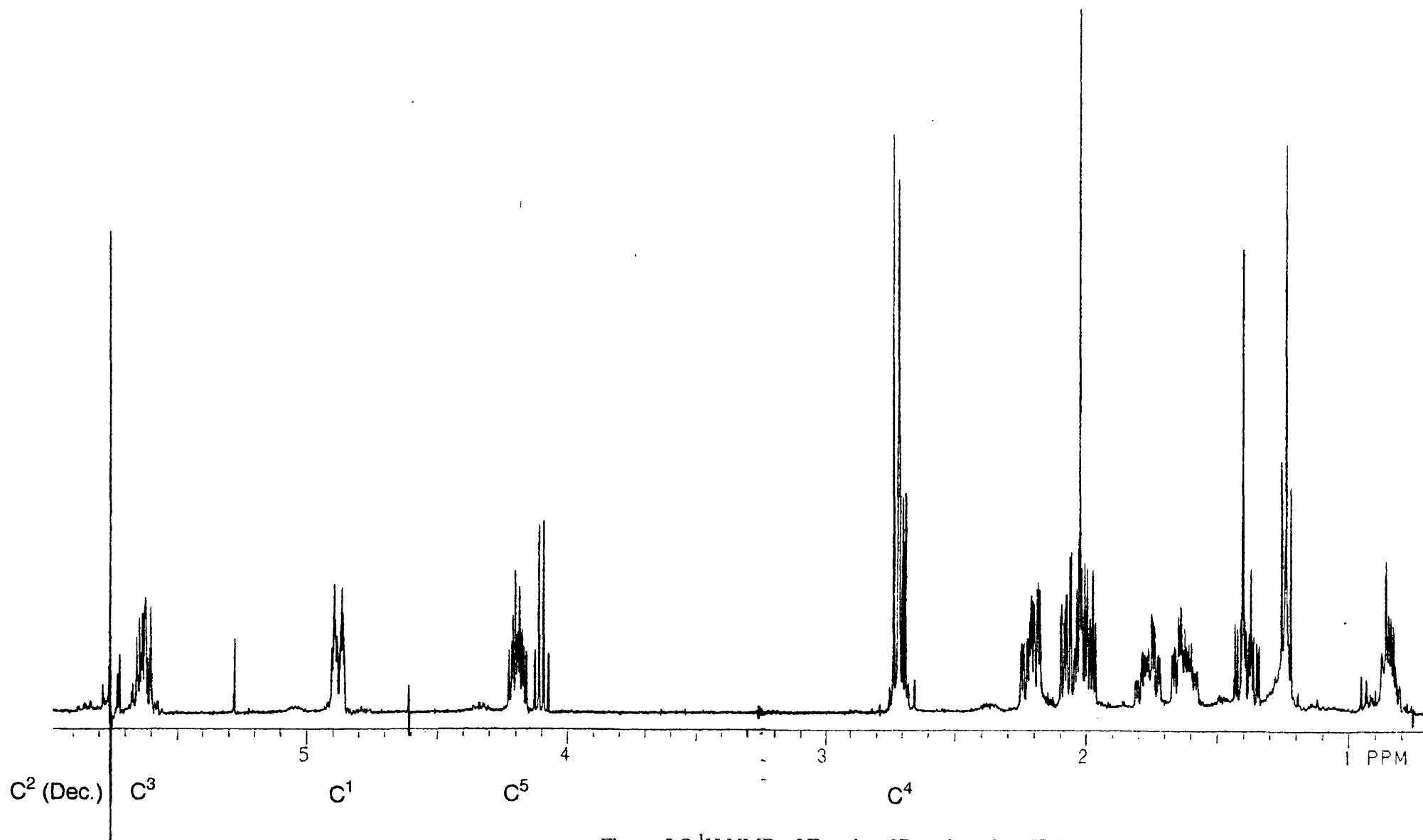
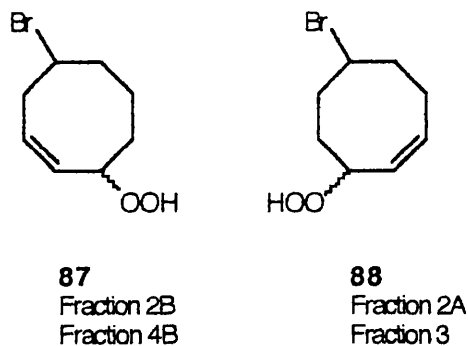

Figure 2.8 ^1H NMR of Fraction 2B assigned as **87A**
Irradiation at δ 5.75 C² simplifies the multiplet
at C¹ δ 5.80

In summary the following regiochemistries were observed



The relative ratios of hydroperoxides in a freshly prepared sample was as follows.

Bromocyclooctenyl Hydroperoxide ratios

Fraction Number	Compound	Estimated by HPLC	Estimated by NMR
2A	88A	1.00	1.00
2B	87A	1.38	1.22
3	88B	2.50	2.50
4B	87B	0.83	0.99

The attribution of stereochemistry to each of the fractions has been determined by the reactions described in section 2.3

HPLC fraction **4A** was confirmed as the ketone **110** or **111** confirmed by MS, IR spectroscopy ($C=O$ at 1600 cm^{-1}) and by comparison with the authentic material prepared independently.

The bromocycloheptenyl hydroperoxides **90A** and **90B** were prepared under less forcing conditions than those needed for the cyclooctenyl system. Singlet oxygenation of 4-bromocyclohepten-1-yl bromide **89** was initially problematic. In the absence of the antioxidant 2,6-di-*t*-butyl-4-methylphenol (BHT) **108** we obtained products that were not the expected hydroperoxides. Addition of 10 mol % of BHT appeared to suppress the formation of these other products and the expected hydroperoxides were obtained in high yield along with 2,6-di-*t*-

butyl-4-methyl-4-hydroperoxy cyclohexa-2,5-dien-1-one **109**. The *cis* hydroperoxide **90B**, *trans* hydroperoxide **90A** and the hydroperoxide from BHT **109** were separated by reverse phase HPLC (acetonitrile/water/ODS2). The acetonitrile was then removed at reduced pressure and the remaining aqueous phase extracted with dichloromethane. The compounds were isolated by drying the dichloromethane, filtration and removal of the dichloromethane.

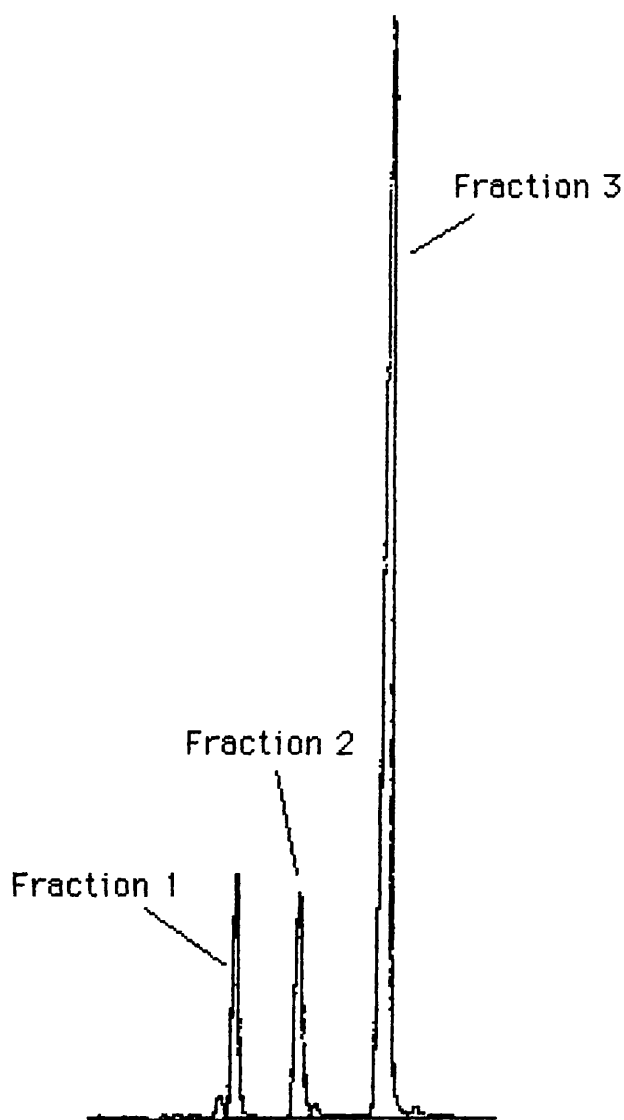

HPLC chromatogram of the crude bromocycloheptenyl hydroperoxides **90A** and **90B** and hydroperoxide **109**.

The relative ratios of the individual fractions was as follows

Bromocycloheptenyl Hydroperoxide ratios

Fraction	Estimated by	Estimated by
	HPLC	NMR
1	0.51	*
2	1	1
3	2.68	2.24

* Value not quoted as structure not similar to other hydroperoxides

The identity of fraction 1 is **109** from spectroscopic evidence. Fractions 2 and 3 are the stereoisomers **90A** and **90B** however spectroscopic evidence does not indicate which is which as was the case with the cyclooctenyl system.

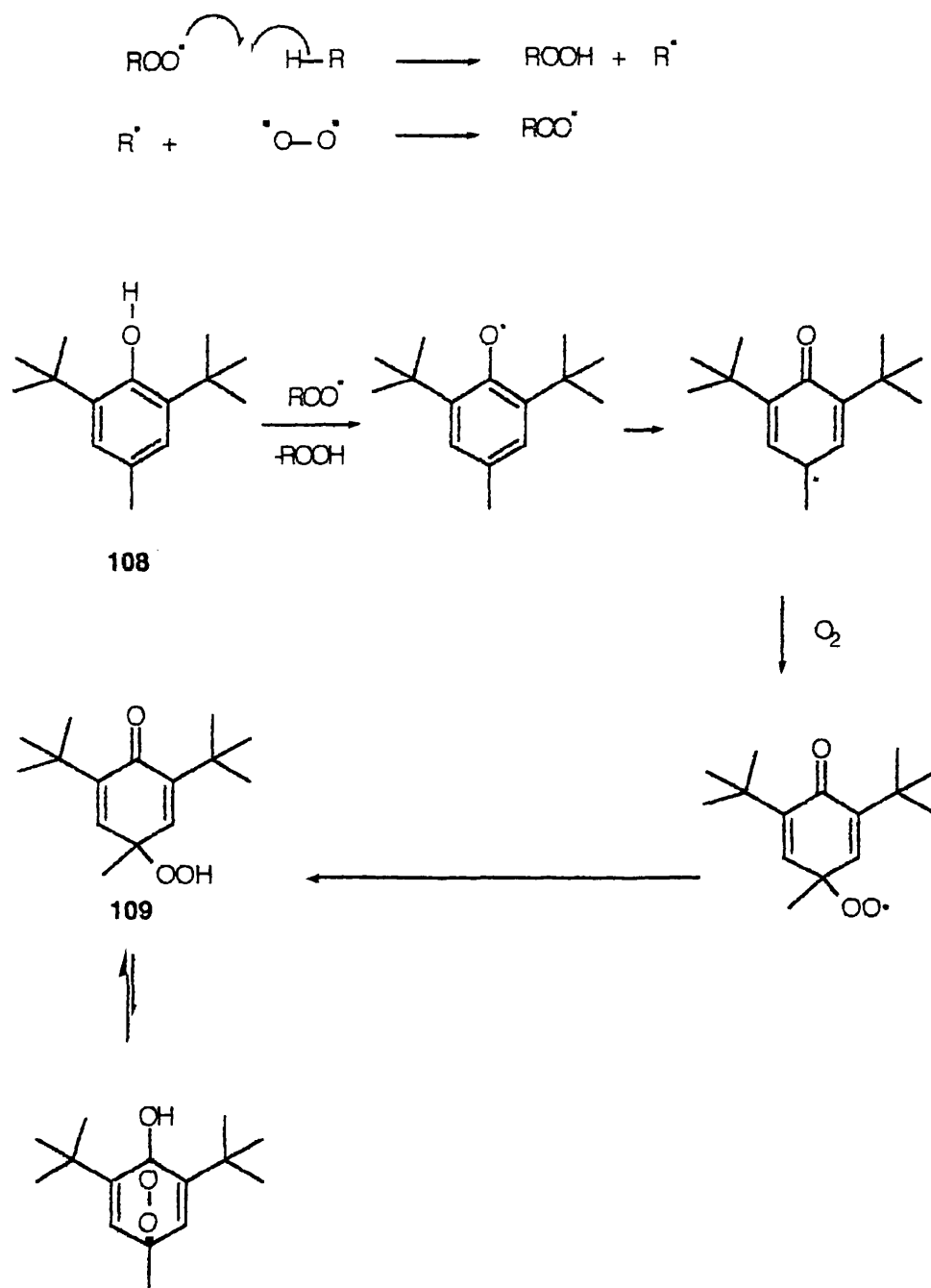

Scheme 2.10. The mechanism of formation of 109. BHT appears to trap oxygen centred radicals and inhibits free radical chain reaction..

2.2.2 Preparation of derivatives and authentic materials.

Because we were initially working with hydroperoxide mixtures in both the seven and eight membered ring series it was necessary to prepare derivatives which provided evidence of the proposed structures. Also it was desirable to have authentic samples of the bicyclic ethers that we hoped to produce in the

oxygen transfer chemistry with the derived dialkylperoxonium ions. This section discusses the preparation of these hydroperoxide derivatives and the preparation of the authentic bicyclic ethers.

2.2.2.1 Alcohol, ketone and triphenylmethanol derivatives

We were aware of a report by Davies⁶⁸ of the tendency of certain allylic hydroperoxides to rearrange in the presence of polar solvents. In order to confirm the identity of our hydroperoxide mixtures we felt it would be useful to make the alcohols and ketones and to perform the interconversions shown in scheme 2.11.

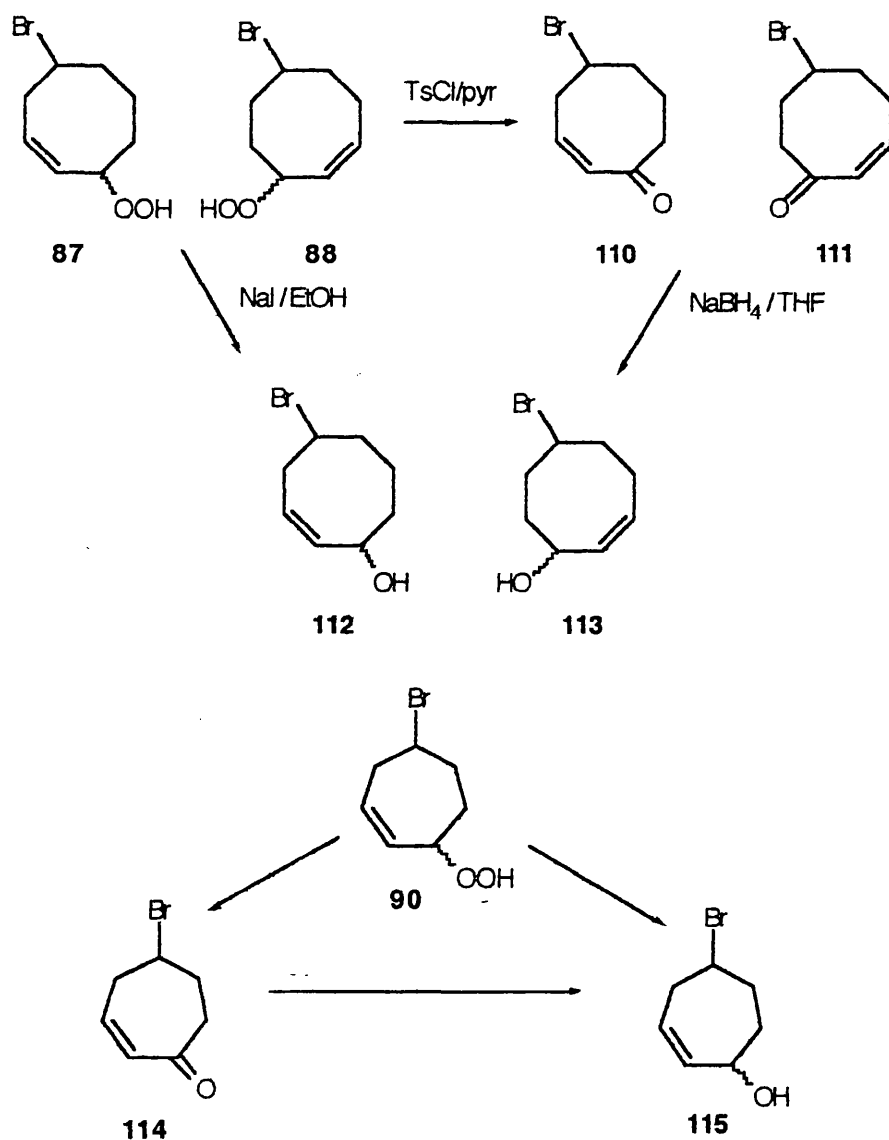

Scheme 2.11 Ketone and alcohol interconversions

We had hoped to prepare the ketones **110/111** by the use of the Corey and Suggs pyridinium chlorochromate reagent (PCC) to perform the conversion **112/113**→**110/111**⁶⁹. Treatment of the alcohols **112/113** with PCC gave intractable tars with the loss of bromine as evidenced by the ¹³C NMR. We therefore used Porter's method to obtain the ketones from the hydroperoxides directly **87/88**→**110/111**. p-Toluenesulfonyl chloride was used as the oxidising agent. The reported mechanism of action is:

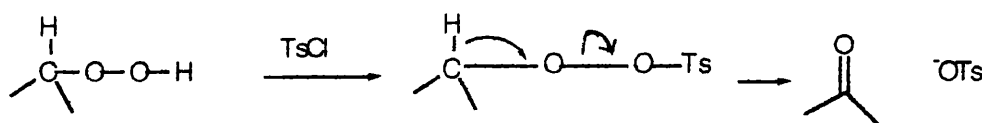

Scheme 2.12 Hydroperoxide to ketone conversion with p-tosyl chloride

This reagent presented no difficulty when 4-cyclooctenyl hydroperoxide was oxidised to the ketone as a model but the bromocyclooctenyl hydroperoxides gave a large number of different products as assessed by ¹³C NMR and TLC. Purification by column chromatography and detection of the ketones with 2,4-dinitrophenylhydrazine spray lead to the clean isolation of the required ketones, albeit in modest yield. The procedure was also adopted for the conversion **90**→**114**.

We attempted to convert the mixture of ketones to alcohols **110/111**→**112/113** and **114**→**115** by use of sodium borohydride but found that under ambient conditions this was also accompanied by reduction of the bromide group. However treatment of the ketones with sodium borohydride at low temperature gave the expected mixture of alcohols as compared to the mixture obtained by *direct* reduction of the hydroperoxides to the alcohols namely **87** and **88**→**112** and **113** and **90**→**115**. Because we were working with *bromohydroperoxides* we were unable to use the usual reagent for the direct reduction of the hydroperoxides namely lithium aluminium hydride (alkyl bromides are reduced to alkanes) or triphenyl phosphine (complexes with alkyl bromides to form the phosphonium salt). Sodium iodide in acidified ethanolic solution provided a suitable alternative:

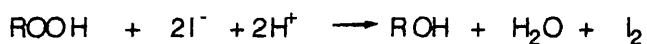

Scheme 2.13 Hydroperoxide reduction with iodide ion

We attribute the low recovery in our reactions to the small amounts used rather than to any incompleteness of reaction.

We also prepared the trityl derivatives of the bromocyclooctenyl hydroperoxides by the method of Davies⁷¹. To be absolutely certain of the stereochemistry and the regiochemistry of the individual hydroperoxides we had hoped to make crystalline derivatives suitable for X-ray crystallography. Although the separated **87A** and **87B** and **88A** and **88B** each gave the trityl derivatives they did not readily crystallise except after repeated precipitation from ethanol/ light petroleum. The chemical shift of the tertiary carbon of the trityl group in the ¹³C NMR was in good agreement with that reported for the trityl derivative of propyl hydroperoxide prepared by Bloodworth. The crystals that were obtained from this trityl derivative preparation were unfortunately much too small for X-ray crystallography. However a sample suitable for microanalysis was obtained.

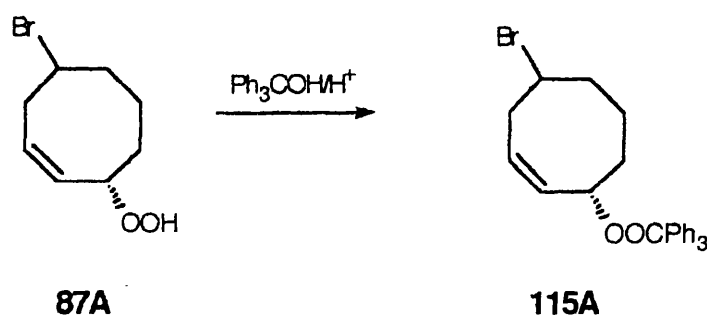

Scheme 2.14.

2.2.2.2 Synthesis of bicyclic ethers

Because we anticipated that the hydroperoxide mixture **87/ 88** would afford a complicated mixture of the bicyclic ethers **94** and **96** as well as products arising from the incorporation of trifluoroacetate (from *cis* isomers **87B** and **88B**) it was decided to prepare authentic samples of the bicyclic ethers **94** and **96** for comparison. These were prepared by the route of Paquette and Storm^{72,73} and Bordwell and Douglass⁷⁴.

4-Cycloocten-1-ol **85** was prepared from 5-acetoxy-6-acetoxy-mercuriocyclooctene **117** formed from the treatment of cycloocta-1,5-diene **86** and mercuric acetate.

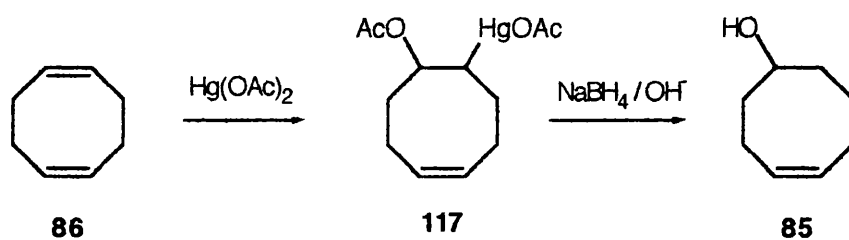

Scheme 2.15 4-cycloocten-1-ol preparation

Mercury (II) acetate mediated cyclisation of of **85** gave predominantly the kinetic product alkylmercury (II) acetate **118**. Mercury (II) nitrate mediated cyclisation of **85** gave predominantly the thermodynamic product alkylmercury (II) nitrate **120**. Anion exchange of **118** and **120** with potassium iodide in base followed by iododemercuration with iodine in carbon tetrachloride afford a mixture of the *cis* and *trans* alkyl iodides **119** and **121**. In both cases **118**→**119** and **120**→**121** the reaction is proposed to proceed by a free radical mechanism. Dehydrohalogenation of **119** and **121** with potassium tertiary butoxide afforded a mixture of the bicyclic ethers. Only the predominant bicyclic ether formed is depicted in the scheme (scheme 2.16). These reactions are not regiospecific.

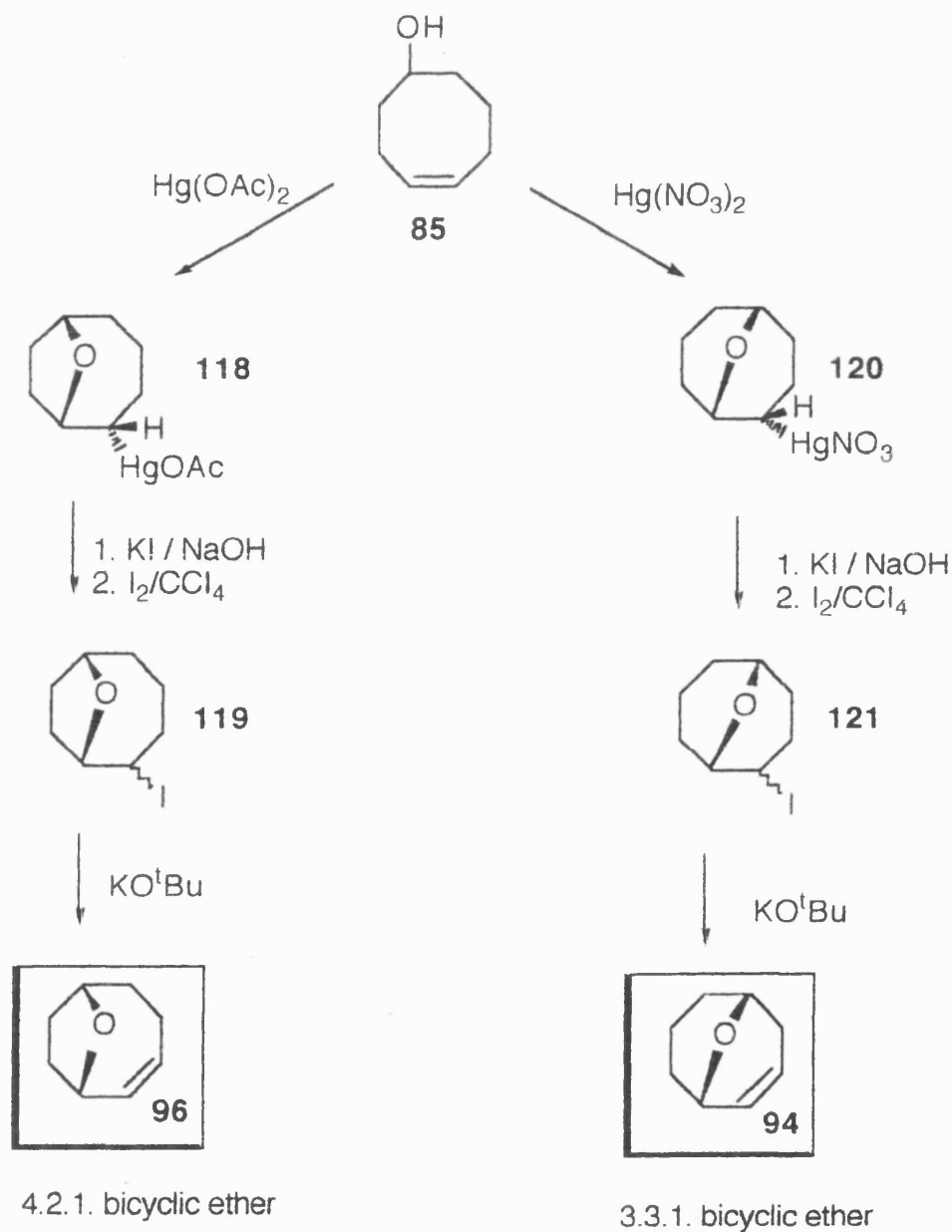

Scheme 2.16 Bicyclic ether synthesis.
 Only the predominant product from each reaction is shown

Assignment of the individual isomers present in the mixtures of alkyl iodides was made by comparison with the ^{13}C NMR spectra of authentic samples of the *trans* iodides prepared by M. D. Spencer.⁷⁵ Relative ratios of the individual compounds was made by comparison of the ratios of average peak heights of methylene carbons in the ^{13}C NMR spectrum.

Ratios of iodides from both routes		
<u>starting materials</u> →		
	120	118
<u>products</u> ↓		
4.2.1 <i>cis</i> 119B	nil	2.2
4.2.1 <i>trans</i> 119A	3.3	1.0
3.3.1 <i>cis</i> 121B	2.0	nil
3.3.1 <i>trans</i> 121A	1.0	nil

Ratios of bicyclic ethers		
<u>starting materials</u> →		
	119A & 121B & 121A	119B & 119A
<u>products</u> ↓		
4.2.1 ether 96	1.5	10.0
3.3.1 ether 94	1.0	1.0

In work on the seven membered ring system the bicyclic ether 8-oxabicyclo {3.3.1} -oct-2-ene **92** was required and was prepared in a similar fashion to **96**. Treatment of the alcohol **103** with buffered mercury (II) acetate followed by anion exchange with potassium iodide afforded 8-oxabicyclo-{3.2.1}-octan-2-ylmercury (II) iodide **122** in a one pot reaction. Iododemercuration afforded 2-iodo-8-oxabicyclo{3.2.1}octane **124** as a mixture of *endo* and *exo* isomers in the ratio 1 to 4.5. Dehydrohalogenation gave the desired bicyclic ether **92**.

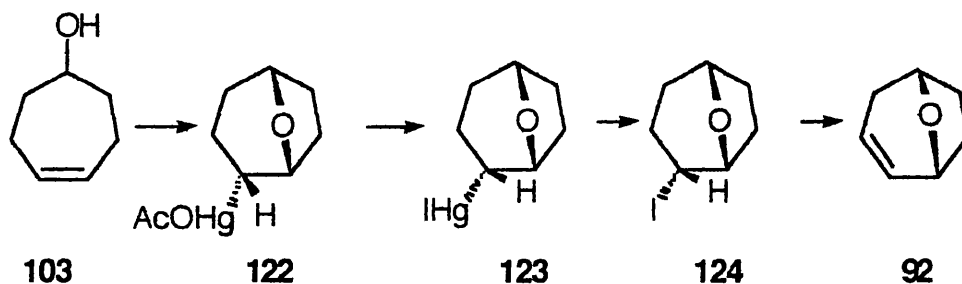

Scheme 2.17 Bicyclic ether synthesis

2.3 Reactions of the hydroperoxides

To demonstrate that dialkylperoxonium ions have been formed in the reactions of bromohydroperoxides it is necessary to show that a product consistent with their intermediacy has been formed. Further evidence is provided if the proposed intermediate is capable of transferring oxygen to a suitable substrate. To show that the dialkylperoxonium ion is an *activated* species when compared to the hydroperoxide from which it is derived, a differential reactivity with respect to oxygen transfer must be shown. Finally in the case of our systems the formation of the dialkylperoxonium ion is accompanied by the formation of trifluoroacetic acid. Protonated hydroperoxides are known to be better electrophilic oxidising agents than the hydroperoxides from which they are derived so it is also necessary to demonstrate a differential reactivity between the protonated hydroperoxides and the dialkylperoxonium ions.

Firstly the formation of bicyclic ethers from the hydroperoxides **87** and **88** is shown in the absence of an oxidisable substrate. Secondly the ability to transfer oxygen from these species to phenyl methyl sulfoxide is shown. Thirdly the non-reactivity of the hydroperoxides is shown under conditions under which the dialkylperoxonium ions effect oxidation. Finally the {4.2.1} bicyclic ether **96** formed from the bromocyclooctenyl hydroperoxide **88A** is shown not to rearrange to the {3.3.1} bicyclic ether **94**.

2.3.1 Hydroperoxides with silver salt and no oxidisable substrate

In the cyclooctenyl system, treatment of a mixture of the hydroperoxides **87** and **88** gave the bicyclic ethers **94** and **96** as well as other products that appear to have resulted from the incorporation of trifluoroacetate. We conclude this because of the presence of a characteristic quartet for the CF₃ quartet in the ¹³C NMR at 159.05 ppm. The individual components of the reaction mixtures were not isolated but their ¹³C NMR spectra compared with the authentic compounds prepared previously. In the cycloheptenyl system hydroperoxides **91A** and **91B** were separated prior to treatment with silver trifluoroacetate. In the absence of an oxidisable substrate only **91A** was capable of forming bicyclic ether **92** *cis* hydroperoxide **91B** did not form **92** only a product which had incorporated trifluoroacetate as evidenced by a quartet at 160 ppm. We noted that in all the reactions where bicyclic ether formation occurred it was not clean and other products are formed as assessed by ¹³C NMR spectroscopy.

2.3.2 Hydroperoxides with silver salt and sulfoxide

In order to provide evidence for the intermediacy of the dialkylperoxonium ions, previous workers have relied on the formation of products consistent with their intermediacy. Further evidence has been provided by Melvin^{57,76} who has demonstrated oxygen transfer to a suitable substrate. Her results suggest that dialkyl peroxonium ions are electrophilic in character, Furthermore she could not find any evidence to support the existence of the deprotonated species (dioxygen ylid) in her systems. We considered that phenyl methyl sulfoxide would be suitable as an oxidisable substrate as the product sulfone cannot be oxidised further and is not too easily oxidised (c.f. the sulfide). Melvin has already performed a Hammett study⁵⁷ on the reactivity of the dialkylperoxonium ions and shown that sulfoxides are suitable substrates.

The bromocyclooctenyl hydroperoxide mixture was treated with three equivalents of phenyl methyl sulfoxide and one equivalent of silver trifluoroacetate. At the end of the reaction the product balance was assessed by ¹³C NMR. For comparison an authentic sample of phenyl methyl sulfone was prepared by a literature method.⁷⁷ When the mixture of bromocyclooctenyl hydroperoxides was used the ratio of sulfoxide to sulfone was 5.2:1. Using the following calculation:

If x is the number of equivalents of ROOH that transfer oxygen to PhSOME then $(3-x)$ equivalents of PHSOME remain (when 3 equivalents of sulfoxide present initially)

ie ratio $(3-x)/x = \text{sulfoxide in final mixture} / \text{sulfone in final mixture}$

$$\therefore \quad 3/x - 1 = 5.2/1$$

$$\therefore \quad 3/x = 6.2$$

$$\therefore \quad 3/6.2 = x \quad x=0.48 \text{ ie } 48\%$$

This suggests that 48% of the hydroperoxide mixture is performing electrophilic oxygen transfer through the intermediacy of the dialkylperoxonium ions **93A**

and **95A** Importantly, the bicyclic ethers **94** and **96** were also formed, although the separation and isolation of these bicyclic ethers was not possible.

In the cycloheptenyl system again three equivalents of phenyl methyl sulfoxide and one of silver trifluoroacetate were employed. The ratio of sulfoxide to sulfone in the final product was 7.2:1. Hence using the same calculation as above we estimate that 37% (see above calculation) of the mixture **90A/90B** transferred oxygen via dialkylperoxonium ion **91A**. HPLC suggested that the ratio of *trans/cis* hydroperoxides is 3:1. The separated hydroperoxide **90B** does not form dialkylperoxonium ion **91A**. Hydroperoxide **90A** forms bicyclic ether **92** from which we infer **91A** is the intermediate. The separated bromocyclooctenyl hydroperoxides **87A** and **88A** have been shown to transfer oxygen *efficiently* through dialkylperoxonium ions **93A** and **95A**. We presume that **90A** will be equally efficient at transferring oxygen via **91A** suggesting that *minor* fraction, fraction 2 is the *trans* hydroperoxide **90A** and the *major* fraction, fraction 3 is the *cis* hydroperoxide **90B**

Reactions of the separated hydroperoxides.

Treatment of the *individual* bromocycloheptenyl hydroperoxides **87** and **88** showed a remarkable difference in the reactivity with phenyl methyl sulfoxide.

HPLC fraction 3, shown by NMR spectroscopy to be **88A** or **88B**, did *not* form bicyclic ether when treated with silver trifluoroacetate alone. Sulfone formation but *not* bicyclic ether formation occurred when HPLC fraction 3 was treated with phenyl methyl sulfoxide and silver trifluoroacetate. The yield of sulfone was calculated to be 20% of the theoretical. It is thus presumed that this is *cis* hydroperoxide **88B** and that it *inefficiently* oxidises sulfoxide.

HPLC fraction **2A** did form the bicyclic ether **96** and the efficiency of phenyl methyl sulfoxide oxidation was calculated to be 95%. We thus presume that this is *trans* hydroperoxide **88A** and that it *efficiently* oxidises sulfoxide via peroxonium ion **95A**.

HPLC fraction **4B** (compound **87A** or **87B**) formed a trace of bicyclic ether **94** but sulfone was formed in only 12% yield. We thus presume that this is *cis* hydroperoxide **87B**.

HPLC fraction **2B** formed bicyclic ether **94** and sulfone in a yield of 65%. We thus presume that this is *trans* hydroperoxide **87A**.

These results suggest that the *trans* hydroperoxides are fractions **2A** and **2B**. The concomitant oxidation of sulfoxide to sulfone accompanied with bicyclic ether formation suggests the intermediacy of the dialkylperoxonium ions **93A** and **95A**. This is a reasonable assumption given that ring closure of hydroperoxy bromides only occurred with the *trans* hydroperoxy bromide **31** to afford the vicinal product peroxide **33**. (see chapter 1).

It is somewhat surprising that the efficiency of the peroxonium ion **95A** is higher than that of **93A** and that the *cis* hydroperoxides perform some (limited) oxidation. This could be oxidation from a species other than the hydroperoxide

2.3.3 The difference in the apparent efficiency of the dialkylperoxonium ions

We had considered the possibility that our peroxonium ions might rearrange to give products that themselves are *inefficient* at transferring oxygen. In the case of the dialkylperoxonium ion **95A** arising from the hydroperoxide **88A** an allylic rearrangement will result in the same ion after rearrangement.

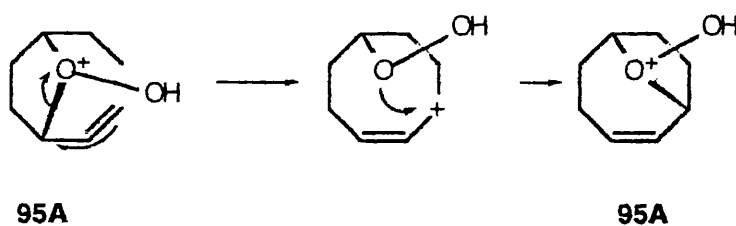

Scheme 2.18 Allylic rearrangement of **95A**.

The same is not true for dialkylperoxonium ion **93A**. In this case the formation of the bicyclic peroxide **124** is possible. This rearrangement to form another product could explain the reduced efficiency of the dialkylperoxonium ions derived from the hydroperoxide **87A**.

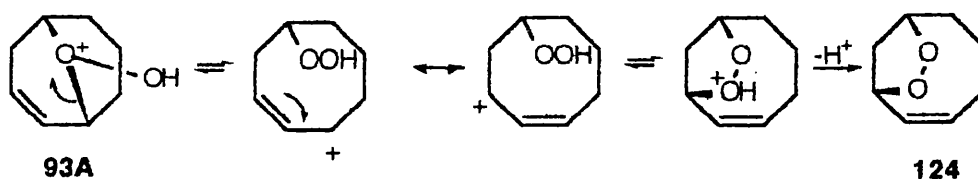

Scheme 2.19 Allylic rearrangement of **93A**

An alternative scenario is that bicyclic ether formation directly from hydroperoxide **87A** might be more favourable than from **88A** and this would explain the *apparent* reduction in efficiency of peroxonium ion **93A**. As neither bicyclic peroxide was isolated or detected by spectroscopy these points are purely speculation.

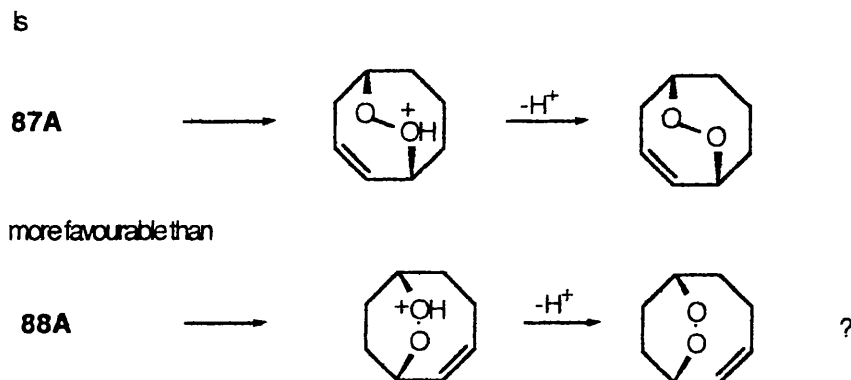

Scheme 2.20

2.3.4 Enhancement of oxygen transfer ability of hydroperoxides by protonation

One problem that we envisaged in assessing the efficiency of oxygen transfer by these hydroperoxides was the generation of trifluoroacetic acid. On treatment of an hydroperoxy alkyl bromide with silver trifluoroacetate, silver bromide and trifluoroacetic acid can be formed, if oxygen transfer and subsequent bicyclic ether formation have occurred. Trifluoroacetic acid itself can enhance the reactivity of hydroperoxides by protonation.

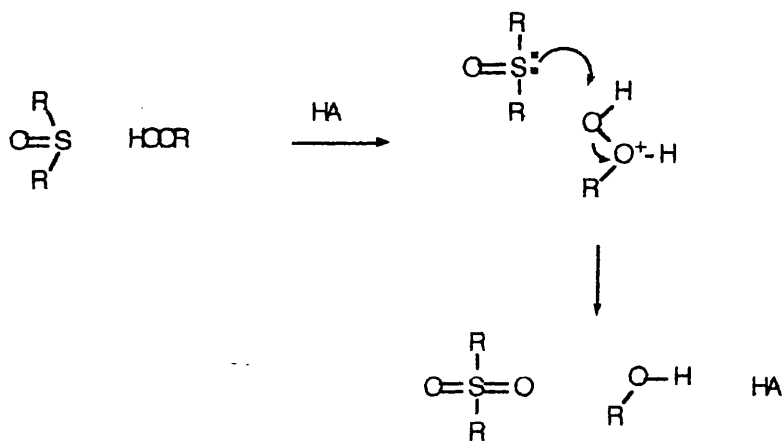

Scheme 2.21. Oxidation of a sulfoxide by a protonated hydroperoxide

In order to check whether enhancement of hydroperoxide oxidation of sulfoxide to sulfone was occurring by protonation, we treated the mixture of bromocyclooctenyl hydroperoxides with one equivalent of phenyl methyl sulfoxide and one equivalent of trifluoroacetic acid but no silver trifluoroacetate. This is the theoretical maximum amount of acid produced in the reaction of the bromocyclooctenyl hydroperoxides with silver salt. Under these conditions no oxidation of sulfoxide to sulfone was observed in the time scale that the hydroperoxides **87** and **88** with silver trifluoroacetate effected oxidation. Similarly for the bromocycloheptenyl hydroperoxides **90** no sulfoxide formation was observed with sulfoxide and trifluoroacetic acid in the absence of silver trifluoroacetate.

2.4 Summary

In summary the combination of chemical (oxygen transfer and bicyclic ether formation) and spectroscopic (proton single-frequency off-resonance decoupling) evidence confirms the stereochemistry and positional isomerism of each of the fractions.

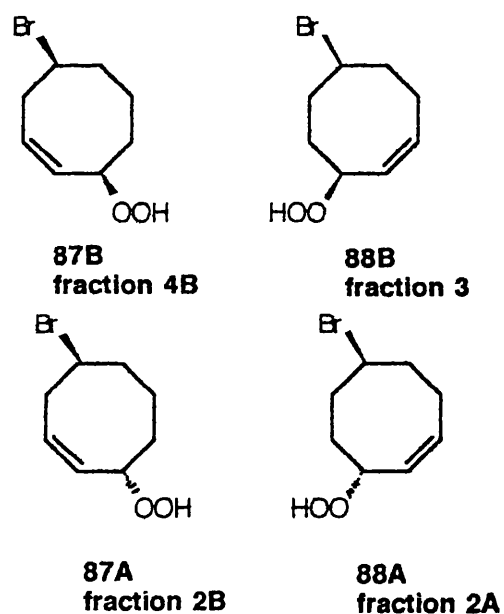

Under the conditions selected the oxidation of phenyl methyl sulfoxide proceeds not by the hydroperoxides **87** and **88** or **90** but by the dialkyl peroxonium ions **93A/95A** and **91A** produced by treatment of the hydroperoxides with silver trifluoroacetate.

In the absence of silver trifluoroacetate but presence of trifluoroacetic acid these hydroperoxides are incapable of performing oxidations of phenyl methyl sulfoxide suggesting the enhancement of oxidation is not due to protonation of the hydroperoxides.

Because we were unable to prove independently that a particular HPLC fraction of hydroperoxide was *cis* or *trans* we established the regioisomerism of each fraction by SFORD and compared the difference in chemical reactivity of each pair **87A/87B** and **88A/88B** to indicate the stereochemistry. We noted that limited oxidation did occur with the *cis* isomer but that the difference in reactivity of each isomer made assignment quite conclusive.

In the cycloheptenyl system a similar result was observed. As the *trans* bromocyclooctenyl hydroperoxides **87A** and **88A** were efficient at transferring oxygen to sulfoxide via a dialkylperoxonium ions we presumed that *trans* hydroperoxide **90A** is similarly efficient. As the *overall* efficiency of the mixture is only 37% this suggests that *minor* fraction, fraction 2 is **90A** and *major* fraction, fraction 3 is **90B**.

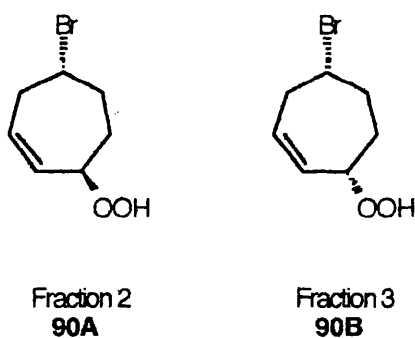

Finally the *overall* efficiency of oxidation is relatively poor in these systems because of the presence of the unreactive *cis* isomers.

2.5 Experimental

Unless otherwise stated NMR spectra were recorded in deuterated chloroform. Proton NMR spectra were obtained with Jeol PMX 60, Varian XL200 or Varian VXR 400 NMR spectrometers. Infra red spectra were recorded with a Perkin Elmer 983 instrument in solutions of carbon tetrachloride with potassium bromide cells. Mass spectra were obtained using a VG 7070 F/H mass spectrometer with Finnigan Incos data system. TLC was performed on Merck silica gel glass or aluminium backed plates and column chromatography performed with Merck 70/230 silica. Flash chromatography was performed with Fluka 220/440 grade silica gel. Peroxide detection was achieved by spraying TLC plates with acidified ferrous thiocyanate spray. General compound detection was achieved with p-anisaldehyde spray or phosphomolybdic acid. Melting points were determined on a Reichert hot stage microscope. Microanalysis was performed by the Microanalytical department at University College.

5-cyclohepten-1yl carboxylic acid **101**

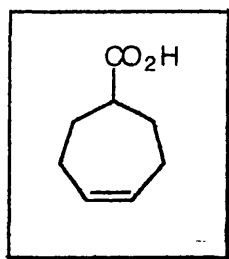

5-Cyclohepten-1yl carboxylic acid **101** was prepared by the method of Stork and Landesman⁷⁸ and recrystallised from pentane

¹H NMR: δ 0.40-1.80 (9H, m), 2.85 (2H, s) 4.8-5.2 (1H, s, br)

¹³C NMR : δ 182.72, 131.58, 46.99, 29.00, 26.55.

IR: 3019, 2930, 1705, 1546, 1442, 1414, 1313, 1295, 1178, 1121, 1059, 942 cm^{-1}

mp 68-69 °C (lit. m.p. 65-67 °C)

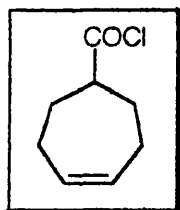
5-cyclohept-1-en carbonyl chloride 104

5-cycloheptene carboxylic acid (5.59 g 0.040 mol) was dissolved in sodium dried benzene (100 mL) under nitrogen. Dimethylformamide (5 drops) was then added followed by oxalyl chloride (29.1 g, 0.229 mol) dropwise over 1h. The solution was left to stir for a further 3h. The reaction mixture was then concentrated on a rotary evaporator at room temperature. A further portion of anhydrous benzene was then added at room temperature and the solution reconcentrated with warming at 30 °C. The crude acid chloride was then purified by bulb to bulb distillation (8mm Hg, 145 °C) to afford **104** as a light brown oil (4.18 g, 26mmol, 66%,).

^1H NMR: δ , 1.6-1.8 (4H, m), 1.9-2.4 (4H, m), 2.85-3.25 (1H, m), 5.65-5.95 (2H, m)

^{13}C NMR: δ , 176.75, 131.30, 58.90, 29.29, 26.08.

IR (neat): 1791 2935 2887, 2840, 3020, 776, 740, 684 cm^{-1} .

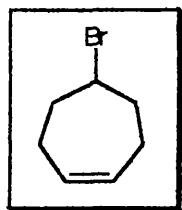
5-cyclohept-1-enyl bromide 89 (photolytic conditions)

Bromotrichloromethane (50 mL, 0.507 mol) was placed in a 250 mL water jacketed 2 neck round bottomed flask with 2-mercaptopyridine-N-oxide sodium salt (4.730 g, 31.7 mmol) under nitrogen with 4-dimethylaminopyridine (300 mg, 2.46 mmol). 4-cyclohept-1-enyl carbonyl chloride **104** (4.20 g, 26.4 mmol) was added dropwise over 10 min whilst the solution was cooled by the water jacket and irradiated with a 500W tungsten lamp. The solution turned bright yellow after 3 min and this colour dissipated after 1h. The solution was

irradiated for a further 1h and then left to stand under N₂ overnight. The reaction mixture was then filtered through Celite[®] and the filtrate concentrated. Column chromatography on silica gel (220 g) eluting with pentane gave the bromide **89** (2.24g, 48%) as a colourless oil, 2-pyridyl-trichloromethyl sulfide and 2,5-dibromo-1-trichloromethyl cycloheptane.

5-cyclohepten-1-yl bromide 89

R_f : pentane 0.53

¹H NMR(200 MHz): δ 1.10 - 2.24 (8H, m) 4.42 - 4.51 (1H, m) 5.76-5.80 (2H, m)

¹³C(50 MHz): δ 131.58, 57.73, 37.04, 25.49 .

2-pyridyl-trichloromethyl sulfide .

R_f: pentane 0.0 (the yield of this product was not determined but the material was obtained by scraping from the top of the column after solvent elution and dissolving in fresh solvent)

¹H NMR(200 MHz): δ 7.70 (2H, m), 7.75 (1H, d), 8.65 (1H, d)

¹³C NMR: δ 152.63, 150.13, 137.24, 129.70, 124.30, 96.28

2,5-dibromo-1-trichloromethyl-cycloheptane

(mixture of two isomers)

Yield: 2.57 g 6.88 mmol

R_f: pentane 0.40

¹H NMR: 0.9-3.2 (10H,m), 4.8-5.2 (1H, m, br)

¹³C(50MHz): δ 103.53, 103.22, 68.72, 67.88, 56.44, 52.26, 53.67, 52.09, 35.25, 36.87, 34.61, 36.77, 29.86, 33.30, 24.63, 24.63, 28.18

5-cyclohepten-1-yl bromide 89 (thermal conditions)

2-Mercaptopyridine-N-oxide sodium salt (4.710 g, 31.6 mmol) was placed in a 3-neck round bottomed flask with bromotrichloromethane (50 mL, 0.507 mol) and 4-dimethylaminopyridine (330 mg, 2.70 mmol). The flask was fitted with a Dean Stark trap and addition funnel containing 4-cyclohepten-1-yl carbonyl chloride **104** (4.18 g, 26.3 mmol) in bromotrichloromethane (10 mL). The reaction mixture was refluxed for 2 h followed by the addition of the acid halide over 10 min during this time the colouration of the solution to bright yellow and the effervescence of carbon dioxide was observed. This colour then dissipated and the solution was refluxed for a further 10min. The solution was allowed to cool and filtered through Celite[®] and concentrated. Column chromatography on silica gel (165g) eluting with pentane gave the bromide **89** (2.24 g, 48%) as a colourless oil and 2-pyridyl-trichloromethyl sulfide (not isolated see previous preparation) and 2,5 dibromo-1-trichloromethyl cycloheptane **106** (0.570 g).

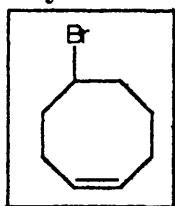
4-cycloocten-1-yl bromide 82

This was prepared by the method of Ziegler and Wilms⁵⁸ from cycloocta-1,5-diene **86** and hydrogen bromide in glacial acetic acid. (45% w/v)

Yield: 21% b.p. 64-66 °C/ 3 mm Hg

Repeat: Yield 63% (lit. b.p. 84-85 °C/ 100 mm Hg⁷⁹)

¹H NMR 1.0-3.1 (10H, m), 4.2-4.8 (1H, m), 5.4-6.1 (2H, m)

¹³C NMR: 129.57, 129.19, 55.61, 39.7, 37.11, 27.04, 25.30, 25.22.

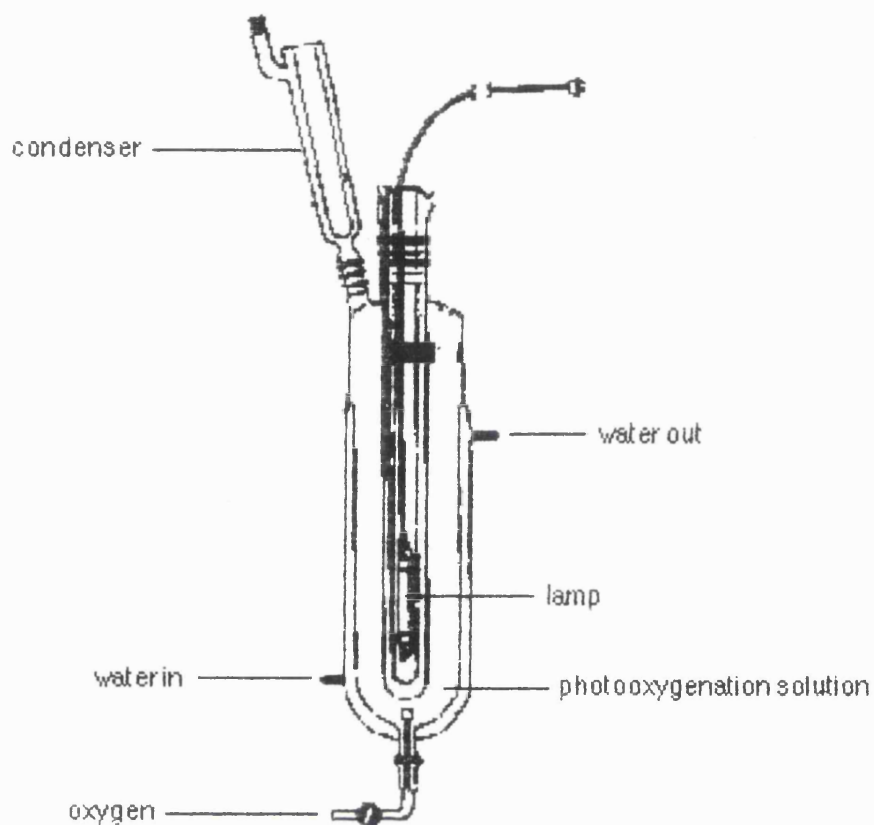
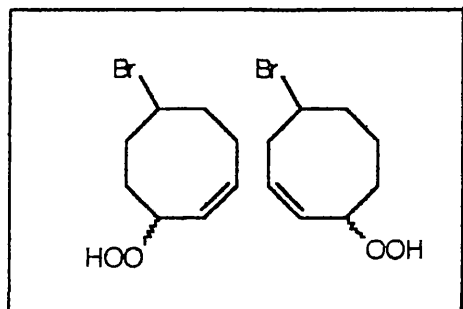

Fig 2.10 Immersion cell apparatus

The immersion cell apparatus consisted of a water jacketed pyrexTM immersion cell fitted with a standard ground glass joint for condenser attachment and a glass frit at the base for the introduction of oxygen. The volume of the reaction vessel was approximately 350 mL. The lamp was a 200W medium pressure sodium lamp made by Hanovia

5-bromo- and 6-bromo -1-hydroperoxy cyclooct-2-ene 87 & 88

4-Bromocyclooct-1-ene **82** (0.954 g, 5.05 mmol) and meso-tetraphenylporphine (0.010 g 1.64×10^{-4} mol) were dissolved in dichloromethane (350 mL) and placed in the immersion cell described. Oxygen was gently bubbled through the immersion cell which was irradiated with a 400W sodium lamp. The apparatus was covered in foil to reflect light back into the reaction mixture. The progress of the reaction was monitored by TLC and after a period of 8h the solution was cooled and concentrated to afford an oil (1.30 g). Column chromatography with dichloromethane/methanol 10/1 gave the hydroperoxide mixture **87 & 88** (1.12 g 5.06 mmol, 100%)

R_f: CH₂Cl₂/ MeOH 10/1 0.85

¹H (200 MHz): δ 8.30-8.31 (1H, s), 5.4-5.85 (2H, m, br), 4.2-4.6 (1H, m, br), 1.2-2.8 (8H, m, br)

¹³C (50 MHz): δ 134.75, 134.47, 131.20, 130.82, 129.18, 128.79, 126.78, 125.61, 83.41, 83.22, 82.31, 81.16, 54.59, 54.54, 54.22, 53.98, 38.82, 38.41, 37.04, 36.37, 36.29, 36.13, 35.23, 34.34, 33.05, 32.47, 31.57, 29.82, 26.43, 26.08, 21.88, 20.50.

MS:(EI) (M-OH) + 189/91 (M-OOH)+ 173/175

Acc Mass obs 188.9894 calcd for C₈H₁₂⁷⁹Br₁O₁ 188.9915

Separation of the bromocyclooctenyl hydroperoxides was performed by Mr S. J. Corker of University College using two 250 mm x 10 mm 5μm silica gel columns in series with 90% hexane / 10% ethyl acetate (Romill High Purity) as eluant. Injection volume was 25μL and a sufficient number of injections were made in order to collect enough material for subsequent reaction of the

individual isomers with phenyl methyl sulfoxide. The amounts shown are the amounts of individual isomers isolated and give an indication of the constitution of the original hydroperoxide mixture. These are in agreement with the amounts calculated by analysis of the ^{13}C NMR of the crude mixture. A typical HPLC trace is shown (page 46).

Ratios of the bromocycloctenyl hydroperoxides

fraction #	87A	88B	88A	87B
	2B	3	2A	4B
Calcd by NMR:	1.38	2.50	1.00	0.83
Calcd by HPLC area:	1.22	2.50	1.00	0.99

Fraction 3: *cis* 6-bromo-1-hydroperoxycyclooct-2-ene 88B

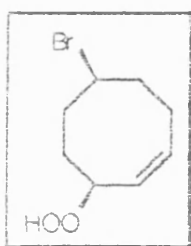

^{13}C (50MHz): δ 130.69, 129.06, 81.09, 54.53, 38.30, 35.14, 29.74, 26.34.

^1H (400MHz): δ 1.35-1.48 (2H, m), 1.95-2.12 (2H, m), 2.13-2.28 (2H, m), 2.28-2.42 (2H, m), 4.15-4.25 (1H, m), 4.97-5.07 (1H, m), 5.45-5.55 (1H, m) and δ 5.78-5.88 (1H, m)

Irradiation (SFORD) at δ 4.2 (C^6H) simplifies the multiplet at δ 1.95-2.12 (C^4H and C^5H) and at δ 2.28-2.42 (C^4H and C^7H)

Irradiation (SFORD) at δ 5.81 (C^3H) simplifies the multiplet at δ 5.45-5.55 (C^2H) and at δ 2.28-2.42 (C^4H). (The multiplets at δ 2.28-2.42 and δ 1.95-2.22 contain one proton each of the group C^4H_2)

Irradiation (SFORD) at δ 5.50 (C^2H) simplifies the multiplet at δ 4.97-5.07 (C^1H) and δ 5.78-5.88 (C^3H)

Irradiation (SFORD) at δ 5.02 (C^1H) simplifies the multiplet at δ 1.35-1.48 (C^8H) and δ 5.45-5.55 (C^2H)

Fraction 2B: ***trans*-5-bromo-1-hydroperoxycyclooct-2-ene 87A**

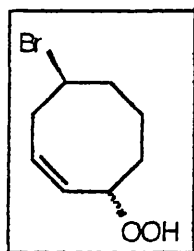

^1H (400MHz): δ 0.79-2.28 (6H, m), 2.68-2.78 (2H, m), 4.07-4.17 (1H, m), 4.18-4.23 (1H, m), 4.84-4.90 (1H, m), 5.59-5.66 (1H, m), 5.73-5.78 (1H, m)

^{13}C (50MHz): δ 134.79, 126.86, 83.27, 53.92, 37.10, 36.23, 31.64, 20.59

Irradiation (SFORD) at δ 4.20 (C^5H) simplifies the multiplet at δ 2.73 (C^4H_2).

Irradiation (SFORD) at δ 5.62 (C^3H) also simplifies the multiplet at δ 2.73 (C^1H)

Irradiation (SFORD) at δ 5.75 (C^2H) simplifies the multiplet at δ 4.87 (C^1H) but not at δ 2.73 (C^4H)

Fraction 2A: ***trans*-6-bromo-1-hydroperoxycyclooct-2-ene 88A**

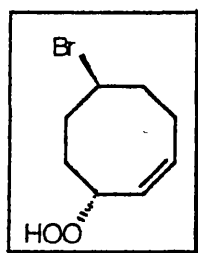

^1H (400MHz): δ 1.42-1.55 (2H, m), 1.95-2.30 (4H, m), 2.31-2.43 (2H, m), 4.29-4.35 (1H, m), 5.01-5.27 (1H, m), 5.58-5.71 (2H, m)

^{13}C (50MHz): δ 131.22, 128.83, 82.36, 54.18, 38.86, 33.11, 30.45, 26.12.

Irradiation (SFORD) at δ 4.32 or δ 5.65 did NOT cause collapse of the multiplets at δ 5.58-5.71 or δ 2.31-2.43.

Fraction 4B: *cis*-5-bromo-1-hydroperoxycyclooct-2-ene 87B

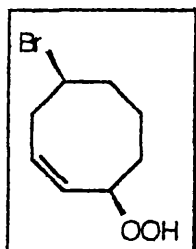

^{13}C (50MHz): δ 134.47, 125.72, 83.45, 54.54, 36.36, 34.42, 32.52, 21.94.

^1H (400MHz): δ 1.32-1.48 (2H, m), 1.82-2.08 (3H, m), 2.12-2.23 (1H, m), 2.68-2.78 (2H, m), 4.32-4.42 (1H, m), 4.72-4.82 (1H, m), 5.78-5.89 (2H, m).

Irradiation at δ 5.83 (C^2H and C^3H) causes collapse at δ 4.72-4.82 (C^1H) and δ 2.68-2.78 (C^4H_2).

Irradiation at δ 4.35 (C^5H) causes collapse at δ 2.68-2.78 (C^4H) and δ 2.12-2.23 (C^6H).

ketone 4A

^1H (400MHz): δ 1.30-2.50 (6H, m), 2.63-2.88 (2H, m), δ 3.17-3.27 (1H, m), 4.32-4.42 (1H, m), 6.32-6.42 (1H, m), 6.18-6.28 (1H, m)

IR(CCl_4): 1600cm^{-1}

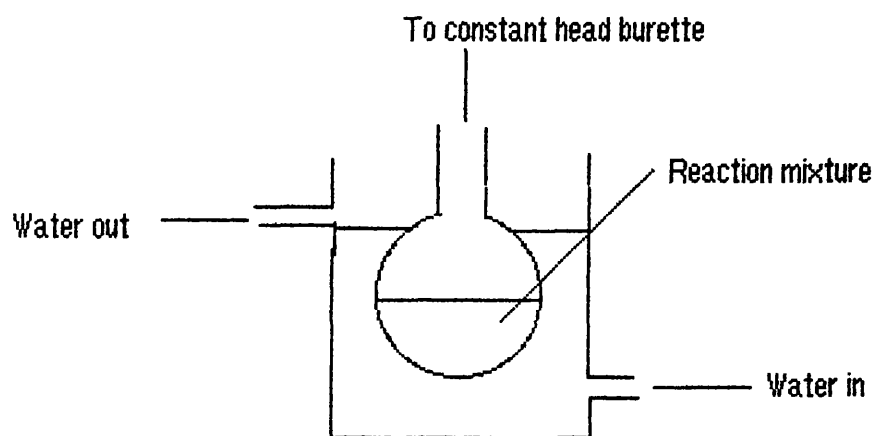
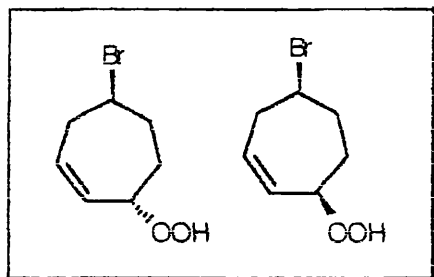

Figure 2.9 Schematic of singlet oxygenation apparatus

Singlet oxygenation of alkene **89** was performed by irradiation of a 20mL round bottomed vessel surrounded by a constant head water cooled beaker at a lamp to vessel distance of 5cm. The vessel was provided with magnetic stirring and was connected to a burette containing oxygen maintained at a pressure of 1 atm.

1-hydroperoxy-5-bromocyclohept-2-ene **90**



5-Bromocyclohept-1-ene **89** (0.492 g 2.81 mmol), BHT **109** (0.062 g, 0.281 mmol) and meso tetraphenylporphine (0.010g 1.62×10^{-5} mol) were dissolved in dichloromethane (10 mL) and injected into the apparatus described. The flask was irradiated with a 400W sodium lamp at a distance of 5 cm. and the progress of the reaction monitored by the uptake of oxygen. When oxygen uptake had ceased irradiation was stopped and the reaction mixture concentrated. HPLC gave three products.

Analytical HPLC conditions:

Mobile phase: 60/40 water/acetonitrile

Support: Phase Sep ODS 2-5 μm 250 mm x 4.6 mm ID

Column detector: UV at 210 nm 0.5 AUFS

Flow rate 1 mL min^{-1}

Injector Valco C6W fitted with 10 μL loop.

A representative HPLC is shown. Preparative HPLC was performed using a large scale analogous version column to that employed for the analytical HPLC. Purity of the individual isomers isolated by preparative HPLC was checked by analytical HPLC after isolation.

Workup of the HPLC fractions was achieved by concentration of the solutions extraction of the remaining water layer into dichloromethane (1 x 100 mL) + (3x 50mL), drying with magnesium sulfate, concentration and removal of solvent. Yields shown give an idea of the relative proportion of each isomer and agree

well with a comparison of an estimate of peroxide ratios obtained by integration of HPLC peak areas.

Fraction 1: 2,6-di-*tert*-butyl-4-methyl-4-hydroperoxycyclohexa-2,5-dien-1-one 109

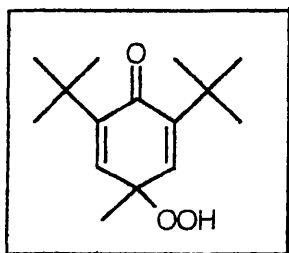

28mg

^1H (200MHz): δ 1.70 - 3.15, 3.59, 4.39-4.46, 6.02-6.05, 6.32-6.38,

^{13}C (50MHz): δ 140.63, 133.40, 70.34, 48.26, 40.60, 39.61.

95% purity by HPLC

Fraction 2: *cis* 1-hydroperoxy-5-bromocyclohept-2-ene 90B

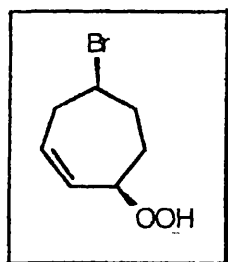

54 mg peroxide test positive

^1H (200MHz): δ 1.77-2.78, 4.31-4.37, 4.52-4.56, 5.60-5.67, 5.88-5.92, 8.45-8.70.

^{13}C (50MHz): δ 133.57, 127.64, 82.94, 50.98, 37.38, 35.90, 26.97.

94% purity by HPLC

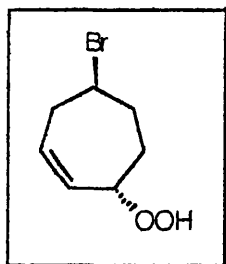
Fraction 3: *trans* 1-hydroperoxy 5-bromocyclohept-2-ene 90A

145 mg peroxide test positive

^1H (200MHz): δ 1.59-2.83, 4.00-4.07, 4.54-4.59, 5.54-5.68, 5.88-5.93. ^{13}C

(50MHz): δ 135.09, 127.11, 83.72, 50.60, 39.24, 38.39, 30.57.

98% purity by HPLC

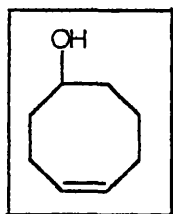
4-cycloocten-1-ol 85

This was prepared by the method of Courtneidge in 52% yield from cycloocta-1,5-diene ^1H and ^{13}C NMR are in agreement with those reported by him.

^{13}C (50MHz): δ 22.73, 24.89, 25.49, 36.21, 37.14, 72.06, 129.06, 129.85

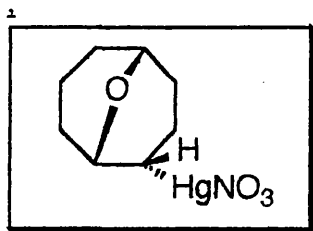
endo 2,6-epoxycyclooctyl mercury(II) nitrate 120

4-Cycloocten-1-ol **85** (2.036 g, 0.016 mol) was added dropwise over 10min to a stirred solution of mercury (II) nitrate monohydrate (4.297 g, 0.0164 mol) and potassium nitrate (1.600 g, 0.016 mol) in water (15 mL) and left to stir overnight. The precipitated product was filtered off washed with ethyl acetate

(10mL) to yield after drying (30 °C, 3 mm, 2 h) **120** (6.02 g, 0.016 mol) as white crystals

^{13}C (50 MHz): δ 70.05, 67.81, 53.76, 33.10, 32.74, 29.18, 26.98, 19.27.

endo 2,6-epoxycyclooctyl mercury(II) iodide

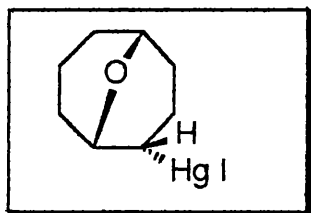

Potassium iodide (66.0 g 0.397 mol) was dissolved in 10% sodium hydroxide solution (100mL). 35mL of this solution was added to a solution of 2,6-epoxycyclooctylmercury(II) nitrate **120** (5.859 g 0.0153 mol) in 10% sodium hydroxide solution (60 mL) over a period of 10 min. The precipitated product was collected by filtration and washed with 98% ethanol (25 mL). The product was then dried overnight to yield white crystals of endo 2,6-epoxycyclooctyl mercury II) iodide (3.310 g, 7.31 mmol, 46%)

^{13}C (50MHz): δ 70.84, 67.64, 65.96, 33.75, 32.98, 29.34, 27.20, 19.61.

2-Iodo-9-oxabicyclo{3.3.1} nonane 121

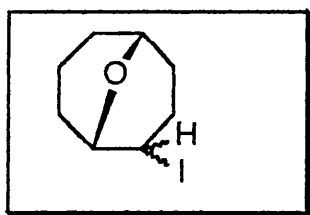

endo 2,6-epoxycyclooctylmercury(II) iodide (3.047 g 6.73 mmol) was dissolved in carbon tetrachloride (160 mL) and cooled to 0 °C. Iodine (1.66g, 6.54 mmol) was added under an atmosphere of nitrogen and the reaction mixture stirred for 8 h. The solids were removed by filtration and the filtrate washed with sodium thiosulfate solution until colourless. The filtrate was then dried with magnesium sulfate and filtered. The filtrate was then concentrated to remove the carbon tetrachloride and afford a mixture of *cis* and *trans* 2-Iodo-9-oxabicyclo{3.3.1} nonane **94** (0.874 g, 3.48 mmol, 52%)

^1H (200MHz): δ 4.45-4.70 (1H, m) 3.75-4.15 (2H, m) 1.12-2.83 (10H, m)

^{13}C (50MHz): δ 421 *trans* iodide 82.66, 76.15, 26.51, 35.58, 34.99, 34.95, 24.92, 24.82. 331 *cis* iodide 73.49, 66.07, 34.35, 30.50, 28.89, 27.82, 25.54. 331 *trans* iodide 70.19, 65.48, 32.61, 32.53, 31.55, 28.43, 24.80, 17.99

Isomer ratios estimated from peak heights of saturated CH_2 carbons 421 *trans* iodide 3.3/ 331 *cis* iodide 2.0 331 *trans* iodide 1.0; assignments of *cis* and *trans* made by comparison with figures for authentic *trans* iodides independently prepared by M. D. Spencer

4-cyclohepten-1-yl acetate 102

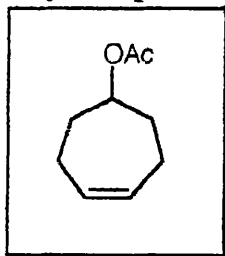

This was prepared by the method of Cope et al.⁶¹ from 4-cyclohepten-1-yl carboxylic acid in a yield of 15% (lit, yield 70%)

^1H NMR: δ 1.1-2.2 (8H,m), 4.0 (1H,m), 5.3 (2H, s, br)

^{13}C NMR : δ 169.685, 131.182, 75.412, 31.670, 22.594, 20.943

4-cyclohepten-1-ol 103

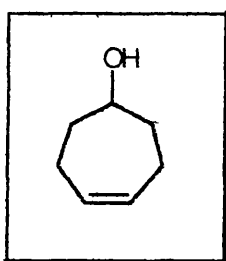

This was prepared by the method of Cope⁶¹ from 102

^1H NMR: 1.46 (2H, m), 1.70-2.50 (m, 6H), 3.73 (1H, t x t), 4.32 (1H,s) (disappeared on shaking with D_2O), 5.69 (2H, m)

^{13}C NMR :131.812, 131.624, 126.034, 73.753, 35.220, 22.825

4-cyclohepten-1-yl bromide 89

This was prepared by the method of Cope et al⁶¹ in 5 % yield (c.f. Walton's procedure⁶⁷)

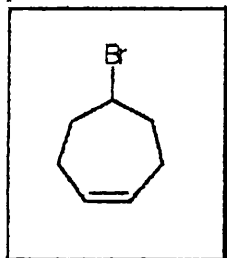

^{13}C NMR : 25.76, 37.35, 57.81, 131.78

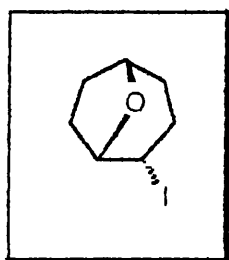
***trans*-2-iodo-8-oxabicyclo-{3.2.1}octane 124A**

This was prepared by the method of Paquette et al⁷² from 4-cyclohepten-1-ol **103** in 14% yield as a mixture with **124B**

^{13}C NMR : δ 79.93, 74.64, 34.47, 31.81, 29.58, 28.50, 25.52

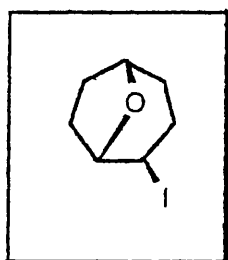
***cis*-2-iodo-8-oxabicyclo-{3.2.1}octane 124B**

^{13}C NMR : δ 80.31, 75.43, 33.70, 29.36, 28.40, 27.57, 27.18

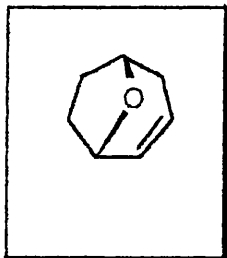
8-oxabicyclo{3.2.1}oct-2-ene 92

This was prepared from 124A & 124B by the method of Paquette⁷² in 84% yield.

¹³C NMR : δ 132.31, 122.47, 73.43, 72.69, 35.34, 34.76, 29.86

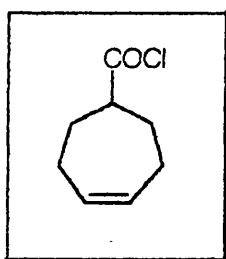
4 cyclohepten-1-yl carbonyl chloride 104

¹³C NMR : δ 176.75, 131.30, 58.90, 29.20, 26.08.

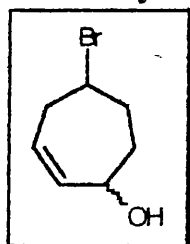
5-bromocyclohept-2-en-1-ol 115

Hydroperoxides **90A** and **90B** (0.165 g, 0.80 mmol.) were dissolved in a mixture of absolute alcohol (10 mL) and anhydrous ether (1 mL). Sodium iodide (0.671 g, 4.04 mmol) was added with vigorous stirring for 4h. Anhydrous ether (3 mL) was then added and the mixture washed with saturated sodium thiosulfate (3 x 5mL) and water (1 x 5mL). The ethereal layer was then dried with magnesium sulfate, filtered and concentrated to afford **115A** and **115B** (0.089 g, 0.43 mmol, 54%)

^1H NMR: δ 1.2-1.8 (6H, m), 3.8-4.2 (1H, m), 4.2-4.6 (1H, m), 5.4-5.7 (1H, m), 5.7-6.1 (1H, m).

^{13}C NMR: δ 140.61, 138.77, 125.65, 71.17, 70.59, 51.23, 50.66, 39.76, 39.32, 37.33, 36.83, 36.99, 32.18.

The relative ratio of *trans/cis* isomers was calculated from the relative intensity of the methylene peaks for each of the isomers.

MS: M^+ 190.0009 obsd. 189.9994 calcd. for $\text{C}_7\text{H}_{11}^{79}\text{BrO}$
191.9946 obsd. 191.9974 calcd. for $\text{C}_7\text{H}_{11}^{81}\text{BrO}$

M-Br 111

M-Br- H_2O 93

Others 84, 77, 67, 55, 43.

5-bromocyclohept-2-en-1-one 114

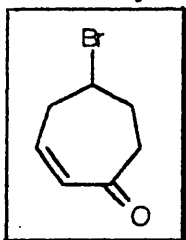

The mixture of hydroperoxides **90A** and **90B** was dissolved in pyridine (2 mL) and p-tosyl chloride (0.250 g, 1.30 mmol) was added to the solution with vigorous stirring. After 3h the reaction mixture was poured into dichloromethane (20 mL). This organic layer was washed with 2M hydrochloric acid (3 x 20 mL) and then copper sulfate until no colour change was observed in the copper sulfate layer (3 x 5mL). The organic layer was dried with magnesium sulfate filtered and concentrated to afford 5-bromocyclohept-2-en-1-one (0.074 g, 0.39 mmol, 48%)

^1H NMR: δ 1.4-2.2 (6H, m), 4.3-4.5 (1H, m), 5.9-6.1 (1H, m), 6.3-6.6 (1H, m).

^{13}C NMR: 203.30, 141.55, 135.07, 48.09, 39.75, 29.36, 29.33.

MS: M^+ 187.9836 Obsd. 187.98368 calcd. for $\text{C}_7\text{H}_9^{79}\text{BrO}$

189.9799 Obsd. 189.98168 calcd. for $C_7H_9^{81}BrO$

M-Br 109

Br+ 79/81

Others 68, 53/55, 39/41.

IR: neat 1674, 786, 761 cm^{-1}

5-bromo-cyclooct-2-en-1-ol 112 and 6-bromocyclooct-2-en-1-ol 113

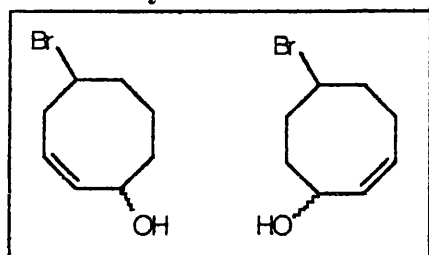

The hydroperoxide mixture **87** and **88** (0.191 g, 0.864 mmol) was dissolved in absolute alcohol (10 mL) and anhydrous ether (1 mL). Sodium iodide (0.655 g 4.37 mmol) was then added with stirring overnight. Anhydrous ether (30 mL) was then added and the organic layer was washed with saturated sodium thiosulfate (3 x 5mL) and water (1 x 5mL). The organic layer was then dried with magnesium sulfate filtered and concentrated to afford a mixture of the alcohols (0.094 g, 0.456 mmol, 53%).

^{13}C NMR: δ 138.32, 138.28, 138.24, 133.16, 128.80, 128.52, 127.23, 124.02, 70.02, 69.65, 68.75, 67.32, 54.97, 54.65, 54.40, 54.36, 39.39, 39.29, 38.25, 37.28, 37.15, 36.51, 36.15, 36.08, 35.98, 35.93, 35.37, 34.29, 33.58, 26.58, 25.86, 22.17.

MS: M+ 204.0142 Obsd 204.0150 calcd for $C_8H_{13}^{79}BrO$
 206.0159 Obsd 206.0131 calcd for $C_8H_{13}^{81}BrO$

M-Br 125

M-HBr 124

M-H₂O 187/189

Others 107/109 95, 91, 81, 67, 55, 41, 27.

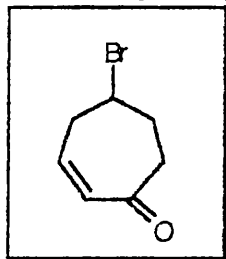
6-bromocyclohept-1-en-3-one 114

^{13}C NMR: δ 203.30, 40.61, 29.36, 141.55, 39.75, 29.33, 135.07.

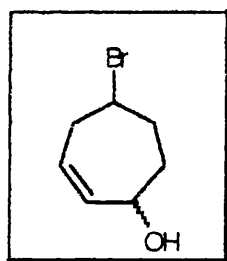
6-bromocyclohept-1-en-3-ol 115

^{13}C NMR: δ 140.61, 138.77, 125.95, 125.65, 71.17, 70.59, 51.23, 50.66, 39.76, 37.33, 36.83, 35.99, 32.18, 39.32

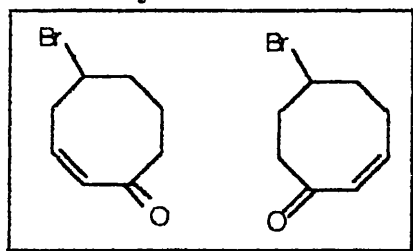
5-bromocyclooct-2-ene-1-one 110 and 6-bromocyclooct-2-en-1-one 111

The hydroperoxides **87** and **88** (0.401 g, 1.81 mmol) were dissolved in pyridine (4 mL) and p-tosyl chloride (0.470 g, 2.47 mmol) was added in one portion with vigorous stirring. The reaction mixture was left to stir overnight and the mixture was then diluted with dichloromethane (20 mL) washed with 2M hydrochloric acid (3 x 20 mL), saturated copper sulfate (2 x 20 mL) and saturated sodium chloride (1 x 10 mL). The organic layer was then dried with magnesium sulfate, filtered and concentrated to afford 0.285 g material. The product was then columned on silica with dichloromethane to afford a mixture of the ketones **110** and **111** (0.740 g, 0.36 mmol, 20%)

R_f: 0.43 dichloromethane.

¹H NMR: δ 1.5-3.2 (8H, m), 4.25-4.25 (1H, m), 6.2-6.6 (2H, m)

¹³C NMR: δ 202.31, 200.68, 139.35, 138.65, 137.14, 128.19, 53.64, 49.21, 41.2, 41.24, 37.42, 32.97, 32.61, 31.95, 27.96, 20.97.

MS: M+ ⁷⁹Br 202.0020 Obsd 201.99932 Calcd

MS: M+ ⁸¹Br 203.99732 Obsd 203.998732 Calcd

M-Br 123

Br+ 79/81

Others 95, 68, 55, 39, 27.

IR: 787 (very br) 1664 1724 cm⁻¹

Trityl derivatives

The individually separated isomers were each treated with triphenylmethanol in glacial acetic acid with a catalytic amount of sulfuric acid according to the method of Davies⁷¹.

115B

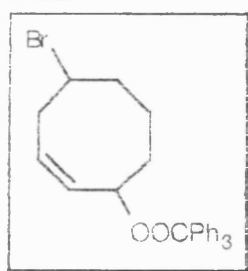

This was prepared from hydroperoxide **87B** (HPLC fraction 4B).

¹H NMR(400MHz): δ 0.95-1.05 (1H, m), 1.08-1.25 (1H, m), 1.45-1.80 (3H, m), 1.80-1.95 (2H, m), 2.25-2.40 (1H, m), 2.40-2.55 (1H, m), 3.92-4.02 (1H, m), 4.15-4.28 (1H, m), 5.55-5.75 (2H, m), 7.24-7.45 (16H, m).

¹³C NMR: δ 21.68, 32.19, 34.28, 36.23, 127.38, 55.09, 81.33, 127.28, 127.53, 129.05, 124.13, 135.10, 143.05.

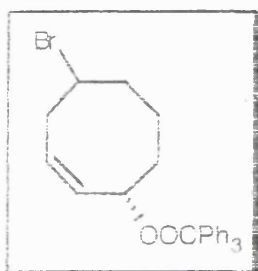
115A

This was prepared from **87A** (HPLC fraction 2B)

^1H NMR(400MHz): δ 1.08-1.79 (6H,m), 2.01-2.11 (1H,m), 2.23-2.35 (1H,m), 2.50-2.58 (1H,m), 3.97-4.08 (1H,m) 4.08-4.15 (1H,m), 5.39-5.49 (1H,m) 5.53-5.63 (1H,m), 7.24-7.45 (16H, m).

^{13}C NMR: δ 20.83, 31.16, 36.45 37.08, 54.27, 80.93, 127.33, 127.90, 127.56, 129.04, 125.51, 135.33, 143.03

Calcd for $\text{C}_{27}\text{H}_{27}\text{O}_2\text{Br}_1$: C 69.98, H 5.87 Found C 69.61, H 5.78

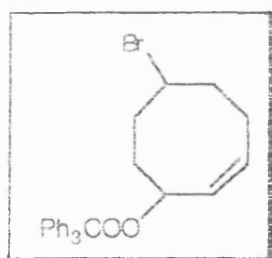
116B

This was prepared from **88B** (HPLC fraction 3)

^1H NMR(400MHz): δ 1.10-1.23 (1H,m), 1.47-1.65 (2H,m), 1.75-2.23 (5H,m), 3.78-3.88 (1H,m), 4.16-4.28 (1H,m) 5.33-5.44 (1H,m), 5.54-5.68 (1H,m), 7.24-7.45 (16H,m).

^{13}C NMR δ 26.53, 29.684, 35.23, 38.67, 54.27, 79.01, 127.28, 127.54, 129.00, 127.38, 127.39, 130.10, 142.99.

Reaction of 87/88 with silver trifluoroacetate

Hydroperoxides **87** and **88** (0.310 g, 1.4mmol) were dissolved in dichloromethane (10 mL). Silver trifluoroacetate (0.333 g, 1.5 mmol) was added in one portion with vigorous stirring for 30 min at ambient temperature and then the mixture was

transferred to a glass centrifuge tube and spun at high speed. The supernatant was then pipetted off and concentrated and then redissolved in CDCl_3 . The products were inferred by comparison with authentic materials.

Reaction of 90A with silver trifluoroacetate

90A was dissolved in dichloromethane (5 mL) in a round bottomed flask fitted with magnetic stirrer. Silver trifluoroacetate (0.170 g 0.77 mmol) was then added in one portion with vigorous stirring. After 30 min the suspension was transferred to a glass centrifuge tube and spun for 5 min. The supernatant was pipetted off and concentrated. The concentrate was dissolved in CDCl_3 for ^{13}C NMR which was recorded immediately. The products were inferred by comparison with authentic materials.

Reaction of 90B with silver trifluoroacetate

The procedure adopted for **90A** was repeated for *cis* hydroperoxide **90B** using **90B** (0.054 g, 0.26 mmol), silver trifluoroacetate (0.063 g, 0.29 mmol). The products were inferred by comparison with authentic materials.

Reaction of the cyclooctenyl hydroperoxides with phenyl methyl sulfoxide and silver trifluoroacetate.

The hydroperoxides (amounts shown in table) were dissolved in dichloromethane (5 mL) with stirring and 3 equivalents of phenyl methyl sulfoxide added. This was *immediately* followed by silver trifluoroacetate with stirring for 30 mins. The reaction mixture was then filtered under suction through a short pad of Celite, concentrated and dissolved in CDCl_3 . The ^{13}C NMR was then immediately recorded.

The reaction was performed on fraction 3, 4B and combined fraction 2A/2B. The reaction was also performed on the separated isomers 2A and 2B. The amount of phenyl methyl sulfoxide and phenyl methyl sulfone in the final product mixture were then calculated by comparing peak heights in the ^{13}C NMR. The extent of the oxidation was calculated by assuming that should the reaction go to completion the starting 3 equivalents of phenyl methyl sulfoxide will yield 1 equivalent of phenyl methyl sulfone with 2 equivalents of sulfoxide remaining. The presence of the bicyclic ethers was confirmed by comparison with authentic samples prepared earlier.

Materials/mg	Hydroperoxide			
	4A	2A	2B	3
Silver trifluoroacetate	74.4	39	42	114
Phenyl methyl sulfoxide	86	50	54	180
Hydroperoxide	48	26	26	95

Cyclooctenyl hydroperoxide with silver salt and phenyl methyl sulfoxide

The same procedure was adopted as described above except a mixture of 2A (**88A**) and 2B (**87A**) was employed. 2A and 2B (0.0275 g, 0.13 mmol), phenyl methyl sulfoxide (0.055 g, 0.392 mmol) and silver trifluoroacetate (0.032 g, 0.145 mmol). This afforded a complex mixture with the formation of bicyclic ethers **96** and **94** as assessed by comparison with authentic materials.

Control reaction of hydroperoxides, phenyl methyl sulfoxide and trifluoroacetic acid

The mixture of hydroperoxides **87** and **88** (0.398 g, 1.80 mmol) was dissolved in dichloromethane (5mL) with stirring. Phenyl methyl sulfoxide (1.134 g, 8.09 mmol) and trifluoroacetic acid (208 mL 2.70 mmol) were then added in rapid succession and the mixture stirred for 30 min. The solution was then concentrated and resuspended in CDCl_3

The constitution of the mixture was then calculated by comparison with the authentic materials.

Control reaction with cycloheptenyl hydroperoxides

The same procedure was adopted for **90** as described above. The amounts used were **90** (0.482 g, 0.233 mmol), phenyl methyl sulfoxide (0.097 g, 0.692 mmol) and trifluoroacetic acid (65 μL , 0.228 mmol)

Confirmation of non rearrangement of 421 ether

The ether **94** was dissolved in CDCl_3 and the ^{13}C NMR recorded. Trifluoroacetic acid was added and the ^{13}C NMR recorded 40h later. This showed that compound **94** remained unchanged.

Preparation of phenyl methyl sulfone

Phenyl methyl sulfone was prepared from thioanisole (methyl phenyl sulfide) from freshly prepared peracetic acid by the method of Bordwell and Pitt⁷⁷ m.p. 87-88.5 °C (lit mp 85-88 °C⁸⁰)

4-bromocycloheptane carboxylic acid

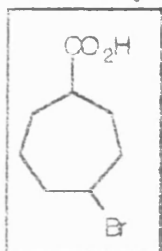

¹H NMR: δ 1.1-2.64 (14H, m), 4.24-4.36 (2H, m), 11.54 (1H, s)

¹³C NMR: δ assigned as cis isomer 22.716, 27.197, 29.681, 36.988, 39.996, 43.710, 55.152, 182.903. assigned as trans isomer 23.621, 26.220, 30.182, 36.457, 40.185, 43.567, 55.029, 182.807.

3. *Ortho* halomethylbenzyl hydroperoxides

3.1 Introduction

The *overall* efficiency of oxygen transfer by the bromohydroperoxides discussed in Chapter 2 was relatively poor. The formation of both *cis* and *trans* hydroperoxides meant that only a proportion of the hydroperoxides was capable of oxygen transfer via dialkylperoxonium ions. We thought that it might be possible to develop an alternative, more efficient system based on the autoxidation of a halomethyl substituted cumene. The liquid phase autoxidation of hydrocarbons is the method of choice in industry for the production of the commonly employed alkyl hydroperoxides t-butyl hydroperoxide, ethylbenzene hydroperoxide and cumene hydroperoxide. The free radical autoxidation of cumene to produce cumene hydroperoxide and thence phenol was described in Chapter 1. We hoped that an autoxidation of the *ortho*-bromomethylcumene **127** would make the hydroperoxide **126** equally accessible.

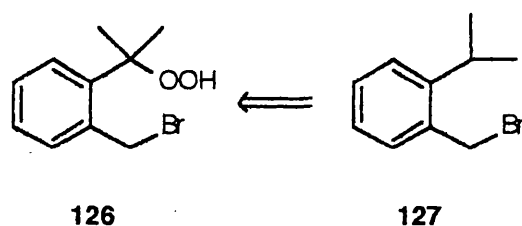

Scheme 3.1

On treatment with a Lewis acid catalyst we could envisage ring closure to form the ether **129** through oxygen transfer from the peroxonium ion **128**. A further advantage of this system would be the presence of the methyl groups enhancing cyclisation through the Thorpe-Ingold effect.

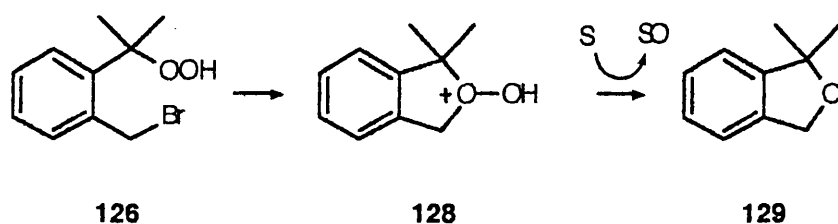

Scheme 3.2

In order to test whether such a system would be accessible by autoxidation we chose *ortho*-isopropylbenzoic acid **130** as the starting point for this work. A

successful procedure for the autoxidation of *ortho*-isopropylbenzoic acid itself would suggest that an *ortho*-substituted halomethyl benzyl hydroperoxide would also be accessible by autoxidation and the hydroperoxy acyl chloride **132** might also be accessible from the autoxidation of *ortho*-isopropyl benzoyl chloride **131**. It was hoped that hydroperoxide **132** would ultimately ring close to form 3, 3-dimethyl phthalide **134** by oxygen transfer from the hitherto unknown acyl alkyl peroxonium ion **133**.

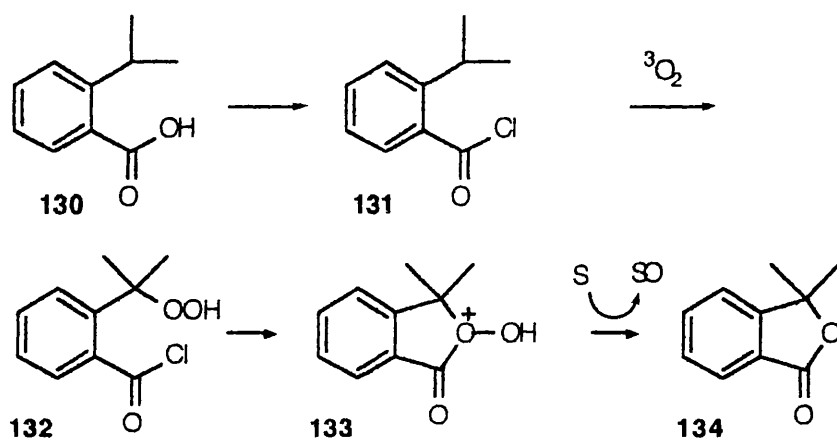

3.2 Synthesis and reaction of *ortho* isopropyl benzoic acid

ortho-Isopropyl benzoic acid **130** was prepared from 1-iodo-2-isopropyl benzene **137** which itself was prepared from *ortho* isopropylaniline **135** via the diazonium salt **136** (Scheme 3.4). *ortho*-isopropyl benzene carbonyl chloride **131** was prepared from the acid **130** with oxalyl chloride by the method described in Chapter 2 for compound **104**.

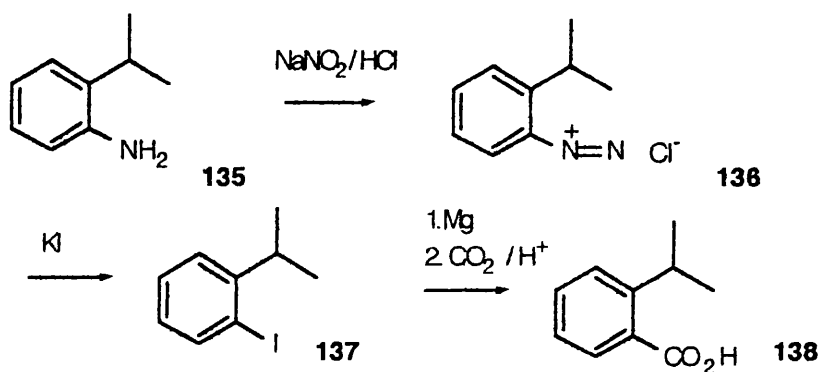

Our initial attempts to autoxidise acid chloride **131** at room temperature with UV irradiation showed no measurable uptake of oxygen occurred over 24 hours and no peroxide was detected by TLC. This is perhaps unsurprising as the rate of reaction of cumenes at room temperature is likely to be quite slow. Synthetically useful amounts of cumene hydroperoxide are only produced under laboratory conditions by irradiating cumene at 85°C with UV or by heating alone in Teepol[®] emulsions⁸¹. An attempt to autoxidise *ortho*-isopropyl benzoic acid itself also gave no peroxidic products. One problem that we had envisaged in these reactions was that should any hydroperoxide **132** or **139** be formed, the presence of trace amounts of water would transform them to salicylic acid **140** which would be inhibitory to the formation of further hydroperoxide.

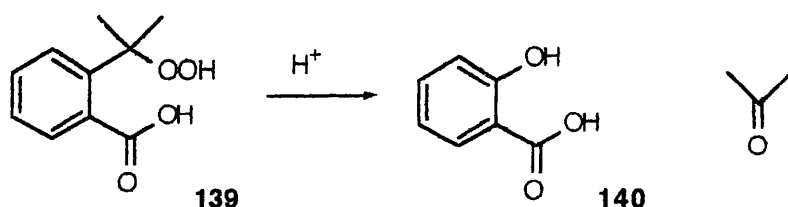

Scheme 3.5 Decomposition of hydroperoxide under acid conditions

Under conditions in which some reaction did appear to take place no peroxide was formed and the several compounds that were formed as assessed by TLC and ¹³C NMR of the crude were inseparable by column chromatography. We thought that one way around the problem of autoinhibition by **140** would be to employ the sodium salt of **138**. Here after attempted autoxidation and workup only starting material was recovered. If any hydroperoxide had been formed in the reaction, during acidic workup we would expect to form salicylic acid **140** but none was observed.

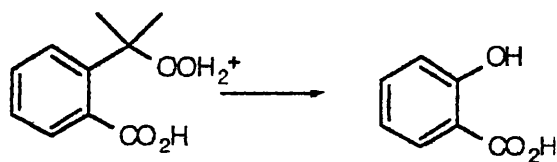

Scheme 3.6

An examination of the literature made the reason for the unreactivity of our compounds apparent. Pritzkow et al.⁹⁰ investigated the oxidisabilities of various hydrocarbons in chlorobenzene at 75°C with AIBN initiator. Whilst cumene is more readily oxidised than toluene under these conditions a *meta* substituent decreases the rate somewhat and an *ortho* substituent leads to a marked decrease.

**Oxidisabilities of alkyl aromatic hydrocarbons at 75°C
solvent: chlorobenzene; initiator AIBN**

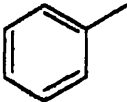
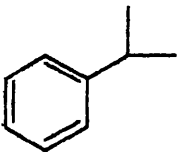
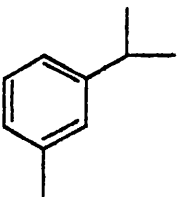
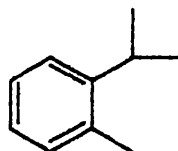
hydrocarbon	relative rate
	0.13
	3.55
	283
	0.71

Investigation of the literature reveals the reason for the non-reactivity of the *ortho* substituted cumenes. *Ortho* substitution inhibits the oxidation of the tertiary C-H bond of the isopropyl aromatic by preventing the coplanar arrangement of all the carbon atoms of the isopropyl radical group with the carbon atoms of the aromatic nucleus. It is this coplanarity that makes possible the resonance stabilisation of the cumyl radical and hence the facile autoxidation of an unsubstituted cumene possible.

For these reasons it would seem that formation of *ortho* substituted cumyl hydroperoxides is likely to be difficult by free radical methods and given the other problems experienced with this system autoxidation as a route to these compounds was not pursued further.

3.3 Heterolytic methods

Organic peroxides are commonly prepared by the nucleophilic substitution reaction of a peroxide reagent at a carbon centre.



(X=OH₂⁺, OSO₂OH, OSO₂OR or OSO₂Me; R² = H or alkyl)

Scheme 3.7 Typical heterolytic reaction to produce a dialkyl peroxide/hydroperoxide

When R¹ is tertiary, R¹X is normally an alcohol or an alkyl hydrogen sulfate. The reaction is typically carried out in the presence of concentrated sulfuric acid and involves an S_N1 mechanism.

Having abandoned attempts to prepare an *ortho* substituted cumyl hydroperoxide by autoxidation we hoped the heterolytic method described above might give us the desired hydroperoxide **173**.

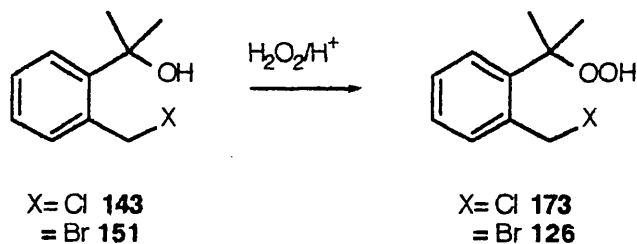

Scheme 3.8

We reasoned that we could prepare the required cumyl alcohol **143** from the parent acid **141** via the following sequence.

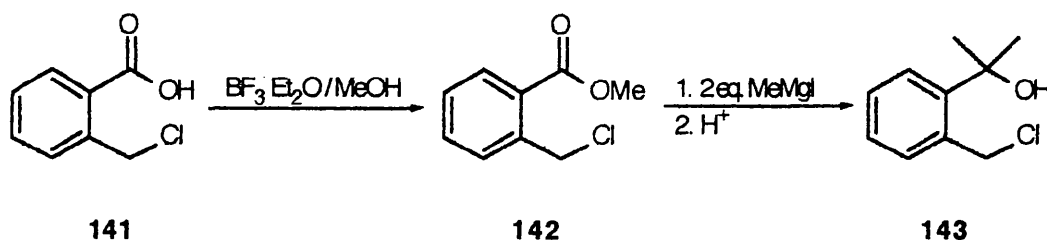

Scheme 3.9

ortho-Chloromethyl benzoic acid **141** was prepared by refluxing *ortho*-toluic acid **150** and suluryl chloride followed by aqueous work up⁸³. The methyl ester **142** was prepared from the carboxylic acid and boron trifluoride etherate complex with a large excess of methanol. The methyl ester was then treated with

two equivalents of methylmagnesium iodide which should have resulted in the desired product. Creary⁸⁴ had previously prepared the para substituted analogue, albeit in only modest yield. In fact we obtained an intractable tar which did not contain any of the desired product as evidenced by ¹³C NMR spectroscopy of the crude product.

We presumed a viable alternative to the above route would be the treatment of *ortho* hydroxymethyl cumyl alcohol **144**, with Corey's DMS/NCS complex⁸⁵.

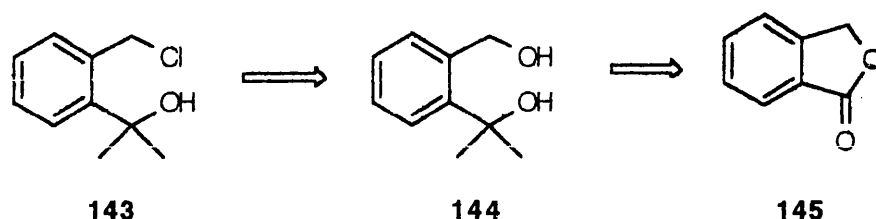

Scheme 3.10 Retrosynthesis for *ortho*-chloromethyl cumyl alcohol

ortho-Hydroxymethyl cumyl alcohol **144** was prepared from phthalide **145** via the Grignard route.

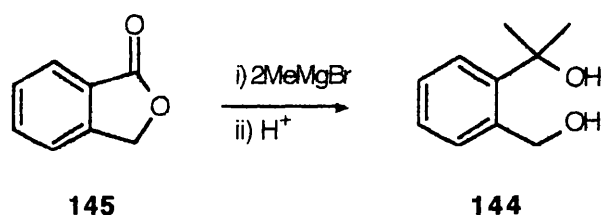

Scheme 3.11

Corey's DMS/NCS reagent is selective for allylic or benzylic hydroxyl groups for replacement with halogen under mild conditions.

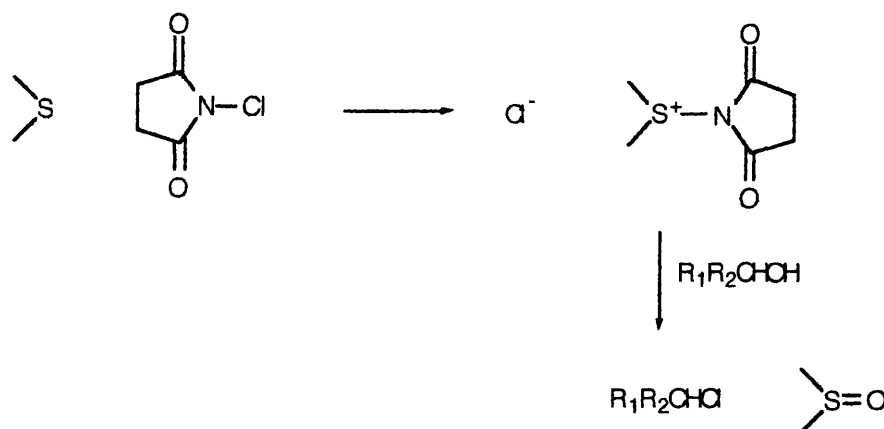

Scheme 3.12 Proposed mechanism for Corey's DMS/NCS reagent

We hoped that although two benzylic hydroxyl groups are available, the primary carbon site would be preferred to the tertiary one in the presence of a limiting amount of the DMS/NCS complex to prepare **143**. We noted that Corey reported that compound **146** did not exhibit the propensity to cyclise to dihydropyran **148** when using DMS/ NCS complex, so we were hopeful that our diol **144** would presumably *not* afford a cyclic ether **129**.

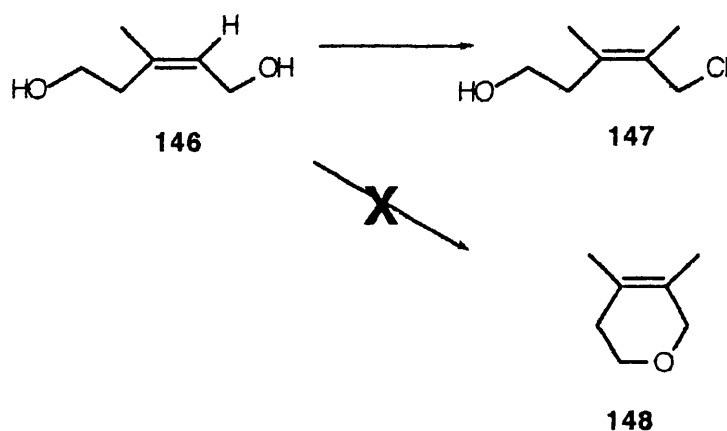

Scheme 3.13 Non cyclisation of diol when using DMS/ NCS reagent

However, the only product obtained from the reaction of *ortho*-hydroxymethylcumyl alcohol **144** was the cyclic ether **129**. We rationalised this result by assuming that intramolecular ring closure is preferred to intermolecular hydrolysis of DMS adduct **174** with chloride ion.

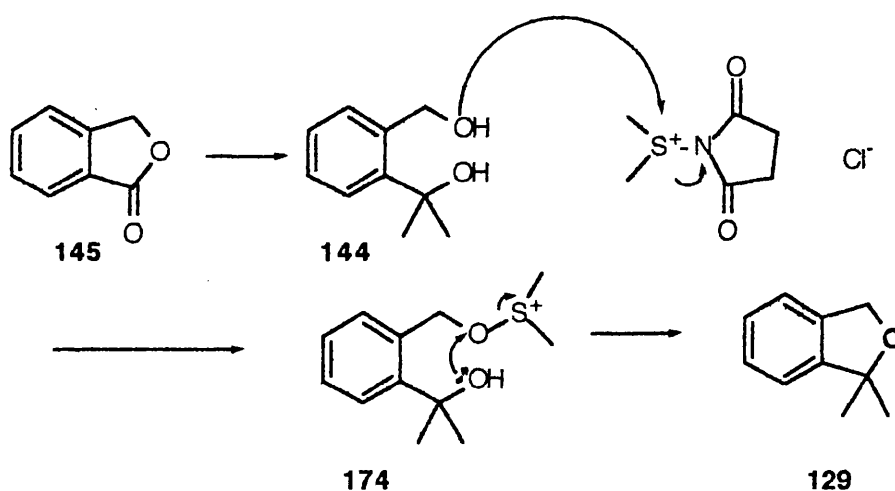

Scheme 3.14 Cyclisation of *ortho*-hydroxymethylcumyl alcohol with DMS/ NCS complex

Our third approach to compound **173** was from *ortho*-chloromethylbenzoyl chloride **149**. Treatment of this compound with two equivalents of methyllithium

should afford the desired product without the problems associated with the use of the Grignard reagent.⁸⁶⁻⁸⁷

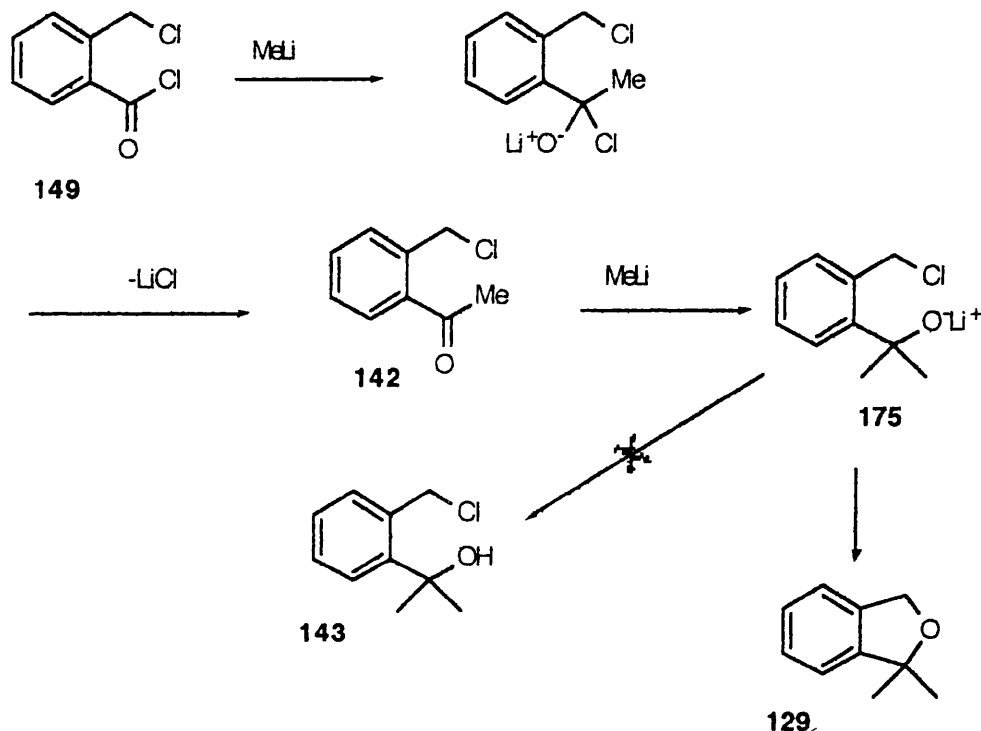

Scheme 3.15 Cyclisation of *ortho*-chloromethyl benzoyl chloride with methyl lithium

In fact we obtained the cyclic ether **129** by ring closure of the intermediate lithium alkoxide **175**. Repeating the reaction at -78°C gave no improvement and the cyclic ether **129** was again obtained exclusively. We considered the possibility that when using the acyl halide **149** we might be forming the required alcohol **143**, but the lithium chloride byproduct might act as a Lewis acid catalyst for ring closure.

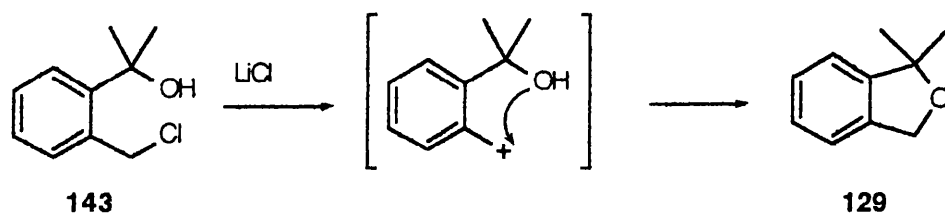

Scheme 3.16

We attempted to carry out the reaction with *ortho*-chloromethyl benzoic acid methyl ester **142** under almost halide-free conditions. The methyl lithium solution employed contained $\sim 0.05\text{M}$ halide i.e. $\sim 3.6\%$ halide. This did not improve matters and again the ether **129** was obtained.

Finally a viable route was found from *ortho*-methyl cumyl alcohol **154**. It was possible to brominate or chlorinate this under much more forcing conditions than were used for the free radical halogenation of *ortho*-toluic acid (page 88).



Scheme 3.17

Treatment of the cumyl alcohol **151** with 85% hydrogen peroxide and a trace of acid gave some peroxide and some cyclic ether **129**, but this was always accompanied by the related styrene **153** resulting from acid-catalysed dehydration. We were not able to prepare hydroperoxide **152** in a pure state for further work.

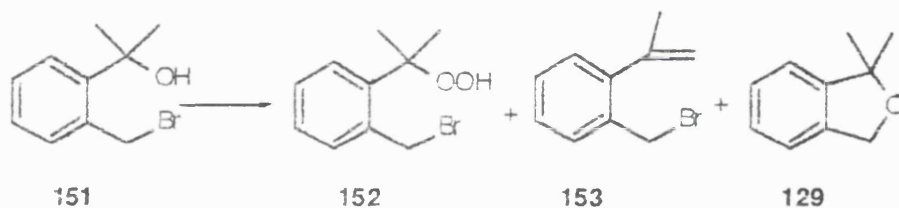

Scheme 3.18

This result is unsurprising given that 2-*ortho*-tolyl propene **155** is prepared from the acid catalysed dehydration of *ortho* cumyl alcohol **154** upon distillation. Furthermore treatment of *ortho*-methylcumyl alcohol **150** with a trace of acid and hydrogen peroxide always resulted in the production of the styrene **155** as well as the cumyl hydroperoxide **156**.

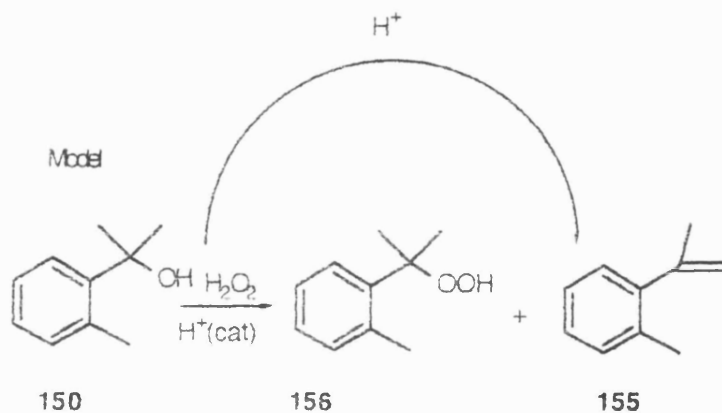

Scheme 3.19

3.4 Ozonolysis

Reaction of an alkene with ozone in an inert solvent usually affords an ozonide (1,2,4 trioxolane) which can be reduced to give the carbonyl compounds. All of these reactions are 1,3-dipolar additions. Ozone adds as a dipole stereospecifically to form the primary ozonide (molozonide) **46** which decomposes to **45** and a carbonyl compound. Compound **45** can recombine with the carbonyl compound to afford **47**. In the presence of an alcohol R_2OH may give the α -alkoxy hydroperoxide **161**. It occurred to us that an *ortho*-halomethyl benzyl hydroperoxide could be prepared by the ozonolysis of a suitable *ortho*-alkenyl halomethyl benzene. This would need to be selected to ensure that cleavage of the intermediate molozonide (primary ozonide) takes place in the desired sense.

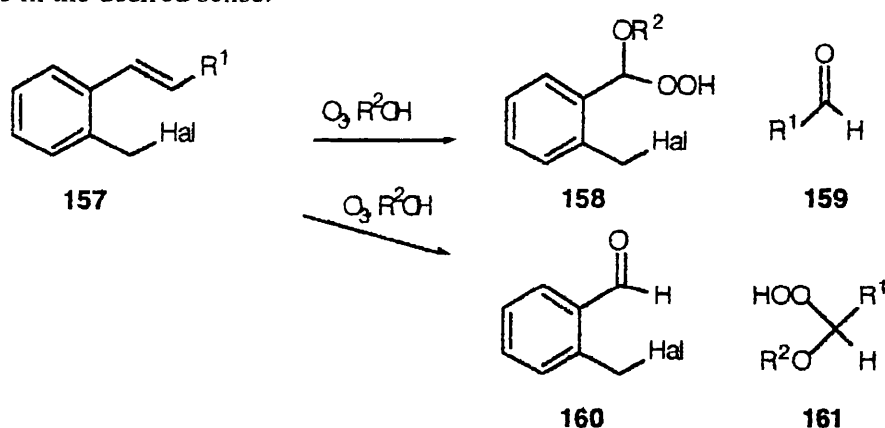

Scheme 3.20 The possible cleavages of the initially formed molozonide

Kolsaker and Bailey⁸⁸ have made a study on the ozonation of substituted cinnamic esters. *ortho*-Methoxycinnamic acid methyl ester **162** was ozonolysed at $-78^\circ C$ in methanol and then subjected to acidic workup to give the phenol **163**, aldehyde **164** and carboxylic acid **165**.

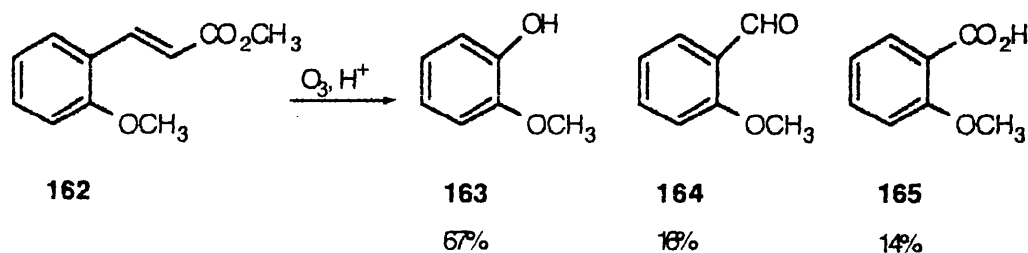
Scheme 3.21 Product distribution on ozonolysis of *ortho* methoxy cinnamic acid

These products were said to have arisen from the following reactions.

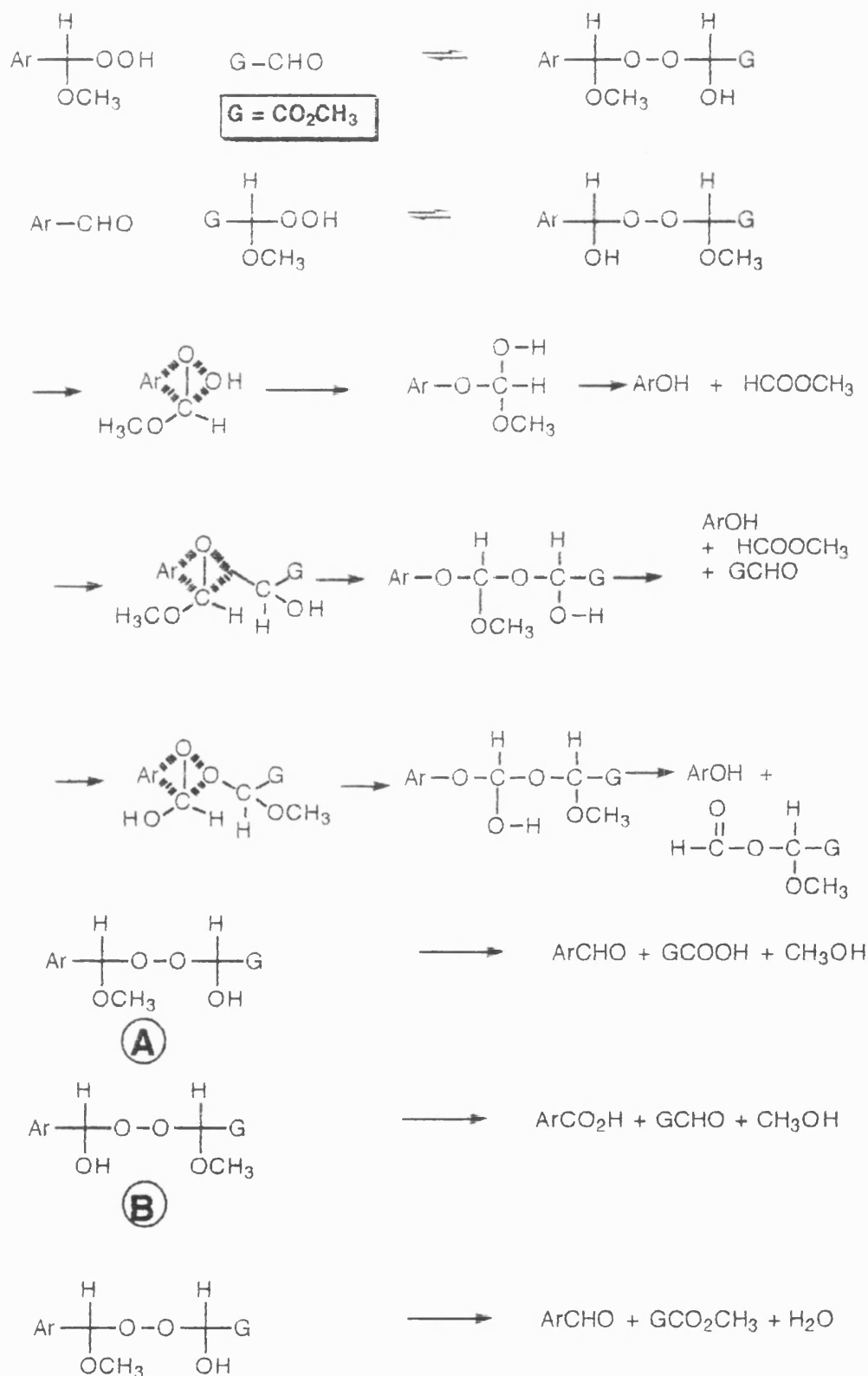

Scheme 3.22 Mechanistic explanation of products derived from the ozonolysis of cinnamyl esters.

The oxalic acid formed in the reaction arises from the cleavage of the alkoxy hydroperoxide adducts to give dimethyl oxalate which is rapidly hydrolysed during acidic work up.

Unfortunately this work does not provide an answer as to which mode of cleavage predominates because either adduct **A** or adduct **B** (scheme 3.22) could result in the products formed in the reaction. Work by Norcross et al.⁸⁹ suggests that at least some adduct **A** is produced in the ozonolysis of **169** as reduction of the ozonolysis products gives **160** (X=Br) in 10% yield. We thus attempted to isolate the hydroperoxide **170** by using the procedure of Norcross to prepare the alkene **169** and the modified ozonolysis of Kolsaker⁸⁸ to isolate the hydroperoxide **170**.

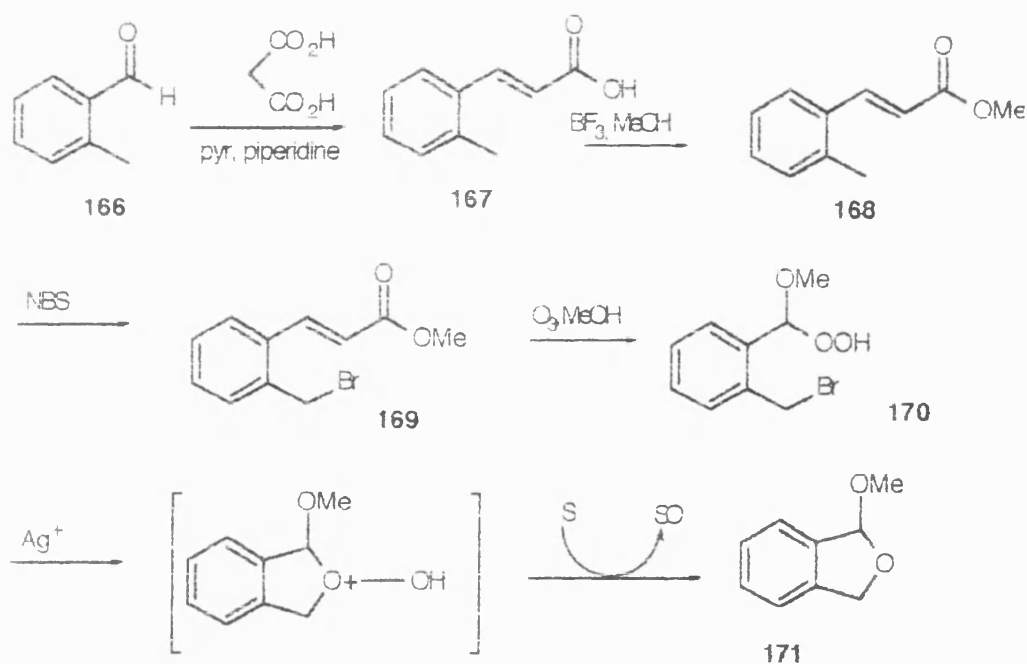

Scheme 3.23 Norcross route to *trans* *ortho*-bromomethyl methyl cinnamate and anticipated fate of hydroperoxide produced by ozonolysis

Treatment of *ortho*-tolualdehyde **166** with malonic acid in piperidine/pyridine gave the Doebner condensation adduct *trans* *ortho*-methyl cinnamic acid **167**.⁸⁹ Treatment of this product with boron trifluoride etherate complex and methanol⁹² afforded the methyl ester **168**. The bromomethyl compound **169** was then prepared by treating the ester **168** with NBS in carbon tetrachloride in the standard fashion to afford a crystalline product which was recrystallised from methanol under argon at -78°C . The compound was subsequently ozonolysed to afford the methoxy hydroperoxide **170**.⁸⁹ It was noted that crude samples of this material were exceptionally unstable at room temperature giving black tarry

complete disappearance of peroxide after only a few minutes. Immediate purification of the product by flash chromatography gave a more stable product at the expense of yield. The methoxy hydroperoxide would be expected to give phthalan **171** on treatment with silver trifluoroacetate if the peroxonium ion (scheme 3.23) is an intermediate in the reaction. We prepared an authentic sample of the phthalan to assist with our analysis of reaction products. Authentic phthalan **171** (1,3 dihydro-1-methoxy isobenzofuran) was prepared by treatment of phthalyl diol **172** with sodium hypochlorite solution in methanol. Phthalyl diol **172** was prepared by the reduction of phthalide **145** with lithium aluminium hydride.

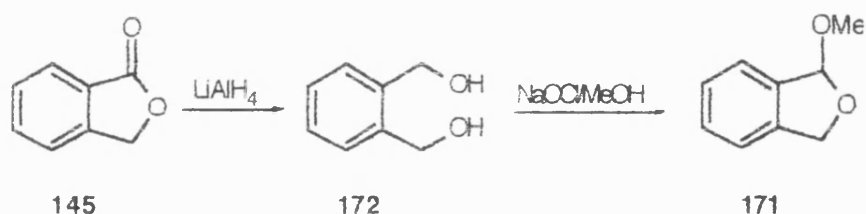

Scheme 3.24 Preparation of phthalan

An alternative possibility is that the methoxy group is more nucleophilic and instead of forming the dialkylperoxonium ion some other species is formed which will ultimately give different products.

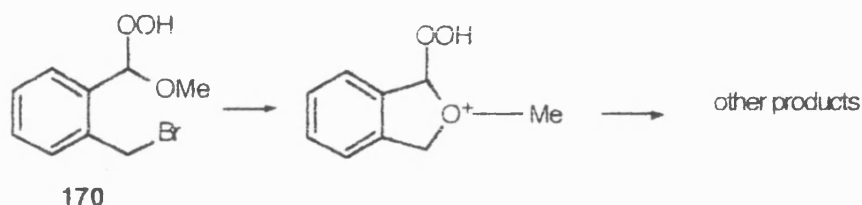

Scheme 3.25

The methoxy hydroperoxide **170** was dissolved in dichloromethane and an excess of silver trifluoroacetate was added. The progress of the reaction was monitored by TLC. To our surprise the reaction was exceptionally slow and the disappearance of hydroperoxide took over 1.5 hours. At the end of the reaction the silver salts were separated off by centrifugation and the supernatant concentrated. The product was then chromatographed to afford two fractions. Product recovery appears to have been adequate. ^{13}C and ^1H NMR suggest that the reaction product is not phthalan but one containing a carbonyl group. Because this result has shown that phthalan formation did not take place we

decided not to make any further investigations into the chemistry of the *ortho*-halomethyl benzyl hydroperoxides.

3.5 Experimental

Synthesis of 1-iodo-2-isopropylbenzene iodide **137**

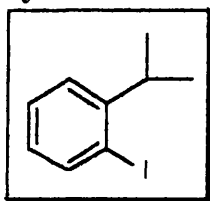

This was prepared by a method similar to that of Vogel who reported the synthesis of iodobenzene .

ortho-Isopropyl aniline **135** (47.0 g, 0.348 mol) was dissolved in a mixture of concentrated hydrochloric acid (89 mL) and water (89 mL). Immediate precipitation of the yellow isopropyl amine hydrochloride **136** was observed. The solution was cooled to 3 °C. Sodium nitrite (25.69 g, 0.372 mol) was dissolved in water (121 mL) and added to the reaction mixture dropwise by syringe. Cautious addition (5 mL aliquots) of sodium nitrite solution prevented the reaction temperature rising above 5 °C. The final 5% of sodium nitrite was added more cautiously (1 mL aliquots) and after each addition the solution tested with freshly prepared starch/iodide paper until an immediate and persistent blue colour was observed. (5 mL sodium nitrite remained unadded).

Potassium iodide (58.04 g, 0.349 mol) in water (58 mL) was then added slowly with stirring so as to control the evolution of nitrogen. The mixture was then left to stir overnight.

The reaction mixture was then brought to reflux for 2 h and allowed to cool. Ether (200 mL) was then added and the organic layer separated. The aqueous layer was extracted with more ether (3 x 50 mL) and the combined organic extracts washed with sodium thiosulfate until colourless, dried and distilled. *ortho*-isopropyl benzene iodide **137** was obtained by distillation (29.5 g, 0.120 mol, b.p. 222 °C).

¹H NMR: 1.3 (6H, d), 3.25 (1H, m), 6.9 (1H,t) 7.3 (2H, m) (7.8 (1H, d)

^{13}C NMR: 22.70, 23.21, 38.15, 101.30, 126.03, 127.74, 128.63, 139.53, 150.40.

***ortho*-isopropylbenzoic acid 138**

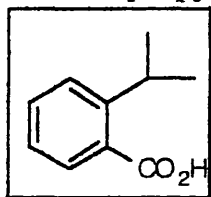

M H Crawford and F H C Stewart⁹⁰ described the preparation of *ortho*-isopropylbenzoic acid **138** from 1-bromo-2-isopropyl benzene. A similar procedure was adopted for the iodide **137**.

A 500mL 3-neck round-bottomed flask was fitted with a mechanical stirrer, condenser and pressure equalising funnel under argon. Magnesium (5.83 g 0.240 mol) was washed with dry ether and dried under vacuum. The magnesium was placed in the reaction vessel with ether (50 mL) and a crystal of iodine. The 1-iodo-2-isopropylbenzene **137** was placed in the funnel and 2mL introduced to the reaction mixture to initiate the reaction. A further portion of ether (50mL) was added to the reaction mixture and addition of the iodide continued over 40 min. When the reaction subsided the flask was cooled in an ice slurry and more ether (50mL) added.

Crushed solid carbon dioxide (Cardice[®]) was placed in a 600mL beaker and the reaction mixture added in a steady stream. A vigorous reaction ensued and the mixture was stirred manually. Crushed ice (150 g) and concentrated hydrochloric acid (75 mL) were added with stirring. After 1h the two layers were separated and the lower aqueous layer extracted with ether (3 x 40 mL). The combined ethereal extracts were washed with 20% sodium hydroxide (4 x 40mL) and cooled. Concentrated hydrochloric acid was then added until the mixture was just acid. The crude precipitate of **138** was crystallised from light petroleum (6.86 g 42 mmol, 35%) mp 55-57 °C

^1H (DMSO): 1.35 (6H,d) 3.55 (1H,m) 7.2-7.8 (3H,m) 8.15 (1H,d)

^{13}C : 24.04, 29.35, 125.54, 126.46, 128.33, 130.88, 132.79, 150.97, 174.17

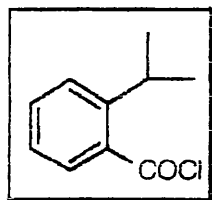
***ortho*-isopropylbenzoyl chloride 131**

ortho-isopropylbenzoyl chloride **131** was prepared from **138** with oxalyl chloride using the method described for **104** in chapter 2. The crude product was purified by bulb to bulb distillation ($t_{\text{ot}} < 200\text{ }^{\circ}\text{C}$, 20 mmHg) to afford **131** (2.0 g, 11 mmol, 91%).

^1H NMR: 1.35 (6H,d), 3.55 (1H, m), 7.2-7.8 (3H, m), 8.15 (1H,d)

^{13}C NMR: 23.67, 29.50, 125.89, 126.48, 128.27, 132.15, 132.97, 133.81, 150.23, 167.88.

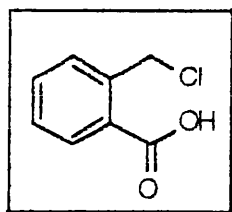
***ortho*-chloromethyl benzoic acid 141**

Riad et al¹⁰⁸ reported preparing **141** by refluxing toluic acid in sulfuryl chloride with simultaneous irradiation with UV light. **141** was prepared by us using reflux only.

ortho-Toluic acid (45.0g, 0.33mol) and benzoyl peroxide (2.96 g, 12.2 mmol) were dissolved in sulfuryl chloride (70 mL, 0.87 mol) in a one-neck round-bottomed flask fitted with condenser under nitrogen. The mixture was brought to reflux for 1.5 h and then allowed to cool to a semi-solid mass. Chopped ice (80 g) was then added at such a rate to prevent vigorous reflux. When the ice had melted the solid mass was then broken up and filtered under vacuum. The moist cake was air dried under suction at room temperature for 3 h. The crude product was then recrystallised twice from chloroform. From this second recrystallisation two crops of **141** were obtained

First crop mp 122-123 $^{\circ}\text{C}$ (20.32 g 0.119 mol)

Second crop mp (8.00 g 0.047 mol)

^{13}C NMR (DMSO): δ 44.21, 128.72, 120.26, 130.75, 131.26, 132.26, 138.15, 167.89

Authentic 3,3 dimethylphthalide preparation 134

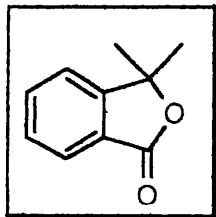

This was prepared from diethyl phthalate by the method of Elsner and Strauss⁹¹ except that methyl iodide was used instead of methyl chloride in the preparation of the Grignard reagent.

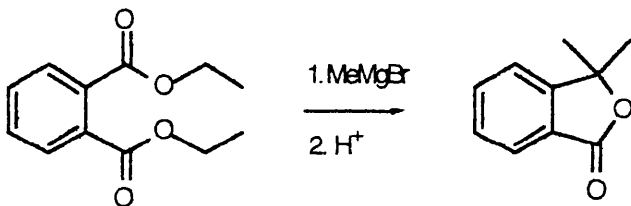

^1H NMR: 1.63 (6H, s), 7.2-7.8 (4H, m)

^{13}C NMR: 27.30, 85.35, 120.62, 125.25, 125.69, 128.8, 134.05, 154.93, 169.74,

IR: (CCl_4) C=O 1775 cm^{-1}

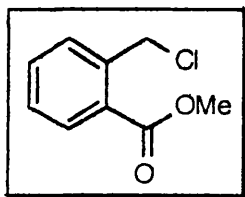
methyl *ortho*-chloromethyl benzoate 142

This was prepared by the method of Hallas⁹². ¹³C NMR revealed that the product was contaminated with phthalide. Purification was effected by column chromatography with a mixture 7% ethyl acetate 93% petroleum ether (b.p. 30-40 °C) as eluant.

R_f 0.46

3.13 g product isolated

¹³C: 44.37, 52.20, 128.33, 128.96, 130.81, 131.03, 132.42, 138.73, 166.98

Reaction of *ortho*-hydroxymethylcumyl alcohol 144 with DMS/NCS complex.

NCS (0.294 g, 2.20 mmol) was dissolved in dichloromethane (2.5 mL) and placed in a 3-necked round-bottomed flask under nitrogen at 0 °C and the mixture stirred. DMS (0.20 mL) in dichloromethane (2.5 mL) was then added dropwise over 10 min. The reaction mixture was then cooled to -20 °C and *ortho*-hydroxymethyl cumyl alcohol **144** (0.410 g 2.47 mmol) in dichloromethane (5 mL) added in one portion with stirring. The mixture was allowed to warm to 0 °C over 90 min and then stirred at 0 °C for a further 1h. The reaction mixture was then poured into ice cold brine (10 mL) and the organic layer separated. The aqueous layer was extracted with ether (2 x 4 mL) and the combined organic layers washed with cold brine (2 x 4 mL) dried with magnesium sulfate, filtered and concentrated to afford 0.404 g material.

¹³C: 28.22, 34.50, 70.53, 85.63, 120.32, 120.81, 127.03, 127.16, 127.21, 138.27, 146.71.

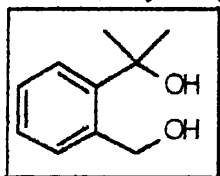
ortho*-hydroxymethyl cumyl alcohol 144ortho*-(1-hydroxy-1-methyl ethyl) benzyl alcohol)

Magnesium (4.90 g, 0.20 mol) was washed with dry ether, dried and placed in a 3-neck round-bottomed flask fitted with condenser, addition funnel and mechanical stirrer. Ether (30 mL) was added followed by methyl iodide (12.5 mL 0.20 mol) in ether (50 mL) dropwise. When the addition was complete (45 min) the mixture was refluxed (20 min). Phthalide (13.41 g, 0.10 mol) in freshly distilled dry THF (90 mL) was then added dropwise and the mixture refluxed for 1h and allowed to stand overnight. The solids were then resuspended by vigorous stirring and saturated ammonium chloride solution (80 mL) added dropwise. On completion of the addition the mixture was allowed to stand overnight. The organic layer was then separated and the aqueous layer extracted with ether (3x 60 mL). The aqueous layer was still very basic and 10% acetic acid added was added until the mixture was at pH7. The aqueous layer was then extracted with more ether (3 x 60 mL). The combined organic extracts were washed with saturated sodium bicarbonate solution (2 x 60 mL), then with brine (60 mL) and dried with magnesium sulfate, filtered and concentrated to afford an oil. Trituration of this oil with dichloromethane/hexane caused precipitation of white crystals of *ortho*-hydroxymethyl cumyl alcohol **144** (10.4 g, 0.062 mol, 31%).

R_f CH₂Cl₂/MeOH 10/1 0.33

mp 59-61 °C lit. mp 63-64 °C¹²⁷

¹H NMR: δ 4.70 (d,1H), 4.90 (d,2H), 7.18-7.25 (4H,m)

¹³C NMR: δ 32.16, 64.99, 74.26, 126.16, 127.01, 127.77, 1731.80, 137.83, 146.38.

Reaction of *ortho*-chloromethyl benzoyl chloride **149** with methyl lithium

The acyl halide **149** was dissolved in anhydrous ether (15 mL) under nitrogen and cooled to -78 °C. Methyl lithium in ether (1.4M ;20 mL; 0.028 mol) was added dropwise over 10 min with stirring and the mixture allowed to warm to

0°C over 1.5h. The reaction mixture was then quenched with saturated ammonium chloride (50 mL). The organic layer was separated and washed with brine (15 mL) then dried with magnesium sulfate, filtered and concentrated to afford a black tar (2.42 g) ^{13}C NMR of this product showed it to be the ether **134**.

***ortho*-chloromethyl benzoic acid methyl ester 142 with methyl lithium**

Methyl *ortho*-chloromethylbenzoate **142** (2.65 g, 0.014 mol) was dissolved in anhydrous ether (15 mL) under argon with stirring. The solution was cooled to -78 °C and methyllithium solution (1.4 M; 20 mL 0.028 mol) was added over 10m. Glacial acetic acid (2.5 mL) was then added and the reaction mixture was allowed to warm to room temperature over 2h. Saturated sodium bicarbonate (2 x 25 mL) was then added and the organic layer separated. The organic layer was then washed with brine (25 mL), dried with magnesium sulfate, filtered and concentrated to afford the ether **129** as a yellow oil (2.07 g, 99%). ^{13}C NMR of the product and comparison with authentic material confirmed the identity of the product.

***ortho* methyl cumyl alcohol 154**

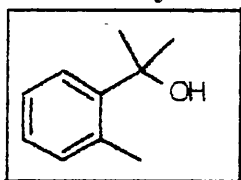

This was prepared by the method of Wakefield⁸⁷ in 73% yield from *ortho* toluoyl chloride

^{13}C NMR 22.09, 30.61, 73.46, 125.11, 125.48, 126.86, 132.50, 135.82, 145.63

^1H 2.05 (6H,s), 2.20 (3H,s), 4.72 (1H,s), 7.3-7.8 (4H,m)

***ortho*-methylcumyl hydroperoxide 156**

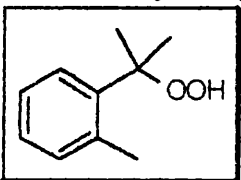

This was prepared by the method of Davies⁹³.

^{13}C NMR: δ 21.62, 26.18, 85.59, 125.96, 125.96, 127.63, 132.82, 136.09, 141.57

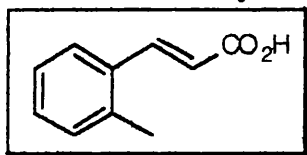
trans ortho-methyl cinnamic acid 167

This was prepared by the method of Norcross et al⁸⁹

mp 179-181 °C lit. mp 175-176 °C⁸⁹

recrystallised from EtOH(90%) -water (10%)

¹H NMR: δ 2.38 (s, 3H), 6.39 (d, 1H J=16Hz), 7.13 (m, 4H), 7.7 (d, 1H J=16Hz)

IR(nujol): 2800-3000 br, 2500-2700 br, 1685 1625 cm⁻¹

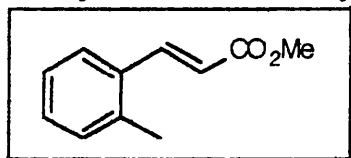
Methyl trans ortho-methylcinnamate 168

This was prepared by the method of Norcross et al⁸⁹

oil bp: 114-117 °C / 2.2 mm Hg

R_f: 10% ethyl acetate 90% hexane

¹H NMR: 2.45 (s, 3H), 3.82 (s, 3H), 6.25 (d, 1H J=16Hz), 7.22 (m, 4H), 7.85 (d, 1H J=16Hz)

IR: neat 2995, 1715, 1638 cm⁻¹

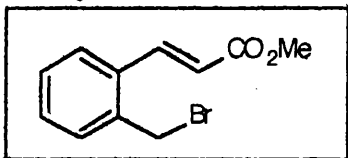
Methyl trans ortho-bromomethylcinnamate 169

This was prepared by the method of Norcross et al⁸⁹

R_f 15% ethyl acetate / 85% hexane 0.30

¹H NMR: 4.0 (s, 3H), 4.8 (s, 2H), 6.45 (d, 1H J=16Hz), 7.2 (m, 4H), 8.1 (d, 1H J=16Hz)

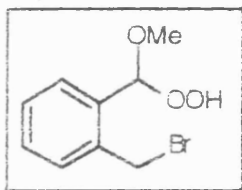
1-(*ortho*-bromomethyl)phenyl-1-methoxymethyl hydroperoxide 170

This was prepared by the method of Kolsaker⁸⁸.

¹H NMR: 3.61 (3H, s), 4.54 (1H, d J=10.4Hz) 4.74 (1H, d J=10.4Hz), 6.04 (1H, s), 7.31-7.58 (4H, s) 9.17 (1H, s)

¹³C NMR: δ 30.43, 56.59, 105.41, 127.55, 128.54, 129.62, 130.77, 133.22, 135.77.

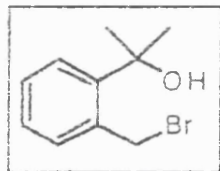
ortho-Bromomethyl cumyl alcohol 151

ortho-Bromomethyl cumyl alcohol **151** was prepared from *ortho*-methyl cumyl alcohol (1.11g, 7.38 mmol) by reflux with NBS (1.32g, 7.41 mmol) in carbon tetrachloride (25 mL). After 1h of reflux the mixture was allowed to cool and the solids were filtered off. The filtrate was concentrated to afford the product which was purified by column chromatography with 5% ethyl acetate 95 % petroleum ether (bp 30-40 ° C) to afford **151** (0.607g, 2.65 mmol, 36%).

¹H NMR: 2.14 (s, 3H), 4.50 (s, 2H), 4.54 (s, 1H), 7.28-7.92 (m, 4H, aro)

MS: M-OH⁺ 211.0141 obs 211.0122 calc

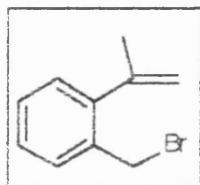
2-(*ortho*-bromomethyl)phenyl propene 153

¹H 2.18 (s, 3H), 4.66 (s, 2H), 5.10 (s, 1H), 5.37 (s, 1H), 7.10-7.51 (m, 4H)

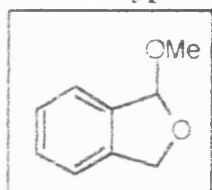
2-methoxyphthalan 171

This was prepared by the method of Naito and Rickborn⁹⁴

bp: 62-64 °C /3mm Hg

¹H NMR: 3.42 (3H, s), 5.00 and 5.06 (1H, d) (A part of AB qt), 5.18 and 5.24 (1H, d) (B part of AB quartet), 6.18 (1H, d, J=2.5Hz), 7.2 (4H, m)

¹³C NMR: 55.13, 72.23, 107.47, 120.92, 122.85, 127.56, 129.09, 137.19, 139.84

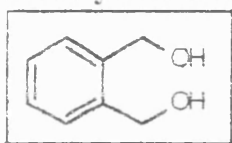
Phthalylidol 172

(1,2-Benzenedimethanol)

This was prepared by the reduction of phthalide according to the method of Naito and Rickborn⁹⁴

mp: 63-64 °C

¹³C 63.91, 128.47, 129.62, 139.28.

¹H 3.18 (s, 2H), 4.58 (s, 4H), 7.20 (m, 4H, aro)

4. Peroxyacid preparation

4.1 Introduction: the acyl alkyl peroxonium ion

Because of the difficulty in preparing the model compound **132** for examination of the reactivity of a hydroperoxy acyl chloride we had hoped it might be possible to prepare **133** via *ortho* halomethyl substituted peroxy compounds of the type **174**.

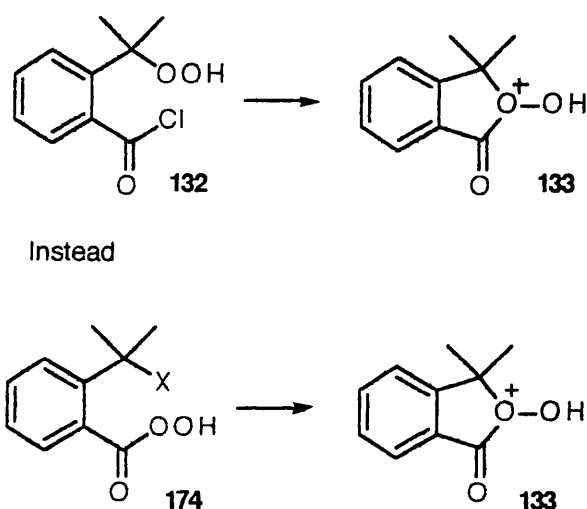

Scheme 4.1

Peroxyacids are themselves powerful electrophilic oxidising agents and we hoped that an acyl alkyl peroxonium ion **133** might be more electrophilic than the parent peroxyacid from which it was derived, given the documented enhancement of reactivity of the dialkyl peroxonium ion when compared to its parent hydroperoxide.

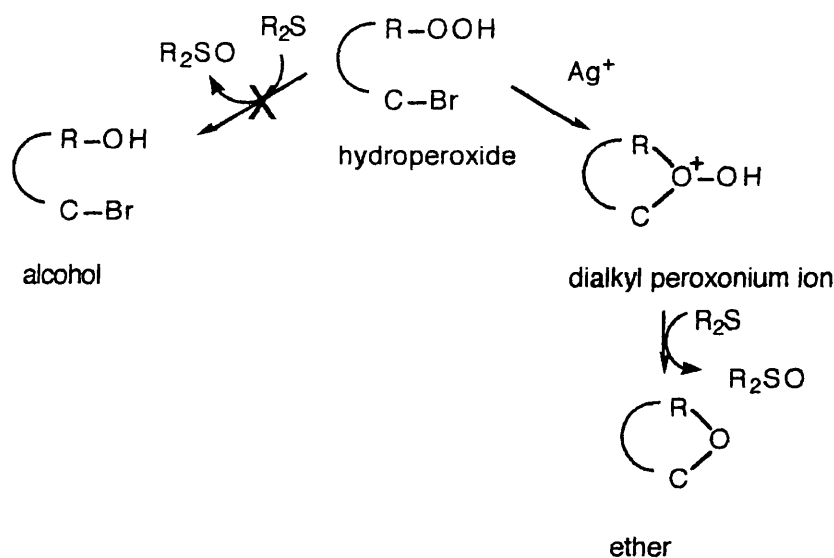

Can we extend the principle ?

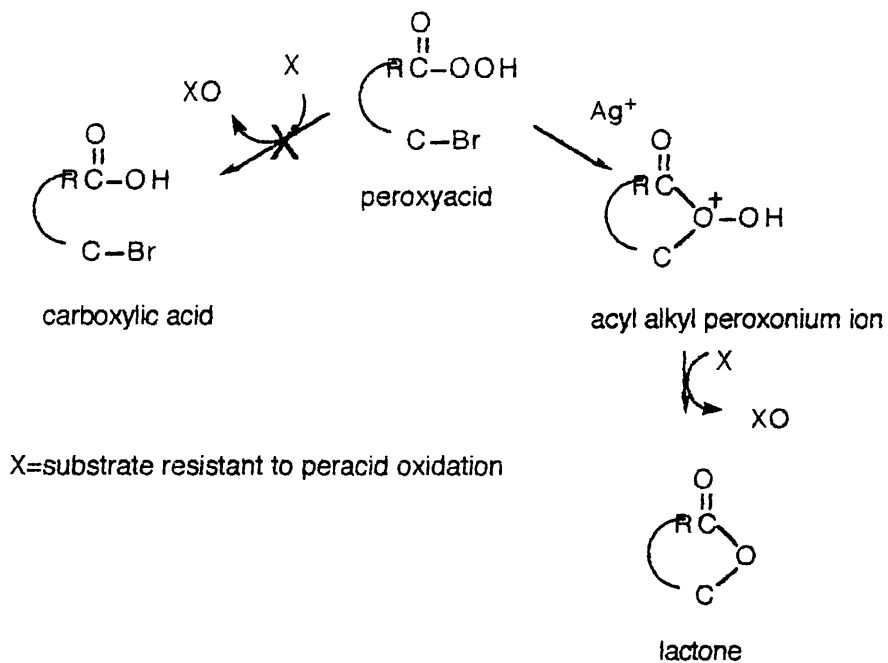

Scheme 4.2 The acyl alkyl peroxonium ion principle

MODEL

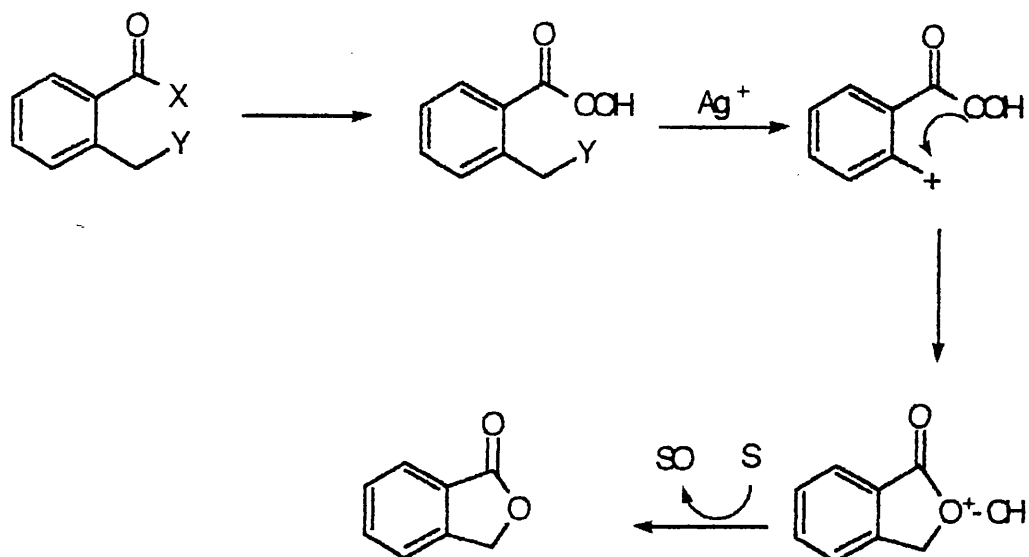

Scheme 4.3 The system chosen to test the formation of the acyl alkyl peroxonium ion.

As a starting point we attempted to prepare **176** (*o*-chloromethylperbenzoic acid)
 A summary of the methods attempted is shown in the table (page 134).

4.2 Overview of peroxyacid preparation

4.2.1 Direct peroxidation

The synthetic procedures used to prepare peroxyacids up to 1990 have been extensively reviewed in Houben-Weyl⁹⁵. Some methods are superior to others for specific cases although each reaction tends to be limited in scope, yield and preparative convenience. Formation of a peroxyacid from the carboxylic acid under neutral conditions is impractically slow but is enhanced by acid catalysis, azeotropic removal of water, and increasing the strength of hydrogen peroxide used.

Table 3.1 Equilibration of acids and hydrogen peroxide^{96,97}

	Strength of H ₂ O ₂ (%)	Time (h)	Concentration RCO ₃ H (%)
Formic acid	90	0.5	46
	30	2	4.7
Acetic acid	90	12-15	46
	30	80-90	8.6

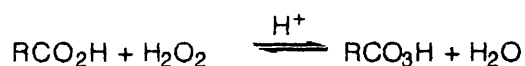

Scheme 4.4 Peroxyacid/acid equilibrium.

Typically sulfuric acid has been employed for the preparation of the aliphatic peroxyacids such as peracetic acid.

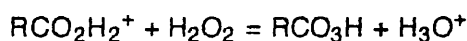
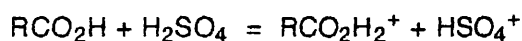

Scheme 4.5 Sulfuric acid catalysed peroxyacid preparation

This method is not suitable where the carboxyl group is a direct substituent of the aromatic ring as peroxidation is generally accompanied by degradation of the aromatic nucleus. Indeed our attempts to prepare *ortho*-chloromethylperbenzoic acid **176** or *ortho*-bromomethylperbenzoic acid **177** by this method gave tarry products in dangerously exothermic reactions, with the products containing no peroxide. Siegel and Swern⁹⁸ have attributed the problem to the strong oxidation/sulfonation properties of sulfuric acid and its low solvation capacity

for the aromatic acids. They replaced sulfuric acid with methanesulfonic acid, an acid of comparable strength, but of much lower oxidising potential and greater solvation capacity. We were not able to effect any significant conversion of *ortho*-chloromethylbenzoic acid **141** to **176** using the Swern procedure and a modified procedure using dichloromethane as cosolvent and reflux of the reaction mixture effected the conversion of the acid to phthalide not the peroxyacid.

4.2.2 Exchange reactions

A procedure for the conversion of acids to peroxyacids using polymer-supported peroxyacid has been reported by Pande and Jain⁹⁹. They claimed that they were able to form peroxyacids in excellent yield using polymer-supported peroxyacids prepared from strongly acidic ion exchange resins (sulfonic acid type).

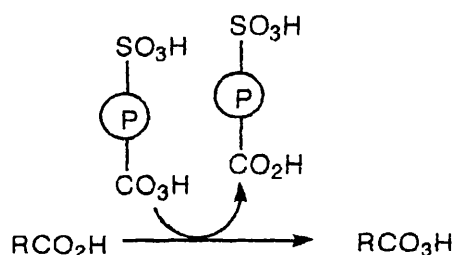

Scheme 4.6 Peroxyacid/acid exchange reaction

We used a similar resin to that employed by them but were unable to effect the conversion of *ortho*-chloromethylperbenzoic acid **141** to peroxyacid **176**, nor the conversion of *meta*-chlorobenzoic acid to mcpba, a conversion that was reported by them to proceed in 85% yield. Other polymer-supported peroxyacids have been prepared^{100,101} by previous researchers. These were used directly for epoxidation of substrates and not the peroxyacid/acid exchange reaction. In any case, the difficulty in obtaining the precursor resins precluded us from pursuing this reaction further.

4.2.3.1 Perhydrolysis of acyl halides

Perhydrolysis of acyl halides at low temperatures gives yields of peroxyacids of typically 85% or more but *only* for acid chlorides of relatively strong acids. Another problem is the formation of undesirable diaryl peroxides. This problem can be avoided in two ways. The peroxyacids often exhibit reduced

excess H_2O_2 is used (a ratio of $\text{RCOCl} : \text{H}_2\text{O}_2$ of 2:1 leads to almost exclusive diaryl peroxide formation). This method is based on the high nucleophilicity of the perhydroxyl anion having an α effect¹⁰².

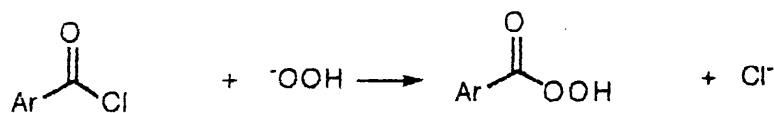

Scheme 4.7 Peroxyacid formation by perhydrolysis

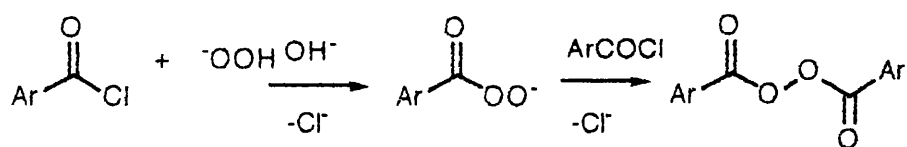

Scheme 4.8 Diaryl peroxide formation by basic hydrogen peroxide

Nedelec, Sorba and Lefort¹⁰³ modified the method by using an excess of hydrogen peroxide in the presence of pyridine. They isolated peroxyacids in high yield with minimum formation of diacyl peroxide. The following reactions take place

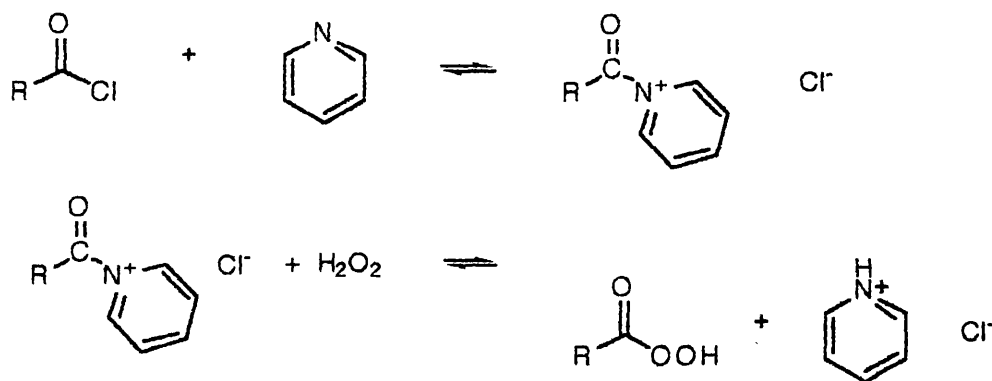

Scheme 4.9 Peroxyacid preparation using pyridine and hydrogen peroxide

By use of excess hydrogen peroxide, reaction of the acylpyridinium intermediate with the peroxyacid is prevented. Furthermore the presence of base in the reaction mixture is said to minimise the decomposition of peroxyacid formed. Under the stated conditions we again obtained phthalide.

Our rationale for employing basic conditions was the measurement by Sawaki¹⁰⁴ of the reactivity of perhydroxyl and hydroxyl anions. The perhydroxyl anion is more reactive than the hydroxyl anion by a factor of 10^4 for an $\text{S}_\text{N}2$ reaction whilst it is only 35 times as nucleophilic as H_2O in $\text{S}_\text{N}1$

type reactions. We felt that we should select conditions favouring S_N2 reactions and thus improve the nucleophilicity of the perhydroxyl anion.

In order to favour perhydrolysis we prepared the $DABCO.H_2O_2^{105}$ complex which is an essentially anhydrous form of hydrogen peroxide. On treating *ortho*-bromomethyl benzoyl bromide **178** with this complex we obtained no peroxidic material.

4.2.3.2 Alkaline alcoholysis of a diaroyl peroxide

Alkaline alcoholysis of a diaroyl peroxide is an alternative method of peroxyacid preparation particularly useful for the preparation of perbenzoic acid from benzoyl peroxide. We felt that this was an inappropriate procedure for our purposes because it would require an extra step to prepare the diacyl peroxide and one half of the acyl groups would be wasted by ester formation.

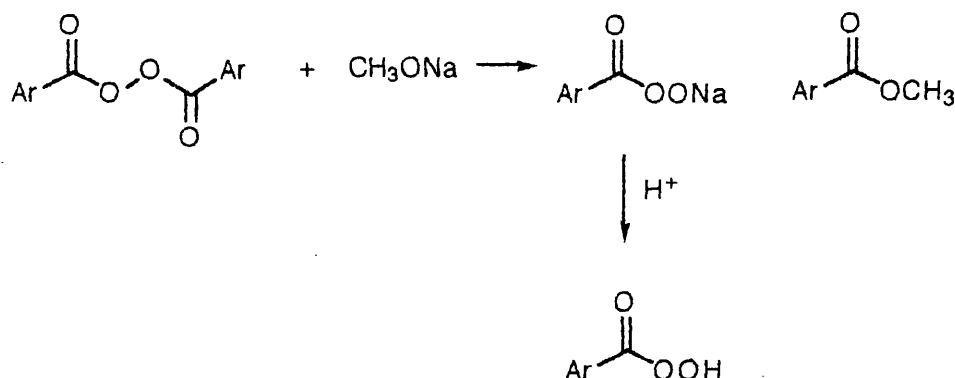

Scheme 4.10 Alkaline alcoholysis of diacyl peroxides

The use of the anhydride for the preparation of the required peroxyacids was rejected for similar reasons.

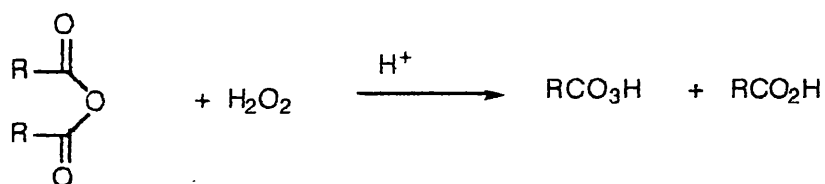

Scheme 4.11 Peroxyacid preparation from the anhydride

When *ortho*-bromomethylbenzoyl bromide **178** was treated with basic hydrogen peroxide (sodium hydroxide/hydrogen peroxide solution) or by any of the

variants of the method (sodium peroxide/ water/ dioxane)(hydrogen peroxide/pyridine), high yields of phthalide were obtained. Our initial thought was that peroxyacid formation might indeed be occurring but rapid ring closure prevented isolation of the desired peroxyacid. An alternative scenario was that perhydrolysis was not taking place at all and that hydrolysis was a competing reaction. We replaced **178** by *ortho*-chloromethylbenzoyl chloride **149** and obtained similar results.

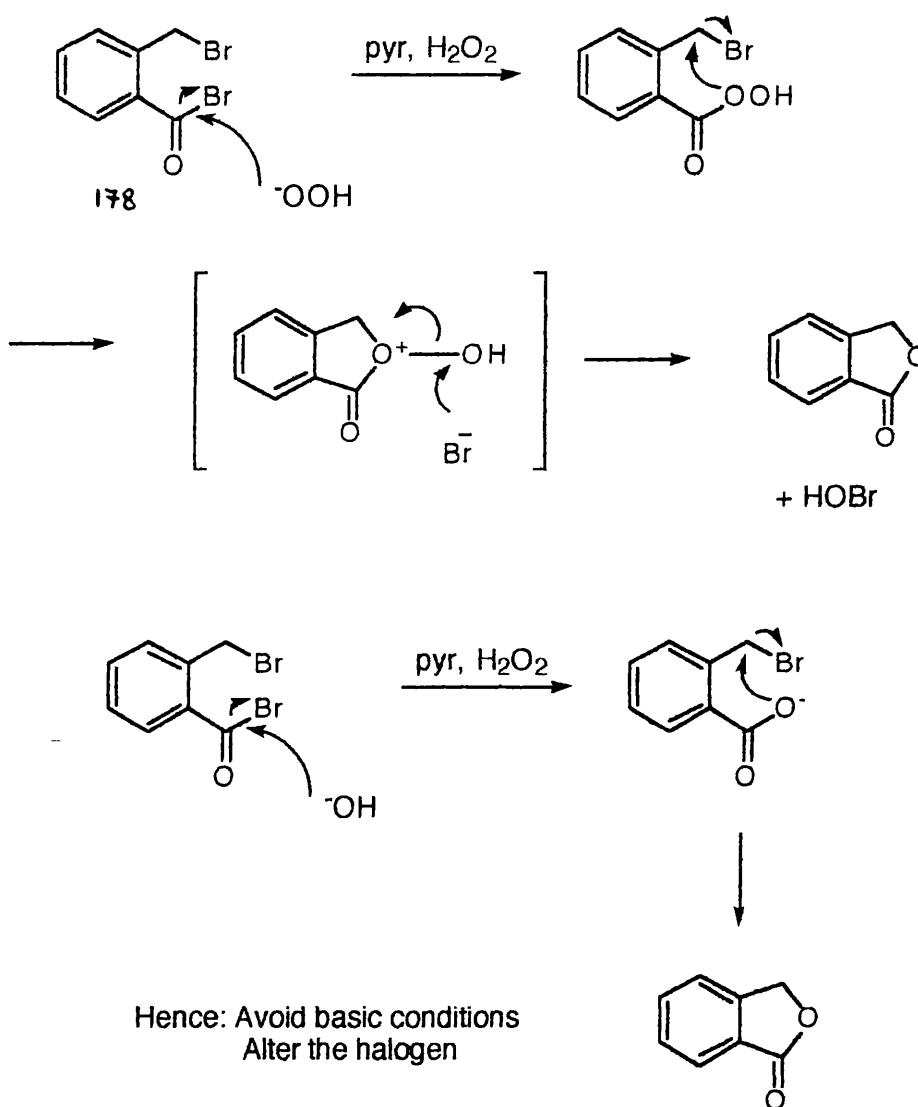

Scheme 4.12 The possible intermediates involved in perhydrolysis of *ortho*-bromomethylbenzoyl bromide.

4.2.3.3 Imidazolides

Imidazolides have been suggested as potential precursors of peroxyacids in washing powder formulations¹⁰⁶, as alkaline perhydrolysis of imidazolides is

more facile than that of the carboxylic acids from which they are derived. It was thought useful to evaluate whether the *ortho*-halomethylimidazolides might have a reactivity different from a non halogen substituted *ortho* M-acyl imidazolidine such as *ortho*-toluoyl-acylimidazole **180**. An enhancement of oxidising power might indicate the involvement of the acyl alkyl peroxonium ion. We prepared the *ortho* halomethyl imidazolides from their acyl halides and imidazole or from the acids themselves with N,N'-thionyl diimidazole **181**. Subsequent treatment of the imidazolides with basic hydrogen peroxide did not lead to the isolation of the required peroxyacids.

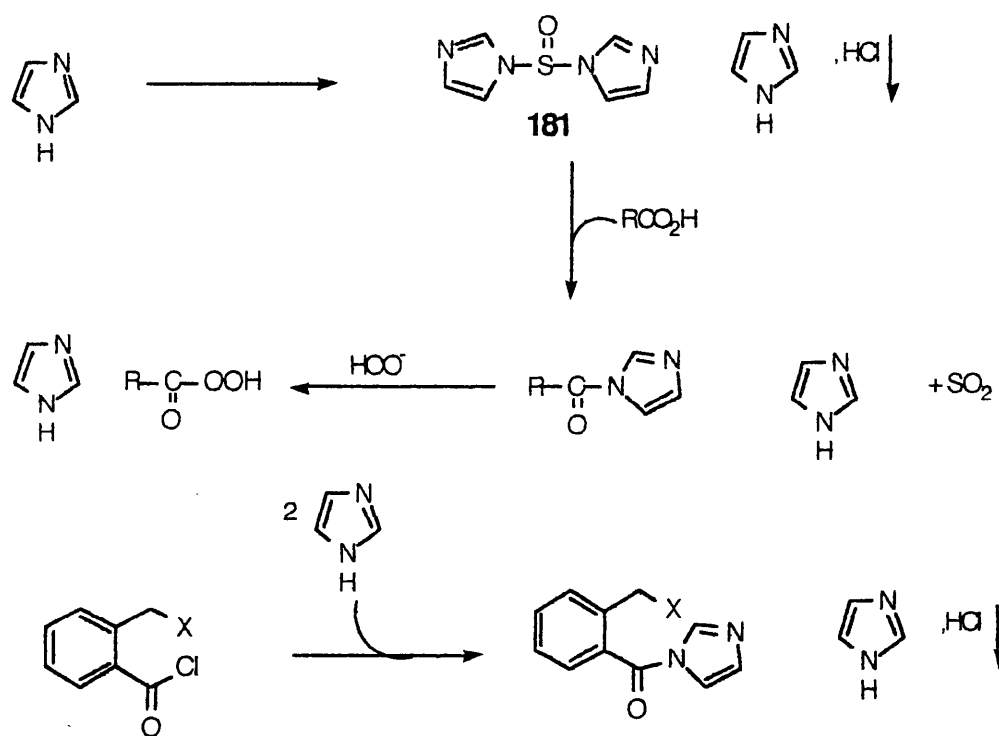

Scheme 4.13 Imidazolides as sources of peroxyacids

Corey et al.¹⁰⁷ had had problems in the preparation of peroxyarachidonic acid (Scheme 4.14). However they did manage to produce this self reactive intermediate by treating it with N,N'-carbonyldiimidazole to form the imidazolide **182**. In their preparation they use added potassium hydrogen sulfate to rapidly remove the imidazole formed in the reaction. Unless this is done, they claimed that the peroxyacid was rapidly reduced to the carboxylic acid.

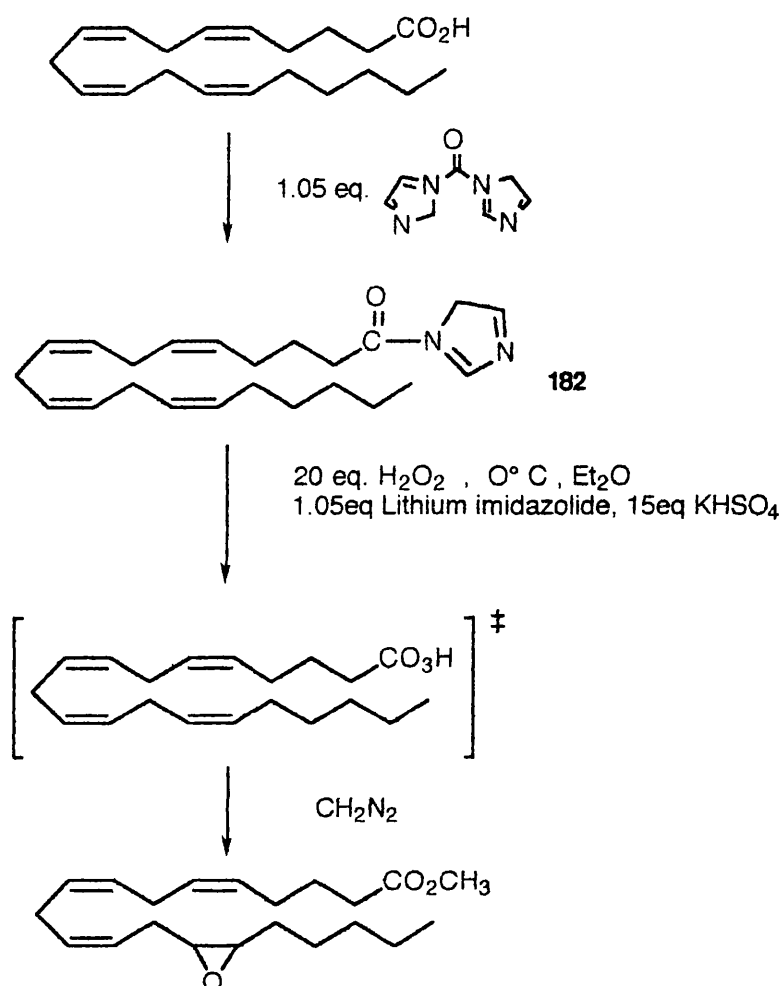

Scheme 4.14 Peroxyarachidonic acid preparation
followed by regioselective epoxidation.

Because of problems that we had experienced in use of any source of basic hydrogen peroxide we did not perform this modification.

4.3 The potential problem with the *ortho* halomethyl peroxybenzoic acids

We were aware of the potential problems of using basic conditions with our compounds. Riad et al.¹⁰⁸ have reported the conversion of *ortho*-chloromethylbenzoic acid **141** into the corresponding γ -lactone phthalide **145** under alkaline conditions in aqueous dioxan, when the following ionisation equilibrium reaction is set up.

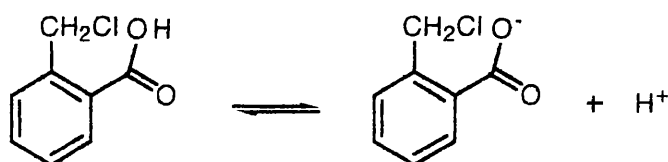

Scheme 4.15

The reaction of *ortho*-chloromethyl benzoic acid **141** to form phthalide **145** in dioxan suggested to Riad that the following steps are taking place, although we prefer scheme 4.12.

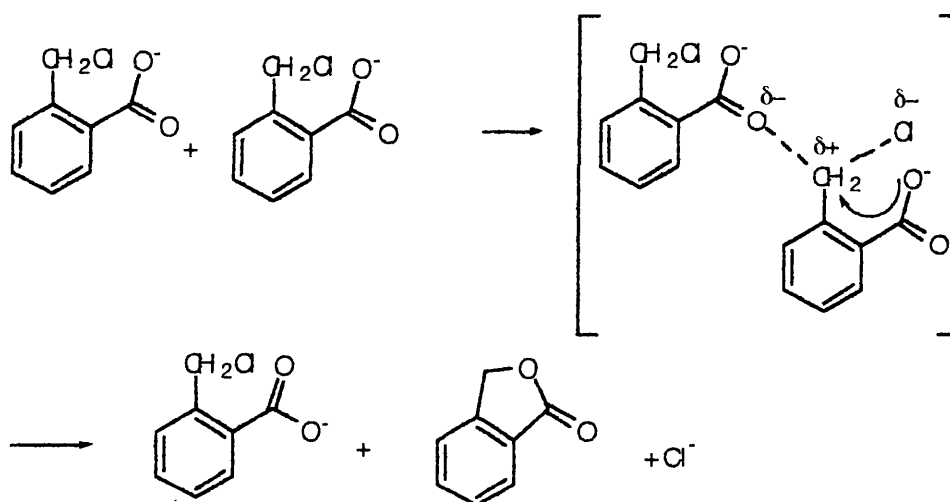

Scheme 4.16 Proposed mechanism for formation of phthalide from *ortho*-chloromethylbenzoic acid under basic conditions.

This mechanism is in accordance with the second order kinetics observed in the reaction for chloride ion liberation. We had hoped that by using basic conditions under which the perhydrolysis is rapid we might be able to isolate the peroxyacid before ring closure took place. Unfortunately whenever basic hydrogen peroxide was employed, phthalide was always isolated in very high yield.

4.4 Autoxidation of aldehydes

Dick and Hanna¹⁰⁹ reported a high yielding synthesis of aromatic peroxyacids by the ozone-initiated autoxidation of benzaldehydes. They noted that the effect of solvent was critical to the relative ratio of acid/peroxyacid in the final reaction mixture. In solvents such as carbon tetrachloride and *n*-hexane, yields were only 25% of peroxyacid, the remaining aldehyde was converted to carboxylic acid. They attributed the low yields of peroxyacids to the low polarity of the solvent.

Solvents with high polarity gave high yields of peroxyacid and they presumed that solvents of high polarity minimise the interaction between peroxyacid and aldehyde. The short reaction time in polar solvents also serves to maximise the yield of peroxyacid. Of interest to us was the reaction of ozone with *ortho*-chlorobenzaldehyde **182** as a 0.5M solution in ethyl acetate which was reported to give yield of 83% of peroxyacid **183** in 4 hours. We prepared the required aldehyde **186** for this reaction by the cadmium-moderated borohydride reduction of the haloacyl halides **149**. It is interesting to note that we did get significant reduction of the benzylic halogen group whereas Entwistle et al.¹¹⁰ reported no reduction of benzyl chloride **184** to toluene under these conditions.

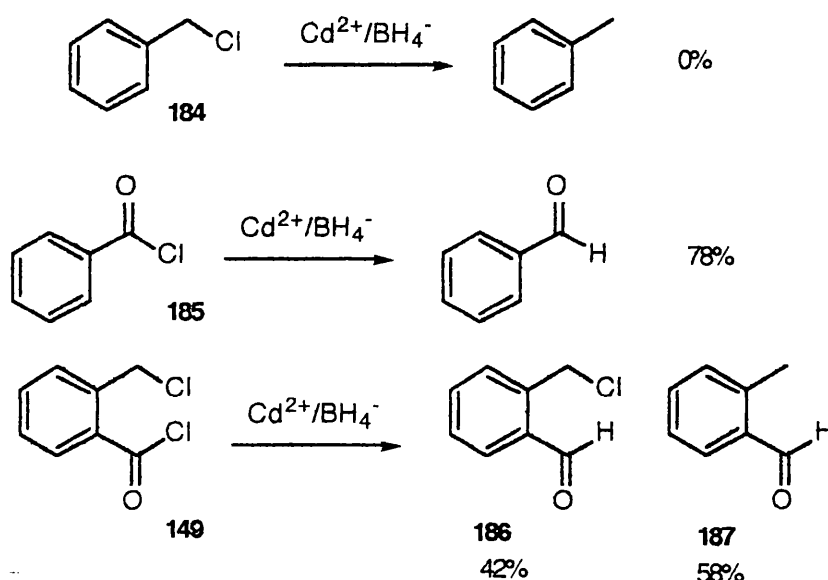

Scheme 4.17 Cadmium-moderated borohydride reduction to produce *ortho*-chloromethylbenzaldehyde

Having obtained *ortho*-chloromethylbenzaldehyde **186** we treated it with an oxygen/ozone stream at $-78\text{ }^\circ\text{C}$ until all the aldehyde had disappeared as judged by TLC of the reaction mixture. We worked up the reaction mixture as described by Dick and Hanna and found it to be composed exclusively of *ortho*-chloromethylbenzoic acid **141**.

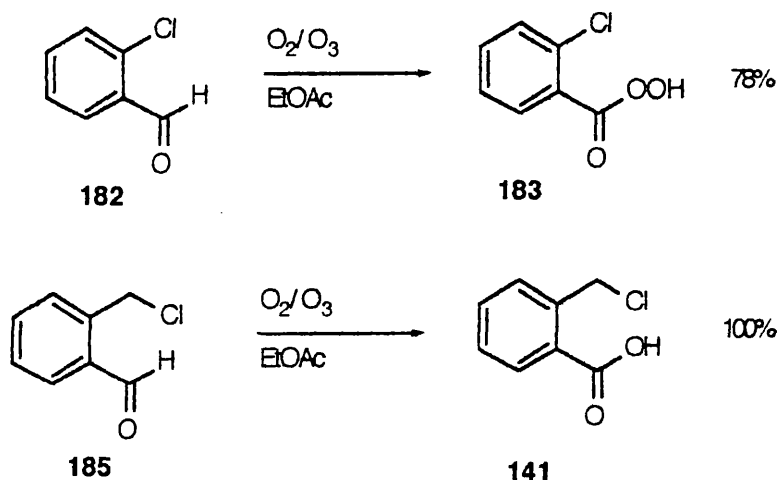

Scheme 4.18 Ozonolysis of aldehydes

Bailey ¹¹¹ has suggested the following scheme for the ozonation of aldehydes.

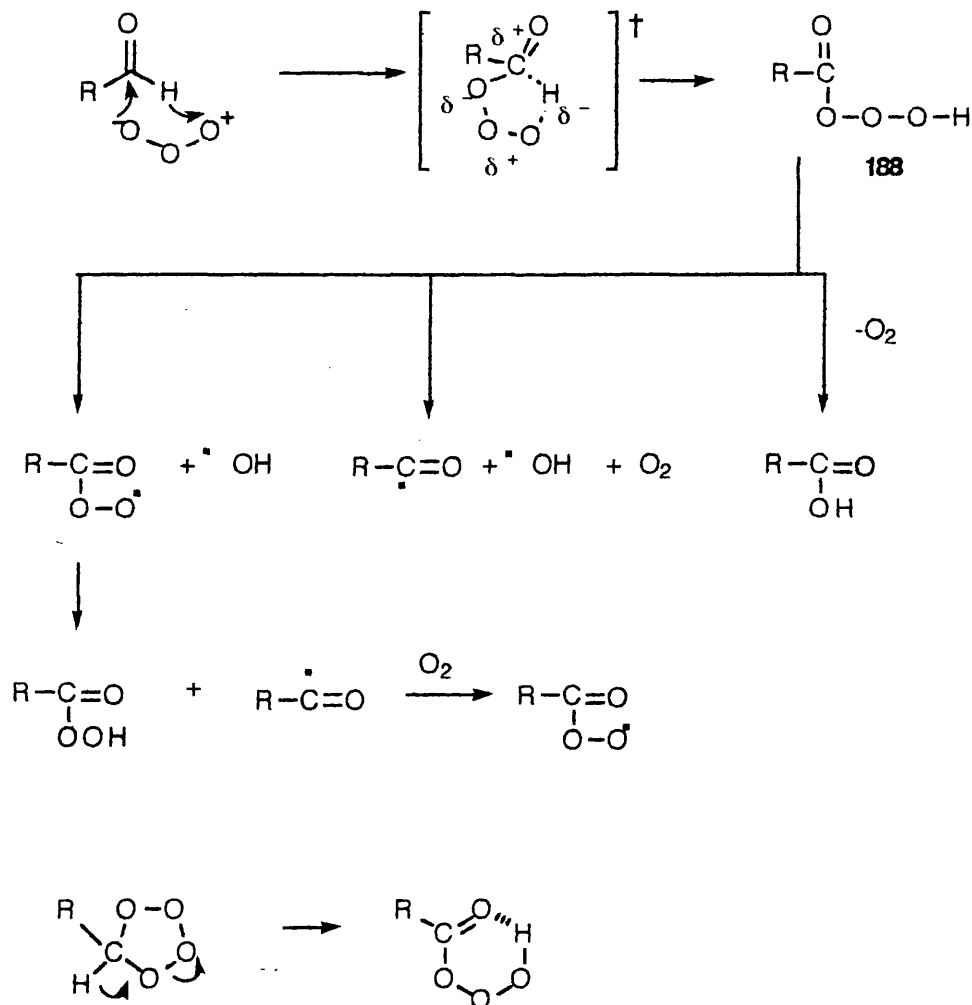

Scheme 4.19 The mechanism of ozonolysis of aldehydes

We concluded that we were not able to initiate the formation of hydrotrioxide **188** rapidly enough and that any intermediate peroxyacid formed was consumed

by unreacted aldehyde to form two moles of carboxylic acid. Given this result and the difficulty of preparing enough aldehyde to repeat the reaction on the scale indicated by Dick and Hanna, the route to peroxyacids via ozonolysis was not pursued further.

4.5 Hemiacetalised hydrogen peroxide

Typically the methods described for making peroxyacids have been characterised by prolonged reaction times with concentrated hydrogen peroxide under strongly basic or acidic conditions. Our initial suspicions that these conditions would enhance the formation of phthalide without the interaction of the peroxyacid have been confirmed. An alternative strategy has been developed by Dussault and Sahli¹¹² using a hemiacetalised hydrogen peroxide (2-methoxyprop-2-yl hydroperoxide **190**). The general procedure of using an iminoanhydride and hydrogen peroxide to prepare a peroxyacid had been developed some years earlier by Staab et al.¹¹³.

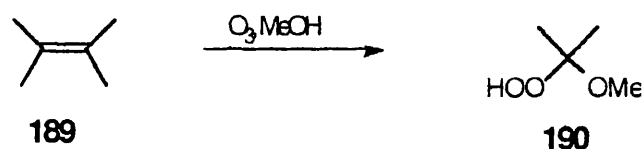

Scheme 4.20 2-Methoxyprop-2-yl hydroperoxide formation

Compound **190** was prepared by the ozonolysis of tetramethylethylene **189**. On treatment of a carboxylic acid with DCC they obtained an iminoanhydride which was treated with **190** to afford the peracetal **191**. This peracetal could be deprotected with wet acetic acid to give the peroxyacid (i.e. exceptionally mild conditions)

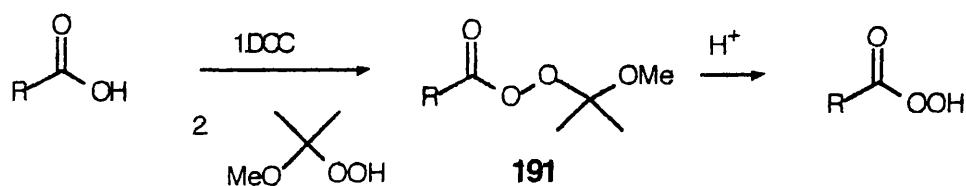

Scheme 4.21 Dussault and Sahli peroxyacid preparation

ortho-Bromomethylbenzoic acid **192** was prepared in the usual fashion from toluic acid **193** and NBS¹¹⁴. The acid was then treated with DCC and DMAP to prepare the iminoanhydride **194**.

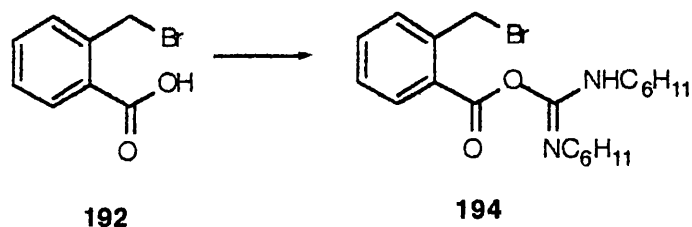

Scheme 4.22 Iminoanhydride formation

The iminoanhydride **194** yielded the peracetal **195** on treatment with 2-methoxyprop-2-yl hydroperoxide **190** and this peracetal could be deprotected cleanly with 90% acetic acid to compound **177** although the deprotection was much slower than that reported for the peroxyacids synthesised by Dussault and Sahli.

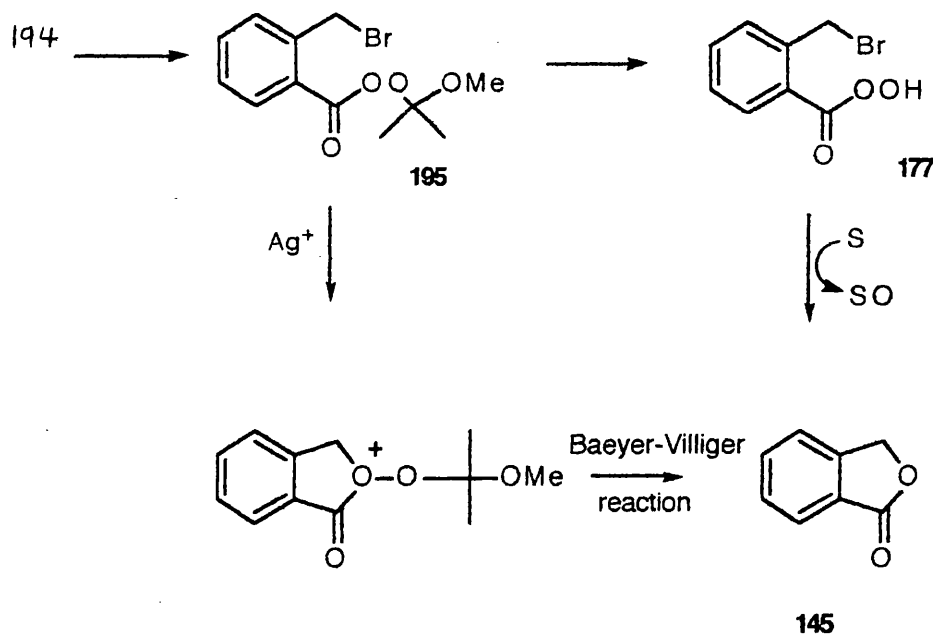

Scheme 4.23

We thought that the the reactivity of the peracetals formed as precursors to the peroxyacids in this methodology could also be evaluated for their potential to form peroxonium ions (see scheme 4.23).

4.6 *t*-Butyl perester preparation

The synthesis of the t-butyl peresters is related to this work. These were prepared from the acyl chlorides by treatment with t-butyl hydroperoxide in toluene with pyridine¹¹⁵.

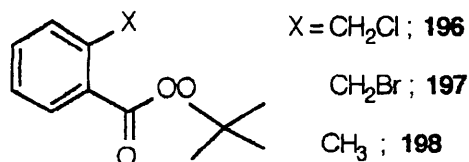

Somewhat to our surprise this was a clean high-yielding reaction from *ortho*-chloromethylbenzoyl chloride. With *ortho*-bromomethyl benzoylbromide it was necessary to purify the product by column chromatography because of contamination with phthalide. We supposed that on treatment with silver trifluoroacetate these compounds would ring-close to form a peroxonium ion which would rearrange by the Baeyer-Villiger mechanism to give 2,2-dimethoxypropane. It would seem somewhat surprising that we were able to produce the t-butyl peresters by this method and yet were unable to prepare the peroxyacids under similar conditions with hydrogen peroxide in pyridine.

Our attempts to form acyl alkyl peroxonium ions from t-butyl peresters are described in Chapter 5. One explanation for the formation of these peresters and yet our inability to form the related peroxyacids is the bulkiness of the t-butyl group. This may make the approach of the peroxide group towards the *ortho* halomethyl group difficult or impossible.

4.7 Summary

Our general approach to the acyl alkyl peroxonium ion has been as follows.

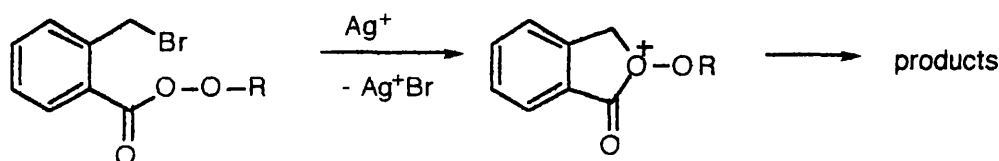

R = CMe₃ , CMe₂(OMe) , H

Scheme 4.24

Because of the propensity of *ortho*-halomethylbenzoic acids to form phthalide the usual methods for the preparation of peroxyacids are not applicable to the formation of *ortho*-halomethylperbenzoic acids. The newly developed procedure of Dussault and Sahli¹¹² provides a route to the required peroxyacids presumably because of the exceptionally mild conditions. The unsuccessful methods we used to prepare peroxyacids are summarised in the table.

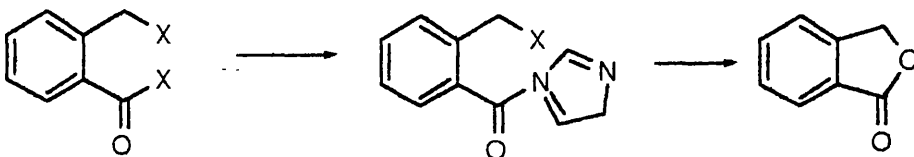
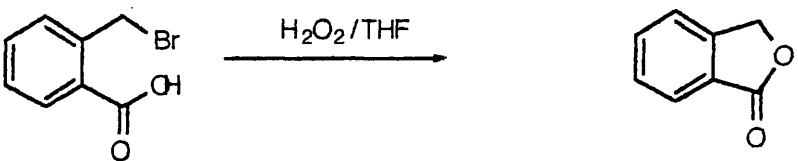
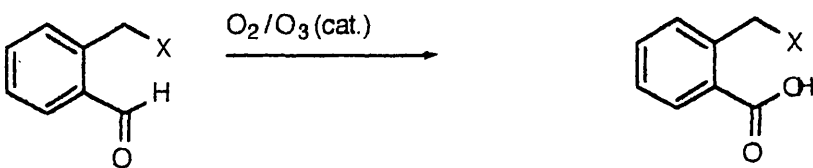
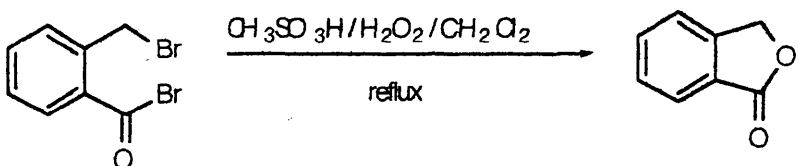
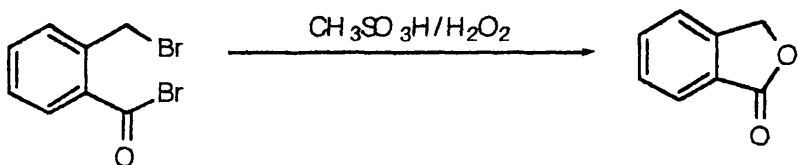
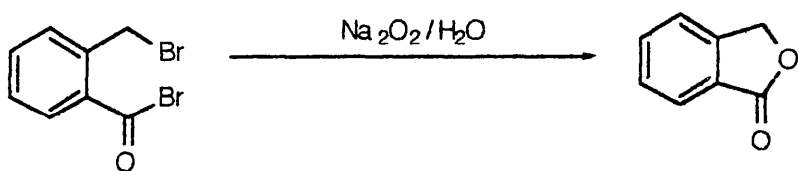
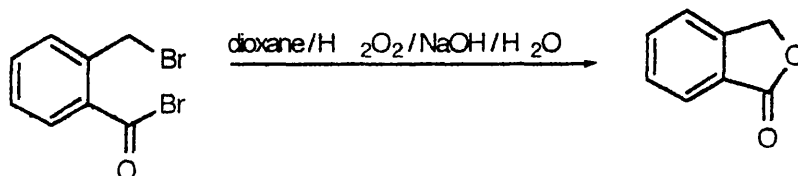
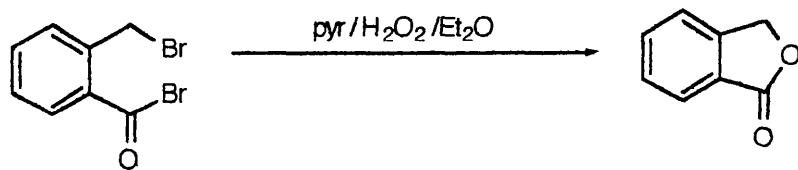

Experimental

Phthalide 145

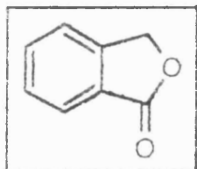

Authentic phthalide was obtained from Aldrich with the following physical characteristics.

^1H NMR: δ 5.32 (2H, m), 7.25-7.94 (4H, m) ¹¹⁶

^{13}C NMR: δ 69.53, 122.00, 124.92, 125.18, 128.48, 133.58, 146.31, 170.41

mp 72-74°C

ortho-Bromomethylbenzoyl bromide 178

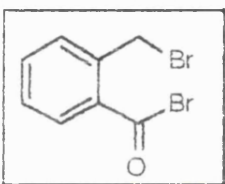

This was prepared according to the method of Davies and Perkin¹¹⁷ in a yield of 54% (b.p. 144-154 °C 32 mm Hg) as a low-melting point solid which crystallised after two weeks at 25°C

^{13}C NMR (50 MHz): δ 164.62, 138.58, 135.84, 134.70, 133.62, 131.74, 129.12, 30.31.

^1H NMR (200 MHz): δ 4.71-4.78 (2H, s), 7.4-8.3 (4H, m)

MS: Calcd for $\text{C}_8\text{H}_7\text{O}^{79}\text{Br}_2$ 275.87854 Obsd 275.86881

1:2:1 pattern at 275, 277, 279 i.e. 2 bromine atoms present.

Preparation of *ortho*-chloromethylbenzoic acid 141.

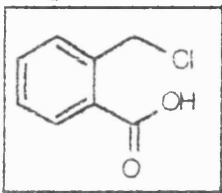

We prepared this either by irradiation of *ortho*-toluic acid and sulfuryl chloride with UV irradiation or by reflux alone for a longer period in accordance with the method of Riad¹⁰⁸. Recrystallisation from chloroform gave **141** in yields ranging from 36-57%.

^{13}C NMR (100 MHz) (DMSO): δ 167.87, 138.12, 132.26, 131.26, 130.73, 130.24, 128.71, 44.19

Reaction of *ortho*-chloromethylbenzoic acid with hydrogen peroxide in methanesulfonic acid.

ortho-Chloromethylbenzoic acid (0.395 g, 2.3 mmol) was made into a slurry with methanesulfonic acid (0.5 mL) with stirring at room temperature. Hydrogen peroxide (0.2 mL, 86%) was added dropwise to the rapidly stirred mixture and on completion ^{of the addition} allowed to stir for 2 h. Saturated ammonium sulfate solution (10 mL) was added. The aqueous layer was then extracted with benzene (3 x 10 mL) and the benzene extracts dried with sodium sulfate, filtered and the solvent removed to afford 0.369 g colourless crystals. ^1H NMR suggested a mixture of the peroxy acid and starting material.

^1H NMR (60 MHz): δ 11.4-11.85 (bs, 2H), 7.2-8.3 (4H, m), 5.0 (2H, s), 5.2 (2H, s)

Integration indicates that the area of the signal at δ 11.4-11.85 is approximately twice the combined area of the signals at δ 5.0 and δ 5.2 suggesting exchange of the acid proton with the peroxy acid proton and that there was approximately 50% of each in the product mixture.

Reaction of *ortho*-bromomethylbenzoic acid with hydrogen peroxide in methanesulfonic acid.

ortho-Bromomethylbenzoic acid (0.432 g, 2.01 mmol) was slurried with methanesulfonic acid (3 mL) with vigorous stirring and hydrogen peroxide (0.180 mL, 86%) added over 90 s and the solution left to stir for 2 h. The solution turned orange with the evolution of bromine. Saturated ammonium sulfate (3 mL) was then added and the product was extracted with benzene (3 x 4 mL) and the benzene layer washed with saturated ammonium chloride (2 x 6 mL) and dried with anhydrous sodium sulfate. The solution was filtered and stripped of solvent giving a white solid (0.194 g, 72%) whose identity was confirmed as phthalide by TLC. The absence of peroxide was noted by testing with iron(II) thiocyanate spray.

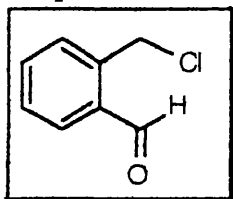
Preparation of *ortho*-chloromethylbenzaldehyde 185

ortho-Chloromethylbenzoyl chloride was prepared by treating *ortho*-chloromethylbenzoic acid with oxalyl chloride in benzene and DMF in 85% yield (b.p. 212-215 °C, 750mm Hg)

^{13}C NMR (50 MHz): δ 167.33, 139.12, 134.84, 134.25, 133.32, 131.11, 129.03, 44.02

^1H NMR (60 MHz): δ 4.8 (2H, s), 7.0-8.25 (4H, m)

In a 3-neck 250ml round-bottomed flask was placed cadmium chloride (4.64 g, 25.3 mmol) in acetonitrile (25mL) under argon with stirring. Sodium borohydride (0.76 g, 20 mmol) was dissolved in DMF (5 mL) and acetonitrile (40 mL) was added by a pressure equalising funnel at 0-5 °C. After 10 min the mixture was cooled to -30 °C. The acid chloride was added over 15 min and stirred for a further 15 min, then quenched with hydrochloric acid (25 mL ~2M) and allowed to warm to room temperature over 1 h. The cadmium salts were filtered off and ether (100 mL) was added to the filtrate. The aqueous layer was separated and extracted with ether (150 mL + 3 x 75 mL). The combined ethereal extracts were washed with saturated sodium bicarbonate solution (2 x 150mL) and saturated sodium chloride solution (2 x 150 mL), dried with magnesium sulfate, filtered, and the solvent removed. TLC of the crude reaction mixture showed that two products were present. Chromatography with 70 g of silica afforded *ortho*-chloromethyl benzaldehyde (1.06 g, 6.87 mmol, 34%) and *ortho*-tolualdehyde.

***ortho*-chloromethylbenzaldehyde**

^{13}C NMR (50 MHz): δ 192.06, 138.49, 133.88, 133.49, 133.13, 130.63, 128.82, 42.84.

^1H NMR: δ 4.95 (2H, s), 6.8-7.9 (4H, m) 9.85 (1H, m)

MS: Calcd for $\text{C}_8\text{H}_7\text{O}^{35}\text{Cl}$ 154.0185 Obs 154.0179

Calcd for C₈H₇O³⁷Cl 156.0155 Obs 156.0194

Ozonation of *ortho*-chloromethylbenzaldehyde.

The general procedure of Dick and Hanna¹⁰⁹ was followed on a *considerably reduced scale* using a potential of 60 V at 5 psi oxygen. In a 3 neck round-bottomed flask fitted with gas dispersion tube and solid CO₂ condenser was placed distilled ethyl acetate (40 mL). Ozone/oxygen was bubbled through the solution for 1 h. The aldehyde (0.590 g, 3.8 mmol) was dissolved in ethyl acetate (10mL) and added via a syringe in one portion to the presaturated ethyl acetate solution at room temperature. After 30 min no detectable aldehyde remained as determined by TLC and the ozone stream was stopped. Nitrogen was bubbled through the solution for 10 min and the solution concentrated to afford 0.640 g material which on titration showed no detectable peroxide. ¹³C NMR showed this to be *ortho*-chloromethylbenzoic acid on comparison with an authentic sample.

Preparation of benzimidazolides

Benzimidazolides were prepared according to the method of Staab^{118,119} and perhydrolysis was attempted using the method of Folli and Iarossi^{120,121}. The attempted preparation of *ortho*-pertoluic acid outlines the general procedure.

ortho-Toluoyl chloride (1.3 mL ~1.54 g, 10 mmol) was dissolved in freshly distilled anhydrous THF (50 mL) and added to the stirred solution of imidazole (1.36 g, 20mmol) (freshly recrystallised from dichloromethane) in THF (30 mL) under nitrogen. The imidazolium hydrochloride was filtered off and the volume of filtrate reduced to 10 mL. The imidazolidine solution was then added dropwise to a mixture of 30% hydrogen peroxide (2 mL, 0.018 mol) and potassium hydroxide (1.74g, 0.031 mol) in aqueous ethanol (1:1; 12mL) over 3 min. The reaction mixture was stirred over 5 min and extracted with cold chloroform (30 mL + 2 x 10 mL). The chloroform layer was discarded and the aqueous layer was acidified with 10% sulfuric acid. The aqueous layer was then extracted with chloroform (3 x 15 mL) and the chloroform extracts washed with water (1 x 10 mL), saturated ammonium sulfate (1 x 10 mL) and water (1 x 10mL) and then dried with sodium sulfate to afford 0.698 g of a white solid. ¹³C NMR showed that this was *ortho*-pertoluic acid and toluic acid in the ratio 2:3.

ortho-Chloromethylbenzimidazole was prepared in a similar fashion to that described for *ortho*-toluoyl benzimidazole. In all cases of attempted perhydrolysis no peroxyacid separated when the product was triturated with light petroleum (b.p. 30-40 °C).

***ortho*-Toluoylbenzimidazole 180**

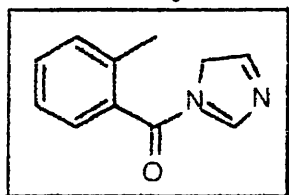

^{13}C (50MHz): δ 166.35, 137.83, 134.70, 134.67, 131.80, 131.28, 130.77, 128.04, 125.66, 117.30, 19.36.

^1H NMR (200 MHz): δ 2.25 (3H, s), 7.15 (2H, s) (7.20-7.70 (4H, m), 7.85 (1H, m)

***ortho*-Chloromethylbenzimidazole 199**

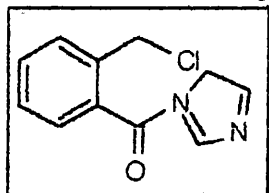

^{13}C (50MHz): δ 165.75, 132.44, 131.57, 130.93, 130.79, 128.96, 128.44, 42.68.

^1H NMR (200MHz): δ 4.75 (2H, s) 7.25 (2H, s) 7.28-7.85 (4H, m) 8.15 (1H, m)

2-Methoxyprop-2-yl *ortho*-chloromethylbenzoyl peroxide 200

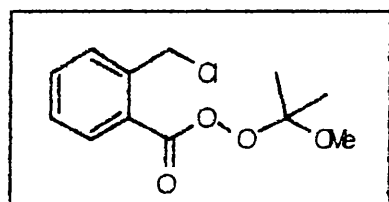

^{13}C NMR: δ 22.54, 43.46, 49.81, 107.32, 126.72, 128.39, 130.05, 132.71, 138.33, 164.37.

R_f: 10% ethyl acetate/ 90% hexane 0.33

Calcd for C₁₂H₁₅O₄Cl C 55.71, H 5.84 Found C 56.04, H 5.91

2-Methoxy prop-2-yl *ortho*-bromomethylbenzoyl peroxide 194

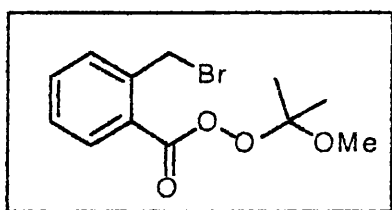

^1H NMR: δ 1.50 (6H, s), 3.37 (3H, s), 4.81 (2H, s), 7.24 -7.88 (4H, m)

^{13}C NMR: δ 22.58, 30.23, 49.92, 107.37, 126.69, 128.46, 130.34, 131.60, 132.79, 138.85, 164.32.

IR: neat 1757, 1486, 1381, 1369, 1225, 1182, 1144, 1069, 819 cm⁻¹

R_f: 7.5% ethyl acetate / 92.5% hexane 0.20

Calcd for C₁₂H₁₅O₄Br C 47.54, H 4.99 Found C 47.39, H 4.95

***t*-Butyl *ortho*-methoxymethylperbenzoate 197**

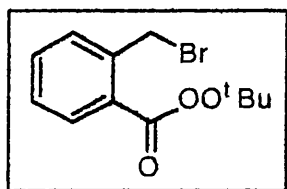

^1H NMR: δ 1.35 (s, 9H), 4.75 (s, 2H) 7.1-7.8 (4H, m)

^{13}C NMR: δ 26.31, 30.39, 84.22, 127.10, 128.55, 130.27, 131.75, 132.78, 138.98, 164.76

***t*-Butyl *ortho*-bromomethylperbenzoate 201**

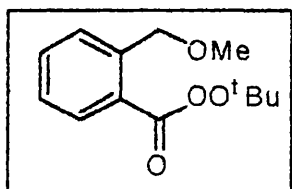

^{13}C NMR: δ 26.15, 58.58, 72.06, 84.05, 126.06, 127.35, 128.31, 129.47, 132.58, 139.82, 165.45.

Reaction of *ortho*-bromomethylbenzoyl bromide with hydrogen peroxide and silver trifluoroacetate in ethereal solution.

86% Hydrogen peroxide was first dissolved in sodium-dried ether and the resultant solution dried with magnesium sulfate and filtered to give an anhydrous ethereal hydrogen peroxide solution (~0.546 M).

This ethereal hydrogen peroxide (10 mL, 5.46 mmol) was added by means of a dropping funnel to a stirred solution of the acyl bromide (1.44 g, 5.18 mmol) in ether (10 mL) with stirring over 30 min. The solution turned bright orange almost immediately with an evolution of bromine. Silver trifluoroacetate (1.23 g, 5.69 mmol) was then added in one portion. Further vigorous effervescence ensued and the mixture was stirred for a further 30 min. Dichloromethane (15 mL) was then added and the solution filtered from the silver salts. The filtrate was washed with saturated sodium bicarbonate solution (3 x 15 mL), dried with magnesium sulfate, filtered and the solvent removed to afford a light amber solid (0.455 g, 3.39 mmol) of phthalide by comparison with ^{13}C NMR of authentic material.

^{13}C NMR (50 MHz) : δ 171.31, 146.44, 134.18, 128.91, 125.56, 125.42, 125.37, 122.03, 69.70.

Reaction of *ortho*-bromomethylbenzoyl bromide with hydrogen peroxide in ether.

The procedure above was repeated in the absence of silver trifluoroacetate on a similar scale and the reaction was quenched and worked up at the 30 min stage to yield 81% phthalide.

Reaction of *ortho*-bromomethylbenzoyl bromide with hydrogen peroxide in basic aqueous medium.

The procedure of Speakman¹²² was adopted using 2 mmol of the acyl bromide. Final extraction of the product into deuteriochloroform revealed only the presence of phthalide (¹³C NMR).

Reaction of *ortho*-bromomethylbenzoyl bromide with ethereal hydrogen peroxide and pyridine

The acyl bromide (1.52 g, 5.46 mmol) in dry ether (10 mL) was cooled to 0 °C with stirring. To the ethereal hydrogen peroxide solution (10 mL) prepared previously, pyridine (0.45 mL, 5.56 mmol) was added dropwise with stirring. This solution was then added dropwise to the stirred solution of acyl bromide. A precipitate of pyridinium hydrobromide formed during the 30 min of addition; the precipitate was filtered off and the reaction mixture was worked up as previously described to afford 0.438 g of a mixture that was predominantly phthalide (TLC and ¹³C NMR spectroscopy) (~60% recovery phthalide)

DABCO.H₂O₂ complex 179

This was prepared according to the method of Davies et al.¹⁰⁵

Reaction of DABCO.H₂O₂ complex with the bromoacyl bromide

DABCO.H₂O₂ complex (0.50 g, 3.42 mmol) was made into a slurry with dry ether (4 mL). This was then cooled to 0 °C. The acyl bromide (1.73g, 6.22 mmol) in dry ether (4mL) was then added dropwise over 5 min to the stirred slurry which thickened and became almost solid. The reaction mixture was left to stir for a further 1 h then allowed to warm to room temperature. The solids were separated by filtration and the filtrate washed with water (2 x 5 mL), dried and concentrated to afford 0.55 g material with the following spectra.

¹H NMR (60 MHz)(CD₃OD): δ 6.6-7.85 (complex m, 4H), 5.3-5.6 (s, 1H), 4.5-4.8 (m, 2H). TLC revealed that no peroxide positive material was present.

Reaction of *ortho*-bromomethylbenzoyl bromide with hydrogen peroxide in THF.

The procedure of Nedelec, Sorba and Lefort¹⁰³ was followed as described for alkanoyl chlorides (no pyridine); 1.152 g of material was recovered. This sample was peroxide positive as determined by iron(II) thiocyanate spray and an attempt was made to purify the product using pH 7.5 buffer (NaH₂PO₄·2H₂O/ NaOH). We attempted to work up the product in a similar fashion to that described for the recovery of mcpba from a mixture of mcpba and *meta*-chlorobenzoic acid with buffer. This resulted in a recovery of 31% of the original material that was consistent with the *ortho*-bromomethylbenzoic acid.

¹³C NMR (50 MHz)(CD₃OD/CDCl₃) : 168.4, 138.9, 132.0, 131.2, 131.0, 128.0, 31.0 This product did not contain peroxide as determined with iron(II) thiocyanate.

Reaction of *ortho*-bromomethylbenzoyl chloride with sodium peroxide.

A solution of sodium peroxide (0.553 g, 7.10 mmol) was prepared in water (10 mL) and cooled to below room temperature. The solution was then filtered into a 50 mL round bottomed flask and ethanol (12 mL), magnesium sulfate (16 mg, 0.13 mmol) in water (1 mL) were added. The solution was allowed to warm to room temperature and the melted bromoacyl bromide (1.93 g, 6.98 mmol) added dropwise to produce an immediate flocculent white precipitate. After 10 min the solution was filtered and acidified (20% H₂SO₄; 22 mL) at which point the filtrate yellowed. The filtrate was extracted with chloroform (4 x 10 mL) and stripped of solvent to afford 0.985 g material which reacted strongly with iron(II) thiocyanate spray. This was stored in the freezer overnight but remained oily. The product was triturated with light petroleum (b.p. 30-40 °C) and crystallised out at -27°C after 48 hours. The ¹³C NMR showed this to be predominantly phthalide.

Polymer-supported hydrogen peroxide

The resin described by Pande and Jain⁹⁹ was unavailable and substituted with Amberlite® IR-120(plus). The polymer-supported peroxyacid was prepared using 85% hydrogen peroxide. We were unable to prepare *meta*-chlorobenzoic acid as described by the authors and with *ortho*-bromomethylbenzoic acid only starting material was ever isolated.

5. Applications and oxidations with *ortho* halomethyl peroxy acids

5.1 Reactions of the t-butyl peresters

Although not able to perform oxygen transfer chemistry, t-butyl peresters might provide evidence that acyl alkyl peroxonium ions can be formed. Thus we hoped that ring closure would result in the formation of a peroxonium ion which after Baeyer-Villiger rearrangement would form phthalide and in methanol 2,2-dimethoxypropane (see scheme 4.23).

On treatment of the t-butyl peresters **196** and **197** with silver trifluoroacetate in THF or in dichloromethane, no reaction was observed as assessed by TLC, even after several hours.

In the more polar solvent methanol, the expected phthalide was still not obtained but rather t-butyl *ortho*-methoxymethylperbenzoate **199**. Even this reaction was slow and required reflux to go to completion.

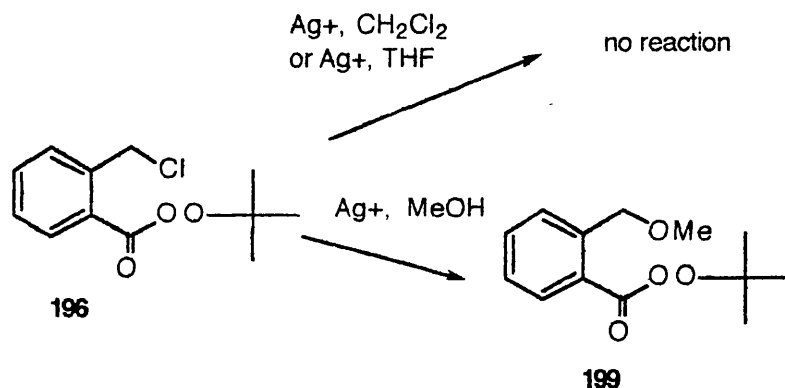

Scheme 5.1 Reaction of *ortho*-chloromethyl t-butyl perbenzoate with silver trifluoroacetate.

In order to confirm that product **199** had been formed rather than isomer **200** arising from the migration of the t-butyl peroxy group (scheme 5.2) we treated the product with potassium hydroxide and it was shown that *ortho*-methoxymethyl benzoic acid **201** was obtained (scheme 5.3).

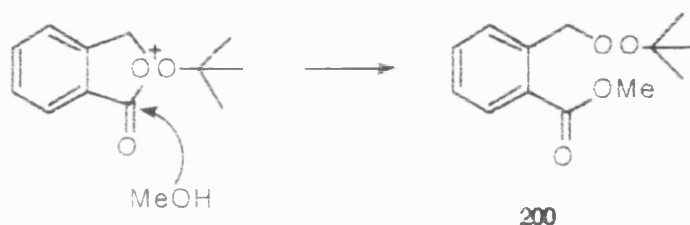

Scheme 5.2 The possible migration of the t-butyl peroxy group in a nucleophilic attack on the acyl alkyl peroxonium ion

The formation of **199** suggests that intramolecular ring closure is more difficult than intermolecular solvolysis. This *could* be due to steric bulk of the t butyl group (though trialkylperoxonium ions have been prepared by others). More plausible an explanation is the fact that the nucleophilicity of the epoxidic oxygen is reduced by the presence of the adjacent carbonyl group (electronic effect).

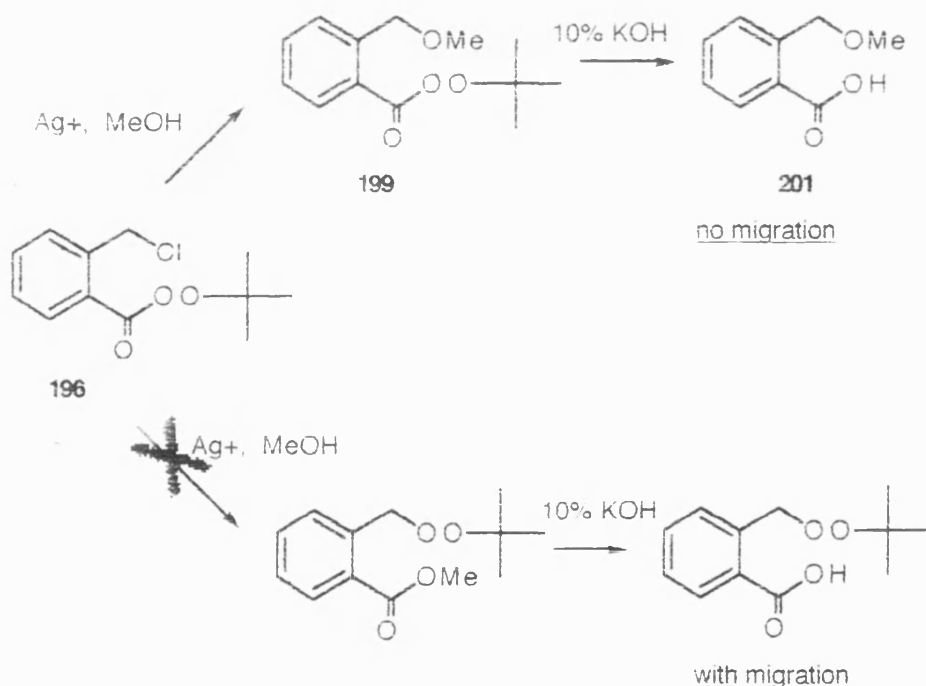

Scheme 5.3 Saponification of the reaction product from scheme 5.1 confirms it is **199** and **not** the product from migration **200**

To gain further insight into the solvolysis, we carried out a competition experiment. We took one equivalent of benzyl chloride **202** and one equivalent of the t-butyl perester **196** and treated the mixture with one equivalent of silver trifluoroacetate in methanol (scheme 5.4). The products of this reaction were

benzyl methyl ether **203** (from benzyl chloride) and unchanged *t*-butyl perester **196**. Benzyl methyl ether was prepared independently by treating benzyl chloride with silver trifluoroacetate in methanol affording an identical product to that obtained in the competition reaction.

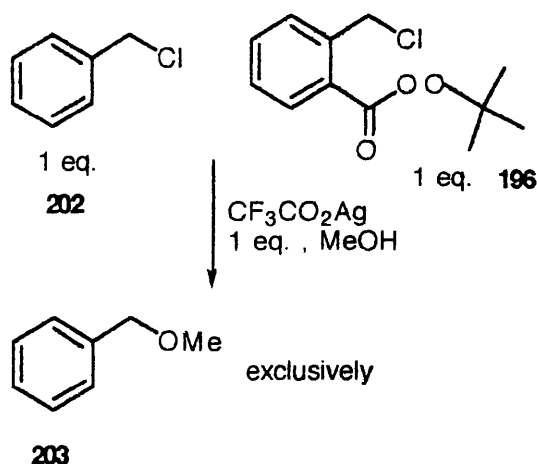

Scheme 5.4 Competition experiment involving benzyl chloride and *ortho*-chloromethyl *t*-butyl peroxybenzoate

The result of the competition experiment shows that far from activating the benzoyl chloride **196** to solvolysis (as expected for a peroxonium ion mechanism) it actually *deactivates* the molecule. This deactivation might be sterically and/or electronically based.

5.2 Peroxyacid evaluation: wash test

Notwithstanding the results with the *t*-butyl peresters described in section 5.1, we still hoped that acyl alkyl peroxonium ion formation from *ortho*-halomethyl peroxyacids might be possible and that this might provide the basis for a bleach activator system. Because phthalide formation occurred in the absence of silver salt on treatment of *ortho*-halomethyl benzimidazolides with basic hydrogen peroxide this might indicate that silver salt is not required in the reaction at all. We chose the imidazolides as possible peroxyacid precursors for evaluation in a wash test, as the source of hydrogen peroxide in washing powder formulations is sodium perborate (i.e. basic hydrogen peroxide). The performance of certain imidazolides as bleach activators has been evaluated by Fine¹⁰⁶. The wash test is supposed to simulate washing conditions using standardised materials. A perborate based detergent (activator free) was dissolved in French hardness water (water containing salts found in 'typical' tap water). The test activators

(imidazolides) were then added with artificially (red wine) stained swatches. The swatches were washed by stirring for 30 minutes in a dimpled Buchi flask. After rinsing with distilled water and drying their reflectance was measured. Our test imidazolides matched up to the currently most popular bleach activator TAED but were *not significantly* better. More importantly *ortho*-chloromethyl benzimidazole was no better as a bleach activator than the corresponding methyl compound providing no evidence for an intermediate other than the peroxyacids in the bleaching of the test swatches.

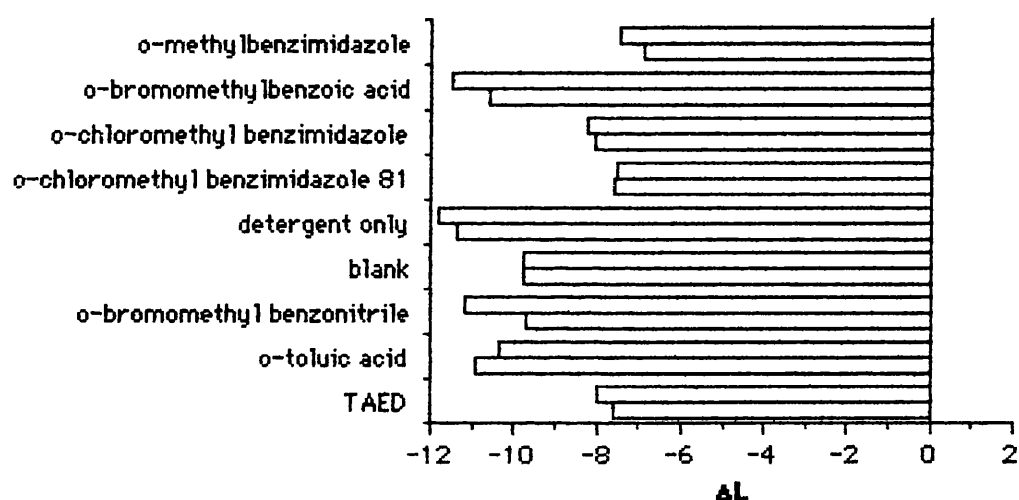

Figure 5.1 Graph of *Total Reflected Light* or *Whiteness* values, L , measured on the ICS Micromatch System.TM. The ΔL values are all relative to a white tile (very high L). The high negative ΔL values, e.g. detergent only, are from the least white (most red cloths). Runs completed in duplicate.

We suspected that the difference in reactivity between a peroxyacid and the putative acyl alkyl peroxonium ion might be difficult to detect using this relatively insensitive test particularly as benzimidazolides are very susceptible to hydrolysis. We thus attempted to evaluate the reactivities of these *ortho* halomethyl peroxyacids using methods more familiar to the synthetic chemist.

5.3 Peroxyacid evaluation: chemical substrates

The rate of epoxidation by peroxyacids is increased by electron withdrawing groups in the peroxyacid and electron donating groups in the alkene. The rate of reaction is thus increased by increasing alkyl substitution in the alkene. Electron deficient alkenyl groups such as those in conjugation with electron withdrawing groups, e.g. carbonyl and alkoxy carbonyl, require strong peroxyacids (e.g. peroxytrifluoroacetic acid) for epoxidation to be achieved. More commonly epoxidation of enones is achieved with basic hydrogen peroxide or alkyl

hydroperoxides. This is thought to occur by the initial Michael type *nucleophilic* addition of the peroxide species on the α,β unsaturated system.

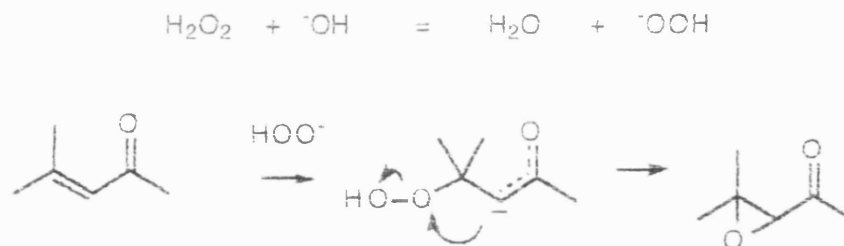

Scheme 5.5 Nucleophilic epoxidation of enones

The difficulty in achieving electrophilic epoxidation with such enones makes them suitable substrates for evaluation of compounds with a putative reactivity greater than peroxyacids. Mitchell¹²³ had used isophorone **204** to evaluate the oxygen transfer properties of the dialkyl peroxonium ion obtained from 1,8-bis-bromomethylnaphthalene with silver tetrafluoroborate and hydrogen peroxide, but had not observed isophorone oxide **205** formation.

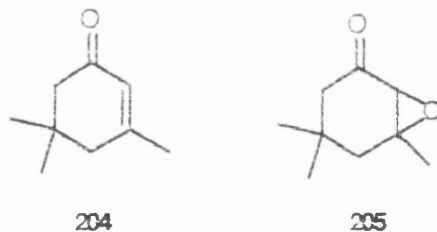

In our case the reaction of *ortho* halomethyl peroxyacids with silver trifluoroacetate and isophorone also gave no isophorone oxide as noted by comparison of the characteristic singlet adjacent to the alkene group in the ^1H NMR of isophorone and comparison with that in isophorone oxide. The products recovered were phthalide and unchanged isophorone.

5.4 Reactions with alkenes

Because *ortho* halomethyl groups produced no enhancement of reactivity of benzimidazoles in the wash test and because of the absence of isophorone oxide formation with the peroxyacids, we looked at the reactions of the peroxyacids with alkenes that are normally highly reactive peroxyacid substrates for

epoxidation. With *trans* stilbene no epoxide formation was observed as assessed by ^1H NMR.

The reaction of *ortho* bromomethyl peroxybenzoic acid with cyclohexene and silver trifluoroacetate was performed at -78°C in dichloromethane as the reaction at room temperature gave only phthalide and no cyclohexene oxide. On inspection of the ^1H NMR it appeared that we had formed cyclohexene oxide and phthalide in good yield. We attempted to purify the product by chromatography and recovered about 80% of the phthalide expected.

The reaction mixture appears to contain another polar product possibly the half ester of cyclohexane-1,2-diol **206**. This might explain why our attempted purifications lead to such a poor product balance (the trifluoroacetate moiety is very polar).

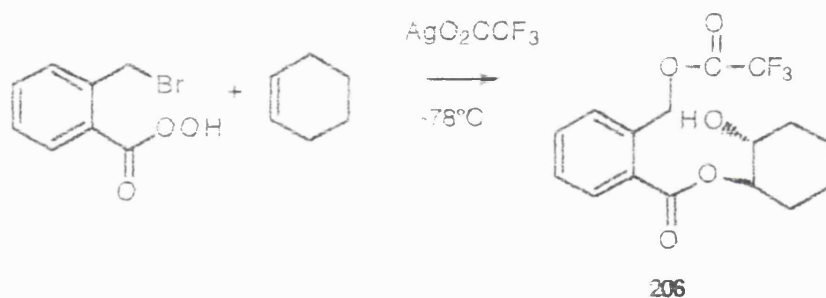

Scheme 5.6

In the absence of silver trifluoroacetate we obtain the expected acid and cyclohexene oxide. It might be expected that on prolonged exposure of the acid to the epoxide we might obtain the half ester of *ortho*-bromomethyl benzoic acid and cyclohexane-1,2-diol. This was not the case and no reaction was observed after several hours, standing at room temperature.



Scheme 5.7

On treatment of the mixture of acid and epoxide with silver trifluoroacetate, we obtained a complex product mixture that we were unable to purify by column chromatography but this had an identical ^1H NMR spectrum to that obtained

earlier (scheme 5.6). We obtained a good yield of phthalide and again what we presume to be **206**.

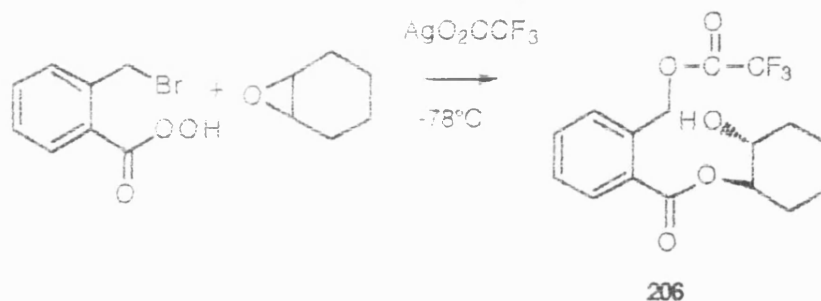

Scheme 5.8

These results suggest that the epoxidation is mediated by the peroxyacid group alone without the intervention of the benzylic halogen group.

We attempted an independent synthesis of the products we had presumed were formed. We could not use the conventional method of treating the acyl halide with diol under basic conditions (Schotten Baumann) as phthalide or **208** are likely to be formed.

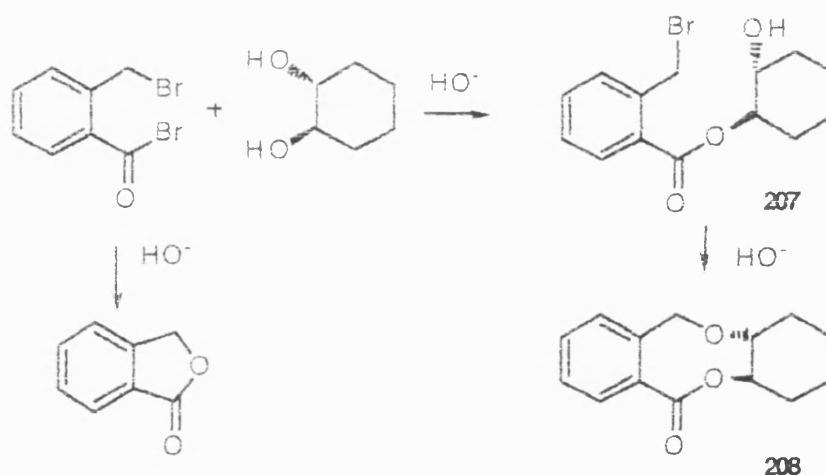

Scheme 5.9

We attempted to prepare the half ester **207** under neutral conditions by treatment of the iminoanhydride **194** with cyclohexane-1,2-diol. The diol was not soluble in most solvents (except very polar protic ones). This made the reaction of the diol with the activated ester impractically slow and extraneous moisture provided a competing reaction which simply caused hydrolysis back to the original acid.

We prepared the half ester **209** by the Schotten Baumann procedure and attempted to brominate it with NBS. Unfortunately bromination of the benzylic group was also accompanied by bromination of the alpha position of the cyclohexane ring affording intractable mixtures.

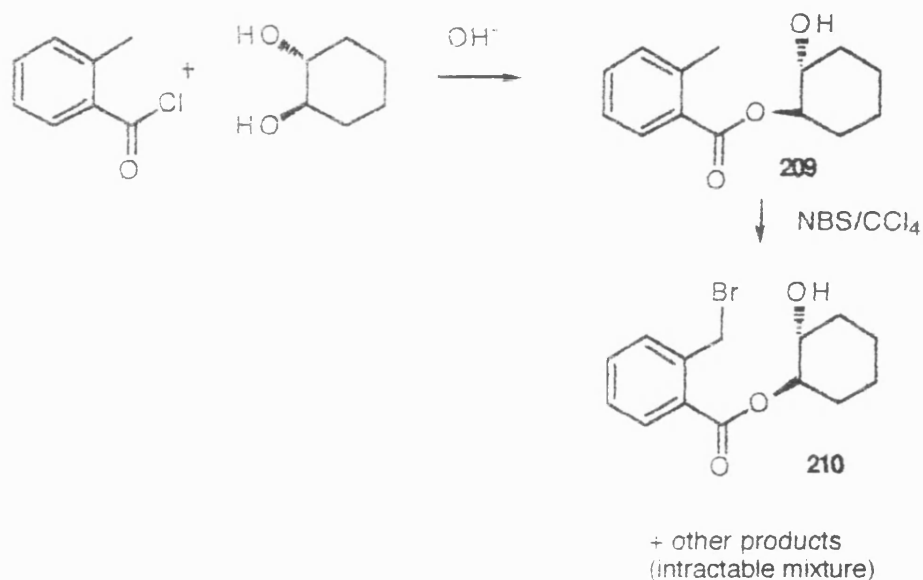

Scheme 5.10

Because of these difficulties we abandoned an authentic synthesis. In any case the reactions described are unremarkable and would be in accord with established chemistry.

5.5 The reactions of *ortho* hydroxymethyl benzenemethylamine

The observations of Kirmse and Kundl²⁴ with compound **211** *ortho* hydroxymethyl benzenemethylamine are particularly pertinent to this work. Compound **211** gives diol *ortho*-hydroxymethyl benzyl alcohol **212** exclusively on treatment with nitrous acid.

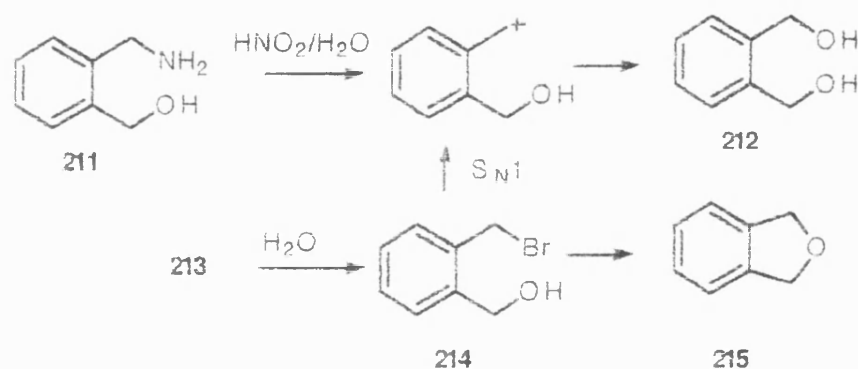

Figure 5.6 The reactions of *ortho* hydroxymethyl benzenemethylamine

The products from the hydrolysis of **213** are dependent on the concentration of base and solvent polarity. Decreasing the concentration of base or increasing solvent polarity increases the ratio of diol **212** to ether **215**. The ether **215** is preferred by $\text{S}_{\text{N}}2$ conditions. Polar solvents with excess silver salt favour $\text{S}_{\text{N}}1$ conditions and result in a predominance of the diol **212**. This is even in the absence of a carbonyl group which might localise any positive charge from carbocation formation at the benzylic site.

These results accord with our own experience with the *ortho*-halomethyl peroxyacids with silver salt. The results can simply be explained by oxidation by the peroxyacid and intermolecular solvolysis at the benzylic site followed by ring closure of the resultant peroxyacid to form phthalide, ie it is not necessary to invoke the intermediacy acyl alkyl peroxonium ion.

5.6 Conclusions

The *t*-butyl perester group deactivates compound **196** relative to benzyl chloride towards intermolecular solvolysis and the absence of any migration of the *t*-butyl peroxy group has been confirmed by subsequent saponification. *Ortho* halomethyl peroxybenzoic acids show no increase in reactivity when compared to related non halogenated peroxyacids either in a wash test or using the enone isophorone. The oxidation of cyclohexene with *ortho* bromomethyl peroxybenzoic acid is unremarkable and we infer that cyclohexene oxide is formed and is followed by addition of the carboxylic acid to form the monoester in the presence of silver salt. The studies of Kirmse and Kund on the compounds **211** and **213** confirm the idea that intramolecular ring closure under essentially $\text{S}_{\text{N}}1$ conditions is likely to be difficult. Accordingly there is no evidence to support the existence of the acyl alkyl peroxonium ion and our findings are adequately explained by established chemistry.

5.7 Experimental

Reaction of *ortho*-chloromethyl *t*-butyl peroxybenzoate with silver trifluoroacetate in dichloromethane.

The perester **196** (0.355 g, 1.46 mmol) was dissolved in dichloromethane (10 mL) and silver trifluoroacetate (0.485 g, 2.20 mmol) was added in one portion with vigorous stirring at room temperature. Over 1.5 h the reaction was monitored by TLC (80% light petroleum (b.p. 60-80 °C) and 20% ethyl acetate). No formation of phthalide or any other product was observed. The solution was then filtered, concentrated and the ^{13}C NMR spectrum recorded. This showed that the perester was unchanged. The perester solution was then concentrated redissolved in dichloromethane (20 mL) and a fresh portion of silver trifluoroacetate added (0.485 g, 2.20 mmol) added. The reaction mixture was brought to reflux for 1 h but no change was observed.

Reaction of *ortho*-chloromethyl *t*-butylperoxybenzoate with silver trifluoroacetate in methanol

The perester **196** (0.218 g, 0.898 mmol) was dissolved in methanol with vigorous stirring at room temperature. Silver trifluoroacetate (0.297 g, 1.34 mmol) was then added in one portion and the reaction mixture brought to reflux. After 90 min the reaction was judged complete as assessed by TLC and the reaction mixture was allowed to cool. The silver salts were then removed by centrifugation and the supernatant concentrated to afford the product (0.183 g, 0.768 mmol, 86%). A similar result was obtained by stirring the reaction mixture without reflux for 70 h.

^1H NMR: δ 1.9 (9H, s), 3.20 (1H, s), 7.3-8.2 (4H, m)

^{13}C NMR: δ 58.58, 72.06, 84.05, 126.06, 127.35, 128.31, 129.47, 132.58, 139.82, 165.45.

***ortho*-bromomethyl *t*-butyl peroxybenzoate**

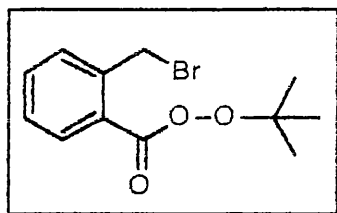

t-Butyl hydroperoxide solution (TBHP in toluene) (15 mL, 39.0 mmol) was placed in a one necked round bottomed flask fitted with a magnetic stirrer and micro dropping funnel. Pyridine (3.5 mL) was added in one portion with stirring and the solution cooled to 0 °C. The bromoacyl bromide (4.997 g, 17.97 mmol) was transferred under nitrogen to the dropping funnel by melting and dissolving whilst hot in toluene (10 mL). The bromoacyl bromide solution was added to the t-butyl hydroperoxide solution over 1.5 h. The solution was filtered and washed with iced water (30 mL). The water layer was extracted with toluene (2 x 25 mL) and the combined toluene extracts washed with 20% H₂SO₄, iced water (10 mL), 10% sodium carbonate (10 mL) and iced water (3 x 10 mL). The solution was dried with magnesium sulfate, filtered and concentrated to afford 2.18g of crude **197**.

The product was purified by column chromatography with 95.5% light petroleum (30-40 °C) 4.5% ethyl acetate to afford phthalide (0.350 g, 2.7 mmol) and **197** (1.321 g, 4.6 mmol, 26%)

t-butyl *ortho*- methoxy methyl perbenzoate **194**

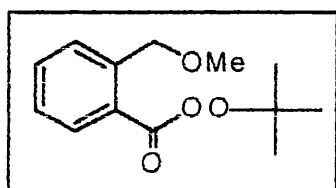

This was prepared in the same fashion as **196** from methoxymethyl benzoic acid.

ortho- methoxymethyl benzoic acid **196**

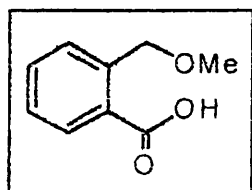

This was prepared by treatment of ortho bromomethyl benzoic acid with silver trifluoroacetate and purified by chromatography with ethyl acetate hexane.

Benzyl methyl ether **198**

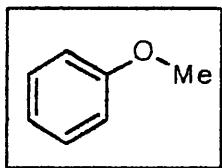

This was prepared from benzyl chloride and silver trifluoroacetate in methanol.

***ortho*-bromomethylbenzonitrile**

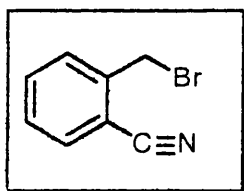

This was prepared by the method of Buckley ¹²⁵ from *ortho*-tolunitrile with NBS and benzoyl peroxide in CCl₄. The impure product was recrystallised from cyclohexane over 24 h to afford the product in 51% yield.

ECE colour fastness test detergent 77

Anionic Surfactant: Linear alkylated benzene sulfonates 8.0%

Non-Ionic Surfactant: Ethoxylated tallow alcohol 2.9%

Anionic Detergent: Sodium soap 3.5%

Builder: Sodium triphosphate 43.8%

Buffer/ Builder: Sodium & Magnesium silicates and Sodium ethylene diamine tetraacetate 7.5% + 1.9% + 0.2%

Coating: Carboxymethylcellulose 0.2%

Filler/ Granulation aid: sodium sulfate 21.2%

Balance: water 9.8%

Bleach activator wash test procedure

French Hardness water was prepared by dissolution of magnesium chloride hexahydrate (0.500 g) and calcium chloride (1.675 g) in distilled water (5.000 L).

To perform the wash test French hardness water (600 mL) was placed in a 2L dimpled (powder) Buchi flask and stirred using a Buchi rotavap assembly (no vacuum) in a thermostatted bath equilibrated at 40 °C for 20 min and maintained at this temperature for the wash period. Detergent base ECE no. 77 (2.400 g) was added with sodium perborate tetrahydrate (0.450 g) stirred for 20 s and the

test activator added (quantities as detailed below). After one min of agitation by hand the test swatches (3 pieces of EMPA 114 cotton measuring 100 mm x 30 mm) were added and the whole stirred at 150 r.p.m for 30 min. The swatches were then removed and vigorously stirred in distilled water (500 mL) for 30 s removed and shaken to dislodge water droplets and then dried in a G.C. oven at 60 °C. Assessment of the cloth bleaching was made measurement of reflectance on an ICS Micromatch™ spectrophotometer.

Activator	Amount mmol		Reflectance [‡]
			ΔL
<i>ortho</i> -chloromethylbenzimidazole	81mg	0.367	-7.63, -7.56
N,N,N,N-tetraacetyl ethylene diamine	60mg	0.306	-7.62, -7.99
<i>ortho</i> -chloromethylbenzimidazole	60mg	0.272	-8.07, -8.27
<i>ortho</i> -toluoyl benzimidazole	60mg	0.322	-6.91, -7.49
detergent + perborate only	*	*	-9.78, -9.81
<i>ortho</i> -bromomethyl bezonitrile	60mg	0.306	-9.74, -11.50
<i>ortho</i> -toluic acid	60mg	0.441	-10.96, -10.34
detergent alone	*	*	-11.37, -11.80

[‡]The more negative the reflectance value the better the performance of the activator in the wastest (see figure 5.1) Measurements were made in duplicate

Isophorone oxide preparation 200

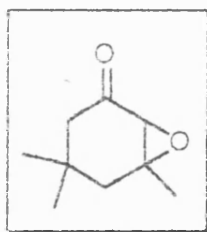

This was prepared from isophorone by the method of Wasson¹²⁶ using basic hydrogen peroxide.

Competition experiment between perester 196 and benzyl chloride.

The chloromethyl perester **196** (0.329 g, 1.35 mmol), benzyl chloride (0.168 g, 1.33 mmol) and silver trifluoroacetate (0.294g, 1.33 mmol) were dissolved in methanol (10 mL) and brought to reflux for 1h. The mixture was then filtered

through a pad of Celite™ and concentrated. The products were inferred by comparison with authentic materials.

Reaction of *ortho* bromomethyl perbenzoic acid 177 with isophorone.

ortho-Bromomethyl perbenzoic acid **177** (0.143g 0.665 mmol) was dissolved in dichloromethane (10mL), silver trifluoroacetate (0.177g, 0.801 mmol) and isophorone (0.184g, 1.331 mmol) were added in one portion. After 24h the solids were filtered through Celite™, the product concentrated and ¹H NMR recorded. This revealed that isophorone had remained unreacted by comparison with an authentic sample of isophorone oxide prepared from isophorone with basic hydrogen peroxide.

Reaction of *ortho* bromomethyl perbenzoic acid 177 with *trans* stilbene.

ortho-Bromomethyl perbenzoic acid **177** (0.099 g, 0.428 mmol) was dissolved in dichloromethane (3 mL) and *trans* stilbene (0.078g, 0.433 mmol) added followed by silver trifluoroacetate (0.113 g, 0.511 mmol) in one portion with stirring. After 1h the reaction was judged complete (no peroxide remained). The reaction mixture was worked up by washing with 1.5 mL saturated sodium bicarbonate filtering through Celite™. The ¹H NMR was then recorded this revealed only the presence of *trans* stilbene and no *trans* stilbene oxide.

Reaction of *ortho* bromomethylperbenzoic acid with cyclohexene in the absence of silver trifluoroacetate

Cyclohexene (0.033g 0.401 mmol) was dissolved in dichloromethane (2 mL) and cooled to -78 °C. The peracid (0.067 g, 0.312 mmol) was added on one portion with stirring and the mixture allowed to warm to room temperature over 1h. The solution was filtered to afford *ortho*-bromomethyl benzoic acid and the filtrate concentrated at reduced temperature to afford cyclohexene oxide (0.032 g, 0.33 mmol, 83%)

ortho Bromomethyl benzoic acid was stirred with cyclohexene in dichloromethane for 24 h. The solvent undissolved *ortho*-bromomethyl benzoic acid was filtered off and the solution concentrated at reduced temperature to afford cyclohexene alone.

Reaction of *ortho* bromomethylperbenzoic acid with cyclohexene in the presence of silver trifluoroacetate

Cyclohexene (0.033g 0.40 mmol) and silver trifluoroacetate (0.056 g, 0.253 mmol) were dissolved in dichloromethane (5 mL) with stirring and cooled to -78 °C. *ortho* Bromomethylperbenzoic acid **177** (0.045 g, 0.209 mmol) was dissolved in dichloromethane (0.5 mL) and added to the suspension with stirring. The mixture was allowed to warm to room temperature over 1.5 h and then filtered through Celite™ and concentrated at reduced temperature to afford 0.031 g material. The ¹H NMR of the crude product was recorded (this suggested a mixture of phthalide and cyclohexene oxide) followed by chromatography with 10% ethyl acetate 90% hexane to afford phthalide (0.023g 0.17 mmol). Stripping the column with methanol failed to displace the other product.

Reaction of *ortho* bromomethylbenzoic acid with cyclohexene oxide in the presence of silver trifluoroacetate

ortho Bromomethylbenzoic acid **192** (1.09 g, 5.06 mmol) was suspended in dichloromethane (25 mL). Cyclohexene oxide (0.98 g, 10 mmol) was added with stirring at -78 °C and the mixture allowed to warm to room temperature over 1h. The mixture was then filtered through Celite™ and concentrated at reduced temperature to afford 0.676 g material. The ¹H NMR of the crude product was recorded followed by chromatography with 10% ethyl acetate 90% hexane to afford phthalide (0.480 g 3.6mmol). The ¹H NMR of the crude material was identical to that of the material prepared as described above.

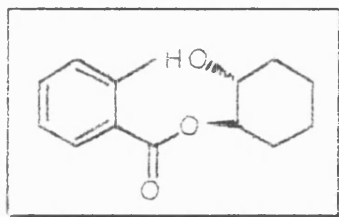
Preparation and attempted bromination of *ortho* toluic acid 1,2 cyclohexanediol half ester **209.**

Benzoyl chloride (8.4 mL, 64 mmol) was dissolved in pyridine (50 mL) with stirring. *trans* Cyclohexane diol (6.73 g, 58 mmol) was then added in one portion under nitrogen. The mixture was allowed to stir for 12h and 200 mL of

10% hydrochloric acid added. The aqueous solution was extracted with ether (200 + 2 x 100 mL) and the extracts dried filtered and concentrated to afford 13.13 g of **209**.

Rf: 0.20 (30% EtOAc/ 70% hexane)

^{13}C NMR: 24.80, 23.73, 23.88, 33.05, 72.67, 78.37, 125.68, 129.84, 130.54, 131.67, 131.98, 140.08, 167.82.

Bromination of the *ortho* toluic acid 1,2-cyclohexanediol half ester was attempted by reflux with NBS in carbon tetrachloride but intractable mixtures of bromination products were formed. ^{13}C NMR of the crude reaction mixture revealed that bromination at the alpha position of the cyclohexane ring had taken place as well as in the desired benzylic position.

References

- (1) Groves, J. T. In *Metal Ion Activation of Dioxygen*; T. G. Spiro, Ed.; John Wiley & Sons: New York, 1980.
- (2) Mitchell, J. C. *Chem. Rev.* **14**, 399.
- (3) Armstrong, G. P.; Hall, R. H.; Quin, D. C. *J. Chem. Soc.* **1950**, 666-670.
- (4) Heinze, A.; Lauterbach, G.; Pritzkow, W.; Schmidt-Renner, W.; Voerckel, V.; Zewesguren, N. *J. prakt. Chemie* **1987**, *329*, 439-446.
- (5) Weissermel, K.; Arpe, H.-J. *Industrial Organic Chemistry*; VCH: Weinheim, 1993.
- (6) *Ullman's Encyclopedia of Industrial Chemistry*; 5th ed.; Gerhartz, W., Ed.; VCH: Basel, 1985.
- (7) Sheldon, R. A.; Koichi, J. K. *Metal-Catalysed Oxidations of Organic Compounds*; Academic Press: New York, 1981.
- (8) Sheldon, R. A. In *The Chemistry of Functional Groups, Peroxides*; S. Patai, Ed.; John Wiley & Sons Ltd.: London, 1983; pp 162-196.
- (9) Mimoun, H. *Angew. Chem. Intl. ed Engl.* **1982**, *21*, 734-750.
- (10) March, J. In *Advanced Organic Chemistry*; 3rd ed. John Wiley & Sons: New York, 1985; pp 629.
- (11) Tagamaki, S.; Suzuki, K.; Okamoto, H.; Tagaki, W. *Tet. Letts.* **1983**, *24*, 4847.
- (12) Richter, H. W.; Wadell, W. H. *J. Am. Chem. Soc.* **1982**, *104*, 4620.
- (13) Derbyshire, D. H.; Waters, W. A. *Nature* **1950**, *165*, 401.
- (14) Hart, H.; Beuhler, C. A. *J. Org. Chem.* **1964**, *29*, 2397.
- (15) Hart, H. *Chem. Commun.* **1971**, *4*, 337-343.
- (16) Plesnicar In *Oxidation in Organic Chemistry*; Trahanovsky, Ed.; Academic Press: New York, 1978; Vol. C; pp 211.
- (17) Bruice, T. C. *Chem. Commun.* **1983**, 14.
- (18) Bruice, T. C.; Noar, J. B.; Bal, S. S.; Venkataram, U. V. *J. Am. Chem. Soc.* **1983**, *105*, 2452.
- (19) Ogata; Tabushi *J. Am. Chem. Soc.* **1961**, *83*, 3440.
- (20) Kwart, H.; Hoffman, D. H. *J. Org. Chem.* **1966**, *31*, 419.
- (21) Somasekar Rao, A. In *Oxidation 1991*; Vol. 7; pp Chapter 3.1 p.357.
- (22) Bingham, K. D.; Meakins, G. D.; Witham, G. H. *Chem. Commun.* **1966**, 445.
- (23) Schneider, H.; Becker, N.; Philippi, K. *Chem Ber.* **1981**, *114*, 1562.
- (24) Woods, K. W.; Beak, P. *J. Am. Chem. Soc.* **1991**, *113*, 6281-6283
supplementary material.

- (25) Woods, K. W.; Beak, P. *J. Am. Chem. Soc.* **1991**, *113*, 6281-6283.
- (26) Payne, G. B. *Tetrahedron* **1962**, *18*, 763.
- (27) Arias, L. A.; Adkin, S.; Nagel, C. J.; Bach, R. D. *J. Org. Chem.* **1983**, *48*, 888.
- (28) Baumstark, A. L.; Vasquez, P. C. *J. Org. Chem.* **1985**, *50*, 3657-3659.
- (29) Rebek, J.; McCready, R.; Wolf, S.; Mossman, A. *J. Org. Chem.* **1979**, *44*, 1485-1493.
- (30) Rodriguez, J.; Dulcere, J. *J. Org. Chem.* **1991**, *56*, 469-471.
- (31) Olah, G. A.; Berrier, A. L.; Surya Prakash, G. L. *J. Am. Chem. Soc.* **1982**, *104*, 2373.
- (32) Porter, N. A.; Mitchell, J. C. *Tet. Letts.* **1983**, *24*, 543-546.
- (33) Adam, W.; Birke, A.; Cadiz, C.; Diaz, S.; Rodriguez, A. *J. Org. Chem.* **1978**, *43*, 1154.
- (34) Denny, R. W.; Nickon, A. *Organic Reactions* **1973**, *20*, 133-331.
- (35) Easton, N. R.; Anet, F. A. L.; Burns, P. A.; Foote, C. S. *J. Am. Chem. Soc.* **1974**, *96*, 3945.
- (36) Foote, C. S. *Acc. Chem. Res.* **1968**, *1*, 104.
- (37) Foote, C. S.; Wexler, S.; Ando, W. *Tet. Letts.* **1965**, *46*, 4111-4118.
- (38) Foote, C. S. *Pure Appl Chem.* **1971**, 635-645.
- (39) Frimer, A. A. *Chem. Revs.* **1979**, *79*, 359-387.
- (40) Gollnick, K. In *Oxygen and Oxy-Radicals in Chemistry and Biology* Academic Press: 1981.
- (41) Schaap, A. P.; Recher, S. G.; Faler, G. R.; Villasenor, S. R. *J. Am. Chem. Soc.* **1983**, *105*, 1691-1693.
- (42) Wasserman, H. H.; Ives, J. L. *Tetrahedron* **1980**, *37*, 1825-1852.
- (43) Yamaguchi, K. In *Oxygen and Oxy-Radicals in Chemistry and Biology* Academic Press: 1981; pp 409-419.
- (44) Kopecky, K. R.; Scott, W. A.; Lockwood, P. A.; Mumford, C. *Can. J. Chem.* **1978**, *56*, 1114.
- (45) Adam, W.; Curci, R.; Edwards, J. O. *Acc. Chem. Res.* **1989**, *22*, 205.
- (46) Bach, R. D.; Owensby, A. L.; Andres, J. L.; Bernhard Schlegel, H. *J. Am. Chem. Soc.* **1991**, *113*, 7031.
- (47) Mitchell, J. C.; Heaton, S. *Tet. Letts* **1984**, *25*, 3769-3772.
- (48) Bloodworth, A. J.; Courtneidge, J. L.; Eggelte, H. J. *J. Chem. Soc. Chem. Commun.* **1983**, 1267-1268.
- (49) Melvin, T. PhD Thesis. University College, University of London, 1987.
- (50) James, A. P.; Mackirdy, I. S. *Chem. & Ind.* **1990**, *15th October 1990*, 641-645.
- (51) Warwick International Limited, Promotional Literature for Mykon Activators.

- (52) Merz, T.; Kottwitz, B.; Poethkow, J.; Lehmann, R. *Chem. Abs.* **1989**, 112, 121131h.
- (53) Brougham, P.; Cooper, M. S.; Cummerson, D. A.; Heaney, H.; Thompson, N. *Synthesis* **1987**, 1015-1016.
- (54) Gorman, A. A.; Rodgers, M. A. J. *Chem. Soc. Rev.* **1981**, 10, 205-231.
- (55) Ohloff, G. *Pure Appl Chem* **1975**, 43, 481-501.
- (56) Kearns, D. R. *Chem. Rev.* **1971**, 71, 395-427.
- (57) Bloodworth, A. J.; Melvin, T.; Mitchell, J. C. *J. Org. Chem.* **1988**, 53, 1078-1082.
- (58) Ziegler, K.; Wilms, H. *Justus Liebigs Ann. Chem.* **1950**, 561, 1-43.
- (59) Stork, G.; Landesman, H. K. *J. Am. Chem. Soc.* 78, 5128.
- (60) Marquardt, D. J.; Newcomb, M. *Syn. Commun.* **1988**, 18, 1193.
- (61) Cope, A. C.; McKervey, M. A.; Weinshenker, N. M. *J. Org. Chem.* **1969**, 34, 2229-2231.
- (62) Barton, D. H. R.; Crich, D.; Motherwell, W. B. *J. Chem. Soc. Chem. Commun.* **1983**, 939.
- (63) Barton, D. H. R.; Crich, D.; Motherwell, W. B. *J. Chem. Soc. Chem. Commun.* **1984**, 243.
- (64) Barton, D. H. R.; Crich, D.; Potier, P. *Tet. Lett.* **1985**, 26, 5943.
- (65) Barton, D. H. R.; Lacher, B.; Zard, S. Z. *Tet. Lett.* **1985**, 26, 5939.
- (66) Barton, D. H. R.; Crich, D.; Motherwell, W. B. *Tetrahedron* **1985**, 41, 3901.
- (67) Walton, J. C. *Mag. Res. Chem.* **1988**, 26, 412.
- (68) Davies, A. G.; Davison, I. G. E. *J. Chem. Soc. Perkin 2* **1989**, 825-830.
- (69) Corey, E. J.; Suggs, J. W. *Tet. Letts.* **1975**, 31, 2647-2650.
- (70) Porter, N. A.; Mitchell, J. C. *Tet. Letts.* **1983**, 24, 543-546.
- (71) Davies, A. G.; Foster, R. V.; White, A. M. *J. C. S.* **1955**, 2200.
- (72) Paquette, L. A.; Dunkin, I. R.; Freeman, J. P.; Storm, P. C. *J. Am. Chem. Soc.* **1972**, 94, 8124-8132.
- (73) Paquette, L. A.; Storm, P. C. *J. Org. Chem.* **1981**, 35, 3390-3393.
- (74) Bordwell, F. G.; Douglass, M. L. *J. Am. Chem. Soc.* **1966**, 88, 993.
- (75) Spencer, M. D. Thesis, University College, University of London, 1990.
- (76) Melvin, T. Thesis, University College London, 1987. X
- (77) Bordwell, F. G.; Pitt, B. M. *J. Am. Chem. Soc.* 77, 572.
- (78) Stork, G.; Landesman, H. K. *J. Am. Chem. Soc.* 78, 5128.
- (79) Gale, L. H. *J. Org. Chem.* **1968**, 33, 3643.
- (80) *Catalogue Handbook of Fine Chemicals*; Aldrich Chemical Company: 1992.

- (81) Armstrong, G. P.; Hall, R. H.; Quin, D. C. *J. Chem. Soc.* **1950**, 666-670.
- (82) Heinze, A.; Lauterbach, G.; Pritzkow, W.; Schmidt-Renner, W.; Voerckel, V.; Zewesguren, N. *J. f. prakt. Chemie* **1987**, 329, 439-446.
- (83) Riad, Y.; Abdallah, A. A.; El-Bardan, A. A.; El-Nahas, H. M. *Egypt. J. Chem.* **1984**, 27, 487.
- (84) Creary, X.; Mersheikh-Mohammadi, M. E.; McDonald, S. *J. Org. Chem.* **1987**, 52, 3261.
- (85) Corey, E. J.; Kim, C. U.; Takeda, M. *Tetrahedron letters* **1972**, 42, 4339-4342.
- (86) Wakefield, B. J. In *Organolithium Methods Academic Press*: New York, 1988.
- (87) Wakefield, B. J. In *The Chemistry Of Organolithium Compounds*; pp 136.
- (88) Kolsaker, P.; Bailey, P. S. *Acta. Chem. Scand.* **1967**, 21, 537.
- (89) Norcross, B. E.; Lansinger, J. M.; Martin, R. L. *J. Org. Chem.* **1977**, 42, 369-373.
- (90) Stewart, F. H. C.; Crawford, M. H. *J. Am. Chem. Soc.* **1952**, 4443.
- (91) Elsner, B. B.; Strauss, H. E.; Forbes, E. J. *J. Chem. Soc.* **1957**, 578.
- (92) Hallas, G. *J. Chem. Soc.* **1965**, 5770-5771.
- (93) Davies, A. G. *J. Chem. Soc.* **1958**, 3474.
- (94) Naito, K.; Rickborn, B. *J. Org. Chem.* **1980**, 45, 4061.
- (95) *Methoden der organischen Chemie: Houben-Weyl, 4te vollig neu gestaltete Auflage*; Kropf, H., Ed.; 1990; Vol. E12/E13.
- (96) Davies, A. G. *Organic Peroxides*; Butterworths: London, 1961.
- (97) Greenspan *J. Am. Chem. Soc.* **1946**, 68, 907.
- (98) Silbert, L. S.; Siegel, E.; Swern, D. *J. Org. Chem.* **1962**, 27, 1336.
- (99) Pande, C. S.; Jain, N. *Syn. Commun.* **1989**, 19, 1271.
- (100) Helfferich, F.; Luten jr, D. B. *J. Appl. Polym. Sci.* **1964**, 8, 2899.
- (101) Harrison, C. R.; Hodge, P. *J. Chem. Soc. Perkin 1* **1976**, 605.
- (102) Edwards, J. O.; Pearsons, R. G. *J. Am. Chem. Soc.* **1962**, 84, 4607.
- (103) Nedelec, J. Y.; Sorba, J.; Lefort, D. *Synthesis* **1976**, 821.
- (104) Ogata, Y.; Sawaki, Y. *Tetrahedron* **1967**, 23, 3327.
- (105) Cookson, P. G.; Davies, A. G.; Fazal, N. *J. Organometall. Chem.* **1975**, 99, C31.
- (106) Fine, L. W.; Grayson, V. S.; Grayson, M. *Detergent Age* **1974**, 42.
- (107) Corey, E. J.; Niwa, H.; Falek, J. R. *J. Am. Chem. Soc.* **1979**, 101, 1586.
- (108) Riad, Y.; Abdallah, A. A.; El-Bardan, A. A.; El-Nahas, H. M. *Egypt. J. Chem.* **1984**, 27, 487.
- (109) Dick, C. R.; Hanna, R. F. *J. Org. Chem.* **1964**, 29, 1218.

- (110) Entwistle, I. D.; Boehm, P.; Johnstone, R. A. W.; Telford, R. P. *J. Chem. Soc. Perkin I* **1980**, 27.
- (111) Bailey, P. S. In *Ozonation in Organic Chemistry* Academic Press: 1982; Vol. II; pp 302.
- (112) Dussault, P.; Sahli, A. *J. Org. Chem.* **1992**, 57, 1009.
- (113) Staab, H. A.; Rohr, W.; Graf, F. *Chem. Ber.* **1968**, 98, 1122.
- (114) Abdallah, A. A. E.; El-Nahas, H. M.; Kandil, S. H. *Egypt. J. Chem.* **1981**, 24, 53.
- (115) Hill, J. G.; Rossiter, B. E.; Sharpless, K. B. *J. Org. Chem.* **1983**, 48, 3607.
- (116) Pouchert, C. J. In *The Aldrich Library of NMR spectra*; 2nd ed. Aldrich Chemical Company: Milwaukee, 1983; pp 307D.
- (117) Davies, W.; Perkin, W. H. *J. Chem. Soc.* **1922**, 121, 2202.
- (118) Staab, H. A.; Lueking, M.; Derr, F. H. *Chem. Ber.* **1962**, 95, 1275.
- (119) Staab, H. A. *Angew. Chem. Intl. Ed. Engl.* **1962**, 1, 351.
- (120) Folli, U.; Iarossi, D. *Bolletino Scientifico della Facolta di Chimica Industriale di Bologna* **1968**, 26, 61.
- (121) Folli, U.; Iarossi, D. *Chem. Abs.* **1968**, 69, 86565.
- (122) Speakman, P. R. H. *Chem. and Ind.* **1978**, 579-580.
- (123) Mitchell, J. C. Dissertion Abstracts Number 8325666 Thesis, Duke University, 1983.
- (124) Kirmse, W.; Kund, K. *J. Org. Chem.* **1990**, 55, 2325-2332.
- (125) Buckley, D. G. *Aust. J. Chem.* **1969**, 22, 577.
- (126) Wasson, R. L.; House, H. O. *Organic Syntheses* 552.
- (127) Payne, G. B.; Smith, C. W. *J. Org. Chem.* **1957**, 22, 1682.
- (128) Klimovitskiĭ, E. N.; Strel'nik, D. Yu.; Sergeeva, G. N.; Abuzov, B. A. *J. Gen. Chem. USSR*, **1986**, 56, 952.