

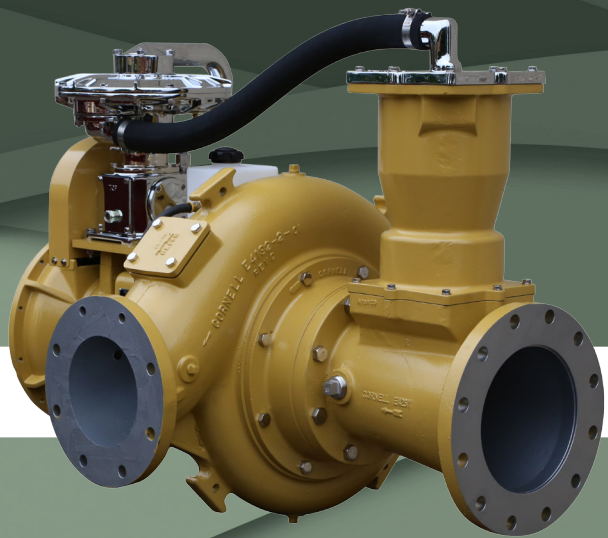

CORNELL PUMP COMPANY

WATER TRANSFER

HYDRAULIC FRACTURING / FOR OIL & GAS APPLICATIONS



EFFICIENT BY DESIGN





WATER TRANSFER

WATER TRANSFER PUMPS FOR OILFIELD SERVICE

You need uptime and efficiencies to take advantage of market conditions and spend less on maintenance and repairs.

Cornell Pump has been producing robust, high-efficiency pumps since 1946, and our innovative pumps have provided unmatched value. Cornell offers a wide range of pump models and configurations and we responded to the oilfield service industry's changing needs; providing models best suited for today's water transfer pumping requirements.

RELIABILITY: many of our pumps have seen continuous service for years in harsh conditions such as shale oil fields, frac sand mines, rock quarries, fixed chemical refineries, and more.

ROBUST CONSTRUCTION: thick walled castings, durable frames, and oversize bearings keep the pump in the field rather than your repair depot.

HIGH EFFICIENCY: Many of our pumps beat industry averages by four of five percent—that can mean thousands of dollars in operating costs EVERY YEAR.

SOLIDS HANDLING: Cornell pumps easily handle solids up to 10", depending on model.

INNOVATIVE DESIGN: We've been creating great designs in Portland Oregon since 1946. Our ingenuity, responsiveness, and know-how benefit you.

SPECIALTY SEALS: No leaks means easier clean up and reduced environmental concerns.

WIDE VARIETY OF PUMPS: We have dozens of options for water transfer, so we should have a pump to meet your conditions.

FEATURES & BENEFITS

- Heads up to 800 feet possible
- Designed priming system (RediPrime®) eliminates liquid carry-over
- Suction lifts to 28 feet
- Handles large size solids
- Industry leading two-year warranty
- Fully automated priming and repriming
- Run dry pumps
- Handles air/liquid mixtures with ease
- Patented Cycloseal®, Redi-Prime®, and RunDry™ options
- Extend pump life with hardened metal options

RUN-DRY™ SEAL PROTECTION

Cornell's Run-Dry system consists of an auxiliary gland and oil reservoir that keeps the seal faces lubricated and prevents dry running of the seal faces during priming, re-priming, or standby operation.

- Run dry for hours without damaging the seal
- Cools and lubricates seal faces
- Ideal for applications that could experience dry operation
- Useable in conjunction with Cycloseal® and Redi-Prime®

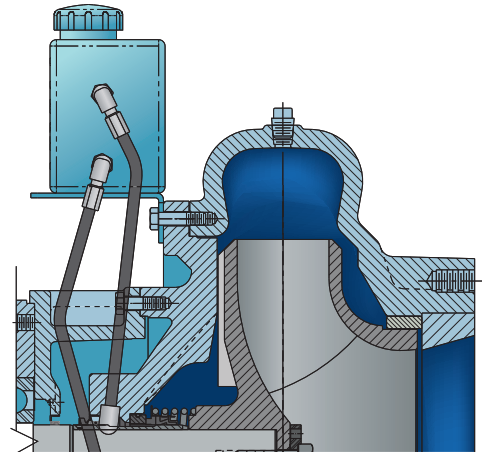

CYCLOSEAL® DESIGN: ADVANTAGES IN WATER TRANSFER

THE PATENTED, PREMIUM MECHANICAL SEAL SYSTEM THAT DISTINGUISHES OUR PUMPS FROM ALL OTHERS

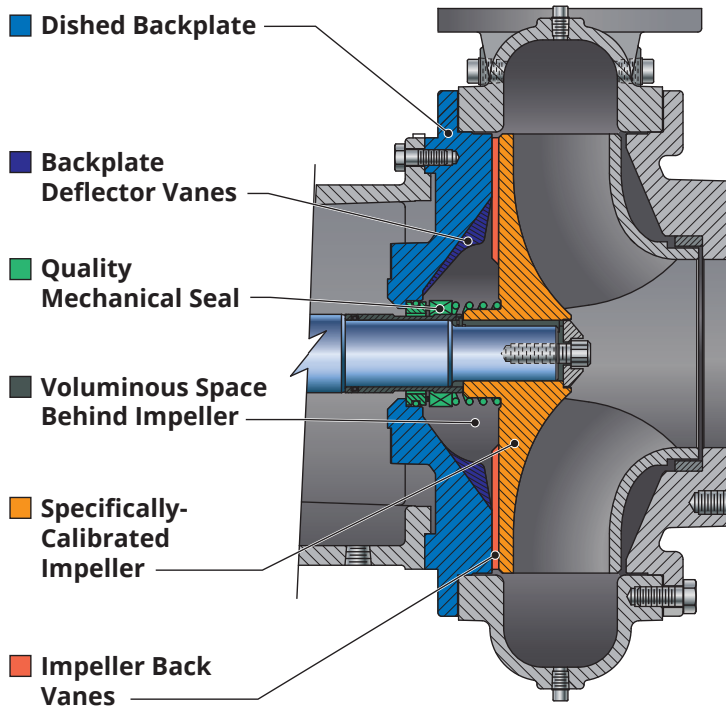

One of the main reasons Cornell pumps have a distinctive edge on competitors is Cornell's patented Cycloseal design that removes solids and abrasive material from the seal area, while purging air and gas pockets. This innovative cyclonic action extends seal life and eliminates the need for venting or flush water- a valuable benefit for those servicing hydraulic fracturing sites and other remote locations.

EXTENDED SEAL LIFE: Cornell's Cycloseal design has proven itself in the toughest applications; in some cases more than tripling the normally-expected mechanical seal life.

SYSTEM SAVINGS: The Cycloseal system requires no external water flush, filters, grease cups, piping or instrumentation normally associated with packing or double mechanical seals.

MAINTENANCE SAVINGS: Longer seal life which translates into less pump down time and lower maintenance costs.

NO SEEPAGE: Fluid stays in the pump, not on the ground at a site. Less product loss, shorter clean up time, and less environmental mitigation.

REDI-PRIME® SYSTEM ALLOWS TRANSFER PUMPS TO PRIME AND REPRIME

With over 70 years of proven experience and reliability, Cornell Pump Company has established the highest industry standard for premium quality and rugged performance. Our pumps are backed by an industry-leading two-year warranty.

The Redi-Prime system uses a positive-sealing float box and a diaphragm vacuum pump to provide fully automatic priming and re-priming of the pump. There is absolutely no water carry-over to contaminate the environment, and Redi-Prime is compatible with most Cornell pump models.

- Fully-automatic priming and repriming
- Handles air/liquid mixtures with ease
- Rapidly primes and re-priming completely unattended
- Environmentally safe priming system designed to prevent product leakage
- Patented Cycloseal® and Run-Dry™ options
- Does not impede solids handling of pump
- No change in suction lift capacity and flow rates
- Check valve eliminates any liquid carry over

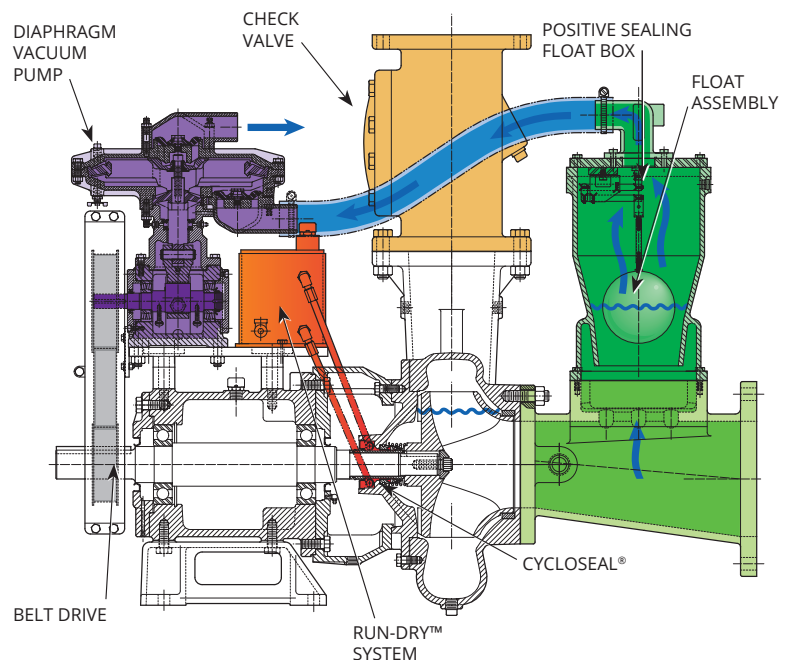



WATER TRANSFER

SOLIDS HANDLING PUMPS

CONSTRUCTION PUMPS

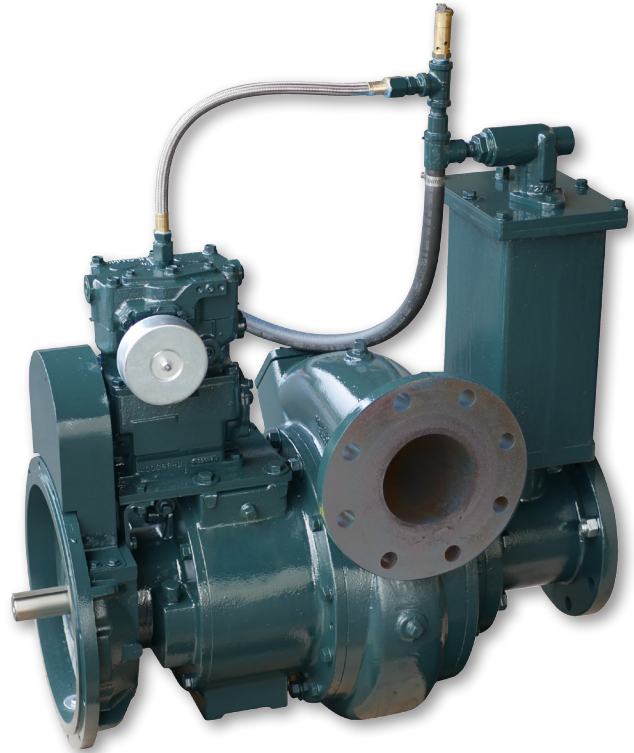
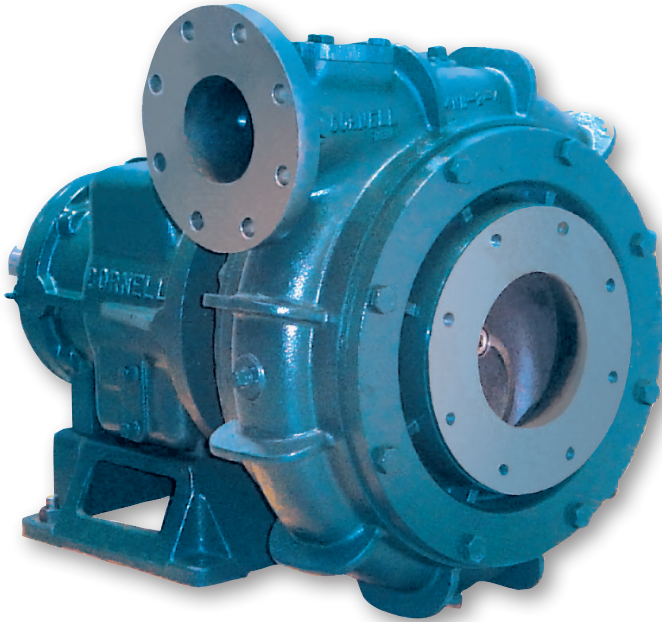

N SERIES

DISCHARGE SIZE RANGE	3" TO 30"
MAX SOLIDS HANDLING SIZE	10.2"
MAX FLOW	38,000 GPM
MAX HEAD	500'

IMPELLER CHOICES: choose from the Delta style impeller for heavy sludge, two and three port enclosed impellers for large solids, and three or four bladed, semi-open impeller with cutting action for the worst slurries/solids.

MATERIALS OF CONSTRUCTION

- Ductile or cast iron pump casings
- Some models available in CD4MCu
- Ductile, cast iron, or CD4MCu impellers
- Stressproof or heat-treated steel shafts (stainless on CD4MCu models)
- 420HT wear rings and shaft sleeve available

FEATURES

- Cycloseal® grit removal system
- High-efficiency design
- Run-Dry™ and Redi-Prime® Options
- Excellent NPSHr
- Ruggedness and durability
- Two-year warranty

DURAPRIME SERIES

DISCHARGE SIZE	3" TO 6"
MAX SOLIDS HANDLING SIZE	3"
MAX FLOW	3050 GPM
MAX HEAD	205'

Robust **DURAPRIME** construction pumps are ideal for rental and construction applications. The Duraprime series feature a rebuild-able pump design, robust construction, efficient operation and competitive pricing.

MATERIALS OF CONSTRUCTION

- Ductile iron casings
- 17-4PH stainless steel shafts
- 303 Shaft sleeves
- Ductile Iron impellers

FEATURES

- Cycloseal® grit removal system
- High-efficiency design; up to 82%
- Run-Dry™, Venturi-Prime, Redi-Prime®, and bare pump options
- Easy servicing and upkeep of pumps
- Long life and low maintenance costs
- Two-year warranty

HIGH HEAD PUMPS

SELF-PRIMING PUMPS

SLURRY PUMPS

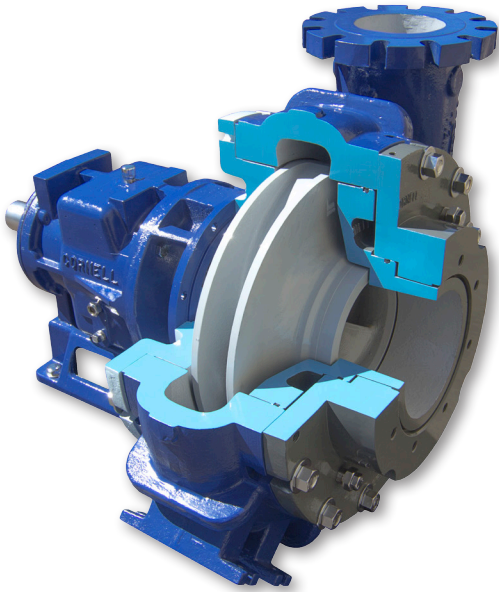

MX SERIES

DISCHARGE SIZE	2" TO 8"
MAX SOLIDS HANDLING SIZE	2.38"
MAX FLOW	8,000 GPM
MAX HEAD	800'

Cornell's **MX HIGH HEAD PUMPS** provide heads up to 800', long service life, and industry-leading efficiency.

MATERIALS OF CONSTRUCTION

- Ductile iron casings
- 17-4PH stainless steel shafts
- CA6NM impellers
- Optional hardened wear ring and shaft sleeves.

FEATURES

- Cycloseal® grit removal system
- High-efficiency design
- Run-Dry™ and Redi-Prime® Options
- High operating pressures
- Two-year warranty

STX/H/L SERIES

DISCHARGE SIZE RANGE	2" TO 10"
MAX SOLIDS HANDLING SIZE	3"
MAX FLOW	4,500 GPM
MAX HEAD	275'

STX, STL, AND STH PUMPS offer rugged construction and efficiencies up to 68%.

MATERIALS OF CONSTRUCTION

- Ductile iron volute casing, backplate, and impeller
- 17-4PH stainless steel shafts
- Optional CD4MCu on 3STX, 4STX, and 6STX pump models

FEATURES

- Cycloseal® grit removal system
- High-efficiency design
- High RPM capacity for engine driven applications.
- High head capacity
- Modular design
- ANSI, NPT, & DIN flanges available
- Five-year warranty

SP SERIES

DISCHARGE SIZE RANGE	2" TO 12"
MAX SOLIDS HANDLING	4.1"
MAX FLOW	18,000 GPM
MAX HEAD	290'

SP-SERIES PUMPS are rubber or metal lined and handle pH from 1 to 14 depending on configuration. Capable of pumping slurries that are up to 40% solids by volume.

MATERIALS OF CONSTRUCTION

- Chrome iron impellers
- Ductile iron volute casings & bearing housing
- Lined in chrome iron or rubber
- 4140 steel shafts

FEATURES

- Cycloseal® grit removal system
- Enclosed impeller = higher efficiency
- Run-Dry™ and Redi-Prime® Options
- No seal flush, vent line or lubrication required
- Two-year warranty



TYPICAL PUMP MODELS

Following are performance curves for several pump models that are extremely popular with hydraulic fracturing operations. There are over 80 models from the series listed previously; Cornell will have the right pump for flow, head, and solids handling conditions, with great efficiency, strong design, and robust build. Please see our website, e-catalog or Pump-Flo sizing program for additional curves.

8NHTA

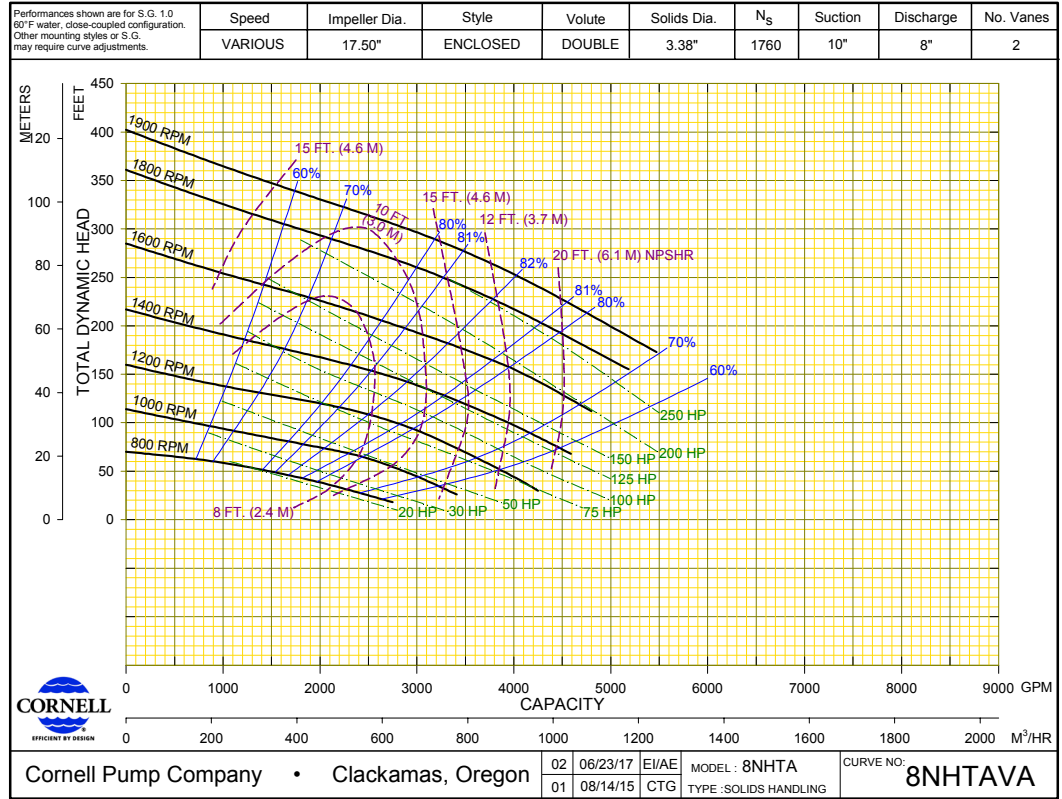

8NHG19

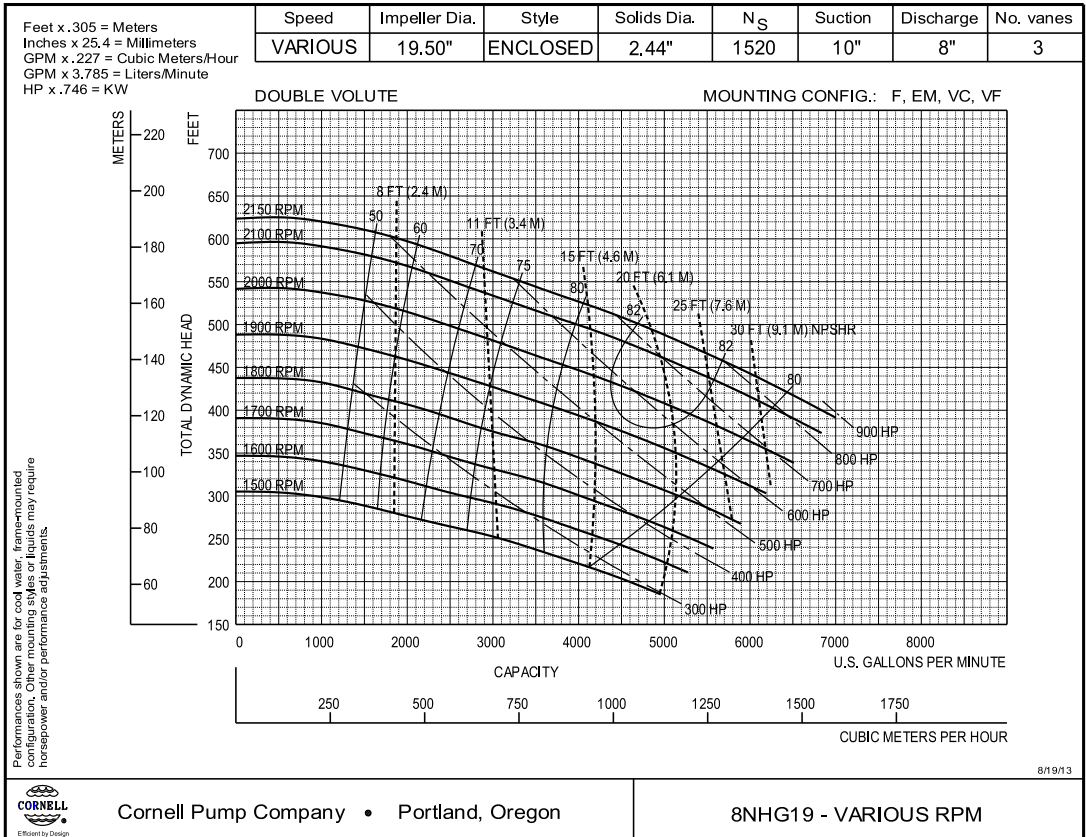

6NHTA

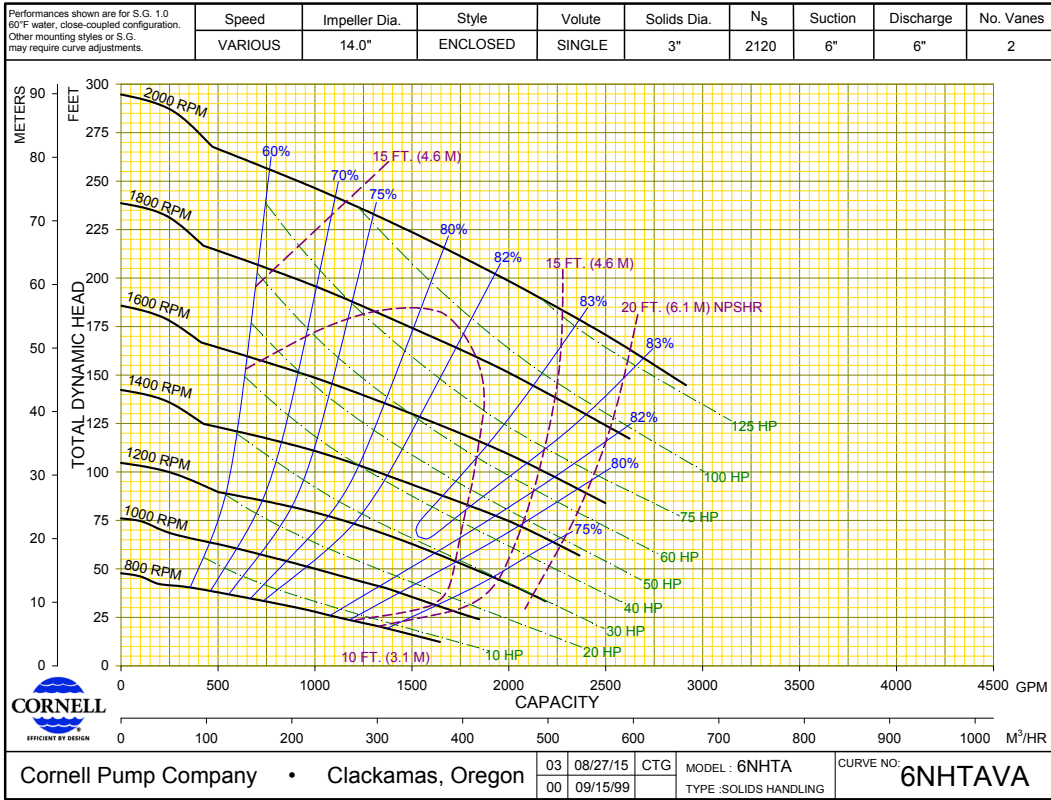

8NHTH

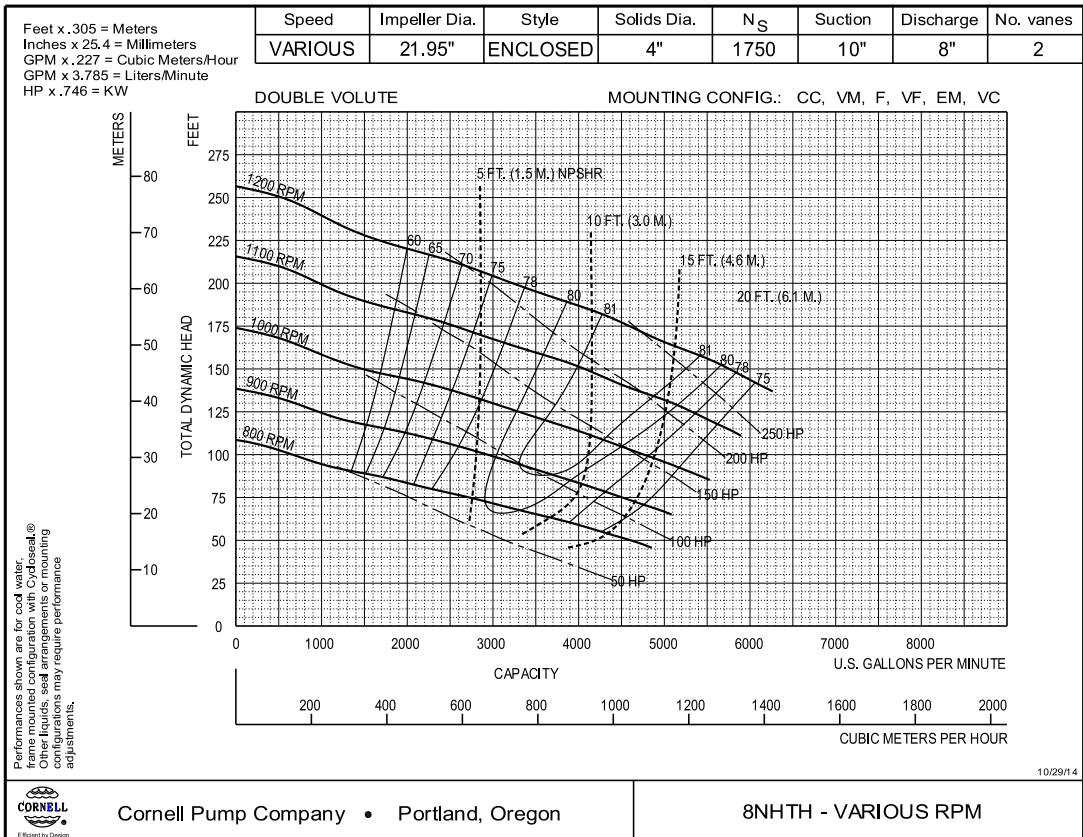

NEW PAGE

8NHTHVA



MARKET AND PRODUCT LINE



AGRICULTURE

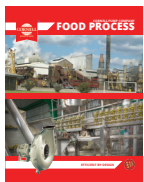

FOOD PROCESS



INDUSTRIAL

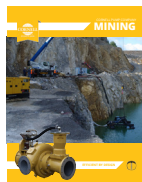

MINING



MUNICIPAL



WATER TRANSFER



REFRIGERATION



CONSTRUCTION

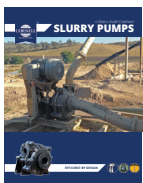

SLURRY

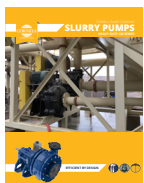

SLURRY SM

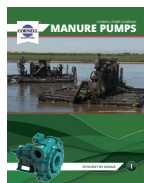

MANURE

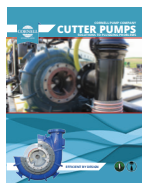

CUTTERS



SELF PRIMING



V SERIES



MX SERIES



N SERIES



Q-MAX



EDGE™



HYDRAULIC SUBS



IMMERSIBLE



CD4MCU



RUN-DRY™



PRIMING SYSTEMS



CYCLOSEAL®

Cycloseal® and Redi-Prime® are Registered Trademarks of Cornell Pump Company.

Cornell pumps and products are the subject of one or more of the following U.S. and foreign patents: 3,207,485; 3,282,226; 3,295,456; 3,301,191; 3,630,637; 3,663,117; 3,743,437; 4,335,886; 4,523,900; 5,489,187; 5,591,001; 6,074,554; 6,036,434; 6,079,958; 6,309,169; 2,320,742; 96/8140; 319,837; 918,534; 1,224,969; 2,232,735; 701,979 and are the subject of pending U.S. and foreign patent applications.

CORNELLPUMP.COM
©2017 CORNELL PUMP COMPANY



Cornell Pump Company
Clackamas, Oregon, USA
P: +1 (503) 653-0330
F: +1 (503) 653-0338

AUTHORIZED CORNELL PUMP DISTRIBUTOR