

## Corrosion / Cathodic Protection

### Drive In Spike Anodes

- Sacrificial cathodic protection
- Easy to install
- One man installation
- Angled point for easy penetration through soil
- Zinc or Magnesium



ITEM#	Product Description
GA-MG-ROD-1.315x24-10-12HMWPE	AZ31D anodes 1.315 x 24" 10' of #12 HMWPE wire
GA-MG-ROD-1-315-30-10-12THHN	AZ31D anodes 1.315 x 24" 10' of #12 THHN wire
GA-MG-1-315X30	AZ31D anodes 1.315 X 30" 10' of #12 THHN Wire
GA-S-1.5-10	Zinc Spike Anode, 1.5" x 10" with 10' #12 Gauge Solid Black THHN Wire & Cap

### Zinc Soil Anodes

- Sacrificial soil Zinc anodes made from 99.99% pure high grade zinc
- Conforms to the composition of ASTM B-418-95 Type II
- Multiple shapes, sizes and weights available - CALL FOR QUOTE



### High Potential Magnesium Anodes

- Top quality sacrificial Magnesium anodes
- Bare also available
- Multiple shapes, sizes and weights available - CALL FOR QUOTE



### H1 Standard Potential Magnesium Anodes

- Top quality sacrificial Magnesium anodes
- Bare also available
- Multiple shapes, sizes and weights available - CALL FOR QUOTE



### Bronze Grounding Clamps

- 10 SOL 2 STR gauge
- UL/CSA approved
- Commonly used to attach a sacrificial anode to copper service risers



ITEM#	Product Description
BGC1	Bronze Grounding Clamps 1/2" – 1" Pipe
BGC2	Bronze Grounding Clamps 1 1/4" – 2" Pipe

### Zinc Anode Caps

- Cathodic protection for underground and submerged threads, bolts and nuts on glands, flanges and mechanical fittings
- Meet or exceeds all MIL-A-18001J and ASTM B418-80 specifications

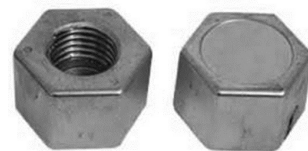

**WARNING: Cancer & Reproductive Harm**  
[www.P85Warnings.ca.gov](http://www.P85Warnings.ca.gov)

ITEM#	Product Description
P238	3/8" Sacrificial Zinc Cap – 2.5 oz
P205	1/2" Sacrificial Zinc Cap -2.5 oz
P258	5/8" Sacrificial Zinc Cap – 2.5 oz
PC-50-6	1/2" Sacrificial Zinc Cap – 6 oz
PC-58-6	5/8" Sacrificial Zinc Cap – 6 oz
PC-75-6	3/4" Sacrificial Zinc Cap – 6 oz
PC-78-6	7/8" Sacrificial Zinc Cap – 6 oz
PC-100-14	1" Sacrificial Zinc Cap – 6 oz
PC-118-14	1 1/8" Sacrificial Zinc Cap – 14 oz
PC-114-14	1 1/4" Sacrificial Zinc Cap – 14 oz

### Jumpers/Bonding Cables

- Made from cathodic quality HMWPE cathodic cable
- Used to connect pipeline joints or fittings for electrical continuity
- Custom size gauges available with or without sleeves - CALL FOR QUOTE



### Cadweld® Mold Cleaner Tool

- Used to remove slag from the crucible area of the mold after making a Cadweld® connection



ITEM#	Product Description
TC-CAB136-A	Cadweld® Mold Cleaner Tool

## Corrosion / Cathodic Protection

### Flint Gun Cadweld® Striker



ITEM#	Product Description
38-0309-00	Flint Gun Cadweld® Striker

### Royston Handy Cap IP, Protection for Cadweld® Connection

- Seals the welded connection of an anode or test wire to a metal substrate
- Handy Cap IP uses gray elastomeric adhesive with integrated primer
- Exclusive formulation allows for faster application as there is no need to apply a separate primer



**WARNING: Cancer**  
[www.P85Warnings.ca.gov](http://www.P85Warnings.ca.gov)

ITEM#	Product Description
RHC44IP	Royston Handy Cap – Integrated Primer

### Cadweld® Adapter Sleeves



ITEM#	Product Description
CAS09F	Cadweld® Adapter Sleeve for #2 Str Wire
CAS20F	Cadweld® Adapter Sleeve for #4 Str (54062296)
TC-CAB112	Cadweld® Adapter Sleeve for #6 Str
TC-CAB133-1L	Cadweld® Adapter Sleeve for #8, 10 Str & #6, 8 Sol
TC-CAB133-1K	Cadweld® Adapter Sleeve for #10 Str & #8, #10 Sol
TC-CAB133-1H	Cadweld® Adapter Sleeve for #12, 14 Str & #10,12,14 Sol

## Horizontal and Vertical Cadwelders - Exothermic Welders

- Forms a permanent, low resistance connection
- Provides a molecular bond
- Rated with the same current capacity as the conductor
- Portable installation equipment with no external source of power required
- Connections can be visually inspected
- All configurations available
- Call with wire gauge and substrate information for pricing and availability



### Cadweld® Weld Metal Cartridges

- Primarily used in cathodic protection applications on cable to cast or ductile iron pipe
- Mixture of copper oxide and aluminum
- Welding material in top of tube and starting material in the bottom half
- Packaged by size in plastic tubes
- Tubes packaged in plastic boxes along with metal disks
- Each weld connection uses a single disk
- Non-explosive, not subject to spontaneous ignition



ITEM#	Product Description
TC-CA15	Cadweld® Weld Metal Cartridge for Steel
TC-CA25	Cadweld® Weld Metal Cartridge for Steel
TC-CA32	Cadweld® Weld Metal Cartridge for Steel
TC-CA45	Cadweld® Weld Metal Cartridge for Steel
TC-CA65	Cadweld® Weld Metal Cartridge for Steel
TC-CA25-XF19	Cadweld® Weld Metal Cartridge for Iron
TC-CA32-XF19	Cadweld® Weld Metal Cartridge for Iron
TC-CA45-XF19	Cadweld® Weld Metal Cartridge for Iron
TC-CA65-XF19	Cadweld® Weld Metal Cartridge for Iron

## Corrosion / Cathodic Protection

### Cadweld® Plus Control Unit

- Battery-powered controller box designed for up to 600 connections with one set of batteries
- Requires no special batteries or charger
- Includes high temperature lead
- Connects to the welding material ignition strip with a custom made, purpose-designed termination clip
- Sends a predetermined voltage to the ignition strip and initiates the reaction
- The PBPLUSCU control unit electronic ignitor is primarily designed for ignition of nVent ERICO Cadweld Plus WELDING MATERIAL, F80
- PBPLUSCU meets AREMA C&S Manual Recommendations; Part 8.1.34, 2013



ITEM#	Product Description
TC-PLUSCU15L	ERICO Cadweld Plus Control Unit

### Cadweld® Plus Welding Material for Steel

- Used in cathodic protection applications on cable to cast or ductile iron pipe
- Mixture consists mainly of copper oxide and aluminum
- Integrated welding material package
- Electronic ignition
- No starting material required
- Non-explosive
- Not subject to spontaneous ignition
- For assistance in selection, please provide specific connection details



ITEM#	Product Description
TC-CA15PLUSF33	Cadweld® Plus Welding Material for Steel
TC-CA25PLUSF33	Cadweld® Plus Welding Material for Steel
TC-CA32PLUSF33	Cadweld® Plus Welding Material for Steel
TC-CA45PLUSF33	Cadweld® Plus Welding Material for Steel
TC-CA65PLUSF33	Cadweld® Plus Welding Material for Steel

### Cadweld® Plus Welding Material for Iron

- Used in cathodic protection applications on cable to cast or ductile iron pipe
- Mixture consists mainly of copper oxide and aluminum
- Integrated welding material package
- Electronic ignition
- No starting material required
- Non-explosive
- Not subject to spontaneous ignition
- For assistance in selection, please provide specific connection details



ITEM#	Product Description
TC-CA25-PLUS-XF19	Cadweld® Plus Welding Material for Iron
TC-CA32-PLUS-XF19	Cadweld® Plus Welding Material for Iron
TC-CA45-PLUS-XF19	Cadweld® Plus Welding Material for Iron
TC-CA65-PLUS-XF19	Cadweld® Plus Welding Material for Iron

### Insulating Couplings

- Stop corrosion caused by dissimilar metals
- For oil, gas or water



ITEM#	Product Description
TC-CORR-COUP10	1" Corrosion Insulating Coupling
TC-CORR-COUP125	1.25" Corrosion Insulating Coupling
TC-CORR-COUP15	1.5" Corrosion Insulating Coupling
TC-CORR-COUP20	2" Corrosion Insulating Coupling

## Corrosion / Cathodic Protection

### Copper Sulfate Reference Electrode (Cells), Permanent Ceramic

- Size 1.5" dia. x 6" long, space-age ceramic tube with yellow protective caps
- Lead wire is 30' of #14 RHH-RHW cable
- Stability: +/- 5 millivolts with 3.0 microamp load
- Temperature range: 32°F to 135°F ( 0°C to 57.2°C)



ITEM#	Product Description
CU-1-UGPC-14RH-Y	Permanent Ceramic Copper Sulfate Reference Electrode

### Cott Yellow Shunt .01 OHM 8 AMP

- Circuit board made of Makrolon® Polycarbonate
- Color coded for easy value recognition
- Current strips and potential posts are nickel plated brass
- Resistance wire: Manganin (ASTM B267, Cl.VI)
- Configuration: standard 1/4" holes on 1" centers fits all Fink® brand cathodic protection test stations

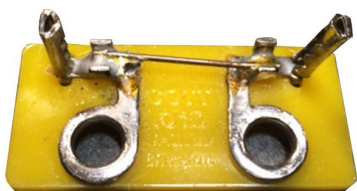

**WARNING: Cancer**  
www.P85Warnings.ca.gov

ITEM#	Product Description
TC-COTTSHUNT	Cott Yellow Shunt .01 OHM 8 AMP

### Holloway .01 OHM JB Shunt

- 0.01 OHM, 8 AMP capacity Manganin strip shunt designed for use in junction boxes, test stations and similar applications
- Size is 1/2" x 3 3/4"
- Standard hole size is for #10 (3/16") screws
- Optional hole size for 1/4" screws available
- Hole spacing is 3 1/4".

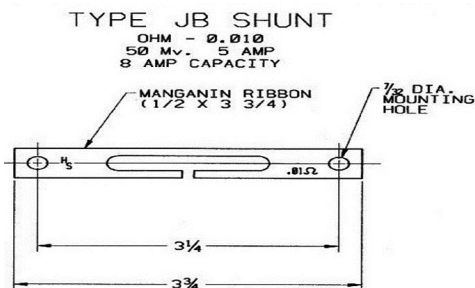

ITEM#	Product Description
TC-SHUNT-JB01	Holloway .01 OHM JB Shunt

### Holloway .01 OHM RS Wire Shunt

- 0.01 OHM shunt is rated at 6 AMPs and made from #12 Manganin wire
- Overall length of 5 3/4", the shunt can be bent to fit in small areas.
- Used for junction boxes, test stations and similar applications

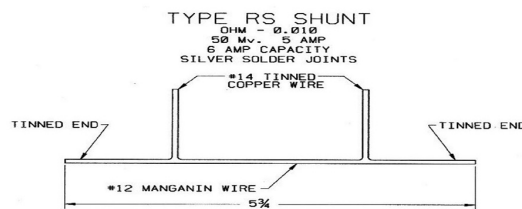

ITEM#	Product Description
TC-SHUNT-RS01	Holloway .01 OHM RS Wire Shunt

### Copper Sulfate Reference Electrode (Cells), Packaged

- Permanent prepackaged underground reference electrode
- Packaging is special non-polarizing backfilled in yellow cotton bag
- Size 2" dia. x 7" Long high impact ABS plastic tube
- Overall size approx. 6" dia. x 14" long, approx. 15lbs
- Reinforcing rods 1/4" x 3" PVC at electrode end
- Lead wire is standard 30' of #14 RHH-RHW, yellow lead wire
- Stability +/- millivolts with 3.0 microamp load
- Temperature range 32°F to 150°F
- Other wire options available upon request



ITEM#	Product Description
CU-1-UG-14RH-R	Copper Sulfate Ref Electrode (Cell) with 30' #4 Red RHH/RHW Wire
CU-1-UG-14RH-Y	Copper Sulfate Ref Electrode(Cell) with 30' #14 Yel RHH/RHW Wire
CU-1-UG-8HM-B	Copper Sulfate Ref Electrode (Cell) with 30' #8 HMWPE Wire
CU-1-UG-8RH-Y	Copper Sulfate Ref Electrode (Cell) with 30' #8 Yel RHH/RHW Wire



## Corrosion / Cathodic Protection

### Christy's G5 Concrete Meter Box and Lid

- Permits quick, easy valve adjustments
- Unique locking grade rings assure permanence and quality of surface grades when streets are re-paved
- Carefully engineered cast iron lid and ring includes machined surfaces and bolting feature reduces the danger of lid "pop-out" in high traffic areas
- Custom legends available

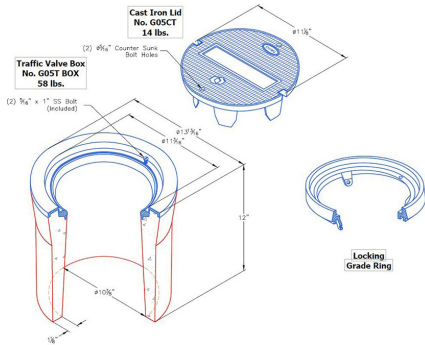

**WARNING: Cancer & Reproductive Harm**  
[www.P65Warnings.ca.gov](http://www.P65Warnings.ca.gov)

ITEM#	Product Description
G5-BOX	Box, G5 Traffic Valve, 10-3/8 I.D.x12
G5C-CPTS	Christy's G5C C.I. Lid, Marked "CPTS"
G5C-SEWER	Christy's G5C C.I. Lid, Marked "SEWER"
G5C-WATER	Christy's G5C C.I. Lid, Marked "WATER"

### Cott Big FINK® Standard 5 Terminal Cathodic Test Station, Black

- Field proven, high strength, maintenance free terminal for monitoring electric currents and potentials
- Cap, terminal board and collect nut made from Makrolon® polycarbonate



**WARNING: Cancer**  
[www.P65Warnings.ca.gov](http://www.P65Warnings.ca.gov)

ITEM#	Product Description
TC-BFINK	Cathodic Test Station

### Cott Flush FINK® Standard 5 Terminal Cathodic Test Station, Black



**WARNING: Cancer**  
[www.P65Warnings.ca.gov](http://www.P65Warnings.ca.gov)

ITEM#	Product Description
TC-FFINK	Cathodic Test Station

### Cott Street FINK® Standard 5 Terminal Cathodic Test Station, Black

- Used to conveniently monitor electrical currents and potentials associated with all types of underground piping, cables and other metallic structures
- Designed especially for used in troublesome locations where water, street traffic and other adverse conditions exist
- Maintains its structural integrity during hard usage and is suitable for installation in asphalt
- Lid, terminal board and housing made from Makroblend® polycarbonate

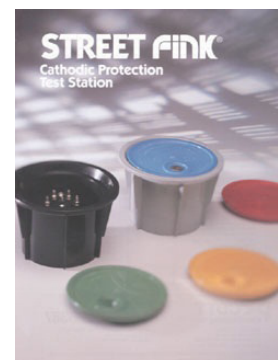

**WARNING: Cancer**  
[www.P65Warnings.ca.gov](http://www.P65Warnings.ca.gov)

ITEM#	Product Description
TC-SFINK	Cathodic Test Station

## Corrosion / Cathodic Protection

### Split Bolt Connector 16 Sol

- 16 Sol Split bolt connector
- Brass



**WARNING:** Cancer & Reproductive Harm  
www.P85Warnings.ca.gov

ITEM#	Product Description
S4	Conductor sizes 4 - 8 AWG
S8	Conductor sizes 8 - 16 AWG

### 3M™ 82-A1 Inline Resin Splicing Kit

- Split bolt required, sold separately
- For making inline (straight) splices on unshielded, synthetic insulated cables rated up to max of 5000 volts
- For use in weather-exposed or direct burial locations
- UL listed for direct burial and submerged applications up to 600 Volts and 90°C
- #2 AWG(MAX) conductor size



ITEM#	Product Description
82-A1	3M™ 82-A1 Inline Resin Splicing Kit

### 3M™ Direct Bury Splice Kit

- Premium moisture resistant connector
- UL-listed for direct bury & rated for 600V
- Accommodates wire size 18-10 AWG



ITEM#	Product Description
DBR-Y-6BULK	3M™ Direct Bury Splice Kit

### 3M™ WYE Resin Splice Kit

- Split bolt required, sold separately
- For insulation and moisture sealing of WYE splices
- Used for making tap or branch splices on unshielded, synthetic insulated cables rated up to max of 1000 volts
- Accommodates wire size of 1/0 to 2/0 AWG



ITEM#	Product Description
90-B1	3M™ WYE Resin Splice Kit 90B1

### Stranded HMWPE, Cathodic Protection, Black

- Used for direct earth burial DC feeder cable for cathodic protection
- Copper conductors are stranded annealed copper per UL83 & ASTM requirements
- Available #2 - #12 500' spools or cut to desired length
- Custom size gauges and colors available - CALL FOR QUOTE

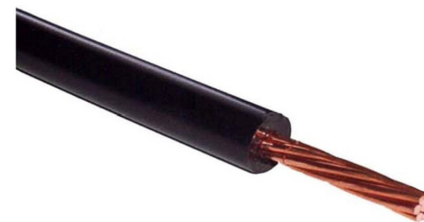

ITEM#	Product Description
2CAD500	Cathodic HMWPE, #2 Gauge, 7 Stranded, Black
4CAD500	Cathodic HMWPE, #4 Gauge, 7 Stranded, Black
6CAD500	Cathodic HMWPE, #6 Gauge, 7 Stranded, Black
8CAD500	Cathodic HMWPE, #8 Gauge, 7 Stranded, Black
10CAD500	Cathodic HMWPE, #10 Gauge, 7 Stranded, Black
12CAD500	Cathodic HMWPE, #12 Gauge, 7 Stranded, Black

### Stranded RHH/RHW

- Single copper conductor, stranded and insulated with moisture and heat resistant, chemically crosslinked polyethylene
- Suitable for general purpose wiring applications, rated for direct burial
- Available #6 - 4/0
- Custom size gauges available - CALL FOR QUOTE

## Corrosion / Cathodic Protection

### Tracer Wire (THHN)

- Sold in 500' Rolls
- Solid or stranded
- Additional colors and insulations available upon request - CALL FOR QUOTE
- Purchase not eligible for prepaid freight



ITEM#	Product Description
6BST500	#6 Black Stranded THHN Tracer Wire
6WST500	#6 White Stranded THHN Tracer Wire
8BLST500	#8 Blue Stranded THHN Tracer Wire
8GST500	#8 Green Stranded THHN Tracer Wire
8WST500	#8 White Stranded THHN Tracer Wire
10BLK500	#10 Black Solid THHN Tracer Wire
10BST500	#10 Black Stranded THHN Tracer Wire
10BLU500	#10 Blue Solid THHN Tracer Wire
10BLST500	#10 Blue Stranded THHN Tracer Wire
10GRN500	#10 Green Solid THHN Tracer Wire
10YLW500	#10 Yellow Solid THHN Tracer Wire
12BLK500	#12 Black Solid THHN Tracer Wire
12BLU500	#12 Blue Solid THHN Tracer Wire
12BLST500	#12 Blue Stranded THHN Tracer Wire
12GRN500	#12 Green Solid THHN Tracer Wire
12WHT500	#12 White Solid THHN Tracer Wire
12YLW500	#12 Yellow Solid THHN Tracer Wire
14BLU500	#14 Blue Solid THHN Tracer Wire
14BLST500	#14 Blue Stranded THHN Tracer Wire
14YLW500	#14 Yellow Solid THHN Tracer Wire

### Heavy-Duty Rubberized Spray Undercoating

- Seals, protects and insulates
- Moisture and corrosion resistant
- Durable rubberized finish



**WARNING: Cancer & Reproductive Harm**  
www.P85Warnings.ca.gov

ITEM#	Product Description
81833	Heavy-Duty Rubberized Spray Undercoating

### Polyken #1027 Primer

- Liquid adhesive system for only Polyken coating systems
- Can be machine or brushed on
- Non-toxic and non-polluting



**WARNING: Cancer & Reproductive Harm**  
www.P85Warnings.ca.gov

ITEM#	Product Description
1027-GL	Polyken #1027 Primer (Adhesive) - Gallon

### Rapid Crete Rapid Plug

- Fast setting water proof mortar used to repair cracks and holes in masonry, even when water is flowing
- Product is bagged inside a bucket for easy storage and built in mixing tub
- Mortar sets within 5 minutes



**WARNING: Cancer**  
www.P85Warnings.ca.gov

ITEM#	Product Description
T5002	Rapid Crete Rapid Plug, 5 Gallon

### NO-OX-ID Ultra High Performance Rust Inhibitor

- Grease type rust preventative
- Protects metal from weathering, water, and other corrosive atmospheres
- Cold applied



ITEM#	Product Description
NO-OX-ID-1-WW	NO-OX-ID "A Special" Protective Metal Coating, 1 Gallon
NO-OX-ID-5-WW	NO-OX-ID "A Special" Protective Metal Coating, 5 Gallon
PWL600	NO-OX-ID PWL-600 Protective Coating, 1 Gallon

**Corrosion / Cathodic Protection**

**Christy's HD-50 Corrosion Prevention Coating**

- Single component
- Bituminous based coating
- Protects above and below ground metallic pipe and fittings from corrosion
- SCAQMD Low-VOC compliant



**WARNING: Reproductive Harm**  
www.P85Warnings.ca.gov

ITEM#	Product Description
HD50	Christy's HD-50 Corrosion Prevention Coating, 1 Gallon

**Bit Wrap Asphalt Tape**

- Durable woven glass filament mesh treated with asphalt
- Ideal for applications requiring a strong, lightweight reinforcement material
- Commonly used with Christy's CG15 Corrosion Guard



**WARNING: Cancer & Reproductive Harm**  
www.P85Warnings.ca.gov

ITEM#	Product Description
BW4	Bit Wrap Asphalt Tape

**CG15 Corrosion Guard 15 lb**

- Amber colored grease for all metal surfaces
- Barrier for metal surfaces against weathering and corrosion
- Use with Christy's Bit Wrap tape
- California Water Specifications



ITEM#	Product Description
CG15	Corrosion Guard 15 lb

**Corrosion / Cathodic Protection / Cold Applied AWWA C217 Wax Wraps and Accessories**

**Superior Corrosion Control Prime Guard Primer**

- Only minimal surface preparation required
- Easy to apply by hand
- No curing time necessary for immediate service
- Environmentally safe, non toxic, no VOCs
- No clay fillers
- Excellent wetting properties
- Conforms to AWWA C217 standards



ITEM#	Product Description
PGBP-GL	Prime Guard, SCC CorrGuard, Primer, 1 Gallon, Brown (4-1 Gallon Pails/Case)
PGWP-GL	Prime Guard, SCC CorrGuard, Primer, 1 Gallon, White (4-1 Gallon Pails/Case)

**Superior Corrosion Control Prime Guard 250**

- Only minimal surface preparation required
- Non-Melting
- No curing time necessary for immediate service
- Environmentally safe, non toxic, no VOC's
- Easy to apply by hand



ITEM#	Product Description
PGHTBP-GL	Prime Guard, SCC CorrGuard, High Temp, 250 Primer, Brown, 1 Gallon (4-1 Gallon Pails/Case)
PGHTSP-GL	Prime Guard, SCC CorrGuard, High Temp, 250 Primer, Silver, 1 Gallon (4-1 Gallon Pails/Case)



## Corrosion / Cathodic Protection / Cold Applied AWWA C217 Wax Wraps and Accessories

### Superior Corrosion Control Pro Mold Putty

- Pro Mold Putty is excellent for molding irregular surfaces for an even application of wax wraps
- Anticorrosive filling compound that can be applied over wet or dry surfaces with only minimal surface preparation
- No curing time needed for immediate service
- Environmentally safe, nontoxic, no VOC's
- Will not dry out in heavy clay soils



ITEM#	Product Description
PUTMLD2GL	Putty, SCC CorrGuard, Promold, 2 Gallon Pail

### Superior Corrosion Control CorrGuard AB Wax Wrap, for Above or Below Ground

CorrGuard AB is an 80-MIL Wax Wrap that is a petroleum based compound impregnated into a non-woven synthetic carrier that provides long term corrosion protection to above and below-ground metal structures when used in conjunction with Prime Guard. Specifically formulated to inhibit mold growth, CorrGuard AB firms up over time as non-solids escape. Wax is inert and does not degrade over time making Wax Wraps ideal for corrosion protection. Easy application and pliable in cold weather. Requires minimal surface preparation for maximum performance. Can be repositioned after application.

- Only minimal surface preparation required
- Easily conforms to irregular shaped profiles
- No curing time necessary
- Environmentally safe, non-toxic, no VOC's
- No clay fillers
- Can be used above and below-ground with appropriate Prime Guard selection
- Inhibits the growth of mold
- Applied over wet or dry surfaces
- Available in multiple colors



ITEM#	Product Description
WXW29AB-80MIL	Wrap, SCC CorrGuard, Wax, AB Above Ground 2" x 9', 80 mil (48/1)
WXW49AB-80MIL	Wrap, SCC CorrGuard, Wax, AB Above Ground 4" x 9', 80 mil (24/1)
WXW69AB	Wrap, SCC CorrGuard, Wax, AB Above Ground 6" x 9', 80 mil (16/1)
WXW918AB-80MIL	Wrap, SCC CorrGuard, Wax, AB Above Ground 9" x 18', 80 mil (6/1)
WXW1218AB-80MIL	Wrap, SCC CorrGuard, Wax, AB Above Ground 12" x 18', 80 mil (4/1)

### Superior Corrosion Control CorrGuard B for Below Ground

CorrGuard B is a highly conformable 80-MIL Wax Wrap that is a petroleum based compound impregnated into a non-woven synthetic carrier that provides long term corrosion protection to below-ground metal structures. Wax is inert and does not degrade over time making Wax Wraps ideal for corrosion protection. Easy application and pliable in cold weather. CorrGuard B has exceptional dielectric strength for compatibility with cathodic protection. CorrGuard B will protect the structure from external corrosion indefinitely if external forces do not damage the wrap.

- Only minimal surface preparation required
- Easily conforms to irregular shaped profiles
- No curing time necessary for immediate backfill
- Environmentally safe, non-toxic, no VOC's
- No clay fillers
- No primer dissolving solvents
- Applied over wet or dry surfaces
- Conforms to AWWA C2117



ITEM#	Product Description
WXW1218	Wrap, SCC CorrGuard, Wax, B Anticorrosion, Below Ground 12" x 18', Brown, 60 Mil (4/1)
WXW1218B-80MIL	Wrap, SCC CorrGuard, Wax, B Anticorrosion, Below Ground 12" x 18', Brown, 80 Mil (4/1)
WXW29B-80MIL	Wrap, SCC CorrGuard, Wax, B Anticorrosion, Below Ground 2" x 9', Brown, 80 Mil (48/1)
WXW49	Wrap, SCC CorrGuard, Wax, B Anticorrosion, Below Ground 4" x 9', Brown, 60 Mil (24/1)
WXW49B-80MIL	Wrap, SCC CorrGuard, Wax, B Anticorrosion, Below Ground 4" x 9', Brown, 80 Mil (24/1)
WXW69	Wrap, SCC CorrGuard, Wax, B Anticorrosion, Below Ground 6" x 9', Brown, 60 Mil (16/1)
WXW69B-80MIL	Wrap, SCC CorrGuard, Wax, B Anticorrosion, Below Ground 6" x 9', Brown, 80 Mil (16/1)
WXW918	Wrap, SCC CorrGuard, Wax, B Anticorrosion, Below Ground 9" x 18', Brown, 60 Mil (6/1)
WXW918B-80MIL	Wrap, SCC CorrGuard, Wax, B Anticorrosion, Below Ground 9" x 18', Brown, 80 Mil (6/1)

## Corrosion / Cathodic Protection / Cold Applied AWWA C217 Wax Wraps and Accessories

### Superior Corrosion Control SCC Poly Wrap Outerwrap

Available in 4"x50' (27 rolls/case) and 6"x50' (18 rolls/case), SCC Poly Wrap Outerwrap is a three-ply layer of 120-gauge polyethylene barrier film wrap layered together to give 3.6 mils of total thickness. Can be wrapped over wax wraps to give extra barrier protection to the coating system below ground.

- 3-ply construction with 3.6 mils total thickness
- Easily conforms to irregular shaped profiles
- Excellent electrical insulator giving high dielectric strength
- Environmentally safe, non-toxic
- Good stretch and toughness to withstand soil stress
- Inert and resists chemicals and bacteria



ITEM#	Product Description
PW4X50	Wrap, SCC, Poly Wrap Outerwrap, 4" x 50', Clear (27/1)
PW6X50	Wrap, SCC, Poly Wrap Outerwrap, 6" x 50', Clear (18/1)

### Superior Corrosion Control Corrguard HD Outerguard

In any environment there are conditions that may damage coatings such as abrasion, soil stress, frost heave, and mechanical damage. HD Outer Guard is a blend of plasticizers and resins saturated into a heavy duty synthetic knit carrier that cures to a hard cast by using the moisture in the surrounding environment. This hard cast provides the protection and added mechanical strength needed to keep the wrap intact and conformed to the metal structure, allowing the wrap to perform to its full potential.

- Easy to apply, minimal surface preparation is required
- Can be applied to hot or cold surfaces, above or below ground
- Excellent resistance to U.V.
- Provides an excellent profile for painting
- Increases mechanical protection to any coating system
- Special open knit material to prevent shielding of cathodic protection



ITEM#	Description
OG4X15	Wrap, SCC, HD Outerguard 4x15
OG4X30	Wrap, SCC, HD Outerguard 4x30
OG6X30	Wrap, SCC, HD Outerguard 6x30

## Chlorine/Water Testing

### Chlorine

- For disinfection and oxidation
- Tablets or granular



ITEM#	Product Description
30932	Chlorine – 1" 7 Gram Tablets, 5 lb Jug
30929	Chlorine – Granular, 5 lb Jug
22206	Chlorine – Granular, 25 lb Pail
22209	Chlorine – Granular, 100 lb Drum

### Captor® Dechlorination-Liquid Calcium - 5 Gal

- Liquid calcium thiosulfate solution for dechlorinating
- For highly chlorinated applications of 50 PPM or more



ITEM#	Product Description
CAPTOR5	Captor Dechlorination-Liquid Calcium – 5 Gal

### Norweco Bio-Neutralizer® Dechlorination Tablets

- 5oz / 2 5/8" diameter tablets
- Sodium Sulfate dechlorinating tablets



ITEM#	Product Description
DC25	Dechlorination-Norweco Bio Neutralizer Tablets 25 lb Jug
DC45	Dechlorination-Norweco Bio Neutralizer Tablets 45 lb Jug

## Chlorine/Water Testing

### Vita-D-Chlor Dechlorinating Granules 5.5 lb Jug

- Easy dissolving fine granular form
- NSF Certified (Dechlorination and antioxidant chemical)
- Meets pharmaceutical industry standards for purity (USP)



ITEM#	Product Description
VDC5-5	Vita-D-Chlor Dechlorinating Granules 5.5 lb Jug

### Vita-D-Chlor Dechlorinating Tablets

- 3oz / 2 5/8" diameter white tablets with citrus odor
- Simple and fast set up for treating potable water in dewatering and flushing applications
- 1 tablet neutralizes 8,500 gallons with 1ppm chlorine



ITEM#	Product Description
VDT6	3oz / 2 5/8" - Vita-D-Chlor Dechlorinating 6 Tablets
VDT20	3oz / 2 5/8" - Vita-D-Chlor Dechlorinating 20 Tablets
VDT40	3oz / 2 5/8" - Vita-D-Chlor Dechlorinating 40 Tablets
VDT140	3oz / 2 5/8" - Vita-D-Chlor Dechlorinating 140 Tablets

### Tablet Water Tracing Dye System

- 200 tablets per bottle
- 1 tablet provides visual in 60 gallons
- Detects leaks, use for flow studies and mapping
- NSF approved



ITEM#	Product Description	Case Qty.
STD-BLU-T	Water Tracing Dye System - NSF Blue Tablets	1
FLT-RED-T	Water Tracing Dye System - NSF Red Tablets	1
FLT-YG-T	Water Tracing Dye System - NSF Yellow Tablets	1

### Liquid Water Tracing Dye System

- 1 pint liquid bottle provides visual in 12/500 gallons
- Detects leaks, use for flow studies and mapping
- Visually seen with black light



ITEM#	Product Description	Case Qty.
FLT-RED-L25	Water Tracing Dye System - Liquid Fluorescent Red	1
FLT-YG-L	Water Tracing Dye System - Liquid Fluorescent Yellow/Green	1

### Powder Water Tracing Dye System

- Best for moderate to large volumes of water, more than 50,000 gallons
- May be used for visual, ultraviolet\* and fluorometric\* inspections
- Moderate rate of dispersion



ITEM#	Product Description	Case Qty.
FLT-YG-P	Water Tracing Powder – Fluorescent Yellow/Green	1

## Bolts & Specialties

### Flange Kit

- Zinc plated nuts/bolts with gaskets
- Neoprene gasket
- AWWA C110
- For CL 150# flange



**WARNING: Cancer & Reproductive Harm**  
www.P85Warnings.ca.gov

ITEM#	Product Description
BK20FF	2" Flange Kit with Full Face Gasket
BK20RG	2" Flange Kit with Ring Gasket
BK25FF	2 1/2" Flange Kit with Full Face Gasket
BK25RG	2 1/2" Flange Kit with Ring Gasket
BK30FF	3" Flange Kit with Full Face Gasket
BK30RG	3" Flange Kit With Ring Gasket
BK40FF	4" Flange Kit With Full Face Gasket
BK40RG	4" Flange Kit With Ring Gasket
BK60FF	6" Flange Kit With Full Face Gasket
BK60RG	6" Flange Kit With Ring Gasket
BK80FF	8" Flange Kit With Full Face Gasket
BK80RG	8" Flange Kit With Ring Gasket

### Breakable Padlock for Post Indicator Valves

- Cadmium plated steel padlock
- With brittle shackle



**WARNING: Cancer & Reproductive Harm**  
www.P85Warnings.ca.gov

ITEM#	Product Description
7158	5/8" Breakable Padlock
7175	3/4" Breakable Padlock For PIVS

### Tubular Manhole Water Stop Gasket

- For use on PVC sewer pipe
- Made from SBR
- Conforms to ASTM C-923



**WARNING: Cancer & Reproductive Harm**  
www.P85Warnings.ca.gov

ITEM#	Product Description
MA4	4" Tubular Manhole Water Stop Gasket
MA6	6" Tubular Manhole Water Stop Gasket
MA8	8" Tubular Manhole Water Stop Gasket
MA10	10" Tubular Manhole Water Stop Gasket
MA12	12" Tubular Manhole Water Stop Gasket
MA15	15" Tubular Manhole Water Stop Gasket
MA18	18" Tubular Manhole Water Stop Gasket
MA21	21" Tubular Water Stop Gasket

### Belt Manhole Water Stop Gasket



ITEM#	Product Description
W-S-04	4" Belt Manhole Water Stop Gasket
W-S-06	6" Belt Manhole Water Stop Gasket
W-S-08	8" Belt Manhole Water Stop Gasket
W-S-10	10" Belt Manhole Water Stop Gasket
W-S-12	12" Belt Manhole Water Stop Gasket
W-S-15	15" Belt Manhole Water Stop Gasket
W-S-18	18" Belt Manhole Water Stop Gasket
W-S-21	21" Belt Manhole Water Stop Gasket
W-S-24	24" Belt Manhole Water Stop Gasket
W-S-27	27" Belt Manhole Water Stop Gasket
W-S-30	30" Belt Manhole Water Stop Gasket
W-S-36	36" Belt Manhole Water Stop Gasket
W-S-42	42" Belt Manhole Water Stop Gasket
W-S-48	48" Belt Manhole Water Stop Gasket



## Bolts & Specialties

### Ground Hydrant/Pavement Reflector 4" X 4" Blue

- Manufactured from optical-grade Acrylic
- Use with Taping Kit



ITEM#	Product Description
PRB44	Ground Hydrant/Pavement Reflector 4" X 4" Blue

### Hydrant 2 Sided Taping Kit

- Good for use on 1 reflector



ITEM#	Product Description
HTK2	Hydrant 2 Sided Taping Kit

## Fire Protection

### Control Valve Supervisory Switch

- Monitors the open position of fire sprinkler control valves of the post indicator/ butterfly and others
- For use on post indicator and BF valves



**WARNING: Cancer & Reproductive Harm**  
[www.P65Warnings.ca.gov](http://www.P65Warnings.ca.gov)

ITEM#	Product Description
1010207	Control Valve Supervisory Switch

### Outside Screw & Yoke Valve Supervisory Switch

- Monitors open position of OS & Y valves
- Mounts to valves 2" through 12"
- Contains 2 sets of SPDT (Form C Contacts)



ITEM#	Product Description
1010206	Outside Screw & Yoke Valve Supervisory Switch

### United Wafer Check Valve

- Ductile iron body, Bronze seat ring assembly
- Stainless steel screw
- Buna-N seat and face o-rings
- 250 WOG @ 180 deg max



**WARNING: Cancer & Reproductive Harm**  
[www.P65Warnings.ca.gov](http://www.P65Warnings.ca.gov)

ITEM#	Product Description
4WC	4" UL / FM United Wafer Check Valve
6WC	6" UL / FM United Wafer Check Valve
8WC	8" UL / FM United Wafer Check Valve

**Waterworks Tools**

**Curb Stop Wrenches for Corporation Valves**

- Constructed of 1 1/2" heavy wall square tubing
- Blue powder coated finish
- Vynafoam grips for added comfort



**WARNING: Cancer**  
www.P85Warnings.ca.gov

ITEM#	Product Description
WT-CS18-0100	Curb Stop Wrenches – 18" Long for 3/4" and 1" Corporation Valves
WT-CS18-0200	Curb Stop Wrenches – 18" Long for 1 1/2" and 2" Corporation Valves
WT-CS36-0100	Curb Stop Wrenches – 36" Long for 3/4" and 1" Corporation Valves
WT-CS36-0200	Curb Stop Wrenches – 36" Long for 1 1/2" and 2" Corporation Valves

**Curb Stop Wrenches - 24"/42" Adjustable for Corporation Valves**

- Constructed of 1 1/2" heavy wall square tubing
- Blue powder coated finish
- Vynafoam grips for added comfort



**WARNING: Cancer**  
www.P85Warnings.ca.gov

ITEM#	Product Description
WT-CS2442-0100	Curb Stop Wrenches – 24"/42" Two Position for 3/4" and 1" Corporation Valves
WT-CS2442-0200	Curb Stop Wrenches – 24"/42" Two Position for 1 1/2" and 2" Corporation Valves
WT-PIN	Telescoping Gate Valve Wrench Replacement Pin

**Extra Heavy Duty Digging Bar**

- Hardened tempered plow steel
- Heat treated pick on one end and wedge on other
- Ideal for dispersing tough soil while excavating
- Blue powder coated finish



**WARNING: Cancer**  
www.P85Warnings.ca.gov

ITEM#	Product Description
WT-XHDB	Extra Heavy Duty Digging Bar 6' X 1 1/4" Hex Bar
WT-XHDB-ROUND5	Extra Heavy Duty Digging Bar 5' X 1 1/4" Round Bar
WT-XHDB-ROUND	Extra Heavy Duty Digging Bar 6' X 1 1/4" Round Bar

**Gate Valve Wrench**

- For 2" AWWA gate valve operation nuts
- Shaft is 1 1/2" heavy wall square tubing
- 30" X 1" Sch.40 steel handle
- Blue powder coated finish

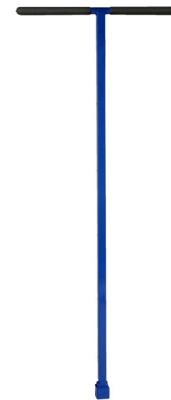

**WARNING: Cancer**  
www.P85Warnings.ca.gov

ITEM#	Product Description
WT-GVW-60	Gate Valve Wrench 5'; Standard
WT-GVW-72	Gate Valve Wrench 6'; Standard

## Waterworks Tools

### Adjustable Hydrant Lifting Sling

- Safely installs and removes fire hydrants
- Nylon straps will not harm exterior finishes
- Adjusts quickly to fit different style hydrants



ITEM#	Product Description
WT-HLS400	Adjustable Hydrant Lifting Sling

### Adjustable Gate Valve Wrench

- For 2" AWWA gate valve operation nuts
- Shaft is 1" heavy wall square tubing
- 30" X 1" Sch.40 steel handle
- Blue powder coated finish



**WARNING: Cancer**  
www.P65Warnings.ca.gov

ITEM#	Product Description
WT-GVW-0510	Gate Valve Wrench 5' – 10' Extendable
WT-GVW-0611	Gate Valve Wrench 6' – 11' Extendable
WT-GVW-2442-2	Gate Valve Wrench, 24" – 42" Extendable
WT-PIN	Telescoping Gate Valve Wrench Replacement Pin

### Speed Handle Wheel for 2" Valve Operation Nut

- Handle has bearing surface for actuation ease
- Blue powder coat finish



**WARNING: Cancer**  
www.P65Warnings.ca.gov

ITEM#	Product Description
WT-GVSW	Speed Handle Wheel for 2" Valve Operation Nut

### Manhole Hook

- Perpendicular handle
- Blue powder coated finish



ITEM#	Product Description
WT-MHOOK-12	Manhole Hook With 1/2" Shaft X 27" Length
WT-MHOOK-58	Manhole Hook With 5/8" Shaft X 27" Length
WT-MHOOK-5836	Manhole Hook With 5/8" Shaft X 36" Length

### Stainless Steel Meter Box Lid Remover

- Polished 304 SS tubing
- Vynafoam grip with wrist string for added comfort



**WARNING: Cancer**  
www.P65Warnings.ca.gov

ITEM#	Product Description
WT-MLR24	24" Stainless Steel Meter Box Lid Remover
WT-MLR36	36" Stainless Steel Meter Box Lid Remover

### Economy Water Meter Key

- For hard to turn valves
- 3/4" solid driver head and tubular steel shaft
- 32" length with 18" steel handle
- Black powder coated finish



**WARNING: Cancer**  
www.P65Warnings.ca.gov

ITEM#	Product Description
WT-HDWMK	Economy Water Meter Key

## Waterworks Tools

### Universal Water Meter Wrench

- 12" polished 304 SS
- Vynafoam grip for added comfort



**WARNING: Cancer**  
www.P85Warnings.ca.gov

ITEM#	Product Description
WT-UWMW400	Universal Water Meter Wrench
WT-UWMW-JAW	Universal Water Meter Wrench Replacement w/ Teeth

### Skimmer Test Plug Wrench

- Allows removal of galvanized plug at base of skimmer
- Black powder coated finish



**WARNING: Cancer**  
www.P85Warnings.ca.gov

ITEM#	Product Description
WT-SKIMMER	Skimmer Test Plug Wrench

### Valve Lifting Device

- Capable of lifting up through 12" Class 300 valves
- For AWWA C509 and C515 gate valves
- Blue powder coated finish



**WARNING: Cancer**  
www.P85Warnings.ca.gov

ITEM#	Product Description
WT-VL400	Valve Lifting Device

### Hydrant Wrench

- Cadmium plated, cast iron adjustable wrench for pentagonal nuts or pin and rocker lug fittings



**WARNING: Cancer & Reproductive Harm**  
www.P85Warnings.ca.gov

ITEM#	Product Description
7111	Hydrant Wrench

### Pipe Supports

- Zinc plated threads and nut
- Saddle or flange mount supports 2" - 24" pipe
- 30" height can be adjusted an additional 6" with threaded collar
- Can be cut down to as low as 11"
- Blue powder coated finish
- Base material 6" X 6" X 3/8" plate



**WARNING: Cancer**  
www.P85Warnings.ca.gov

ITEM#	Product Description
WT-PSFM-104	Pipe Support w/ 1" Riser For Flange Mount (4" Pipe)
WT-PSFM-106	Pipe Support w/ 1" Riser For Flange Mount (6" Pipe)
WT-PSFM-108	Pipe Support w/ 1" Riser For Flange Mount (8" Pipe)
WT-PSSM-100	Pipe Support w/ 1" Riser For Saddle Mount (2"- 8" Pipe)
WT-PSSM-200	Pipe Support w/ 1 1/2" Riser For Saddle Mount (10"-16" Pipe)
WT-PSSM-300	Pipe Support w/ 2" Riser For Saddle Mount (18"- 24" Pipe)



## Waterworks Tools

### 4' Stainless Steel Soil Probe

- 304 Stainless Steel handle
- Vynafoam grip with wrist string for added comfort
- Stainless steel shaft



**WARNING: Cancer**  
www.P85Warnings.ca.gov

ITEM#	Product Description
WT-SP48	4' Stainless Steel Soil Probe

### Yellow Fiberglass Soil Probe

- 48" X 1/2" diameter
- Fiberglass handle/shaft with cast aluminum tip
- Insulated and non-conductive



**WARNING: Cancer**  
www.P85Warnings.ca.gov

ITEM#	Product Description
SP48	4' Yellow Fiberglass Soil Probe

### 5' Aluminum Tip Soil Probe

- Plastic coated steel handle
- Steel shaft
- High strength aluminum tip

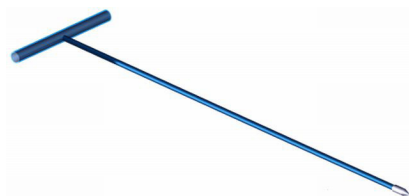

**WARNING: Cancer**  
www.P85Warnings.ca.gov

ITEM#	Product Description
SP5F	5' Aluminum Tip Soil Probe

### Polyfiber Valve Stem Extension - Lower Operating Nut (Female)

- Injected molded aircraft-grade poly compound
- Corrosion resistant



**WARNING: Cancer**  
www.P85Warnings.ca.gov

ITEM#	Product Description
WT-PFLF-100	Polyfiver Valve Stem Extension – Lower Operating Nut (Female)

### Polyfiber Valve Stem Extension Adhesive



**WARNING: Cancer & Reproductive Harm**  
www.P85Warnings.ca.gov

ITEM#	Product Description
WT-FAD-37	Polyfiber Valve Stem Extension Adhesive 3.7oz
WT-FAD-102	Polyfiber Valve Stem Extension Adhesive 10.2oz

### Polyfiber Valve Stem Extension - 2" Square Tubing

- Tested at 750 lbs
- Corrosion resistant
- 1/2" wall thickness
- Nut with valve can ring sold separately



**WARNING: Cancer & Reproductive Harm**  
www.P85Warnings.ca.gov

ITEM#	Product Description
WT-FGT-100	Polyfiber Valve Stem Extension 2" Square Tubing 10'; Length
WT-FGT-200	Polyfiber Valve Stem Extension 2" Square Tubing 20'; Length

## Waterworks Tools

### Polyfiber Valve Stem Extension - Upper Operating Nut W/Valve Can Ring (Male)

- Injected molded aircraft grade poly compound
- Centering ring fits 8" valve cans
- Can be easily trimmed to fit 4" and 6" valve cans
- Corrosion resistant
- Tubing sold separately



**WARNING: Cancer**  
www.P65Warnings.ca.gov

ITEM#	Product Description
WT-PFUM-100	Polyfiber Valve Stem Extension – Upper Operating Nut W/ Valve Can Ring (Male)

### Steel Valve Extension w/ 1 1/2" Square Shaft (Primer)

- 5' long
- Standard 2" drive nuts
- Heavy wall square tubing
- Can make custom order stem extension
- Enamel coated



**WARNING: Cancer & Reproductive Harm**  
www.P65Warnings.ca.gov

ITEM#	Product Description
WT-SVE150-P	5' Steel Valve Extension w/ 1 1/2" Square Shaft (Primer)

### Test Plate Class 150

- Check integrity of line before installing valve
- Two slots at top of plate for easy installation
- Clear zinc finish
- 3/16" thickness up to 12"
- 3/8" thickness for 14" - 24"



**WARNING: Cancer**  
www.P65Warnings.ca.gov

ITEM#	Product Description
WT-STP-04	4" In-Line Test Plate Class 150
WT-STP-06	6" In-Line Test Plate Class 150
WT-STP-08	8" In-Line Test Plate Class 150
WT-STP-10	10" In-Line Test Plate Class 150
WT-STP-12	12" In-Line Test Plate Class 150
WT-STP-14	14" In-Line Test Plate Class 150
WT-STP-16	16" In-Line Test Plate Class 150
WT-STP-18	18" In-Line Test Plate Class 150
WT-STP-20	20" In-Line Test Plate Class 150
WT-STP-24	24" In-Line Test Plate Class 150

### Christy's Waterline Replacement Kit



ITEM#	Product Description
WT-WLK-50	Christy's Waterline (50' cable) Replacement Kit
WT-WLK-75	Christy's Waterline (75' cable) Replacement Kit
WT-WLK-100	Christy's Waterline (100' cable) Replacement Kit

## Waterworks Tools

### Waterline Replacement Kit Parts

- Replacement Parts for Waterline Kits



**WARNING: Cancer**  
www.P65Warnings.ca.gov

ITEM#	Product Description
WT-CH100	Waterline Replacement Parts – 3/4" and 1" Service Cutter Head
WT-CTA075	Waterline Replacement Kit Parts – 3/4" Copper Tubing Adapter
WT-CTA100	Waterline Replacement Kit Parts – 1" Copper Tubing Adapter
WT-DWP100	Waterline Replacement Kit Parts – Double Weave Pipe Puller For 3/4" through 1" Pipe
WT-DWP200	Waterline Replacement Kit Parts – Double Weave Pipe Puller For 1 1/4" through 2" Pipe
WT-DWPA	Waterline Replacement Kit Parts – Double Weave Pipe Pulling Adapter
WT-KPG	Waterline Replacement Kit Parts – Klein Cable Pulling Grip
WT-WR100	Waterline Replacement Kit Parts -100'; Heavy Duty Pulling Cable
WT-WR50	Waterline Replacement Kit Parts – 50'; Heavy Duty Pulling Cable
WT-WR75	Waterline Replacement Kit Parts – 75'; Heavy Duty Pulling Cable

## Vent Caps / Bug Screens

### Mushroom Vent Cap

- Rust resistant galvanized cast iron vent cap
- #30 mesh screen



ITEM#	Product Description
4021	Mushroom Vent Cap 3/4" FNPT #30 Mesh
4022	Mushroom Vent Cap 1" FNPT #30 Mesh
4025	Mushroom Vent Cap 2" FNPT #30 Mesh
4027	Mushroom Vent Cap 3" FNPT #30 Mesh
4028	Mushroom Vent Cap 4" FNPT #30 Mesh

## Backflow Protection

### Backflow Security Freeze Blanket

- Herculite 10W laminated fabric
- Velcro® Texacro® fasteners
- R19 insulation rating
- Custom sizes available, need manufacturer model #, size and if OS&Y valves are installed



ITEM#	Product Description	Size	Sizing Guidelines
BFSC2018	Backflow Security Freeze Blanket	20" x 18"	3/4" Valves
BFSC2420	Backflow Security Freeze Blanket	24" x 20"	3/4" through 1" Valves
BFSC2424	Backflow Security Freeze Blanket	24" x 24"	3/4" through 1 1/4" Valves
BFSC3624	Backflow Security Freeze Blanket	36" x 24"	1 1/2" through 2" Valves
BFSC3636	Backflow Security Freeze Blanket	36" x 36"	2" Valves
BSFC4824	Backflow Security Freeze Blanket	48" x 24"	2" Valves
BSFC4830	Backflow Security Freeze Blanket	48" x 30"	2" - 2 1/2" Valves
BSFC4842	Backflow Security Freeze Blanket	48" x 42"	2 1/2" Valves
BSFC5424	Backflow Security Freeze Cover	54" x 24"	Not Standard
BSFC6038	Backflow Security Freeze Blanket	60" x 38"	3" Valves
BSFC7262	Backflow Security Freeze Blanket	72" x 62"	Not Standard
BSFC7438	Backflow Security Freeze Cover	74" x 38"	4" Valves
BSC10248	Backflow Security Freeze Blanket	102" x 48"	8" Valves
BSFC11448	Backflow Security Freeze Blanket	114" x 48"	10" Valves