

# Panasonic®

Removable Front Panel MP3 WMA CD Player/Receiver  
with CD Changer Control

Récepteur/lecteur CD MP3 WMA avec panneau avant  
amovible et contrôle de changeur CD

Reproductor de CD MP3 WMA/Receptor con Controlador  
de Cambiador de Discos y Panel Frontal Removible

## CQ-DP383U

Operating Instructions  
Manuel d'instructions  
Manual de instrucciones



**Panasonic Consumer  
Electronics Company, Division  
of Matsushita Electric  
Corporation of America**  
One Panasonic Way, Secaucus,  
New Jersey 07094  
<http://www.panasonic.com>

**Panasonic Sales Company.  
Division of Matsushita Electric  
of Puerto Rico, Inc. ("PSC")**  
Ave. 65 de Infanteria, Km. 9.5  
San Gabriel Industrial Park,  
Carolina, Puerto Rico 00985  
<http://www.panasonic.com>

**Panasonic Canada Inc.**  
5770 Ambler Drive,  
Mississauga, Ontario  
L4W 2T3  
<http://www.panasonic.ca>

YFM284C374ZA TAMACO1202-0 Printed in China  
Imprimé en Chine  
Impreso en China



**WMA MP3**

- Please read these instructions carefully before using this product and save this manual for future use.
- Prière de lire ces instructions attentivement avant d'utiliser le produit et garder ce manuel pour l'utilisation ultérieure.
- Lea con atención estas instrucciones antes de utilizar el producto y guarde este manual para poderlo consultar en el futuro.

## Safety Information

### WARNING:

TO REDUCE THE RISK OF FIRE OR ELECTRIC SHOCK, DO NOT EXPOSE THIS PRODUCT TO RAIN OR MOISTURE.

TO REDUCE THE RISK OF FIRE OR ELECTRIC SHOCK, AND ANNOYING INTERFERENCE, USE ONLY THE INCLUDED COMPONENTS.

### CAUTION:

THIS PRODUCT IS A CLASS I LASER PRODUCT. USE OF CONTROLS OR ADJUSTMENTS OR PERFORMANCE OF PROCEDURES OTHER THAN THOSE SPECIFIED HEREIN MAY RESULT IN HAZARDOUS RADIATION EXPOSURE. DO NOT OPEN COVERS AND DO NOT REPAIR YOURSELF. REFER SERVICING TO QUALIFIED PERSONNEL.

The following applies only in the U.S.A.

### Part 15 of the FCC Rules

#### FCC Warning:

Any unauthorized changes or modifications to this equipment would void the user's authority to operate this device.

### NOTICE:

This product has a fluorescent lamp that contains a small amount of mercury. It also contains lead in some components. Disposal of these materials may be regulated in your community due to environmental considerations. For disposal or recycling information please contact your local authorities, or the Electronics Industries Alliance: <<http://www.eiae.org>>

Find the model number and serial number on either the back or bottom of the unit. Please record them in the space below and retain this booklet as a permanent record of your purchase to help with identification in case of theft.

MODEL NUMBER           CQ-DP383U            
 SERIAL NUMBER \_\_\_\_\_  
 DATE PURCHASED \_\_\_\_\_  
 FROM \_\_\_\_\_

## Consignes de sécurité

### MISE EN GARDE:

POUR RÉDUIRE LES RISQUES D'INCENDIE OU D'ÉLECTROCUTION, N'EXPOSEZ PAS CET APPAREIL À LA PLUIE OU À L'HUMIDITÉ.

AFIN DE PRÉVENIR TOUT RISQUE D'INCENDIE OU D'INTERFÉRENCES, UTILISER UNIQUEMENT LES COMPOSANTS FOURNIS.

### ATTENTION:

CET APPAREIL EST UN PRODUIT LASER DE LA CLASSE I. L'UTILISATION DE COMMANDES OU RÉGLAGES OU L'EXÉCUTION D'OPÉRATIONS AUTRES QUE CELLES QUI SONT INDIQUÉES DANS CE DOCUMENT PEUVENT RÉSULTER EN UNE EXPOSITION À UN RAYONNEMENT DANGEREUX. N'OUVREZ PAS LES COUVERTLES ET N'ESSEYER PAS D'EFFECTUER VOUS-MÊME DES RÉPARATIONS. ADRESSEZ-VOUS À UN PERSONNEL QUALIFIÉ POUR TOUTE RÉPARATION.

Il est recommandé de noter, dans l'espace prévu ci-dessous, les numéros de modèle et de série inscrits soit à l'arrière soit sous le fond de l'appareil, et de conserver ce manuel comme mémorandum de l'achat afin de permettre l'identification de l'appareil en cas de vol.

NUMÉRO DE MODÈLE           CQ-DP383U            
 NUMÉRO DE SÉRIE \_\_\_\_\_  
 DATE DE L'ACHAT \_\_\_\_\_  
 VENDEUR \_\_\_\_\_

## Información para su seguridad

### ADVERTENCIA:

PARA REDUCIR EL RIESGO DE INCENDIOS O SACUDIDAS ELÉCTRICAS, NO EXPONGA ESTE PRODUCTO A LA LLUVIA NI A LA HUMEDAD.

PARA REDUCIR EL RIESGO DE INCENDIOS O SACUDIDAS ELÉCTRICAS, Y PARA EVITAR LAS INTERFERENCIAS MOLESTAS, UTILICE SOLAMENTE LOS COMPONENTES INCLUIDOS.

### PRECAUCIÓN:

ÉSTE ES UN PRODUCTO LASER DE LA CLASE I. LA UTILIZACIÓN DE CONTROLES, EL HACER AJUSTES O EL SEGUIR PROCEDIMIENTOS DISTINTOS DE LOS ESPECIFICADOS EN ESTE MANUAL PODRÍA CAUSAR UNA EXPOSICIÓN PELIGROSA A LA RADIACIÓN. NO ABRA LAS CUBIERTAS NI HAGA REPARACIONES USTED MISMO. SOLICITE LOS TRABAJOS DE SERVICIO AL PERSONAL CALIFICADO.

Busque el número del modelo y el número de serie ya sea en la parte trasera o en el fondo de la unidad. Sírvase anotar dichos números en el espacio siguiente, y mantenga este librete como una anotación permanente de su compra para ayudar en la identificación en el caso de robo.

NÚMERO DEL MODELO           CQ-DP383U            
 NÚMERO DE SERIE \_\_\_\_\_  
 FECHA DE COMPRA \_\_\_\_\_  
 NOMBRE DE LA TIENDA \_\_\_\_\_

Panasonic welcomes you to our ever growing family of electronic product owners. We know that this product will bring you many hours of enjoyment. Our reputation is built on precise electronic and mechanical engineering, manufactured with carefully selected components and assembled by people who take pride in their work. Once you discover the quality, reliability, and value we have built into this product, you too will be proud to be a member of our family.

## Use this Product Safely

### When Driving

Keep the volume level low enough to be aware of road and traffic conditions.

### When Washing Your Car

Do not expose the product, including the speakers and CDs, to water or excessive moisture. This could cause electrical shorts, fire, or other damage.

### When Parked

Parking in direct sunlight can produce very high temperatures inside your car. Give the interior a chance to cool down before switching the unit on.

### Use the Proper Power Supply

This product is designed to operate with a 12 V DC, negative ground battery system (the normal system in a North American car).

### Disc Mechanism

Do not insert coins or any small objects. Keep screwdrivers and other metallic objects away from the disc mechanism and disc.

### Use Authorized Servicenters

Do not attempt to disassemble or adjust this precision product. Please refer to the Servicenter list including with this product for service assistance.

### For Installation

This product should be installed in a horizontal position with the front end up at a convenient angle, but not more than 30°.

#### Note:

- The preset memory is cleared to return to the original factory setting when the power connector or battery is disconnected.

## Features

### Large-sized Volume Control

An large-sized rotary volume control that looks like one belonging to a Hi-Fi audio system is featured.

### CD Changer Control

You need connect the optional CD changer unit. For details, refer to the operating instructions on the CD changer unit.

### MP3/WMA Playback from CD-R/RW

You can play your MP3/WMA (Windows Media Audio) files as well as regular CDs.

With up to 10 to 12 times\* the capacity of a conventional CD, a single MP3/WMA-encoded disc can keep you entertained throughout your entire journey.

\*Depending on data bit rate.

Example:

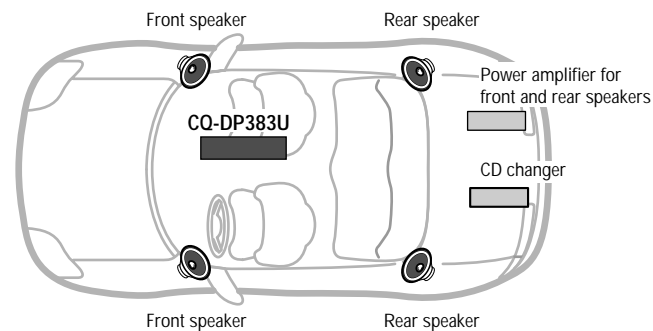

## Before Reading these Instructions



This can only be controlled through the main unit.



This can only be controlled through the remote control unit.

Operations with neither mark can be performed either by the main unit or the remote control unit.

# Contents

Safety Information . . . . . Page 2  
 Use this Product Safely . . . . . 4  
 Features . . . . . 4  
 Before Reading these Instructions . . . . . 5

**Accessories** . . . . . 16

**Remote Control Unit Preparation** . . . . . 16  
 Battery installation, battery notes

---

**General** . . . . . 17  
 Power (POWER), source (SRC), volume, muting, loudness

---

**Clock Set** . . . . . 19  
 Time reset, display change

---

**Radio** . . . . . 20  
 Radio mode, band, tuning, display change, preset station setting, manual preset memory, Auto Preset Memory (APM), preset station calling

---

**CD Player** . . . . . 22  
 Listening to a CD, insert the disc, stop and eject the disc, pause, track (file) selection, folder selection, fast forward/fast reverse, repeat play, random play, folder random play (MP3/WMA only), folder repeat play (MP3/WMA only), scan play, folder scan play (MP3/WMA only), display change, direct track (file) selection, direct folder selection, text scroll, ID3/WMA tag setting, notes on MP3/WMA

---

**CD Changer Control** . . . . . 29  
 CD changer mode, disc selection, track selection, fast forward/fast reverse, repeat play, disc repeat play, random play, disc random play, scan play, disc scan play, display change, direct disc selection

---

**Audio Settings** . . . . . 32  
 Volume, bass and treble, balance and fader

---

**Troubleshooting** . . . . . 34  
 Preliminary steps, if you suspect something wrong, troubleshooting tips, error display messages, maintenance, product servicing, replacing the fuse

---

**Maintenance** . . . . . 41  
 Notes on CD-Rs/RWs, notes on CD/CD media (CD-ROM, CD-R, CD-RW)

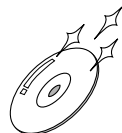
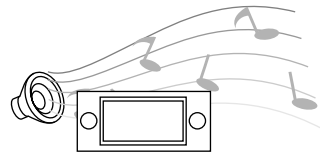
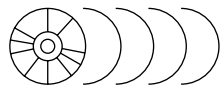
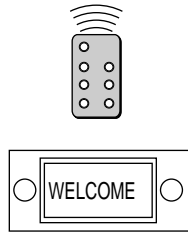

**Installation Guide** . . . . . 42  
 Remove the unit

---

**Anti-Theft System** . . . . . 47  
 Place the removable face plate into case, install removable face plate

---

**Electrical Connections** . . . . . 48  
 Caution, wiring diagram, upgrading the system

---

**Specifications** . . . . . 51

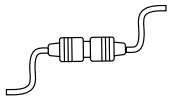
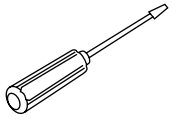

# Accessories

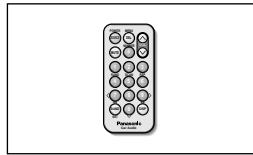

- Remote control unit (1)

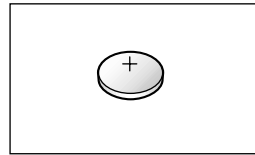

- Lithium battery (CR2025) (1)

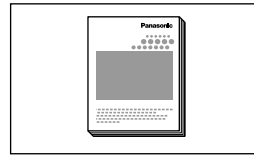

- Operating instructions (1)

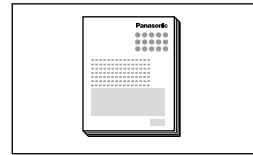

- Operating guide for Sirius (1)

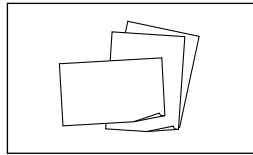

- Warranty card, etc.

- Installation hardware (screws, power connector, etc.) (page 42)

## Remote Control Unit Preparation

### Battery Installation

- 1 Remove the battery holder.  
Pull the battery holder by the position B while pushing position A in the direction indicated by the arrow.
- 2 Install the battery on the battery holder.
- 3 Insert the battery holder back into its original position.

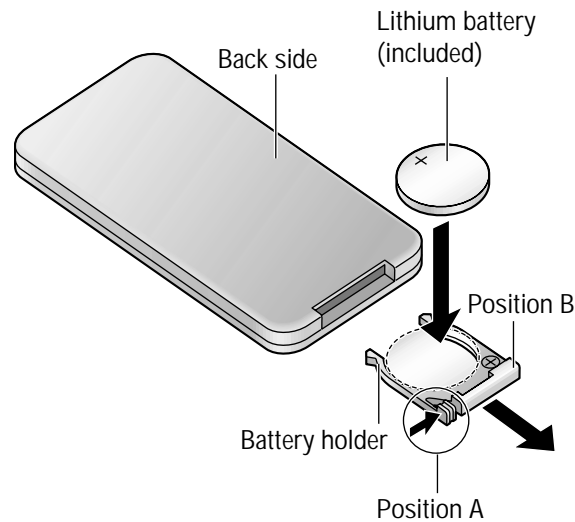

### Battery Notes

- Battery type: Panasonic lithium battery (CR2025) (included)
- Battery life: Approximately 6 months with normal use (at room temperature)

#### Caution:

- Improper use of batteries may cause overheating, an explosion or ignition, resulting in injury or a fire. Battery leakage may damage the unit.
- Remove and dispose of an old battery immediately.
- Do not disassemble or short the battery. Do not throw a battery into a fire.
- Keep batteries away from children to avoid the risk of accidents.
- Be careful to observe proper local disposal rules when you dispose of batteries.

# General

## 1 Power (POWER)

Turn your car's ignition key to ACC or ON position.

**ON:** Press [POWER].

**OFF:** Press and hold [POWER] again on the main unit for more than 1 second.

Press and hold [POWER] again on the remote control unit for more than 2 second.

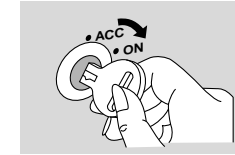

#### Note:

- When the power is switched on for the first time, a demonstration message appears on the display.  
To cancel this display, press [DISP] (display).

- To display the message again, press and hold [SRC] (source) on the main unit for more than 4 seconds when the power is off.

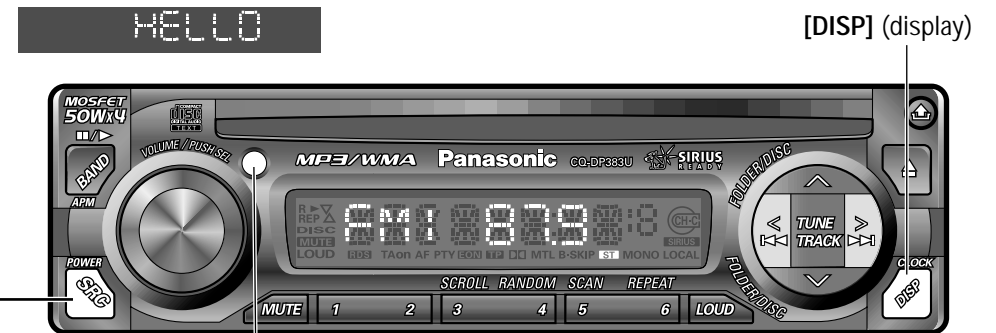

## 2 Source (SRC)

Press [SRC] (source) to change the source.

Remote control signal sensor  
Point the remote control unit at the main unit's sensor.

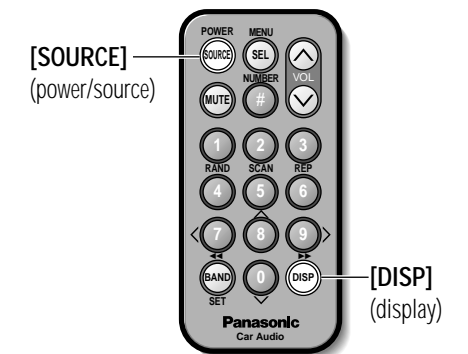
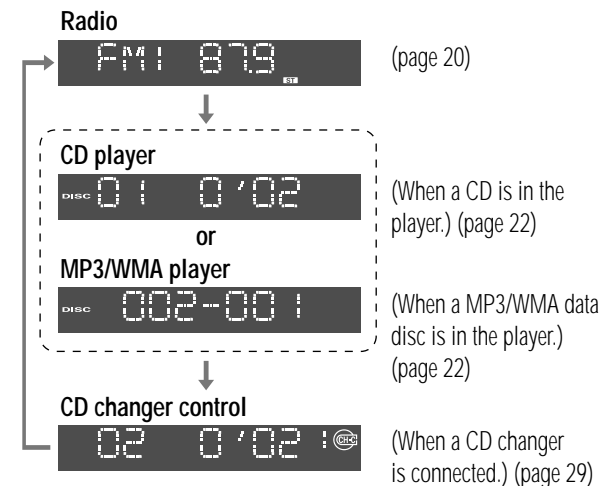

For details on the Sirius mode, refer to the separate operating guide for Sirius.

# General (continued)

## Volume

Turn [VOL].

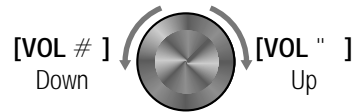

[VOL " ]: Up  
[VOL # ]: Down

**VOL 18** Setting range: 0 to 40 (default: 18)

### Note:

- The sound level for each source is stored in memory. (For radio, one volume setting for AM, one volume setting for all FMs)

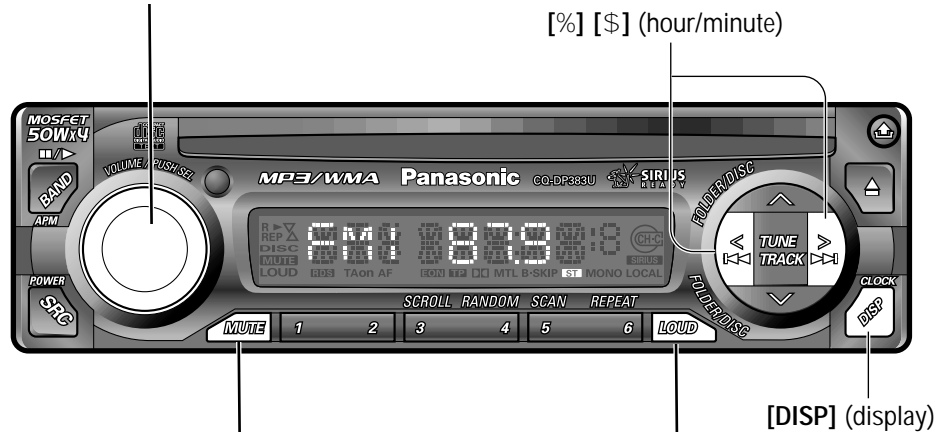

## Muting

Press [MUTE].

**MUTE** No sound. [MUTE] lights.

Press [MUTE] again to cancel.

## Loudness

To enhance bass and treble tones at low or medium volume.

Press [LOUD] (loudness).

**LOUD** [FM 87.9] [LOUD] lights.

Press [LOUD] (loudness) again to cancel.

# Clock Set

The 12-hour system is used for the clock.

1 Press [DISP] (display).

**ADJUST** Clock display

2 Press and hold [DISP] (display) again for more than 2 seconds.

**FM1 12:00** Hours blink.

Hours:

3 Press [%] or [\$].

**FM1 10:00** Hours set.

4 Press [DISP] (display).

**FM1 10:00** Minutes blink.

Minutes:

5 Press [%] or [\$].

**FM1 10:10** Minutes set.

6 Press [DISP] (display).

**FM1 10:10** End.

### Note:

- Displays **ADJUST** before adjusting the clock.
- Press and hold [%] or [\$] to change numbers rapidly.

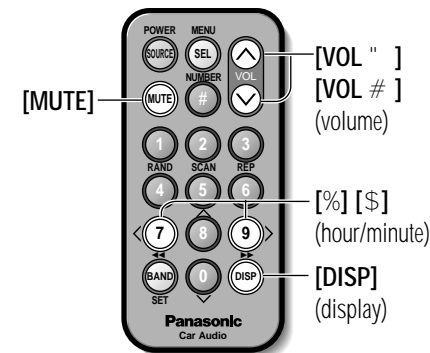

## Time Reset

- Press and hold [DISP] (display) for more than 2 seconds.
- Repeat steps 3 to 6.

## Display Change

Press [DISP] (display).

When the power is off:



Clock display

Display off

# Radio

## 1 Radio Mode

Press [SRC] (source) to change to the radio mode.

### Radio mode display

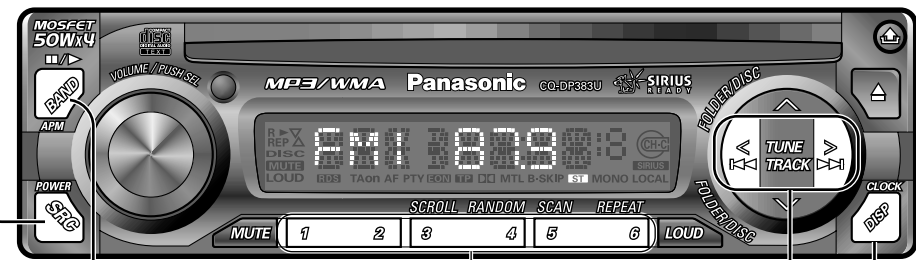
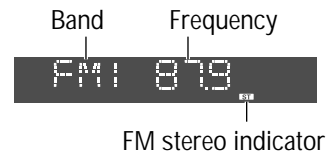

## 2 Band

Press [BAND].

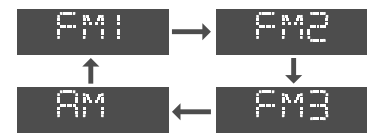

## 3 Tuning

[\$]: Up  
[%]: Down  
Press and hold [%] or [\$] for more than 0.5 seconds, then release.  
Seeking will start.

## Display Change

Press [DISP] (display).

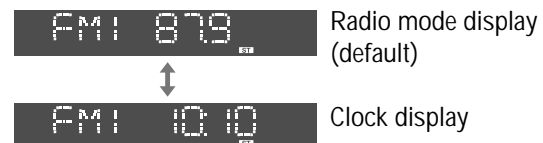

### Caution:

- To ensure safety, never attempt to preset stations while you are driving.

## Preset Station Setting

- Up to 6 stations each can be saved in the FM1, FM2, FM3 and AM preset station memories.

### Manual Preset Memory

Manually save a station in the preset memory.

- Select a band and frequency. (previous page)
- Press and hold [1] to [6] for more than 2 seconds to memorize.
  - The display blinks once, and a receiving station is saved in the memory.

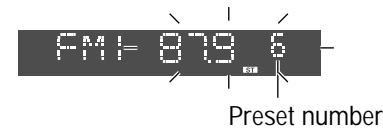

### Auto Preset Memory (APM)

Automatically save stations with good reception in the preset memory.

- Select a band. (previous page)
- Press and hold [APM] for more than 2 seconds.
  - The 6 stations with good reception will be automatically saved in the memory under preset number 1 to 6.
  - Once set, the preset stations are sequentially scanned for 5 seconds each. (scanning)
  - To stop the scanning, press [1] to [6].

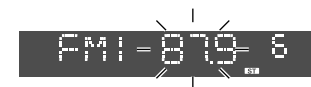

### Note:

- Existing saved stations are overwritten with new stations after this procedure above.

## Preset Station Calling

- Select a band. (previous page)
- Press [1] to [6].

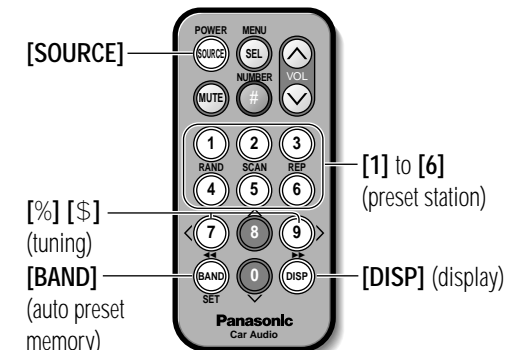

# CD Player

## Caution:

- Available discs:
    - Disc size: 5" (12 cm) CD only
    - CD-DA data recorded CD-R and CD-RW discs
    - MP3/WMA data recorded CD media (CD-ROM, CD-R, CD-RW)
  - 3" (8 cm) CD is not available for this unit, so do not insert it absolutely.
  - Before loading a disc, check to make sure that a disc is not already loaded.
  - Refer to page 41 about notes on CD-Rs/RWs.
  - Refer to page 27 about notes on MP3/WMA.
- Do not
    - use irregularly shaped discs.
    - use discs that have a seal or label attached.
    - pinch your finger or hand in the front panel.
    - insert foreign matter into the disc slot.
    - watch the scroll display while driving a car. (pages 25, 26)

## Listening to a CD

### 1 Insert the disc.

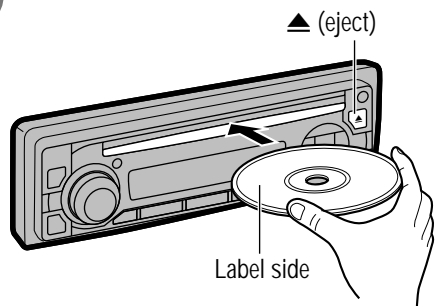

The display changes as shown below. Playback starts automatically.

#### Note:

- Do not insert a disc when "DISC" indicator lights.



#### ■ CD

- Do not insert a disc when "DISC" indicator lights.
- Lights when the disc is loaded.

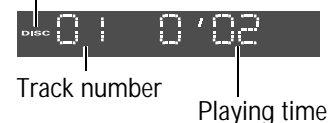

#### ■ MP3/WMA

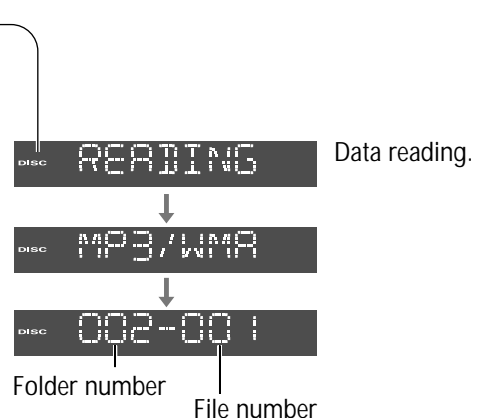

#### When CD is in the player

Press [SRC] (source) to change to CD player mode.

### 2 Stop and eject the disc.

Press [▲] (eject).

## Note:

- The power will be turned on automatically when a disc is loaded.
- The title can be displayed. (pages 25, 26)
- It may take some time to distinguish CD-DA and MP3/WMA before playback starts.
- If you record too many folders and files onto a disc, it may take some time before playback starts.

### Pause

Press [||/▶].  
Press [||/▶] again to cancel.



### Folder Selection

[\*]: Next folder.  
[#]: Previous folder.

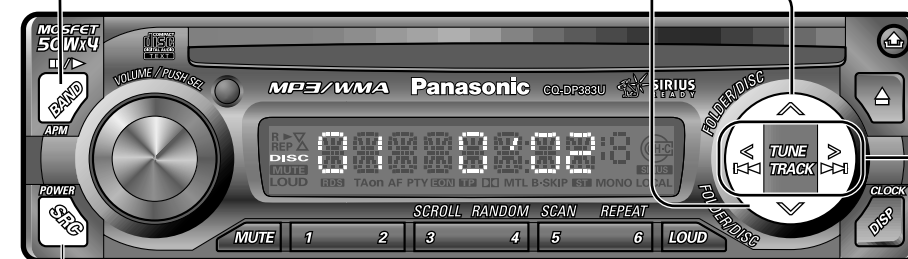

### Track (File) Selection

[▶▶]: Next track (file).  
[◀◀]: Beginning of the current track (file).  
For the previous track (file), press twice.

### Fast Forward/Fast Reverse

Press and hold.  
[▶▶] (▶▶): Fast forward.  
[◀◀] (◀◀): Fast reverse.  
Release to resume the regular play.

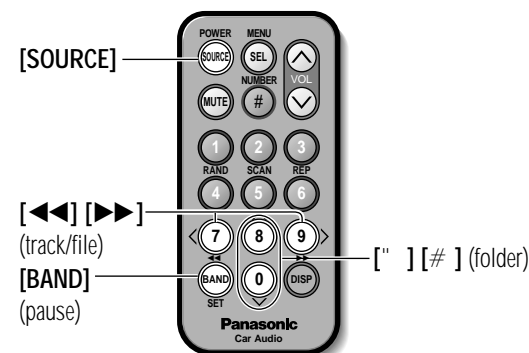



# CD Player (continued)

## Repeat Play

Press **[REPEAT]**.  
**REP** (repeat indicator) lights.



Press **[REPEAT]** again to cancel.

## Folder Repeat Play (MP3/WMA only)

Press and hold **[REPEAT]** for more than 2 seconds.  
**REP** (repeat indicator) blinks.  
 Repeat the current folder.



Press and hold **[REPEAT]** again for more than 2 seconds to cancel.

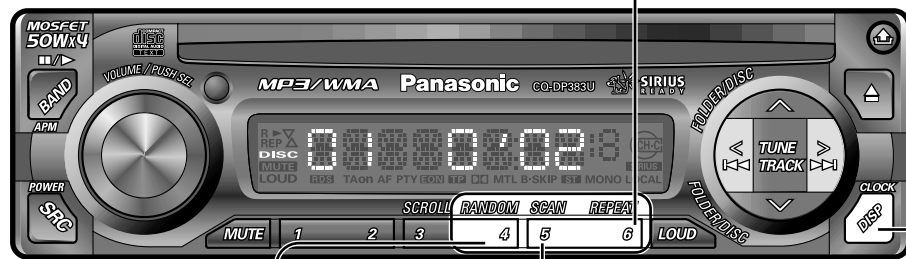

## Random Play

Press **[RANDOM]**.  
**R** (random indicator) lights.  
 All the available tracks (files on all folders) play in a random sequence.



Press **[RANDOM]** again to cancel.

## Scan Play

Press **[SCAN]**.  
 The first 10 seconds of each track (file on all folder) plays in sequence.



Press **[SCAN]** again to cancel.

## Folder Random Play (MP3/WMA only)

Press and hold **[RANDOM]** for more than 2 seconds.  
**R** (random indicator) blinks.  
 All the files on the current folder play in a random sequence.



Press and hold **[RANDOM]** again for more than 2 seconds to cancel.

## Folder Scan Play (MP3/WMA only)

Press and hold **[SCAN]** for more than 2 seconds.  
 From the next folder, the first 10 seconds of the first file on each folder plays in sequence.



Press and hold **[SCAN]** again for more than 2 seconds to cancel.

## Display Change

Press **[DISP]** (display).

### ■ CD

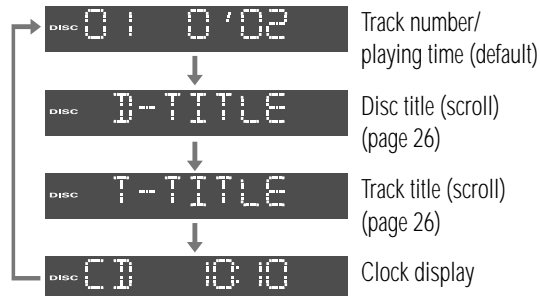

### Note:

**DISC NO TITLE** Displays when there is no title.

- The display shows title when a disc with CD text data is loaded. (Up to 128 letters can be displayed when scrolling. Some letters are not serviceable.)
- Characters that the player cannot display are shown as an asterisk.

### ■ MP3/WMA

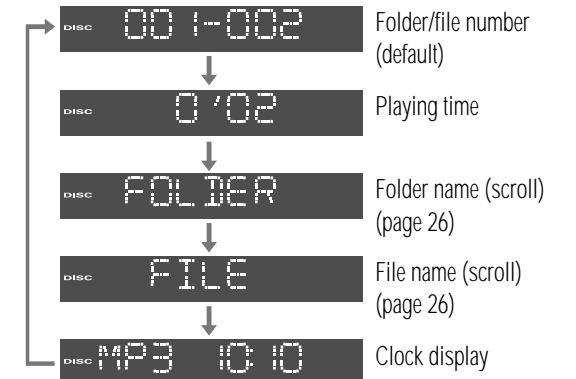

(Example: MP3)

### Note:

**DISC NO NAME** Displays when there is no album/title/artist name.

- The bit rate value changes when variable bit rate (VBR) data is played.
- When playing a Tree 1 file, the folder name is displayed with the word "ROOT" (root folder).
- Folder and file names can be displayed. Displayable character number varies with file systems.
- Characters that the player cannot display are shown as an asterisk.



- [4] (random play)
- [5] (scan play)
- [6] (repeat play)
- [DISP] (display)

# CD Player (continued)

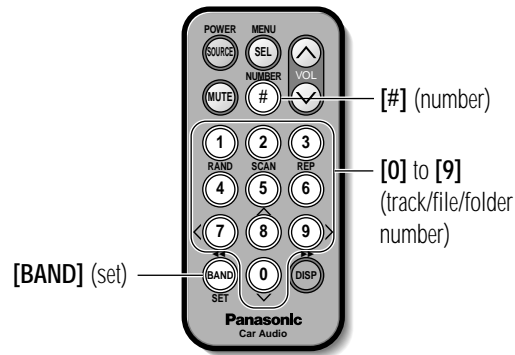

## Direct Track (File) Selection

Example: track (file) number 10

- 1 Press [#].
  - 2 Press [1] [0].
  - 3 Press [BAND].
- CD
- DISC TRACK \_ \_
- ↓
- DISC TRACK 10
- MP3/WMA
- DISC FILE \_ \_ \_
- ↓
- DISC FILE \_ 10

## Direct Folder Selection

Example: folder number 10

- 1 Press [#] twice.
  - 2 Press [1] [0].
  - 3 Press [BAND].
- DISC FLDR \_ \_ \_
- ↓
- DISC FLDR \_ 10

**Note:**

- Press [DISP] (display) to return to the regular mode.
- Operation returns to the start of the disc when a folder with no MP3 or WMA format files is selected.

## Text Scroll

Press [SCROLL].

When the display is set to show disc/track title (folder/file name/ID3/WMA tag) (page 25), this scrolls the text.

## ID3/WMA Tag Setting

Press and hold [SCROLL] for more than 2 seconds.



**When a folder name is displayed:**  
TAG ON: The album title is displayed.  
TAG OFF: The folder name is displayed.

**When a file name is displayed:**  
TAG ON: The title/artist name is displayed  
TAG OFF: The file name is displayed.

## Notes on MP3/WMA

### What is MP3/WMA?

MP3 (MPEG audio layer 3) and WMA (Windows Media™ Audio) are the compression formats of digital audio. The former is developed by MPEG (Motion Picture Experts Group), and the latter is developed by Microsoft Corporation. Using these compression formats, you can record the contents of about 10 music CDs on a single CD media. (This figures refer to data recorded on a 650 MB CD-R or CD-RW at a fixed bit rate of 128 kbps and a sampling frequency of 44.1 kHz.)

**Note:**

- MP3/WMA encoding and writing software are not supplied with this unit.
- CD writing software is not supplied with this unit.

### Points to remember when making MP3/WMA files

**Common**

- High bit rate and high sampling frequency are recommended for high quality sounds.
- Selecting VBR (Variable Bit Rate) is not recommended because playing time is not displayed properly and sound may be skipped.
- The playback sound quality differs depending on the encoding circumstances. For details, refer to the user manual of your own encoding software and writing software.

**MP3**

- It is recommended to set the bit rate to "128 kbps or more" and "fixed".

**WMA**

- It is recommended to set the bit rate to "64 kbps or more" and "fixed".
- Do not set the copy protect attribute on the WMA file to enable this unit to playback.

**Caution:**

- Never assign the ".mp3", or ".wma" file name extension to a file that is not in the MP3/WMA format. This may not only produce noise from the speaker damage, but also damage your hearing.

### Display Information

#### Displayed items

CD-TEXT	MP3/WMA	MP3 (ID3 tag)	WMA (WMA tag)
• Disc title	• Folder name	• Album title	• Album title
• Track title	• File name	• Artist name	• Artist name
		• Title name	• Title name

#### Displayable characters

- Displayable length of file name/folder name: within 128 characters
- Name files and folders in accordance with the standard of each file system. Refer to the instructions of writing software for details.
- ASCII character set and special characters in each language can be displayed.

#### ASCII character set

A to Z, a to z, digits 0 to 9, and the following symbols:  
(space) ! " # \$ % & ' ( ) \* + , - . / : ; < = > ? @ [ \ ] ^ \_ ` { | } ~

#### Special characters

À Á Â Ã Ä Å à á â ã ä å  
Ò Ó Ô Õ Ö ò ó ô õ ö ø  
Ù Ú Û Ü ú û ü

**Note:**

- With some software in which MP3/WMA format files have been encoded, the character information may not be displayed properly.
- Undisplayable characters and symbols will be converted into an asterisk.

# CD Player (continued)

## Notes on MP3/WMA (continued)

### Recording MP3/WMA files on a CD-media

- You are recommended to minimize the chances of making a disc that contains both CD-DA files and MP3/WMA files.
- If CD-DA files are on the same disc as MP3 or WMA files, the songs may not play in the intended order, or some songs may not play at all.
- When storing MP3 data and WMA data on the same disc, use different folders for each data.
- Do not record files other than MP3/WMA files and unnecessary folder on a disc.
- The name of MP3/WMA file should be added by rules as shown in the following descriptions and also comply with the rules of each file system.
- You may encounter trouble in playing MP3/WMA files or displaying the information of MP3/WMA files recorded with certain writing software or CD recorders.
- The file extension ".mp3" or ".wma" should be assigned to each file depending on the file format.
- This unit does not have the play list function.
- Although Multi-session recording is supported, the use of Disc-at-Once is recommended.

#### Supported file systems

ISO 9660 Level 1/Level 2, Apple Extension to ISO 9660, Joliet, Romeo

#### Note:

- Apple HFS, UDF 1.50, Mix CD (CD Extra) is not supported.

Compression formats (Recommend: "Points to remember when making MP3/WMA files" on the previous page)

Compression method	Bit rate	VBR	Sampling frequency
MPEG 1 audio layer 3 (MP3)	32 k–320 kbps	Yes	32, 44.1, 48 kHz
MPEG 2 audio layer 3 (MP3)	8 k–160 kbps	Yes	16, 22.05, 24 kHz
Windows Medio Audio Ver. 2, Ver. 8	64 k–192 kbps	No	32, 44.1, 48 kHz

### Folder selection order/file playback order (example)

#### Note:

- This unit counts the number of folders irrespective of the presence or absence of MP3/WMA file.
- If the selected folder does not contain any MP3/WMA files, the nearest MP3/WMA files in the order of playback will be played.
- Playback order may be different from other MP3/WMA players even if the same disc is used.
- "ROOT" appears when displaying the root folder name.

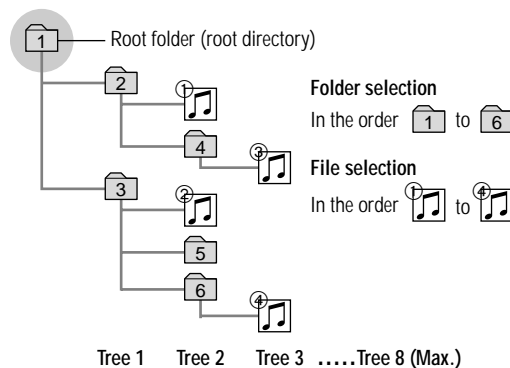

#### Maximum number of files/folders:

- Maximum number of files/folders: 999 (files+ folders)
- Maximum number of files in one folder: 255
- Maximum depth of trees: 8
- Maximum number of folders: 255 (Root folder is included.)

Windows Media, and the Windows logo are trademarks, or registered trademarks of Microsoft Corporation in the United States and/or other countries.



#### Copyright

It is prohibited by copyright laws to copy, distribute and deliver copyrighted materials such as music without the approval of copyright holder except enjoying yourself personally.

#### No warranty

Above description complies with our investigations as of December 2002. It has no warranty for reproducibility and displayability of MP3/WMA.

# CD Changer Control

CD changer functions are designed for optional Panasonic CD changer unit.

#### Preparation:

- Connect the CD changer, and load a magazine (CDs).

#### Note:

- The power will be turned on automatically when a magazine is loaded.

The following functions are not supported during playback through a CD changer.

- CD-ROM, CD-RW playback
- CD text display
- MP3/WMA playback
- Pause
- In principle, CD-R disc play is supported but it does not follow that it will be possible to play all such discs properly.

## 1 CD Changer Mode

(When a CD changer is connected and a magazine is in the changer.)

Press [SRC] (source) to change to CD changer mode. Playback starts automatically.

#### Note:

- NO DISC: Load a magazine with CDs.
- CD EJECT: Magazine is ejected in the CD changer mode.

#### CD changer mode display

Lights when the changer is connected.

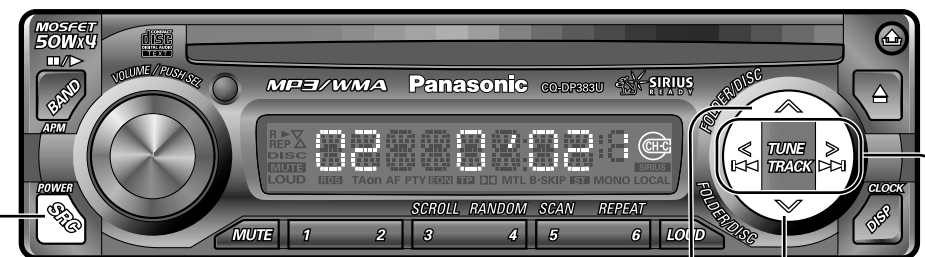
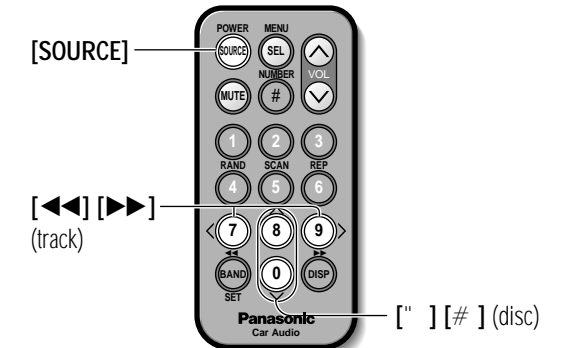
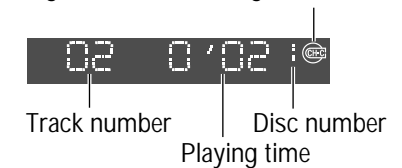

## 2 Disc Selection

["] : Next disc.  
[#] : Previous disc.

## 3 Track Selection

[>>>]: Next track.  
[<<<]: Beginning of the current track.  
For the previous track, press twice.

## Fast Forward/Fast Reverse

Press and hold.  
[>>>] (>>>): Fast forward.  
[<<<] (<<<): Fast reverse.  
Release to resume the regular play.

# CD Changer Control (continued)

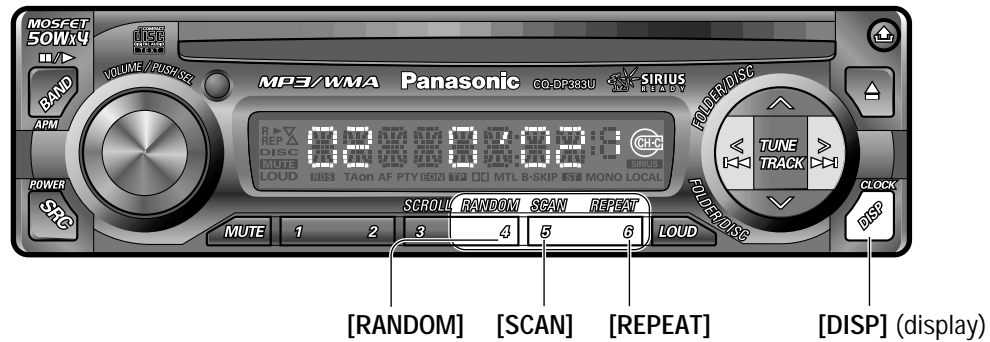

## Repeat Play

Press **[REPEAT]**.  
**[REP]** (repeat indicator) lights.  
 Repeat the current track.



Press **[REPEAT]** again to cancel.

## Disc Repeat Play

Press and hold **[REPEAT]** for more than 2 seconds.  
**[REP]** (repeat indicator) blinks.  
 Repeat the current disc.



Press and hold **[REPEAT]** again for more than 2 seconds to cancel.

## Random Play

Press **[RANDOM]**.  
**[R]** (random indicator) lights.  
 All the available tracks on all discs in the magazine play in a random sequence.



Press **[RANDOM]** again to cancel.

## Disc Random Play

Press and hold **[RANDOM]** for more than 2 seconds.  
**[R]** (random indicator) blinks.  
 All the available tracks on the current disc play in a random sequence.



Press and hold **[RANDOM]** again for more than 2 seconds to cancel.

## Scan Play

Press **[SCAN]**.  
 The first 10 seconds of each track on all discs plays in sequence.



Press **[SCAN]** again to cancel.

## Disc Scan Play

Press and hold **[SCAN]** for more than 2 seconds.  
 From the next disc, the first 10 seconds of the first track of all the discs plays in sequence.



Press and hold **[SCAN]** for more than 2 seconds again to cancel.

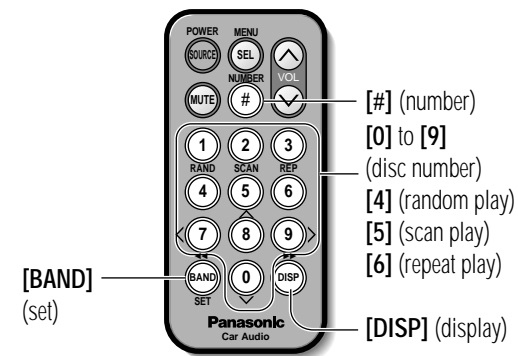

## Display Change

Press **[DISP]** (display).



## Direct Disc Selection

Example: disc number 10

- 1 Press **[#]**.
- 2 Press **[1] [0]**.
- 3 Press **[BAND]**.

Note:

- Press **[DISP]** (display) to return to the regular mode.

# Audio Settings

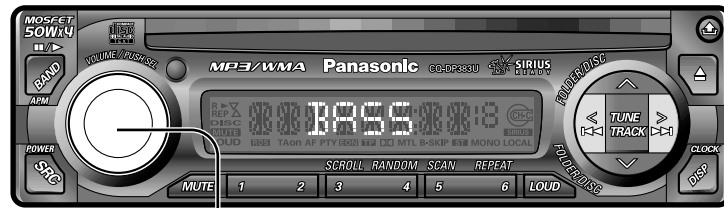

1 Press [SEL].

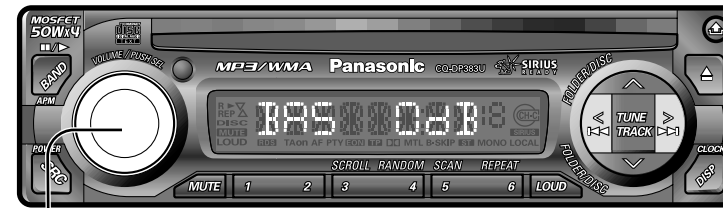
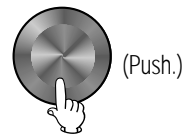

2 Turn [VOL].  
(Press [VOL " ] or [VOL # ] on the remote control unit.)

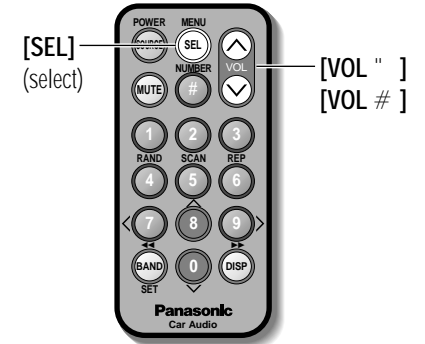
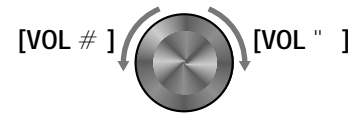

## Volume

Default: 18  
Setting range: 0 to 40

## Bass and Treble

You can adjust the bass and treble sound.

Default: BAS (bass) 0 dB  
TRE (treble) 0 dB  
Setting range: -12 dB to +12 dB (by 2 dB)

## Balance and Fader

You can adjust the sound balance among the front, rear, right and left speakers.

Default: BAL (balance) CNT (center)  
FAD (fader) CNT (center)  
Setting range: 15 levels each

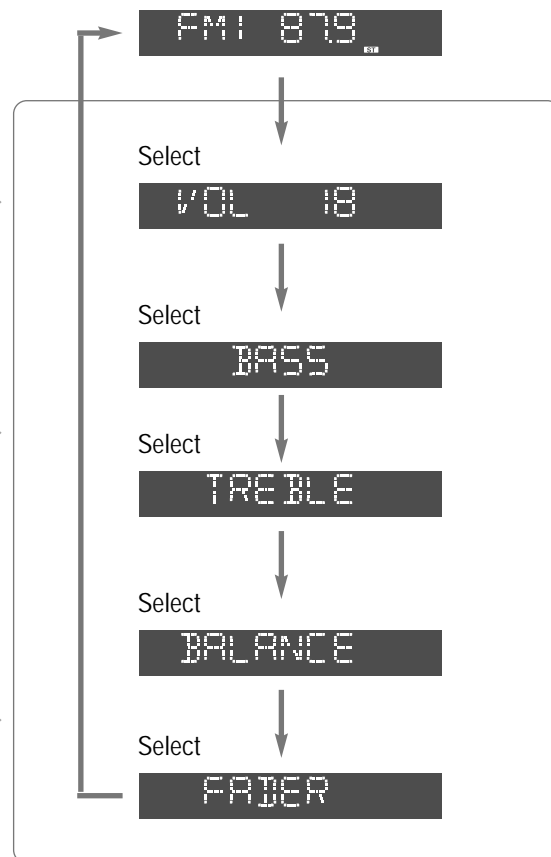

VOL 18	[VOL " ]: Increases the volume. [VOL # ]: Decreases the volume.
BAS 0dB	[VOL " ]: Increases the bass. [VOL # ]: Decreases the bass.
TRE 0dB	[VOL " ]: Increases the treble. [VOL # ]: Decreases the treble.
BAL CNT	[VOL " ]: Right enhanced. [VOL # ]: Left enhanced.
FAD CNT	[VOL " ]: Front enhanced. [VOL # ]: Rear enhanced.

### Note:

- Press [DISP] (display) to return to the regular mode.
- If no operation takes place for more than 2 seconds in volume setting, the display returns to the regular mode.
- If no operation takes place for more than 7 seconds in audio setting except volume setting, the display returns to the regular mode.
- The volume can also be adjusted directly using [VOL] on the main unit.

# Troubleshooting

## Preliminary Steps

Check and take steps as described in the tables below.

## If You Suspect Something Wrong

Immediately switch the power off. Disconnect the power connector and check that there is neither smoke nor heat from the unit before asking for repairs. Never try to repair the unit yourself because it is dangerous to do so.

### Caution:

- Do not use the unit if it malfunctions or is something wrong.
- Do not use the unit in abnormal condition, for example, without sound, or with smoke or foul smell, which can cause ignition or electric shock. Immediately stop using it and call the store where you purchased it.

## Troubleshooting Tips

### Common

Trouble	Cause/Step
No power.	Car's engine switch is not on. → Turn your car's ignition switch to ACC or ON.
	Cables are not correctly connected. → Connect cables correctly. → Connect the battery cable to the terminal that is always active. → Connect the accessory cable to your car's ACC source. → Connect the grounding wire to a metal part of the car.
	Fuse is burnt out. → Call the store where you purchased the unit, or your nearest Servicenter (see the attached sheet) and ask for fuse replacement.
No sound.	Mute is set to ON. → Set it to OFF.
	Cables are not correctly connected. → Connect cables correctly.
	Condensation (dew). → Wait for a while before use.
Noise.	A mobile phone is used near the unit. → Keep the mobile phone away from the unit.
	The unit's grounding wire is not connected securely. → Check the metal areas of the car body (chassis), and connect the grounding wire more securely.
Audio sound is output but the display shows demonstration message.	Demonstration mode is ON. → Press [DISP] (display) to cancel demonstration mode.

## Radio

Trouble	Cause/Step
Too much noise in FM stereo and monaural (AM) broadcasts.	Station is too far, or signals are too weak. → Select other stations of higher signal level.
	The motor antenna relay control lead is not connected correctly. → If there is a motor antenna in the car, connect the antenna control lead to the motor antenna lead that is installed in the car correctly.
	The ground connection of the radio antenna is not secure enough. → Check the ground connection of the mounted base part of the antenna, and tighten up the screw.
Preset station is reset.	The radio antenna is not extended enough. → Extend fully the radio antenna.
	Battery cable is not correctly connected. → Connect the battery cable to the terminal that is always active.

## CD/MP3/WMA

Trouble	Cause/Step
Disc is in the CD compartment but no sound is made, or disc is ejected automatically.	Disc is upside down. → Place disc in the correct direction with the label side up.
	• Disc is dirty. • Disc has scratches. → Clean disc, referring to the section on "Notes on CD/CD Media (CD-ROM, CD-R, CD-RW)". (page 41)
	A disc that has data other than CD-DA or MP3/WMA type is played. → Discs that have CD-DA or MP3/WMA type data should be used.
	→ The unit may not successfully play back a CD-R/RW that is made in combination of writing software, a CD recorder (CD-R/RW drive) and a disc which are incompatible one another. Refer to instructions for the concerned devices for details.

## CD/MP3/WMA (continued)

Trouble	Cause/Step
Sound skips, bad sound quality. (e.g. caused by noise)	<ul style="list-style-type: none"> <li>• Disc is dirty.</li> <li>• Disc has scratches.</li> </ul> →Clean disc, referring to the section on “Notes on CD/CD Media (CD-ROM, CD-R, CD-RW)”. (page 41)
Sound skips due to vibration.	Mounting angle is over 30°. →Adjust mounting angle to less than 30°. Instable mounting. →Mount the unit securely with the mounting parts, referring to the section on installation.
Disc is not ejected.	<ul style="list-style-type: none"> <li>• Disc is defective.</li> <li>• Mechanical trouble.</li> </ul> →Press [▲] (eject). If normal operation is not restored, call the store where you purchased the unit or the nearest Servicenter to ask for repairs.
CD text is not displayed normally.	<ul style="list-style-type: none"> <li>• Disc is dirty.</li> <li>• Disc has scratches.</li> </ul> →Clean disc, referring to the section on “Notes on CD/CD Media (CD-ROM, CD-R, CD-RW)”. (page 41)
Time is counted but no sound comes out.	An attempt has been made to play a mixed disc. →In the case of mixed discs, MP3 files may be played with their sound muted.

## MP3/WMA

Trouble	Cause/Step
No playback.	The disc does not conform to any of the file systems supported by this player. →Insert a disc that conforms to the file systems (ISO 9660 Level 1, Level 2, Joliet, Romeo or Apple Extension to ISO 9660). The MP3 file is missing the “.mp3” file name extension. →Make sure to add the “.mp3” extension to each MP3 file name. The WMA file is missing the “.wma” file name extension. →Make sure to add the “.wma” extension to each WMA file name.
It takes too long for playback to start.	The folders and files recorded on the disc are layered too much. →As checking of files takes longer in this case, do not record any unnecessary folders or files other than MP3/WMA on the disc.
Poor recording quality, sound skipping.	→The recording quality differs depending on the encoding software used, and on settings such as the bit rate. Set the bit rate within the range specified in the specifications chart (page 51). <ul style="list-style-type: none"> <li>■ MP3                It is recommended to set the bit rate to “128 kbps or more” and “Fixed”.             </li> <li>■ WMA                It is recommended to set the bit rate to “64 kbps or more” and “Fixed”.             </li> </ul>
Files are not played in the desired order.	High-speed writing was executed when MP3/WMA data was recorded on the disc. →Decrease writing speed as low as possible. Files or folders are not recorded in the desired playback order. →Some writing software lets you specify the recording order by adding a prefix in the range of “01”–“99”, etc. to the file name. For details refer to the user manual of your writing software.
Folder/file name is not displayed correctly.	The disc does not conform to any of the file systems supported by this player. →Insert a disc that conforms to the file systems (ISO 9660 Level 1, Level 2, Joliet, Romeo or Apple Extension to ISO 9660). →There may be a problem with your writing software or CD recorder (CD-R/RW drive). For details refer to the user manual of your writing software.

# Troubleshooting (continued)

## MP3/WMA (continued)

Trouble	Cause/Step
File playing time is not displayed correctly.	You ran the file in fast forward or fast reverse during playback or turned off the ignition switch of the car during playback. →Playing another file will return the file playing time to normal.
	You played a VBR (Variable Bit Rate) format file. →The file playing time of VBR (Variable Bit Rate) format file is sometimes displayed incorrectly.

## Sound Setting





Trouble	Cause/Step
No sound from left, right, front or rear speaker.	Left and right balance, or front and rear balance is off on one side. →Adjust balance/fader setting as appropriate.
Left and right sounds are reversed in stereo listening.	Cables are not correctly connected. →Connect the cables correctly.
	The speaker leads are reversed between right and left. →Connect the speaker wires to the correct ones.

## Remote Control Unit

Trouble	Cause/Step
Buttons are invalid for operation.	Battery polarities are reversed. →Insert the battery correctly.
	Wrong the battery. →Check the battery.
	The battery has run down. →Replace the battery.
	Remote control unit is in the wrong direction. →Direct the remote control unit at sensor on the front panel.

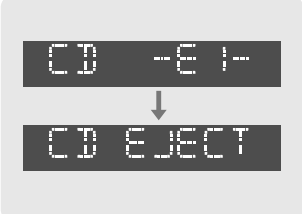
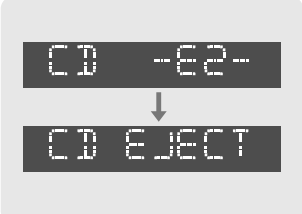
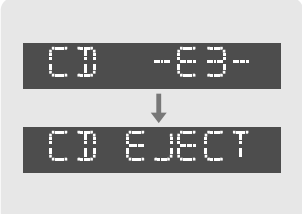
## Error Display Messages

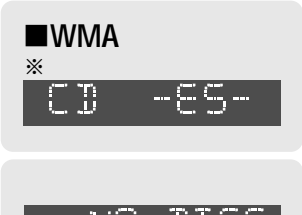
### CD/MP3/WMA

Display	Cause/Step
	<ul style="list-style-type: none"> <li>Disc is dirty, or is upside down.</li> <li>→The disc is ejected automatically. Check the disc.</li> </ul>
	<p>Disc has scratches.</p> <ul style="list-style-type: none"> <li>→The disc is ejected automatically. Check the disc.</li> </ul>
	<p>No operation by some cause.</p> <ul style="list-style-type: none"> <li>→The disc is ejected automatically. If normal operation is not restored, call the store where you purchased the unit or the nearest Servicenter to ask for repairs.</li> </ul>
<p>■MP3/WMA</p> <p>※</p> 	<p>The player for some reason cannot read the file you are trying to play. (File recorded in an unsupported file system, compression scheme, data format, file name extension, damaged data, etc.)</p> <ul style="list-style-type: none"> <li>→Select a file that the player can read. Confirm the type of data recorded on the disc. Create a new disc if necessary.</li> </ul>
<p>■WMA</p> <p>※</p> 	<p>An attempt has been made to play a copy-protected WMA file.</p> <ul style="list-style-type: none"> <li>→Play WMA files which are not copy-protected.</li> </ul>
	<p>No disc is in the player.</p> <ul style="list-style-type: none"> <li>→Insert a disc in the player.</li> </ul>

※ If all the files cannot be played, E4 or E5 remains on the display.



# Troubleshooting (continued)

## CD Changer

Display	Cause/Step
	<ul style="list-style-type: none"> <li>• Disc is dirty, or is upside down.</li> <li>• A disc other than a music CD (CD-DA type) is loaded.</li> </ul> <p>→Check the disc. (The changer automatically switches to the next disc.)</p>
	<p>Disc has scratches.</p> <p>→Check the disc. (The changer automatically switches to the next disc.)</p>
	<p>No operation by some cause.</p> <p>→If normal operation is not restored, call the store where you purchased the unit or the nearest Servicer to ask for repairs. The display continues if you cannot switch off the power.</p>
	<p>The changer has become disconnected from the main unit in the changer mode.</p> <p>→Verify that correct connections have been made.</p>
	<p>No disc is in the changer (magazine).</p> <p>→Insert discs into the changer (magazine).</p>

**Note:**

- For details, refer to operating instructions for the changer used.

## Maintenance

Your product is designed and manufactured to ensure a minimum of maintenance. Use a dry, a soft cloth for routine exterior cleaning. Never use benzene, thinner or other solvents.

## Product Servicing

If the suggestions in the charts do not solve the problem, we recommend that you take it to your nearest authorized Panasonic Servicer. The product should be serviced only by a qualified technician.

## Replacing the Fuse

Use fuses of the same specified rating (15 A). Using different substitutes or fuses with higher ratings, or connecting the unit directly without a fuse, could cause fire or damage to the unit. **If the replacement fuse fails, contact your nearest Panasonic Servicer for service.**

# Maintenance

## Notes on CD-Rs/RWs

- You may have trouble playing back some CD-R/RW discs recorded on CD recorders (CD-R/RW drives), either due to their recording characteristics or dirt, fingerprints, scratches, etc. on the disc surface.
- CD-R/RW discs are less resistant to high temperatures and high humidity than ordinary music CDs. Leaving them inside a car for extended periods may damage them and make playback impossible.
- The unit may not successfully play back a CD-R/RW that was made by the combination of writing software, a CD recorder (CD-R/RW drive) and a disc if they are incompatible one another.
- This player cannot play the CD-R/RW discs if the session is not closed.
- This player cannot play the CD-R/RW discs which contains other than CD-DA or MP3/WMA data.
- Be sure to observe the instructions of CD-R/RW disc for handling it.

## Notes on CD/CD Media (CD-ROM, CD-R, CD-RW)

If you use commercial CDs, they must have either of these labels below.



### How to hold the disc

- Do not touch the underside of the disc.
- Do not scratch the discs.
- Do not bend the disc.
- When not in use, keep the disc in the case.

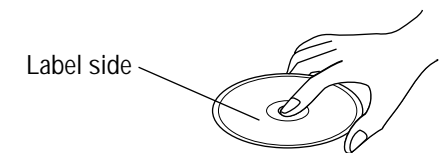

Do not use irregularly shaped discs.

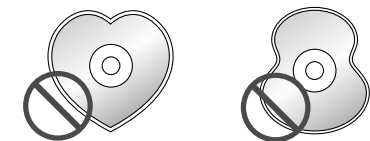

Do not leave discs on the following places:

- Direct sunlight
- Near car heaters
- Dirty, dusty and damp areas
- Seats and dashboards

### Disc cleaning

Use a dry, soft cloth to wipe from the center outward.

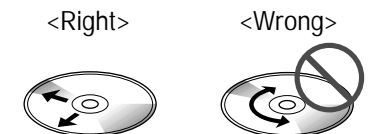

Do not attach any seals or labels to your discs.

Do not write on the disc label in a heavy pen or ballpoint pen stroke.

# Installation Guide



This installation information is designed for experienced installers and is not intended for non-technical individuals. It does not contain warnings or cautions of potential dangers involved in attempting to install this product. Any attempt to install this product in a motor car by anyone other than qualified installer could cause damage to the electrical system and could result in serious personal injury or death.

## Installation Hardware

No.	Item	Diagram	Q'ty
①	Mounting collar		1
②	Hex. nut (5 mmφ)		1
③	Rear support strap		1
④	Tapping screw (5 mmφ × 16 mm)		1
⑤	Mounting bolt (5 mmφ)		1
⑥	Power connector		1
⑦	Removable face plate case		1
⑧	Trim plate		1
⑨	Lock cancel plate		2

## Overview

This product should be installed by a professional. However, if you plan to install this product yourself, your first step is to decide where to install it. The instructions in these pages will guide you through the remaining steps:

(Please refer to the "WARNING" statement above.)

- Identify and label the car wires.
- Connect the car wires to the wires of the power connector.

- Install the unit in the dashboard.
  - Check the operation of the unit.
- If you encounter problems, please consult your nearest professional installer.

### Caution:

- This unit operates with a 12 V DC negative ground auto battery system only. Do not attempt to use it in any other system. Doing so could cause serious damage.

Before you begin installation, look for the items which are packed with your unit.

- **Warranty Card.** ...Fill this out promptly.
- **Panasonic Servicenter List for Service Directory** ...Keep for future reference in case the product needs servicing.
- **Installation Hardware**...Needed for in-dash installation.

## Required Tools

You'll need a screwdriver, a 1.5 V AA battery, and the following:

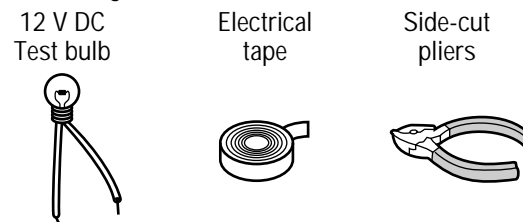

## Dashboard Specifications

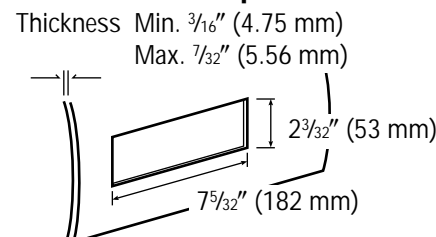

## Identify All Leads

The first step in installation is to identify all the car wires you'll use when hooking up your sound system.

As you identify each wire, we suggest that you label it using masking tape and a permanent marker. This will help avoid confusion when making connections later.

### Note:

- Do not connect the power connector to the stereo unit until you have made all connections. If there are no plastic caps on the stereo hooking wires, insulate all exposed leads with electrical tape until you are ready to use them. Identify the leads in the following order.

### Power Lead

If your car has a radio or is pre-wired for one: Cut the connector wires one at a time from the plug (leaving the leads as long as possible) so that you can work with individual leads.

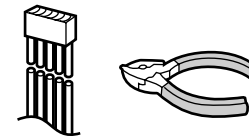

Turn the ignition on to the accessory position, and ground one lead of the test bulb to the chassis.

Touch the other lead of the test bulb to each of the exposed wires from the cut radio connector plug. Touch one wire at a time until you find the outlet that causes the test bulb to light.

Now turn the ignition off and then on. If the bulb also turns off and on, that outlet is the car power lead.

If your car is not wired for an audio unit:

Go to the fuse block and find the fuse port for radio (RADIO), accessory (ACC), or ignition (IGN).

### Battery Lead

If your stereo unit has a yellow lead, you will need to locate the car's battery lead. Otherwise you may ignore this procedure. (The yellow battery lead provides continuous power to maintain a clock, memory storage, or other function.)

If your car has a radio or is pre-wired for one: With the ignition and headlights off, identify the car battery lead by grounding one lead of the test bulb to the chassis and checking the remaining exposed wires from the cut radio connector plug.

If your car is not wired for an audio unit:

Go to the fuse block and find the fuse port for the battery, usually marked BAT.

### Speakers

Identify the car speaker leads. There are two leads for each speaker which are usually color coded.

A handy way to identify the speaker leads and the speaker they are connected with is to test the leads using a 1.5 V AA battery as follows.

Hold one lead against one pole of the battery and stroke the other lead across the other pole. You will hear a scraping sound in one of the speakers if you are holding a speaker lead.

If not, keep testing different lead combinations until you have located all the speaker leads. When you label them, include the speaker location for each.

### Antenna Motor

If your car is equipped with an automatic power antenna, identify the car motor antenna lead by connecting one bulb tester lead to the car battery lead and touching the remaining exposed wires from the cut radio connector plug one at a time. You will hear the antenna motor activate when you touch the correct wire.

### Antenna

The antenna lead is a thick, black wire with a metal plug at the end.

## Connect All Leads

Now that you have identified all the wires in the car, you are ready to begin connecting them to the stereo unit wires. The wiring diagram (page 48) shows the proper connections and color coding of the leads.

We strongly recommend that you test the unit before making a final installation.

You can set the unit on the floor and make temporary connections to test the unit. Use electrical tape to cover all exposed wires.

### Important:

- Connect the red power lead last, after you have made and insulated all other connections.

### Ground

Connect the black ground lead of the power connector to the metal car chassis.

# Installation Guide (continued)

## Speakers

Connect the speaker wires. See the wiring diagram (page 48) for the proper hookups. Follow the diagram carefully to avoid damaging the speakers and the stereo unit.

The speakers used must be able to handle more than 50 W of audio power. If using an optional audio amplifier, the speakers should be able to handle the maximum amplifier output power. Speakers with low input ratings can be damaged. Speaker impedance should measure 4–8 Ω, which is typically marked on most speakers. Lower or higher impedance speakers will affect output and can cause both speaker and stereo unit damage.

## Motor Antenna

Connect the car motor antenna lead to the dark blue motor antenna relay control lead. (Do not confuse the antenna lead with blue/white stripe lead for a power amplifier.)

## Battery

Connect the yellow battery lead to the correct radio wire or to the battery fuse port on the fuse block.

## Antenna

Connect the antenna by plugging the antenna lead into the antenna receptacle.

## Equipment

Connect any optional equipment such as an amplifier, according to the instructions furnished with the equipment. Leave about 12" (30 cm) of distance between the speaker leads/amplifier unit and the antenna/antenna extension cord. Read the operating and installation instructions of any equipment you will connect to this unit.

## Power

Connect the red power lead to the correct car radio wire or to the appropriate fuse port on the fuse block.

If the stereo unit functions properly with all these connections made, disconnect the wires and proceed to the final installation.

## Final Installation

### Lead Connections

Connect all wires, making sure that each connection is insulated and secure. Bundle all loose wires and fasten them with tape so they will not fall down later. Now insert the stereo unit into the mounting collar.

Congratulations! After making a few final checks, you're ready to enjoy your new auto stereo system.

## Final Checks

1. Make sure that all wires are properly connected and insulated.
2. Make sure that the stereo unit is securely held in the mounting collar.
3. Turn on the ignition to check the unit for proper operation.

If you have difficulties, consult your nearest authorized professional installer for assistance.

## Preparation

- We strongly recommend that you wear gloves for installation work to protect yourself from injuries.
- When bending the mounting tabs of the mounting collar with a screwdriver, be careful not to injure your hands and fingers.

- Disconnect the cable from the negative ⊖ battery terminal (see caution below).
- Unit should be installed in a horizontal position with the front end up at a convenient angle, but not more than 30°.

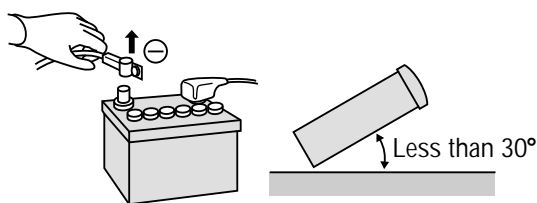

### Caution:

- Do not disconnect the battery terminals of a car with a trip or navigational computer since all user settings stored in memory will be lost. Instead take extra care with installing the unit to prevent shorts.

## Dashboard Installation

### Installation Opening

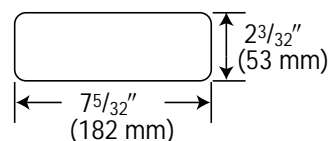

This unit can be installed in any dashboard having an opening as shown above. The dashboard should be 3/16" (4.75 mm)–7/32" (5.56 mm) thick in order to be able to support the unit.

## Installation Procedures

First complete the electrical connections, and then check them for correctness. (page 48)

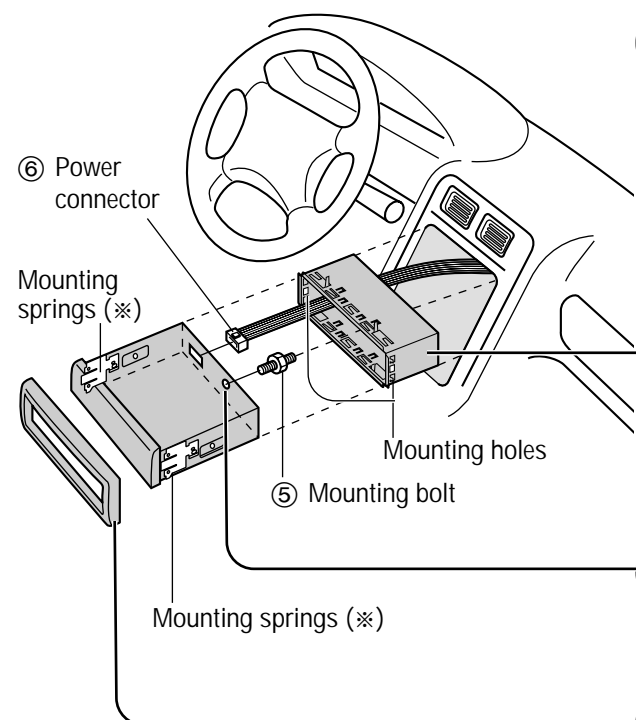

The included mounting collar ① is designed specifically for this unit. Do not use it to attach any other model.

- 1 Insert mounting collar ① into the dashboard, and bend the mounting tabs out with a screwdriver.

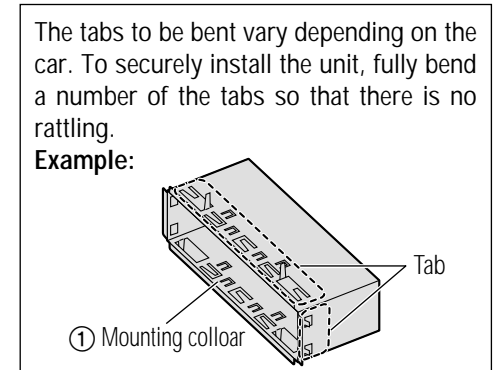

- 2 Secure the rear of the unit. After fixing mounting bolt ⑤ and power connector ⑥, fix the rear of the unit to the car body by either method (a) or (b) shown below.

- 3 Insert trim plate ⑧.

- 4 After installation, reconnect the negative ⊖ battery terminal.

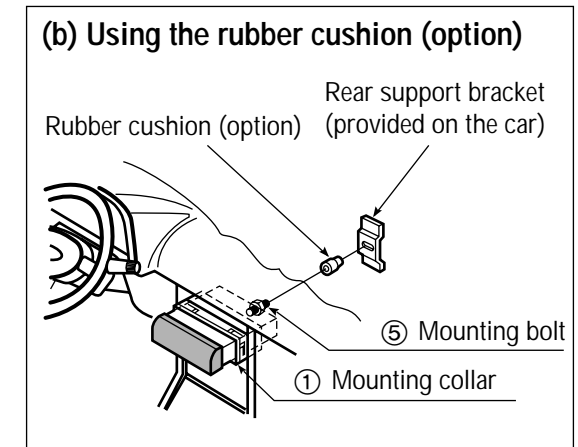
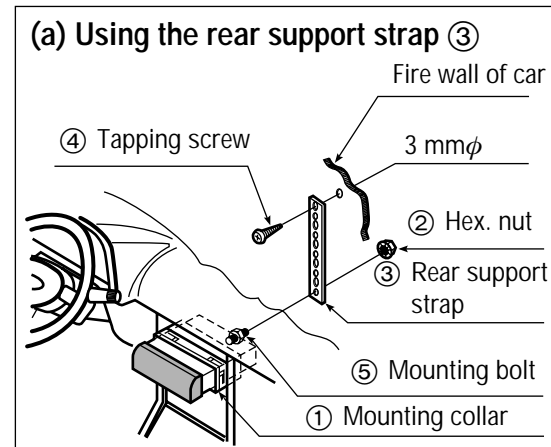
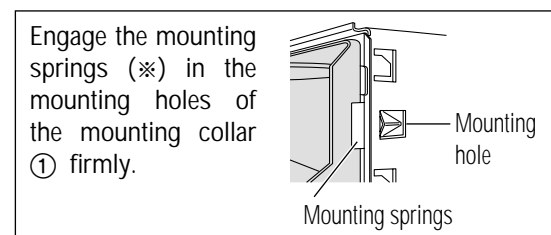

## Remove the Unit

Switch off the power of the unit.

- 1 Remove the removable face plate.
  - 1 Press [ ] (release button). The removable face plate will be opened.

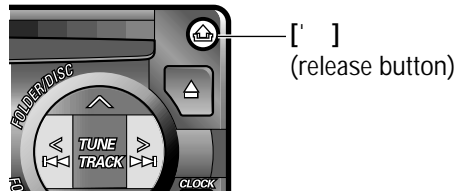

- 2 Pull on the right side of the unit.

- 2 Remove the trim plate ⑧ with a screwdriver.

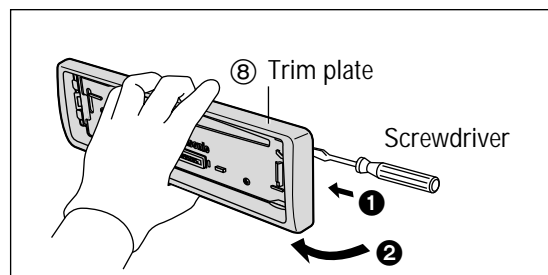
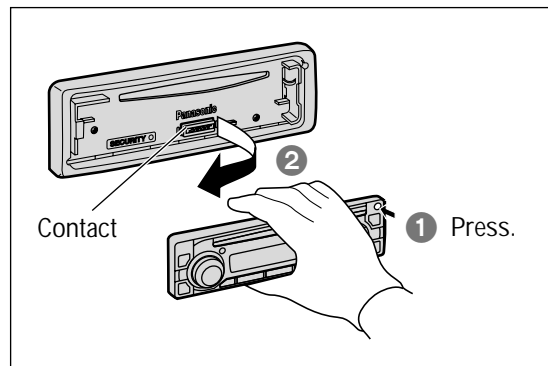

- 3
  - 1 Insert the lock cancel plates ⑨ along the grooves on both sides of the main unit until "click" is heard.
  - 2 Pull out the unit while pushing the plates further inside.

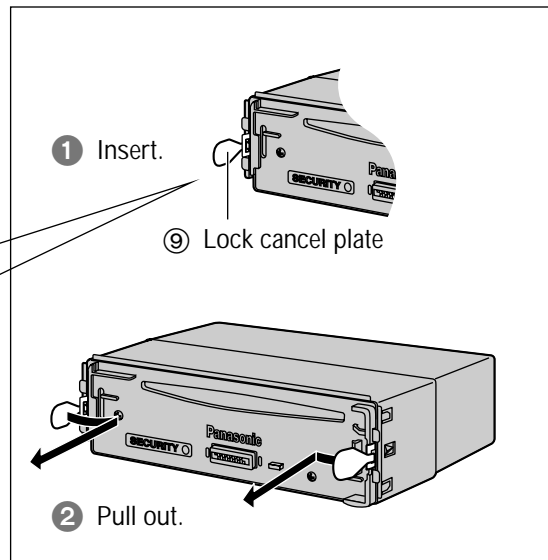
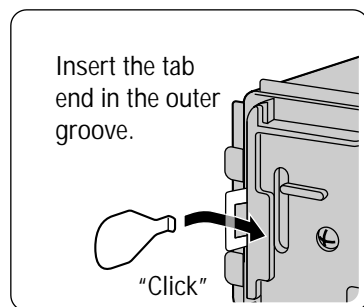

- 4 Remove the unit by pulling with both hands.

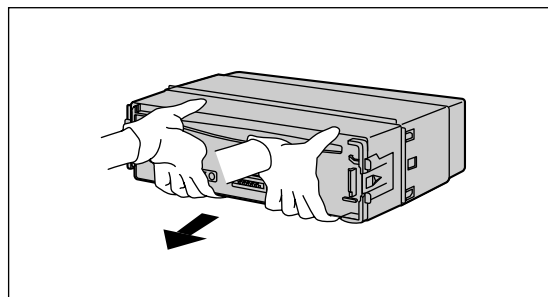

## Anti-Theft System

This unit is equipped with a removable face plate. Removing this face plate makes the radio totally inoperable.

### Place the Removable Face Plate into Case

- 1 Switch off the power of the unit.
- 2 Remove the removable face plate. (page 46)
- 3 Gently press the bottom of the case and open the cover. Place the face plate into the case and take it with you when you leave the car.

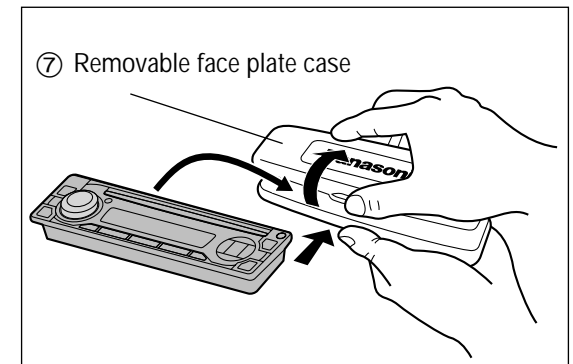

### Install Removable Face Plate

- 1 Slide the left side of the removable face plate in place.
- 2 Press the right end of the removable face plate until "click" is heard.

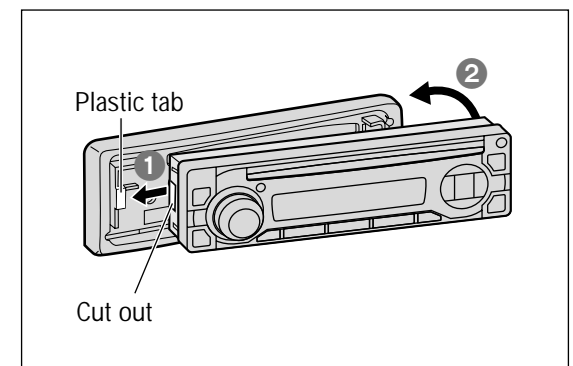

#### Caution:

- This face plate is not waterproof. Do not expose it to water or excessive moisture.
- Do not remove the face plate while driving your car.
- Do not place the face plate on the dashboard or nearby areas where the temperature rises to high level.
- Do not touch the contacts on the face plate or on the main unit, since this may result in poor electrical contacts.
- If dirt or other foreign substances get on the contacts, wipe them off with a clean and dry cloth.
- To avoid damaging the front panel, do not push it down or place objects on it while it is open.

# Electrical Connections

**Caution:**

- This product is designed to operate with a 12 V DC, negative ground battery system.
- To prevent damage to the unit, be sure to follow the connection diagram below.
- Remove approximately 1/4" (5 mm) of protective covering from the ends of the leads before connecting.
- Do not insert the power connector into the unit until the wiring is completed.
- Be sure to insulate any exposed wires from a possible short-circuit from the car chassis. Bundle all cables and keep cable terminals free from touching any metal parts.
- Remember, if your car has a drive computer or a navigation computer, the data of its memory may be erased when the battery terminals are disconnected.

**Wiring Diagram**

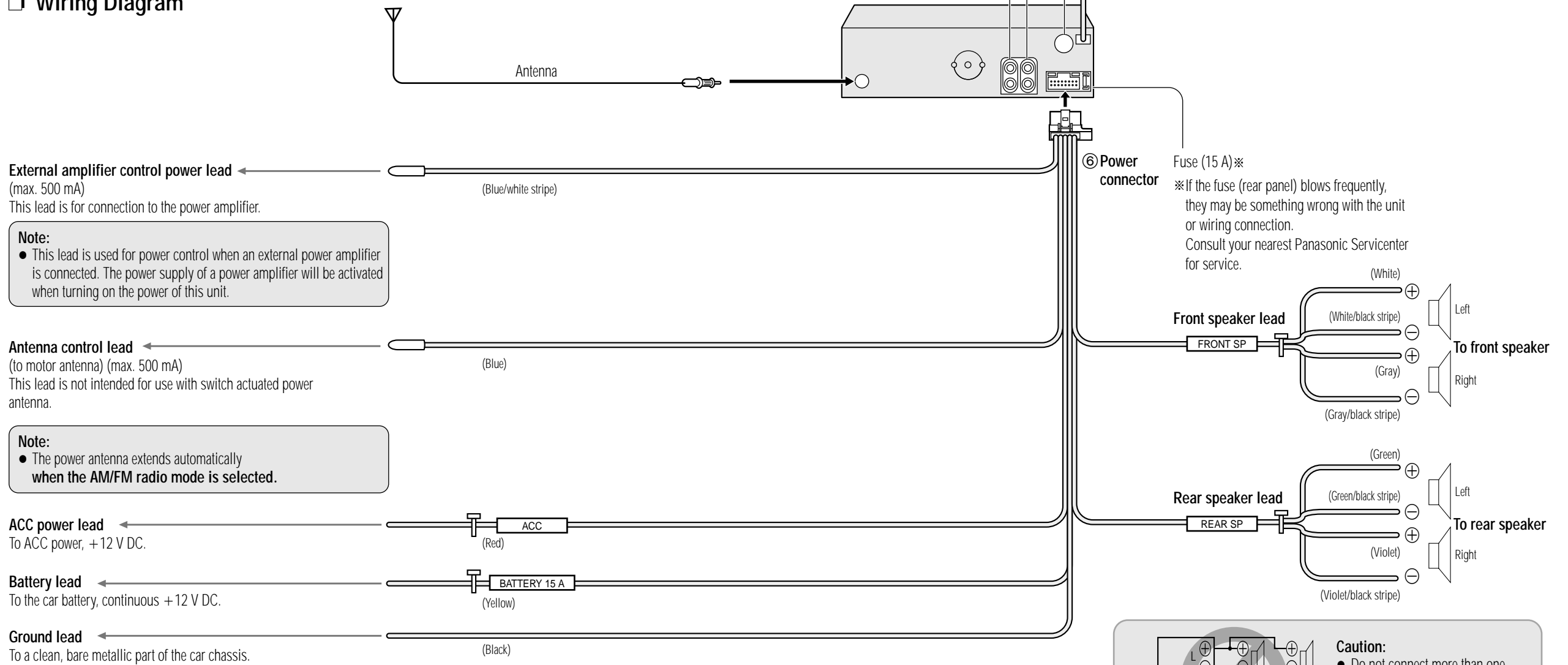

**Accessory used for wiring**

No.	Item	Q'ty
⑥	Power connector	1

**External amplifier control power lead**

(max. 500 mA)  
This lead is for connection to the power amplifier.

**Note:**

- This lead is used for power control when an external power amplifier is connected. The power supply of a power amplifier will be activated when turning on the power of this unit.

**Antenna control lead**

(to motor antenna) (max. 500 mA)  
This lead is not intended for use with switch actuated power antenna.

**Note:**

- The power antenna extends automatically when the AM/FM radio mode is selected.

**ACC power lead**

To ACC power, +12 V DC.

**Battery lead**

To the car battery, continuous +12 V DC.

**Ground lead**

To a clean, bare metallic part of the car chassis.

Fuse (15 A)\*  
\*If the fuse (rear panel) blows frequently, they may be something wrong with the unit or wiring connection. Consult your nearest Panasonic Servicenter for service.

**Front speaker lead**

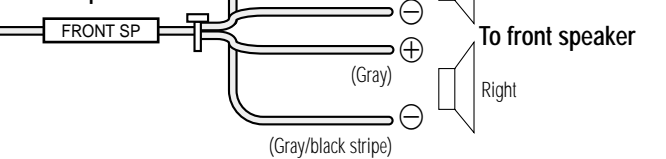

**Rear speaker lead**

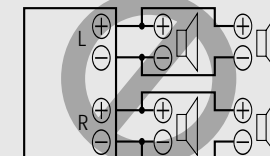
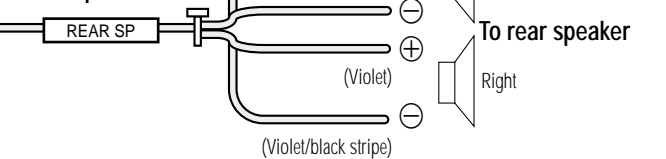

**Caution:**

- Do not connect more than one speaker to one set of speaker leads.

# Electrical Connections (continued)

## Upgrading the System

### Example combination

- CD changer (CX-DP88U, option)

### Note:

- For wiring, carefully read the operating instructions for the devices connected.

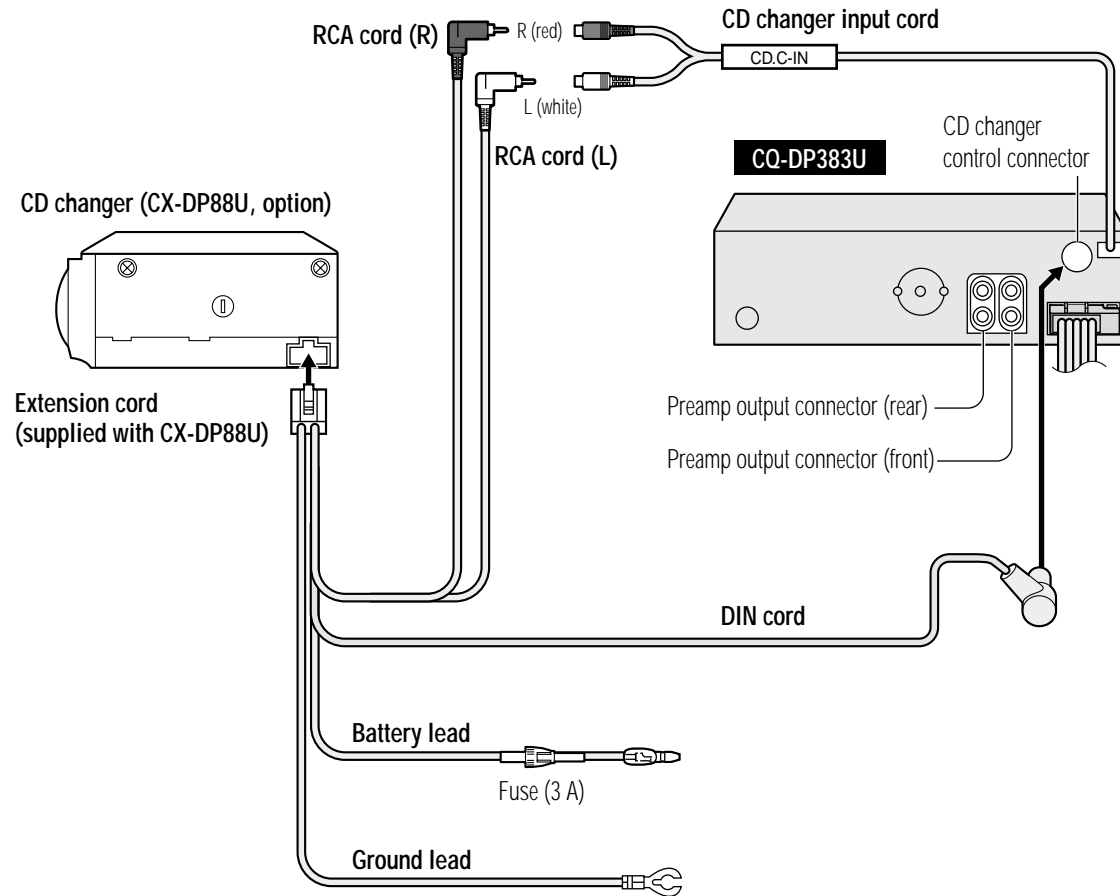

# Specifications

## General

Power supply:	12 V DC (11 V–16 V), test voltage 14.4 V, negative ground
Current consumption:	Less than 2.2 A (CD play mode; 0.5 W×4 channels)
Maximum power output:	50 W×4 channels at 1 kHz, volume control maximum
Tone adjustment range:	
Bass:	±12 dB at 100 Hz
Treble:	±12 dB at 10 kHz
Speaker impedance:	4–8 Ω
Preamp output voltage:	2.5 V (CD play mode; 1 kHz, 0 dB)
Preamp output impedance:	200 Ω
Dimensions (W×H×D):	7"×1 <sup>15</sup> / <sub>16</sub> "×6 <sup>1</sup> / <sub>8</sub> " (178×50×155 mm)
Weight:	3 lbs. 1 oz (1.4 kg)

## FM Stereo Radio

Frequency range:	87.9 MHz–107.9 MHz
Usable sensitivity:	11.0 dBf. (1.25 μV, 75 Ω)
50 dB quieting sensitivity:	15.2 dBf. (1.6 μV, 75 Ω)
Frequency response:	30 Hz–15 kHz (±3 dB)
Alternate channel selectivity:	75 dB
Stereo separation:	35 dB (1 kHz)
Image response ratio:	75 dB
IF response ratio:	100 dB
Signal to noise ratio:	70 dB

## AM Radio

Frequency range:	530 kHz–1 710 kHz
Usable sensitivity:	29 dB/μV (25 μV, S/N 20 dB)

## CD Player

Sampling frequency:	8 times oversampling
DA converter:	1 bit/4 DAC system
Pick-up type:	Astigma 3-beam
Light source:	Semiconductor laser
Wave length:	780 nm
Frequency response:	20 Hz–20 kHz (±1 dB)
Signal to noise ratio:	96 dB
Total harmonic distortion:	0.01 % (1 kHz)
Wow and flutter:	Below measurable limits
Channel separation:	75 dB
MP3 decoding:	MPEG 1 audio layer 3 / MPEG 2 audio layer 3
Bit rate:	
MPEG 1 audio layer 3:	32 kbps–320 kbps, VBR (Variable Bit Rate)
MPEG 2 audio layer 3:	8 kbps–160 kbps, VBR (Variable Bit Rate)
Sampling frequency:	
MPEG 1 audio layer 3:	32 kHz, 44.1 kHz, 48 kHz
MPEG 2 audio layer 3:	16 kHz, 22.05 kHz, 24 kHz
WMA:	
Bit rate:	64 kbps–192 kbps
Sampling frequency:	32 kHz, 44.1 kHz, 48 kHz

Above specifications comply with EIA standards.

### Note:

- Specifications and the design are subject to modification without notice due to improvements in technology.