



CRANES & DERRICKS: CODES & REGULATIONS

presented by

Ashraf Omran, P.E. and Elizabeth Mattfield, P.E.

BUILD SAFE | LIVE SAFE
CONFERENCE 2019

COPYRIGHT MATERIALS

This presentation is protected by US and International Copyright laws. Reproduction, distribution, display and use of the presentation without written permission of the Department is prohibited.

The information in this presentation is current only as of the copyright date of this presentation. This presentation is not a substitute for any law, rule or regulation. The City disclaims any liability for errors that may be contained herein and shall not be responsible for any damages, consequential or actual, arising out of or in connection with the use of this information.

© 2019 New York City Department of Buildings

DESCRIPTION

This presentation will provide an overview of types of cranes, how they are designed, set up, inspected and utilized on job sites. Attendees will learn safety requirements for installation, use, operation and removal of cranes in order to avoid potential safety hazards. Local Laws related to crane modernization, personnel, event recorders and wind measurement will be discussed.

LEARNING OBJECTIVES

At the end of this presentation, you will be able to:

1. Be familiarized with the different types of cranes and able to describe their distinctive functions.
2. Examine NYC requirements for cranes and apply these provisions to design installations and inspections.
3. Review examples of crane safety hazards and identify potential safety issues and strategies for their prevention. Participants will review rules for cranes and their application to risk mitigation.
4. Be able to summarize recent legislation related to crane modernization, personnel requirements, event recorders, and anemometers.

The background of the slide is a low-angle, upward-looking photograph of a building's steel framework under construction. A large tower crane is visible on the right side of the frame. The image is semi-transparent, allowing the text to be clearly visible over it.

CRANES

Safety Hazards

BUILD SAFE | LIVE SAFE
CONFERENCE 2019

NYC
Buildings

WIRE ROPE

Broken Wires



Torn Rope

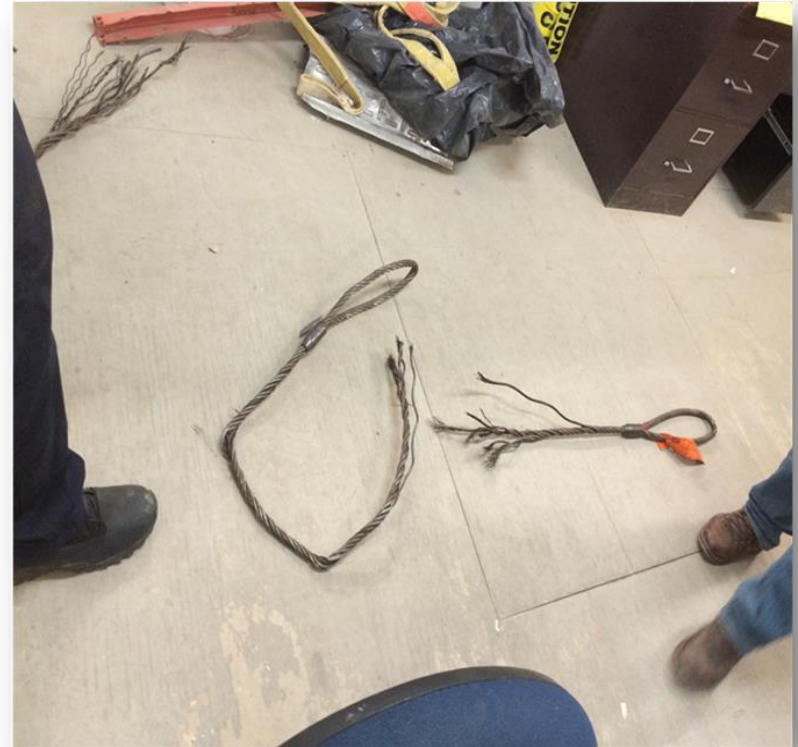

TORN SLING



IMPROPER SETUP



IMPROPER SETUP

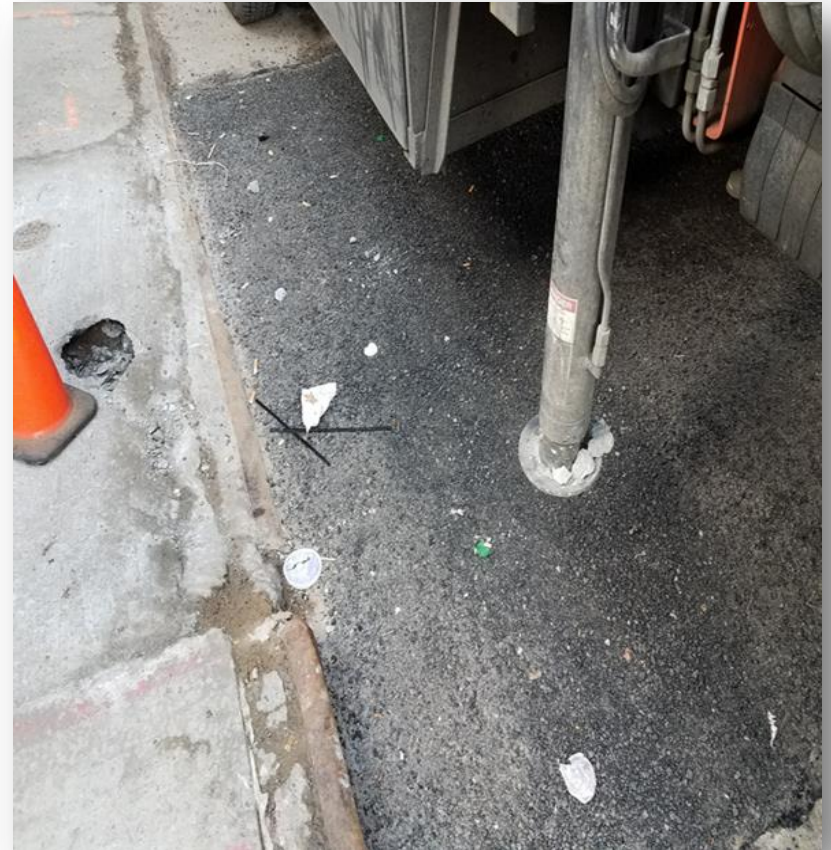

LOOSE BOLT



BENT BOOM LACING



INSUFFICIENT CLEARANCE



BOOM FAILURE



BUILD SAFE | LIVE SAFE
CONFERENCE 2019

NYC
Buildings

OVERLOADING, OVERTURNING



BUILD SAFE | LIVE SAFE
CONFERENCE 2019

NYC
Buildings

IMPROPER TIEBACK



MINI CRANE RULE

UNSAFE OPERATION

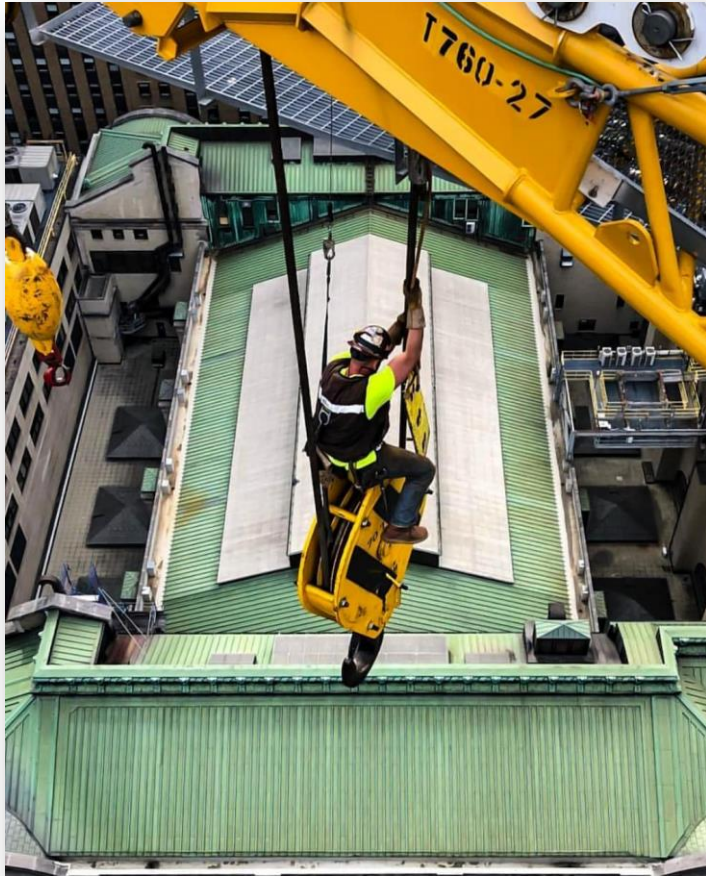

CRANE: ARTICULATING BOOM

Is this legal?



UNSAFE OPERATIONS



UNSAFE OPERATIONS



The background of the slide is a faded, light-colored image of a building's steel framework under construction. A large crane is visible on the right side of the frame. The overall tone is professional and industrial.

CRANES & DERRICKS

Codes and Regulations

BUILD SAFE | LIVE SAFE
CONFERENCE 2019

NYC
Buildings

TYPES OF CRANES: TOWER CRANES

Luffing Jib



Hammerhead



TYPES OF CRANES: MOBILE CRANES

Crawler Crane



Hydraulic Crane



DERRICKS & PILE DRIVERS

Derrick



Pile Driver



CRANES & DERRICKS

Mini Cranes



BUILD SAFE | LIVE SAFE
CONFERENCE 2019

NYC
Buildings

MINI CRANES

What is a mini crane?

Mobile crane

- Wheel or tread-mounted
- Boom length not exceeding 50 feet
- Manufacturer's rated capacity of 3 tons or less

MINI CRANES

An ALT-2 permit **must** be obtained prior to the use of a mini crane.

- The EQ-Construction Equipment work type must be selected

MINI CRANES

Plans must be filed with the permit, developed by a NYS registered PE.

- Machine make and model
- Capacity
- Site conditions/location/configuration
- Maximum and minimum swing radii
- Minimum boom clearance
- Picking/landing zones
- Securing tiebacks
- Wind thresholds

MINI CRANES

Operator Qualifications

- Licensed New York City Hoisting Machine Operator (HMO)
- Valid certificate acceptable to the Department
 - Issued by manufacturer
 - Specific to the make and model of the mini crane to be used on site

MINI CRANES

Steel Erection Work and Critical Picks:

- **Must** have Licensed New York City Hoisting Machine Operator (HMO)

Mini crane capacity in excess of 1 ton:

- Rigging crew and rigging supervisor **must** be trained or certified in accordance with Section BC 3316.9.2 of the NYC Building Code

MINI CRANES

A Lift Director is not required for the use of a mini crane.

The background of the slide is a faded, light-colored image of a building's steel framework under construction. A large crane is visible on the right side of the frame. The overall tone is professional and industrial.

CRANES & DERRICKS

Risk Mitigation

BUILD SAFE | LIVE SAFE
CONFERENCE 2019

NYC
Buildings

RISK MITIGATION: CODE & RULES

Where are we now?

Chapter 3319: Ongoing

1 RCNY 3319-01

- Phase 1: Prototype – went into effect on January 1, 2016
- Phase 2: Onsite Inspection – went into effect 5/24/2017 ****NEW CD8 FORMS introduced 3/1/2019****
- Phase 3 & 4: CD Inspection & Crane Operations – anticipated 2019

1 RCNY 3319-02: Lift Director Rule

- Effective 5/24/2017 for tower cranes and derricks
- Went into effect for all other mobile cranes approved on/after 7/1/2017

RISK MITIGATION: CODES & RULES

On-site Inspection

- A/D Director
- Updated CD8 Forms
- Lift Director
- Frequent Inspections
- Log Requirements

Local Laws

- LL 79/2017: Event Recorders
- LL 3/2018: Crane Age Bill
- LL 13/2018: Anemometer

Regulation of Articulating Booms

CRANES & DERRICKS

Risk Mitigation: On-Site Inspection

BUILD SAFE | LIVE SAFE
CONFERENCE 2019

NYC
Buildings

CERTIFICATE OF ON-SITE INSPECTION

1 RCNY §3319-01

(effective 5/24/2017)

Application for Certificate of On-Site Inspection

1. Cranes and Derricks Notice Plan
2. Assembly/Disassembly Plan
3. Pre-operational Test Procedures
4. Load Imposed
5. Wind Action Plan
6. Certifications
7. Calculations

CRANE NOTICE APPLICATION

Cranes and derricks notice plan (filed by a licensed NYS Professional Engineer) with the following information:

- Ground and Subsurface Elements
- Site Conditions
- Location and Configuration
- Foundation, Tie-ins, and Supporting Elements
- Bolted Connections
- Welded Connections
- Anchors
- Structural Steel
- Counterweights
- Aviation Hazards
- Electrical Information
- Special Inspections
- Tolerances

LOADS IMPOSED

Where the crane or derrick imparts a load on a building or structure, the application **must** be accompanied by either:

- A. Drawing stamped and sealed by EOR of the project, indicating that structure is sufficient to support loads imposed by the crane or derrick; or
- B. Signed and sealed letter from the EOR attesting to the adequacy of the building structure to support loads imposed by the crane or derrick; or
- C. For a project on which there is no EOR, a signed and sealed letter from the crane EOR attesting to the adequacy of the building structure to support imposed loads.

WIND ACTION PLAN

The application **must** be accompanied by a wind action plan:

A. Content

1. Load reductions, if any, due to wind.
2. The maximum in-service wind threshold.
3. Wind thresholds, configurations, and procedures, including angles and sequencing, for parking and securing the crane in each applicable out-of-service position (e.g. retracted, parked, jackknifed, laid down, and/or other special protective measures for wind)
4. The communication protocol for safeguarding the crane in the event of changes in weather forecasts over weekends or longer stoppage periods.

WIND ACTION PLAN

(continued)

- B. Self-contained document
- C. Maximum in-service threshold (30 mph or per manufacturer whichever more stringent)
- D. Specific to configuration
- E. Able to be implemented based upon site conditions
- F. Emergency action plan

WIND ACTION PLAN

- In-service/During Operation
- Out of Service

Sample Wind Action Plan
for a specific configuration,
make and model of
crawler crane

WIND REQUIREMENTS	
WIND SPEED (mph)	LUFFING JIB
	REDUCTION BY %
15	0
20	10
25	20
30	40
35	70
Above 35	OPERATION PROHIBITED

UP TO 49 MPH: PARK CRANE (UPPER IN LINE WITH CRAWLERS)
WITH LOAD BLOCKS AND WEIGHT BALLS ON GROUND OR
SECURED. POSITION BOOM AT 80° AND LUFFING JIB AT 66°-70°.

UP TO 80 MPH: JACK KNIFE BOOM AND LUFFING JIB.

ABOVE 80 MPH: LAY BOOM AND JIB DOWN.

CRAWLER CRANE

Out-of-Service Parked Position



WINDS < 45 MPH (PARK):

PARK BOOM AT 80°

PARK LUFFING JIB AT 63° TO 70°

DO NOT PLACE WEIGHT BALLS ON GROUND

AT HIGHER WIND SPEEDS, THE BOOM AND JIB
MUST BE PLACED ON THE GROUND OR JACK-
KNIFED.

Developed for
specific crane
make, model and
configuration

CRAWLER CRANE

Out-of-Service Jackknifing

Developed for
specific crane
make, model and
configuration

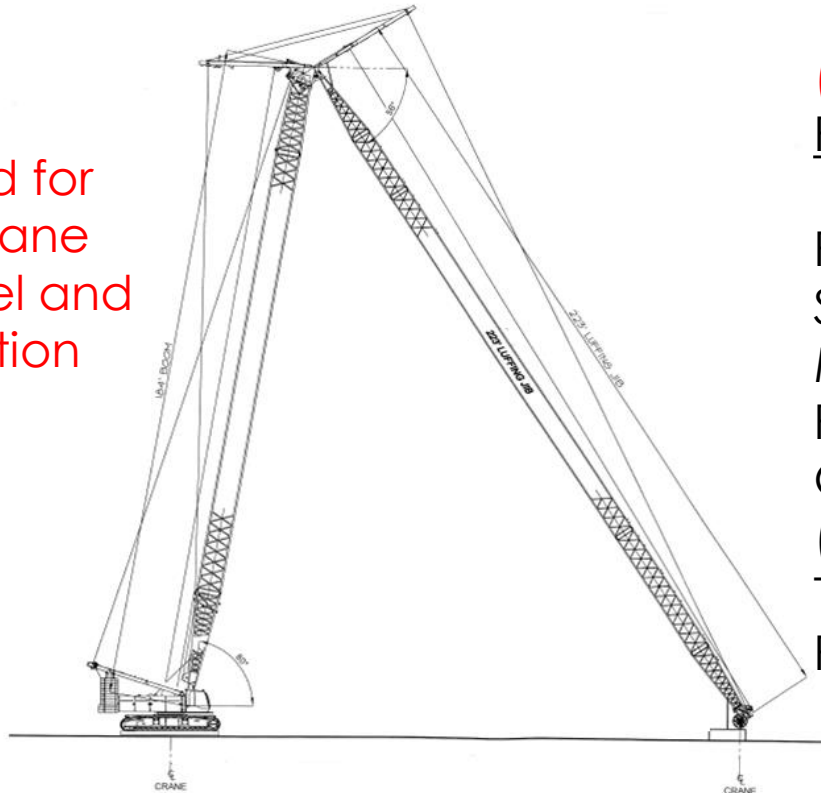

**(SAMPLE) JACK-KNIFE
PROCEDURE:**

PARK BOOM AT 80°,
SET LUFFING JIB AT $\pm 56^\circ$
MAX WIND SPEED 53 MPH
PLACE ALL BLOCKS ON
GROUND
(AT HIGHER WIND SPEEDS,
THE BOOM & JIB MUST BE
PLACED ON THE GROUND.)

CRAWLER CRANE

Sequence of Laying Down

The HMO must:

- Perform a parking/securing inspection at any time the crane is taken out of service and parked or secured.
- Record in the crane log:
 - The laid down configuration
 - Reference to the wind action plan or manufacturer's manual page
 - Maximum wind speed allowed for such configuration

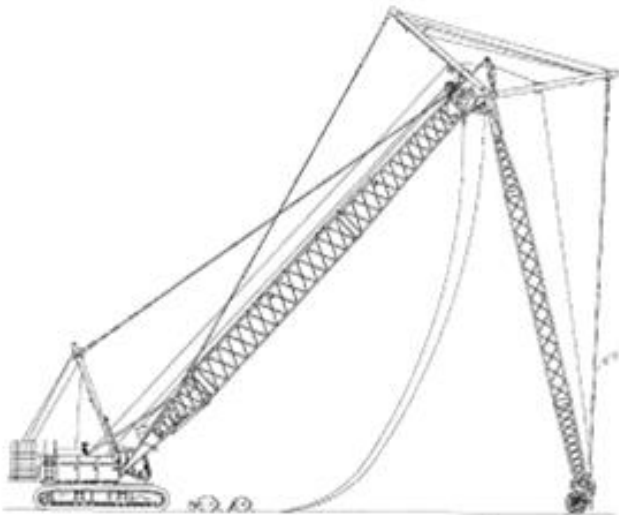

CRAWLER CRANE

Out of Service Laydown

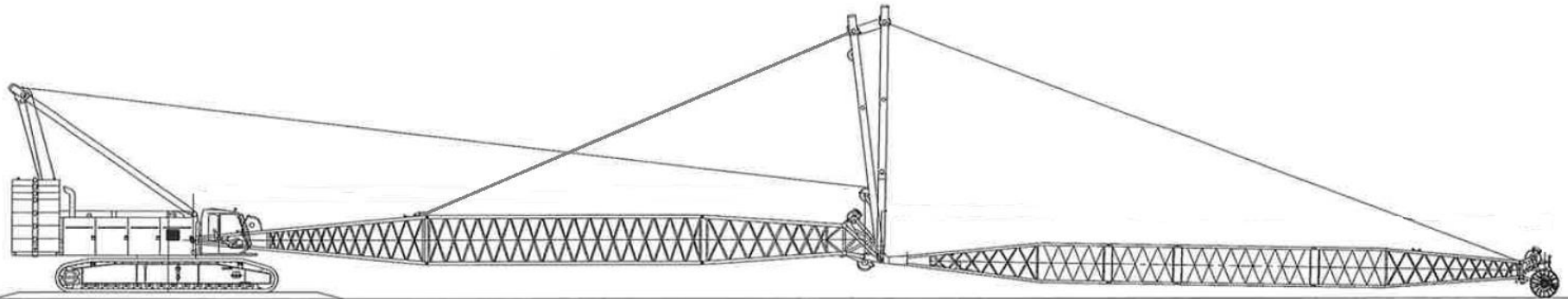

BOOM

JIB

BUILDING CODE: TOWER CRANES

Site Specific Wind Analysis

NYC Building Code 1618 (Loads on Temporary Installations)

Installations governed by this code shall be defined as temporary when such installations are intended to be taken apart or removed after a limited period following their installation including but not limited to **cranes**.

Loads on Temporary Structures

1. Shall be designed and constructed to resist loads as per NYC BC Chapter 16.
2. All temporary installations reducing the design environmental loads shall include action plan. (Basic wind speed can be reduced by applying a factor of 0.8 with an action plan).
3. Action plan shall be reliably implemented with one day's notice or less.

BUILDING CODE: TOWER CRANES

Site Specific Wind Analysis

1 RCNY §3319-01

- A. Cover each configuration for which approval is sought.
- B. Crane EOR to provide the manufacturer the following:
 1. Project address
 2. Crane make and model
 3. Maximum lifting capacity
 4. Distance of crane from building

BUILDING CODE: TOWER CRANES

Site Specific Wind Analysis

1 RCNY §3319-01 (continued)

- C. Required information from manufacturer:
 - Maximum moment
 - Slewing moment
 - Corresponding vertical loads on foundation
- D. Certification from the manufacturer that analysis is based on information provided by the crane EOR
- E. Certification from the manufacturer that all components can sustain wind load as specified above
- F. Note any special condition in which the crane may not be used or installed

BUILDING CODE: TOWER CRANES

SITE SPECIFIC WIND ANALYSIS

1 RCNY §3319-01 *(continued)*

- G. Proposed tie-in spacing
- H. Elevations and sections
- I. Action plan in case reduction factor is applied
- J. Wind load conditions, exposure category, wind distribution:
 - In-service of at least 45 mph
 - Out-of-service in accordance with NYCBC Chapter 16

TOWER CRANE ACTION PLAN

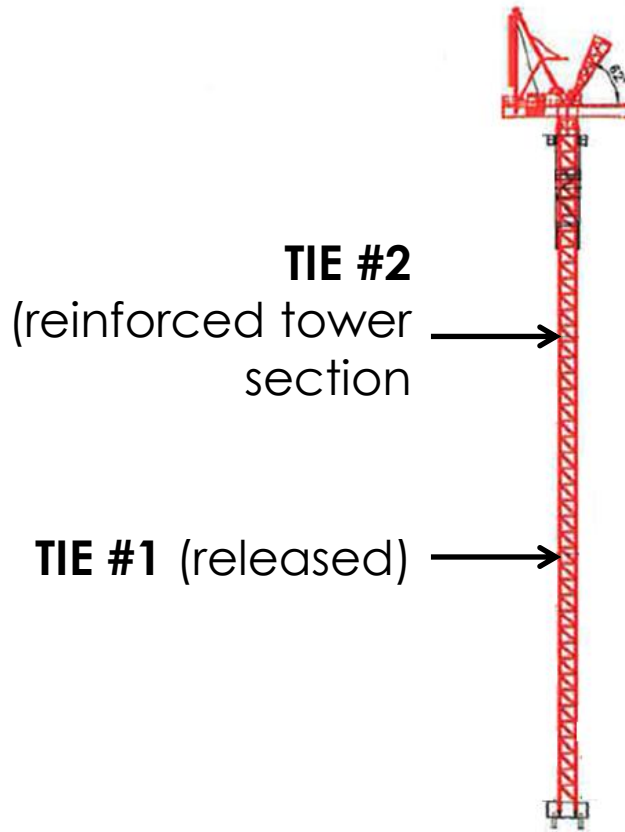

SPECIFY

- Boom configuration
- Boom angle and radius for weathervaning
- Phase including mast height

ACTION PLAN ELEVATION

LOAD TEST

PROTOCOL AND APPROVAL

For tower cranes, self-erecting tower cranes, and derricks, the application **must** be accompanied by procedures for the pre-operational test:

1. Tower crane (ASME B30.3 2016)
2. Self-erecting tower crane (ASME B30.29 2012)
3. Derrick (ASME B30.6) – 1 RCNY 3319-01 limits the load test maximum to **100% of the rated capacity**

CRANES & DERRICKS

***On-Site Inspection:
Assembly/Disassembly Plan and
Director***

BUILD SAFE | LIVE SAFE
CONFERENCE 2019

NYC
Buildings

CRANES & DERRICKS

***NEW* Assembly/Disassembly Requirements**

- Assembly/Disassembly Plan
- Assembly/Disassembly Director
- Review of Assembly/Disassembly Plan
- Training of Assembly/Disassembly Director
- Training of Assembly/Disassembly Crew

CRANES & DERRICKS

NEW Assembly/Disassembly Requirements

- Recent changes to 1RCNY 3319-01 establish new assembly/disassembly (A/D) requirements for mobile cranes and derricks.
- A/D defined as the installation or removal of structural components or attachments to a crane or derrick, or the installation of any elements that connect or attach a crane or derrick to a building or structure.
- **EXCEPTION:** A/D not applicable to operations exclusive to counterweight installation or removal, or to the unfolding and pinning of a boom or swing-away jib.
- **EXCEPTION:** Self-erecting tower crane with no additional mast sections added.

CRANES & DERRICKS

NEW Assembly/Disassembly Requirements

Assembly/Disassembly Plan: For a crane or derrick that requires components to be assembled or disassembled at the site, the application **must** include an A/D plan. The plan **must** include the following required by 1RCNY §3319-01 (g)(2)(ii):

- Content
- Self contained document
- Maximum A/D wind threshold
- Specific to configurations
- Able to be implemented based upon site condition

CRANES & DERRICKS

NEW Assembly/Disassembly Requirements

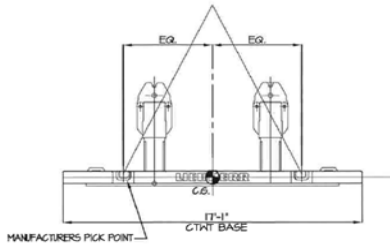

15T (33.07k) COUNTERWEIGHT BASE

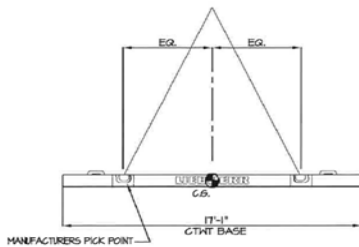

15T (33.07k) COUNTERWEIGHT PLATE

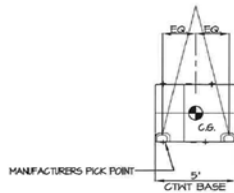

15T (33.07k) COUNTERWEIGHT BALLAST PLATE

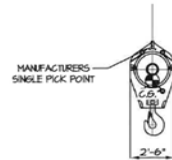

2.7k HOOK BLOCK

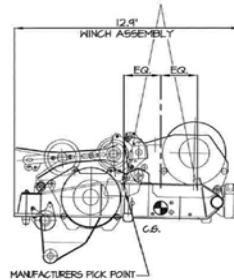

22.5t (45.3k) WINCH ASSEMBLY

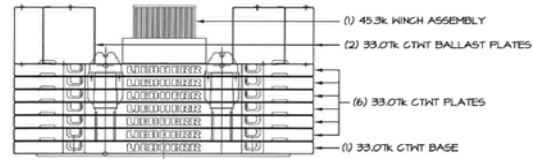

LIEBHERR LTM1500 - 297.6k COUNTERWEIGHT ASSEMBLED



CRANES & DERRICKS

NEW Assembly/Disassembly Requirements

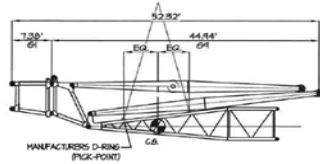

LUFFING JIB HEEL SECTION
(G1 & G9 COMBINED WT = 28.9k)

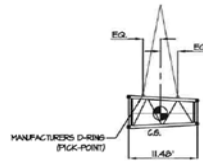

LUFFING JIB REDUCER SECTION
(G5 WT = 1.76k)

REFER TO OPERATORS
MANUAL FOR G6 & G8
GOVERNED LIFT POINT

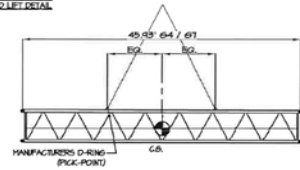

LUFFING JIB INTERMEDIATE SECTION
(G4 WT = 5.73k)
(G7 WT = 5.51k)

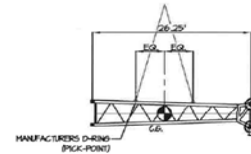

LUFFING JIB END SECTION
(G8 WT = 5.95k)

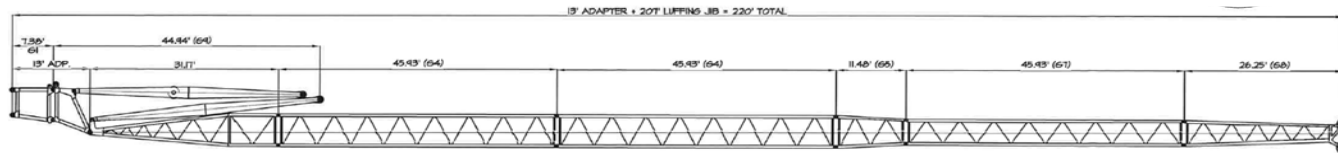

LIEBHERR LTM1500 - 207' LUFFING JIB + 13' ADAPTER ASSEMBLED

CRANES & DERRICKS

NEW Assembly/Disassembly Requirements

Assembly/Disassembly Director: No crane or derrick that requires a certificate of on-site inspection (CN) may be assembled or disassembled unless an A/D director provides continuous, onsite supervision of such operation, and ensures compliance with approved A/D plan, and as applicable, relevant rigging plans.

- Designation and qualifications
- Training and licensing
- Review of the A/D plan

CRANES & DERRICKS

NEW Assembly/Disassembly Requirements

- **Designation and qualifications:** The A/D director must be designated by the equipment user and must meet the criteria for both a competent and a qualified person.
- **Training and licensing:** If the A/D operation involves items to be hoisted or lowered, the A/D director must be a licensed master or tower crane rigger, a master rigging foreman, or be trained or certified as a rigging supervisor.
- **Review of the A/D plan:** Before A/D operation, the A/D director must review the approved A/D plan, and as applicable, relevant rigging plans.

CRANES & DERRICKS

NEW Assembly/Disassembly Requirements

Training of assembly/disassembly crew : RC §3319-01 (i)(6)

- A/D director **must** ensure all members of the A/D crew, including signalpersons, understand their tasks and hazards related to their tasks.
- If A/D operation involves items to be hoisted or lowered, the individuals who attach or detach these items from the hoisting equipment's hook (used in conjunction with the A/D operation) **must** be trained or certified as a rigging crew member.
- Signalpersons **must** also be trained or certified as a rigging crew member.

ASSEMBLY/DISASSEMBLY DIRECTOR

All cranes with certificate of onsite inspection that require assembly/disassembly will require an assembly/disassembly director to ensure compliance with assembly/disassembly plans.

- **Must** be designated by equipment user and meet the criteria for both competent and qualified person.
- If assembly/disassembly involves hoisting/lowering articles, the assembly/disassembly **must** be either:
 1. Licensed Master Rigger
 2. Tower crane rigger
 3. Master rigging foreman trained or certified as rigging supervisor per section 3316.9.2, or completed training requirements per section 3319.10

***EXCEPTION:** Tower crane erection, jumping, climbing, or dismantling must be supervised by a licensed master/tower crane rigger*

COMMISSIONER'S ORDER

Crawler Cranes

As of May 24, 2017, 3319-01 & 3319-02 supersede certain sections of June 30, 2016 Commissioner's Order for crawler cranes. These include:

REQUIREMENT	COMMISSIONER'S ORDER	NEW PROVISION
Anemometer	III, IV & V	1RCNY 3319-01(t)(7)
In-service (in-operation) Wind Threshold	VI & VII	1RCNY 3319-01(t)(3), (4), and (5)
Parking and Securing the Crane	VIII & IX	1RCNY 3319-01(h), 1RCNY 3319-01(k)(2), and 1RCNY 3319-01(t)(3), (4), and (5)
Wind Action Plan	X, XI, XII, XIII, XIV, XV & XVI	1RCNY 3319-01(g)(2)(v) and 1RCNY 3319-01(u)
Lift Director	XVII	1RCNY 3319-02(c)
Designation of the Lift Director	XVIII, XIX & XX	1RCNY 3319-02(c) and (d) <u>Note:</u> Submit CD12 form to C&D to notify DOB of primary Lift Director designation
Duties of the Lift Director	XXI	1RCNY 3319-02(e)
Ordering Corrective Action and Notification to DOB	XXII	1RCNY 3319-02(f)
Authority to Stop Operations	XXIII	1RCNY 3319-02(g)
Responsibility for Crane and Rigging Operations	XXIV	1RCNY 3319-01(i)(2), 1RCNY 3319-01(p)(2), and 1RCNY 3319-02(h)
Pre-shift Meeting	XXV, XXVI & XXVII	1RCNY 3319-02(j)

CRANES & DERRICKS

*On-Site Inspection: NEW On-Site
Inspection Forms (CD8)*

BUILD SAFE | LIVE SAFE
CONFERENCE 2019

NYC
Buildings

NEW CRANES & DERRICKS FORMS

Why do we need new forms?

- Need a consistent method of reporting on-site inspections to the Department
- Improved reporting of special inspections

NEW CRANES & DERRICKS FORMS

New CN Filings Started March 2019

CD8

Filed by Design Applicant of Record
(Crane Engineer)

CD8-TR

Performed by Crane Engineer and
SIA, documented on CD8 and
Building TR1 form

CD8-AD

Documents all inspection items on
current CD6, signed by A/D Director
and Crane Engineer

NEW CRANES & DERRICKS FORMS

When do I use each new CD8?

CD8

- Any job requiring an **on-site inspection – ALWAYS FILED**

CD8-TR

- Any job requiring **on-site special inspections**

CD8-AD

- Any job requiring an **assembled or disassembled inspection or assembly/disassembly director**

CD8: ON-SITE CRANE INSPECTIONS

- Inspections performed exclusively by Design Applicant
- On-site Inspection Checklist added
- Rule references added

CD8-TR: ID OF SPECIAL INSPECTIONS

- Replaces TR forms for crane filings
- Requires multiple filings for each applicable phase
 - Identification of requirement
 - Identification of inspection agency
 - Certification of completion

CD8-TR: ID OF SPECIAL INSPECTIONS

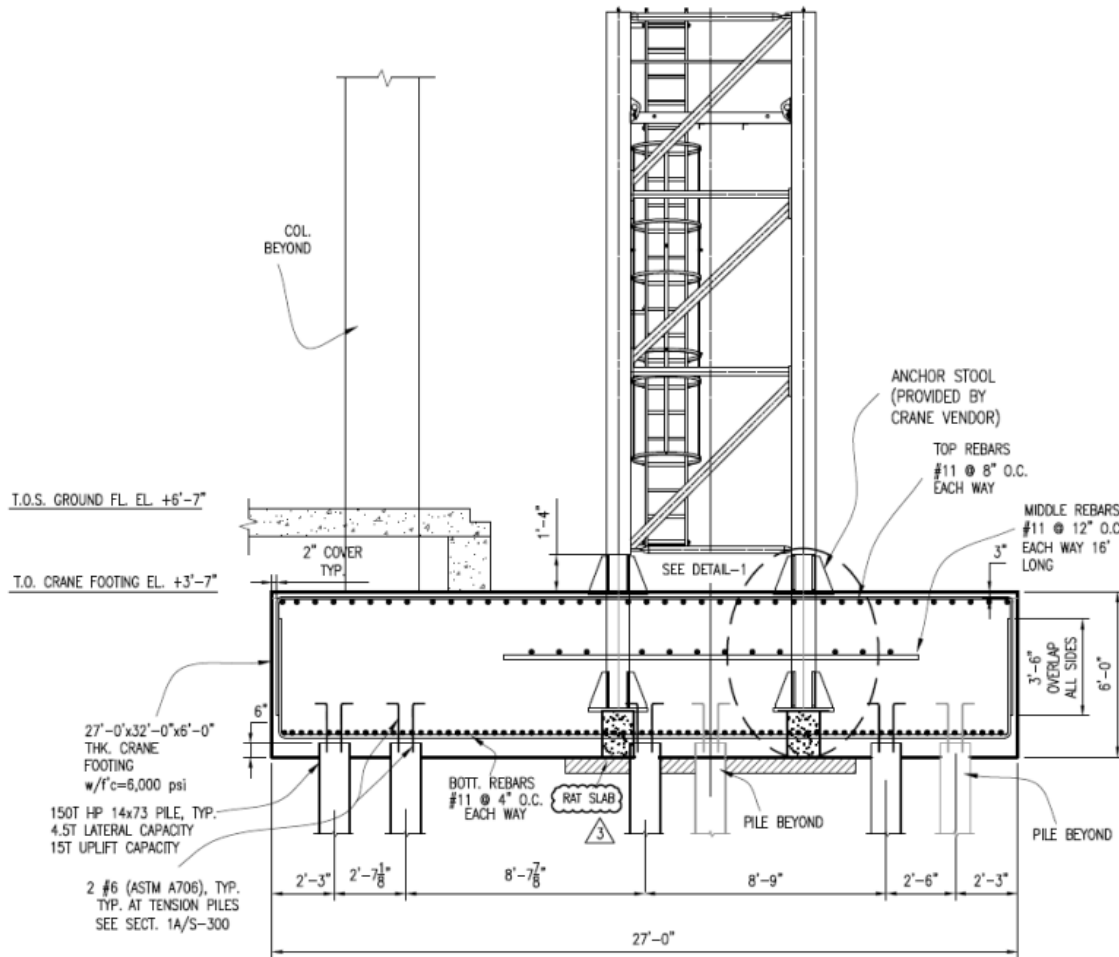

CD8-TR

Special Inspections:

- Subgrade
- Deep Foundations
- Reinforcement
- Concrete

CD8:

Design Applicant also inspects setup for conformance to design requirements, such as location, embedded components, stools, pile type/count, SIA reports

CD8-AD: ON-SITE CRANE PRE-OPERATION INSPECTIONS

- Unassembled Inspection Checklist
- Assembled Inspection Checklist
- Surveyor's statement
- Rigger or A/D Director's statement
- Pre-operational Test Witness Section

WHO INSPECTS THESE?



CRANES & DERRICKS

*On-Site Crane Inspections:
Who witnesses the Load Test?*

BUILD SAFE | LIVE SAFE
CONFERENCE 2019

NYC
Buildings

LOAD TEST

1 RCNY §3319 (g)(8)(i)(D):

The pre-operational test must be witnessed by, and verification that the crane or derrick has passed the test made by either:

1. The crane or derrick notice engineer;
2. A qualified person employed and supervised by such engineer;
3. A qualified person employed by the equipment owner;
4. A qualified person employed by the crane or derrick manufacturer or a manufacturer authorized service center, distributor, or service provider; or
5. For a derrick, a licensed master rigger, or a master rigging foreman.

LOAD TEST

Qualified Person:

A person who by possession of a recognized degree, certificate or professional standing, or who by knowledge, training and experience, has successfully demonstrated his or her ability to solve or resolve problems related to the subject matter, the work, or the project.

CD8-AD: ON-SITE CRANE PRE-OPERATION INSPECTIONS

Critical Pick

1. An article that is at or above 95 percent of approved rated capacity of the hoisting equipment or rigging equipment;
2. An article that is asymmetrical and is not provided with standard rigging ears;
3. An article that has a wind sail area exceeding 500 square feet (46 m²);
4. A pick that may present an added risk because of clearance, drift, or other interference;

CD8-AD: ON-SITE CRANE PRE-OPERATION INSPECTIONS

Critical Pick *(continued)*

5. An article that is fragile or of thin shell construction and is not provided with standard rigging ears;
6. A pick that requires multiple power-operated hoisting equipment (tandem pick); or
7. A pick that requires out of the ordinary rigging equipment, methods, or setup.

ON-SITE INSPECTION: LOAD TEST

Critical Pick:

BC 3316.9.1 Supervision

Exception 3.6: Master Rigger or Registered Design Professional

RISK MITIGATION

*On-Site Inspection: Lift Director Rules
(effective 5/24/17)*

CRANES & DERRICKS

Lift Director

- Present at jobsite fulltime and while crane is performing certain tasks
- Lift Director is required when:
 - Crane or derrick is picking a load
 - Crane is traveling at the site
 - Crane or derrick is being placed into parked condition or taken O.S.
 - Crane or derrick boom/jib is being laid down or jackknifed
 - The crane or derrick boom/jib is being raised from laid down or jackknifed
 - Other protective measures for wind are being installed or removed

CRANES & DERRICKS: LIFT DIRECTOR

Responsibilities include ensuring:

- Crane or derrick is located and configured in accordance with the approved notice plans prior to each shift or if relocating.
- Site conditions match approved notice plans.
- Traffic and pedestrian controls are in place.
- HMO, rigging supervisor, rigging crew possess proper licensing, and or training cards.
- HMO and rigging supervisor are present throughout the shift.
- Weather conditions and forecasts are monitored as warranted.

CRANES & DERRICKS: LIFT DIRECTOR

Responsibilities *(continued)*

- Coordination with HMO, rigging supervisor for the various crane operation, cease of operation, out of service action plans are implemented in accordance with notice plan.
- HMO ceases operations at the end of the shift or as weather conditions warrant.
- HMO has completed a written record prior to leaving the site.
- When warranted during O.S. periods, appropriate personnel return to the site to take further steps to secure the crane or derrick.

CRANES & DERRICKS: LIFT DIRECTOR

Responsibilities *(continued)*

- When carrying load over an occupied building, the top two floor are vacated prior to start of such operation in accordance with **1 RCNY 3319-01(q)(3)(v)**.
- Prior to a critical pick the master rigger or the P.E. has verified the pick plan in accordance with **BC Section 3316.9.1**
- Compliance with **1 RCNY 3319-01(s)(3)** for overhead power lines.
- Required frequent inspections are performed prior to start of the shift.

CRANES & DERRICKS: LIFT DIRECTOR

Responsibilities *(continued)*

- Crane operator is informed of the weight of load, moving, and placing locations of these loads.
- Crane operator's verification has been obtained that weight does not exceed crane capacity.
- Constant communication is maintained between the operator, rigging supervisor, and signalpersons.
- Load is properly rigged before it is lifted.

CRANES & DERRICKS

On-Site Inspections: Frequent Inspection

BUILD SAFE | LIVE SAFE
CONFERENCE 2019

NYC
Buildings

RISK MITIGATION: FREQUENT INSPECTION REQUIREMENTS

Recent amendments to 1RCNY 3319-01 have revised the frequent inspection requirements for cranes and derricks. Prior to each shift, the HMO **must** inspect the crane or derrick.

Inspection criteria can be found in **1RCNY 3319-01(k)(1)** and apply to the following devices:

- Mobile cranes
- Dedicated pile drivers
- Articulating boom cranes
- Tower cranes
- Self-erecting tower cranes
- Derricks

CRANES & DERRICKS

FREQUENT INSPECTION REQUIREMENTS

- **1RCNY 3319-01(k)(1)(A)(ii) Record of inspection.** Where the crane or derrick requires a certificate of on-site inspection, at the conclusion of the inspection the hoisting machine operator **must** record the results of the inspection in the crane or derrick log required by subdivision (h) of this section. Any deficiencies must be clearly noted.
- **1RCNY 3319-01(k)(1)(A)(iii) Defects.** Any defects revealed by the inspection **must** be corrected. Where such defects constitute a safety hazard, the crane or derrick cannot be operated until such defects are corrected.

The background of the slide is a faded, light-colored image of a building's steel framework under construction. A large crane is visible on the right side of the frame. The overall tone is professional and industrial.

CRANES & DERRICKS

On-Site Inspection: Log Requirements

BUILD SAFE | LIVE SAFE
CONFERENCE 2019

NYC
Buildings

CRANE & DERRICK LOG REQUIREMENTS

- **1 RCNY 3319-01** and **1 RCNY 3319-02** requires equipment user to record and maintain certain information at the jobsite.
- All entries **must** be signed and dated by individual who recorded the information.

*NOTE: For the **erection, jumping, climbing, or dismantling of a tower or climber crane**, the pre-jump safety meeting log requirements of Section 3319.8.6 of the New York City Building Code continue to apply.*

CRANE & DERRICK LOG REQUIREMENTS

For a crane or derrick requiring a CN, equipment user **must** maintain for duration of the job a crane or derrick log. As per **1RCNY 3319-01(h)**, the log **must** contain the following information:

- Equipment user custody of the crane or derrick
- Records of inspections (such records **must** be signed and dated by the hoisting machine operator who performed the inspection)
- Meeting log for the erection, climbing, jumping, or dismantling of a tower crane
- Date and time of pre-shift meetings, along with names, titles, and company affiliations of those who participated in the meeting
- The A/D Director for the assembly/disassembly operation

CRANE & DERRICK LOG REQUIREMENTS

- **Frequent (pre-shift) inspections:** Results of the pre-shift inspection required by 1 RCNY 3319-01 (k)(1) **must** be recorded by the HMO and kept in the cab or at the operator's station.
- **Parking/securing (post-shift) inspection:** Results of the post-shift inspection, required by 1 RCNY 3319-01 (k)(2), **must** be recorded by the HMO and kept in the cab or at the operator's station.
- **Pre-shift meeting:** For all pre-shift meetings, date, time, participants' names, titles, and company affiliation, required by 1 RCNY 3319-02(j), **must** be recorded in the jobsite crane or derrick log.

*NOTE: The entry **must** be made by equipment user's authorized representative.*

CRANE & DERRICK LOG REQUIREMENTS

Assembly/disassembly information: Before A/D operation, the A/D director **must** record their name and contact information in the log.

- If A/D director changes before work completion, new A/D director **must** enter their name and contact information before starting A/D director duties.

Equipment user information: When equipment user obtains or releases custody over the crane or derrick, his authorized representative **must** record this action, along with date, time, and corporate name, in log.

- All equipment users **must** be indicated on DOB-approved CD4/CD4EQ.

Change of Lift Director: If lift director changes, new lift director **must** record this change, along with name, date, and time in the log.

- CD-12 **must** be amended if permanent lift director is changed, or if an alternate will be acting in place for two consecutive weeks or longer.

CRANES & DERRICKS

Risk Mitigation: Local Laws

BUILD SAFE | LIVE SAFE
CONFERENCE 2019

NYC
Buildings

RISK MITIGATION: LOCAL LAW 79 OF 2017

Event Recorders

LL79/2017 requires that all cranes be equipped with event recorders that collect the following data:

- Crane configuration
- Any overload condition
- Status of limit switches
- Operator overrides

RISK MITIGATION: LOCAL LAW 79 OF 2017

A crane's certificate of operation cannot be renewed unless certification is provided to the Department that the event recorder has been installed.

Exceptions:

- Cranes where the manufacturer certifies to the Department that the recorder cannot be installed due to **technological limitation**

RISK MITIGATION: LOCAL LAW 3 OF 2018

Crane Age Bill

To encourage crane modernization, recent amendments to **NYCBC 3302.1** and **3319.13** set rules for how long a crane in NYC can be used.

RISK MITIGATION: LOCAL LAW 3 OF 2018

- **NYCBC 3302.1** redefines the manufacturer date of a crane to the earliest of either:
 - The date the crane was originally manufactured for its intended purpose.
 - The date that the oldest major component of the crane was originally manufactured.
- **NYCBC 3319.13** sets a standard for the maximum duration a crane can operate in NYC.
 - **BC 3319.13** Only cranes having an age of less than 25 years from the manufacture date may be used in New York City. Notwithstanding the provisions of Section 3319.5, the certificate of operation for a crane with an age greater than 25 years from the manufacture date shall be deemed to have expired.

RISK MITIGATION: LOCAL LAW 13 OF 2018

Anemometers Required

Anemometers are now required to be installed and used during crane and derrick operations.

CRANES & DERRICKS ANEMOMETER REQUIREMENTS

Recent amendments to **1 RCNY §3319-01** expanded requirements for lattice cranes to be equipped with anemometers.

- Crawler cranes with lattice boom/jib currently require anemometers
- Tower cranes **must** be equipped with anemometers by May 24, 2017
- Any other mobile crane with a lattice boom or lattice jib **must** be equipped with an anemometer if its CN is issued on/after May 24, 2017.

NOTE: An anemometer is not required if the crane is used for pile driving or clamshell operations.

CRANES & DERRICKS ANEMOMETER REQUIREMENTS

The anemometer:

- **Must** be provided by crane manufacturer or its approved entity
- **Must** be installed at the top of the boom or other location specified by the crane manufacturer.
- **Must** measure a 3-second gust wind.
- **Must** be available to the HMO at the operator's station with a real-time display.

CRANES & DERRICKS ANEMOMETER REQUIREMENTS

Recent amendments to **1 RCNY §3319-01** require anemometers to be used during derrick operations.

One of two installation options may be selected:

- The anemometer may be installed on the derrick,
or
- An anemometer may be installed at a high point of the site

CRANES & DERRICKS ANEMOMETER REQUIREMENTS

An anemometer installed on the derrick:

- **Must** be provided by crane manufacturer or an approved entity.
- **Must** be installed at the top of the boom or other location specified by derrick manufacturer.
- **Must** measure a 3-second gust wind.
- **Must** be available to HMO at the operator's station with a real time display.

CRANES & DERRICKS ANEMOMETER REQUIREMENTS

An anemometer installed at a high point of the site:

- **Must** be located at the site's high point approximate to derrick boom's height and location.
- **Must** be freely exposed to the wind.
- **Must** be calibrated in accordance with ASTM D5096-02.
- **Must** measure a 3-second gust wind.
- **Must** be available to the HMO at the operator's station with a real time display, or provide a HMO designated person to monitor display and alert the HMO when measurements near, meet, or exceed the thresholds specified in the approved wind action plan.

CRANES & DERRICKS

Risk Mitigation: Codes & Rules for Articulating Booms

BUILD SAFE | LIVE SAFE
CONFERENCE 2019

NYC
Buildings

CRANE: ARTICULATING BOOM

Permitting and Licensing Requirements

NYC Building Code 3319.3 does not require prior approval of the Department of Buildings to use an articulating boom crane at a jobsite, provided all of the following conditions are met:

- The articulating boom crane is used exclusively to load or unload a truck or trailer;
- The length of the boom does not exceed 135 feet; and
- The material is not raised vertically more than 100 feet during the unloading process.

CRANE: ARTICULATING BOOM

Permitting and Licensing Requirements

A prototype, CN, CD, and HMO licensee **are required** if an articulating boom crane is used for any other type of work at a job site including but not limited to:

- Deliveries at a jobsite beyond the maximums specified in BC 3319.3.
- Holding steel, HVAC equipment, hoist towers, scaffolding, sidewalk shed components, or any other loads in place while they are bolted or otherwise affixed.
- Assisting in the demolition of a building.

The logo for NYC Buildings, featuring the letters 'NYC' in a large, bold, blue, sans-serif font with a trademark symbol (TM) to the upper right. Below 'NYC' is the word 'Buildings' in a smaller, blue, sans-serif font. The background is a light, faded image of a building's steel framework.

NYCTM

Buildings

© 2019 New York City Department of Buildings

BUILD SAFE | LIVE SAFE
CONFERENCE 2019

The NYC Buildings logo, consisting of the letters 'NYC' in a large, bold, white, sans-serif font with a trademark symbol (TM) to the upper right, and the word 'Buildings' in a smaller, white, sans-serif font below it. The background is a dark, faded image of a building's steel framework.

NYCTM
Buildings