

CRESTLINE® DAMPENING SYSTEM

INSTALLATION INSTRUCTIONS

Ryobi 3302M

Itek 3985

A.B. Dick 9985

ACCEL ®
Graphic Systems

GENERAL INFORMATION

ATTENTION CRESTLINE® DAMPENER OWNER

Accel Graphic Systems provides parts and service through its authorized distributors and dealers. Therefore, all requests for parts and service should be directed to your local dealer.

The philosophy of Accel Graphic Systems is to continually improve all of its products. Written notices of changes and improvements are sent to Accel Graphic Systems' Dealers.

If the operating characteristics or the appearance of your product differs from those described in this manual, please contact your local Accel Graphic Systems Dealer for updated information and assistance.

Always update your dampener when improvements are made available, especially those related to safety.

YOUR AUTHORIZED CRESTLINE® DEALER IS:

THE SERIAL NUMBER OF YOUR CRESTLINE® DAMPENER(S) IS:

SAFETY INFORMATION

FOR YOUR SAFETY, DO NOT DISENGAGE OR REMOVE ANY GUARDS FROM THE CRESTLINE® DAMPENER. THE DAMPENER CONTAINS SOME INWARD ROTATING ROLLER NIPS THAT CAN CAUSE INJURY IF LEFT UNGUARDED.

GENERAL INFORMATION

BASIC CONFIGURATION OF CRESTLINE®

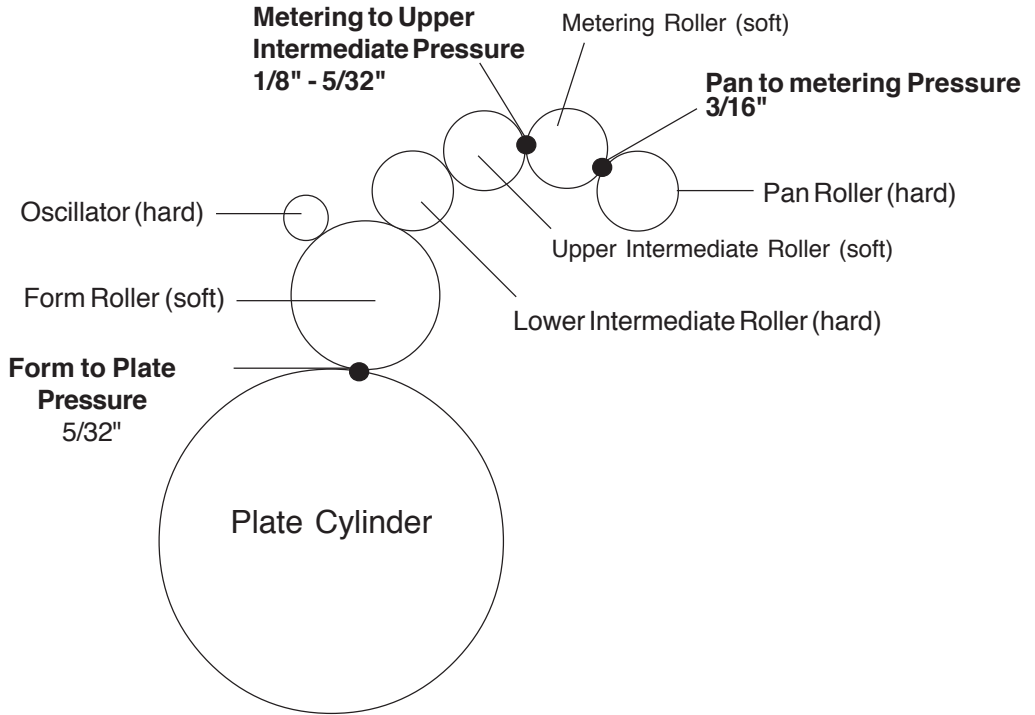

TERMINOLOGY

OPS = Operator's Side

NOPS = Non Operator's Side

TECHNICAL ASSISTANCE

For technical assistance during the installation, please contact:

ACCEL GRAPHIC SYSTEMS
 11103 Indian Trail
 Dallas, TX 75229
 PHONE (972) 484-6808
 FAX (800) 365-6510
 E-MAIL accel@dallas.net
 WEB SITE www.accelgraphicsystems.com

Crestline® is covered by U.S. Patents and Patents Pending

GENERAL INFORMATION

REQUIRED TOOLS

1. Phillips Screwdriver
2. Standard Screwdriver
3. 1/8" & 3/32" Allen
4. 2.5, 3, 4, 5, & 6 mm Allens
5. 8, 10, 13, & 17 mm Wrenches
6. 7/16" Open End Wrench
7. Vise Grips
8. 4 mm Punch
9. Brass Drift
10. 1/8" Punch
11. Hammer

PRE-INSTALLATION INSTRUCTIONS

PRE-INSTALLATION PROCEDURES AND HOW TO PARALLEL THE DAMPENER.

1. Cut the ties holding the rollers and examine the rollers for gouges, scratches or nicks.
2. Check the box and parts boards to make sure all pieces are present and nothing has been damaged in shipment.
3. Check the dampener alignment by setting it on end on a flat surface such as a cutter bed. If dampener rocks, it needs to be realigned. Loosen the tie bar bolt and align the frames on the flat surface. Retighten bolt.

DISASSEMBLY

1

Remove guards covering the plate cylinder on both printing units.

2

Remove operating handles and upper side covers from OPS and NOPS sides of both printing heads.

3

Remove the small covers over the water control mechanism OPS & NOPS. On older model presses, remove the gray plate that indicates the clicks in ratchet system.

7

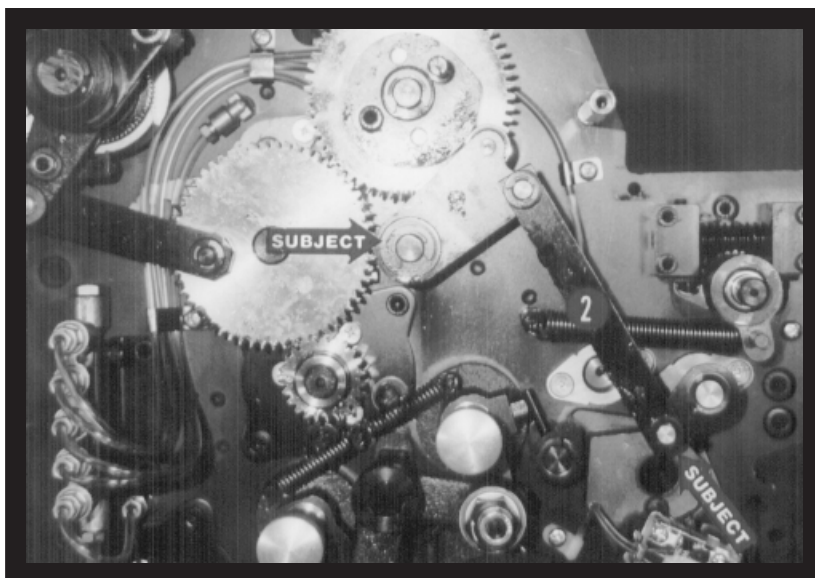
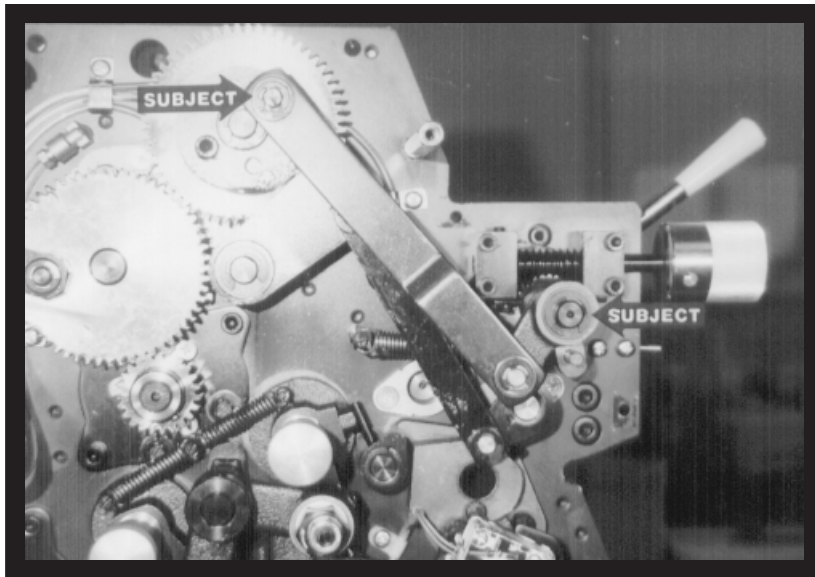

DISASSEMBLY

4

Remove the water tray and cloth covered rollers from both printing units.

5

At the OPS, remove "E" clips and washers (subject arrows) from stud and pull off the assembly held by these parts.

6

At the OPS, remove the spring behind the arm (#2, not visible in picture). Remove the "E" clips and washers (subject arrows) and pull the assembly off.

9

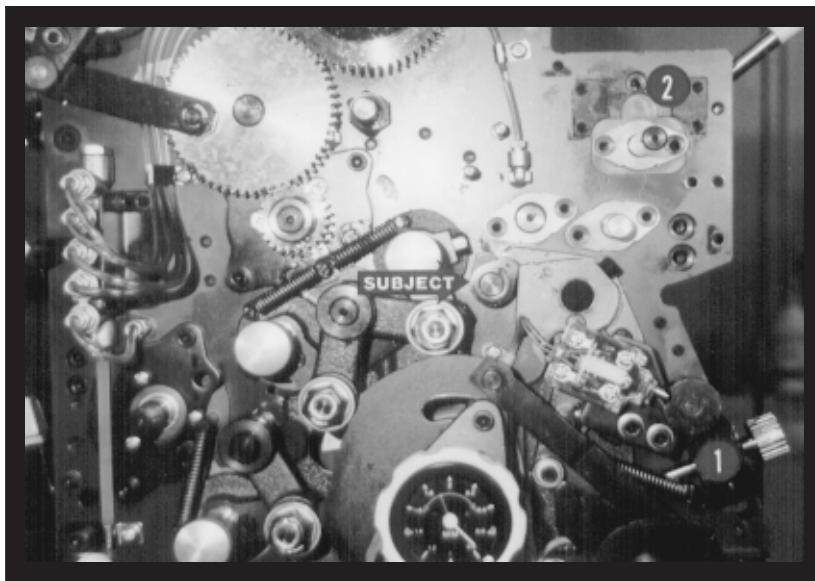
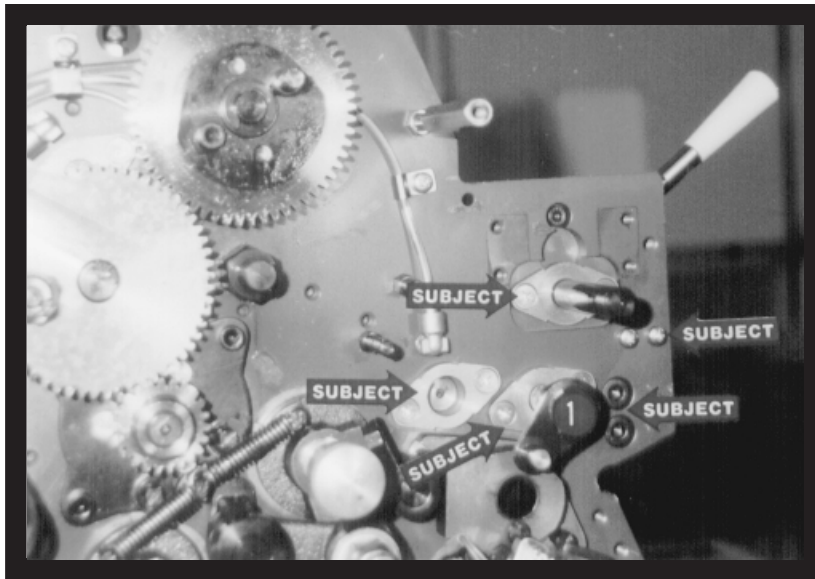
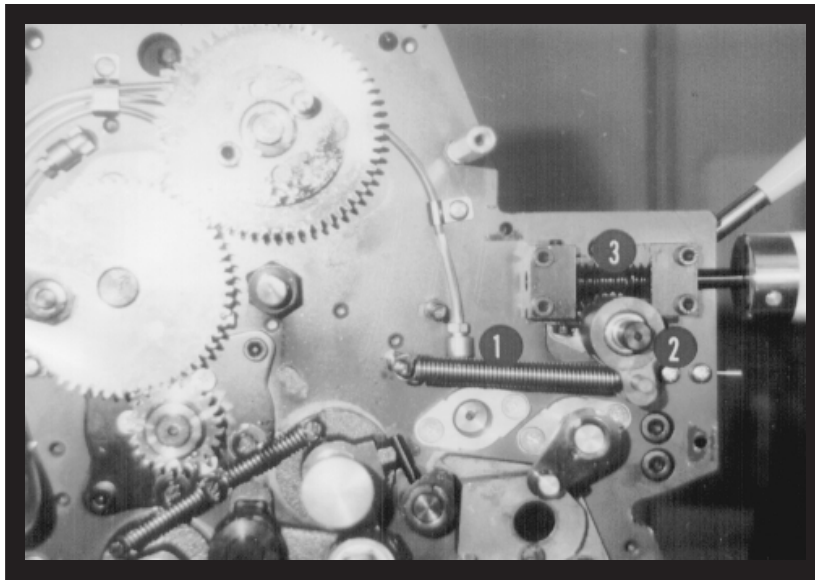

7

At the OPS, remove the spring (#1), housing with clutch (#2), and infinite water control (#3, held on by 4 bolts) from the end of the water fountain roller shaft. (Older models have an arm and ratchet assembly with a gear. Remove these pieces if the press does not have the infinite water control. The gear has a set screw in it that needs to be loosened before you can remove it.)

8

Drive the pin out of the arm (#1) and remove it. Remove all the screws indicated by the subject arrows. The arrows on the left indicate the housings for the metal rollers and ductor. The upper arrow, on the right, is the water pan block, the lower arrow is the tie bar bolts. These are at the OPS.

NOTE: A new tie bar will be installed in the press during the dampener installation.

9

Remove the long stop pin from the hosing on the water form night latch shaft (subject arrow). Remove the bolt from the wiper bar (#2). These are located at the OPS. (On older models, the bolt holding the wiper bar is at the NOPS.) Remove the wiper bar.

OPTION: You can remove the small screw and clicker plate from the water form adjustment screw block (#1) and replace it with the set screws #05-153025 provided by Accel. This will secure the form to plate setting once adjusted.

NOTE: This picture has the parts already removed.

11

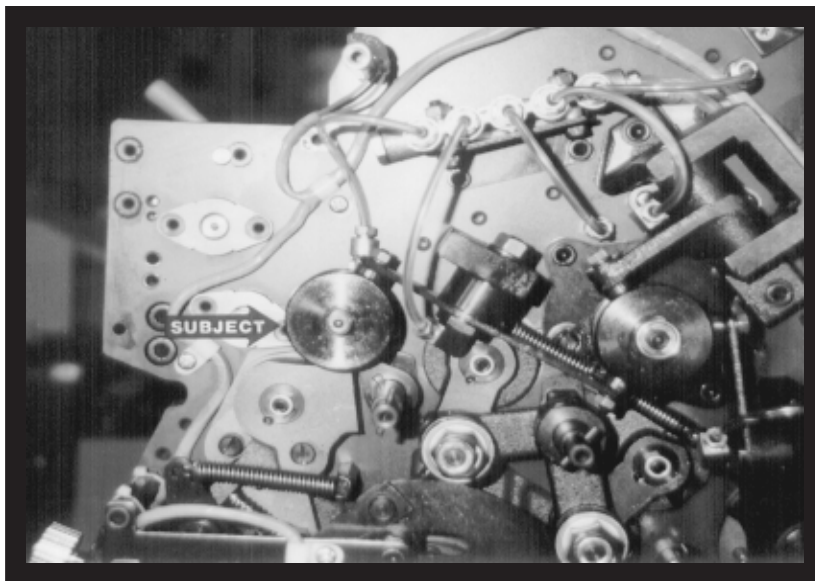
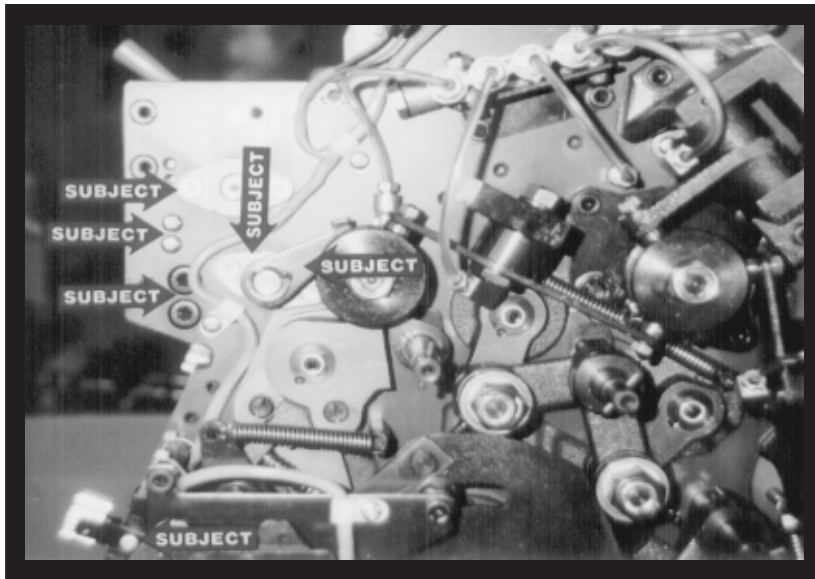
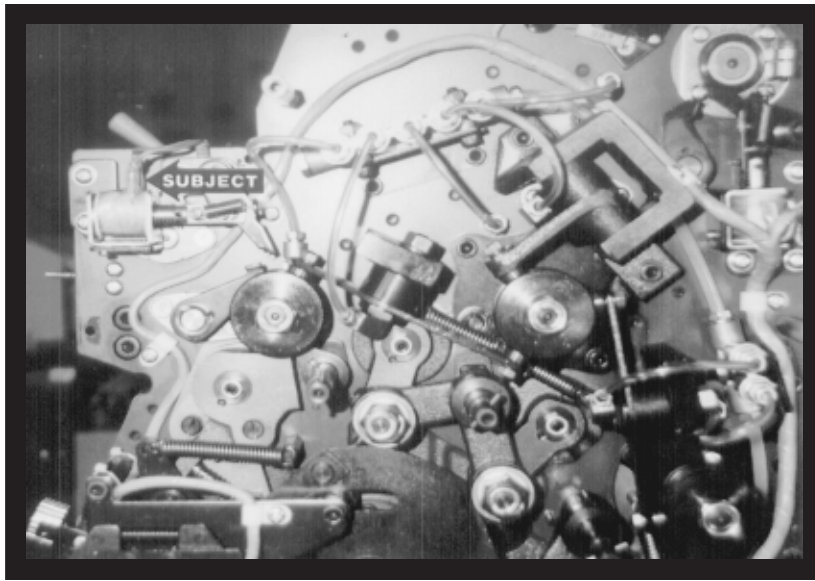

10

Unhook the wires from the solenoid at NOPS (subject arrow) and remove it from the press. 3 screws hold the solenoid. Each screw has a washer and a spacer. Be sure these parts do not fall in the press.

11

At the NOPS, drive the pin out and remove the arm (subject arrow at far right.) Remove the screws near the other subject arrows

12

Remove the nut and spool from the end of the oscillator (subject arrow.) The easiest way to do this is:

1. Rotate the press, by hand, until the oscillator has moved all the way to the NOPS.
2. Remove the nut and lock washer from the end of the oscillator.
3. Remove the oscillator bushing at the OPS and slide the oscillator roller by hand to the OPS. The spool will come off.

13

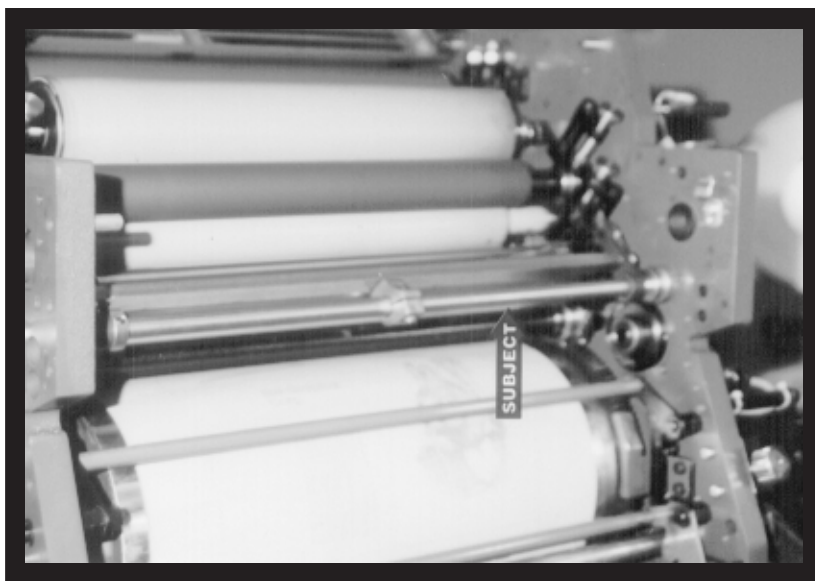
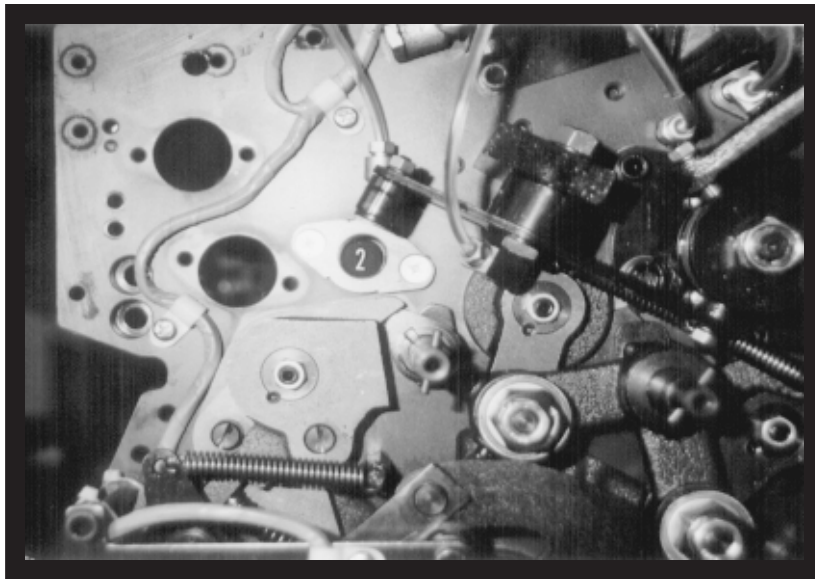
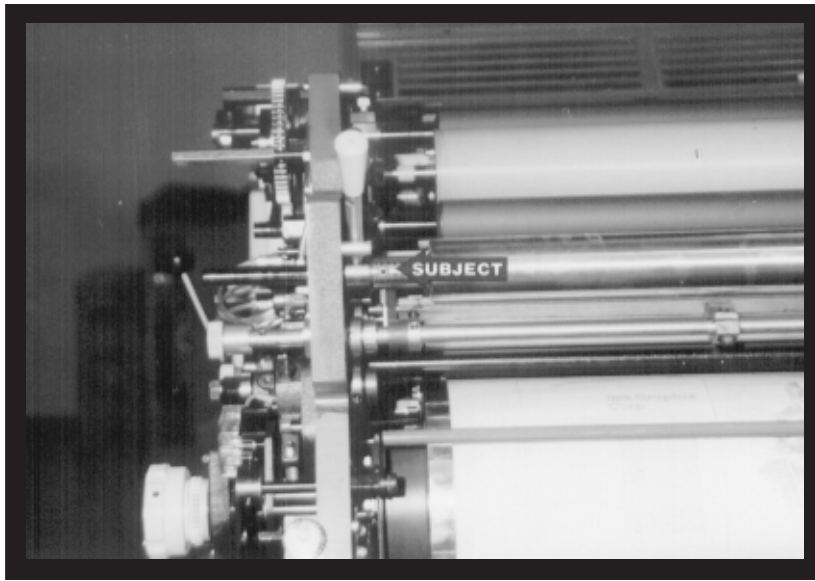

13

Remove the cap screw (subject arrow) holding the two pieces of the water fountain roller together. Remove the bushings from the side frame holding the roller, slide the two pieces apart, and remove the pan roller and extension from the press.

NOTE: Older models may have a single piece fountain roller.

14

Remove the 2 screws and bushing (near #2) for the oscillator at the NOPS. Slide the oscillator roller out of the press.

15

The water ductor mechanism (subject arrow) has a series of set screws holding it to the shaft. Loosen all the set screws, including the one in the brass collar in the middle. Remove the bushings holding the shaft in the side frames. Gently tap the shaft towards the OPS until it clears the inside of the press frame. The entire assembly can be removed.

15

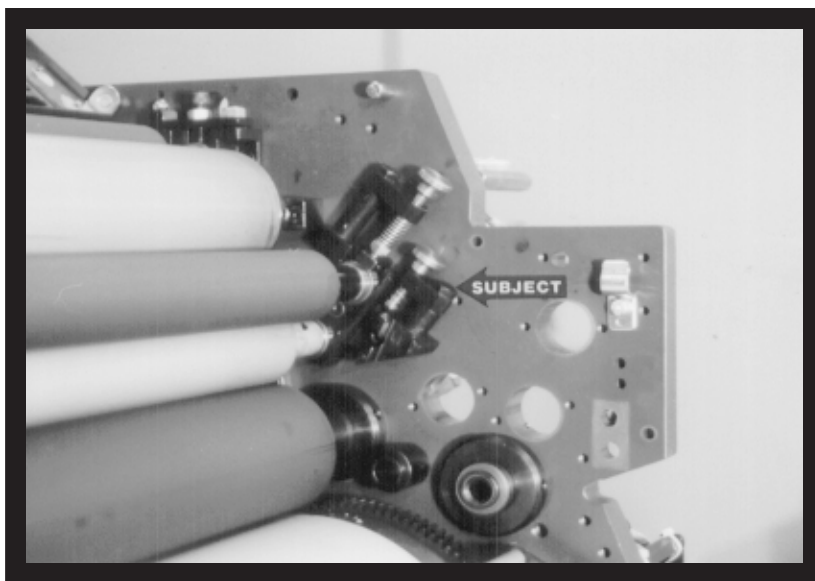
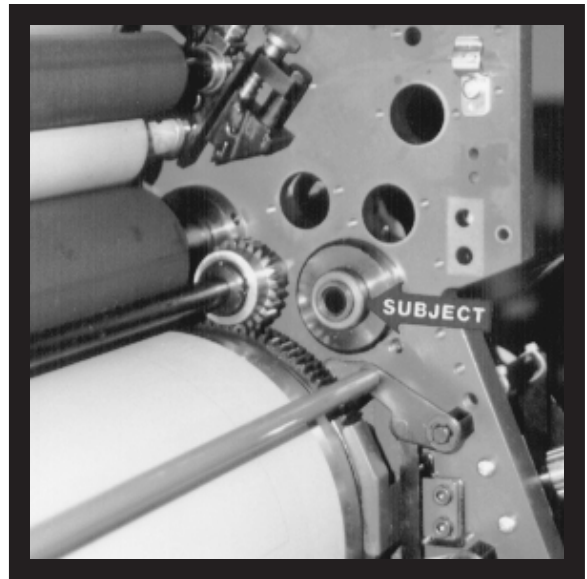
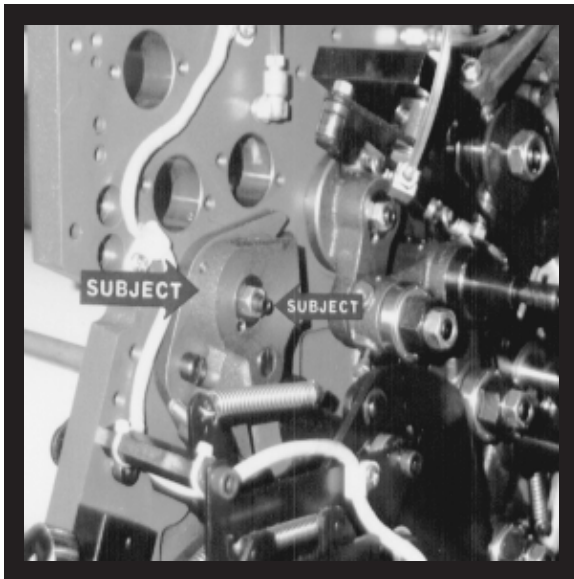
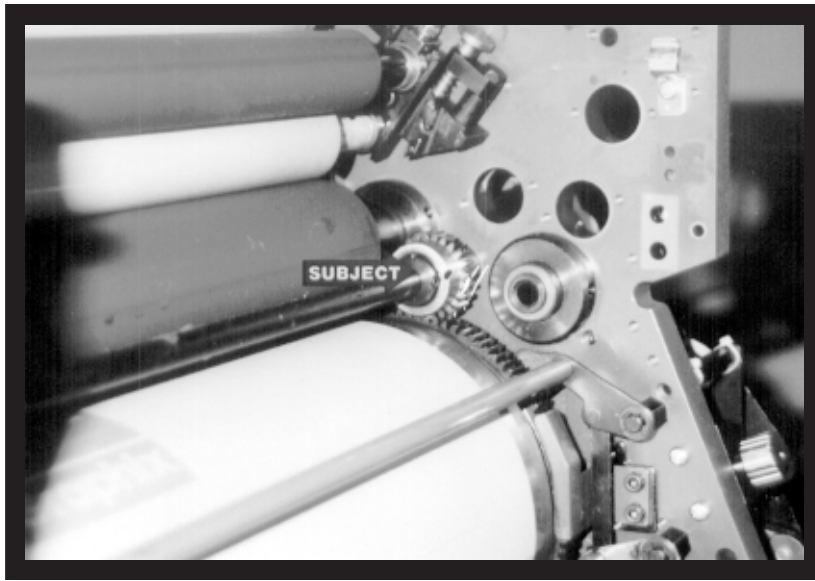

16

Remove the water form night latch shaft as follows:

1. Put the handle on the shaft at NOPS.
 2. Knock the pin out and remove the collar on the shaft at the OPS.
(Located outside the side frame.)
 3. Loosen the two set screws in the collar (subject arrow).
 4. Clean the shaft thoroughly and spray with a lubricant.
 5. Pull the shaft towards the NOPS to remove shaft, collar and gear.
-

17

Loosen set screw (left hand subject arrow, left picture). Also loosen lock nut (right hand subject arrow, left picture) and back out set screw almost all the way. Gently tap inner ring (subject arrow, right hand picture) until it is flush with the middle ring. Tighten side screw, spin end play screw back in until it stops and then tighten lock nut.

This is only done at the NOPS.

18

Remove the bolt and spring loaded assembly (subject arrow) at OPS and NOPS.

17



19

Remove the studs (#2) from inside the press frame. There is one stud in the first printing unit and 3 in the second printing unit.

YOU ARE NOW READY TO INSTALL CRESTLINE®.

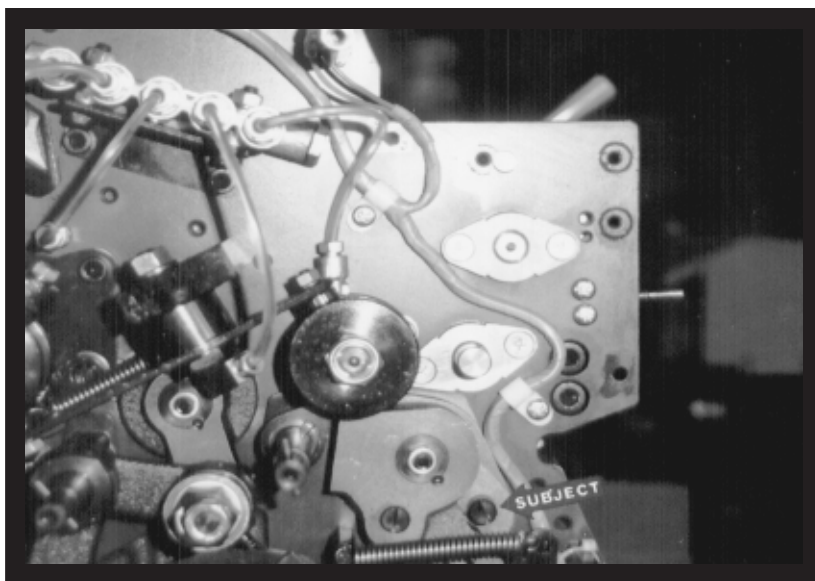
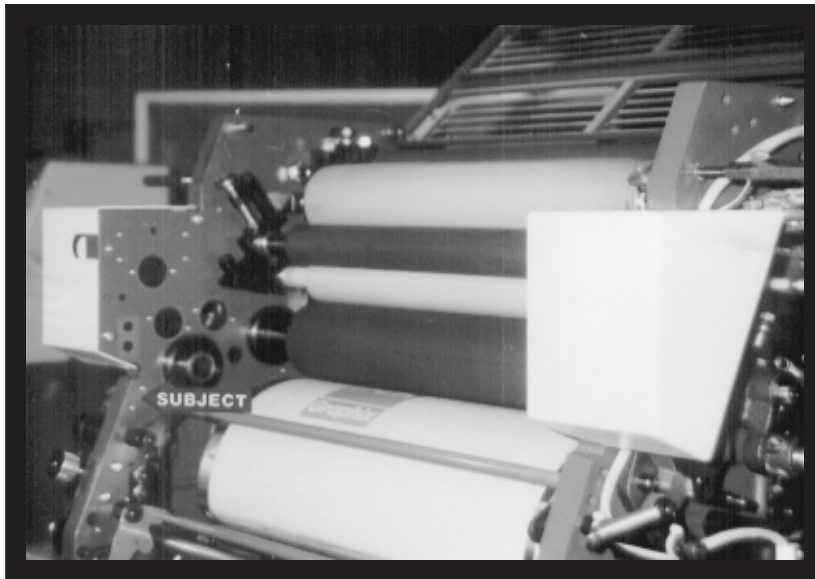
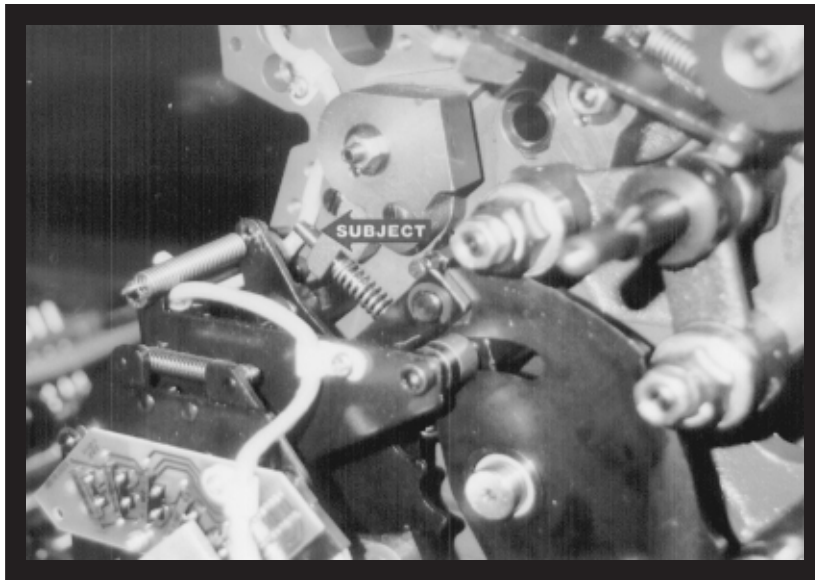

INSTALLATION

1

Tighten screw (subject arrow) until it is flush with the cast metal arm it is threaded through. This tightens a spring and prevents the entire housing from moving. Screws are located at OPS and NOPS of both printing units.

2

Reinstall small side covers. On older press also reinstall the small gray plates (not shown) taken off with the small side covers. Note the two holes (subject arrow). These holes are used in step 5.

3

Make sure the pivot stud (subject arrow) is fully tight at OPS and NOPS. Accel recommends removing screw and placing a drop of Loc-tite or similar product on the threads before proceeding.

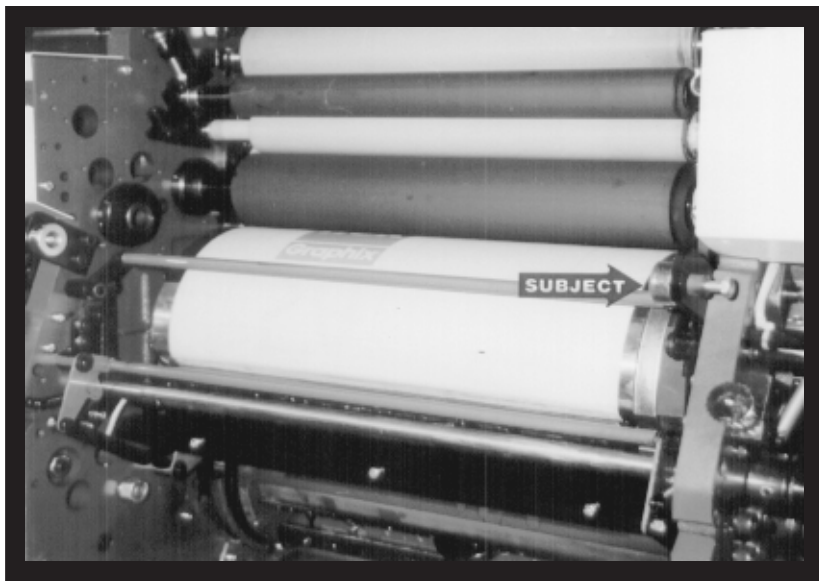
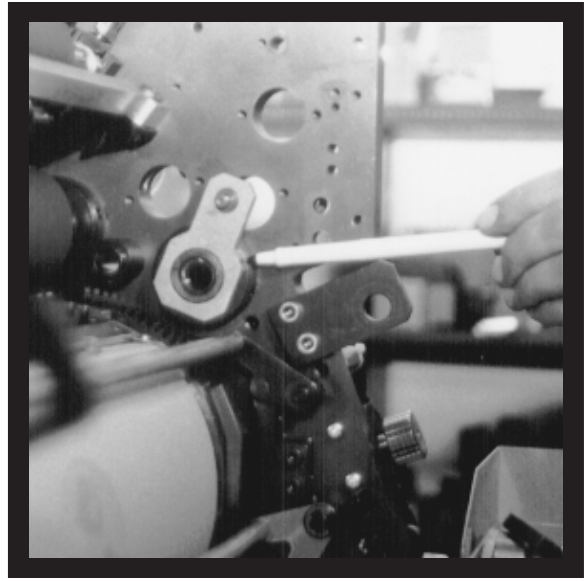

INSTALLATION

4

Take the provided aluminum connecting links #17-0704 and slip the small black eccentric through the small hole in the link and its retaining bolt. Next, slip the link over the molleton form roller housing as shown.

5

The hex portion of the eccentric and the bolt head will face outward. Let the link lie down and rest the bolt head against the opening in the press frame as shown. Install the Crestline® mounting block #16-02 as shown in the picture. Make sure that the mounting hole faces down on each side.

6

Place the bolts #05-114125, mounting spools 12-113100 and set collars 13-5043 into the mounting blocks as shown (subject arrow). The set collar should be flush against the inside of the mounting block and the spool should not extend past the set collar.

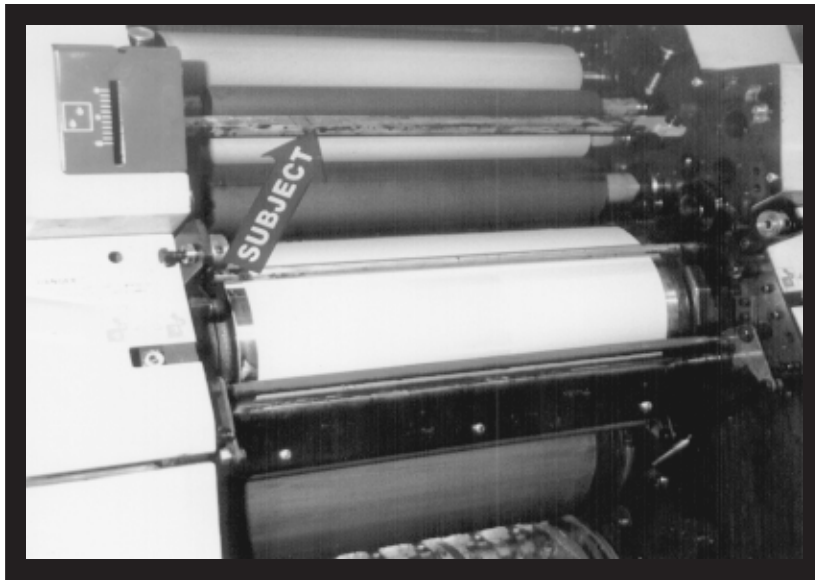

INSTALLATION

7

Set the bar #02-0301 (subject arrow) over the posts which held the spring loaded assembly removed in disassembly step 18. Check the dampener on a cutter bed to see if it is square.

8

Remove the oscillator, intermediates, and metering rollers from dampener. Set the dampener between the press frames as shown, making sure the dampener form gear meshes with the plate cylinder. The front edge of the dampener will rest under the casting where the tie bar rests (Step 7 above).

9

Tighten the mounting bolt (left hand subject arrow). This may misalign the dampener. Make sure the water form is centered relative to the ink forms, then move the set collar (right hand subject arrow) against the mounting block at each side and tighten.

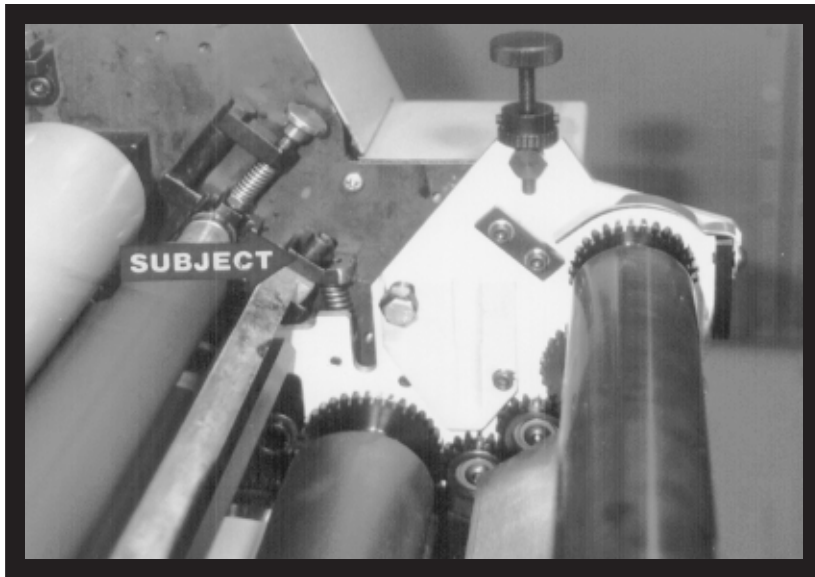

10

Thread the bolt in the eccentric into the tapped hole in the dampener side frame and finger tighten. The high side of the eccentric (denoted by yellow dot) should point toward the press feeder.

11

Slip spring #09-0202 over posts at OPS and NOPS of dampener and secure retainer (subject arrow) to the posts protruding through the new tie bar with the blocks #08-020303 and bolts #05-128M20 provided.

12

Replace both plate cylinder guards and the inker guards with the new ones provided by Accel.

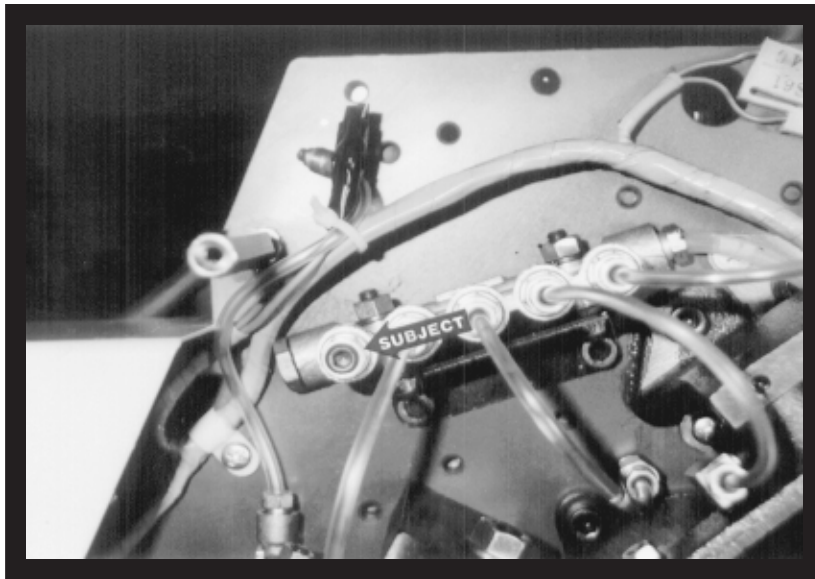
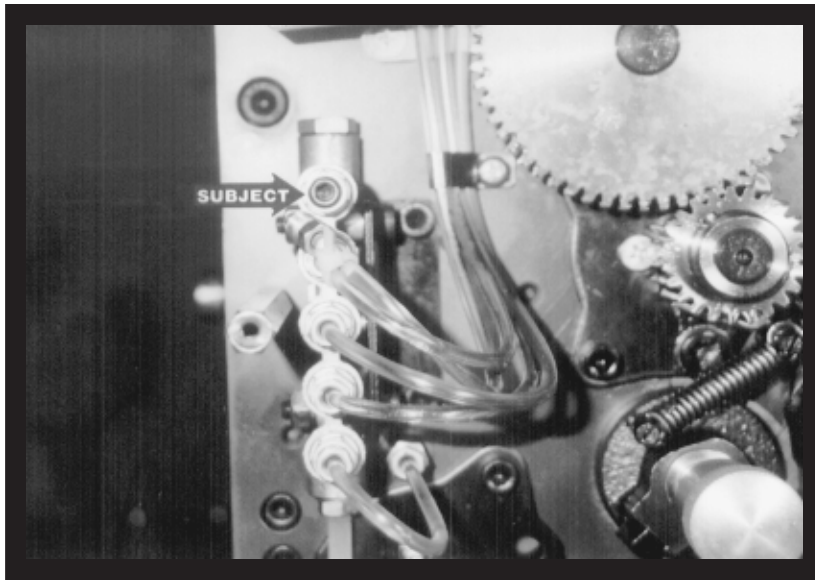

13

Plug up the oil lines at OPS (picture #1) and NOPS (Picture #2) with the screws #99-24 provided and zip tie the lines. Note how the solenoid wires at NOPS are taped off and tied with the oil line.

YOU ARE NOW READY TO MAKE THE FINAL ADJUSTMENTS.

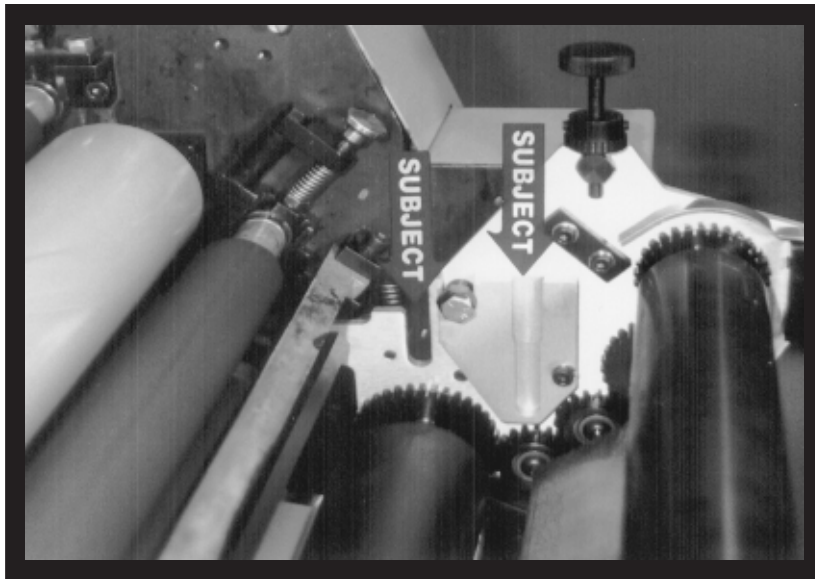
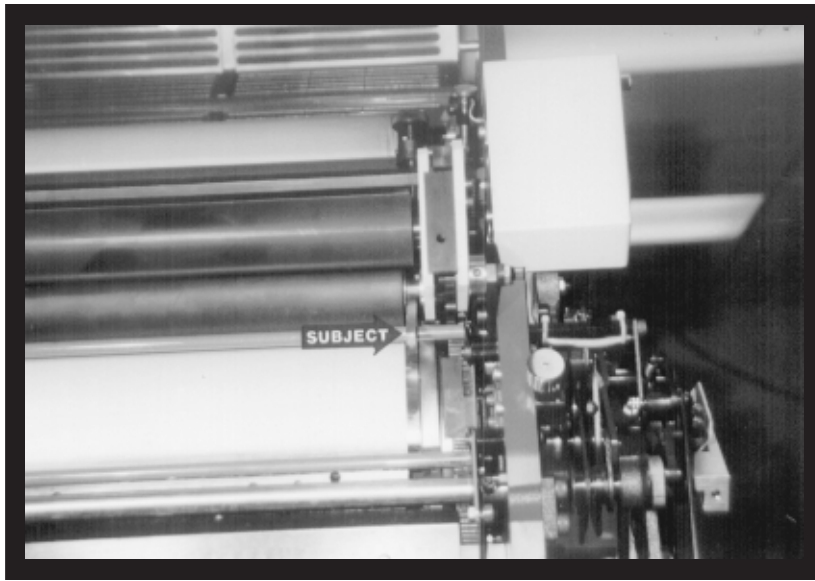

FINAL ADJUSTMENTS

1

FORM ROLLER LIFT AND GEAR MESH

Make sure the single lever is in the OFF position adjust the dampener lift as follows. Take the provided gap tool and insert between the plate cylinder surface and the under-side of the water form roller shaft. Adjust the eccentric in the connecting link until the proper lift off the plate is obtained and fully tighten the lock bolt. Do this at the OPS and NOPS.

2

INSTALLATION OF ROLLERS

Install the rollers in the following order:

1. Oscillator in slot indicated by left hand subject arrow.
2. Hard intermediate roller in slot indicated by right hand subject arrow. Place pin in set collar to the NOPS.
3. Soft intermediate (same size as hard intermediate) above hard roller. Again, pin in set collar to NOPS.
4. Metering roller beneath thumb screws. Pin in collar should be resting against angle block, towards the ink rollers.

3

MOUNT PLATES AND INK UP THE DAMPENER

Mount plates to both cylinders. Dab some ink on the dampener oscillator and idle the press for a while to distribute the ink on the dampener rollers.

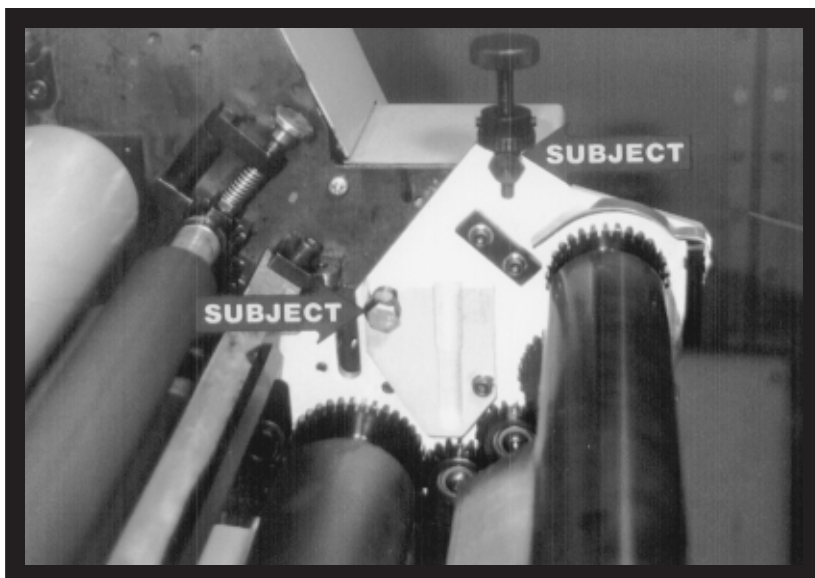
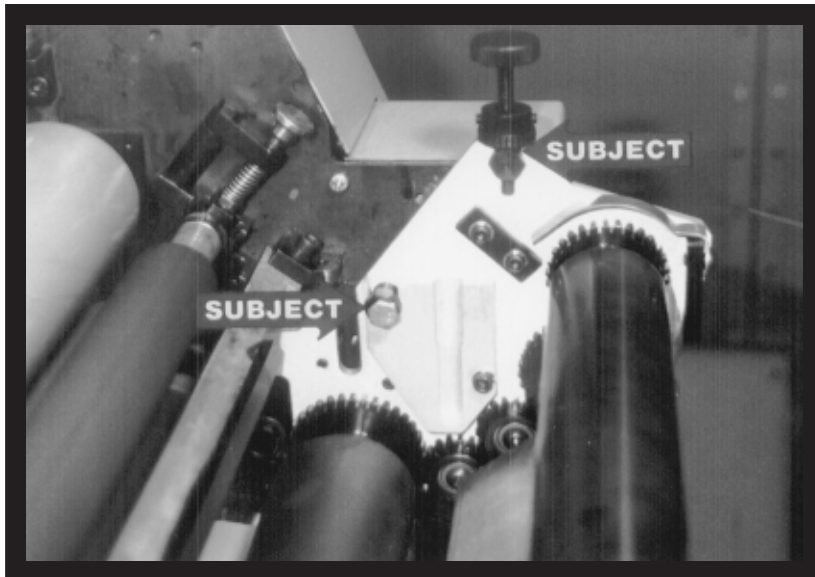

FINAL ADJUSTMENTS

4

FORM ROLLER TO PLATE CYLINDER PRESSURE

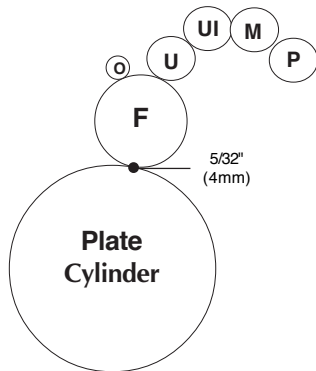

Shut the press off and drop the water form to the plate and back off again. (Form drops by moving single lever handle to water position). The form pressure to the plate should be set at $5/32''$. (Dropping the form to the plate leaves an ink stripe). Adjust the water form knobs (same ones used to adjust molleton form) until an even $5/32''$ stripe is achieved. Lock the position of the knobs with the small set screws. A stripe card is provided for your convenience.

5

MAXIMUM METERING TO PAN ROLLER PRESSURE

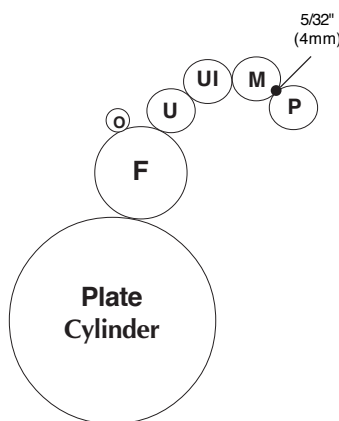

(Rollers are not shown in the picture) Spin the ratchet gear (which is not attached to the thumb screw at this time) down until it stops against the stud (upper subject arrow). Tighten the thumb screw until pressure is applied between the metering and pan rollers. Idle the press for 20 seconds, then let it sit for 20 seconds. Jogging the press forward reveals a roller pressure stripe. It should be $3/16''$. Adjust the thumb screws until a $3/16''$ stripe is obtained. Lock the ratchet gear to the thumb screw with the two small set screws.

6

METERING TO INTERMEDIATE PRESSURE

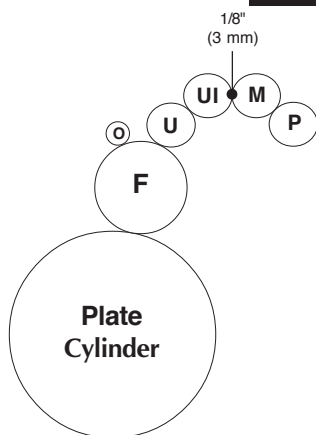

Adjust the metering to upper intermediate pressure by using the hanger eccentric (lower subject arrow). To view the stripe, idle the press for 20 seconds and then let it sit for 20 seconds. Drop the water form to the plate then rotate the press backwards and view the stripe on the metering roller. The stripe needs to be viewed in this manner because the dampener has clutches that prevent it from rotating backwards. Dropping the water form to the plate friction drives the dampener backwards. Adjust the eccentric until an even $1/8''$ stripe is obtained.

Also see page 40 for a special diagram explaining how to set this pressure.

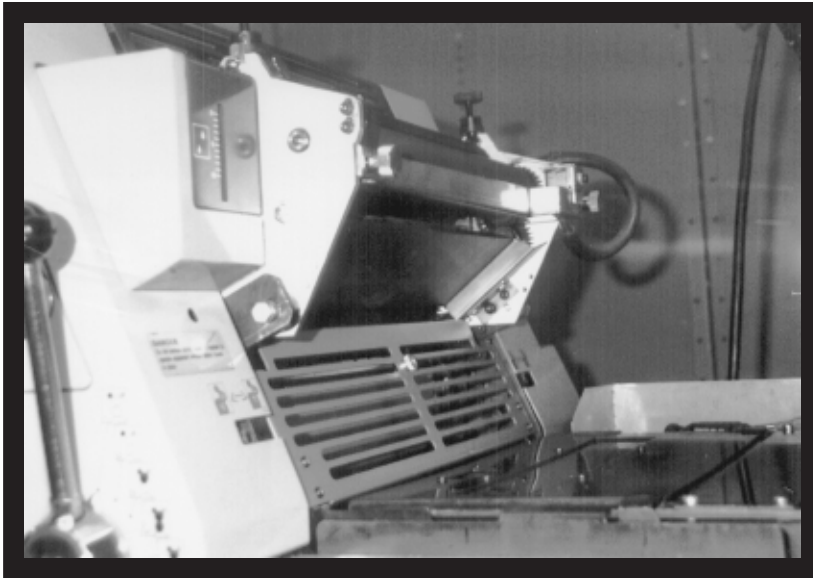

FINAL ADJUSTMENTS

7

Install the water pan and bottle. Set the water level in the pan by adjusting the bottle bracket. Raising the bracket will raise the pan level and vice-versa. Water should be about halfway up the pan.

8

Reinstall the covers on the press.

YOU ARE NOW READY TO PRINT.

BASIC OPERATION

START OF DAY

- A. Make sure the oscillator, lower intermediate and metering rollers are in place.
- B. Spin knurled knobs until the shoulder on the ratchet stops against the stud bar.
- C. Place water bottle in bracket.

NOTE: Accel recommends using the proper fountain solution for the plate material being run on the press. A good acid/gum etch should be used with metal plates.

- D. Mount plate to cylinder. Wipe down all plates before running. Pre-ink the Crestline® dampener before running the plates with an extremely light coverage of ink. Dab the ink on the oscillator only.

RUNNING DURING THE DAY

- A. In general, the Crestline® Dampener should not have to be adjusted from job to job. The form roller setting should never be changed unless it has deviated from the factory specification of 5/32" to the plate.
- B. Adjustments to the amount of water fed to the plate are made by the knurled knobs that apply pressure to the metering roller. The dampener has been set up for minimum water. To increase the water to the plate, turn the knurled knobs counter clockwise 1 or 2 clicks at a time. This opens the gap between the metering and pan rollers and allows more water to the plate.
- C. In general, more water will only be required when going from a metal plate to an electrostatic or silvermaster type plate.

CLEANING & MAINTENANCE

WASH UPS DURING THE DAY

1. Remove bottle and drain the excess water from the pan.
 2. Mount a metal plate to the press.
 3. Turn on the press and squirt a small amount of press wash on the ink rollers.
 4. Drop both the dampener and ink forms to the plate. it will be necessary to drop the forms manually rather than by the single lever. In general, the dampener will pick up enough roller wash off the plate to clean itself. Apply wash directly to the dampener only when necessary.
 5. Use wash up attachment as normal. The plate cylinder is being used as a bridge between the dampener and inker. Solution transfers from the dampener to the plate, plate to inker, and inker to wash up attachment.
 6. Remove water pan and clean any solution left in it.
 7. Be sure to wipe excess clean up solution from the ends of the dampener metering and pan rollers.
-

END OF THE DAY

1. Wash up dampener. Pay close attention to cleaning the ends of the pan and metering rollers that extend past the form rollers.
2. Spin the knurled knobs up until the metering roller can be removed.
3. Remove metering roller and wipe down thoroughly to remove any excess wash that may be on the roller.

CLEANING & MAINTENANCE

DEGLAZING THE DAMPENER

Periodic deglazing of water-soluble contaminants will be necessary with the Crestline®. Typically, once every 2-3 weeks is sufficient, unless you are running electrostatic plates on a daily basis, whereas deglazing should be performed weekly. A 50/50 solution of household ammonia and hot water can be used for deglazing purposes. If you prefer a commercially available deglazer, avoid those containing pumice or gritty substances. Always follow deglazing with straight water and then roller wash.

OILING AND GREASING THE DAMPENER

- A. Place a small amount of grease on the gears once a month.
- B. Inject grease into the oscillator grease fitting one a month.

CLEANING & MAINTENANCE

CRESTLINE® CLEANING & MAINTENANCE CHART

	Daily	Weekly	Bi-Weekly	Monthly
Wash Rollers	✓			
Deglaze Rollers				
Metal Plate Users			✓	
Silvermaster Plate Users			✓	
Electrostatic Plate Users		✓		
Grease Gears				✓
Inspect Ball Bearings				✓
Check Roller Pressures				✓
Check Roller Surfaces				✓

RYOBI 3302/ITEK 3985/AB DICK 3985

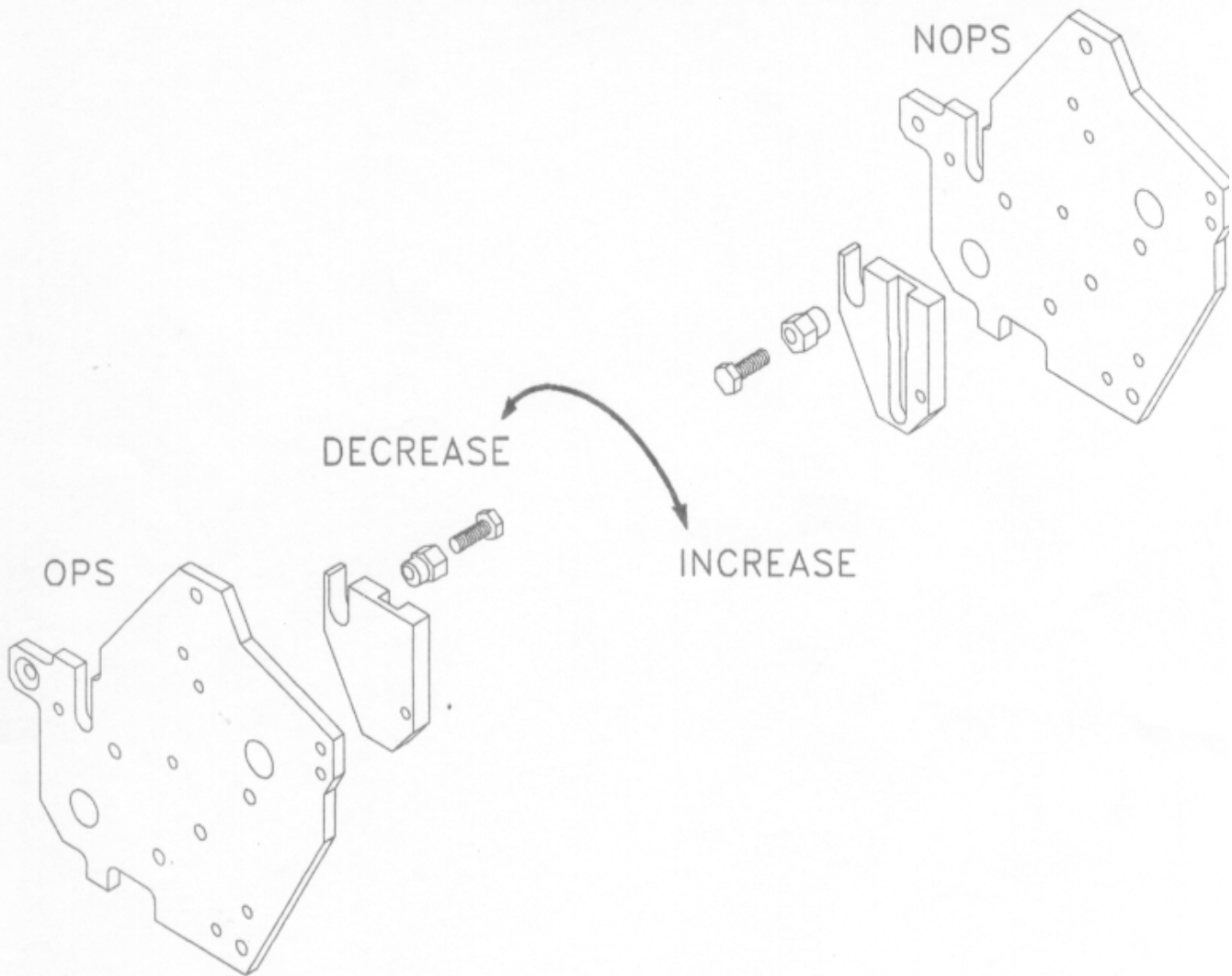

When adjusting the upper intermediate roll to the metering roll, turn the eccentrics in the direction indicated to set the stripe. The stripe between the intermediate and metering roll should be 1/8".

RY332-OPS

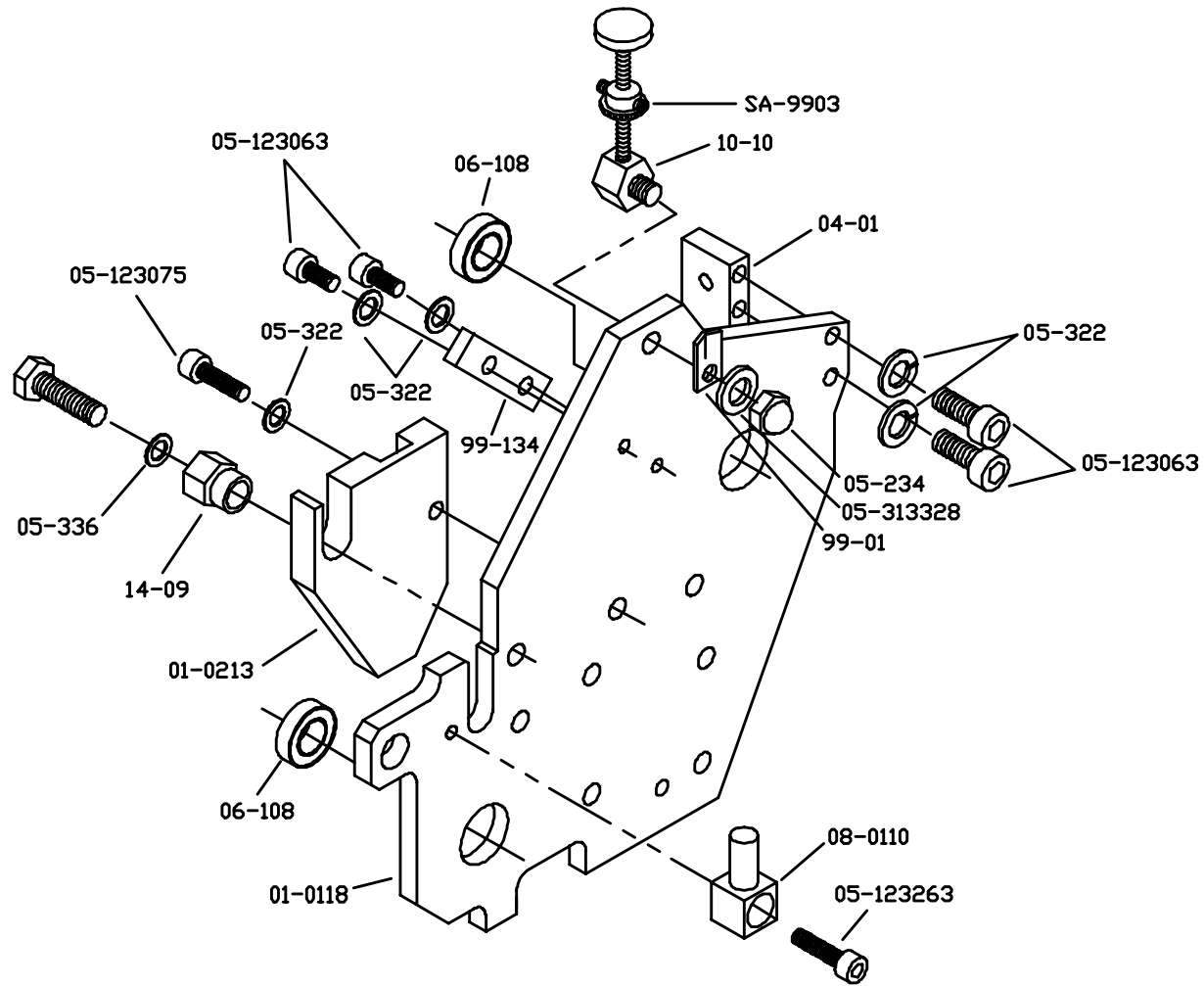

RY332-NDPS

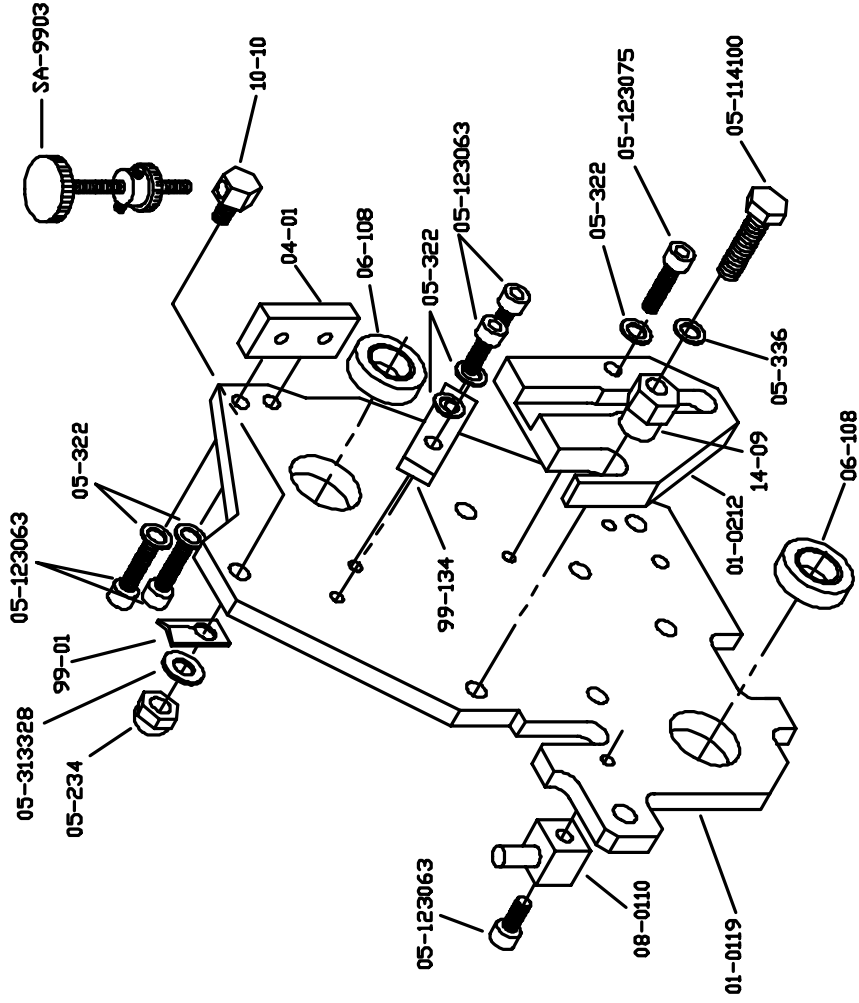

RY332

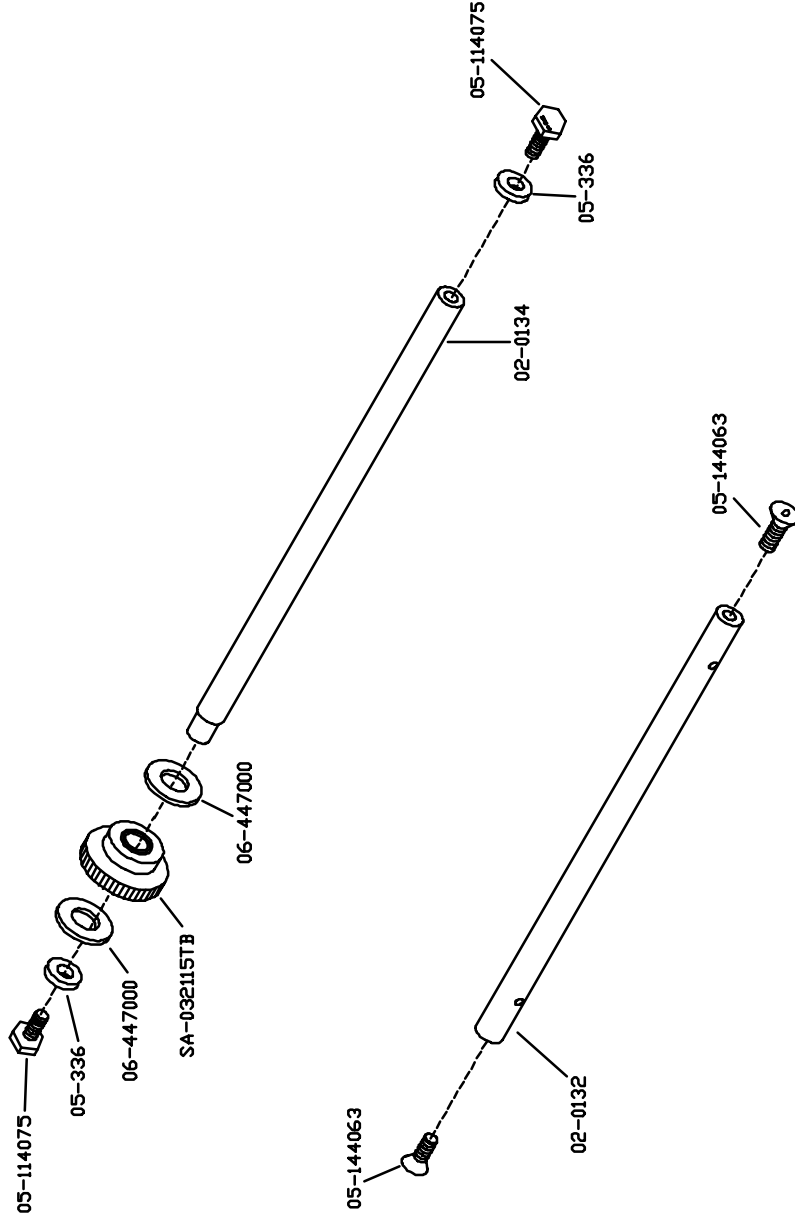

BLDW6, 7-93

RY332

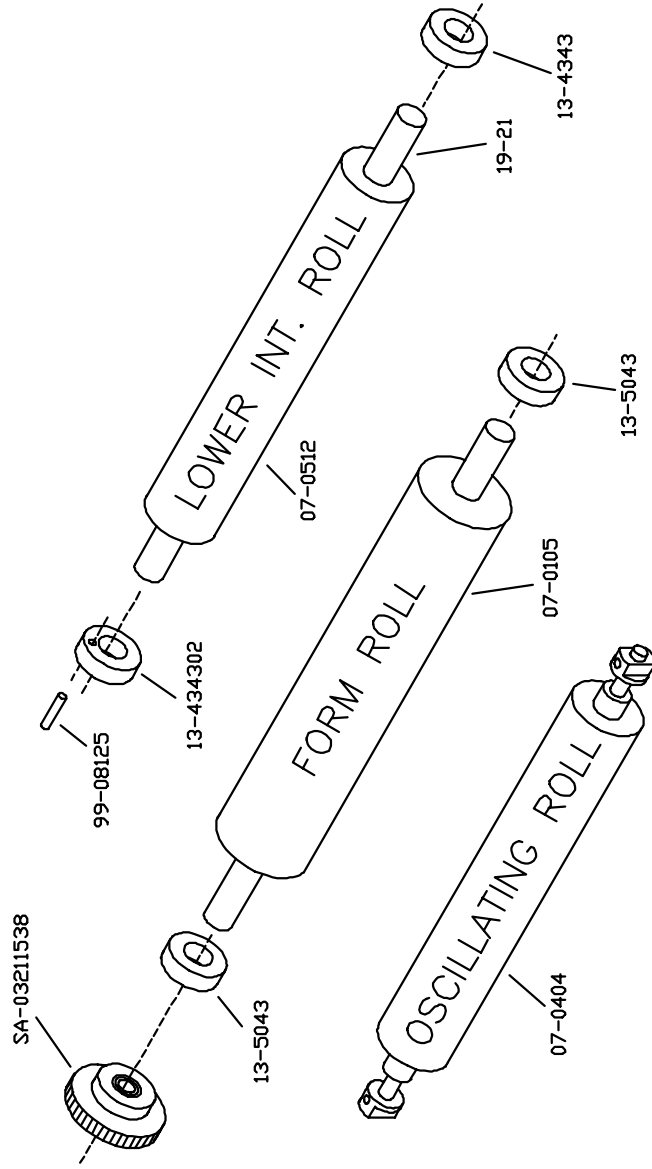

RY332

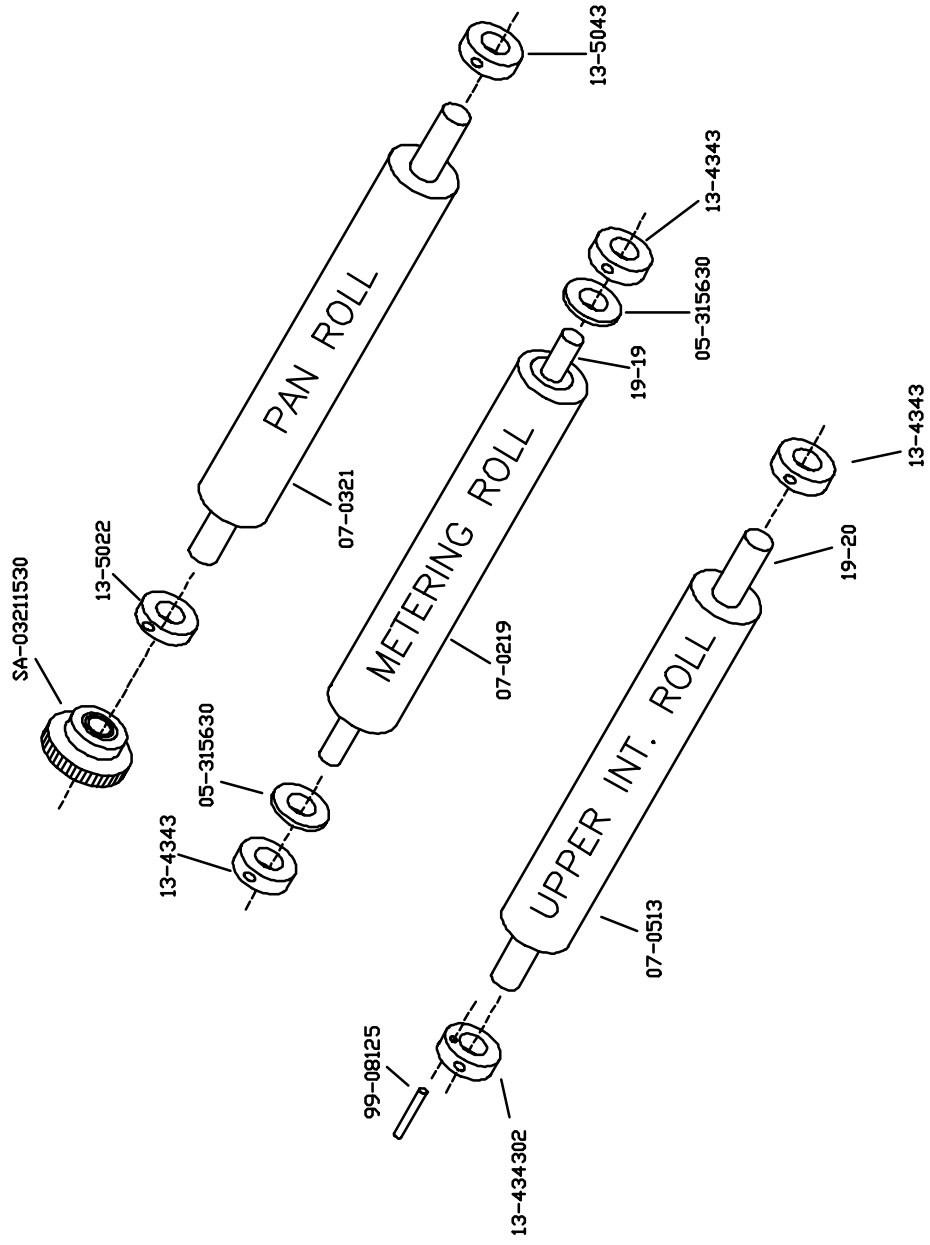

RY332-NOPS

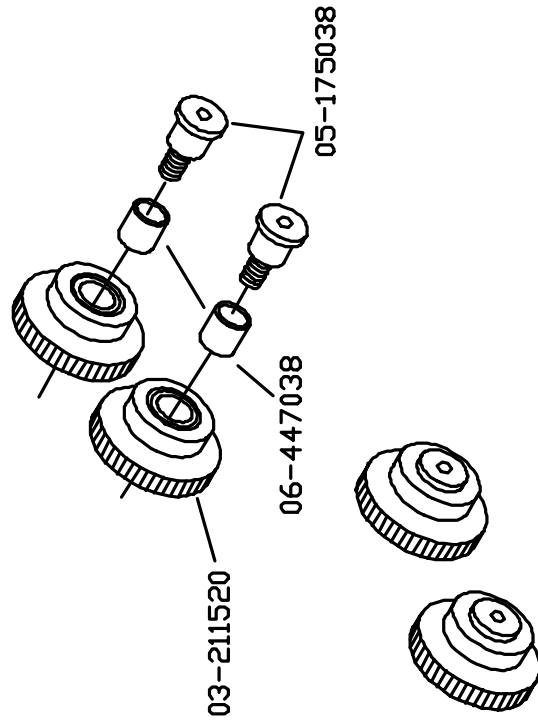

RY332

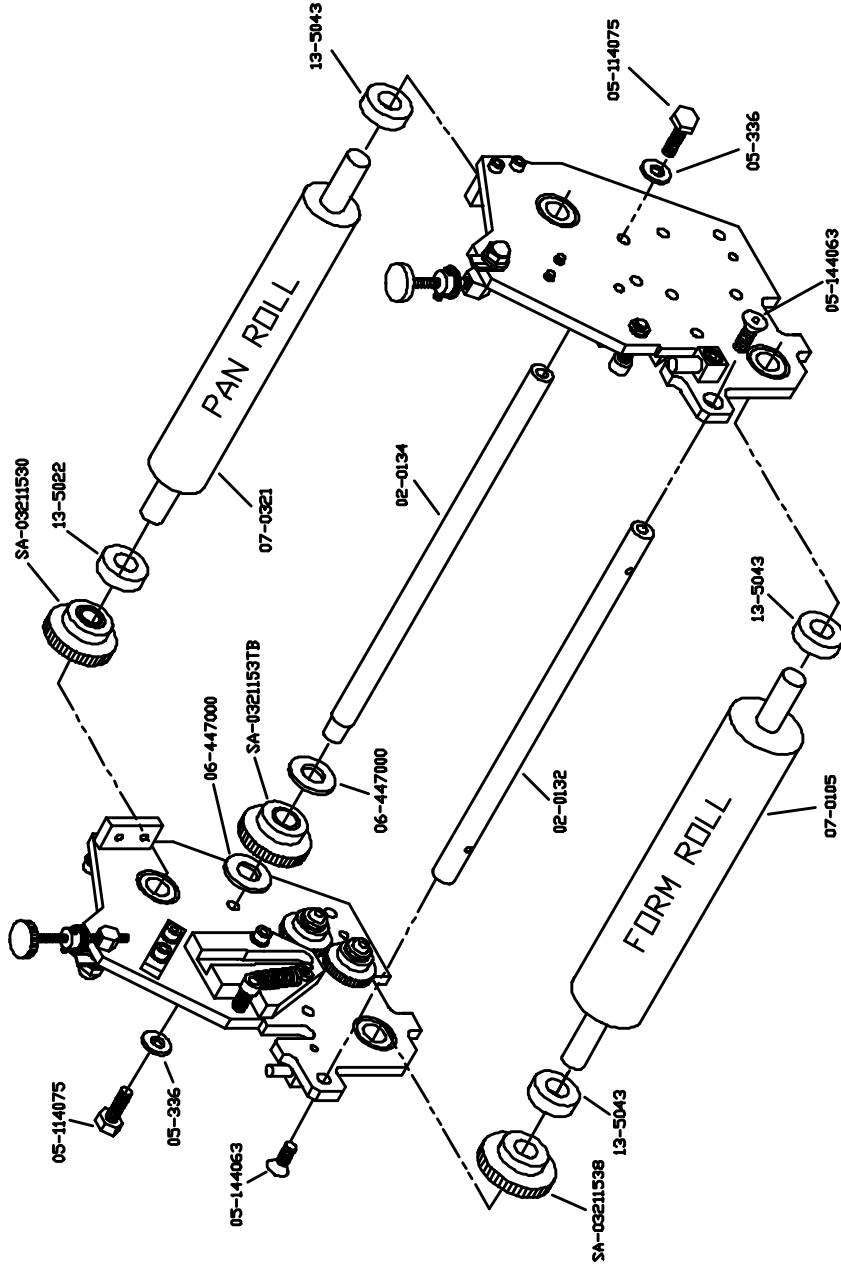

RY332

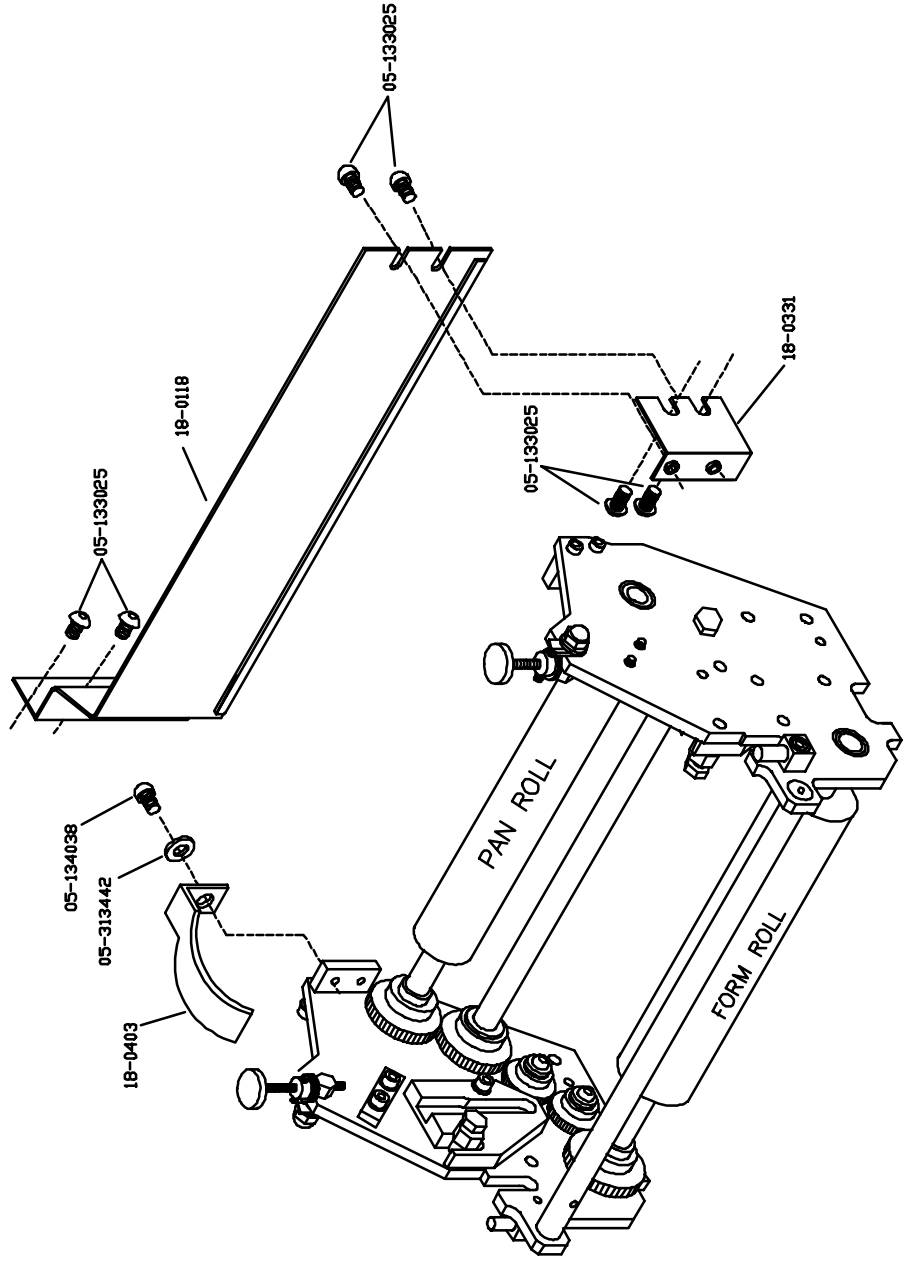

RY332

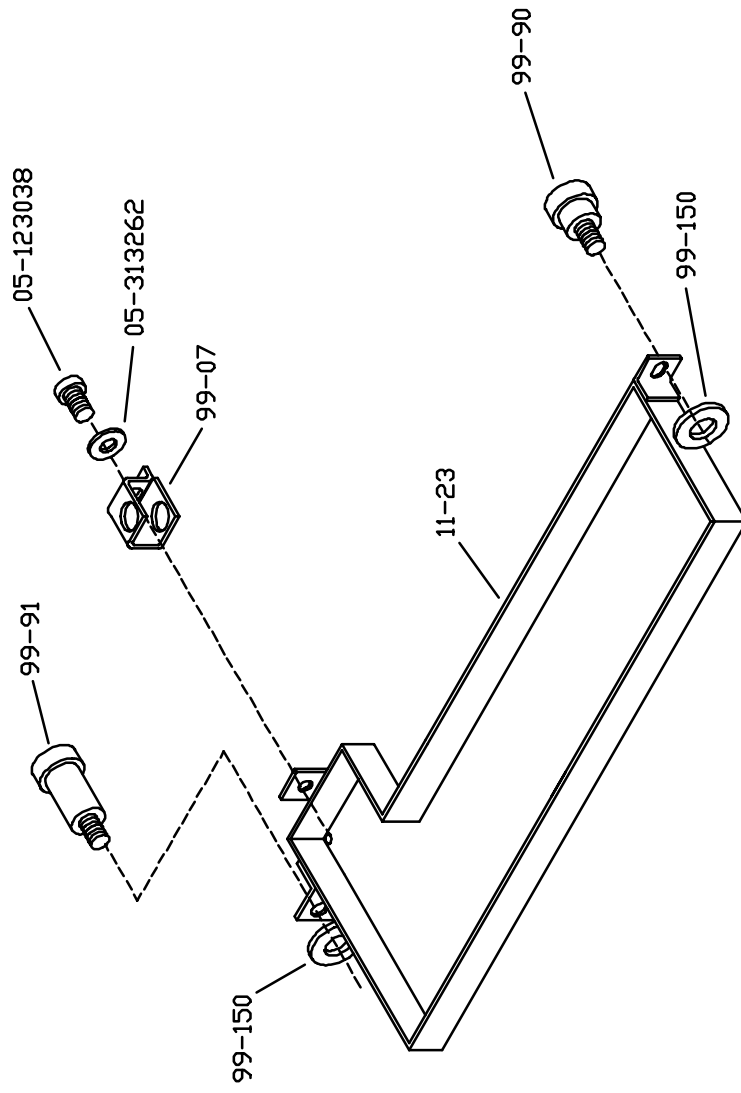

RYOBI 3302

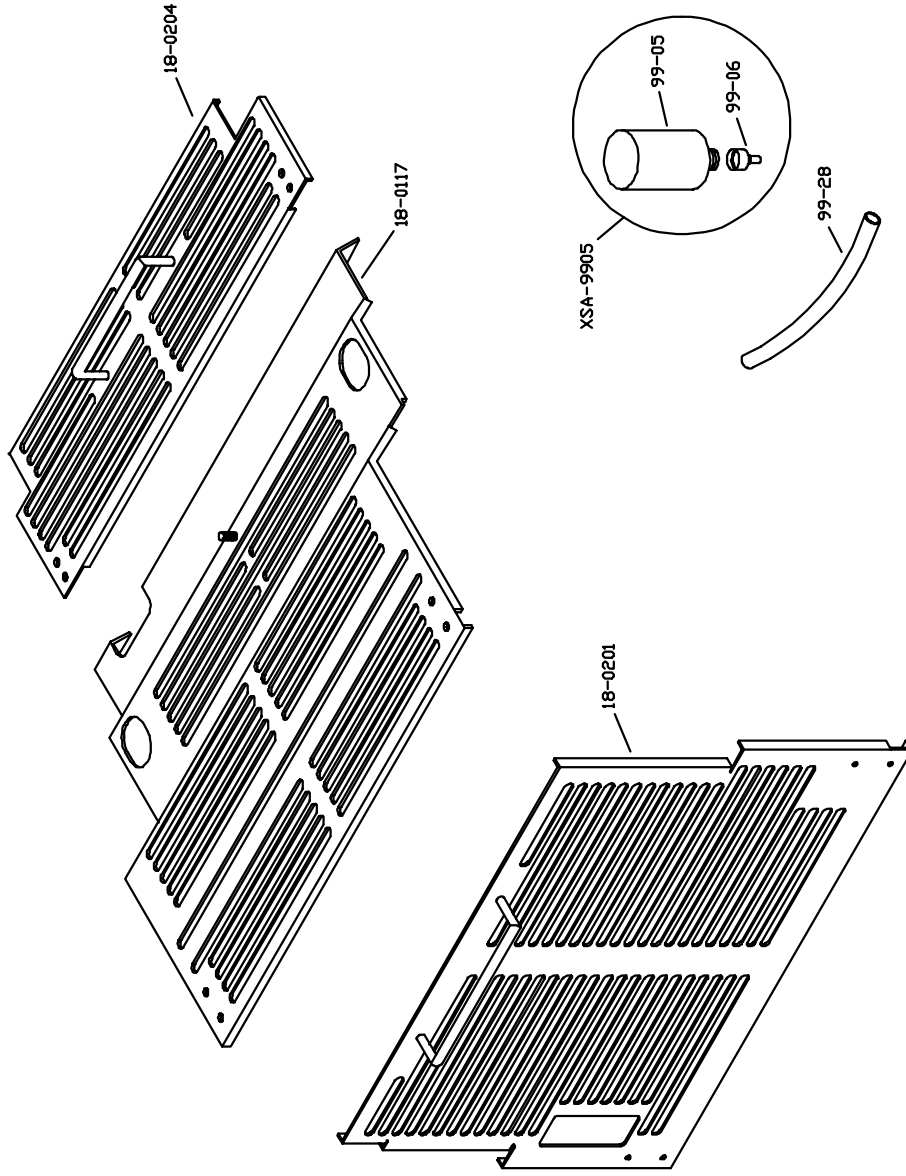

ACCEL  [®]
Graphic Systems

11103 Indian Trail, Dallas, TX 75229 Phone 972-484-6808, Fax 800-365-6510
E-mail accel@dallas.net, Web Site www.accelgraphicsystems.com