

**NOT MEASUREMENT
SENSITIVE**

**JSSG-2010-7
30 October 1998
SUPERSEDING
(See 6.2)**

DEPARTMENT OF DEFENSE JOINT SERVICE SPECIFICATION GUIDE



CREW SYSTEMS CRASH PROTECTION HANDBOOK

**This specification guide handbook is for guidance only.
Do not cite this document as a requirement.**

AMSC

15GP

DISTRIBUTION STATEMENT A. Approved for public release; distribution is unlimited.

JSSG-2010-7

FOREWORD

JSSG RELEASE NOTE

The specification guides support the acquisition reform initiative, and is predicated on a performance based business environment approach to product development. As such it is intended to be used in the preparation of performance specifications. It is one of a set of specification guides. It is the initial release of this guide. In this sense this document will continue to be improved as the development program is accomplished.

1. This specification guide handbook is approved for use by all Departments and Agencies of the Department of Defense (DoD).
2. This Joint Service Specification Guide (JSSG) handbook, in conjunction with its companion JSSGs handbooks, is intended for use by Government and Industry program teams as guidance in developing program unique specifications. This handbook is for guidance only. This handbook cannot be cited as a requirement. If it is, the contractor does not have to comply. This document may not be placed on contract.
3. The complete set of JSSGs, and their respective handbooks, establish a common framework to be used by Government-Industry Program Teams in the Aviation Sector for developing program unique requirements documents for Air Systems, Air Vehicles, and major Subsystems. Each JSSG contains a compilation of candidate references, generically stated requirements, verification criteria, and associated rationale, guidance, and lessons learned for program team consideration. The JSSGs identify typical requirements for a variety of aviation roles and missions. By design, the JSSG sample language for "requirements" and "verification criteria" are written as generic templates, with blanks that need to be completed in order to make the requirements meaningful. Program teams need to review the JSSG rationale, guidance, and lessons learned to: (1) determine which requirements are relevant to their application; and (2) fill in the blanks with appropriate, program-specific requirements.
4. This document is Part 2 of two parts. Part 1 of the JSSG-2010 is a template for developing the program unique performance specification. As a generic document, it contains requirement statements for the full range of aviation sector applications. It must be tailored to delete non-applicable requirements to form the program unique specification. In addition, where blanks exist, these blanks must be filled in for the program unique specification to form a complete and consistent set of requirements to meet program objectives. Part 2 of the JSSG-2010 is a handbook which provides the rationale, guidance, and lessons learned relative to each statement in Part 1. The section 4, verification requirements, must be tailored to reflect an understanding of: (1) the design solution; (2) the identified program milestones; (3) the associated level of maturity which is expected to be achieved at those milestones; and (4) the specific approach to be used in the design and verification of the required products and processes. It must be recognized that the rationale, guidance, and lessons learned are not only generic in nature, but also document what has been successful in past programs and practices. This must not be interpreted to limit new practices, processes, methodologies, or tools.
5. Beneficial comments (recommendations, additions, deletions) and any pertinent data which may be of use in improving this document should be addressed to: ASC/ENSID, Bldg. 560, 2530 Loop Road West, Wright-Patterson AFB OH 45433-7101, by using the Standardization Document Improvement Proposal (DD Form 1426) appearing at the end of this document or by letter.

JSSG-2010-7

CONTENTS

PARAGRAPH	PAGE
1. SCOPE	1
1.1 Scope	1
2. APPLICABLE DOCUMENTS.....	1
2.1 General.	1
2.2 Government documents.	1
2.2.1 Specifications, standards, and handbooks.	1
2.2.2 Other Government documents, drawings, and publications.....	9
2.3 Non-Government publications.	9
2.4 Order of precedence.	10
3. REQUIREMENTS	10
3.1 Aircrew Systems Engineering (see JSSG-2010-1).	10
3.2 Crew Systems Automation, Information, and Control/Display Management (see JSSG-2010-2).....	10
3.3 Cockpit/Crew Station/Cabin (see JSSG-2010-3).	10
3.4 Aircrew Alerting (see JSSG-2010-4).....	10
3.5 Aircraft Lighting (see JSSG-2010-5).....	10
3.6 Sustenance and Waste Management (S&WM) Systems Requirements (see JSSG-2010-6).....	10
3.7 Crash Survivability.	10
3.7.1 Aircraft crash protection envelope.	17
3.7.2 Occupant exposure limits to crash hazards.	26
3.7.3 System functional requirements.	45
3.7.3.1 Pre-crash warning.	46
3.7.3.2 Contact injury protection.....	47
3.7.3.2.1 Preservation of occupied space.	56
3.7.3.2.2 Seat structural integrity and occupant retention.	64
3.7.3.2.3 Cargo and Ancillary Equipment Retention.....	93
3.7.3.3 Acceleration Injury Protection.....	98
3.7.3.3.1 Impact Energy Management.....	115
3.7.3.4 Post-Crash Injury Protection.....	121
3.7.3.5 Emergency Egress System	134
3.7.3.5.1 Emergency Exits.....	137
3.7.3.5.2 Emergency Egress Routes	139
3.7.3.5.3 Localized Entrapment Prevention	141
3.7.3.6 Crash Data Recording.....	143
3.7.3.7 Aircraft Integration and System Interfaces.....	145
4. VERIFICATIONS (SEE REQUIREMENTS).....	147
5. DEFINITIONS	147

JSSG-2010-7

CONTENTS

PARAGRAPH	PAGE
6. NOTES	147
6.1 Intended use.....	147
6.2 Supersession data.....	147
6.3 Subject term (key word) listing.....	148

TABLES

Table I. Crash Impact Design Conditions, With Landing Gear Extended, For Military Rotorcraft And Light Fixed-Wing Aircraft.	18
Table II. 95 th Percentile Velocity Changes For Survivable Class A And B Mishaps.	19
Table III. Human Tolerance Limits To Acceleration.....	32
Table IV. Abbreviated Injury Scale (AIS) And Sample Injury Types For Two Body Regions.....	33
Table V. Recommended Military Lumbar Tolerance Levels.	34
Table VI. Recommended Military Injury Assessment Test Methods.	43
Table VII. Occupant Restraint Harness Strength Requirements (See Mil-Std-1290).....	69
Table VIII. Seat Crash Load Factors.	74
Table IX. Cockpit Seat Design And Static Test Requirements.	84
Table X. Typical Aviator Weights	87
Table XI. Troop And Gunner Weights	87
Table XII. FAA Summary Seat Dynamic Performance Standards	90
Table XIII. Operational Energy Absorbers.....	103
Table XIV. V-22 Crashworthiness Trade Options.....	118
Table XV. Rotorcraft Crashworthiness Comparison	120
Table XVI. Crash Resistant Fuel System Materials Comparison.....	131
Table XVII. Summary Of Design Velocities For Rotary And Light Fixed Wing Aircraft	133

JSSG-2010-7

CONTENTS

PARAGRAPH	PAGE
FIGURES	
Figure 1. Crash Resistant Features for Rotorcraft - MIL-STD-1290.....	13
Figure 2. Aircraft Coordinate and Attitude Directions.	20
Figure 3. Impact Attitude Envelope for Rotary-Wing and Light Fixed Wing Aircraft.....	20
Figure 4. Comparison of Survivable Impact Velocity Changes For Army, Navy, and Civil Rotorcraft.	23
Figure 5. Comparison of Vertical Velocity Change at Major Terrain Impact vs Cumulative Frequency of Occurrence for Survivable Mishaps.	24
Figure 6. NATO Designated Directions of Accelerative Forces on Body.	29
Figure 7. Duration and Magnitude of Headward Acceleration (EIBAND).	30
Figure 8. Duration and Magnitude of Spineward Acceleration (EIBAND).	31
Figure 9. Table of Injury Assessment Values for Hybrid III ATD And HIC Injury Risk Curve. ...	37
Figure 10. IARV Curves for Axial Neck Tension and Compression Loading.....	38
Figure 11. IARV Curves For Neck Shear Loading and Fracture of Patella, Femur, or Pelvis. ...	39
Figure 12. Occupant Strike Envelope with Lap Belt Only Restraint.	50
Figure 13. Occupant Strike Envelope with Shoulder Harness and Lap Belt.	51
Figure 14. Inflatable Body And Head Restraint System (above) and Cockpit Airbag System (below).....	55
Figure 15. MIL-S-58095 Five-Point Restraint Harness Configuration	67
Figure 16. Comparison of Lap Belt Only Versus Lap Belt–Shoulder Restraint Protection.	70
Figure 17. Troop Seat Restraint Configurations	71
Figure 18. View of MA-6 Inertia Reel’s Ratchet/Pawl Assembly.	78
Figure 19. View of MA-6 Inertia Reel’s Damaged Ratchet Teeth.	79
Figure 20. Seat Forward Load-Deflection Requirements for All Types of Rotorcraft and Light Fixed-Wing Aircraft.....	85

JSSG-2010-7

CONTENTS

PARAGRAPH	PAGE
Figure 21. Dynamic Test Parameters for Military Rotary-Wing and Light Fixed-Wing Aircraft..	86
Figure 22. Floor and Bulkhead Misalignment Diagrams for Military Seats.....	89
Figure 23. Forward Load-Displacement for Energy Absorbing Cargo Restraint.	97
Figure 24. Cargo Lateral Load-Displacement Requirements.....	98
Figure 25. Relative Frequency of Spinal Injuries vs. Change in Vertical Velocity	100
Figure 26. Occupant Response (Ride-Down) Curve	107
Figure 27. Typical Vertical Response Parameters of 50th Percentile Hybrid III ATD at 20 G Peak; 7.625 m/s Velocity Change	108
Figure 28. Recommended Stress-Strain Corridors for Cushion Materials	111
Figure 29. V-22 Crashworthiness Trade Study Approach.....	117
Figure 30. Schematic of V-22 Energy Management System	119
Figure 31. Comparison of Fuel System Injury Patterns	130
Figure 32. Distribution of Flight Mishaps According to Helicopter Series.....	132
Figure 33. Factors to be Included in a Time-Line Analysis for Underwater Emergency Egress From a Helicopter	135

JSSG-2010-7

1. SCOPE**1.1 Scope.**

This handbook establishes guidance for the development requirements and verifications for occupant crash protection and for crash protective aspects of seating, restraint, and crewstation and passenger/troop station design. This handbook is for guidance only. This handbook cannot be cited as a requirement. If it is, the contractor does not have to comply.

2. APPLICABLE DOCUMENTS**2.1 General.**

The documents listed below are not necessarily all of the documents referenced herein, but are the ones that are needed in order to fully understand the information provided by this handbook.

2.2 Government documents.**2.2.1 Specifications, standards, and handbooks.**

The following specifications, standards, and handbooks form a part of this document to the extent specified herein. Unless otherwise specified, the issues of these documents are those listed in the latest issue of the Department of Defense Index of Specifications and Standards (DoDISS) and supplement thereto.

NUMBER	TITLE	TYPE
MIL-STD-1290	LIGHT FIXED AND ROTARY-WING AIRCRAFT CRASH RESISTANCE	(Canceled)
ADS-36	ROTARY WING AIRCRAFT CRASH RESISTANCE	AERONAUTICAL DESIGN STANDARD
USAAVSCOM 89-22 A THROUGH-22E	AIRCRAFT CRASH SURVIVAL DESIGN GUIDE <ul style="list-style-type: none"> • VOL. I: Design Criteria and Checklists • VOL. II: Aircraft Design Crash Impact Conditions and Human Tolerance • VOL. III: Aircraft Structural Crash Resistance • VOL. IV: Aircraft Seats, Restraints, Litters, and Cockpit/Cabin Delethalization • VOL. V: Aircraft Postcrash Survival 	TECHNICAL REPORT

JSSG-2010-7

SD-24	GENERAL SPECIFICATION FOR DESIGN AND CONSTRUCTION OF AIRCRAFT WEAPON SYSTEMS	LETTER OF ISSUANCE
MIL-STD-1807	CRASH SURVIVABILITY OF AIRCRAFT PERSONNEL	
FAR PART 23	AIRWORTHINESS STANDARDS: NORMAL, UTILITY, ACROBATIC, AND COMMUTER CATEGORY AIRPLANES	FEDERAL AVIATION REGULATIONS
FAR PART 25	AIRWORTHINESS STANDARDS: TRANSPORT CATEGORY AIRPLANES	FEDERAL AVIATION REGULATIONS
FAR PART 27	AIRWORTHINESS STANDARDS: NORMAL CATEGORY ROTORCRAFT	FEDERAL AVIATION REGULATIONS
FAR PART 29	AIRWORTHINESS STANDARDS: TRANSPORT CATEGORY ROTORCRAFT	FEDERAL AVIATION REGULATIONS
ADS-24	CRASHWORTHY DESIGN PRINCIPLES	AERONAUTICAL DESIGN STANDARD
REPORT NO. FAA-ED-18-6 JUNE 1982	AIRCRAFT CRASHWORTHINESS/ STRUCTURAL AIRWORTHINESS	FAA TECHNICAL CENTER ENGINEERING AND DEVELOPMENT PLAN
ADS-11	SURVIVABILITY PROGRAM ROTARY WING	AERONAUTICAL DESIGN STANDARD
B-86-SE-03-H000 GEORGIA INSTITUTE OF TECHNOLOGY CENTER OF EXCELLENCE FOR ROTARY WING AIRCRAFT TECHNOLOGY MEETING ON CRASHWORTHY DESIGN	SURVIVABILITY AND CRASHWORTHINESS DESIGN CRITERIA	
J.D. CRONKHITE, PRESENTED AT AHS CRASHWORTHY DESIGN OF ROTORCRAFT MEETING, ATLANTA, GEORGIA, APR 1986	DESIGN OF AIRFRAME STRUCTURES FOR CRASH IMPACT	
DTIC AD-A212606	THE DESIGN OF HELICOPTER CRASHWORTHINESS	PAPER
MIL-STD-1530	AIRCRAFT STRUCTURAL INTEGRITY PROGRAM, AIRPLANE REQUIREMENTS	
AR-56	STRUCTURAL DESIGN REQUIREMENTS (HELICOPTERS)	AERONAUTICAL REQUIREMENTS

JSSG-2010-7

MIL-A-8863	AIRPLANE STRENGTH AND RIGIDITY, GROUND LOADS FOR NAVY REQUIRED AIRPLANES	
MIL-A-8865	AIRPLANE STRENGTH AND RIGIDITY- MISCELLANEOUS LOADS	
MIL-A-8867	AIRPLANE STRENGTH AND RIGIDITY- GROUND TESTS	
AGARD-AG-306	OCCUPANT CRASH PROTECTION IN MILITARY IN MILITARY AIR TRANSPORT	
NTSB-AAS-81-2	SPECIAL STUDY-CABIN SAFETY IN LARGE TRANSPORT AIRCRAFT	SPECIAL STUDY
DOT/FAA/CT-82-118	CRASH INJURY PROTECTION IN SURVIVABLE AIR TRANSPORT ACCIDENTS- CIVIL AIRCRAFT EXPERIENCE 1970 TO 1978	REPORT
FAA AC 21-22	INJURY CRITERIA FOR HUMAN EXPOSURE TO IMPACT	ADVISORY CIRCULAR JUNE 20, 1985
NBDL-89R003	GUIDELINES FOR SAFE HUMAN EXPOSURE TO IMPACT ACCELERATION	Update A New Orleans, LA: Naval Biodynamics Laboratory, 1989
SAE PAPER 851847	HUMAN INJURY CRITERIA RELATIVE TO CIVIL AIRCRAFT SEATS AND RESTRAINT SYSTEMS	PAPER
SAE J885	HUMAN TOLERANCE TO IMPACT CONDITIONS AS RELATED TO MOTOR VEHICLE DESIGN	SAE Information Report, July 1986
ISBN Number: 1-56091-499-8	HEAD AND NECK INJURY	1994, SAE order number: P-276
ISBN Number: 1-56091-363-0	BIOMECHANICS OF IMPACT INJURY AND INJURY TOLERANCES OF THE HEAD-NECK COMPLEX	1993, SAE order number: PT-43
MEMORANDUM REPORT AAC-119-81-8 CIVIL AEROMEDICAL INSTITUTE FAA, 1983	LOADS MEASURED DURING PASSENGER SEAT TESTS	MEMORANDUM REPORT
PROCEEDINGS OF THE EIGHTEENTH STAPP CAR CRASH CONFERENCE, SAE, pp 303-338	EFFECT OF HEAD AND BODY POSITION AND MUSCULAR TENSING AN RESPONSE TO IMPACT	PAPER

JSSG-2010-7

PROCEEDINGS OF THE FIFTEENTH STAPP CAR CRASH CONFERENCE, SAE, 1971, pp 207-255	STRENGTH AND RESPONSE OF THE HUMAN NECK	PAPER
DOT/FAA/CT-90/24	A LITERATURE SURVEY OF AIRBORNE VEHICLES IMPACTING WATER AND SOIL: HEAD INJURY CRITERIA AND SEVERITY INDEX DEVELOPMENT OF COMPUTER PROGRAM KRASH	FINAL REPORT
ISBN 0-8139-0634-2 THE UNIVERSITY PRESS OF VIRGINIA	AIRCRAFT CRASHWORTHINESS	BOOK
USAARL REPORT NO. 93-15	BASIC PRINCIPLES OF HELICOPTER CRASHWORTHINESS	REPORT
Vol. 60, pp 112-121, Aviation Space and Environmental Medicine, February, 1989	KINEMATICS OF U.S. ARMY HELICOPTER CRASHES: 1979-1980	PAPER
NADC 88106-60	THE NAVAL AIRCRAFT CRASH ENVIRONMENT: AIRCREW SURVIVABILITY AND AIRCRAFT STRUCTURAL RESPONSE	REPORT
DYNAMIC SCIENCE 1500-71-43	A SURVEY OF NAVAL AIRCRAFT CRASH ENVIRONMENTS WITH EMPHASIS ON STRUCTURAL RESPONSE	REPORT
MIL-STD-1333	AIRCREW STATION GEOMETRY FOR MILITARY AIRCRAFT	
MIL-STD-1776	AIRCREW STATION AND PASSENGER ACCOMMODATIONS	
MIL-STD-1472	HUMAN ENGINEERING DESIGN CRITERIA FOR MILITARY SYSTEMS, EQUIPMENT AND FACILITIES	
MIL-STD-1800	HUMAN ENGINEERING PERFORMANCE, REQUIREMENTS FOR SYSTEMS	
NACA TN 4158 (FEB 1958)	ACCELERATIONS IN TRANSPORT-AIRPLANE CRASHES	

JSSG-2010-7

NACA TN 2991 (1953)	ACCELERATIONS AND PASSENGER HARNESS LOADS MEASURED IN FULL SCALE, LIGHT AIRPLANE CRASHES	
FAA-RD-77-188 (FEB. 1977)	FULL SCALE CRASH TEST EXPERIMENTAL VERIFICATION METHOD OF A METHOD ANALYSIS FOR GENERAL AVIATION CRASHWORTHINESS	
TI-83402 U.S. DEPARTMENT OF TRANSPORTATION, FEDERAL AVIATION ADMINISTRATION TECHNICAL CENTER	DEVELOPMENT OF ROTORCRAFT CRASH SCENARIOS	REPORT
MIL-STD-210	CLIMATIC INFORMATION TO DETERMINE DESIGN AND TEST REQUIREMENTS FOR MILITARY SYSTEMS AND EQUIPMENT	
QSTAG-360	CLIMATIC ENVIRONMENTAL CONDITIONS AFFECTING THE DESIGN OF MILITARY MATERIEL	QUADRIPARTITE STANDARDIZATION
MIL-S-58095	SEAT SYSTEM: CRASH RESISTANT, NON-EJECTION, AIRCREW, GENERAL SPECIFICATION FOR	
SAE TECHNICAL PAPER NO. 850853	THE DEVELOPMENT OF DYNAMIC PERFORMANCE STANDARDS FOR GENERAL AVIATION AIRCRAFT SEATS	TECHNICAL PAPER
SAE TECHNICAL PAPER NO. 850851	DATA FOR THE DEVELOPMENT OF CRITERIA FOR GENERAL AVIATION SEAT AND RESTRAINT SYSTEM PERFORMANCE	TECHNICAL PAPER
MIL-R-8236	REEL, SHOULDER HARNESS, INERTIA LOCK	
MIL-R-81729	RESTRAINT SYSTEM, AIRCREWMAN'S	
MIL-R-85510	SEATS, HELICOPTER CABIN, CRASHWORTHY, GENERAL SPECIFICATION FOR	
MIL-S-26688	SEAT, PASSENGER, AFT FACING, TRANSPORT AIRCRAFT	

JSSG-2010-7

MIL-S-81771	SEAT SYSTEM; AIRCREW, GENERAL SPECIFICATION FOR	
MIL-S-7852	SEAT, AIRCREW, ADJUSTABLE SWIVEL, TYPE E-1	
SAE AEROSPACE STANDARD 8049	PERFORMANCE STANDARD FOR SEATS IN CIVIL ROTORCRAFT AND TRANSPORT AIRPLANES	SAE AEROSPACE STANDARD
ADVISORY CIRCULAR NO. 23.562-1	DYNAMIC TESTING OF PART 23 AIRPLANE SEAT/RESTRAINT SYSTEMS AND OCCUPANT PROTECTION	ADVISORY CIRCULAR (JUNE 22, 1989)
ADVISORY CIRCULAR NO. 25.562-1	DYNAMIC EVALUATION OF SEAT RESTRAINT SYSTEMS AND OCCUPANT PROTECTION ON TRANSPORT AIRPLANES	ADVISORY CIRCULAR (MARCH 6, 1990)
MIL-S-25073	SEAT, AIRCRAFT	
MIL-S-5804	SEAT, AIRCRAFT, WALL-STYLE	
MIL-S-27174	SEAT, TROOP, VARIABLE SEATING WIDTH	
TSO-C114	TORSO RESTRAINT SYSTEM	FAA TECHNICAL STANDARD ORDER
SAE AEROSPACE STANDARD 8043	TORSO RESTRAINT SYSTEM	SAR AEROSPACE STANDARD
MIL-S-7877	SEAT PASSENGER, CABIN FOLDING	
MIL-B-8437	BELT, AIRCRAFT SAFETY, LAP, TROOP, MC-1A	
MIL-B-83787	BELTS, AIRCRAFT SAFETY, LAP, TROOP, TYPES MD-1 AND MD-2	
MIL-A-83469	ADJUSTER, LAPBELT, 13/4 WEBBING	
MIL-B-8242	BELT, SAFETY, LAP, TROOP, TYPE C-3A	
MIL-B-5428	BELT, SAFETY, SHOULDER, HARNESS, TROOP, TYPE, D-2	
MIL-H-5364	HARNESS, SHOULDER SAFETY, GENERAL SPECIFICATION FOR	
MIL-W-4088	WEBBING, TEXTILE, WOVEN NYLON	

JSSG-2010-7

MIL-W-25361	WEBBING, TEXTILE, POLYESTER, LOW ELONGATION	
MIL-A-21165	ADAPTERS, QUICK DISCONNECT, PASSENGER SEAT TO FLOOR	
MIL-F-8905	FITTINGS AND CARGO RINGS, TIE-DOWN AIRCRAFT FLOOR	
MIL-STD-209	SLINGING AND TIEDOWN PROVISIONS FOR LIFTING AND TYING DOWN MILITARY EQUIPMENT	
MIL-F-87168	FIRE AND EXPLOSION HAZARD PROTECTION SYSTEMS, AIRCRAFT, GENERAL SPECIFICATION FOR	
MIL-HDBK-221	FIRE PROTECTION DESIGN HANDBOOK FOR U.S. NAVY AIRCRAFT POWERED BY TURBINE ENGINES	
MIL-27422	TANK, FUEL, CRASH-RESISTANT, AIRCRAFT	
SER-13298; SIKORSKY, 31 AUGUST 1977	CRASHWORTHY FUEL SYSTEM DESIGN CRITERIA	ref from REPORT ON ANALYSIS OF H-53 FUEL SYSTEM CRASHWORTHINESS
USAAVLABS TR-71-8 (AD723988)	CRASHWORTHY FUEL SYSTEM DESIGN CRITERIA AND ANALYSIS	TECHNICAL REPORT
AD-A217 575 (DTIC)	AIRCRAFT FIRE SAFETY	AGARD CONFERENCE PROCEEDINGS No. 467
JOURNAL OF AHS, 1979	DESIGN AND TESTING OF FLOAT LANDING GEAR SYSTEMS FOR HELICOPTERS	PAPER
DOT/FAA/CT-84/3 (FEB 1984)	STUDY OF TRANSPORT AIRPLANE UNPLANNED WATER CONTACT	
NACA-TR-1347 (1958)	DITCHING INVESTIGATIONS OF DYNAMIC MODELS AND EFFECTS OF DESIGN PARAMETERS ON DITCHING CHARACTERISTICS	TECHNICAL REPORT
SAFE SYMPOSIUM PROCEEDINGS 1995, pp142-151	DEVELOPMENT OF A PASSENGER AIRCRAFT AIRBAG SYSTEM	PAPER

JSSG-2010-7

SAFE SYMPOSIUM PROCEEDINGS 1994, pp 66-73	ADVANCED TECHNOLOGY FOR ROTARY-WING AIRCRAFT CRASHWORTHINESS	PAPER
SAFE SYMPOSIUM PROCEEDINGS 1994, pp 157-163	MODEL OF AND ERGONOMICALLY DESIGNED HELICOPTER SEAT	PAPER
SAFE SYMPOSIUM PROCEEDINGS 1993, pp 356-365	HELICOPTER TROOP SEATS: THE PRESENT AND THE FUTURE	PAPER
SAFE SYMPOSIUM PROCEEDINGS 1993, pp 288-297	RECENT HELICOPTER INFLATABLE RESTRAINT DEVELOPMENTS	PAPER
SAFE SYMPOSIUM PROCEEDINGS 1992, pp 246-253	NAVAL AIRCRAFT CRASH SIMULATION USING PROGRAM KRASH	PAPER
SAFE SYMPOSIUM PROCEEDINGS 1991, pp 63-80	STRUCTURAL TESTING OF COMMERCIAL ROTORCRAFT SEATS: AN OVERVIEW	PAPER
SAFE SYMPOSIUM PROCEEDINGS 1990, pp 196-202	STANDARDIZATION OF NATOPS EMERGENCY EGRESS PROCEDURES	PAPER
SAFE SYMPOSIUM PROCEEDINGS 1990, pp 84-89	INERTIA REELS FOR AIRCREW RESTRAINT SYSTEMS	PAPER
SAFE SYMPOSIUM PROCEEDINGS 1987, pp 190-195	ENERGY ABSORBING SYSTEM DESIGN AND EVALUATION USING A DISCRETE ELEMENT MODEL OF THE SPINE	PAPER
SAFE SYMPOSIUM PROCEEDINGS 1986, pp 264-269	DELETHALIZED CYCLIC CONTROL STICK	PAPER
SAFE SYMPOSIUM PROCEEDINGS 1986, pp 147-152	H-46 HELICOPTER EMERGENCY FLOTATION SYSTEM (HEFS)	PAPER
SAFE SYMPOSIUM PROCEEDINGS 1986, pp 80-87	KOCH EMERGENCY EGRESS LIGHTING SYSTEMS FOR ADVERSE OPTICAL CONDITIONS FOR MILITARY AND COMMERCIAL AIRCRAFT AND OTHER APPLICATIONS	PAPER
SAFE SYMPOSIUM PROCEEDINGS 1985, pp 76-80	RETROFIT ENERGY-ABSORBING CREWSEAT FOR SH-3 (S-61 SERIES SEA KING HELICOPTER	PAPER
SAFE SYMPOSIUM PROCEEDINGS 1985, pp 137-140	ADVANCEMENTS IN INERTIA REELS FOR FIXED SEATING AIRCRAFT	PAPER

JSSG-2010-7

SAFE SYMPOSIUM PROCEEDINGS 1983, pp 66-74	HELICOPTER CRASH SURVIVABILITY AND EMERGENCY ESCAPE	PAPER
SAFE SYMPOSIUM PROCEEDINGS 1980, pp 196-201	TEST AND EVALUATION OF IMPROVED AIRCREW RESTRAINT SYSTEMS	PAPER
SAFE SYMPOSIUM PROCEEDINGS 1980, pp 202-208	DESIGN OF A CRASHWORTHY CREW SEAT FOR BOEING VERTOL CHINOOK HELICOPTER	PAPER
SAFE SYMPOSIUM PROCEEDINGS 1980, pp 209-215	CRASHWORTHY MILITARY PASSENGER SEAT DEVELOPMENT	PAPER
SAFE SYMPOSIUM PROCEEDINGS 1980, pp 216-220	HASEP SURVIVAL FROM CRASHED NAVY HELICOPTERS	PAPER
SAFE SYMPOSIUM PROCEEDINGS 1980, pp 106-109	A NEW SAFETY HARNESS FOR MOBILE AIRCREW	PAPER
SAFE SYMPOSIUM PROCEEDINGS 1980, pp 16-24	EMERGENCY IN-FLIGHT OPENING FOR GENERAL AVIATION AIRCRAFT	PAPER
SAFE SYMPOSIUM PROCEEDINGS 1976, pp 132-136	USAF EXPERIENCE IN AIRCRAFT ACCIDENT SURVIVABILITY	PAPER
SAFE SYMPOSIUM PROCEEDINGS 1971, pp 114-123	METHOD FOR IMPROVING HELICOPTER CREW AND PASSENGER SURVIVABILITY	PAPER

(Unless otherwise indicated, copies of the above specifications, standards, and handbooks are available from the Standardization Document Order Desk, 700 Robbins Ave., Bldg 4D, Philadelphia PA 19111-5094.)

2.2.2 Other Government documents, drawings, and publications.

The following other Government documents, drawings, and publications form a part of this document to the extent specified herein.

SOCIETY OF AUTOMOTIVE ENGINEERS (SAE)

SAE 942482 Racing Car Restraint System Frontal crash Performance Testing

SAE 962522 Investigation of Indy Car Crashes Using Impact Recorders

(Application for copies should be addressed to the Society of Automotiver Engineers, Inc, 400 Commonwealth Dr., Warrendale PA 15096-0001.)

2.3 Non-Government publications.

The following document(s) form a part of this document to the extent specified herein. Unless otherwise specified, the issue of the documents which are DoD adopted are those listed in the issue of the DoDISS, and supplement thereto.

JSSG-2010-7

Computation of the Effective Intensity of Flashing Lights, C. Douglas, Illuminating Engineer, Vol 52, No.12, Dec 1957

2.4 Order of precedence.

In the event of a conflict between the text of this document and the references cited herein, the text of this document takes precedence. Nothing in this document, however, supersedes applicable laws and regulations unless a specific exemption has been obtained.

3. REQUIREMENTS

3.1 Aircrew Systems Engineering (see JSSG-2010-1).

3.2 Crew Systems Automation, Information, and Control/Display Management (see JSSG-2010-2).

3.3 Cockpit/Crew Station/Cabin (see JSSG-2010-3).

3.4 Aircrew Alerting (see JSSG-2010-4).

3.5 Aircraft Lighting (see JSSG-2010-5).

3.6 Sustenance and Waste Management (S&WM) Systems Requirements (see JSSG-2010-6).

3.7 Crash Survivability.

The crash protection system shall provide means for protecting aircraft occupants (i.e. pilots, aircrew, troops, and passengers) from severe and fatal injuries caused by acceleration and contact forces, fire, toxic gases, submersion, and other hazards associated with crash survivable aircraft crashed. The system shall also provide occupants both the time and the means to egress rapidly and safely, once the aircraft has come to rest. In addition, survival and rescue equipment on-board the aircraft shall be protected from crash damage so that occupants can readily access the equipment after a crash to support post-crash survival, enemy evasion, and rescue. The system may consist of both autonomous elements integrated into the aircraft solely for the purpose of providing crash protection, as well as aircraft structural and subsystem elements modified to enhance occupant crash protection. The system shall be integrated into the aircraft to achieve efficient overall protection for aircraft occupants, while limiting cost and weight penalties to acceptable levels. The system's performance requirements are defined in this document within the following three areas:

- a. Aircraft crash protection envelope
- b. Occupant exposure limits to crash hazards
- c. System functional elements

The Crew Systems Specification Guide defines overall performance requirements for occupant crash protection, and detailed performance requirements for crash resistant seating and restraint systems. The Subsystems Specification Guide must be applied for detailed performance requirements of aircraft subsystems which contribute to crash protection including crash resistant fuel systems, energy absorbing landing gear, crash resistant cargo restraint

JSSG-2010-7

systems, and aircraft floatation systems. The Airframe Specification Guide must be applied for detailed performance requirements regarding structural crash resistance of the airframe, as well as for structural interfaces with crash protection subsystems.

REQUIREMENT RATIONALE (3.7)

The occupant crash protection system defined in this handbook is required to eliminate injuries and fatalities in relatively mild impacts, and minimize them in severe, survivable mishaps. Minimizing personnel losses in crashes conserves the military's human resources, reduces medical and disability expenses, provides a positive morale factor, and thereby improves the effectiveness of the services both in peacetime and in periods of conflict. Military and civil research and field experience have shown that the initial cost and weight increases associated with incorporating crash protection features are offset by the cost-benefits of reduced personnel injury and reduced structural damage over an aircraft's life cycle. Consequently, new generation aircraft are now procured under a requirement to implement a systems design approach in the development of occupant crash protection.

REQUIREMENT GUIDANCE (3.7)

A successful crashworthiness design is one that protects occupants from serious injury in potentially survivable crashes while limiting weight increase, costs, and additional maintenance to acceptable levels. Under-design of the system results in unexpected injuries and deaths while over-design of these elements result in unnecessary costs and weight. To avoid either eventuality, the author of the design specification, as well as the designer, should thoroughly understand:

- a. Potentially survivable crash conditions and characteristics for the type of aircraft under consideration.
- b. Human kinematic response to input accelerations.
- c. Human tolerance to abrupt accelerations.
 - (1) Whole body
 - (2) Regional (i.e., head, neck, abdomen, femur)
 - (3) Human variability in anthropometry and impact tolerance
- d. Injury mechanisms.
- e. Performance, weight, cost, and cost-benefits of crash protection features/subsystems
- f. The affect of aircraft configuration/design features on aircraft crash response and occupant survivability potential.

The most effective crash protective systems are ones where the design specifications were based on a correct prediction of the crash environment and an accurate assessment of human exposure limits.

Since a protective system cannot protect occupants in all crashes under all anticipated conditions, trade-off decisions have to be made in the development of protective system design specifications. In general, there are four inter-related factors that need to be considered in making these trade-off decisions.

- a. Anticipated survivable crash impact conditions (input variables) - velocity, force, attitude.

JSSG-2010-7

- b. Maximum acceptable injury level, and life cycle cost savings of reduced injuries and fatalities
- c. Host restrictions - space, weight, hard-point availability.
- d. Life cycle cost for all elements of the crash protective system.

The weight given to each factor depends on the particular aircraft application. When retrofitting a protective system into an existing aircraft, for example, host restrictions (integration constraints) and cost are usually the dominant factors since the new protective system must adapt to existing space and hard points, and costs are invariably fixed. In new aircraft designs, host restrictions are usually more flexible and can be adapted as necessary to accommodate the desired protection systems. However, in new aircraft programs the portion of available funds allocated to safety systems is not fixed, and safety and protective equipment must compete for weight and cost with all other aircraft systems. In this climate, program managers can be reluctant to trade performance for safety.

As implied above, cost and host restrictions tend to drive the decision making process in protective system implementation. However, the first two technical factors of the four listed above can easily be overlooked in the process. A thorough understanding of all four factors is absolutely imperative for making informed trade-off decisions.

Design of an appropriate protective system also requires an understanding of the crash and occupant survivability history for the specific aircraft application under consideration. This information can be estimated from a collective analysis of the crash history of similar class aircraft (i.e. type, size, gross weight, and mission) over an extended period of time. This analysis can then complement other analytical methods for determining the required crash protection envelope including impact velocities, attitudes, and surfaces.

Ultimately, the “right” level of crash protection for a particular application is determined by balancing the four crash design considerations cited above. Once that level has been determined, a systems approach is recommended for developing the crash protection system based on the principles provided in MIL-STD-1290. Though MIL-STD-1290 was developed primarily for helicopters and light fixed wing aircraft, the “general crash survivability design factors” discussed in that document, and summarized below, form the foundation for crashworthiness design approaches in all aircraft types.

- a. Airframe protective shell.
- b. High mass component, equipment and cargo retention strength.
- c. Occupant acceleration environment.
- d. Occupant environment hazards.
- e. Post-crash hazards.

The MIL-STD-1290 factors are listed here to acknowledge their importance, and each of these factors is further covered in designated sections of this Handbook. Figure 1 provides a schematic picture of the design features associated with a MIL-STD-1290 crash resistant rotorcraft configuration.

JSSG-2010-7

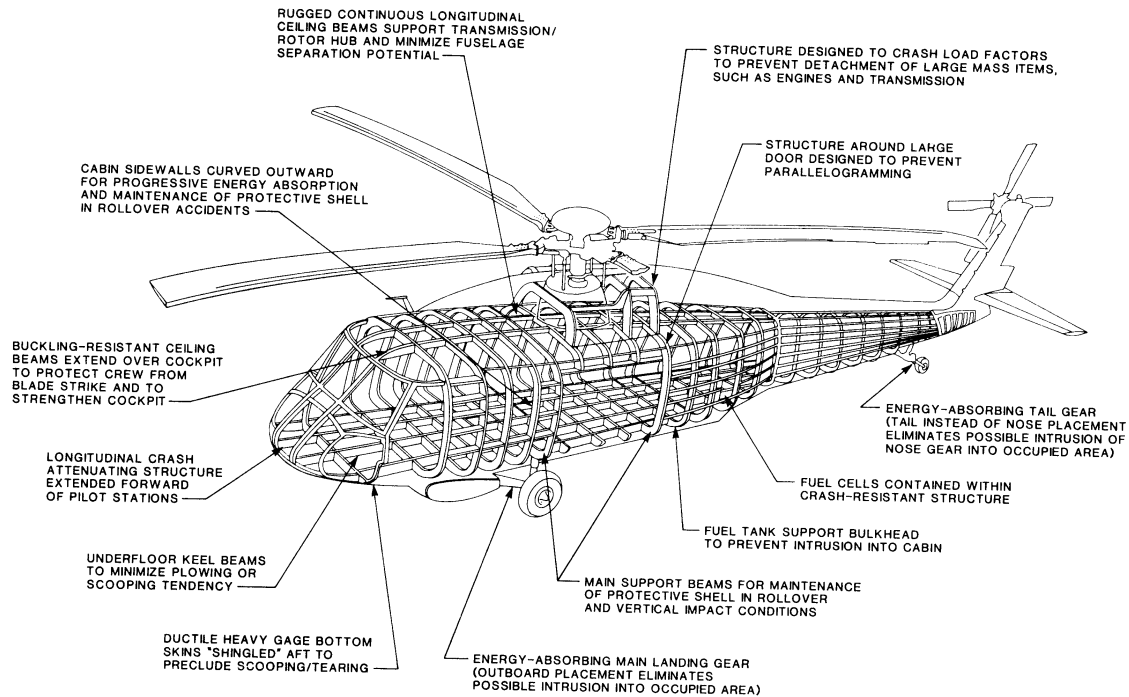


FIGURE 1. Crash resistant features for rotocraft - MIL-STD-1290.

REQUIREMENT LESSONS LEARNED (3.7)

Although the basic principles of crashworthiness in military aviation were known prior to 1960, it was at this time that the U.S. Army Transportation Research Command initiated a long-range program to study all aspects of aircraft safety and survivability. The Aviation Safety Engineering and Research (AvSER) Division of the Flight Safety Foundation, Inc., was contracted to investigate the problems associated with occupant survival in aircraft crashes. Specific relationships between crash forces, structural failures, crash fires, and injuries were studied. The investigations included mishap analyses, full-scale drop tests of 1960's era aircraft, and design/development of crash protection systems. In 1965, the U.S. Army consolidated the series of reports generated during the study into the first edition of the "Crash Survival Design Guide", TR 67-22. The design guide has been revised and expanded four times to incorporate the results of continuing research in crash resistance technology. Much of the follow-on research during the 1970's and 1980's was conducted in cooperation with other government agencies and industry. For example, the NASA -LANGLEY Drop Test Facility was used extensively to conduct full-scale drop tests of such helicopters as the CH-47, UTTAS Black Hawk, BELL Apache prototype, and both configurations of the all composite aircraft program, (ACAP). The Civil Aeromedical Institute (CAMI) was actively involved during this period with crash testing of military crash seating systems. Also, the U.S. Navy pursued occupant crash protection during this time with efforts in the areas of crash resistant seating,

JSSG-2010-7

restraint systems, and energy absorption devices. Navy crash testing was conducted on a sled system based on a hydraulically controlled, pneumatically actuated ram cylinder and a Drop Tower Facility. Efforts during those early days concentrated on development of components and subsystems. The third edition of the design guide was the basis for MIL-STD-1290, Light Fixed-and Rotary Wing Aircraft Crash Resistance. It was this document which formally set a "systems design" approach to the development of an aircraft crash protection system. A more extensive review of the history of crashworthiness can be found in Chandler's paper entitled "Development of Crash Injury Protection in Civil Aviation", 1993 Accidental Injury, Biomechanics and Prevention, Nahum and Melvin, and Waldock's paper entitled, "A Brief History of Crashworthiness", 1997 SAFE Symposium Proceedings.

The Army's Black Hawk and Apache were the first operational aircraft to have crashworthiness as a major design objective. The Crash Survival Design Guide provided the primary design guidance for both of these aircraft. In 1974 the design objectives enumerated in the Crash Survival Design Guide were incorporated into MIL-STD-1290 which was intended to provide crashworthiness design requirements for all future Army helicopters. The Navy's H-60 series aircraft were also based on the Crash Survival Design Guide, but the energy absorbing landing gear requirement was omitted in deference to the Navy's primary "over-water" mission. The success of Black Hawk and Apache in reducing injury in severe crashes has been documented by Shanahan in, "Kinematics of U.S. Army Helicopter Crashes: 1979-1985", Aviation Space Environmental Medicine, 1989 and in "Injury in U.S. Army Helicopter Crashes: 1979-1985, Journal of Trauma, 1989.

In the area of commercial transport crash safety, the Federal Aviation Administration (FAA) conducted several full-scale crash tests of transport category aircraft in the 1960's at the AvSER facility, namely, a Douglas DC-7 and a Lockheed 1690 Constellation. These tests were supported by the military and NASA with on-board experiments, including an early prototype air bag system and several versions of energy absorbing seat systems. More recently, the FAA and NASA jointly conducted a controlled impact demonstration (CID) "fly-in" crash test of a Boeing 720 aircraft, specifically to study a fuel anti-misting system.

Currently, the FAA's Technical Center at Pomona, NJ, and the Civil Aeromedical Institute (CAMI), Oklahoma City, OK are investigating commuter and transport category crash safety. Gowdy (DOT/FAA/AM-90/11: "Development of a Crashworthy Seat for Commuter Aircraft") discusses test results of several sled crash tests conducted on commuter-type seat systems subjected to the new FAR Part 23 dynamic crash pulse requirement.

General aviation category crashworthiness was investigated extensively at the NASA Langley Research Center primarily based on a series of full-scale drop tests of general aviation aircraft at NASA's Drop Test Facility. An SAE Paper, entitled, "Crashworthy Design Considerations for General Aviation Seats", summarizes this research on general aviation seat design and occupant crash response.

Based on the research work and field experience of first generation crashworthy military and civil aircraft discussed above, it has become well accepted in the aircraft regulatory, manufacturing, and user communities that crashworthiness is practical and effective when appropriately designed and integrated into aircraft. All of the crash resistant systems now required in civil aircraft were shown by the FAA to have positive economic cost-benefits when comparing the life cycle cost of implementation to reduced injury cost. Likewise, military crashworthiness systems have proven to provide positive returns on investment based on reduced injury cost, in addition to reducing the loss of one of the military's most valuable assets; their trained aviators.

JSSG-2010-7

4.7 Crash Survivability Verification

The crash protection system shall be incrementally verified throughout the entire development cycle of the aircraft. Verification of the crash protection system shall be demonstrated through the combination of structural analyses, computer crash simulations, static loads testing, and dynamic crash testing at both the subsystem and full-scale aircraft levels. The following incremental verifications shall be accomplished prior to the specified review:

a. System Requirements Review (SRR) - Verify that the air vehicle system specification requires occupant crash protection consistent with the aircraft type, mission requirements, and anticipated survivable crash scenarios. Verify that contract documentation (i.e., specifications, Systems Engineering Master Schedule, Work Breakdown Structure, Statement Of Work) address the major functional design considerations of the crash protection system by requiring appropriate analyses, trade studies, computer simulations, and tests.

b. System Functional Review (SFR) - Verify that the conceptual air vehicle design includes crash protection provisions that show a high probability for satisfying overall occupant protection requirements. Verify that top-level crash protection requirements for the air vehicle are appropriately flowed down and allocated at the subsystem level.

c. Preliminary Design Review (PDR) - Verify through review of trade studies and analyses that the preliminary air vehicle design complies with the occupant crash protection requirements. Verify that all component, subsystem test planning is consistent with the crash impact parameters specified, and that appropriate metrics are being applied to assess human injury levels.

d. Critical Design Review (CDR) - Verify that the final design configuration of the air vehicle and the draft technical data package provide the necessary capabilities to comply with the specified levels of occupant crash protection. Review results of Design Verification (DV) tests for compliance with performance requirements. Verify that planned qualification testing is consistent with the crash impact parameters, and that appropriate metrics are applied to assess human injury levels.

e. System Verification Review (SVR) - Verify that the production configuration of the air vehicle complies with the occupant crash protection requirements. Verification shall include a detailed review of production drawings and qualification test results.

Verification requirements of the Crew Systems Specification Guide shall be applied to verify overall occupant protection performance of the total system. Verification requirements of the Vehicle Subsystems Specification Guide shall be applied to verify performance of aircraft subsystems contributing to crash protection such as crash resistant fuel systems, energy absorbing landing gear, crash resistant cargo restraint, and aircraft flotation systems. Verification requirements of the Airframe Specification Guide shall be applied to verify crash resistant and energy absorbing capability of the airframe, and to verify structural interfaces with the applicable aircraft subsystems.

VERIFICATION RATIONALE (4.7)

Crash protection requirements significantly affect verification requirements for the overall air vehicle and its subsystems. Crash conditions are included in the verification requirements for major elements of an aircraft such as the airframe structure, landing gear, fuel system, cargo restraint, and seating systems. Incremental verification of the crash protection system is essential so that deficiencies can be identified early enough in the aircraft development process to permit timely resolution.

JSSG-2010-7

VERIFICATION GUIDANCE (4.7)

Development and integration of aircraft elements and subsystems that contribute to occupant crash protection should be tracked through the incremental verification process to reduce the risk of not achieving overall crashworthiness performance requirements. Verification shall progress from review of initial analytical predictions based on crash modeling and simulation, to subsystem static testing, subsystem dynamic testing, and ultimately full scale static load and dynamic crash testing. If full scale dynamic crash testing is prohibitive, crash modeling and simulation may be considered as an alternative. However, full scale crash testing is highly recommended whenever possible. One cost sensitive approach is refurbish and use the static load test article for dynamic crash testing once the static load tests are completed.

VERIFICATION LESSONS LEARNED (4.7)

Several examples can be noted which demonstrate the tendency to overlook the adverse effects which design changes can have on the crash protection system's effectiveness. For example, a vital component of the Army's UH-60 Black Hawk crew seat energy absorption (EA) system is a floor well, located beneath each of the crewseats. This feature allows the seat bucket to displace below floor level to maximize stroking distance without floor contact. In the Navy's SH-60B configurations, avionics hardware was installed inside the floor well, which has been found to reduce the effective stroking distance when sub-floor deformation and upheaval occurs in crashes. This situation increases the probability of a "bottoming-out" hazard in severe impacts, particularly for heavier individuals.

In a similar case, the V-22 crew seat's EA stroke was compromised when a control cable for the seat-mounted cyclic assembly was routed into the seat's stroking path. Initial estimates for cable fracture loads were in the range of 500 to 600 pounds. This would have produced unacceptable "bottoming-out" loads to the seated occupants during the crash stroke. Fortunately, a design review revealed the interference problem, and a redesign resulted in reduction of the fracture load to approximately 100 pounds in the production design.

Another example of failure to verify design concepts was encountered in the construction of the stroking troop seats for the UH-60 Black Hawk. These seats were designed with a lap belt and dual shoulder harnesses. In order to accommodate troops wearing the standard "rump" pack, a pocket was incorporated into the lower portion of the seat that could be opened to allow the pack to extend beyond the plane of the seat back. This feature allowed the troop's back to be supported by the seat back without the necessity of removing the pack. Unfortunately, prior to the fielding of the Black Hawk, the Army replaced the "rump" pack with a pack worn on the upper back. For unknown reasons this information was not transmitted to the contractor, so the Black Hawk was fielded with pocket in the wrong location. The resulting problem was that the shoulder harnesses could not be attached when the backpack was worn and the pack was filled.

A positive example of a design validation issue can be found in the dynamic qualification tests of the V-22 troop seat installation. The full-scale demonstration (FSD) model incorporated a cargo guidance tunnel fabricated of composite structure and located on the side-walls, just beneath the troop seats. Initial displacement analyses of the troop seat's stroking path indicated a minor "glancing" type contact between the seat's frame and the tunnel. However, during crash testing of the troop seat and a representative side-wall structure including the cargo tunnel, significant interference was measured with "bottoming-out" type loads incurred by the test dummy. This operational-type test provided the necessary data to support repositioning the tunnel to preclude the adverse effects of the interference.

JSSG-2010-7

3.7.1 Aircraft crash protection envelope.

The aircraft crash protection envelope shall be specified for the specific aircraft configuration identified within the acquisition documents. Crash conditions to be specified shall include aircraft dynamic properties, impact surface types and states, and aircraft configurations that affect crash survivability. The envelope of crash conditions shall be tailored as applicable for the various aircraft types and configurations (i.e. fixed wing, rotary wing, tilt rotor, other) and their anticipated survivable crash scenarios.

a. Impact velocity: An omni-directional envelope of impact velocity vectors shall be defined for all potential aircraft crashes under which occupant protection is required. The impact velocity vector envelope shall define the full range of survivable impacts taking into account variables such as aircraft speed, flight path angles, attitude (roll, pitch, yaw), and the slope of impact surfaces. Impact velocity shall be specified in terms of the aircraft's velocity change during the crash event, including both the principal impact as well as potential secondary impacts.

b. Impact surfaces and conditions: Anticipated impact surfaces shall be defined including terrain, water, and runway surfaces. Surface conditions shall also be specified including soil compressibility and sea states.

c. Aircraft mission configurations and special equipment: Occupant crash protection shall address the full range of aircraft roles and mission configurations affecting crash survivability, such as the application of internal and external auxiliary fuel tanks, hazardous cargo, and special equipment that could constitute strike hazards or egress impediments.

REQUIREMENT RATIONALE (3.7.1)

To achieve an appropriate level of occupant crash protection for a given system, it is essential to be able to accurately predict the potentially survivable crash impact parameters of the aircraft. This involves defining the overall crash environment that will exist at the time of the aircraft impact. That environment includes impacted terrain; airframe configuration; crash impact conditions; payload; weight distributions; aircraft velocities and local environmental conditions. This requirement is needed to define and bound the survivable crash parameters.

REQUIREMENT GUIDANCE (3.7.1)

The design of a crash survivable aircraft is heavily dependent upon the impact parameters specified for survivability. Quantifiable and realistic impact envelopes for velocity change and impact attitudes should be established through trade studies of crashworthiness versus cost, weight and mission needs. Impact velocity (speed and direction), attitude and impacted terrain are critical impact parameters that must be defined. Design criteria for light fixed wing and rotary-wing aircraft are defined in MIL-STD-1290, and are discussed in Section 4, Volume III of the Aircraft Crash Survival Design Guide. Table I provides design impact velocity changes which represent compromise crashworthiness levels derived from Army mishap data and consideration of human tolerance, system cost, weight and aircraft performance (rotary wing and light fixed-wing) factors

JSSG-2010-7

TABLE I. Crash impact design conditions, with landing gear extended, for military rotorcraft and light fixed-wing aircraft.

Condition number	Impact direction (aircraft axes)	Velocity change delta V (ft/sec)	Object impacted
1	Longitudinal (cockpit)	20	Rigid vertical barriers
2	Longitudinal (cabin)	40	Rigid vertical barriers
3	Vertical <u>1/</u>	42	Rigid horizontal surface
4	Lateral, type I	25	Rigid horizontal surface
5	Lateral, type II	30	Rigid horizontal surface
6	Combined high angle <u>1/</u> Vertical -----	42	Rigid horizontal surface
	Longitudinal	27	
7	Combined low angle Vertical -----	14	Plowed Soil
	Longitudinal	100	

1/ For the case of retracted landing gear the seat and airframe combination shall have a vertical crash impact design velocity change capability of at least 26 ft/sec.

Table II provides a summary of crash impact conditions determined from an Army sample of 298 Class A and B mishaps occurring from October 1, 1980 to September 30, 1985 (see Kinematics of U.S. Army Helicopter Crashes: 1979-85, Shanahan).

The authors of this study concluded that there were significant variations in crash resistance between the aircraft types and, that the UH-60A had a significantly higher survivable vertical velocity, even exceeding the 42 ft/sec velocity change required by MIL-STD-1290. Noting the substantial variations between aircraft types, the authors conclude that the current practice of designing all types of helicopters to the same criterion appears somewhat inefficient since current data suggest that different types of helicopters typically impact at different vertical velocities. Shanahan recommends that future crashworthiness research should establish a method to predict the crash environment parameters of a new aircraft in its conceptual stages. Appropriate crashworthiness design criteria could then be established to match the aircraft's predicted crash impact envelope, thus preventing under-design or over-design characteristics. Generally, the following statements apply to the vertical and longitudinal impact vectors in rotorcraft design:

a. Vertical velocity changes are useful in establishing standards since vertical crush is essentially fixed by aircraft design.

b. Horizontal velocity changes are not necessarily as useful because of the large variability of longitudinal airframe crush related to impact surface characteristics.

JSSG-2010-7

TABLE II. 95th percentile velocity changes for survivable class A and B mishaps.

Aircraft type	Survivable mishaps (N-221)	
	Vertical velocity (ft/sec)	Horizontal velocity (ft/sec)
AH-1	39.4	55.8
OH-58	29.5	88.6
UH-1	33.5	85.9
UH-60	47.2	39.4

Figure 2 provides a standard for aircraft coordinate and attitude directions. MIL-STD-1290A states a performance requirement for a “combined impact” condition as follows: The designer shall analytically demonstrate the capability of the aircraft with, 1 DGW rotor/wing lift and, with landing gear extended to withstand the following combined impacts without a reduction of the cockpit or cabin compartments that would seriously injure occupants: (1) a combined impact on a rigid horizontal surface with vertical and longitudinal velocity changes of 42 and 27 ft/sec for the impact attitude envelope shown on figure 3, and (2) a combined impact on plowed soil for the following conditions:

Soil of California bearing ratio	= 2.5
Aircraft pitch	= 5 degrees nose down
Aircraft roll	= $\pm 10^\circ$
Aircraft yaw	= $\pm 20^\circ$
Flight path angle	= -8 degrees down
Impact ground speed	= 100 ft/sec
Impact sink speed	= 14 ft/sec

JSSG-2010-7

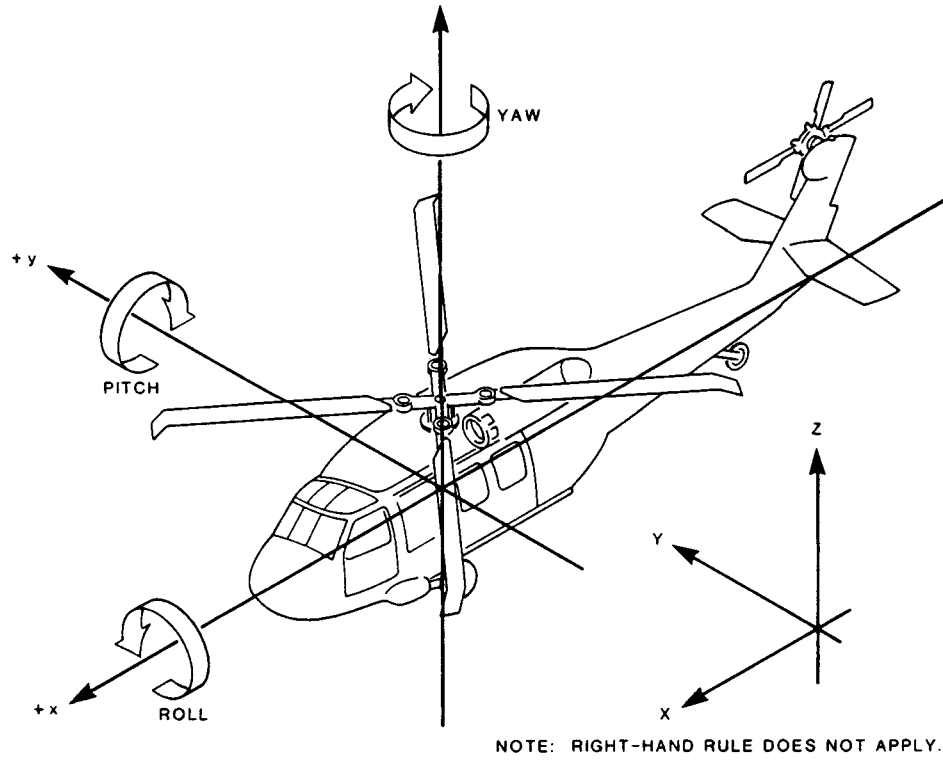


FIGURE 2. Aircraft coordinate and attitude directions.

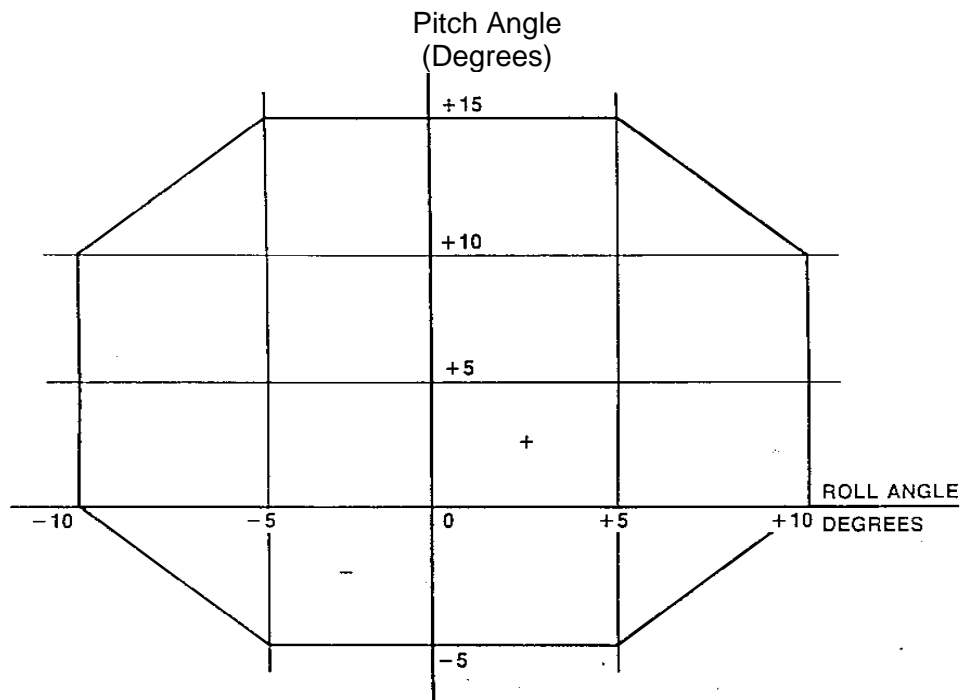


FIGURE 3. Impact attitude envelope for rotary-wing and light fixed wing aircraft.

JSSG-2010-7

Categorized crashworthiness design criteria. USAAVSCOM Technical Report 90-D-16 (“Development of Categorized Crashworthiness Design Criteria For U.S. Army Aircraft”, Coltman, May 1990) establishes categorized crashworthiness design criteria based upon aircraft size (weight). Some of the more important findings are listed below:

a. The study concludes that the crash resistance achievable in practical aircraft will be related to size in accordance with the trends established in the report’s analysis.

b. Further, the author concludes that for vertical impacts within the envelope of the MIL-STD-1290 criteria, the combined 10-degree pitch and 10-degree roll condition was the most severe. For this condition it was shown that the 42 ft/sec, gear-down, vertical impact criteria probably can’t be met by practical designs of aircraft weighing less than approximately 15,000 pounds. (Note: MIL-STD-1290A reduced the pitch requirement to 5-degrees)

c. In addition, the report states for aircraft less than 7,000 pounds, the 26-ft/sec velocity-change criterion with gear up, probably cannot be met in a practical design.

d. For larger aircraft, the earth-scooping criteria associated with the low angle combined impact of MIL-STD-1290 were shown to be impractical. This conclusion was based on the fact that the requirement, which was based on G loading, would impose a severe weight penalty on large airframes (over approximately 20,000 pounds).

The referenced report provides a comprehensive discussion of these “categorized” crashworthiness design criteria and their design implications.

FAA certified aircraft. For those applications where FAA certified aircraft are acquired for military use, the dynamic crash impact parameters cited within the appropriate FAR should be implemented. Specifically, the following regulations cover requirements for General Aviation, Commuter, Transport, and Rotorcraft Aircraft.

a. Title 14 U.S. Code of federal Regulations, Part 23, Amendment 23-39, Section 23.562, published in Federal Register of August 15, 1988, effective date Sept. 14, 1988.

b. Title 14 U.S. Code of Federal Regulations, Part 25, Amendment 25-64, Section 25.562, published in Federal Register of May 17, 1988, effective date of June 16, 1988.

c. Title 14 U.S. Code of Federal Regulations, Part 27, Amendment 27-25, Section 27.562, published in the Federal Register of Nov. 13, 1989, effective date of Dec. 13, 1989.

d. Title 14 U.S. Code of Federal Regulations, Part 29, Amendment 29-29, Section 29.562, published in Federal Register of Nov. 13, 1989, effective date of Dec. 13, 1989.

MIL-STD-1807. This document provides the following guidance relative to establishing the crash environment for USAF aircraft. The requirement for velocities may be completed by inserting an appropriate velocity value if the basic performance of the air vehicle is known. The velocities could be determined by tying the velocities to the maximum energy limit. For example, “the velocities need not exceed those that would result in total air vehicle kinetic energy exceeding twice the maximum energy of the takeoff (lift-off) or landing (touchdown) for that mission.” Or it might be determined by tying the velocities to the maximum personnel limit. For example, “the velocities need not exceed those that would result in fatally injuring the well-protected crew and personnel.” The less definitively the requirement is stated, the more monitoring of the program will be required of the project office personnel to ensure that adequate crash survivability is designed and built into the air vehicle subsystems.

For crash landing sink velocities, the factor to be multiplied times the landing sink velocities might well exceed three and still be a survivable crash. Here again, the factor might be referenced to the limits of well-protected crew and personnel.

JSSG-2010-7

The crash landing crosswinds factor to be multiplied times the landing crosswinds probably should not exceed 1.5 since most landing operations and those related thereto would not be attempted. However, forced landings might be involved with relatively high crosswinds, depending upon the type and intended use of the air vehicle.

The normal landing attitudes need to be increased and decreased by achievable amounts to define crash landing attitudes depending upon the basic aerodynamic characteristics anticipated for the air vehicle and any adverse weather in which it may be required to operate. Note these attitudes will probably determine when parts of the air vehicle, other than the landing gear, will contact the ground first and thus establish the angular velocity of the air vehicle during the rest of the crash scenario.

Regarding other failures, consider any and all subsystems expected to be on the air vehicle and, if they failed, could they influence the control of the motion of the air vehicle by the crew. If so, identify the subsystem and the type of failure associated therewith.

Recent automotive insights. Recent research conducted on Indy racecar crashes suggests that occupants are capable of surviving accidents of greater severity than is commonly accepted. This work is based on researchers obtaining impact acceleration data from actual Indy racecar crashes using on-board crash data recorders installed on the vehicles. Though this work has focused on Indy race cars, its preliminary findings certainly reinforce the fundamental precept that vehicle occupants can withstand severe decelerations if properly restrained and protected from structural intrusion. (See SAE 942482, "Racing Car Restraint System Frontal crash Performance Testing", Melvin, J.W., et al and SAE 962522, "Investigation of Indy Car Crashes Using Impact Recorders", Melvin, J.W., et al).

REQUIREMENT LESSONS LEARNED (3.7.1)

As indicated in the above sections, methodology to establish aircraft crash protection envelopes has evolved considerably over the past 35 years. The first edition of the Crash Survival Design Guide cited a study of selected survivable U.S. Army light fixed-wing and rotary-wing crashes from 1960 to 1965 and recommended that new design protection envelopes encompass the 95th percentile survivable crash determined from this study. Superficially, this appears to be a rigorous criterion, however, it is difficult to precisely define a 95th percentile crash which incorporates all kinematic variables. What was done was to define the 95th percentile survivable crash pulse in terms of the most significant variables, then select the limits of other variables based on less rigorous criteria including experience, intuition and economics. The crash protection envelope specified in the Crash Survival Design Guide and incorporated into MIL-STD-1290 in 1974 was based on an analysis of 40 crashes from the above-cited study. Impact velocity changes for the three major axes were independently plotted and the 95th percentile velocity change determined. The 95th percentile velocity changes were then limited by defining the envelope of roll, pitch and yaw for which these conditions must be met. These limits were established since it is impractical to design any aircraft to provide equal protection for all attitudes of impact. A separate roll over requirement was also established. The result was that, in theory, any helicopter designed to this specification would protect occupants from serious injury in impacts up to the design velocity change limit provided the attitude remained within the specified envelope. In fact, this specification results in serious injury in more than 5 percent of potentially survivable crashes, since most crashes do not occur along the orthogonal axes and many do not occur within the stipulated attitude requirements.

As helicopters were built to these new requirements, there was considerable concern that the attitude requirements were too stringent due to the weight penalty that meeting these

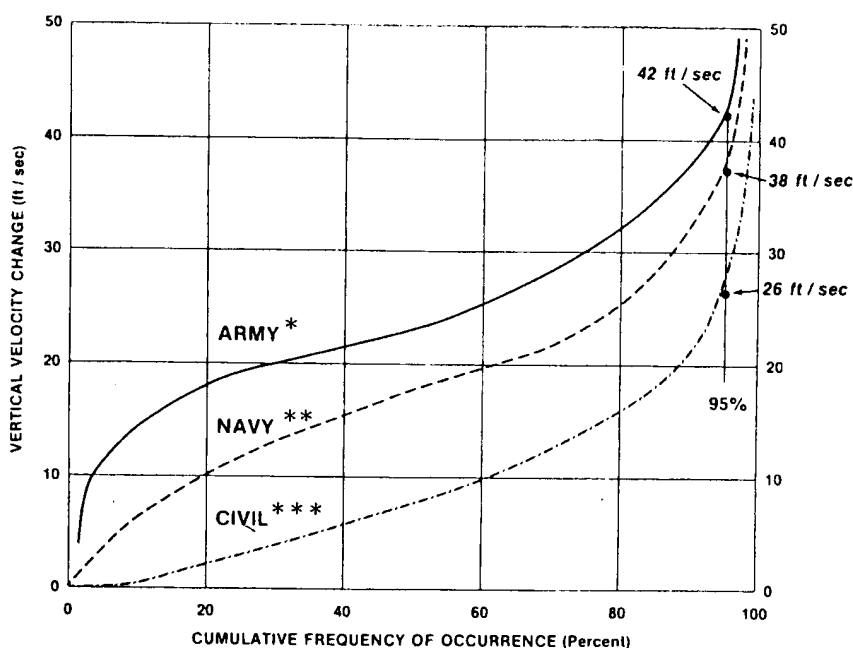
JSSG-2010-7

requirements involved. This led to the revision of MIL-STD-1290 in 1989, which provided the less stringent attitude requirements noted above.

More importantly, there has been considerable opposition to continuing the use of the so-called 95th percentile survivable crash pulse as the basis for establishing crash protection envelopes. The objection is that as more crashworthy aircraft are introduced into the operational fleet, the 95th percentile survivable pulse will necessarily increase since a larger proportion of crashes will be potentially survivable. This phenomenon known as "creeping crashworthiness" would impose ever-increasing burdens on new helicopter development.

For this reason, as well as the considerable variability in crash pulses, gross weight, rotor inertia and mission of helicopter (table II), it appears best to abandon the concept of fixed crash protection envelopes in favor of tailored envelopes that take into consideration all the important variables. The danger in this approach is that economic considerations will take precedence over other considerations leading to adoption of an inadequate crashworthiness standard for the aircraft under design.

Figure 4 provides a comparison of the survivable land and water impact velocity changes for Army, Navy and Civil rotorcraft



* USARL TR-79-22, AIRCRAFT CRASH
CRASH SURVIVAL DESIGN GUIDE,

** NADC-TR-84406, THE NAVAL
AIRCRAFT CRASH ENVIRONMENT.

*** DOT/FAA/CT-85/11, ANAL OF RTR
CRAFT CRASH DYNAMICS FOR DEVEL
OF IMPROVED CRASHWORTHINESS
DESIGN CRITERIA.

88-0034

FIGURE 4. Comparison of survivable impact velocity changes for Army, Navy, and Civil rotorcraft.

JSSG-2010-7

The above impact velocity change data were derived from several independent mishap analyses, and reflect the crash survival protection capacity of non MIL-STD-1290 aircraft designs. Therefore, these data should be considered conservative as incorporation of the crash protective features of MIL-STD-1290 could improve crash impact performance relative to these aircraft. As an example, the UH-60 Black Hawk has demonstrated a significant improvement over earlier vintage rotorcraft in its survivable vertical impact velocity parameter as shown on figure 5 (see "Kinematics of U.S. Army Helicopter Crashes: 1979-1985", Shanahan).

VERTICAL VELOCITY CHGS vs CUMULATIVE FREQ OCCURRENCE
SURVIVABLE MISHAPS — FY 80 - 85

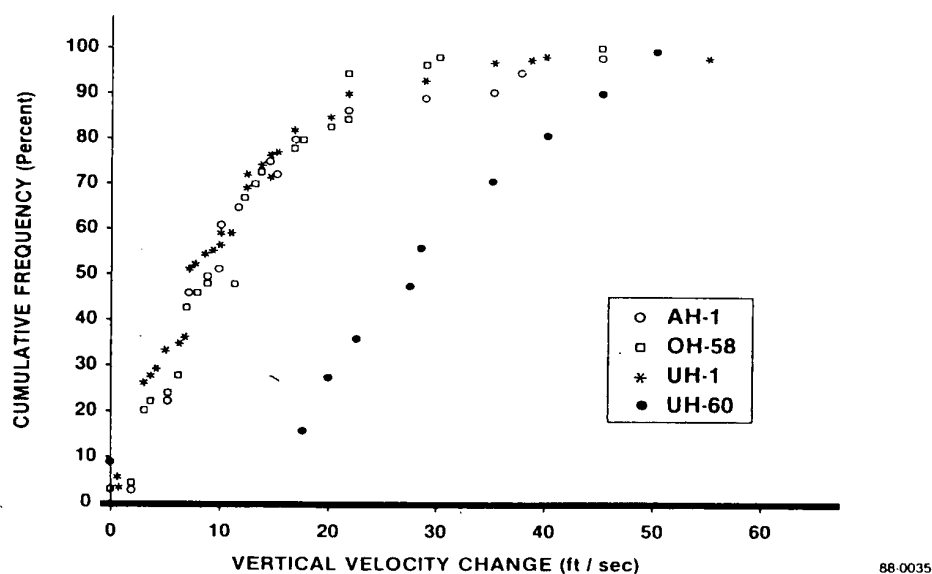


FIGURE 5. Comparison of vertical velocity change at major terrain impact vs cumulative frequency of occurrence for survivable mishaps.

4.7.1 Aircraft crash protection envelope verification.

The aircraft crash protection envelope requirements specified in 3.7.1 shall be verified prior to the system functional review (SFR). The verification shall be conducted through a review of the air vehicle system specification and concept trade studies.

VERIFICATION RATIONALE (4.7.1)

Verification of the aircraft crash protection envelope requirements prior to the SFR is essential to properly assess the allocated impact energy levels for the various subsystems of the energy

JSSG-2010-7

management system. These allocated levels will directly influence the selection of design concepts for landing gear and subfloor structures, respectively. Establishment of crash condition requirements prior to the SFR also alerts designers of all vehicle interfaces of the crash protection system's performance baseline to allow proper integration between systems. Defining the crash conditions prior to SFR provides sufficient time to conduct dynamic analyses of the proposed crash protection system and its predicted occupant response, providing performance tradeoffs for preliminary design selection.

VERIFICATION GUIDANCE (4.7.1)

Since the crash impact envelope must be verified during conceptual development, the designer must rely on preliminary design analyses, aircraft mission scenarios, structural and material processes, and preliminary computer simulations to establish a set of crash impact criteria for the proposed aircraft. The reviewer should base verification on the results of these studies coupled with knowledge of previous crash impact envelopes established for aircraft of similar attributes.

a. MIL-STD-1290 and the Aircraft Crash Survival Design Guide provide fundamental guidance in establishing aircraft crash condition requirements for rotary and light fixed wing aircraft.

b. MIL-STD-1807 provides guidance particularly appropriate for military transport aircraft.

c. Verification guidance of crash protection envelopes for commercial aviation can be found in the specific aircraft category FAR.

d. A survey of the crash environment for U.S. Navy Helicopters during the ten year period of 1972 to 1981 provides impact parameters and hazards associated with major injury (see "Evaluation of The Crash Environment For U.S. Navy Helicopter - The Hazards and Navy Response", Coltman, et al.).

VERIFICATION LESSONS LEARNED (4.7.1)

The basic crash resistant structural requirements and verification tests of MIL-STD-1290, and the Crash Survival Design Guide have been shown to be appropriate for aircraft of the size and configuration of the UH-60A BLACK HAWK and AH-64A Apache. These structural requirements should be considered in the verification analysis of the recommended crash survival envelope for rotorcraft designs.

Cronkhite ("Tilt Rotor Crashworthiness", presented at 41st Annual Forum of AHS, Fort Worth, TX, May 15-17, 1985) provides the methodology used to define the crash impact envelope for the V-22 development based on MIL-STD-1290 requirements. The paper discusses the various design issues related to applying crashworthiness standards to an all-composite aircraft and some of the inherent advantages associated with a tilt-rotor design. The trade study employed provides an excellent model for those involved in the verification process to use as a baseline. Once again, the method employed to balance crew/passenger survivability and aircraft performance is the "systems approach to crashworthiness".

Chandler ("Occupant Crash Protection in Military Air Transport", AGARDograph No. 306, Advisory Group For Aerospace Research & Development, August 1990) provides a comprehensive history of crashworthiness developments and summarizes the studies and decisions which led to the current state-of-the-art. This document is a good source for test and evaluation data and recommended design criteria for transport-category aircraft.

JSSG-2010-7

3.7.2 Occupant exposure limits to crash hazards.

Occupant exposure to impact forces, accelerations, post crash fire, toxic gasses, submersion, and other crash related hazards shall be controlled to prevent fatal injuries, disabling injuries, and injuries which could prevent post-crash emergency egress and survival actions. Injury types that shall be mitigated for crashes within the crash protection envelope include, but are not limited to:

- a. Whole body acceleration induced injuries.
- b. Localized body contact induced injuries.
- c. Thermal injury due to fire.
- d. Respiratory injury due to toxic gases.
- e. Drowning.
- f. Electrical shock.
- g. Chemical exposure.

Injury tolerance levels shall be specified for all applicable injury types, including variations for the range of required anthropometry. The specified tolerance levels shall be quantifiable and measurable in order to be effectively used during the verification process.

REQUIREMENT RATIONALE (3.7.2)

The ultimate goal of the crash protection system required by this guide specification is to prevent occupant fatalities and to minimize the number and severity of injuries during crash impacts of the severity cited in 3.7.1. This requirement places practical boundaries on the extent to which the system must provide occupant protection. The term “occupant exposure limit” is defined herein as an impact level which is taken as the maximum allowable condition for design purposes and is intended to approximate the maximum exposure without serious or fatal injuries to occupants.

REQUIREMENT GUIDANCE (3.7.2)

Defining injury limits is a complex process that requires trade-off decisions. Clearly, it is more difficult and expensive to design a system to prevent all injury within a protection envelope than it is to allow a certain degree of injury at the upper limits of the envelope. Setting a criterion of preventing all injury also limits the size of the envelope of protection. A good example of this issue is exemplified in the design of ejection systems. The objective of these systems is to permit successful ejection under the greatest range of conditions of velocity, altitude, and attitude as possible. The limiting factor is human tolerance to acceleration. If the designer chooses an acceleration pulse that is so low as to prevent any injury for the entire pilot population, the ejection envelope will be quite small and an unacceptable number of occupants will die because they were not ejected in time. Conversely, if the acceleration pulse is too great, the ejection envelope will be greatly expanded but at the expense of an unacceptable number of injuries. Clearly, the objective must be to provide the greatest envelope possible while limiting the rate and degree of injury to an acceptable level. What constitutes an acceptable level of injury must be rigorously and deliberately selected based on knowledge of human tolerance and previous experience with ejection systems. This is a critical issue since the only time the designer can evaluate the effectiveness of his trade-off decisions is after the system becomes operational.

JSSG-2010-7

Acceleration and contact forces can generally be divided into the tolerable, injurious, and fatal ranges according to their effect on the human body. Forces in the tolerable range are such that minor trauma, e.g., abrasions and bruises may occur but the subject is not incapacitated. Forces in the injurious range cause moderate to severe trauma that may or may not incapacitate the subject, survival is insured with prompt medical care. Forces in the fatal range cause non-survivable trauma (see AFSC DH 2-8).

As can be surmised from the preceding discussion, knowledge of human tolerance limits is essential to deriving design specifications for protective systems. What follows is a concise discussion of human tolerance issues and a summarization of what is currently known about whole body and regional (body area) tolerance to abrupt acceleration.

Knowledge of human tolerance is important to understanding and effectively applying the performance requirements of the crash protection system defined in the guide specification and this handbook. Significant research has been conducted in the field of bio-dynamics, resulting in the determination of general guidelines and approximate end points. The tolerance of the human body to impact forces depends on a number of variables, including characteristics of the individual such as age, sex, and general state of health.

There are several difficulties that prevent a ready establishment of human tolerance levels. First, there are differences in judgment as to the specific degree of injury severity that should serve as the tolerance level. Second, large differences exist in tolerances of different individuals. It is not unusual for bone fracture tests on samples of adult cadavers to show a three-to-one load variation. Presumably, variations of at least this magnitude exist in the living population. Finally, most tolerance levels are sensitive to modest changes in the direction, shape, and stiffness of the loading source. The above considerations indicate that complete and precise definitions of human tolerance levels will require large amounts of data based on controlled statistical samples. Only in this way can the influence of age, size, sex, and weight be comprehensively assessed, and only in this way can mean loads and statistical measures of scatter be linked to specific tolerance levels.

In the interim, it is necessary to employ various tolerance measures in the development and evaluation of safety features. Probably the most widely used of such measures is the "tolerance specification". This is an impact level taken as a boundary condition for design purposes. Within this handbook, the terms "tolerance specification" and "occupant exposure limits" are used interchangeably.

SAE J885 provides an excellent reference for discussion and guidance on this issue. The following definitions provide biomedical guidance on terms used throughout this handbook. The definitions for injury, injury level, injury criterion, tolerance level, and tolerance specification, (see section 5) provide biomedical guidance on terms used throughout this handbook.

Injury classification. In general, all mechanical injury arising from aircraft crashes may be classified into either acceleration injury or contact injury. In a strict sense, both forms of injury arise from application of force to the body through an area of contact with a surface. In the case of acceleration injury, the force application is more distributed so that the site of application usually does not receive a significant injury. The site of injury is distant from the area of application and is due to the body's inertial response to the acceleration. An example of acceleration injury is rupture of the aorta in a high sink rate crash. Here the application of force occurs through the individual's thighs, buttocks, and back where he is in contact with the seat. The injury itself is due to shearing forces generated from the aorta's inertial response to the resulting upward acceleration of the body.

JSSG-2010-7

A contact injury occurs when a localized portion of the body comes into contact with a surface in such a manner that injury occurs at the site of contact. This is often referred to as the “secondary collision”. Relative motion between the struck body part and the contacting surface is required. An example of this type of injury is a depressed skull fracture resulting from the head striking a bulkhead. It is important to realize that a mixed form of injury may also occur when acceleration generated by a localized contact produces injury at a site distant from the point of contact as well as at the point of contact. A contra-coup brain injury associated with a depressed skull fracture is an example of a mixed form of injury.

Distinction is made between these two forms of injury since prevention involves different strategies. Providing means of attenuating the energy of a crash before it can be transmitted to the body of occupants prevents acceleration injury. This method has been employed to prevent vertebral injuries in crashes of the Black Hawk and other helicopters through energy attenuating landing gear and seats. The general strategy employed to prevent contact injury, on the other hand, is to prevent localized contact between an individual and a potentially injurious object. To accomplish this, a number of methods may be utilized depending on the specific circumstances. Occupant restraint may be used to prevent flailing of the upper torso, head, or extremities. Potentially injurious objects may be removed from locations where an individual may strike them. The strength of the aircraft structure or the tie-down strength of high-mass items may be increased to prevent aircraft structure or components from intruding into occupied areas. Another possible approach, although somewhat less desirable, is to pad internal objects, make them frangible, or to provide occupants with protective equipment such as flight helmets to reduce the potential for injury when contact is made with internal structures or intruding external structures.

Principles of tolerance to whole body acceleration. A major objective of a crash protection system is to attenuate crash loads reaching occupants to levels within the limits of human tolerance. For a designer to meet this objective, he must possess a basic understanding of human tolerance limits and the factors that influence these limits. Human tolerance to the abrupt accelerations experienced in crashes is dependent upon six general factors:

- a. Individual characteristics – age, gender, anthropometry, general health
- b. Direction of the applied acceleration pulse
- c. Magnitude of the applied acceleration pulse
- d. Duration of the acceleration pulse
- e. Rate of onset of the acceleration pulse
- f. Position/Support/Restraint

Individual characteristics have a marked effect on tolerance to acceleration particularly at the extremes of age. Likewise general health, gender and anthropometry seem to effect tolerance. Since military aircraft are occupied by relatively young adults in excellent physical condition, tolerance criteria applied to these aircraft may not be suitable for civil aircraft designed for the general population. Likewise, one must be careful in the interpretation of tolerance data depending on the subjects used in the testing. Thus, a degree of conservatism may be built in for the military in using criteria for the general public cross section. However, these tolerance criteria have for the most part been based on experiments involving subjects seated with correct upright posture, while military aircrew spend large portions of their time in the aircraft in less than ideal postures for absorbing a crash impact.

Figure 6 below provides NATO Terminology for directions of forces on the body. Notice that the right-hand rule does not apply in this convention which only effects the direction of positive

JSSG-2010-7

acceleration for the y-axis. The automotive industry as well as other groups apply the right-hand rule to designate directions of force on the body, so caution must be used in applying data derived from various sources. Figure 6 also indicates the inertial effects of the applied acceleration on body organs by specifying the direction that an individual's eyeballs would respond. The inertial response of body organs is, of course, opposite to the applied acceleration. This distinction is important in understanding mechanisms of injury in vehicular crashes. The significance of the preceding discussion is that individual tolerance to abrupt acceleration is different for different axes of the body. In general, forces are best tolerated when directed along the G_x axis as will be discussed in more detail below.

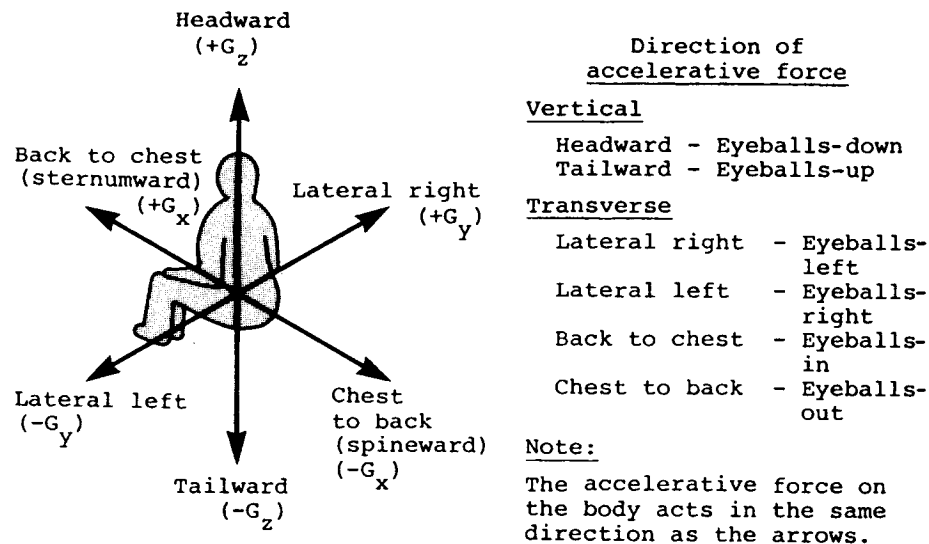


FIGURE 6. NATO designated directions of accelerative forces on body.

The next factor influencing human tolerance to abrupt acceleration is magnitude of the acceleration. It is intuitively obvious that the higher the magnitude, the less tolerable the acceleration. It should also be understood that the duration of the pulse as well as its rate of onset heavily influences tolerable acceleration levels. As a general rule, the longer the duration and the greater the rate of onset, the less tolerable the acceleration.

Currently, military crash resistant seating systems for rotary-wing and light fixed-wing aircraft are evaluated against criteria established by a NASA memorandum published by Eiband, entitled "Human Tolerance to Rapidly Applied Accelerations: A Summary of the Literature". These data were published in 1959 and were based on human and animal test data. Much of the data were collected for a variety of full-torso restraints, and in some cases head restraint also. Only two of the most significant curves are reproduced here (see figures 7 and 8). Tolerable limits of acceleration loading were shown to be a function of time duration and the rate of onset of the applied force. The "head-ward" curve defines a 5.5 millisecond time duration at the 23 g level as the suggested limit for crash resistant seat performance. This specific application of Eiband was based on an early 1944 study by Geertz on seat catapults ("Limits and special problems in Use of Seat catapults", Geertz, A., Air Documents Division, Wright Field, OH, 1944). Note that MIL-S-58095A, (i.e., the military Crash Resistant Crew Seat

JSSG-2010-7

specification, dated Jan 1986) incorporated a change to the time duration parameter, increasing it to 25 milliseconds. This revision was based on qualification experience with Black Hawk crew-seat designs and subsequently validated with cadaver testing.

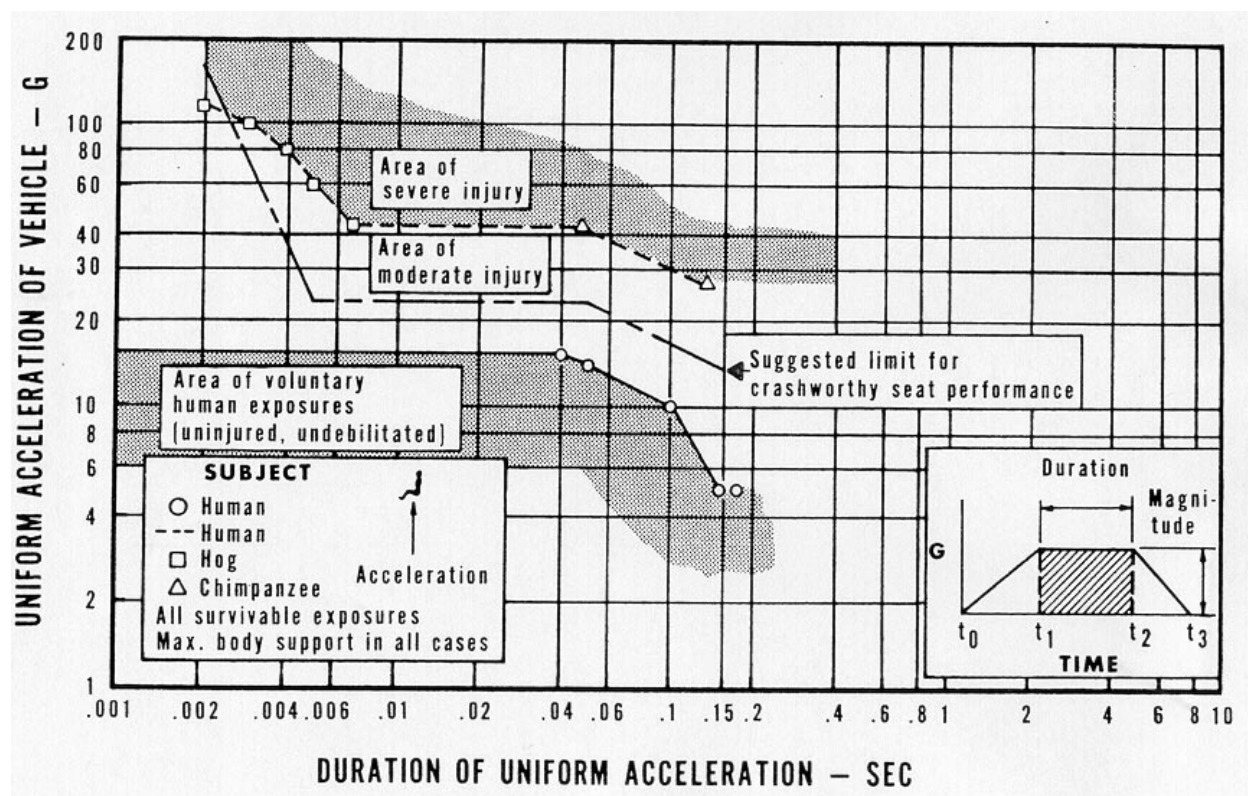


FIGURE 7. Duration and magnitude of headward acceleration (EIBAND).

JSSG-2010-7

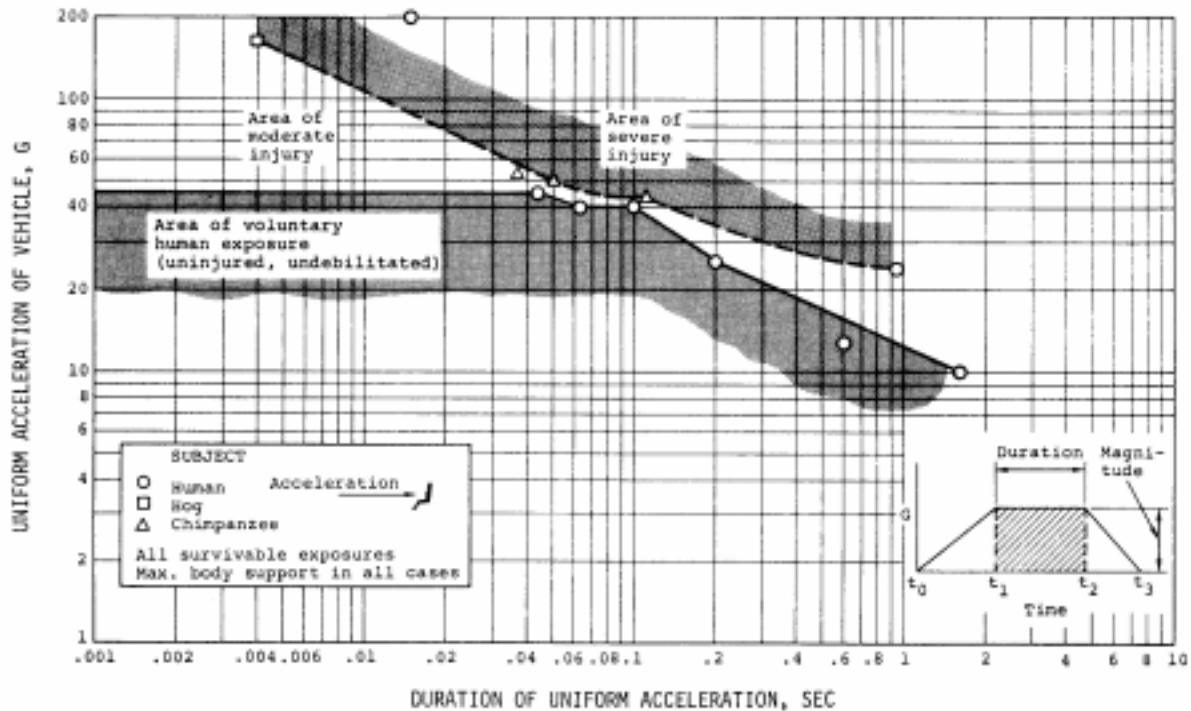


FIGURE 8. Duration and magnitude of spineward acceleration (EIBAND).

The final factor effecting tolerance to acceleration is designated as position/restraint/support. This is a critical area of consideration for crash survival design. To maximize tolerance to an applied acceleration pulse requires that the individual be appropriately positioned with regard to the direction of the pulse, that his body, particularly head and torso, be restrained against excessive motion, and that the seat provide optimum support. Since crash scenarios tend to be relatively predictable for any type of aircraft, designers of protective systems can optimize the above listed factors to prevent injury in crashes. Table III provides generally accepted tolerance limits for acceleration along the three orthogonal axes for "typical" crash pulses for a well restrained young male. These values are provided as "top-level" generalizations while the following paragraphs provide more definitized limits.

The total body limits expressed by the Eiband Curves have been extensively used as the standard for design over the past four decades. However, recent data derived from crashes of instrumented Indy racecars are beginning to dispel the notion that a "40 g" cockpit is the limit of protection. Frontal accelerations of approximately 62 g's have been measured in the cockpit in actual crashes of Indy cars with the driver sustaining only minor injuries (i.e., minor pains and scrapes). It appears that the compilation of these data will demonstrate that when vehicles are designed with appropriate attention to structure, restraint, and other protective systems, the envelope of crash survivability can be greatly expanded over current limits (See references provided under Requirement Rationale 3.7.1).

JSSG-2010-7

TABLE III. Human tolerance limits to acceleration.

Dirction of Accelerative Force	Occupant's Inertial Response	Tolerance Level
Headward (+ Gz)	Eyeballs Down	25 g
Tailward (- Gz)	Eyeballs Up	15 g
Lateral Right (+ Gy)	Eyeballs Left	20 g
Lateral Left (- Gy)	Eyeballs Right	20 g
Back to Chest (+ Gx)	(Sternumward)	45 g
Chest to Back (- Gx)	Spineward	45 g

NOTE: See Crash Survival Design Guide; TR 79-22. (0.10 Second time duration of crash pulse; full restraint)

Injury scaling. Injury scaling is a technique for assigning a numerical assessment or severity score to traumatic injuries in order to quantify the severity of a particular injury. Such a procedure is useful in quantifying the severity of a particular crash or in comparing outcomes between similar crashes. The most extensively used injury scale is the Abbreviated Injury Score (AIS) developed by the American Association for Automotive Medicine and originally published in 1971. The AIS assigns an injury severity of “one” to “six” to each injury according to the severity of each separate anatomical injury. AIS 1 is a very minor injury such as an abrasion or contusion to the skin and AIS 6 is an injury of maximum severity such as a massive crush to the skull. Injuries are sub-classified according to body region. Table IV provides the AIS designations and gives examples of injuries for two body regions. Note that the AIS scores severity of injuries and not the consequences of injuries. Consequently, it cannot be used to indicate impairments or disabilities that are the consequence of injury.

The primary limitation of the AIS is that it looks at each injury in isolation and does not provide an indication of outcome for the individual as a whole. Consequently, the Injury Severity Score (ISS) was developed in 1974 to predict probability of survival (Baker et al, Journal of Trauma, 14:187-196, 1974). The ISS is a numerical scale that is derived by summing the squares of the highest AIS in each of three body regions. This gives a value ranging from 1 to 75. The maximal value of 75 results from three AIS 5 injuries, or one or more AIS 6 injuries. Probabilities of death have been assigned to each possible score and can be found in the referenced publication.

As opposed to injury scaling, each of the military services has historically classified the severity of an injury in aviation mishaps according to a qualitative scale (OPNAV Instruction 3760, DA Regulation 385-95). Recently, the Army has begun using the AIS in addition to the DOD mandated qualitative scale in its Aircraft Mishap Reports (DA PAM 385-95).

JSSG-2010-7

TABLE IV. Abbreviated injury scale (AIS) and sample injury types for two body regions.

AIS	SEVERITY	HEAD	SPINE
0	NONE	----	----
1	MINOR	Headache or dizziness	Acute strain (no fracture or dislocation)
2	MODERATE	Unconscious less than 1 hr., linear fracture	Minor fracture without any cord involvement
3	SERIOUS	Unconscious 1-6 hrs., depressed fracture	Ruptured disc with nerve root damage
4	SEVERE	Unconscious 6-24 hrs., open fracture	Incomplete cervical cord syndrome
5	CRITICAL	Unconscious more than 24 hrs., large hematoma (100cc)	C4 or below cervical complete cord syndrome
6	MAXIMUM INJURY (virtually non-survivable)	Crush of skull	C3 or above complete chord syndrome

Jeffrey Pike (*"Automotive Safety: Anatomy; Injury; Testing; Regulation"*; SAE Publication, 1990) identifies four major categories upon which injury scale techniques can be organized:

Anatomic (based on structural injury. e.g., fracture)

Physiologic (based on functional change due to injury, e.g., change in response of pupil of eye to light),

Combinations and Impairment,

Disability and Societal Loss.

A detailed discussion of each category can be found in the referenced document.

Regional injury tolerance limits. The above discussion has centered on whole body tolerance to abrupt acceleration and the significance of these data to the design of crashworthy aircraft. Of equal importance to the designer is information regarding regional body tolerances. For instance, the helmet designer needs information on head tolerance to peak transmitted force in order to maximize head protection. The design of effective ejection systems and crashworthy seating systems requires knowledge of spinal tolerance to vertically applied forces. An effective restraint system design must consider the tolerance limits of portions of the body that interact with the restraint system during crashes. Because of these and similar considerations, a whole body of literature has been developed describing tolerance limits of specific portions of the body.

Dynamic response index. Whereas the + G_z acceleration limit for military rotary-wing and light fixed-wing crash resistant seating has been defined by the Eiband Curve (figure 7), the USAF has determined ejection seat compliance to a + G_z tolerance specification by calculating dynamic response index (DRI) values. The DRI is representative of the maximum dynamic compression of the vertebral column and is calculated by describing the human body in terms

JSSG-2010-7

of an analogous, lumped-mass parameter, mechanical model consisting of a mass, spring and damper. The DRI model assesses the response of the human body to transient acceleration-time profiles. The equations necessary for calculating DRI are contained in MIL-C-25969 and Volume II of the Aircraft Crash Survival Design Guide: Aircraft Design Crash Impact Conditions and Human Tolerance.

The DRI has been effective in predicting spinal injury potential for +G_z acceleration environments in ejection seats. However, it should be noted that the DRI has not been validated for use as an injury criterion in crashes. In ejection seat applications, the DRI injury probability assumes a well restrained seat occupant with vertical spinal alignment maintained by a power haul-back type inertia reel. Current thinking is that the DRI is acceptable for evaluation of crash resistant seat performance relative to spinal injury if used as part of a set of injury criteria, including EIBAND and lumbar load. In fact, the concept of multiple injury criteria for a given injury mechanism provides a greater degree of confidence in the ultimate assessment of the device's potential for preventing injury.

To address multiple axis response, an expanded version of the DRI referred to as the Multi-axial Dynamic Response Criteria (MDRC) incorporates a mathematical expression that permits calculation of injury probability based on tri-axes acceleration. However, this application of the DRI has not been validated against specific injury mechanisms along the additional x and y axes.

Lumbar load criterion. Currently, the FAA cites a spinal lumbar load injury criterion for passenger seats. A maximum compressive load of 1500 pounds (6672 N) measured between the pelvis and lumbar spine of a Part 572B, 50th-percentile test dummy has been established for a crash pulse in which the predominant impact vector is directed parallel to the longitudinal axis of the spinal column. This load criterion is based on the fact that injury mechanisms are intrinsically related to the applied force sustained by the body member. The Naval Air Warfare Center is currently evaluating this approach for evaluation of crash resistant seats using the Hybrid III anthropomorphic test devices (ATD) as an alternative spinal injury criterion. Table V (Reference: "Development of an Advanced Energy Absorber", Richards, M., Podob, R., SAFE Symposium Proceedings, 1997) provides lumbar tolerance levels proposed for the new criteria.

TABLE V. Recommended military lumbar tolerance levels.

Occupant Size (percentile)	Lumbar Load Tolerance (lbs.)
5th Female	1,281
50 th Female	1,610
50th Male	2,065
95th Male	2,534

The following references provide further discussion and test data to support this approach:

SAFE Symposium Proceedings, 1997: "Establishing A Spinal Injury Criterion For Military Seats", Rapaport, et al., Sept. 1997.

SAE 981215: "Impact Response of Hybrid III Lumbar Spine to + G_z Loads", Schoenbeck, et

JSSG-2010-7

al, April, 1998.

SIMULA TR 97256, "Development of an Automatic Energy Absorber System for Crashworthy helicopter Seats", Labun, L.C., Ph.D., February, 1998.

Head injury criterion. With recent advances in automotive crash safety, the National Highway Traffic Safety Administration (NHTSA) has promulgated several injury criteria that could also have application to military crash safety. Foremost among these criteria is the head injury criterion (HIC). The HIC is an alternative interpretation of the original Wayne State Tolerance Curve developed for forehead impacts against plane, unyielding surfaces by animals and human cadavers. Basically, the acceleration-time response was experimentally measured and the data related to skull fractures. Gadd suggested a weighted-impulse criterion as an evaluator of injury potential (see "*Use of a Weighted-Impulse Criterion for estimating Injury Hazard*", *Proceedings, Tenth Stapp Car Crash Conference, SAE, 1966*) defined as:

$$SI = \int_{t_0}^t a^n dt$$

where:

SI = GADD Severity Index

a = acceleration as function of time

n = weighting factor greater than 1

t = time

The HIC is calculated by:

$$HIC = \left[(t_2 - t_1) \left[\frac{1}{(t_2 - t_1)} \int_{t_1}^{t_2} a(t) dt \right] \right]^{2.5}$$

Where t_1 and t_2 are the initial and final times during which HIC attains a maximum value and $a(t)$ is the resultant acceleration (G) measured at the head's center of gravity.

(See "*Human Tolerance to Impact Conditions as Related to Motor Vehicle Design*", SAE J885, April 1980). Federal Motor Vehicle Safety Standard (FMVSS) # 208 originally set a maximum value of 1000 for the HIC, specifying that the time interval shall not exceed 36 milliseconds. However, the U.S. delegation to the International Standards Organization (ISO) at a working group meeting held in 1982 made the following recommendations relative to use of the HIC:

HIC was not to be used to define acceptable belt restraint performance in the absence of head impact. In such non-impact cases, neck loading was recommended as the appropriate criterion.

The HIC duration should be limited to 15 milliseconds or less for the calculation of the HIC value for a given head acceleration-time history.

The Advisory Group developed tentative risk curves of the percent of population expected to experience life-threatening brain injury or skull fracture versus HIC values. (see SAE #851246: "*The Position of the United States Delegation to the ISO Working Group 6 on the Use of HIC in the Automotive Environment*", Prasad and Mertz, 1985).

The delegation's analysis emphasized the importance of properly using injury indices such as HIC, and understanding the implications of improper use. The risk curves generated show

JSSG-2010-7

distribution of cadaver skull fractures and brain damage, respectively, as functions of HIC duration for a family of constant HIC value threshold curves. The risk curves provided within the paper emphasize caution in any attempt to use a single value HIC threshold to evaluate a restraint system. Contractors and government evaluators should exercise similar caution in applying HIC to the assessment of military restraint systems.

49 CFR Parts 571 and 572, Anthropomorphic Test Dummies (ATDs) provide injury criteria for use with Part 572 and Hybrid III test dummies. Essentially, the regulation was changed to allow substitution of the Hybrid III test dummy for the Part 572. This rule adopts new requirements for specifications, instrumentation, test procedures, and calibration for the Hybrid III test dummy. A detailed discussion of the injury mechanisms and the relevant automotive mishap data are provided within the regulation for each of the injury criteria associated with the Hybrid III ATD. Consideration should be given to implementing these criteria in appropriate military test plans. Figures 9, 10, and 11 summarize injury assessment reference values (IARV s) for Hybrid III-type adult dummies (*Reference: "Anthropomorphic Test Devices", H. Mertz, Hybrid III: The First Human-Like Crash Test Dummy, SAE PT-44, 1994*).

Additional references for this subject material are:

Aircraft Crash Survival Design Guide Volume II- Aircraft Design Crash Impact Conditions and Human Tolerance

Injury Criteria for Human Exposure to Impact (FAA AC 21-22)

Guidelines for Safe Human Exposure to Impact Acceleration (NBDL-89R003)

Human Injury Criteria Relative to Civil Aircraft Seats and Restraint Systems (SAE Paper 851847)

Effect of Head and Body Position and Muscular Tensing a Response to Impact (Proceedings of the Eighteenth STAPP Car Crash Conference)

Strength and Response of the Human Neck (Proceedings of the Fifteenth STAPP Car Crash Conference)

Aircraft Crashworthiness (ISBN 0-8139-0634-2)

Head and Neck Injury (ISBN 1-56091-499-8)

Biomechanics of Impact Injury and Injury Tolerances of the Head-Neck Complex (ISBN 1-56091-363-0)

Injury Assessment Values Used to Evaluate Hybrid III Response Measurements, Mertz, H.J., SAE, PT- 44

Size, Weight, and Biomechanical Impact Response Requirements for Adult Size Small Female and large Male Dummies, Mertz, H.J., SAE 890756, March 1989.

JSSG-2010-7

TABLE 4.A1. Injury assessment reference values for Hybrid III-type adult dummies.^{32-35,37}

Body region Injury-assessment criteria ^a	Small female	Midsized male	Large male
Head			
HIC; $(t_2 - t_1) \leq 15$ ms	1,113	1,000 ^b	957
Head/neck interface			
Flexion bending moment (Nm)	104	190	258
Extension bending moment (Nm)	31	57	78
Axial tension (N)	Fig. 4.A2	Fig. 4.A2	Fig. 4.A2
Axial compression (N)	Fig. 4.A3	Fig. 4.A3	Fig. 4.A3
Fore/aft shear (N)	Fig. 4.A4	Fig. 4.A4	Fig. 4.A4
Chest			
Spine box acc.; (3 ms, G)	73	60	54
Sternal deflection due to:			
— Shoulder belt (mm)	41	50	55
— Air-bag & steering-wheel hub (mm)	53	65	72
Viscous criterion (m/s)	1	1	1
Femur			
Axial compression (N)	Fig. 4.A5	Fig. 4.A5	Fig. 4.A5
Knee			
Tibia-to-femur translation (mm)	12	15	17
Med./lat. clevis compression (N)	2,552	4,000	4,920
Tibia			
Axial compression (N)	5,104	8,000	9,840
Tibia index, $TI = M/M_c + F/F_c$	1	1	1
Where,			
M_c —critical bending moment (Nm)	115	225	307
F_c —critical comp. force (kN)	22.9	35.9	44.2

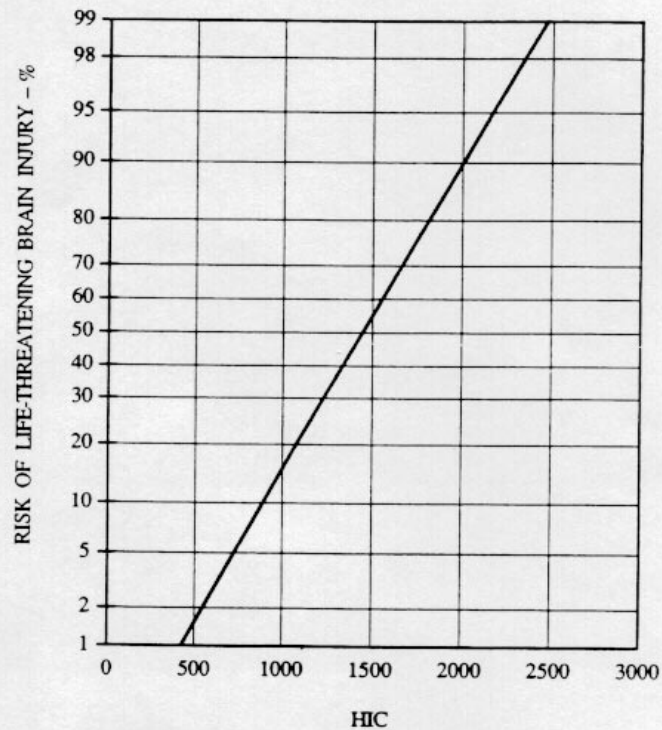
^a Units are SI notation.⁷⁷^b See Fig. 4.A1 for injury risk curve.FIGURE 4.A1. Injury risk curve for HIC for $t_2 - t_1 \leq 15$ ms.³²

FIGURE 9. Table of injury assessment values for hybrid III ATD and HIC injury risk curve.

JSSG-2010-7

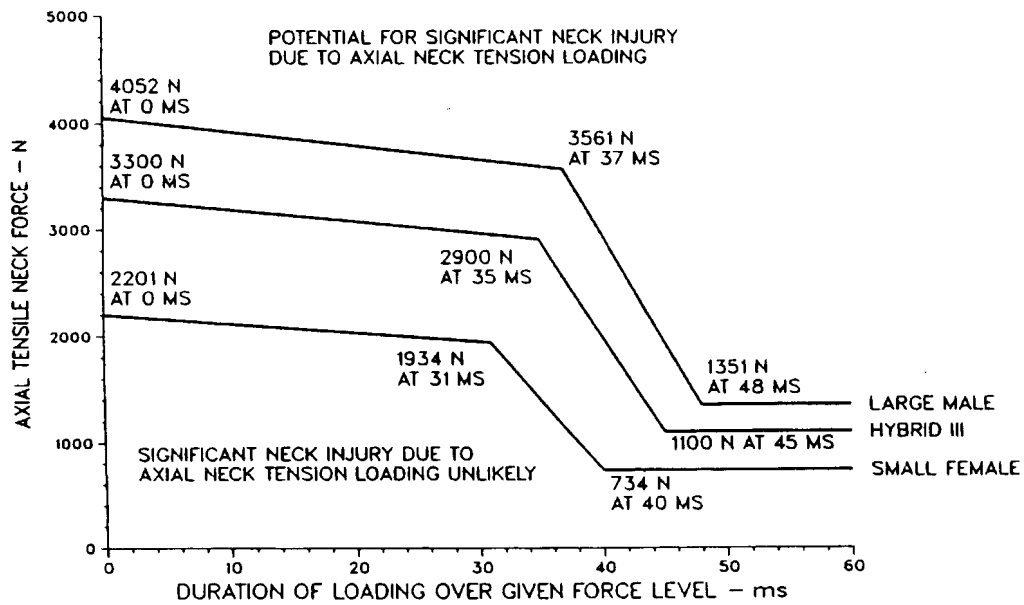


FIGURE 4.A2. Injury-assessment curves for axial neck tension measured with Hybrid III-type adult dummies.^{32,37}

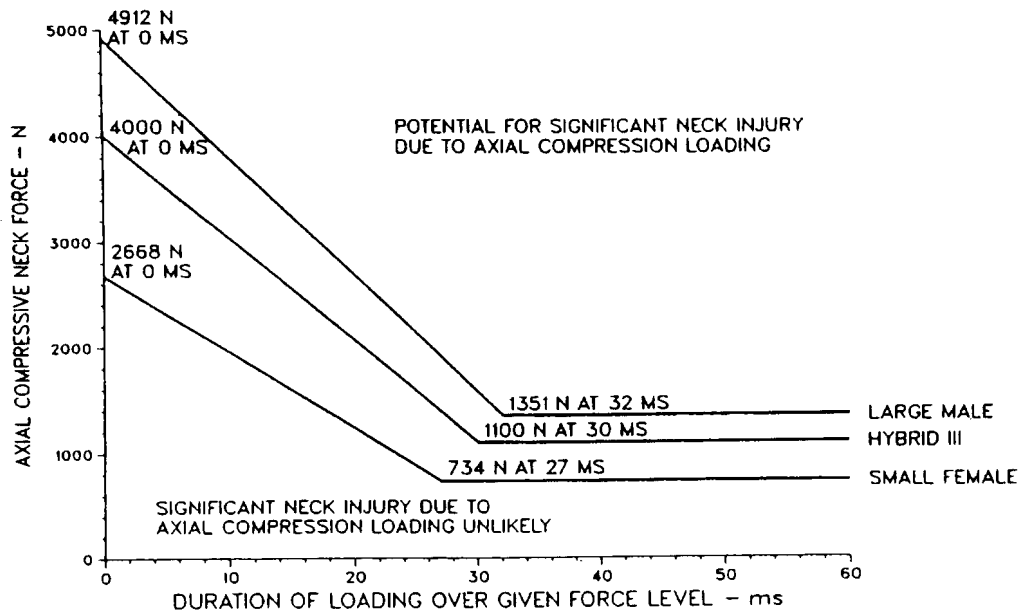


FIGURE 4.A3. Injury-assessment curves for axial neck compression measured with Hybrid III-type adult dummies.^{32,37}

FIGURE 10. IARV curves for axial neck tension and compression loading

JSSG-2010-7

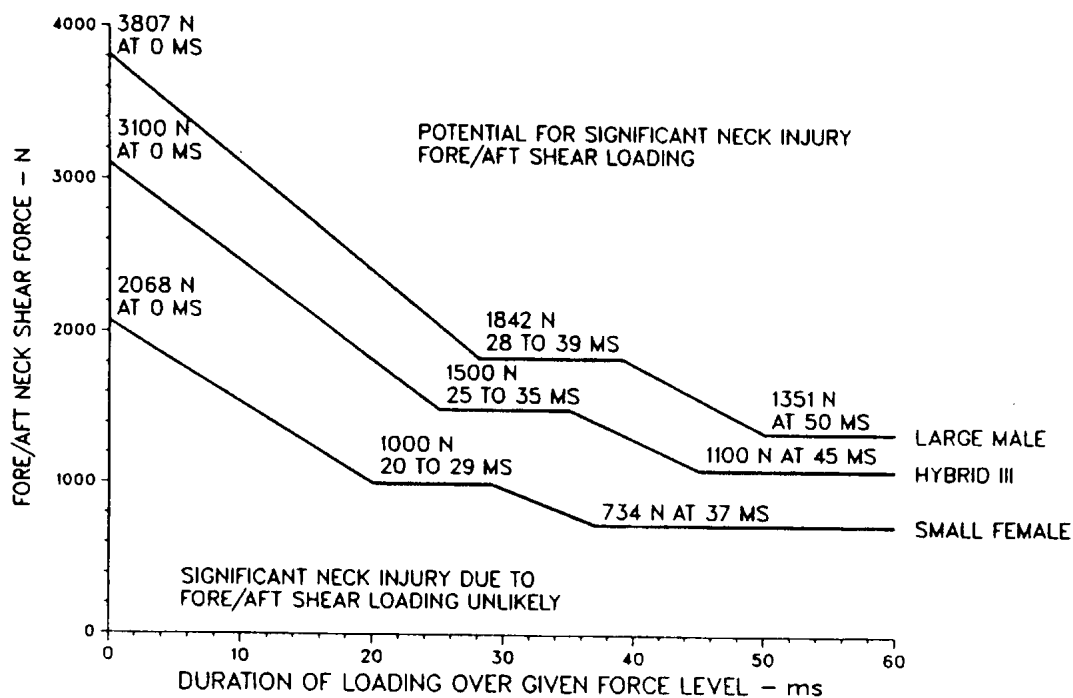


FIGURE 4.A4. Injury-assessment curves for fore and aft shear forces measured at the head/neck interface of Hybrid III-type adult dummies.^{32,37}

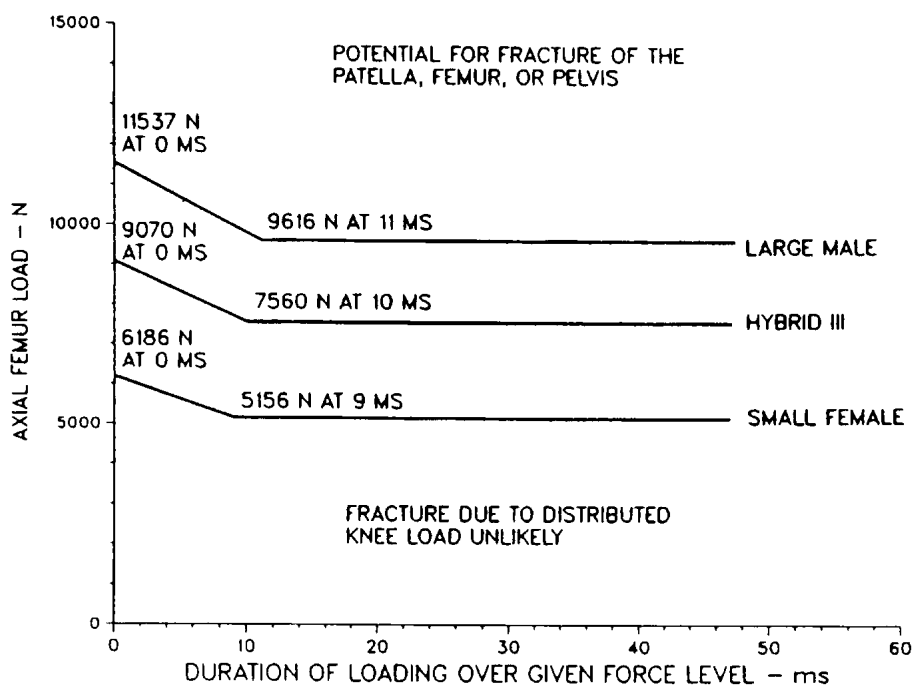


FIGURE 4.A5. Injury-assessment curves for axial compressive femur force measured with Hybrid III-type adult dummies.^{32,37}

FIGURE 11. IARV curves for neck shear loading and fracture of patella, femur, or pelvis.

JSSG-2010-7

REQUIREMENT LESSONS LEARNED (3.7.2)

Crashworthiness design standards must be based upon the determination of occupant exposure limits. Lack of understanding of occupant exposure limits will inevitably lead to either under-design or over-design of occupant protective systems. The former will result in significantly higher injury rates than expected and the latter results in unnecessary expenditures of limited resources.

The UH-60 Black Hawk energy attenuating seat program provides an excellent example of how the principles and knowledge described above were applied to develop a highly effective protective system. Past studies of helicopter crashes had shown that they tended to crash with relatively high vertical velocities in comparison to fixed wing aircraft. Furthermore, because of limited structure to provide crush in the vertical axis, vertical accelerations would frequently exceed spinal tolerance limits in otherwise survivable crashes. Energy management for the vertical axis was clearly a priority for Black Hawk designers. The decision was made to place some of the attenuating capability in the fixed landing gear while leaving a significant portion in the seat. The aircraft floor had relatively little energy attenuation capability.

The seat was designed to have a stroke capacity of between 12 and 17 inches depending on the vertical adjustment of the seat. To achieve this amount of stroke, a well was provided beneath the floor to accommodate the stroking seat. Based on knowledge of human tolerance combined with a clear understanding of principles of dynamic overshoot, the designers chose a maximum stroke force of 14.5 G for the seat. Subsequent experience with crashes of the Black Hawk as well as human cadaver testing in the seat have proven that the choice of 14.5 G was optimum to prevent spinal injury in the most severe survivable crashes for the full range of the aviator population. This is a clear example of how the hazards were accurately assessed prior to the design of the aircraft and how the protective system was integrated into the overall aircraft system design. Too often protective systems are designed in isolation or are given unreasonable space, weight and cost limitations that lead to significant compromise of effectiveness.

As effective as the system for vertical energy management has been for the Black Hawk, it should be emphasized the helicopter was designed for an overland operational environment. The significance of this point is that when the Black Hawk crashes on land the full capability of the vertical energy management system can be utilized as the gear strokes, the floor crushes and the seats stroke. Unfortunately, when the Black Hawk crashes in water, a major portion of the energy management system is defeated since the landing gear does not stroke on water impact. This phenomenon as well as other considerations such as hydraulic effects on the understructure will result in a comparatively poor crash performance for water impacts. Clearly, a helicopter intended for over water use should not have a significant portion of its vertical energy management incorporated in the landing gear. The same is true for helicopters with retractable gear. The lesson here is that one must be cautious in adapting a successful crashworthy design to other operational environments.

4.7.2 Injury tolerance levels verification.

Verification of the specified injury tolerance levels shall be accomplished by a review of the contractor's specifications, design analyses, and trade studies. The specified injury tolerance levels shall be verified relative to assessment of threats such as contact injuries from strike hazards and acceleration-induced injuries. Verification shall be accomplished prior to the System Functional Review (SFR).

JSSG-2010-7

VERIFICATION RATIONALE (4.7.2)

Verification of the occupant exposure limits specified for the crash protection system must be accomplished during the initial design stages of the air vehicle. The appropriateness of the selected injury criteria must be verified prior to the SFR in order to set boundaries on design approaches and justify recommended trade-offs. Verification of occupant exposure limits must be accomplished relative to identified threats within the specified crash environment. Allocation of proper exposure limits and classifications is critical to the subsequent qualification of the crash protection system.

VERIFICATION GUIDANCE (4.7.2)

The contractor's preliminary documentation package should be thoroughly reviewed from a biomedical engineering perspective to ascertain the existence and validity of recommended injury tolerance levels related to the vehicle's crash protection system. The verification process for this critical element of the crash protection system must be initiated during SFR, and follow the design process on through to the qualification test phase. Initially, crashworthiness-related computer models (e.g., KRASH, MSC-DYTRAN, SOM-LA, SOMA-TA, MADYMO, etc.) can be used to assess the design concept's compliance to the proposed injury tolerance levels. Ultimately, since human testing is unacceptable in crash impact testing, test surrogates such as the HYBRID III ATD will provide the dynamic test data for verification. Selection of the actual type and model ATD will be an essential issue for consideration in the verification process. Sensor and test dummy calibrations will play an extremely important role in the assessment of test results. Test plans need to require use of crewstation/passenger-area geometry and mockup structures of potential strike hazards to assess contact-related injuries.

Occupant exposure-limit verification testing of crashworthy systems is not performed with human volunteer testing as is done with some ejection seats. In fact, early crash resistant energy absorber designs were based on controlled human subject tests conducted on the U.S. Navy's ejection tower test facility. Analysis of these data resulted in specification of the 14.5 g limit load factor as the stroking force for the seat energy absorbers. This design parameter is specified in MIL-S-58095 (Army) and MIL-S-81771 (Navy) crew seat specifications, respectively. It correlates closely to NASA's Eiband Criterion ($+G_z$) and was verified by cadaver testing conducted at Wayne State University (see King, A.I., et al., "Human Cadaveric Response to Simulated Helicopter Crashes", Wayne State University; Bioengineering Center; Detroit, MI). The 14.5 g static design criterion considers the dynamic response of the seat and occupant. The factor of 14.5 g was established to limit deceleration of the seat/occupant system to less than 23 g for durations in excess of 0.025 seconds.

Automotive crash safety research has prompted a compilation of biomedical information in the area of crash impact injury tolerance. The Society of Automotive Engineers (SAE) has published a series of compendia related to tolerance levels of the human body in the automotive crash environment. Although the military aviation and automotive crash environments are not equivalent, the vehicle occupants sustain similar impact forces during survivable mishaps in either crash scenario. Several of the more important references are listed below:

SAE PT-43: Biomechanics of Impact Injury and Injury Tolerances of the Head-Neck Complex

SAE J885: Human Tolerances to Impact Conditions as Related to Motor vehicle Design

JSSG-2010-7

SAE SP-731: Injury Biomechanics

SAE PT-47: Biomechanics of Impact Injuries and Injury Tolerances of the Abdomen, Lumbar Spine and Pelvis Complex

SAE P-186: Biomechanics & medical Aspects of Lower Limb Injuries

AGARD 88: Protection of Brain from Injury During Impact: Experimental Studies in Biomechanics of Head Injury

SAE Automotive Safety: Anatomy; Injury; Testing; & Regulation; Jeffrey A. Pike

SAE PT - 44: HYBRID III: The First Human-like Crash Test Dummy

SAE 1988-12-0013: Testing & Evaluation of Hybrid III Load Sensing Face; Planath & Nilsson

DTIC: AD-A270 509: An Assessment of Potential for neck Injury Due to Padding of Aircraft Interior Walls for Head Impact Protection

Eiband, A.M., Human Tolerance to Rapidly Applied Accelerations: A Summary of the Literature, NASA Memorandum 5-19-59E, June 1959

NAWC-AD-PAX Lumbar Loads Test Report

AATD System Technical Characteristics, Design Concepts, and Trauma Assessment Criteria, Melvin, J.W., King, A.I., Alem, N.M., Sept, 1985; NHTSA Contract DTNH22-83-C-07005.

Clinical Biomechanics of the Spine; Augustus White III, Manohar Panjabi

Research continues in the area of injury tolerance, resulting in periodic refinements to accepted values and test methods. Table VI provides a summary of injury criteria and test methods currently applied by the military, and recommended changes for future military applications.

JSSG-2010-7

TABLE VI. Recommended military injury assessment test methods.

Injury	Location	Current requirement	Proposed military tolerance specification	Test Methods
Vertebral Fracture	Lumbar Spine	DoD: EIBAND Curve	Lumbar Force (Fz ; lbs) Criterion ; Limits established for Occupant Weights	Crew Seat EA System Crash Test (Gzx) with Hybrid III ATD
Vertebral Fracture	Cervical/ Neck	DoD: EIBAND Curve	Neck Forces & Moments SAE: PT-43	Crew Seat Crash Test (Gx) with Hybrid III ATD
Closed Head (Inertial)	Brain	DoD: None NHTSA: HIC ≤ 1000	SAE: PT-43 Head Injury Criterion (HIC) ≤ 1000 ; Angular Acceleration Limits (TBD)	Crew Seat System Crash Tests (Gx) with Hybrid III ATD (Non-impact)
<u>Skull/Brain Injury</u>	Head	DoD: None NHTSA: HIC ≤ 1000	HIC ≤ 1000	System Crash Test (Gx) with Hybrid III ATD into crew station impact hazard
Facial Bone Fractures	Face	None	Specific Facial Bone Fracture Levels (see Automotive Safety, Pike, J.)	Hybrid III Head Form with Load Sensing Face; Impact Tests/Pendulum Tests into hazard
Lower Limb Fractures	Femur Knee/Tibia	DoD: None NHTSA: Femur Load Criterion ~ 2250 lbs. NHTSA: Knee/Tibia	NHTSA Femur Limit NHTSA Knee/Tibia Limit	System Crash Tests (Gx) into mock-up structures of crew station strike hazards.
Upper Torso/Thorax	Heart, Lungs, Ribs, etc	DoD: None NHTSA: Thorax G_{Res} , <60 g's, clipped, @ 3 milliseconds. FAA: Shoulder Strap Loads <1750 lbs., (Single Strap); <2000 lbs., (Double Shoulder Harness) NHTSA: Thorax Compression (<3 inches)	Adopt NHTSA & FAA criteria adjusted to military restraint configurations	System Crash Tests (Gx) with 5th, 50th, 95th percentile males & 5th percentile female Hybrid III ATDs.

JSSG-2010-7

The summary shown in table VI demonstrates that currently (~1998) the primary human tolerance criterion used by the military to qualify crash resistant seating systems is based on the Eiband Curve. Figure 7 displays the pulse parameters (magnitude and duration) associated with the headward acceleration (i.e., “eyeballs down”) impact condition and the regions of severe and moderate injury versus the area of voluntary human exposure. This criterion was used as the injury tolerance design specification for the original Black Hawk crew seat’s load limiters.

VERIFICATION LESSONS LEARNED (4.7.2)

Caution must be exercised in the use of injury assessment criteria, since improper application of injury tolerance parameters can lead to an inaccurate prediction of a safety device’s capability to mitigate crash impact injuries. Pike (*“Automotive Safety: Anatomy, Injury, Testing, Regulation”*; 4.5 Test Criteria) discusses this issue extensively by providing the historical and biomechanical testing background for NHTSA’s fundamental human tolerance parameters cited in FMVSS 208. Several examples are provided below which highlight the adverse ramifications of improper use.

The Head Injury Criterion (HIC) evolved from Wayne State impact tests of cadaver heads into solid barriers. The original criterion was a tolerance parameter based on head acceleration and associated time durations. Test data was analyzed relative to threshold levels producing linear skull fractures. Eventually, these data were analyzed with an expression that raised the resultant head acceleration of the Hybrid III to the 2.5 power over a time interval not to exceed 36 milliseconds. By definition, and based on the original Wayne State impact tests, this expression must be less than, or equal to 1,000 for any such interval. However, the HIC has been misused at times by applying this parameter to non-impact situations, implying that HIC could be used to assess the severity of a head injury. The NHTSA has adopted the 36-millisecond time duration rule to pre-empt this practice since it is believed that most head contact accelerations are associated with time durations less than 36 milliseconds. Chapter 4 of *Automotive Safety* provides a comprehensive discussion on the development of the HIC and current assessments on its usefulness as a head injury tolerance index.

Misuse of injury tolerance parameters can also result from improper instrumentation techniques during impact testing of the crash protection system, with resulting misinterpretation of the data. *SAE Recommended Practice J211, entitled “Instrumentation For Impact Test”* outlines a series of performance recommendations concerning the total data channel. This practice provides guidelines and recommendations for the techniques of measurement used in impact tests. For example, the filter class recommended for analysis of vehicle structure and seat systems is a Channel Class of 60 Hz. This relatively low frequency response range has been shown to filter out high frequency spikes normally associated with accelerometer response when mounted directly to structure. During assessment of the first prototype energy absorbing crash resistant crew seats for the Black Hawk, a misinterpretation of one of the candidate seat’s performance data resulted when the filter class assigned to the subject seat was 1000 Hz. This permitted the Eiband analysis to ignore the fundamental characteristics of the seat’s acceleration-time profile that would have failed the seat. Instead, the high frequency analysis permitted the seat designer to argue that this prototype met the Eiband Criterion. Based on this verification controversy, *MIL-S-58095 “Seat System: Crash-Resistant, Non-Ejection, Aircrew, General Specification For”*, was revised with specific requirements pertaining to filter class selection and use of the analytical interpretation of seat response pulses as described in *MIL-S-9479*.

JSSG-2010-7

3.7.3 System functional requirements.

During and following a crash impact within the specified limits, the air vehicle's crash protection system shall protect occupants from the hazards of a crash. All aircraft elements that contribute to crash protection such as airframe structures, landing gear, seating, fuel systems, cargo restraint, and aircraft floatation systems shall be integrated to efficiently achieve the specified level of crash protection.

REQUIREMENT RATIONALE (3.7.3)

The functional requirements describe performance features of the crash protection system. Functional categories covered are: pre-crash warning; contact injury protection; acceleration injury protection, and post-crash injury protection.

REQUIREMENT GUIDANCE (3.7.3)

A systems engineering approach is necessary to efficiently integrate crashworthiness throughout the overall aircraft design. The top-level performance requirements, consisting of the crash protection envelope and injury tolerance criteria, must be flowed down to all appropriate subsystems. Ultimately, the performance requirements allocated for individual subsystems must insure that injury tolerance levels for aircraft occupants are not exceeded.

REQUIREMENT LESSONS LEARNED (3.7.3)

TBD.

4.7.3 System functional requirements verification

The functional requirements of the crash protection system shall be verified by review of design analyses, crash modeling and simulation, trade studies, static load tests, and dynamic crash tests. Specific components and subsystems shall be incrementally verified throughout the acquisition process based on the program milestones specified in 4.7.

VERIFICATION RATIONALE (4.7.3)

Incremental verification of the crash protection system is necessary to assure that each of the various components and subsystems have been properly integrated into a complete system providing the required level of occupant crash.

VERIFICATION GUIDANCE (4.7.3)

Guidance for verification of the various elements of the crash protection system are provided in 4.7 and in the sub-tiers under 4.7.3.

VERIFICATION LESSONS LEARNED (4.7.3)

With the initiation of the "guide specification" philosophy, the verification process takes on an even greater level of importance to acquiring an acceptable crash protection product. Many of the DOD's previous acquisitions were based on "design-oriented" requirements associated with proven concepts. In those cases, the verification process was intended primarily to show that the contractor met the government's specified design requirements. In the area of automotive crash safety, where performance based requirements have already been used for a number of years, many "innovative" design approaches have surfaced that need special test

JSSG-2010-7

considerations. Only after extensive customer use are some systems discovered to create hazards that were not anticipated, nor discovered, through past verification methods. The air-bag child restraint interference issue is a prime example of this type of potential problem. The similarity between the DOD specification guide approach and the NHTSA's Safety Standards should alert acquisition managers of the increased importance of thorough verification.

3.7.3.1 Pre-crash warning.

For troop and passenger carrying aircraft, the system shall provide a warning method or system that enables pilots, in the event of potential or impending mishap, to quickly and clearly convey a crash warning to aircraft occupants so that they can prepare for impact. The warning method shall be _____.

REQUIREMENT RATIONALE (3.7.3.1)

The crash warning system shall alert occupants of an impending crash, ditching or emergency landing to allow aircrew and passengers time to prepare for an emergency situation. Examples of actions which could be taken to enhance occupant survivability are:

- Stow loose equipment.
- Provide time for passengers to become seated and restrained.
- Take a bracing position, if appropriate to the specific seat/restraint configuration.
- Locate an emergency escape route and exit.
- Locate survival equipment (fire extinguishers, HEED, life rafts, etc.)
- Review emergency procedures.

REQUIREMENT GUIDANCE (3.7.3.1)

See MIL-STD-1807 for the following guidance in this area:

Pre-crash warning displays should be unambiguous and redundant (visual and auditory, for example)

Pre-crash warnings should not cause confusion or induce panic

When visual and auditory displays are used in conjunction with each other, the auditory warning devices should supplement or support the visual displays (MIL-STD-1800). JSSG-2010 provides further guidance for visual and auditory warning systems.

REQUIREMENT LESSONS LEARNED (3.7.3.1)

TBD

4.7.3.1 Pre-crash warning verification.

The pre-crash warning requirement specified in 3.7.3.1 shall be incrementally verified at specific program milestones throughout the development cycle. The following incremental verifications shall be accomplished prior to the specified review:

- a. System Requirements Review (SRR) - Verify that a requirement exists for a pre-crash warning system in the air vehicle specification and that an appropriate demonstration of the system's performance is scheduled during the air vehicle qualification-flight tests.

JSSG-2010-7

b. System Functional Review (SFR) - Verify that the functional requirements of a pre-crash warning system specified in 3.7.3.1 have been clearly defined within the contractor's development specification.

c. Preliminary Design Review (PDR) - Verify that the system complies with the development specification by a review of the contractor's preliminary engineering drawings and design analyses.

d. Critical Design Review (CDR) - Verify the pre-crash warning system's design by a review of final design drawings, product specifications, and preliminary passenger egress demonstration test data.

e. System Verification Review (SVR) - Verify that the production configuration complies with the requirements of 3.7.3.1 by a review of the air vehicle flight demonstration test report.

VERIFICATION RATIONALE (4.7.3.1)

The incremental verification process for this requirement will assure the incorporation of a pre-crash warning system which is integrated and compatible with the aircraft configuration.

VERIFICATION GUIDANCE (4.7.3.1)

The proposed approach for providing troops and passengers with a pre-crash warning should be assessed early in the program by personnel trained and experienced in human factors. Final verification of the system can be conducted by performing flight emergency drills during operational flight testing, and by including assessments of the system during emergency egress tests.

VERIFICATION LESSONS LEARNED (4.7.3.1)

TBD

3.7.3.2 Contact injury protection.

The system shall control and limit contact (strike) hazard injury potentials for each aircraft occupant. Contact-induced injuries shall not exceed human tolerance levels specified in 3.7.2.

REQUIREMENT RATIONALE (3.7.3.2)

A contact injury occurs when a localized portion of the body impacts a surface in such a manner that injury occurs at the site of contact. Contact injuries are the most probable type of injury an occupant will receive in a crash if proper prevention methods are not employed in the air vehicle design. Shanahan (see *"Injury in U.S. Army Helicopter Crashes October 1979-September 1985"*, *The Journal of Trauma*, 1989.) reports that the most commonly identified mechanism of injury was that an individual was struck by or against an object (60.1 percent). This was followed in frequency by the mechanisms: "experienced/exposed to" (20.3 percent) and "caught in or under" (5.7 percent). The same study showed that 88 percent of all Army Class A and B helicopter crashes were considered survivable, yet 38 percent of all fatalities and 96 percent of disabling injuries arose from survivable crashes. Of the injuries for which a mechanism was identified, the number of contact injuries exceeded accelerative injuries by a ratio of approximately five-to-one.

JSSG-2010-7

REQUIREMENT GUIDANCE (3.7.3.2)

In designing an aircraft interior, it is extremely important to consider the local environment of the occupants at all potential seating locations. A person's local environment refers to the space that any portion of his body may occupy during dynamic crash conditions. Any object within that space may be considered a strike hazard. The volume and geometry of that space will vary depending on the type restraint system anticipated and, to a lesser extent, on the anthropometry of the occupant population. Clearly the primary concern must be for hazards within the strike zone of the head and upper torso, but objects within the strike zone of the extremities must also be considered since injuries to the extremities may interfere with egress and survival after the crash.

Prevention of contact injuries requires the implementation of strategies that will prevent body contact with potentially injurious objects. This may be achieved by: body restraint systems, ruggedized airframe designs to prevent intrusion of structure and high mass components into occupied areas, preventing loose objects and ancillary equipment from becoming missile hazards and the removal or de-lethalization of objects that cannot be removed from the strike zone of the occupant. De-lethalization is usually accomplished through padding or frangibility of the hazardous object.

Equipment design factors influencing injury, not generally familiar to the designer include:

- Relative velocity between the impacting equipment and the occupant.

- Impact site on the occupant.

- Area on the occupant over which the force is dissipated.

- Mass of impactor or impacting equipment.

- Geometry of the impactor (sharp edges, etc.)

- Surface hardness or compliance of the equipment (ability to conform to the corresponding surface of the occupant's body).

- Equipment surface roughness.

- Energy absorption characteristics of the equipment.

- Direction of impact force.

- Duration or time history of the impact force.

These factors act concurrently and are interdependent in their effect. One other factor, not within the control of the designer, is the injury tolerance level of the occupant, which varies over a large range due to age, general health, physical size, and skeletal development.

Some fundamental contact injury prevention guidelines are provided below:

- Distribution of load over a large body area, particularly over bony structures such as the pelvis will tend to decrease injury.

- Elimination or reduction of the flailing distance available for arms, legs, upper torso, and head generally decreases injury by reducing the relative velocity between the body and the impacted surface.

- Distribution of the impact loads over the body by use of lightweight structure or padding that plastically deforms, with minimum elastic rebound, will generally decrease injury.

JSSG-2010-7

The use of systems that are largely elastic in their response to impact may increase injury since they store the energy of the impact for rebound into the body.

Deformation of material under impact loads should not expose structure that could cause injury.

Items within the passenger cabin that become loose can cause injury if they contact occupants during the crash. These items should be located so as to reduce the likelihood of contact whenever possible, even if their retention system should fail. Deflections of the cabin's interior contents during an impact should be considered when designing the retention system.

As an aid to understanding typical strike envelope dimensions for both the lap belt only restraint, and the combination shoulder/lap belt system, strike envelope figures from the Army Crash Survival Design Guide are provided here.

Restraints, along with cushions, provide the interface between the occupant and the rest of the seating system. Because of this, they perform a critical function in providing occupant safety during a crash. Ensure that restraint harnesses for personnel provide the restraint necessary to prevent injuries to all aircraft occupants as crash conditions approach the upper limits of survivability. Ensure that personnel restraint harnesses (1) are comfortable and light in weight; (2) are easy to put on and remove; (3) contain a single-point release system which is easy to operate with either hand (since a stunned or injured person might have difficulty in releasing more than one buckle with a specific hand) and is protected from inadvertent release; (4) provide freedom of movement to operate the controls of the aircraft (usually necessitating the use of an inertia reel in conjunction with the shoulder harness); (5) provide sufficient restraint in all directions to prevent injury due to decelerative forces in a potentially survivable crash; (6) have a harness webbing which provides a maximum area for force distribution in the upper torso and pelvic regions; and (7) prevent injuries due to submarining and minimizes the crash force amplification of dynamic overshoot.

JSSG-2010-7

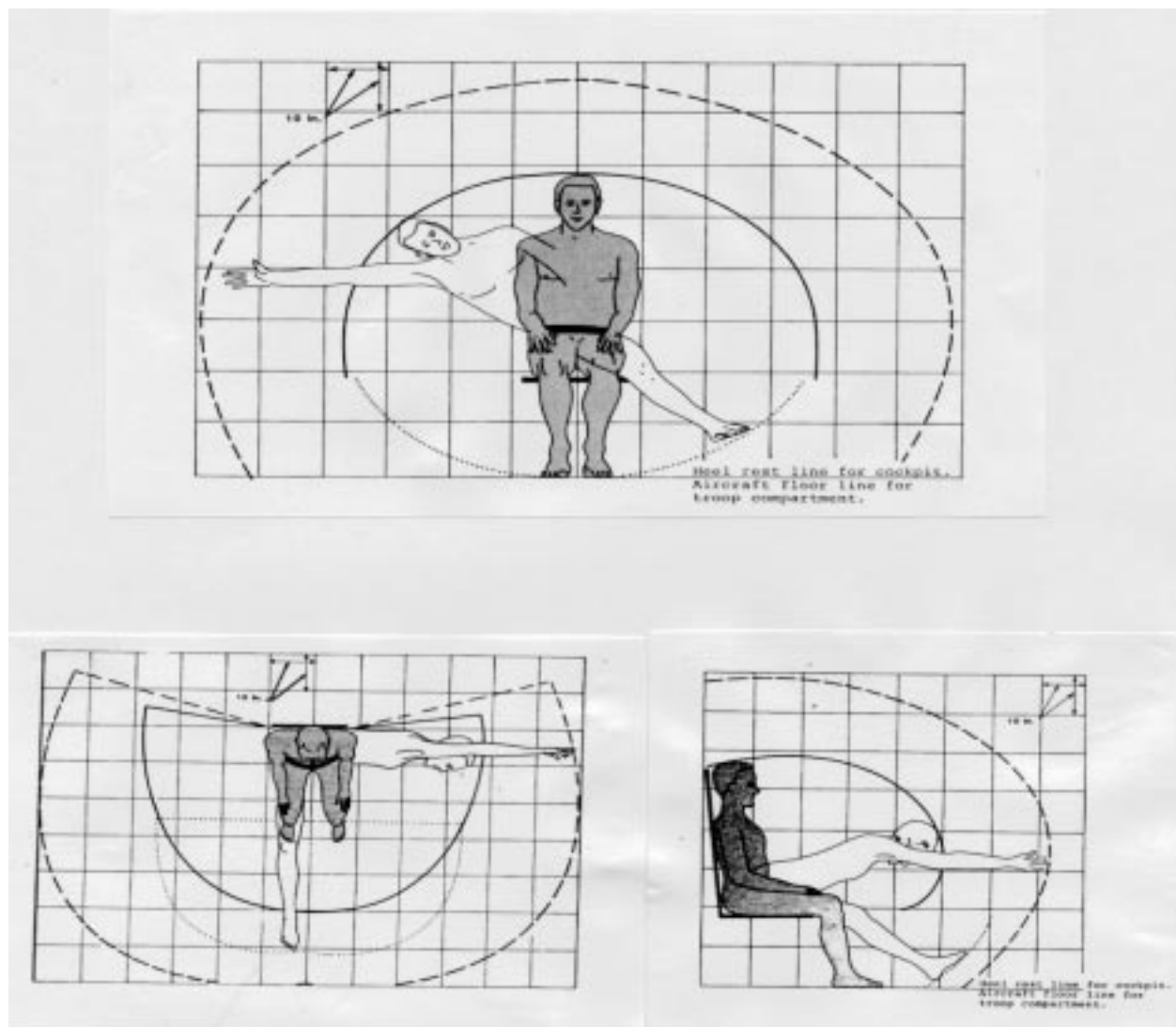


FIGURE 12. Occupant strike envelope with lap belt only restraint.

JSSG-2010-7

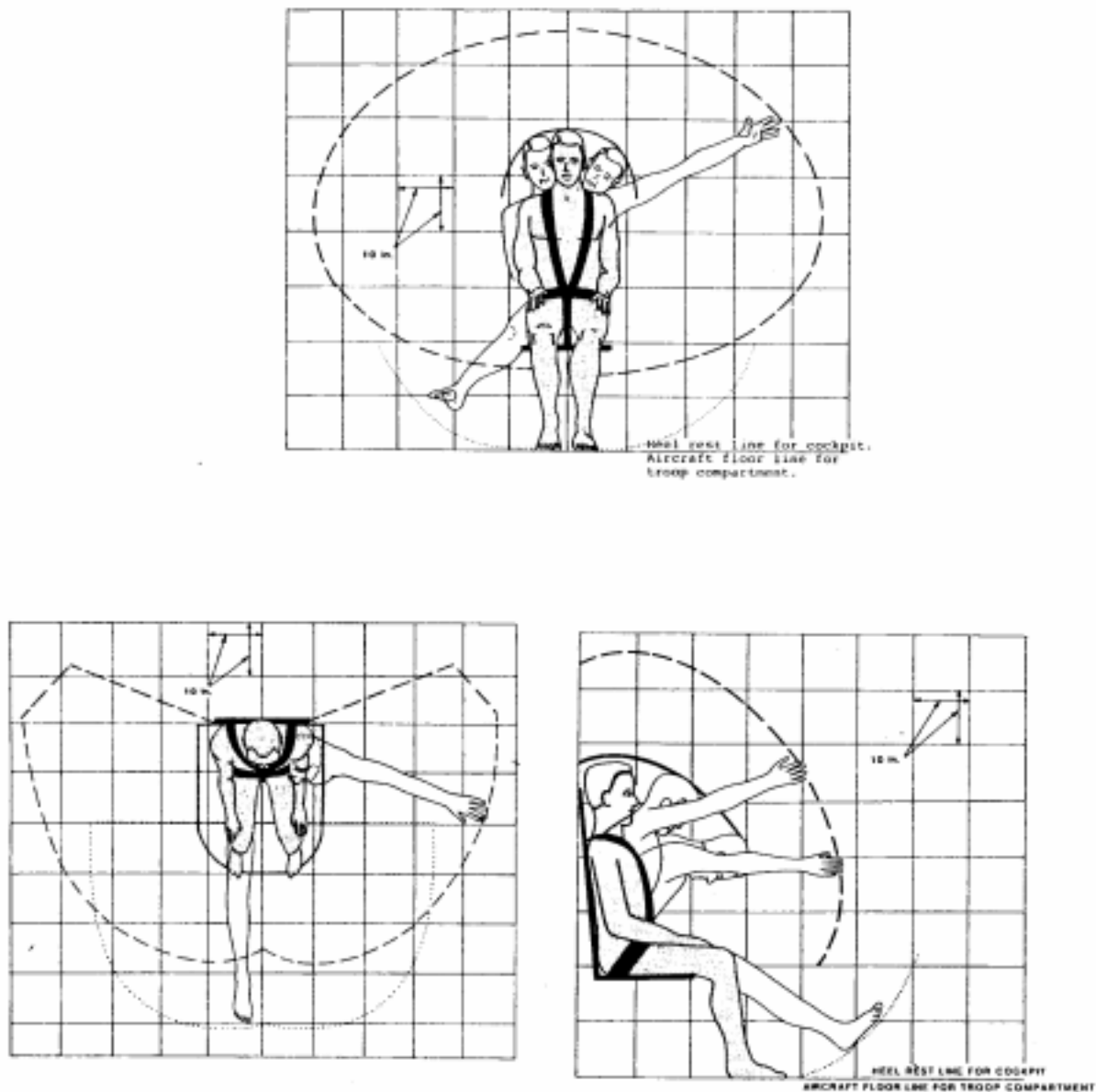


FIGURE 13. Occupant strike envelope with shoulder harness and lap belt.

Other system requirements used in the past include the following:

Comfort. Comfort is important because discomfort can induce fatigue that can contribute to and cause accidents. Design personnel restrain harnesses so that they are comfortable to the wearer, in addition to meeting crash survival requirements. For example, a lap belt with an adjustment buckle located directly over the iliac crest bone provides a constant source of irritation that results in eventual fatigue to the wearer. The primary comfort consideration for

JSSG-2010-7

restraint harnesses is the absence of rigid hardware located over bony portions of the torso. The straps of the harness, however, should provide for restraint through the rigid, bony structures of the body rather than softer portions that would be easily injured due to compression in a crash.

Emergency release requirements. It is preferable that a shoulder harness/lap belt combination have a single point of release that can be operated by one (either) hand. Rapid release of an occupant's restraint system can be critical to survival considering the post-impact threats of fire and submersion. Typically, restraints should be designed so that between 66.7 and 111.2 N (15 and 25 lb) force is needed to release the harness with one finger after application of design crash loads. An excessive force can hinder rapid emergency release, while a light force can cause inadvertent release. It is also essential the restraint harness be capable of release with the occupant hanging in an inverted aircraft.

Lap belt anchorage. Normally, the actual anchorage point for the lap belt should be on the seat bucket. In these cases, the anchorage point for the lap belt should be on that portion of the seat bucket which strokes during vertical crash force attenuation. If the anchorage must be located on basic aircraft structure, consideration must be made for the movement of the seat when load-limiting devices are used, so that the lap belt restraint remains effective. Slack in the restraint system can cause problems such as submarining and dynamic overshoot (amplification of crash forces due to differential deceleration of the aircraft and occupant). A vertically load limited seat with a lap belt attached to the structure, for example, would become slack during the seat stroke unless somehow compensated. Give careful consideration to the belt strength properties since, in addition to the occupant, the belt also restrains the motion of the seat. Anchor the lap belt so that it provides optimum restraint for the lower torso when subjected to $-G_x$ forces. Locate the belt centerline 50.8 to 76.2 mm (2 to 3 in.) forward of the seat back and cushion intersection (seat reference point) on a line parallel with the horizontal vision line to yield the correct angle. Ensure that the lap belt and attachments are capable of displacing 30° vertically and 60° laterally from the normal positions while sustaining belt design loads without producing eccentric loads in either the straps or the attachment fittings. This prevents a purely lateral loading on the torso from resulting in anchorage failure. Do not locate the seat belt so that the belt centerline coincides with the seat reference point. This location results in a 35 to 40° angle with the seat pan; forward displacement during $-G_x$ deceleration, resulting from belt elongation, tends to reduce this angle further. In an accident with high vertical and longitudinal forces present, the restrained body tends to sink down into the seat first and then almost simultaneously be forced forward. If the lap belt angle is less than about 45° , the belt tends to slip over the iliac crests of the pelvic bone, and the pelvis can rotate. The inertia load of the hips and thighs tends to pull or "submarine" the lower torso under the belt. As the lap belt angle is increased above 45° , the load in the belt becomes higher for a given torso deceleration.

The maximum angle should not be greater than about 55° . "Submarining" must be prevented because of the very low compressive tolerance of the spine when it is hyper-flexed (bent) around the seat belt. In addition, it can cause severe to fatal internal injuries. A center tie-down strap helps prevent submarining by counteracting the upward pull of the shoulder harness.

Shoulder harness anchorage. Locate the shoulder harness or inertia reel anchorage preferably on the seat back structure. Locating the anchorage on basic aircraft structure relieves a large portion of the overturning load applied to the seat in a longitudinal loading, however, this approach is usually incompatible with load-limiting seats that permit movement of the seat bucket. Design shoulder straps to pass over the shoulders in a plane parallel to the

JSSG-2010-7

horizontal vision line or at any upward angle not exceeding 25°. Any installation that places the straps at an angle below the horizontal adds additional compressive force to the seat occupant's spine. A shoulder harness pull-off point of 660.4 mm (26 in.) vertically above the parallel horizontal vision line passing through the seat reference point is needed to ensure that the straps are perpendicular to the spine of a 95th percentile (shoulder height, sitting) man. Do not permit the shoulder harness anchorage or guide at the top of the seat back more than 12.7 mm (0.5 in.) lateral movement in order to ensure that the seat occupant is properly restrained laterally.

Three restraint configurations for various seat orientations are:

Forward-facing harness. The existing military lap belt and shoulder harness configuration with a center tie-down strap added is the minimum acceptable harness for use by pilots. The center belt tie-down strap resists the upward pull of the shoulder straps so that the belt is not displaced into abdominal tissue. The tie-down strap is comfortable to wear, since it does not contact the pelvis, and it is 38.1 mm (1.5 in.) wide so that minimum leg rubbing is encountered by during rudder pedal operation. The configuration flown in the F-111 provides improved lateral restraint. Side straps assist in restraining the thighs against lateral loads as well as offer some resistance to "submarining." Permanently attach the side straps to the lap belt (e.g., by stitching). However, seats with adequate side support from deep buckets may not need to use side straps. The F-111 also has reflected shoulder straps that provide very good upper torso restraint to lateral loads according to testing. The reflected shoulder strap webbing from the inertia reel passes through a roller and is permanently fastened toward the top of the seat back on the other side of the seat (webbing from the inertia reel located toward the left side of the seat is fastened on the right side). The roller is sewn to the shoulder strap that connects to the single-point attachment and release fitting.

Aft-facing harness. The need for side straps and a tie-down strap is negligible for the aft-facing passenger, since the seatback provides the primary restraint. Retain the shoulder harness, however, because of occasional crashes in which lateral forces are incurred.

Side-facing harness. It is difficult to provide adequate restraint for side-facing passengers with a lap belt and shoulder harness alone. Leg restraint also is preferred. However, leg restraint is generally not practical because of operational requirements that necessitate side-facing seats in tactical aircraft. The standard lap belt with a shoulder harness, reflected shoulder strap, and side belt strap offers a compromise solution. The belt side straps help to hold the belt in place over the pelvic region and provide more area to resist the pressure from the pelvis. The reflected shoulder strap provides the upper torso restraint.

REQUIREMENT LESSONS LEARNED (3.7.3.2)

Fundamental approaches for protecting aircraft occupants from contact hazards at seating stations during crashes is the same for all aircraft types, although the details of achieving a given degree of protection usually depend upon the specific situation. Occupant kinematics associated with aircraft impacts can be violent, even in accidents of moderate severity. The flailing of body parts is much more pronounced when the aircraft occupant is restrained in a seat with a lap belt only. However even with a combined lap belt / shoulder harness, tightly adjusted, multi-directional flailing of the head, arms, and legs, and to a lesser extent, lateral displacement of the upper torso within its restraint harness is significant. Space for occupants is usually at a premium in aircraft, especially in cockpit areas, and it's not always feasible to remove structural elements that could be hazardous. A viable alternative is to de-lethalize the

JSSG-2010-7

surrounding environment such that when body parts flail and contact rigid and semi-rigid structures, injury potential is minimized. The following prioritized approach is recommended.

Provide primary restraint system.

Remove hazardous objects that are within the occupant motion envelope associated with the primary restraint.

Provide supplemental restraint systems such as air bags.

Delethalize remaining hazards.

It is important to evaluate the local environment of occupants during the design phase of an aircraft since many potentially hazardous objects may be placed outside of the strike zone if they are recognized as hazards. Potentially injurious objects that cannot be relocated can be designed to be less hazardous, padded, or made frangible.

Several countermeasures are in progress to address potential strike hazards. First, the MA-16 inertia reel has been qualified and is currently being retrofit into rotorcraft and fixed wing aircraft. The MA-16 provides a dual mode dynamic response capability to the inertia reel that produces lock-up in response to both vehicle acceleration and webbing pay-out.

Eisentraut (USAAVRADCOM-TR-83-D-23: "Crashworthy Cyclic Control Stick", Nov. 1983) describes a design of a "crashworthy" cyclic which has been delethalized to reduce head/neck loading during contact with the cyclic. However, since this design approach does not eliminate the possibility of injury, it has not been pursued further. Another design approach used in a Russian attack helicopter includes pyrotechnic displacement of the cyclic stick, linked to a crash sensor activation circuit.

The U.S. Army and Navy developed the Inflatable Body and Head Restraint System (IBAHRS), shown below on figure 14, as a "supplemental" restraint to minimize head and upper torso contact injuries with aircraft interior structures. Qualification testing of the IBAHRS demonstrated that crewmember head strikes were prevented in 41 of 44 test trials at crash severities associated with the Marine Corps AH-1W Super Cobra. (Reference: "Inflatable Body and Head Restraint System (IBAHRS) - Dynamic Qualification Tests", Volume I, Test Report, 15 May 1995, Naval Air Warfare Center).

The U.S. Army is leading a joint service effort to develop and incorporate airbag systems within aircraft crew stations to supplement the military's standard five-point restraint harness. The program is called the Cockpit Airbag System (CABS) with the H-60 identified as the initial aircraft application. The UH-60 airbag configuration is shown on figure 14.

Restraint pre-tensioners are also being studied by the Navy as a potential countermeasure to preclude head and upper torso contact injuries. These devices can remove significant amounts of slack in a shoulder harness when activated by a crash sensor prior to the crash event.

JSSG-2010-7

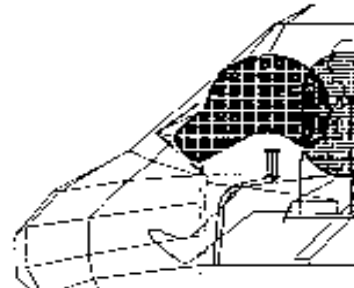
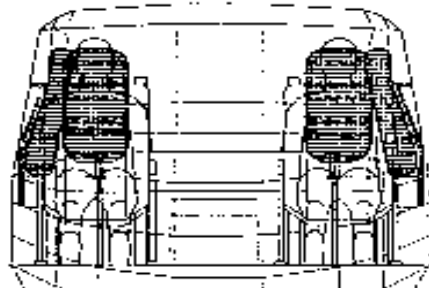
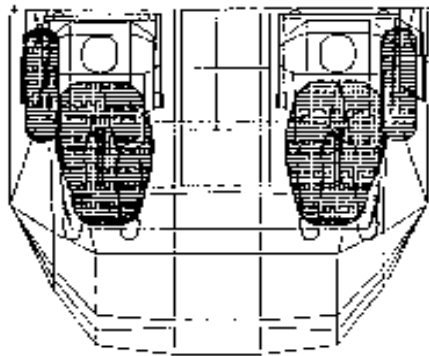
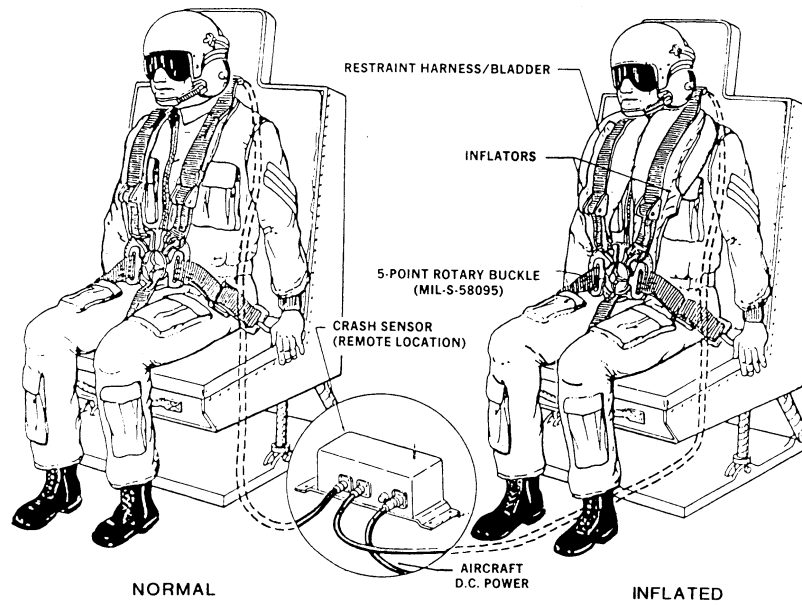


FIGURE 14. Inflatable body and head restraint system (above) and cockpit airbag system (below).

JSSG-2010-7

4.7.3.2 Contact injury prevention verification.

Systems intended to prevent contact injuries shall be verified by analysis, crash modeling, simulation and dynamic crash testing with anthropometric test devices (ATDs) to assure that compliance with the injury tolerance criteria of 3.7.2. Representative mock-ups of all strike hazards within the occupant strike envelope s shall be included during dynamic crash tests to assess contact injury potential.

VERIFICATION RATIONALE (4.7.3.2)

Dynamic analyses, simulations, and tests are necessary to establish that aircraft occupants will not receive serious strike injuries in the dynamic environment of survivable crashes.

VERIFICATION GUIDANCE (4.7.3.2)

Although static geometric analyses and dynamic computer simulations such as SOM-LA, SOM-TA, and DYNAMAN can provide initial assessments of strike envelopes, the ultimate verification method must include dynamic crash tests of the crew station and/or passenger seat environment using ATDs as the test surrogates.

The system's ability to meet this requirement should be incrementally verified throughout the program. Incremental verifications should become more detailed and robust as the system design matures. The specific verifications are specified in the following subparagraphs.

VERIFICATION LESSONS LEARNED (4.7.3.2)

Use of mock-up structures and high-speed video analysis of Anthropomorphic Test Dummy (ATD) motions provide test data necessary for assessment of the system's capability. In addition, current ATDs with enhanced bio-fidelity such as the HYBRID III possess sophisticated instrumentation sensors to measure contact forces and accelerations for comparative assessments of alternate designs. However, current ATDs still display less range-of-motion under dynamic conditions compared to humans. Therefore, strike zones identified by the ATDs should be regarded as an underestimation of crash-induced flail distances.

Military testing of the Inflatable Body And Head Restraint System and Cockpit Air Bag System (IBAHRS) incorporated structural mock-ups of the operational strike hazards within the target aircraft for appropriate measurements of head contact forces and calculation of the Head Injury Criterion (HIC).

The test methodology described within the IBAHRS Qualification Test Report referenced above provides an alternate high-speed video analysis approach to acquiring kinematic test data to assess a structure's potential for inducing contact injuries when mock-up structures are not feasible or cost-effective.

3.7.3.2.1 Preservation of occupied space.

When subjected to the crash conditions specified in 3.7.1, the aircraft structure shall maintain sufficient structural integrity in occupied spaces for the safe containment of occupants, and shall prevent the intrusion of injurious structures and/or objects into occupied spaces. In addition, high mass components such as engines, transmissions, and other equipment shall be designed to prevent uncontrolled displacement into occupied spaces during a crash defined by the impact parameters herein specified and the following static load factors:

JSSG-2010-7

- | | |
|--|--|
| <p>a. Applied Separately:</p> <p>(1) Longitudinal: _____ G.</p> <p>(2) Vertical: _____ G.</p> <p>(3) Lateral: _____ G.</p> | <p>b. Applied Simultaneously:</p> <p>(1) Longitudinal: _____ G.</p> <p>(2) Vertical: _____ G.</p> <p>(3) Lateral: _____ G.</p> |
|--|--|

The air vehicle structure shall exhibit the following minimum crush characteristics:

a. The basic airframe shall be capable of impacting longitudinally into a rigid vertical barrier or wall at a contact velocity of _____ ft/sec without reducing the length of the aircrew compartment by more than _____ percent.

b. The basic airframe shall be capable of impacting longitudinally into a rigid vertical barrier or wall at a contact velocity of _____ ft/sec without reducing the length of the passenger/troop compartment more than _____ percent.

c. The basic airframe with landing gear extended shall be capable of withstanding vertical impacts of _____ ft/sec on a rigid horizontal surface without reducing the height of the cockpit and passenger/troop compartments by more than _____ percent. For the case of retracted landing gear, the basic airframe shall be capable of withstanding vertical impacts of _____ ft/sec on a rigid horizontal surface without reducing the height of the cockpit and passenger/troop compartments by more than _____ percent. In both cases, occupants shall not experience injurious accelerative loading during the impact. These requirements are cited for all aircraft orientations (attitudes) within +15 to -5 degrees pitch and ± 10 degrees roll.

d. The basic airframe shall be capable of withstanding lateral impacts of _____ ft/sec without reducing the width of occupied areas by more than _____ percent.

The air vehicle shall include the following rollover characteristics:

a. The basic airframe shall be capable of resisting an earth impact loading as occurs when the aircraft strikes the ground and rolls to either a 90 degree (sideward) or 180 degree (inverted) attitude without permitting deformation sufficient to cause injury to seated, restrained occupants.

b. A rollover design criteria relative to application of rollover loads shall be established and the following load factors times the design gross weight (DGW) of the aircraft shall apply:

- (1) Perpendicular to ground: _____.
- (2) Parallel to ground, along longitudinal axis: _____.
- (3) Parallel to ground, along lateral axis: _____.

Detailed performance requirements for crash resistance of airframe structures are provided in the Structures section of the Airframe Specification Guide.

REQUIREMENT RATIONALE (3.7.3.2.1)

The aircraft structure needs to possess sufficient strength to prevent intrusion of structure into occupied spaces during a survivable crash, thus maintaining a protective shell around all occupants.

REQUIREMENT GUIDANCE (3.7.3.2.1)

The following design guidance relative to contact injury countermeasures has been extracted from MIL-STD-1290 and FAA Airworthiness Standards, Parts 25, 27, 29 Subpart C:

Provide sufficient structural strength in the protective shell around the occupants to prevent

JSSG-2010-7

bending and buckling failure of the fuselage, or design “controlled” failure modes into the system

Install high-mass items so that they will not intrude into occupied areas or within the established strike envelopes during the crash.

Deform the fuselage outward, if at all possible, rather than inward into living space.

Provide structural strength and shape to prevent plowing, reducing the decelerating forces on the aircraft.

Design for water impact loading for applicable missions.

Incorporate rollover strength cited in MIL-STD-1290.

Position occupants away from likely fuselage fracture areas

Enhance floor strength to be compatible with seat anchorage strength.

Ensure that load paths will not cause protective envelope of aircraft structure to fail in a hazardous manner.

The “high-mass retention” paragraph of MIL-STD-1290 provides the following guidance:

Light fixed-wing aircraft. Engine mounts shall be designed to keep the engine attached to the basic structure supporting the mount under the crash conditions cited herein, even though considerable distortion of the engine mount and support structure occurs. The basic structure supporting the engine shall fail or separate before engine mount failure occurs. Engine mounts and supporting structures, including firewall bulkheads, shall be designed to minimize earth scooping.

Rotary wing, including tilt-prop/rotor aircraft.

a. Mounting of engines, transmissions, fuel cells, rotor masts and other high mass items shall be designed to prevent their displacement in a manner that would be hazardous to occupants under the crash conditions cited herein.

b. The transmission and rotor hub shall not displace in a manner hazardous to the occupants during the following impact conditions:

(1) Rollover about the vehicle’s roll or pitch axis.

(2) Main rotor blade obstacle strike that occurs within the outer 10 % of blade span assuming the obstacle to be an 8 inch-diameter rigid cylinder.

c. All high mass items which could pose a hazard to personnel during a crash shall be designed to withstand the following ultimate load factors:

(1) Applied Separately:

Longitudinal	±20
Vertical	+20/-10
Lateral	±18

JSSG-2010-7

(2) Applied Simultaneously:

	<u>Condition</u>		
	<u>A</u>	<u>B</u>	<u>C</u>
Longitudinal	±20	±10	±10
Vertical	+10/-5	+20/-10	+10/-5
Lateral	±9	±9	±18

d. MIL-STD-1290 provides a design criterion for rollover conditions as follows: The aircraft shall be assumed to be resting inverted on the ground in the most likely attitude which is critical for the safety of the occupants. Loads should be then be individually applied locally and consist of the following load factors times the DGW:

- (1) 4 perpendicular to the ground.
- (2) 4 along the longitudinal axis, parallel to the ground.
- (3) 2 along the lateral axis, parallel to the ground.

REQUIREMENT LESSONS LEARNED (3.7.3.2.1)

A major consideration in preventing contact injury is high-mass item retention. Current FAA standards for retention of high-mass items such as transmissions and engines, are relatively low when compared to military requirements. Intrusion of these components into occupied spaces frequently has tragic consequences. It was observed in several early mishaps of the UH-60 Black Hawk that engine/transmission intrusion was occurring into the cockpit/cabin areas. The estimated vertical impact velocity-changes were greater than the MIL-STD-1290 design limit during these mishaps. This condition sometimes resulted in the roof structure contacting the crew seats in the cockpit. Fortunately, the crew seat's frame design provided a "roll bar" effect as the seated occupant stroked downward, preventing head contact injuries. In the cabin, the displacing roof structure adversely affected the performance of the energy absorbing troop seats, which were anchored to the roof structure. Total roof downward displacement consisted of both plastic and elastic excursions.

Army mishap investigations have documented rotor intrusions within the UH-1, AH-1, and OH-58, but this failure mode has not occurred in the MIL-STD-1290 designed UH-60 BLACK HAWK.

The V-22 design accommodates high-mass retention via a progressive failure mode design for the props-wings-fuselage, such that the habitable volume of the cockpit/cabin is sustained by an inertial unloading of the fuselage. The basic fuselage frame structure was designed to an ultimate strength approximately 15 percent stronger than the wings. In addition, prop failure modes were designed to direct the fractured blades away from the occupied fuselage structure.

In the past, consistency in crash load requirements within US Navy specifications was only partially achieved. Several examples are worth noting here to preclude a recurrence of these inconsistencies within the requirements of this guide specification.

Prior to the use of Joint Service Specification Guides, the US Navy cited *SD-24 (Volume II), "General Specification for Design and Construction of Rotary Wing Aircraft"*, as its general specification upon which the contractor could base and prepare a "detailed/type" aircraft specification. The April 1985 issue of SD-24L (Volume II) incurred two errors: First, in

JSSG-2010-7

3.4.1.1.1, "Aircraft Crashworthiness", it pre-selected the impact velocity-change for the aircraft. The paragraph stated: "aircraft including landing gear, structure and seats, shall be designed as an energy absorber system for the 85th percentile crash velocity change as defined in MIL-STD-1290". Selecting the 85th percentile crash velocity change prior to a preliminary design analysis was premature. Deviations permitting lower velocity change requirements should be granted on a "type specification" basis, only; and secondly, 3.4.1.1, entitled "Detail Strength", stated that "strength and rigidity should comply with MIL-A-8863 and AR-56". Both references attempt to cite reasonable crash loads requirements for the crash safety of rotorcraft occupants, but fail to impose a "systems engineering design methodology" to achieve this goal. For example, AR-56, "Aeronautical Requirements, Structural Design Requirements (Helicopters)", cites a vertical impulse requirement which is more stringent than the MIL-STD-1290 velocity change (i.e., if one considers a triangular-shaped pulse of 25 g-peak and 0.20 sec. duration, AR-56 actually imposes an 80.5 fps velocity change). This design pulse equates to a 2.5 increase in crash severity (i.e., impact energy) versus the current MIL-STD-1290 level of 50 fps. Similar inconsistencies are noted in the other impact directions as shown below:

AR-56, 3.4.7, Crash Loads. "...The following are maximum impulse requirements:

"Vertically $N_z = 25$ g for 0.20 seconds

"Laterally $N_y = 25$ g for 0.20 seconds (forward facing seat)

"Forward $N_x = 45$ g for 0.10 seconds (forward facing seat)."

Paragraph 3.4.7 of AR-56 also cites static ultimate inertia load factors that are inconsistent with the above impulse parameters. For example, the following static load factors were cited for crew seats, passenger seats, troop seats, litters, etc., all acting separately, or alternately:

Forward 20 g

Vertical 20 g (and upward)

Lateral 10 g

Relative to MIL-A-8863, "Airplane Strength and Rigidity, Ground Loads for Navy Acquired Airplanes", 3.14.9, "Maximum allowable load factor on occupants" states:

"Occupants of the airplane shall not be subjected to a peak vertical load factor greater than 20 G for all conditions required by this specification. Also, the type of structure surrounding and under the occupants shall be such that in crashes following collapse of the nose gear, large amounts of energy will be absorbed by progressive failure of the structure to limit the vertical load factor at the seat to 20 G. This requirement is intended to provide a reasonable probability of survival predicated on human tolerance to vertical loads."

This requirement neglects to account for the time dependent nature of human response to acceleration-induced injuries as demonstrated in the EIBAND Curve Criterion. The paragraph does address the need for a crash resistant design that incorporates "progressive failure" of the structure to limit loads experienced by occupants. However, it does not direct the designer to integrate the effects of landing gear, structure and seats to manage crash impact energy by a systems design approach.

The above examples emphasize the importance of ensuring that the crash protection system's requirements are compatible and consistent with the aircraft structures' and subsystems' requirements.

JSSG-2010-7

4.7.3.2.1 Preservation of occupied space verification.

The requirement for preserving occupied space specified in 3.7.3.2.1 shall be incrementally verified by analysis, crash modeling and simulation, and testing appropriate to the program phase. The following incremental verifications shall be accomplished prior to the specified review:

- a. System Functional Review (SFR) - Verify that all appropriate contractor documentation (i.e. specifications, systems engineering master schedule, and contract statement of work) include appropriate analyses, trade studies, simulations, and tests to demonstrate the system's capability to meet the requirements of 3.7.3.2.1.
- b. Preliminary Design review (PDR) - Verify that all preliminary design drawings, structural deformation analyses, trade studies and component/subsystem tests adequately demonstrate compliance with the requirements of 3.7.3.2.1.
- c. Critical Design Review (CDR) - Verify that all detailed design drawings, detailed structural analyses, final trade studies, and component or structural subassembly static and dynamic tests demonstrate compliance of the final design configuration to the requirements of 3.7.3.2.1.
- d. System Verification Review (SVR) - Verify through a review of all qualification test reports, test data and pre-production drawings that the pre-production configuration of the crash protection system meets the requirements of 3.7.3.2.1.

VERIFICATION RATIONALE (4.7.3.2.1)

It's important to begin verification of the "Preservation Of Occupied Space" requirement as early as possible in the aircraft design/development process. This requirement has a large effect on the basic airframe structure, which is defined early in the aircraft development process. In order for the results of dynamic structural analyses and occupant injury trade studies to be effectively incorporated into the design, they must be conducted early in the program with continuous feedback into the preliminary aircraft sizing and layout process.

VERIFICATION GUIDANCE (4.7.3.2.1)

Verifications should be tailored to the type of analytical tools available at the time of system procurement. There should be a proper balance of analytical detail with program cost. In the past this balance has effectively limited the type of analysis available to support early design tradeoffs to relatively simple structural dynamic models such as SOM-LA and KRASH. With the rapid growth of computational power and structural dynamics software capabilities, it's foreseeable that more detailed structural analysis programs, such as MSC/DYTRAN (*MSC/DYTRAN is a registered trademark of the MacNeal-Schwendler Corporation, Los Angeles, CA*), can be used in the early stages of system development. Most metal airframe structures deform both plastically and elastically in a crash impact with some partial rebound from a maximum displacement. Therefore, it's important to conduct analyses of the occupied space with structural models which accurately model large displacements into the plastic range of a material, and which account for dynamic spring-back of the structure. The solicitation should emphasize the need for the contractor to utilize the most effective analytical tools available in order to ensure that this important element of crash survivability can be effectively considered in the development process. References cited below provide descriptions of current computer crash codes and some examples of their use in assessing structural response to impulsive loading. *The Army Research Laboratory's evaluation of candidate modeling and*

JSSG-2010-7

simulation codes is provided in VTC NR 97-07. The objective of this science and technology objective (STO) is to establish a standardized and validated structural crash dynamics modeling and simulation capability from a single selected off-the-shelf computer code that can satisfy the need for a crashworthy performance and design evaluation tool.

References:

Gamon, M.A., et al, "KRASH 85 User's Guide; Input-Output Format", DOT/FAA/CT-85/10, Jul 1985.

Laananen, D.H., "Computer Simulation of An Aircraft Seat and Occupant (s) in a Crash Environment - Program SOM-LA/SOM-TA User Manual", DOT/FAA/CT-90/4, May 1991)

Fasanella, E.L., Jackson, K.E., Lyle, K.H., "Crash Simulation of an Unmodified Lear Fan Fuselage Section Vertical Drop Test", presented at AHS 54th Annual Forum, May, 1998

Jackson, K.E., and Fasanella, E. L., "Innovative Composite Fuselage Design for Improved Crashworthiness", presented at AHS 54th Annual Forum, May, 1998

Jackson, K.E., Fasanella, E. L., Lyle, K. H., "Science and Technology Objective on Structural Crash Dynamics Modeling and Simulation; Phase 1. Year-end Report Evaluation of Candidate Modeling and Simulation Codes", VTC NR 97-07, November, 1997

Prasad, P., Chou, C.C., "A Review of Mathematical Occupant Simulation Models", Accidental Injury, Biomechanics and Prevention Textbook, edited by Nahum and Melvin 1993.

In order to verify that each occupant's seating station provides a survivable environment throughout the crash event, it is first necessary to identify the flail envelope for each occupant. This establishes the space to be protected against structural intrusion. As a first order approximation to support preliminary layout and analysis of structural deformation relative to these predicted flail envelopes, the flail envelope diagrams provided above can be used until detailed analytical simulations can be run to accurately verify strike hazards. It should be recognized, however, that these flail envelope diagrams were based upon a certain set of conditions (identified in Army Crash Survival Design Guide) which may not apply to all design crash impulses for the aircraft being procured. The specifics of seat orientation, type of restraint, design survivable crash pulses and other factors must be considered in the detailed simulations to establish the true flail envelope for each occupant.

In the past, verification requirements for occupied space retention have set limits on maximum reduction in cabin height during the crash pulse and also placed limits on reduction of longitudinal length of occupied cabin areas. These guidelines can be found in the Crash Survival Design Guide. The limit values should be tailored to the type of aircraft.

Some additional guidelines for consideration during the incremental verification process are provided below.

SFR:

Confirm that the airframe structural design includes requirements for withstanding the survivable crash impact conditions (acceleration levels and directions, velocity change magnitudes and directions) while maintaining a minimum protected space for all occupants within their predicted flail envelopes.

The analyses should include evaluation of occupant flail envelopes, airframe deformation

JSSG-2010-7

around the occupied spaces for all occupant locations, and adequate structural attachment or controlled displacement of high-mass items for the specified crash impact parameters.

Review contractor's WBS and SOW to assure that preliminary trade studies are defined with appropriate review and participation from all involved functional engineering disciplines.

Identify contractor's proposed method of analyzing airframe structural response to the specified crash impact conditions. Verify with subject matter experts that these proposed analytical modeling and simulation tools are recognized and validated as acceptable for this intended use.

Identify contractor's proposed method of establishing the predicted flail envelope for each occupant. Verify with subject matter experts that these proposed analytical tools are recognized and validated as acceptable for this intended use. Currently accepted analytical programs include, but may not be limited to, SOM-LA, SOM-TA, ATB, DYNAMAN, MADYMO and occupant simulation models within MSC/DYTRAN.

PDR:

Review preliminary design drawings to evaluate allocation of sacrificial crushable structure in unoccupied areas for energy absorption and protection of occupied space for all likely crash impact scenarios.

Review results of preliminary structural deformation analyses to determine that crash impact structural deformation or high-mass items do not encroach into occupied space.

Review preliminary trade studies to verify that alternate system design concepts have been considered in order to satisfy this requirement. This promotes selection of the best design concept overall considering impacts of cost, schedule, and technical risk as well as minimal impacts on other aircraft functional areas.

Review results of preliminary trade studies of occupant injury risk versus system technical and cost risk.

CDR:

Review detailed design drawings to evaluate placement of high-mass components relative to occupied areas. Preference is for placement of high-mass items away from occupied areas.

Review final analyses of structural deformation in areas of occupied space. Verify that analyses accurately model the range of design survivable crash impact parameters.

Review final analyses of structural deformation in areas of occupied space. Verify that analyses' results confirm that flail envelopes are protected from structural intrusion for all occupants.

Review results of final trade studies of occupant injury risk versus system technical and cost risk.

Review any component or structural subassembly drop test results, if available, in order to validate contractor's simulation of structural deformation and high-mass item integrity.

SVR:

Review static and dynamic test results for subsystems and full scale aircraft. If full scale

JSSG-2010-7

crash tests were not included in the approved test program, verify acceptability of computer modeling and simulation results.

VERIFICATION LESSONS LEARNED (4.7.3.2.1)

In the past, static structural analyses have been used to predict the airframe's ability to meet high-mass item retention requirements. Static analysis may be adequate for determining design margins-of-safety for attachment integrity between the high-mass components and the aircraft structure in a crash. However, the dynamics of the airframe's displacement throughout the crash acceleration event can only be accurately analyzed by time-dependent loading models which accurately account for plastic as well as elastic structural displacements (i.e., large-deflection and/or non-linear analysis).

The previously referenced UH-60 Black Hawk roof collapse failure mode is a good example of the combined effects of plastic-elastic deformation. In this case, elastic recovery of the roof structure masked the severity of the intrusion. Investigators were able to estimate the combined intrusion in the cockpit by the contact witness marks found on the crew-seat's frame and seat bucket guide tubes.

Past airframe procurements have required validation of separately applied loads along the three primary aircraft coordinate axes. Because the aircraft is subjected to loads along all three axes simultaneously in an actual crash, it's important that all verifications be conducted with simultaneously applied loading vectors. The exception to this would be where independently applied loading may be modeled in order to validate the analytical model through test data comparison.

Since crashes are dynamic events, the technical community is moving in the direction of requiring more extensive dynamic structural modeling and simulation, supplemented with crash testing of the static test article after static testing is completed.

3.7.3.2.2 Seat structural integrity and occupant retention.

Crash resistant seating and restraint systems shall be provided for all crew, troops, and passengers to protect aircraft occupants from contact with interior structures and equipment that could cause injuries beyond the tolerance limits defined in 3.7.2. Each seat, restraint, and seat/airframe interface shall form an integrated occupant retention system that maintains structural integrity in crash conditions up to those specified in 3.7.1. In addition to protecting against contact injury, the seat and restraint systems shall also support and position occupants to protect against whole body acceleration and associated biodynamic injury mechanisms. The load attenuation performance allocated for seats within the aircraft's crash energy management system is defined in 3.7.3.3.1. Mobile crewmembers (such as the crew chief, mine sweeping operators, and gunners) shall be provided with seats and restraint systems that can be quickly accessed and occupied after being warned of a potential or imminent crash.

Aircraft seats shall comply with the following structural and occupant strike envelope requirements.

- a. Seat systems shall comply with the following static load factors: _____.
- b. Seat systems shall comply with the following dynamic requirements: _____.
- c. Seat systems shall comply with the following seat/airframe interface warping requirements: _____.

JSSG-2010-7

d. Seat/airframe interface structures shall comply with following structural requirements:

_____.

e. Occupant restraint systems shall comply with following occupant strike envelopes:

_____.

REQUIREMENT RATIONALE (3.7.3.2.2)

This requirement ensures that aircraft occupants are adequately protected by their retention system (i.e., the complete seat/restraint system). The seat and restraint system play a major role in preventing occupant contact injuries that are associated with body parts flailing into aircraft structures.

REQUIREMENT GUIDANCE (3.7.3.2.2)

A critical facet of occupant crash protection is the control of the forces created by the impact. The seat/restraint system plays a vital role in this objective. It is the seat/restraint system's purpose to properly restrain and retain the occupant within the crew/occupant station provided within the airframe during survivable crashes. Essentially, the seat/restraint system must satisfy a dual purpose, i.e., prevent both contact and acceleration injuries. Some of the important factors that must be considered in the design of a crashworthy seat/restraint system are: human injury tolerance, orientation-to-impact forces, restraint type and geometry, seat cushion effects, energy absorption, retention system strength, and occupant strike zone considerations. Based on the "functional approach" taken in this document, the elements primarily associated with contact-type injuries will be discussed in this section. Prevention of acceleration (i.e., inertia-induced) injuries will be discussed in 3.7.3.3 and 4.7.3.3. However, it should be recognized that the two injury mechanisms are closely related in terms of the crash protection systems required to provide protection, and cannot be completely separated.

Seat/restraint systems should provide retention and load distribution for the occupants in the direction of the most severe and likely impact areas. Occupant restraint requires that the seat remain attached to the aircraft while the occupant is securely restrained to the seat. To address contact-induced injuries, occupants must be restrained in such a manner that no body part exceeds the established strike envelope (refer to occupant motion envelopes defined in the Aircraft Crash Survival Design Guide, Volume II, and provided herein).

A systems approach must be used in the design of a seat/retention system. The aircraft's performance and design configuration affect the seat/restraint system's requirements. The restraint system's design should be integrated with the design of the other surrounding aircraft systems. As an example, the energy absorbing features of the airframe, to a certain extent, dictate the requirements for strength and energy absorbing capability of the seat/retention system. In addition, components of the retention system itself interact with each other and cannot be completely separated from the rest of the system. For example, energy-absorbing seats both limit force transmitted to the occupant and may enhance the seat's strength by limiting crash loads to the structure and airframe attachments.

Personal restraint system design criteria considerations. Restraints, along with cushions, provide the interface between the occupant and the rest of the seating system, performing a critical function in providing occupant safety during a crash. Restraint systems should exhibit the following features, as a minimum:

JSSG-2010-7

Be comfortable and lightweight.

Be easy to don and remove.

Contain a single-point release system that is easy to operate, regardless of occupant orientation, with either hand.

Provide freedom of movement to operate the controls of the aircraft (usually necessitating the use of an inertia reel).

Provide sufficient restraint in all directions.

Maximize the area of force distribution over the body.

Prevent injuries due to “submarining”.

Minimize amplification of crash forces (i.e., “dynamic overshoot” factor).

Prevent inadvertent release of the buckle.

Volume I of the Aircraft Crash Survival Design Guide provides design criteria guidance and design checklists for seat and restraint systems.

Aerospace Standard AS 8043 specifies laboratory test procedures and minimal requirements for the manufacturer of torso restraint systems for use in small fixed wing aircraft and rotorcraft. The introduction to this SAE Standard cautions that compliance to the standard alone may not assure adequate performance of the restraint system in an operational environment. It further states that performance must be demonstrated by a system evaluation procedure that includes the seat, occupant, the specific restraint installation and the cabin interior configuration.

Aerospace Standard AS 8049 defines minimum performance standards, qualification requirements, and minimum documentation requirements for passenger and crew seats in civil rotorcraft and transport airplanes. This standard assures occupant protection by defining test and evaluation criteria for the seat/occupant/restraint system. Guidance for test procedures, measurements, equipment, and interpretation of results is presented to promote uniform techniques and to achieve acceptable data. Specifically, the document addresses the performance criteria for seat systems requiring “dynamic testing” to be used in civil rotorcraft and transport airplanes. Much of this guidance is suitable to military aerospace seat/restraint requirements and verification procedures.

In the past, failure modes identified with occupant retention systems involved either the seat tearing free from its attachments, or some form of restraint system failure. These failures usually resulted in ejection of the occupant or, induced serious contact injury. Seats, restraint systems, and their attachments should have sufficient strength to retain all occupants for the maximum survivable crash pulse severity cited for the aircraft.

Since contact injury occurs at least five times more frequently than acceleration injury, careful consideration should be given to restraint system design (Shanahan and Shanahan, 1980). In aircraft with confined interiors, both lap belt and upper torso restraint are essential for crash survivability of crew and passengers. Not only does upper torso restraint reduce upper body flailing and contact with interior structures, it also provides for greater distribution of acceleration loads across the body and increases the body’s tolerance to vertical acceleration by maintaining better spinal alignment. A tie-down strap (crotch strap) incorporated into the restraint system helps reduce the potential for “submarining”. Submarining is a dynamic reaction where the hips rotate under the lap belt as a result of forward inertial loading by the lower limbs, accompanied by the lap belt slipping up and over the iliac crests. Since an upward

JSSG-2010-7

pull by the shoulder straps can sometimes cause this reaction, a tie-down strap has been incorporated within the MIL-S-58095 restraint configuration. This phenomenon can cause serious abdominal injury or even spinal distraction fractures. Many so-called "seat belt injuries" can be attributed to this mechanism. Properly designed and fitted, a tie-down strap can eliminate this hazard. Submarining can also be controlled by seat pan/cushion designs that provide "ramps" to inhibit forward motion of the lower torso. This design approach has been successfully integrated into ejection seats via contoured lids on the survival kits that also serve as seat pans. Automotive seats also employ ramp designs within the seat structure. Finally, belt restraint systems should be seat-mounted to account for any seat height adjustment motions and for the seat displacements associated with energy absorbers!

Accident experience has provided substantial evidence that use of a shoulder harness in conjunction with a safety lap belt can reduce serious injuries to the head, neck, and upper torso of aircraft occupants. In addition, the military (see MIL-S-58095) restraint configuration (i.e., 5-point harness) shown on figure 15 has successfully enhanced the crash survivability of occupants involved in survivable rotorcraft accidents.

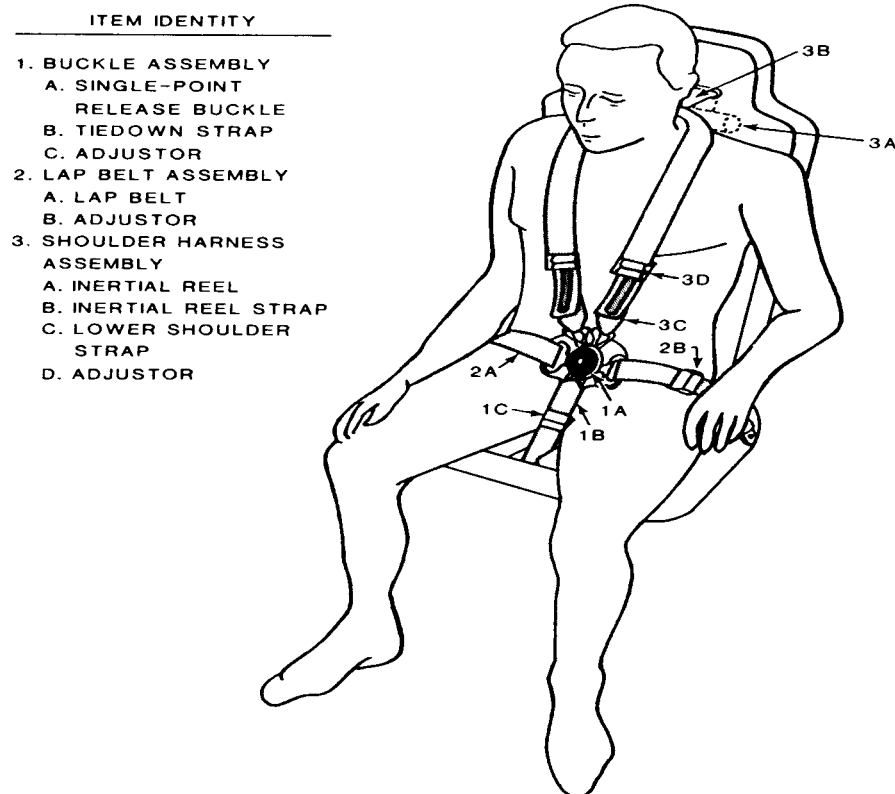


FIGURE 15. MIL-S-58095 five-point restraint harness configuration

JSSG-2010-7

However, experience has also shown that indiscriminate combinations and assemblies of hardware components can result in an inadequate shoulder harness-safety lap belt assembly. Automotive restraint literature supports the premise that installation geometry and attachment techniques influence the restraint effectiveness of shoulder harness and safety lap belt installations.

Since adverse ramifications can occur with a variety of available shoulder harness-safety lap belt systems and associated hardware, table VII provides information for hardware and system selection, as well as installation concepts, which produce an effective response and functional installation in the accident environment.

Shoulder harness assemblies are categorized as “single” and “dual” shoulder belt. The single shoulder belt configuration is normally arranged diagonally across the occupant’s upper torso and is often referred to as a 3-point system. The dual shoulder belt is a symmetrical arrangement of the two belts with one belt passing over each shoulder of the occupant, and is frequently referred to as a 4-point or, a 5-point system, if a tie-down strap is used. These assembly configurations, as well as others may be acceptable with proper design and evaluation.

Design factors to consider in the selection and installation of a shoulder harness-safety lap belt assembly are:

- Maximize restraint load distribution over the restrained occupant’s body.

- Hardware integrity.

- Strength of the assembly relative to the installation geometry.

- Ease and extent of belt length adjustment.

- Means for rapid release and egress.

- Ultimate load and elongation properties of the webbing.

- Comfort to the wearer.

Shoulder harness-safety lap belt systems should be designed to meet the static and dynamic strength requirements dictated by the ultimate inertial forces an occupant will experience during the specified crash environment. Previous military practice specified “static-only” ultimate load requirements cited in such specifications as MIL-B-8437, MIL-B-83787, MIL-B-8242, MIL-B-5428, and MIL-H-5364. Current military restraint evaluation includes an integrated dynamic seat/restraint crash test requirement such as cited in MIL-S-58095 (Crew Seats) and MIL-S-85510 (Troop Seats). The FAA provides Technical Standard Order TSO-C114 as a requirements document for a torso restraint system; whereas, the Society of Automotive Engineers provides SAE Standard 8043 to describe torso restraint system requirements for aerospace applications.

The Design Guide recommends that the inertia reel be tested to demonstrate an ultimate strength of 5,000 lbs. when following the procedures of MIL-R-8236. This ultimate strength factor was increased from a level of 4,000 lbs. after several operational failures of the MA-6 inertia reel.

In addition to the static load requirements cited above, the total restraint system must qualify to the dynamic test requirements shown in figure 19 for the specific seat system designated.

JSSG-2010-7

TABLE VII. Occupant restraint harness strength requirements (see MIL-STD-1290).

Component	Harness Webbing			Harness Assembly	
	Nominal width (in)	Thickness (in)	Minimum tensile breaking strength (lb)	Maximum elongation (%)	Minimum ultimate strength (lb)
Inertia reel lead-in	1.75	.055 - .075	8,000	8 @ 4,000 lb	5,000
Shoulder harness	2.00	.045 - .065	6,000	8 @ 4,000 lb	5,000
Lap belt	2.00 - 2.25	.045 - .065	6,000	7 @ 4,000 lb	4,000
Lap belt tiedown strap	1.75 - 2.00	.045 - .065	6,000	10 @ 3,000 lb	3,000

NOTE: Detailed design requirements for the MIL-S-58095 restraint system are provided in Volume IV of the Aircraft Crash Survival Design Guide.

Air bag systems. As a supplement to standard belt-type restraint systems, airbag systems similar to those used in automobiles have great potential for reducing the incidence of flailing and contact injuries. The Army and Navy are currently (1998) investigating the feasibility of retrofitting air bag systems into helicopter crew stations under a program called the Cockpit Air Bag System (CABS), McEntire ("The Case for Supplemental Cockpit Crew Restraint in Military Helicopters", McEntire, B.J., Smith, K. F., presented at AHS 52nd Annual Forum, June 1996) reports on military research to develop supplemental restraints as countermeasures to secondary strikes of the head and upper torso against rigid structure. These injuries/fatalities are occurring despite use of the 5-point restraint system; the data reveal that this injury mechanism accounts for more than half of the major injuries and fatalities sustained by Army and Navy aviators during otherwise survivable crash impacts.

Inflatable body and head restraint system (IBAHRS). Previously, the Army and Navy, under contract with SIMULA, Government Products, Inc., developed an Inflatable Body and Head Restraint System (IBAHRS) to counter head contact injuries with telescoping sighting units (TSU) sustained by Cobra crew at the copilot/gunner stations. This system was qualified for the AH-1 Cobra and, scheduled for operational service in the Marine AH-1W Super Cobra. Extensive dynamic testing established the reliability of IBAHRS and demonstrated that IBAHRS reduces head displacement by more than 5 inches, consistently preventing head impact with weapons sighting equipment.

SEATS

Rearward facing seats. For passenger/troop occupants and crew members whose duties do not require them to face forward, by far, the best choice of seat orientation is rearward facing. The rearward facing seat does a much better job than a forward facing seat of providing retention during the coupled force crash pulses (vertical and longitudinal) commonly experienced in aircraft crashes. The rear-facing seat distributes upper torso inertia forces into the seat back structure, greatly reducing the tendency of the upper torso to displace forward. The problem of limb flail is also reduced. However, a seat designed for forward facing cannot simply be turned and used as an aft-facing seat. A rearward facing seat must be built to

JSSG-2010-7

withstand the additional loads and moments created by the occupant's body on the seat back. In particular, the rear-leg attachments and seatback must be strengthened to handle the additional loads. This imposes a slight weight penalty that is more than offset by increased survivability. Rearward facing seats do not obviate the need for upper torso restraint. Upper torso restraint is still required to reduce lateral flail and flail from rebound forces. Seat backs must provide a properly designed head restraint (i.e., headrest).

Forward facing seats. The second most desirable seat configuration is a forward facing seat with full torso restraint. Full torso restraint is necessary to prevent occupant jackknifing and to enhance occupant survivability by distributing crash loads over a larger body surface area. The seat structure must be capable of withstanding the inertia forces and moments reacted during the crash by the preferable seat-mounted restraint system. Limb flail may present a greater problem than with the rearward facing seats. Head restraints should be provided to minimize whiplash-type injuries (i.e., hyperextension).

Forward facing seats with lap belt-only restraints should be avoided! This is due to the human body's poor resistance to longitudinal forces ($-G_x$) when restrained in this manner. The lap belt-only configuration has a proclivity to induce submarining, with subsequent jackknifing causing spinal fractures and abdominal injuries. Also, chest injuries due to leg and thigh impact, acceleration injuries to the head, and impact injuries due to the greatly increased strike zone of the head and limbs can result. Forward facing seats with lap belt-only restraints, combined with narrow pitch (closely spaced) seating, and/or stroking energy absorbing seats provide minimal protection, perhaps increasing the chance of injury from sub-marining or flailing. Figure 16 provides a relative survivability comparison between the two configurations showing dramatic enhancement provided by the lap-shoulder restraint in the longitudinal crash vector direction.

Use of Upper Torso Restraint Expands the Onset of the Serious and Fatal Injury Envelopes

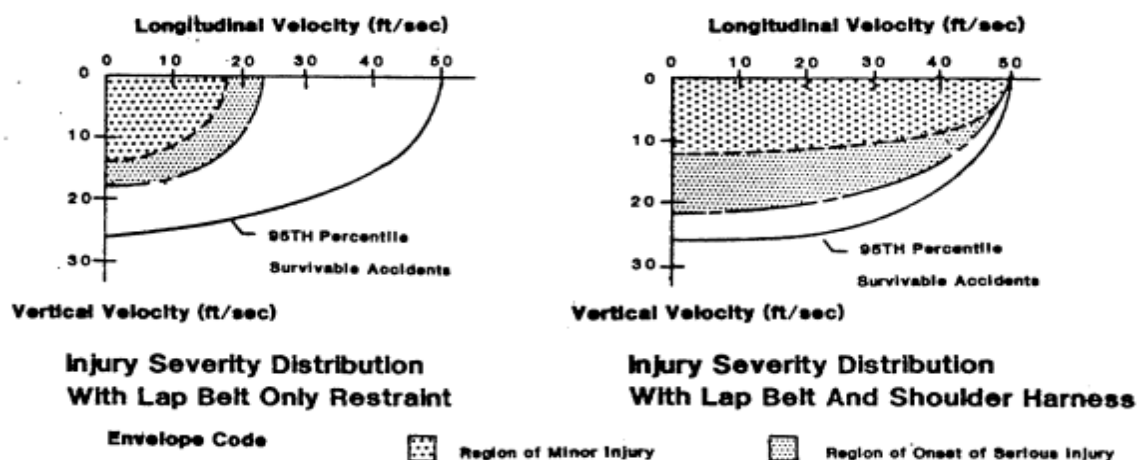


FIGURE 16. Comparison of lap belt only versus lap belt-shoulder restraint protection.

JSSG-2010-7

Side facing seats. Side facing seat configurations present the least desirable option due to limited human side-impact injury tolerance, and the difficulty of providing adequate restraint in this direction. Use of a diagonal shoulder harness provides enhanced upper torso retention for this aircraft installation, but the potential for restraint-induced neck injury may exist. This potential restraint induced hazard has not yet been adequately studied. Restraint designers should consider alternative approaches to address this potential injury mechanism. Figure 17 shows two configurations typically employed in side-facing troop seat restraint systems.

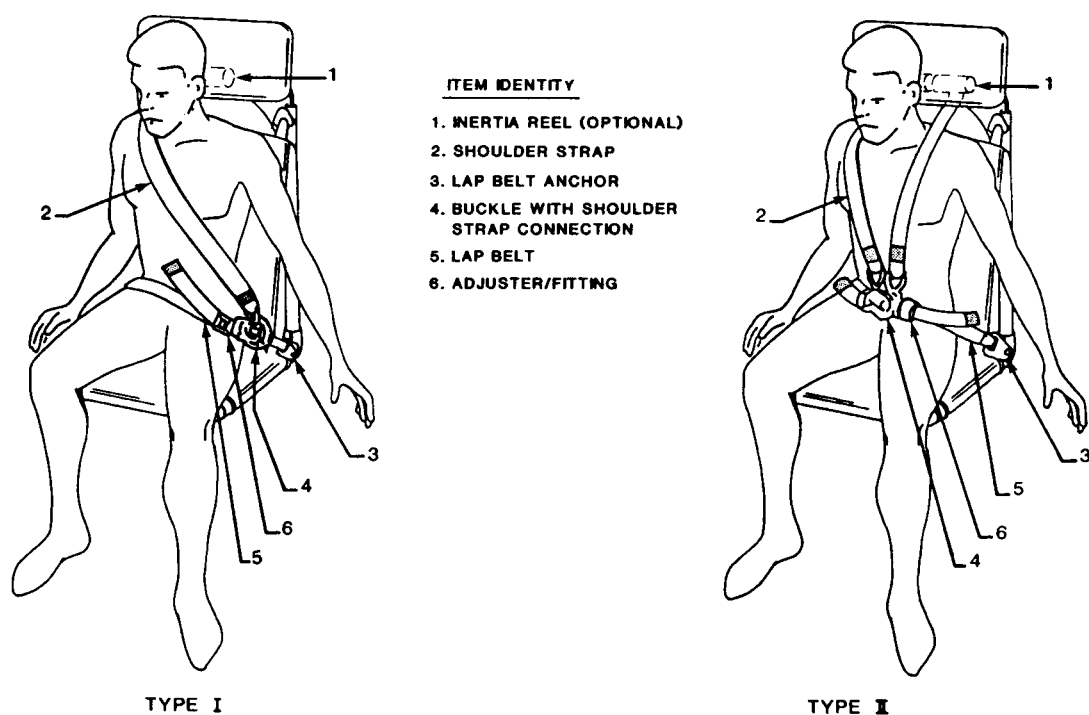


FIGURE 17. Troop Seat Restraint Configurations

The FAA has determined that the new dynamic test requirements for transport category passenger seats cited in FAR 25.562 are also applicable to side-facing seats. The FAA acknowledges that the requirements were initially intended for forward-facing and aft-facing seats, however, since the orientation of the seat does not change the relevant test conditions, the rule applies to all seats. For pass/fail criteria, however, the Agency acknowledges that the orientation of the seat may be significant.

Three major considerations are offered in the assessment of side-facing seats:

- a. Isolation of one occupant from another; i.e., body-to-body impacts are considered unacceptable.
- b. Adequate retention of occupants in the seat and restraint system.

JSSG-2010-7

c. Limitation of inertia loads within the torso in the lateral direction, since human tolerance levels are significantly lower along this axis.

The FAA 's side-facing seat requirements are essentially based on the test procedures and occupant injury criteria developed by the automotive industry for side impact protection. These criteria involve limitation of lateral pelvic accelerations, and the use of the human tolerance parameter, "Thoracic Trauma Index". This injury criterion is defined in 49 CFR 571.214 and requires use of the 49 CFR Part 572, Subpart F, Side Impact Dummy (SID) to evaluate side impact parameters.

USAF seat loading requirements in past systems. MIL-STD 1807 provides the following static ultimate load factors for various seat components:

MIL-S-25073A (Seat, Aircraft)

Strength		Requirements			
Types I & II					
a.	Headrest:	200 lb.	Ultimate	(aft)	
b.	Armrest:	300 lb.	Ultimate	(down)	
		100 lb.	Ultimate	(side)	
c.	Seat pan, front edge:	400 lb.	Ultimate	(down)	
Type I (Helicopters)					
a.	Seat bottom:	3000 lb.	Ultimate	(down)	
b.	Seat back:	2000 lb.	Ultimate	(aft)	
c.	Safety belt mounting:	1440 lb.	Ultimate	equally distributed	
		900 lb.	Ultimate	shoulder harness	
d.	Lap safety belt mountings:	1500 lb.	Ultimate	(up) equally distributed	
Type II (Cargo, transport, and multi-engine trainer aircraft)					
a.	Seat bottom:	4000 lb.	Ultimate	(down)	
b.	Seat back:	1500 lb.	Ultimate	(aft)	
c.	Safety belt mounting:	2880 lb.	Ultimate	equally distributed	
		1800 lb.	Ultimate	(lap belt) shoulder harness	

JSSG-2010-7

MIL-S-26688 (Seat, passenger, aft-facing, transport aircraft)

a.	Seat back:	4000	lb.	Ultimate	
b.	Seat bottom:	4000	lb.	Ultimate	
c.	Armrests:	200	lb.	Ultimate	(side)
d.	Footrests:	250	lb.	Ultimate	
e.	Safety belt fittings:	1000	lb.	Ultimate,	each fitting

MIL-S-7852 (Seat, aircrew, adjustable swivel, type E-1)

a.	Seat bottom:	4000	lb.	Ultimate	
b.	Seat back:	4000	lb.	Ultimate	
c.	Headrest:	200	lb.	Ultimate	(aft)
d.	Armrests:	300	lb.	Ultimate	(down)
		100	lb.	Ultimate	(side)
e.	Safety belt fittings:	2880	lb.	Ultimate	(equally distributed)
		1800	lb.	Ultimate	(shoulder harness)

C-17 seating and restraint requirements.

**Pilot & Copilot: MIL-S-25073 (Type II Seat) (forward facing)

**ACM: MIL-S-7852 (forward facing)

**Crew Rest: MIL-S-26688 (aft facing)

**Loadmaster: MIL-S-7852 & MIL-S-26688 (side & aft facing)

Loadmaster Instructor/Evaluator Seat: (Side facing)

Loads:	<u>FWD</u>	<u>AFT</u>	<u>UP</u>	<u>DOWN</u>	<u>LATERAL</u>
	10 g	5 g	5 g	10 g	3 g

*Restraints: MIL-S-58095A (see 3.11.7)

* Reel: MIL-R-8236 (MA-6)

Troop/Passenger Side-wall Seat: (Side facing)

Loads:	<u>FWD-AFT</u>	<u>UP</u>	<u>DOWN/LATERAL</u>
	942.5	3142	942.5
	(lbs.)	(lbs.)	(lbs.)

JSSG-2010-7

Troop/Passenger Centerline Seat: (Side facing)

Loads:	<u>FWD-AFT</u>	<u>UP</u>	<u>DOWN</u>	<u>LATERAL</u>
	*3 g -*3 g	5 g	10 g	3 g
	*Load path is directed through restraints to aircraft			

Restraints:	<u>FWD</u>	<u>AFT</u>	<u>UP</u>	<u>DOWN</u>	<u>LATERAL</u>
	10 g	10 g	5 g	10 g	3 g
	*MIL-R-81729				

**from C-17 Air Vehicle Specification, 3.7.1.8.1.4 Crew Seats

*MIL-S-58095 (Seat System, Crash-Resistant, Non-Ejection, Aircrew, General Specification For (Army))

MIL-R-8236 (Reel, Shoulder Harness, Inertial Lock (1B/2B))

MIL-R-81729 (Restraint Systems, Aircrewman's)

Load factors for seat installations. In the past, USAF seat systems were required to meet the ultimate load factors specified in applicable specifications or the following load factors shown in table VIII, if no seat specification was available.

TABLE VIII. Seat crash load factors.

	Longitudinal Forward/Aft		Vertical	Lateral (left & right)	Applicable items
All airplanes, except cargo	40	20	10 up 20 down	14	ALL
Cargo	20	10	10 up 20 down	10	All except stowable troop seats
	10	5	5 up 10 down	10	Stowable troop seats

One problem with using these numbers is that it can be difficult to relate them to a specific crash scenario. An analysis would be required to relate a crash scenario to load requirements on equipment. The above information is provided for an historical perspective on seat design practiced prior to the establishment of the Crash Survival Design Guide and the FAA's dynamic test criteria. The static load factors cited above should not be used where they conflict with current dynamic design criteria.

JSSG-2010-7

Webbing retractors (inertia reels). Webbing retractors allow an occupant restrained in a seat the mobility to perform his required function, but during a crash, serve the vital function of locking and anchoring the shoulder harness. This is intended to limit potentially hazardous motion of the occupant's upper torso and head. Webbing retractors are frequently incorporated in shoulder harness and safety belt systems to satisfy the crewmember movement and/or webbing stowage requirements of the restraint system. They can also enhance comfort and ease of length adjustment, which encourages use of the shoulder harness as well as the safety belt. Retractors are categorized by the point in time when they lock to provide occupant restraint.

Emergency locking retractor (ELR). Emergency locking retractors are frequently called "inertia reels" because their functional mechanism is characterized by the feature of providing positive restraint only when significant inertial forces are experienced. Three types of emergency locking retractors that may be encountered are "webbing sensitive", "vehicle sensitive" and "dual-mode locking".

Webbing sensitive retractors lock in response to a change in the rate (acceleration) of webbing pay-out velocity from the retractor, and are functional for occupant accelerations in any direction that produces extension of the webbing.

The vehicle sensitive retractor produces locking by physical acceleration of the retractor itself, or it can be locked by a remote sensor on the vehicle.

The third type of retractor has a dual locking mechanism that combines the favorable features of both the webbing sensitive and the vehicle sensitive retractor. This type of retractor is more suitable for aircraft applications.

NOTE: Emergency locking retractors should be used only on shoulder belts. Their use on safety lap belts prevents proper tightening of the safety belt on the pelvis, and promotes occupant "submarining" under the belt in a dynamic loading environment because the design inherently permits a certain amount of webbing extension before it locks. Also, during low level turbulence, inertial lock-up may not occur, thus requiring a manual lock adjustment.

A military restraint exception to this issue is the UH-60 Black Hawk's gunner seat restraint system that permits the gunner to stand and maneuver about, while remaining strapped to the seat. The trade-off in this design is excessive slack throughout the system to achieve the mobility demanded by the mission.

Automatic locking retractor (ALR). Automatic locking retractors provide lock-up of the webbing after a prescribed amount of webbing (normally about 6 inches) has been removed from the retractor spool. Thereafter, an automatic spring-activated retraction of webbing for length adjustments and stowage of the webbing is functional. This functional mechanism is characterized by the feature of permitting free webbing extension for coupling of the safety belt, but the moment any webbing is retracted, the mechanism locks to prevent further webbing extension. However, these designs typically prevent locking within the first 25 percent (6 to 10 inches) of webbing extension from the retractor. Therefore, one must ensure that the mounting location for these retractors will actually produce locking when the occupant has the safety belt coupled around him. When automatic locking retractors are incorporated at both attachments of the safety belt, buckle positioning by the user becomes important for proper function of the retractors under emergency conditions.

JSSG-2010-7

An excellent source of information and guidance for shoulder harness-safety belt installations is *FAA Advisory Circular AC No: 21-34*.

Pretensioners. Walsh and Kelleher (*“Development of a Preloaded Force-Limited Passive Belt System for Small Cars”, SAE #800300*) conclude in their study that with dynamic preloading, FMVSS 208 performance criteria can be met for a 50-th percentile male size ATD passenger (right front) at sled velocities up to 45 mph. Pretensioners automatically remove slack from a restraint system prior to the crash event when triggered by a crash sensor. Current automotive units employ pyrotechnically activated mechanisms. Seat belt pretensioners have been shown to also minimize the risk of submarining through the reduction of lap belt slippage (*“Seat Belt Pretensioners to Avoid the Risk of Submarining – A Study of Lap-Belt Slippage Factors”, Haland, Y., S9-0-10, 13-th International Technical Conference on Experimental Safety Vehicles*).

Web-Clamp Devices. Web clamps are intended to address two fundamental deficiencies of emergency locking retractors (ELR), (*“Items of an Engineering Program on an Advanced Web-Clamp Device”, Adomeit, D., SAE 870328*) namely:

- delayed restraint force onset due to necessary webbing extraction for activating the locking mechanism.
- film spool-effect, leading to further occupant displacement on an ineffectively low restraint-force level.

Note that web clamps do not eliminate excessive slack in an improperly adjusted restraint system; this can only be accomplished with a pretensioning system. However, the web clamp reduces response time from approximately 30 milliseconds to approximately 15-20 milliseconds for standard automotive ELR s. In addition, web clamps minimize slack due to the ‘spooling effect’, thereby, coupling the occupant to his shoulder harness more effectively. The deficiencies addressed by this device are also present in military inertia reels such as the MA6/MA-8 models.

MIL-R-8236. The “F” revision to military specification MIL-R-8236 establishes new dynamic performance criteria and test verification requirements for 6 types of shoulder harness inertia reels and subassemblies thereof, for military aircraft. Previously, only a “webbing pay-out” requirement and static system testing existed. The automatic locking mechanism of inertia reels, military designation MA-6/MA-8, is activated when the webbing wound around the spools of the reel is extracted at an acceleration exceeding 1 ½ to 3 G’s. Below this level, the webbing is free to pay out as the occupant moves within the seat for normal flight duties. When the threshold is exceeded in a crash, a spring-loaded pawl is released which engages ratchet teeth on the webbing spool, preventing additional spool rotation. The MA-6/MA-8 units were shown to be deficient in design and proven to be unreliable in survivable crash conditions. Dynamic failures of the inertia reel locking pawl and limitations in the “strap sensing” lock-up mechanism necessitated the revision to the “static” specification.

The dual-mode model, designated MA-16, also provides a vehicle-sensitive dynamic requirement that enhances crash-induced lockup, both from a response time and reliability standpoint. “Lock” and “no-lock” tests are required in the “auto-lock” position under stipulated acceleration peaks, onset rates and velocity changes. In addition to the tests required to

JSSG-2010-7

separately validate each of the lock mechanisms, the new specification requires flight performance tests to assure the dual-mode design does not produce nuisance locks during flight. To assure reliable crash performance, both static and dynamic tests are required. The dynamic test matrix entails 22 total tests at four impact conditions for the rotary wing and VTOL aircraft categories. Similar tests are required for two impact conditions for transport and light, fixed-wing aircraft.

REQUIREMENT LESSONS LEARNED (3.7.3.2.2)

Forward load-limiting seats. The Crash Survival Design Guide recommends use of seat load-limiters (i.e., energy absorbers) for the vertical axis to protect the aviator's spine in severe vertical impacts. Use of load limiters along the aircraft's forward (longitudinal) axis should be restricted to retrofit situations which preclude modifications to the seat/aircraft interface structure. The preferred approach is to calculate the loads required to support the crash resistant seat, and then to determine the modifications necessary for the floor or bulkhead to support those loads. The trade-off associated with use of seat load limiters along the forward axis is the potential strike hazard associated with the controlled forward displacement of the seat. Benefits associated with this retrofit approach are that structural retention of the seat to the aircraft can be increased without modifying existing aircraft structure. The Navy implemented this retrofit design approach with the SH-3 and CH-53 helicopters. Both seat configurations employ rear struts that elongate at a constant load, permitting the center-of-gravity of the seat-occupant system to move forward relative to the floor attachment, and limiting the attachment forces. However, the Crash Survival Design Guide cautions that this technique should only be used when no other methods are possible.

Seat – floor anchorage. The Army's BLACK HAWK crew seats are designed to a 35 g ultimate static load factor in the forward axis. This design requirement offers a safety margin for the seat structure to meet the dynamic G_x peak impulse requirement of 30 g's. BLACK HAWK crew seats are validated with static loads testing of the complete system (i.e., seat and aircraft floor attachments), and the dynamic crash tests. The Navy's derivative, Seahawk, also employs crash resistant crew seats that are qualified to the MIL-S-58095 dynamic test requirements given in figure 19. However, the Navy's type specification failed to identify a requirement to match the crew seat's structural strength to the aircraft's ultimate load factors.

USAF rear-facing passenger seats. The USAF employed rear-facing passenger seats in the Military Air Transport System (MATS), C-135 jet transport aircraft about 1961 (AEROTEC Industries Review, Winter Issue, 1961-62). The aft facing seats were capable of withstanding 16 G, combined with light weight, plus reclining backs, food tray tables, footrests, and what was significant at that time, an energy absorber as part of the seat structure itself. The irreversible energy absorber struts made up the vertical members of the leg assembly. Both rear legs were capable of absorbing a total of 3,180 foot pounds of energy. The energy absorption method chosen for this seat was a "drawn tube within a die" concept. Also of interest was the application of this technology to the TWA Star Stream Turbo-fan Jetliner's model 643 lounge seats. Although strength requirements cited were in accordance with TSO-C39, the energy absorbing seat struts provided an enhanced safety factor.

JSSG-2010-7

FAA passenger seat dynamic test requirements. Chandler (“Development of Crash Injury Protection”, Chandler, R. F., *Accidental Injury – Biomechanics and Prevention*, Nahum and Melvin, 1993) describes the methodology used to develop dynamic test criteria for the 16 Gx vector which would be compatible with the existing floor structures in civil transport airplanes. Test conditions were selected so that the tests produced force reactions at the floor that were within allowable limits for existing designs. The forces generated at the attachment of the seat legs to the aircraft floor tracks were measured at the CAMI test facility and compared to the allowable floor loads for typical narrow-bodied passenger aircraft. The compatibility between the recommended dynamic test requirement and the existing static floor strength enabled the new seat designs to be used on existing airplanes without the delays and costs associated with a structural upgrade to floor strength. The new FAA rule that required dynamic testing for seats in newly certified large transport airplanes was issued in May 1988. Chandler reports that field experience with the newly certified seats is limited, but one B-737 crash provided indications that the “dynamically-qualified” seats were effective. In those areas where the floor was not destroyed, the seats remained attached to the floor and the occupants of those seats survived. Specific dynamic test parameters of the Federal Aeronautical Regulations (FARs) are provided below in the verification section of this occupant retention requirement.

MA-6 Inertia Reel Failure Modes. Two failure modes were identified operationally with the MA-6 inertia reel model. One occurs when the locking pawl attempts to engage the ratchet after a critical spool rotational velocity has been exceeded. Depending on the spool rotation rate and the location of the pawl relative to an advancing tooth at the instant of release, the pawl sometimes engages only a tip of a tooth. This condition as shown in the figures 18 and 19 is sometimes referred to as a “skip lock” failure. The failure mode was initially identified during Navy crash loads testing of the IBAHRS, and verified during extensive component tests of the MA-6 inertia reel. (Schultz, M., “Inertia Reels For Aircrew Restraint Systems”, 28th Annual SAFE Symposium, 1990).

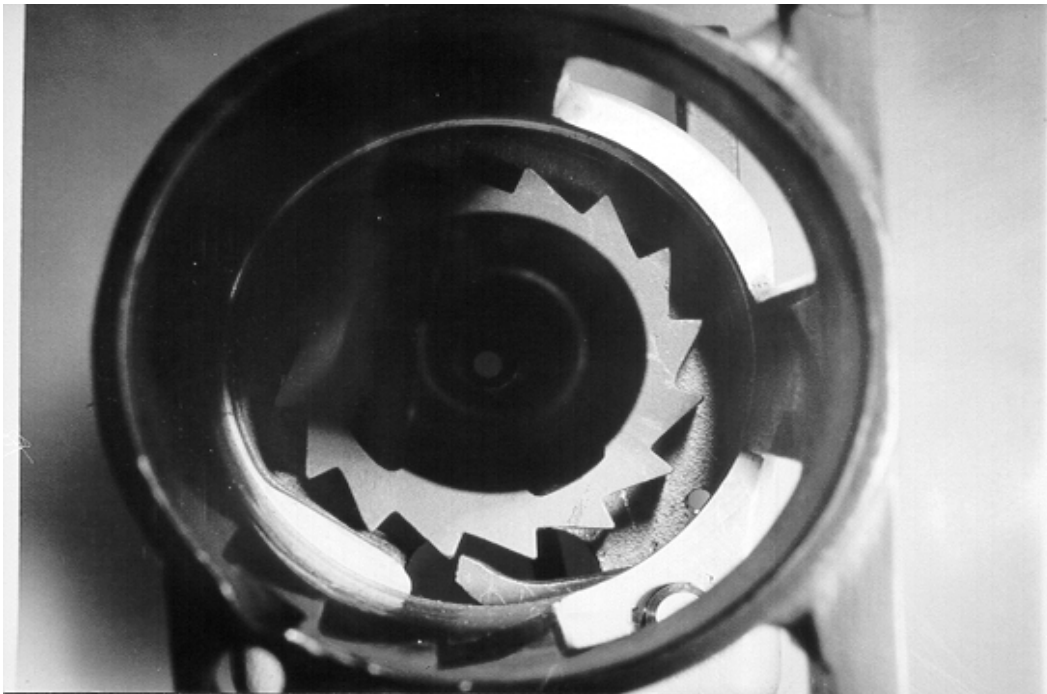


FIGURE 18. View of MA-6 inertia reel's ratchet/pawl assembly.

JSSG-2010-7

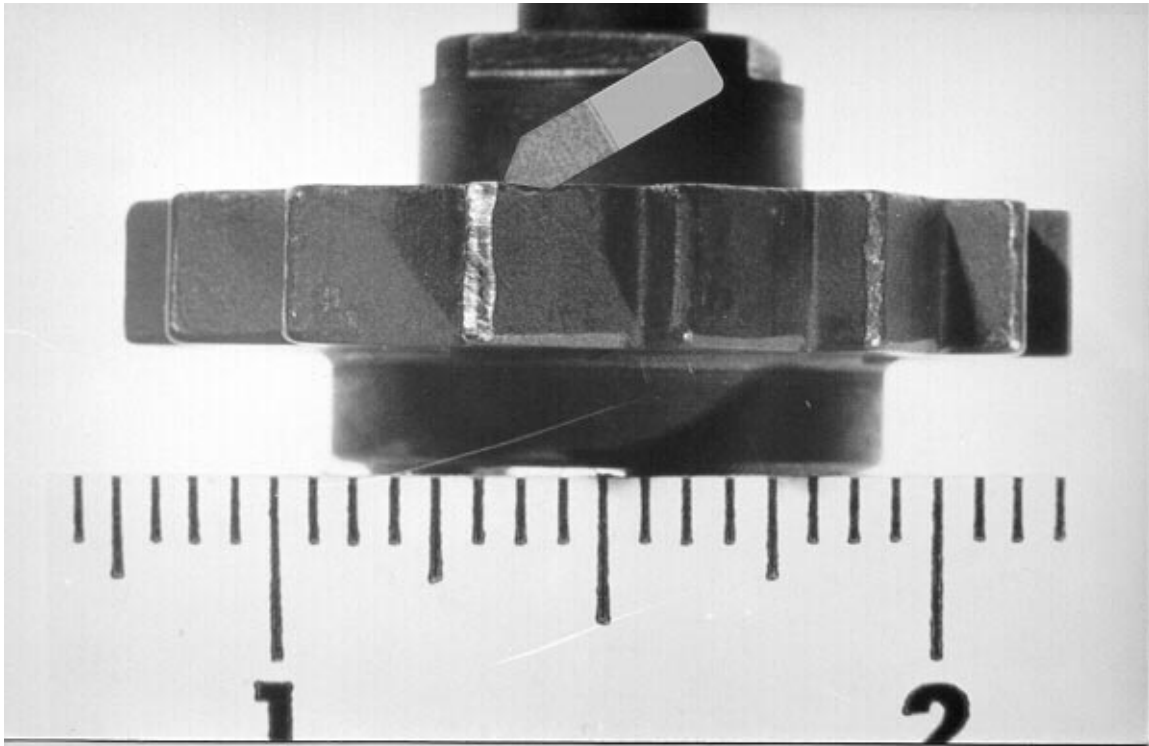


FIGURE 19. View of MA-6 inertia reel's damaged ratchet teeth.

Though partial engagement can initially stop webbing pay-out, the reduced contact and shear areas cannot sustain peak webbing loads that can be as high as 3500 pounds. When tooth and/or pawl failure occurs, as shown in the figure above, the tensioned webbing snaps the spool into rapid rotation causing the pawl to skip over subsequent teeth passing at too high a rate for secondary engagement. After the dynamic pulse ends and the motion ceases, the partially damaged parts engage, giving the misleading appearance that the reel functioned properly. This phenomenon would be essentially undetectable by mishap investigators since the reel appears to function properly in a post crash functional check. Only disassembly and inspection by trained personnel can identify the failure.

The second failure mode occurs in predominantly vertical helicopter crashes in which the initial forward body motion and associated webbing pay-out acceleration are below the threshold level necessary to activate the reel's locking mechanism. In this case, initial dynamic response of the seat occupant is downward compressing into the seat cushion, with subsequent upper torso flexure and gradual build up of strap velocity. Ten inches or more of webbing can be extracted during the "unlocked" forward rotation of the upper torso, allowing unrestricted upper torso travel during the primary impact, secondary impacts and/or rollovers.

Army mishap data revealed a number of critical and fatal injuries attributed to the inertia reel failing to lock, or not locking soon enough. The study was the result of unexplained contact injuries. Preliminary field findings showed the ELR operational, but detailed examination upon disassembly showed failures. (McEntire, B.J., "US Army Helicopter Inertia Reel Locking Failures", Advisory Group For Aerospace Research & Development, AGARD Conference Proceedings 532, Sept 1992).

JSSG-2010-7

4.7.3.2.2 Seat structural integrity and occupant restraint verification.

Compliance to the seat structural integrity and occupant restraint requirements of 3.7.3.2.2 shall be incrementally verified by analysis, simulation, and testing appropriate to the program phase involved. Verification of the occupant restraint system shall be accomplished in conjunction with the specific seat system and the vehicle energy management system. The occupant restraint system shall comply with the appropriate human injury tolerance levels specified in 3.7.2.

The following incremental verifications shall be accomplished prior to the specified review:

a. System Functional Review (SFR) - Verify that all appropriate contractor documentation (i.e. specifications, systems engineering master schedule, contract work breakdown structure, and statement of work) define appropriate analyses, trade studies, simulations, and tests to demonstrate the system's capability to meet occupant retention requirements.

b. Preliminary Design Review (PDR) - Verify that all appropriate preliminary design drawings, occupant crash simulation analyses, trade studies, structural analyses and component/subsystem static and dynamic tests adequately demonstrate compliance to the requirements of 3.7.3.2.2.

c. Critical Design Review (CDR) - Verify that all appropriate final design drawings and seat/restraint system qualification test plans demonstrate compliance to the requirements of paragraph 3.7.3.2.2. System dynamic testing shall be employed to demonstrate occupant retention, inertial response and potentials for contact and acceleration injuries are within the injury tolerance levels specified in paragraph 3.7.2.

d. System Verification Review (SVR) - Verify that all appropriate qualification test reports, test data and pre-production drawings of the final design configuration of the occupant retention system comply with the requirements of paragraph 3.7.3.2.2. All qualification test reports and test data of dynamic and static crash loads testing conducted on the pre-production configuration must comply with the occupant crash protection requirements of this guide specification.

VERIFICATION RATIONALE (4.7.3.2.2)

Verification should confirm that the total retention system limits the forces transmitted to the aircraft occupants and mitigates injuries sustained by all occupants to the specified design levels. All components of the retention system must be evaluated to validate the occupant retention system. The seat/restraint system, the size and weight range of occupants, and the local airframe contact surfaces must be considered both on an individual and systems level basis.

VERIFICATION GUIDANCE (4.7.3.2.2)

To adequately verify the capability of the retention system to protect aircraft occupants (crew, troops, and passengers) from the hazard of contact injuries, it's essential to analyze, simulate, and test all elements involved in the retention chain. Verification should include system analysis, occupant kinematic simulation, and testing all elements of the seating and restraint system, including the seat-to-aircraft structural tie-down chain.

Dynamic testing of seat/restraint systems is essential to accurately evaluate the ability of the retention system to protect the occupants in a crash impact. In the past, static testing alone was performed to verify the structural integrity of the seat system under a specified static load.

JSSG-2010-7

There was no requirement to test in a dynamic mode in order to evaluate the response of the seated occupant to a given dynamic crash impulse. This shortcoming has been well recognized and it is now common practice in the military and civilian aircraft communities to require dynamic testing to assess the ability of the seat/restraint system to protect aircraft occupants.

MIL-STD-1807 suggests that “retention system strength”, “crash force attenuation”, “restraint system and cushions”, and “strike zone” requirements should be verified together as it is difficult to separate these components due to their interaction as a system. The tests should provide compliance with all of the appropriate requirements of paragraph 3.7.3.2.2. Tests should be performed with a human surrogate (manikin) that closely represents the human in size, weight, mass distribution, limb movement, and dynamic response. Dynamic tests should be used to verify all requirements. The test fixture should replicate the seating system to include the floor structure in the immediate vicinity of the seat. The manikin as well as the seat should be instrumented to provide data on the dynamic response of the seat/occupant/restraint system as well as the force attenuation performance of the seat itself. Tests with a manikin can be performed on a track with a method of controlled deceleration. A method of providing the applicable attachment deformation requirements should be provided. The strike zone and injury potential (due to strike zone and movement) can be determined from high-speed films of track tests of the seat with manikin. Injury due to strike zone impact and the performance of the protection method can be verified by measuring the impact force on the body and area of impact and comparing to known injury tolerance levels. Calculation of injury is rather difficult due to the many variables involved. See U.S. Army Aircraft Crash Survival Design Guide, Volume II (USAASVCOM TR-89-D-22B), for further guidance. Additional information is available in FAA Advisory Circular 21-22, “Injury Criteria for Human Exposure to Impact.”

Guidance on dynamic tests can be obtained from the U.S. Army Aircraft Crash Survival Design Guide, Volume IV (USAASVCOM TR-89-D-22D). Static tests conducted to supplement dynamic tests should follow the guidance given in the U.S. Army Aircraft Crash Survival Design Guide, Volume IV. Also, see FAA NPRM 86-11.

Manikins. The manikins used for seat testing should comply with the Code of Federal Regulations, Title 49, Chapter 5, Part 572: Anthropomorphic Test Dummy. More sophisticated, instrumented manikins, such as the Advanced Dynamic Anthropomorphic Manikin (ADAM) being developed for ejection seat testing, would be useful for dynamic seat testing to provide information on the forces transmitted to the seat occupant.

Computer Simulation. Several computer programs exist that simulate the seat-occupant response to crash impact forces. One such program is the FAA developed SOM-LA: Seat Occupant Model-Light Aircraft (there is also a version for transport aircraft called SOM-TA). This program takes into account force deflection information for the cushions and belts, crash conditions (initial velocity, attitude, and time variations of six acceleration components), occupant description, seat design data, and a description of cabin surfaces. The program will give as output the time histories of the occupant segment positions (12 segments and 29 degrees of freedom); velocities and accelerations; restraint system loads; seat deflections and forces; details of contact between the occupant and the aircraft interior; and several measures of injury severity (from segment accelerations, DRI for spine, and from the Head Injury Criterion of Federal Motor Vehicle Safety Standard 208). Since this program was developed, there have been several modifications to improve its performance.

Several other programs and models exist; see the U.S. Army Aircraft Crash Survival Design Guide, Volume IV, section 4.7, for more information. Also refer to the references listed in the verification guidance paragraph of this handbook, 4.7.3.2.1.

JSSG-2010-7

Some additional guidelines for consideration during incremental verification are provided below:

SFR:

Review contractor's specifications to confirm that the airframe structural design includes requirements for the seating and restraint systems to provide occupant protection in accordance with 3.7.3.2.2 under the survivable crash impact conditions cited in the contract.

Review contractor's specifications to confirm an adequate margin of safety for the airframe structural design, including requirements for the seat system-to-airframe tie-down chain. Typical practice has been to require the seat tie-down chain to have at least a 1.3 safety factor in the static stress analysis. However, when consideration is given to the inherent load amplifications associated with the elastic properties of the seated occupant/cushion/restraint system (i.e., "dynamic overshoot"), a safety factor of 1.5 to 2.0 is more appropriate. This would also enhance survival in some partially survivable category mishaps.

Analyses should include simulations of occupant dynamic response to the range of specified survivable crash conditions for all occupant locations.

Dynamic tests should include the entire seat/occupant/aircraft tie-down chain to establish occupant dynamic response to Government-approved crash impact test conditions for all occupant locations.

Verify that alternate occupant retention concepts are to be identified in order to minimize program risk.

Verify that trade studies are included to assess the relative performance (injury reduction) versus the cost and technical risk with all 0 approaches.

PDR:

Review preliminary design drawings to evaluate seating orientation for crashworthiness.

Review preliminary design drawings of seating and restraint systems. Verify that protection is provided against any potential strike surfaces within the occupant flail envelope.

Review results of preliminary occupant crash simulation analyses using subject matter experts. Ensure that occupant response falls within the specified injury tolerance.

Review computer models used in occupant crash simulation analyses of all seating and restraint system components to ensure that each element is validated from past testing/simulation of similar systems and components.

Review results of contractor's stress analysis of the seat system and seat/aircraft interface structure to ensure adequate safety margins exist. Ensure that analysis is conducted using nonlinear material models with large deformation capability and time dependent loading to accurately simulate dynamic crash conditions.

Review results of seating component tests, if available. Pay particular attention to preliminary test results of seating system components that utilize unproven technologies or unproven uses of proven technologies.

JSSG-2010-7

Review test plans for seating and restraint systems to ensure that full system static and dynamic testing is required in accordance with the crash impact parameters cited herein.

CDR:

Review drawings of crew-stations including cockpit and all other seating stations (including passengers) to assess final layouts and placement of seats with respect to nearby structure, controls and displays.

Review test data on seating systems to verify that occupant response is within the specified injury tolerance criteria. Pay particular attention to qualification test results of seating system components that utilize unproven technologies or unproven uses of proven technologies.

Review critical design drawings of seating and restraint systems. Review results of preliminary occupant crash simulation analyses using subject matter experts. Ensure that occupant response falls within the specified injury tolerance.

Review models used in occupant crash simulation analyses of all seating and restraint system components to ensure that each element is validated from past testing/simulation of similar systems and components. This includes models of energy absorbing seats, restraint configurations, special restraint components (IBAHRS, strap pretensioning devices, inertia reels).

SVR:

Verify that all appropriate qualification test reports, test data and pre-production drawings of the occupant retention system comply with the requirements of paragraph 3.7.3.2.2.

Crash test facilities: There are several types of accepted crash test facilities for conducting dynamic tests of seat/restraint systems. The Naval Air Warfare Center, Patuxent River, MD, operates a HYGЕ Horizontal Accelerator facility that simulates typical decelerative crash forces associated with vehicle mishaps by reversing the orientation of the test article and accelerating the system from an initial velocity of zero. This facility consists of three main assemblies: (1) an accelerating mechanism, (2) test sled, and (3) a set of guide rails, approximately 100 feet long. The accelerating mechanism is a 12-inch HYGЕ actuator that generates a maximum force of 225,000 pounds, gross thrust. The USAF originally conducted its crash safety investigations at the HOLLIMAN Daisy Track in New Mexico. Currently, the Air Force operates a 24-inch HYGЕ Horizontal Accelerator and a Drop Test Facility at Wright Patterson AFB OH. Several variations of this type of crash test facility exist throughout the world today, resulting from the emergence of automotive crash safety as an important design/performance feature in current passenger vehicles. Most of the automotive manufacturers operate horizontal test facilities to evaluate their crash protection systems.

Although the vertical impact crash orientation can be simulated on a horizontal sled facility, it more appropriately is simulated in a Drop Test Facility. NASA operates a facility that can drop test an entire airframe to typical crash impact velocities. The Army has conducted several full-scale drop tests of prototype and operational rotorcraft at this facility. NASA can also drop test systems such as seats on a smaller test facility.

Several universities currently operate crash test facilities; to name just a few, University of New Orleans, Wichita-State University, University of Virginia, and Wayne State University, and the University of Michigan Transportation Research Institute (UMTRI). In addition, a few

JSSG-2010-7

commercial organizations have crash test facilities applicable for testing of military crash protection systems; namely, CALSPAN, SIMULA, and Transportation Research Center (TRC), Ohio. This summary of operational crash test facilities is by no means complete, and is provided here to give an overview of the selection available.

Static tests. While the dynamic tests of seat/restraint systems are now recognized as essential, it is still important to conduct static tests of the entire seat tie-down chain. The dynamic response of the seat/restraint/occupant/aircraft interface is very sensitive to the natural frequency of the system. This fact implies that there will be elements of the system that see transient peak loads, magnified by the spring-mass properties of the system. In order to verify the structural integrity of the seat system, the system must be tested statically to establish a load equilibrium throughout the entire seat tie-down chain, and hence ensure that all elements of the seat system are capable of withstanding the design loads with adequate safety margins. Successful completion of the static tests does not guarantee passing the dynamic tests, but it does improve the chances, since weaknesses can be identified and corrected prior to conduct of the ultimate dynamic tests. Recommended static tests are described in the Crash Survival Design Guide and the appropriate FARs for a designated aircraft category. The Design Guide recommends a margin of safety be added to the ultimate static load factor on the design curves as compared to the peak accelerations of the dynamic design pulses. This is based on “loading rate sensitivity” of materials and the dynamic overshoot factor, respectively. The cockpit seat design and static test requirements recommended in the Crash Survival Design Guide for rotorcraft and light fixed-wing aircraft are provided below in table IX.

TABLE IX. Cockpit seat design and static test requirements.

Test Ref. No.	Loading Direction re to Fuselage Floor	Minimum Load Factor ^{1/} (G)	Body Weight Used in Load Determination (lb.)	Seat Weight Used in Load Determination	Deflection Limited ^{2/} (in.)
		Unidirectional			
1	Forward	35	250	Full	2
2	Aft-ward	12	250	Full	2
3	Lateral ^{3/}	20	250	Full	4
4	Downward (Bottomed)	25	200 ^{6/}	Full	No requirement
5	Upward	8	250	Full	2
6	Combined	Combined Loads			
	Forward	25	250	Full	
	Lateral ^{3/}	9	250	Full	
	Downward ^{4/} (Stroking)	<u>5/</u>	140	Stroking Part	Full Stroke

Notes:

- 1/ The aircraft floor or bulkhead shall be deformed prior to the conduct of static tests and kept deformed throughout load application.
- 2/ Forward and lateral loads shall be applied prior to downward load application.
- 3/ The lateral loads shall be applied in the most critical direction.
- 4/ Under load at neutral seat reference point.
- 5/ Static load factor as necessary to meet dynamic test criteria.
- 6/ Effective weight of a 250 lb. “equipped” occupant.

JSSG-2010-7

The above static requirements contain a margin of safety to the ultimate static load factors on the design curves (see Design Guide's Static Load-Deformation Curves, figure 20) as compared to the peak accelerations of the dynamic design pulses to account for dynamic overshoot of the softer seat structure members and the loading rate sensitivity of seat materials.

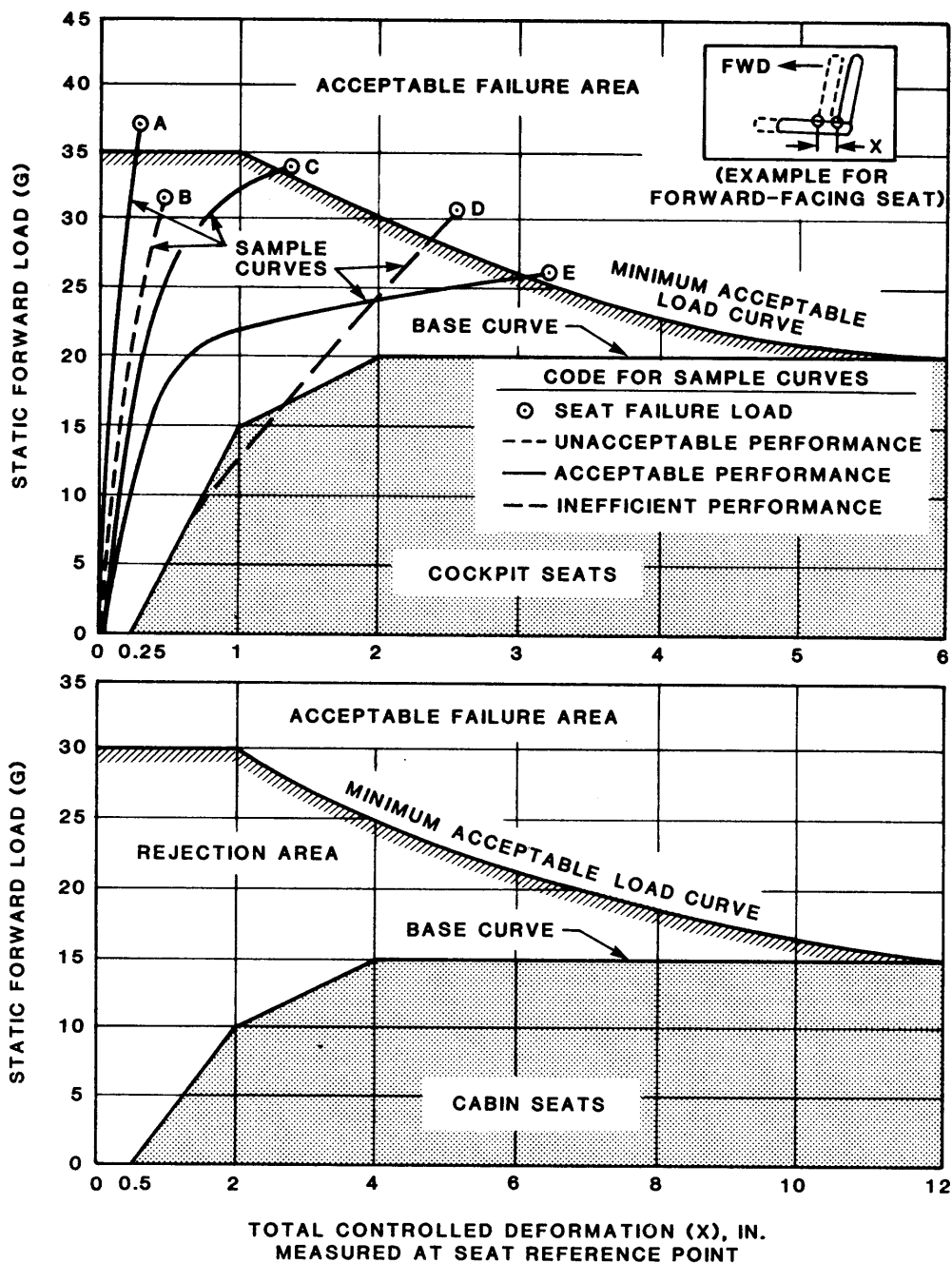


FIGURE 20. Seat Forward Load-Deflection Requirements for all Types of Rotorcraft and Light Fixed-Wing Aircraft

JSSG-2010-7

Dynamic tests. It is important to include a requirement for the contractor to simulate the surrounding aircraft structure (an essential element of the seat tie-down chain) in the test fixture for the seat and restraint system. This ensures that all areas of potential structural failure and occupant strike hazards are included in the verification process. Figure 21 provides dynamic qualification test requirements for crew seats cited within MIL-S-58095 that are significantly higher in crash severity for military rotorcraft and light fixed-wing categories as compared to the commercial aviation requirements.

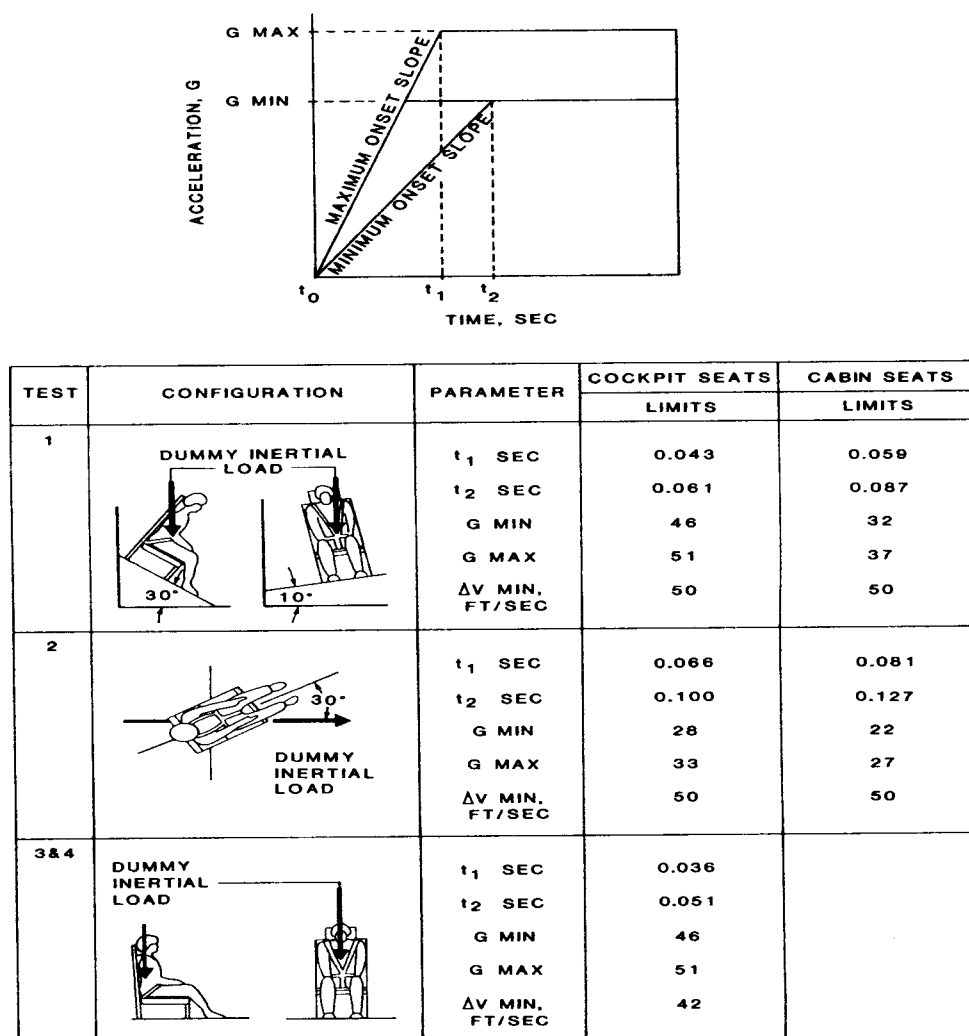


FIGURE 21. Dynamic Test Parameters for Military Rotary-Wing and Light Fixed-Wing Aircraft

Recommended ATD sizes:

Test Condition 1, 2, 4: Male 95th percentile

Test Condition 3: Male 5th percentile, unless the seat's adjustable load-limiter can accommodate the 5th percentile female aviator.

Note: Tests 3 and 4 are intended to assess performance of variable limit load energy absorbers.

JSSG-2010-7

Tables X and XI, extracted from the *Aircraft Crash Survival Design Guide, Volume IV: Aircraft Seats, Restraints, Litters, and Cockpit/Cabin Delethalization*, provide typical aviator, troop and gunner weights.

TABLE X. Typical Aviator Weights

Item	95 th -Percentile Weight (lbs.)		50 th -Percentile Weight (lbs.)		5 th -Percentile Weight (lbs.)	
	Male	Female	Male	Female	Male	Female
Aviator	211.7	164.3	170.5	131.4	133.4	102.8
Clothing	3.1		3.1		3.1	
Helmet	3.4		3.4		3.4	
Boots	4.1		4.1		4.1	
Total Weight	222.3	174.9	181.1	142.0	144.0	113.4
Vertical Effective Weight	175.2	137.2	142.3	111.0	112.6	88.1

TABLE XI. Troop and Gunner Weights

Item	95 th -Percentile Weight (lbs.)		50 th -Percentile Weight (lbs.)		5 th -Percentile Weight (lbs.)	
	Male	Female	Male	Female	Male	Female
Troop/ Gunner	201.9	164.3	156.3	131.4	126.3	102.8
Clothing	3.0		3.0		3.0	
Boots	4.0		4.0		4.0	
Equipment	33.3		33.3		33.3	
Total Weight	242.2	204.6	196.6	171.4	166.6	143.1
Vertical effective weight clothed	163.9	133.7	127.4	107.5	103.4	84.6
Vertical effective weight equipped	197.2	167.1	160.7	140.8	136.7	117.9

JSSG-2010-7

Note that “vertical effective” weights are also provided to aid in the calculation of equivalent limit load factors for energy absorbers.

Federal Aviation Administration (FAA) Test Requirements. In the late 1980s, the FAA cited “dynamic seat/restraint performance requirements” to demonstrate a capability to protect passengers under the following crash impact conditions (*designers should review current FARs for possible revisions*). Requirements for transport category aircraft seats are provided in 14 CFR, PART 25.561 “Emergency Landing Conditions. The FAA requires (1997) that seat and restraint systems must demonstrate a capability to protect each occupant under the following dynamic conditions (*designers should review current FARs for possible revisions*):

PART 25—AS: Transport Category Aircraft

A change in downward vertical velocity of not less than 35 ft/sec, with the airplane’s longitudinal axis canted downward 30 degrees with respect to the horizontal plane and with the wings level. Peak floor deceleration must occur in not more than 0.08 seconds after impact and must reach a minimum of 14g.

A change in forward longitudinal velocity of not less than 44 ft/sec, with the airplane’s longitudinal axis horizontal and yawed 10 degrees either right or left, whichever offset condition causes the greatest likelihood of the upper torso restraint system (where installed) moving off the occupant’s shoulder, and with the wings level. Peak floor deceleration must occur in not more than 0.09 seconds after impact and must reach a minimum of 16g.

Where the floor rails or floor fittings are used to attach the seating devices to the test fixture, the rails or fittings must be misaligned with respect to adjacent seat rails or fittings by at least 10 degrees vertically (i.e., out of parallel with one rolled 10 degrees).

PART 29—AS: Transport Category Rotorcraft

A change in downward velocity of not less than 30 ft/sec when the seat or other seating device is oriented in its nominal position with respect to the rotorcraft’s reference system, the rotorcraft’s longitudinal axis is canted upward 60 degrees with respect to the impact velocity vector, and the rotorcraft’s lateral axis is perpendicular to a vertical plane containing the impact velocity vector and the rotorcraft’s longitudinal axis. Peak floor deceleration must occur in not more than 0.031 seconds after the impact and must reach a minimum of 30g.

A change in forward velocity of 42 ft/sec when the seat or other seating device is oriented in its nominal position with respect to the rotorcraft’s reference system, the rotorcraft’s longitudinal axis is yawed 10 degrees either right or left of the impact velocity vector (whichever offset condition causes the greatest load on the shoulder harness), the rotorcraft’s lateral axis is contained in a horizontal plane containing the impact velocity vector, and the rotorcraft’s vertical axis is perpendicular to a horizontal plane containing the impact velocity vector. Peak floor deceleration must occur in not more than 0.071 seconds after impact and must reach a minimum of 18.4g.

Where floor rails or floor/sidewall floor attachment devices are used to attach the seating devices to the airframe structure for the conditions of this section, the rails or devices must be misaligned with respect to each other by at least a 10 degree lateral roll, with the directions optional, to account for floor warp.

Figure 22 provides schematic diagrams for similar military seat requirements cited within MIL-S-58095.

JSSG-2010-7

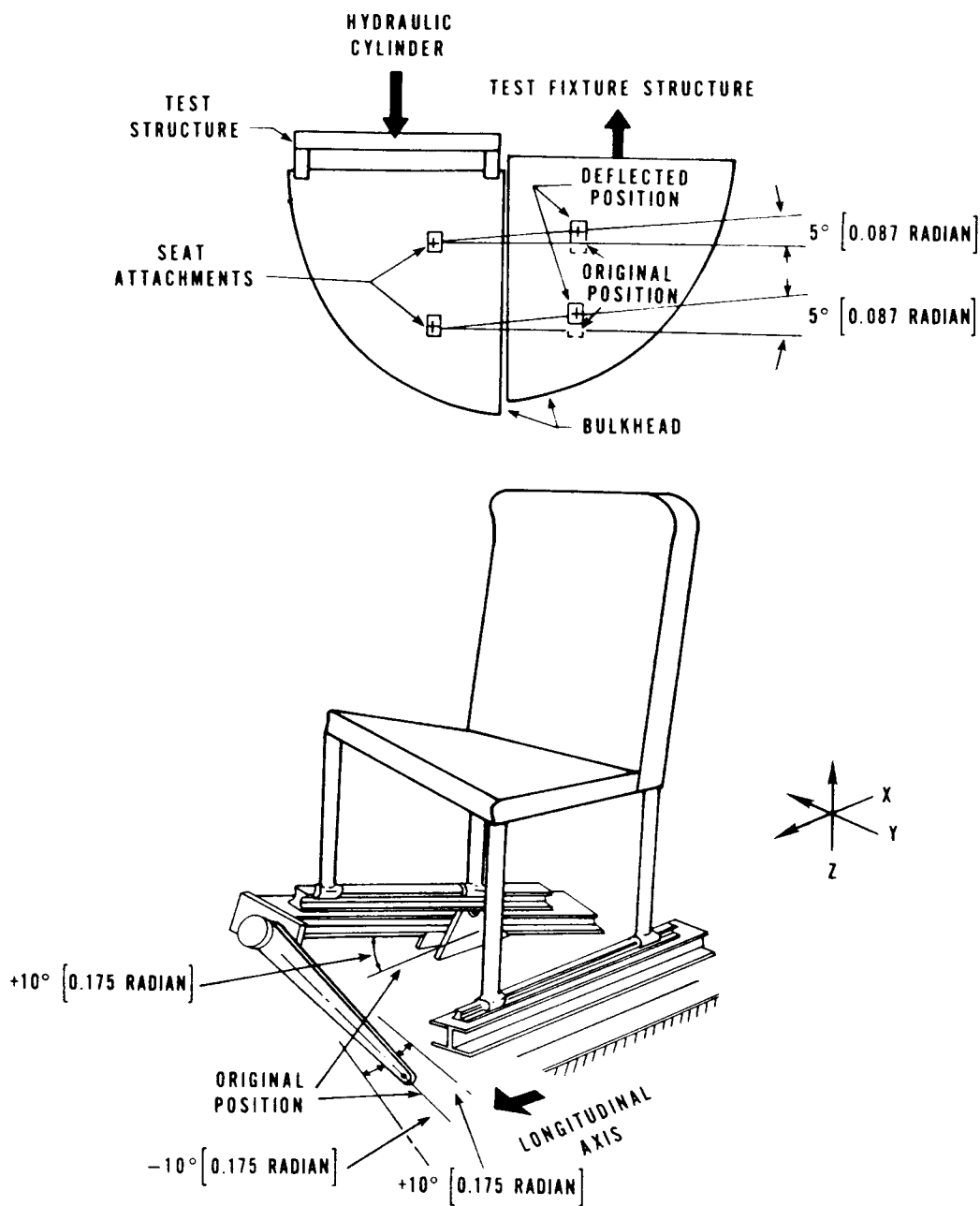


FIGURE 22. Floor and Bulkhead Misalignment Diagrams for Military Seats

Similar FARs are cited for commuter aircraft, general aviation category aircraft (i.e., PART 23), and normal category rotorcraft (i.e., PART 27). Specific dynamic test requirements are given below in Table XII.

JSSG-2010-7

Performance measures not to be exceeded during the dynamic tests are also cited for an upper torso strap peak force of 1750 lbs. (2,000 lbs. for dual straps), maximum occupant compressive load of 1500 lbs. measured in the lumbar spine of a 50th percentile male Part 572 ATD, and a Head Injury Criterion (HIC) value not to exceed 1,000.

The principal injury tolerance parameter cited in these dynamic requirements relative to contact injury prevention is the Head Injury Criterion (HIC). The “upper torso strap force” and “lumbar spine force” parameters are intended to evaluate the system’s ability to preclude acceleration-induced injuries. Table XII provides a summary of the FAA’s dynamic seat performance standards for the various civilian aircraft configurations

TABLE XII. FAA Summary Seat Dynamic Performance Standards

Dynamic Test Requirements	Part 23 Normal & Commuter	Part 25 Transport Fixed Wing	Part 27 Normal Rotorcraft	Part 29 Transport Rotorcraft
TEST 1				
Test velocity (ft/sec)	31	35	30	30
Seat Pitch Angle (degrees)	60	30	60	60
Seat Yaw Angle (degrees)	0	0	0	0
Peak Deceleration (G’s)	19/15	14	30	30
Time to Peak (seconds)	0.05/0.06	0.08	0.031	0.031
Floor Deformation (degrees)	None	None	10 Pitch / 10 Roll	10 Pitch / 10 Roll
TEST 2				
Test Velocity (ft/sec)	42	44	42	42
Seat Pitch Angle (degrees)	0	0	0	0
Seat Yaw Angle (degrees)	10	10	10	10
Peak Deceleration (G’s)	28/21	16	18.4	18.4
Time to Peak (seconds)	0.05/0.06	0.09	0.071	0.071
Floor Deformation (degrees)	10 Pitch / 10 Roll	10 Pitch / 10 Roll	10 Pitch / 10 Roll	10 Pitch / 10 Roll
Quantitative Compliance Criteria :				
Max HIC	1000	1000	1000	1000
Lumbar Load (lbs.)	1500	1500	1500	1500
Strap Loads (lbs.)	1750/2000	1750/200	1750/2000	1750/2000
Femur Loads (lbs.)	N/A	2250	N/A	N/A

JSSG-2010-7

FAA Side-Facing Seat Test Requirements. The FAA issued proposed Transport Category FAA Test Requirements and Injury Criteria for single unit Side-Facing seats in 1997 within *FAA Draft Issue Paper; Item # CI-X; Stage 1; dated Nov. 12, 1997*. The requirements are summarized below:

- **Existing Criteria:** All injury protection criteria of FAR 25.562 (c)(1) through (c)(6) apply to the occupant of a side facing seat. HIC assessments are only required for head contact with the seat and/or adjacent structures.
- **Body-to-wall/furnishing contact:** The seat must be installed aft of a structure such as an interior wall or furnishing that will support the pelvis, upper arm, chest and head of an occupant seated next to the structure. A conservative representation of the structure and its stiffness must be included in the tests. The contact surface of this structure must be covered with at least two inches of energy absorbing protective foam.
- **Thoracic Trauma:** Testing with a Side Impact Dummy (SID), as defined by 49 CFR Part 572, Subpart F, or its equivalent, must be conducted and the Thoracic Trauma Index (TTI) injury criteria acquired with the SID must be less than 85, as defined in 49 CFR Part 572, Subpart F. SID TTI data must be processed as defined in Federal Motor vehicle safety Standard (FMVSS) Part 571.214, section S6.13.5. Rational analysis, comparing an installation with another installation where TTI data were acquired and found acceptable, may also be viable.
- **Pelvis:** Pelvic lateral acceleration must not exceed 130 g. Pelvic acceleration data must be processed as defined in FMVSS Part 571.214, section S6.13.5.
- **Shoulder Strap Loads:** Where upper torso straps (shoulder straps) are used for occupants, tension loads in individual straps must not exceed 1,750 pounds. If dual straps are used for restraining the upper torso, the total strap tension loads must not exceed 2,000 pounds.

General Test Guidelines:

- One test with the SID ATD, undeformed floor, no yaw, and with all lateral structural supports (armrests/walls).
- One test with the Hybrid II ATD, deformed floor, with 10 degrees yaw, and with all lateral structural supports (armrests/walls). Pass/fail injury assessments: HIC; upper torso restraint force; restraint system retention and pelvic acceleration.
- Vertical (14 g's) test to be conducted with modified Hybrid II ATDs with existing pass/fail criteria.

Dynamic test requirements for Side-Facing Divans (Sofas) were provided in Draft Issue Paper # CI-I; Stage 2; dated Nov. 12, 1997. The proposed injury criteria are essentially the same as for the single-unit seat configuration with the following additional requirement:

- **Body-to-body contact:** Contact between the head, pelvis, or shoulder area of one anthropomorphic test dummy (ATD) on the adjacent seated ATD s is not allowed during the tests conducted in accordance with FAR 25.562 (b)(1). Incidental contact of the leg, feet, arms, and hand that will not result in incapacitation of the occupants is acceptable. Contact during rebound is allowed.

JSSG-2010-7

The general test guidelines have been modified for the Divan configuration as follows:

- All side facing seats require end closures.
- All seat positions need to be occupied for longitudinal tests.
- For the longitudinal tests, conducted in accordance with the conditions specified in FAR 25.562 (b)(2), a minimum of two tests will be required, as follows:
 1. One test will be required with one SID ATD in the forward most position and Hybrid II ATD s in all other positions, with non-deformed floor, no yaw, and with all lateral supports (armrests/walls).
 2. One test will be required with one SID ATD in the center seat and Hybrid II ATD s in all other positions, with deformed floor, 10 degrees yaw, and with all lateral supports (armrests/walls). This could be considered the structural test as well.
- For the vertical test, conducted in accordance with the conditions specified in FAR 25.562(b)(1), Hybrid II ATD s will be used in all seat positions.

VERIFICATION LESSONS LEARNED (4.7.3.2.2)

In past programs where energy-absorbing seats have been retrofitted into older aircraft not originally designed to withstand the higher loading for which the EA seats can provide protection, the verification of seat system performance has included dynamic testing to simulate the anticipated crash conditions. This testing, however, has traditionally been limited to the seat system and the aircraft attachment interface components only, without simulating the actual aircraft backup structure that carries the seat/occupant loads into the rest of the airframe. This level of verification has been dictated in the past by the knowledge that the retrofit ground rules prohibited any aircraft structural modifications, hence, there was no interest in simulating the aircraft backup structure. The one exception to this appears to be in the case of the Navy's development of a retrofit EA seat for the H-46 helicopter where the sub-floor backup structure was included in the dynamic test fixture. Not surprisingly, this retrofit seat installation has proven to remain reliably attached to the aircraft floor structure in numerous mishaps analyzed by the Navy.

Relative to this need to replicate operational structural interfaces with the occupant protection system during dynamic crash testing, two seat programs are noteworthy. Incorporating a section of the H-53's floor structure was not an option as was the case when the H-46E crew seat was qualified. Therefore, during dynamic qualification testing of the retrofit H-53 crash resistant crew seats, load cells were installed at the floor attachment locations to verify that the retrofit system would not dynamically overload the H-53's floor structure. The seat design incorporated longitudinal load-limiters to match seat strength to aircraft floor anchor strength. The qualification test report (*Simula Report TI-85446: Dynamic Testing; Qualification Test Report for H-53 A/D Crash-Resistant Crewseat*, Dec. 1985) states that the ability of the crewseat to withstand high forward and lateral loads was demonstrated during test condition 2. During the test pulse, the seat retained the occupant and had no structural failures. The floor loads were also limited to values below the ultimate strength of the floor. The maximum vertical floor load measured was 3310 lbs. The vertical floor load predicted by a finite-element analysis of the seat was between 3625 and 3700 lbs.

JSSG-2010-7

A similar approach is described by Moore (*"Integration of a Crashworthy Troop Seat System into the CH-53 D Sea Stallion"*, Moore, H., et al, presented at American helicopter Society 54th Annual Forum, May 1998). A methodology to qualify a dynamically tested troop seat for integration with an airframe structure designed to a static loads criterion was developed. Dynamic testing in conjunction with Finite Element Analysis (FEA) were used to quantify the capability of the airframe structure to react impulsive loads from the crash impact conditions. The authors concluded that application of both static and dynamic criteria to the integration of a crashworthy seat system into an existing helicopter platform was a valid methodology.

As a part of the FAA/NASA Controlled Impact Demonstration of a Boeing 720 in 1984, static and dynamic tests were performed on the seats to be installed in the test aircraft. In static tests of standard airline seats, the FAA found all seats were able to withstand a 9 g static load.

Dynamic tests were conducted at the FAA Civil Aeromedical Institute in Oklahoma City. The tests were conducted with a 9 g, 50 ft/s pulse equivalent to that used by CAMI in prior seat testing. This pulse was chosen because it allowed a sufficiently long 9 g deceleration to be applied to the seat and dummies, such that the maximum response of the seat was tested. The standards required seats to sustain a 9 g forward static load without failing. The test pulse was intended to test the seats' capabilities at a 9 g forward inertial load. This pulse initiated ultimate failures on all the standard seats tested. This illustrates the need for dynamic testing of seats to properly replicate the crash environment.

3.7.3.2.3 Cargo and Ancillary Equipment Retention

Cargo restraint systems shall be designed to control cargo displacements that are hazardous to occupants during a crash defined in 3.7.1. Additionally, all ancillary equipment carried aboard an aircraft shall be provided with integrated restraint devices or anchors to the aircraft structure such that their retention to the aircraft structure is maintained during a crash. Stowage space for non-restrained items shall be provided, and this space shall be located so items stored cannot become hazards to aircraft occupants. Detailed cargo restraint performance requirements are specified in the Vehicle Subsystems Specification Guide.

REQUIREMENT RATIONALE (3.7.3.2.3)

The complete rationale for the need of cargo restraint systems can be found in the Subsystems Specification Guide. From an occupant protection standpoint, the purpose of cargo and equipment restraint systems is to protect aircraft occupants from hazardous displacements of cargo and equipment in survivable crashes.

REQUIREMENT GUIDANCE (3.7.3.2.3)

Additional cargo and equipment retention guidance can also be found in *MIL-STD-1290, section 5.3*.

To determine the types of cargo and ancillary equipment restraining or fastening devices needed, it is important to consider the type of aircraft, the probable crash modes, and in case of cargo, the type of cargo being carried. Crew and passenger locations relative to cargo and cargo tie down provisions are also significant. The designer must consider the potential hazards associated with the shifting of cargo during missions in which both troops and cargo share the

JSSG-2010-7

cabin. This caution is particularly important when load limiting cargo restraints are employed to retain cargo. Potential intrusion of cargo into passenger space must be avoided!

General Guidelines:

- Provide sufficient restraint of cargo in all directions to prevent injury of occupants.
- Restraint system must not compromise livable volume (cause structural failure of airframe) or emergency egress.
- Cargo restraint and fixed equipment structural attachment to airframe must be strong enough to withstand structural loads of crash environment, if this is not possible, or the load requirements place an undo weight penalty, then load limiters should be used.
- Cargo restraints should be easy to install and remove.
- Cargo restraint should be easily and reliably adjustable for different sizes and shapes of cargo.
- Retention systems should prevent fragmented parts from cargo and equipment from becoming projectiles that could strike occupants, penetrate fuel and oxygen systems, etc.

Cargo and Equipment Restraint Guidance from MIL-STD-1807:

The following factors should be considered for cargo and equipment retention:

- a. Fixed and removable equipment includes all fixed and removable miscellaneous and auxiliary equipment and their subcomponent installations, including but not limited to, armament avionics, equipment, consoles, static lines, parachute airdrop shackle, emergency and survival equipment, escape capsule/fuselage attachment devices, retention system components for tools, ground handling implements, and other portable items, and mechanisms for operating and holding open canopies, doors, and other exits for egress, which in the event of a crash could result in injury to personnel or prevent egress from a crashed airplane.
- b. The dynamic loading conditions in a survivable crash environment.
- c. The design of the cargo and equipment retention system should consider the size, configuration, and orientation of the loaded item.
- d. Airdrop platform rigged items, when loaded into the aircraft restraint rails, have been restrained to the load factors required in this paragraph. However, the aircraft restraint rails (specifically the vertical lips) on the C-130 and C-141 aircraft were designed to provide the required restraint based upon the center of gravity being restricted to specific locations on the airdrop platform.
- e. MIL-STD-209 provides criteria for attachment (tie-down) provisions on the item that can interface with the aircraft's tie-down strength and physical dimensions.
- f. Consideration should also be given to using barriers, nets, etc., to supplement other retention systems to achieve the necessary level of restraint for cargo and equipment and their failed components.
- g. Retention systems should also prevent fragmented parts from cargo and equipment from becoming projectiles that could penetrate fuel systems, oxygen systems, airframe structure, personnel compartments, etc., and adversely affect the survivability of the occupants.

JSSG-2010-7

REQUIREMENT LESSONS LEARNED (3.7.3.2.3)**USAF Lessons Learned:**

a. The forward restraint criteria imposed by MIL-STD-1791 was lowered from 4 g to 3 g in July 1974. Refer to ASD TR-73-17, Final Report—Air Cargo Restraint Criteria, April 1973. Data presented in this report showed that the probability of a crash at the 3 g to non-survivable (20 g) level with cargo aboard was 0.000 002. At the 3 g to 20 g level with cargo and passengers aboard, the probability of a crash was 0.000 000 66 or once in each 1 500 000 flights. A follow-up report, ASD TR-76-30, Cargo Aircraft and Spacecraft Forward Restraint Criteria, December 1977, showed the probabilities to crash decreased based on additional data accumulated between 1971-1976.

b. The amount of restraint afforded by a tie-down (strap, chains, etc.) in a specific direction will be less than the capacity of the tie-down due to the angle at which the tie-down is attached.

c. Wheeled vehicles are usually self-limiting in their ability to withstand vertical downward forces. The limiting factor is the ability of the suspension system and wheels to resist down loads without a failure that would cause aircraft damage. For this reason, suspension loads are limited to the vehicle's cross-country rated capacity or its equivalent commercial rating. Where this rating is exceeded for flight, but not for loading, devices should be incorporated in the design of the vehicle to limit the load experienced by the suspension system to safe levels.

d. In the past some USAF fixed and removable equipment has been required to withstand the following load factors as applicable:

Longitudinal	9.0 forward, 1.5 aft
Lateral	1.5 right and left
Vertical	4.5 down, 2.0 up

Where some USAF fixed and removable equipment were located in a manner wherein failure could not result in injury to personnel or prevent egress, their respective airframe attachments and carrythrough structures were required to withstand the following ultimate load factors, as applicable:

Longitudinal	3.0 forward, 1.5 aft
Lateral	1.5 right and left
Vertical	4.5 down, 2.0 up

One problem with using these numbers is that it can be difficult to relate them to a specific crash scenario. An analysis would be required to relate a crash scenario to load requirements on equipment.

U.S. Navy Lessons Learned

The Naval Air Warfare Center developed load limiting cargo fittings to optimize performance of cargo anchor fittings under impulsive loading conditions. These devices based on the "wire-bending" principal of operation were flight tested in H-53 aircraft. Similar load limiting devices were selected for the V-22 cargo restraint system as it was demonstrated that this approach produced a significant weight reduction. The Subsystems Specification Guide and Handbook provides additional information.

JSSG-2010-7

4.7.3.2.3 Cargo and Ancillary Equipment Retention Verification

Verification of the cargo retention system shall be conducted in accordance with the requirements of the Vehicle Subsystems Specification Guide. Compliance with occupant protection requirements of 3.7.3.2.3 shall be incrementally verified by inspection, analysis and testing of the cargo systems and ancillary equipment throughout the air vehicle development cycle. The following incremental verifications shall be accomplished prior to the specified review:

- a. System Functional Review (SFR) - Verify that appropriate contractor documentation (i.e. specifications, systems engineering master schedule (SEMS), and contract statement of work (SOW)) include appropriate dynamic crash loads requirements for reacting the crash impact conditions specified in 3.7.1. Verify that analyses, as well as static and dynamic tests have been identified to demonstrate verification of the design concept.
- b. Preliminary Design Review (PDR) - Verify that the design analysis and preliminary engineering drawings employ an adequate design to react the dynamic crash loads specified, retaining structural integrity and controlling displacements to minimize potential occupant injury. Verify that load limiting cargo systems are precluded from displacing within habitable areas, during crash impacts defined by the impact parameters specified in 3.7.1.
- c. Critical Design Review (CDR) - Verify that detailed engineering drawings and component / system qualification tests comply with the crash impact requirements of 3.7.3.2.3.
- d. System Verification Review (SVR) - Verify that the air vehicle production design incorporates the qualified cargo system design and ancillary equipment retention requirements demonstrated during the qualification test program.

VERIFICATION RATIONALE (4.7.3.2.3)

Verifications of the basic operational performance requirements are cited in the air vehicle Subsystems Specification Guide. However, performance requirements of cargo and ancillary systems related to crash survivability are covered within this handbook. Actual testing of an item's ability to meet the requirements of 3.7.3.2.3 is the preferred method of verification. However, verification of the structural integrity of the retention system based on engineering analysis or established component strength ratings may also be acceptable.

VERIFICATION GUIDANCE (4.7.3.2.3)

Some additional guidelines for consideration during incremental verification are provided below:

- Review contractor's specifications to confirm that the airframe structural design includes requirements for withstanding the survivable crash impact conditions (acceleration levels and directions, velocity change magnitudes and directions) while maintaining the attachment integrity of all cargo and fixed equipment.
- Identify contractor's proposed method of controlling the displacement of cargo and ancillary equipment. Verify with subject matter experts that these proposed analytical tools are recognized and validated as acceptable for this intended use.
- Review results of final qualification component or system tests to evaluate predicted load/deformation characteristics and the resultant effect on aircraft occupants.

JSSG-2010-7

MIL-STD-1290, provides guidelines in this area for Light Fixed and Rotary-Wing Aircraft. The following is an excerpted summary of those requirements:

Cargo. Cargo restraints shall not permit cargo to shift in flight during turbulent weather, and shall provide restraint of cargo in accordance with the criteria provided below to prevent injury to personnel. Cargo shall be restrained to longitudinal loads of 16-G peak with a longitudinal velocity change of 43 ft/sec. Forward and lateral strength-deformation characteristics shall be in accordance with figures 23 and 24 respectively. If the structure of the fuselage and floor is not strong enough to withstand the cargo crash loads, load limiters shall be used to limit the loads transmitted to the structure. Nets used to restrain small bulk cargo shall be constructed of material with high stiffness characteristics in order to reduce dynamic overshoot to a minimum. Restraining lines having different elongation characteristics shall not be used on the same piece of cargo. If load limiters are used, restraining lines shall be of a material with low-elongation characteristics to insure the most efficient energy absorption.

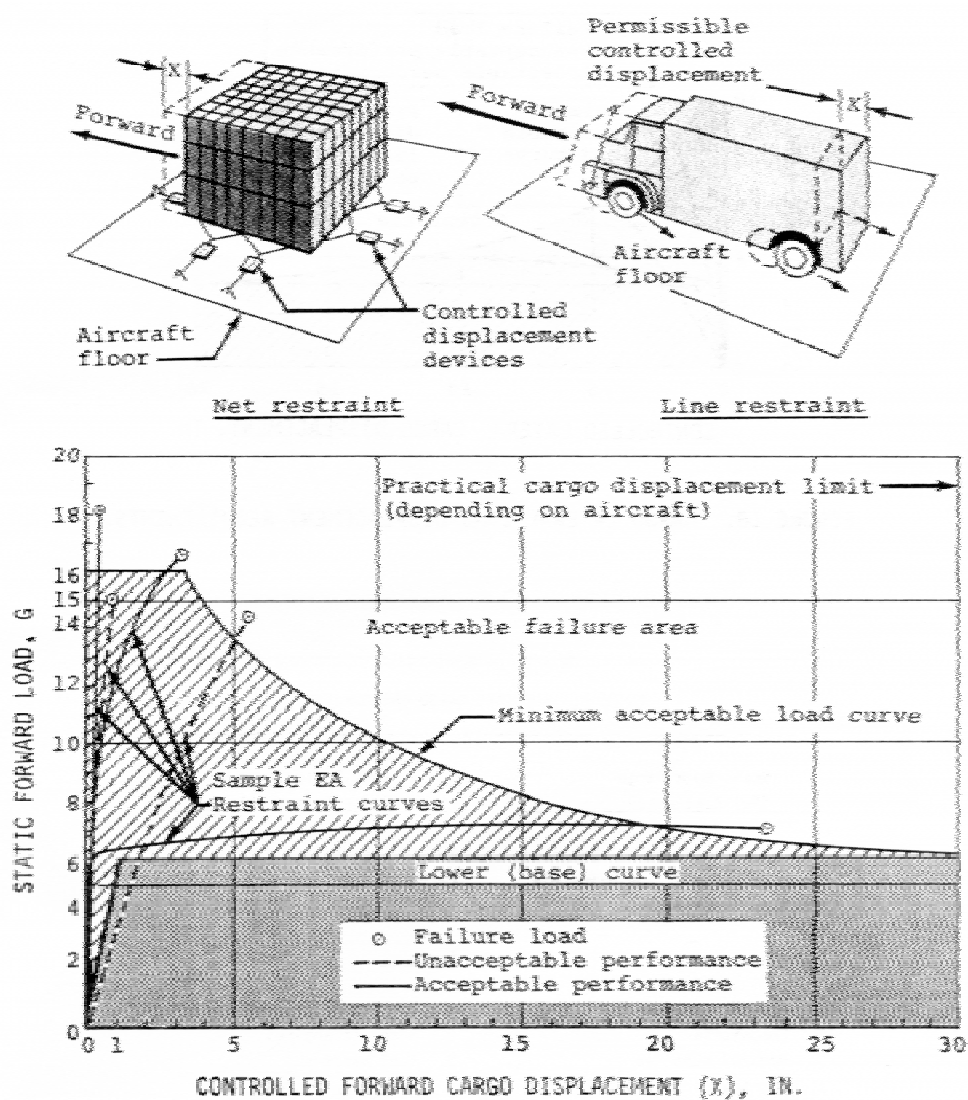


FIGURE 23. Forward load-displacement for energy absorbing cargo restraint.

JSSG-2010-7

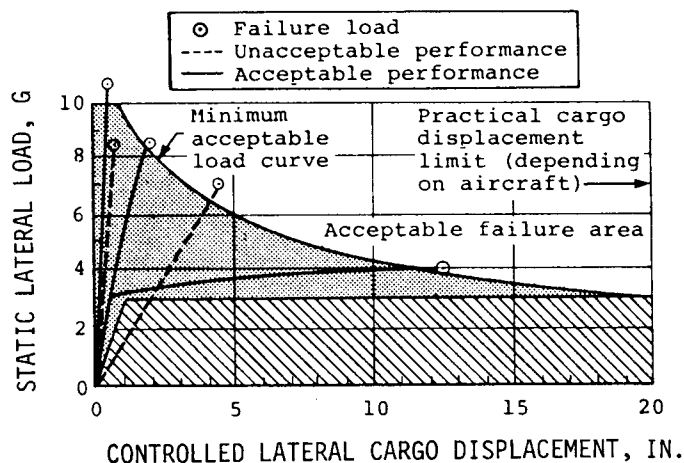


FIGURE 24. Cargo lateral load-displacement requirements.

Ancillary Equipment. All ancillary equipment carried aboard an aircraft shall be provided with integrated restraint devices or anchors to the aircraft structure. Restraint devices or anchors shall insure retention of the equipment during any survivable crash of the severity cited herein. Stowage space for non-restrained items shall be provided in all aircraft. This space shall be located so that the items stored in it cannot become hazards to occupants in a survivable crash. Ancillary equipment shall be restrained to 50 G downward, 10 G upward, 35 G forward, and 25 G sideward static load factors.

MIL-STD-1807 provides the following guidance:

- a. For the dynamic vertical up and down load conditions, the vehicle must be oriented as in the aircraft. The intent of this requirement is to have the cargo under a 1g static condition, then it is subjected to the dynamic loadings.
- b. When engineering analysis is the method used to qualify a vehicle carrying fluids, the analysis should include the effects of the fluid.

VERIFICATION LESSONS LEARNED (4.7.3.2.3)

Refer to the JSSG-2009, Air Vehicle Subsystems, for general operational data on cargo systems and specific information on the Navy's load limiting cargo concept.

3.7.3.3 Acceleration Injury Protection

The system shall incorporate means for controlling and minimizing acceleration-induced injuries so that injury tolerance levels of 3.7.2 are not exceeded.

JSSG-2010-7

REQUIREMENT RATIONALE (3.7.3.3)

This requirement ensures that severe injuries do not occur as a result of the body's inertial response to survivable crashes. Survivability during a crash impact requires dissipating the kinetic energy of the air vehicle mass in a controlled manner while providing a restraint system that allows the occupant to safely "ride-down" the crash forces involved. The design of an aircraft crash protection system must manage this energy dissipation, limiting accelerations, and thereby, limiting the crash forces transmitted to the occupant and occupant body parts to tolerable non-injurious levels.

REQUIREMENT GUIDANCE (3.7.3.3)

Acceleration injury mechanisms differ from contact injuries in that the injured organ or body member may be distant from the location of the applied force. Acceleration-induced injuries are due to the body's inertial response to the crash impact energy. An example of an acceleration injury is rupture of the aorta in a high sink rate crash. Here the application of the force occurs through the individual's thighs, buttocks, and back, where he is contact with the seat. The injury mechanism itself is due to shearing forces generated from the heart's inertial response to the resulting upward acceleration of the body. Other examples of acceleration injuries include: atlanto-occipital shearing, vertebral fractures, and contra-coup brain injuries.

With proper restraints, aircraft occupants can withstand much greater crash acceleration conditions in the longitudinal (G_x) direction than accelerations directed along the vertical axis (G_z) as shown in the Eiband Curves provided above. To achieve desired levels of acceleration protection requires that loads on the occupant be controlled by body positioning, restraint, and the controlled deformation of surrounding structure and seating systems.

The magnitude of crash forces is a function of the input velocity and stopping distance. The stopping distance is controlled by the crushing of the airframe in a given direction coupled with the gouging or penetration of the impact surface. The magnitude of the deceleration is inversely proportional to the stopping distance. In the case of a rigid structure impacting a non-yielding surface, the deceleration is infinite. Any crushing and displacement of structure and impacting surface reduces or attenuates the deceleration amplitude to finite levels. Often, however, there is insufficient structural crushing available in the airframe to attenuate crash forces to human tolerance levels. Therefore, tolerable levels must be achieved by increasing the effective stopping distance. The extra stopping distance required can be provided by using (1) additional crushable airframe structure (the landing gear is considered part of the aircraft structure for this discussion) to attenuate the crash impact condition, (2) a seat design which utilizes energy absorption mechanisms, such as load limiting or controlled seat collapse, or (3) a combination of both methods. The third is the preferred choice since crashes do not always occur in one attitude. Nor can one always count on the controlled deformation of the airframe structure and/or landing gear.

Unlike current transport category aircraft, light fixed-wing aircraft and helicopters provide minimal crushable structure to attenuate crash forces. This is particularly true for the vertical direction ($+G_z$). Consequently, additional means of absorbing crash forces in the vertical direction frequently must be employed to prevent acceleration injury in potentially survivable crashes.

JSSG-2010-7

Figure 25 provides relative frequency of spinal injuries versus change in vertical impact velocity for the Army's OH-58 helicopters (Reference: "Spinal Injury in a U.S. Army Light Observation Helicopter", Shanahan, D.F., and Mastroianni, G.R., USAARL Report No. 85-12, Sept. 1985).

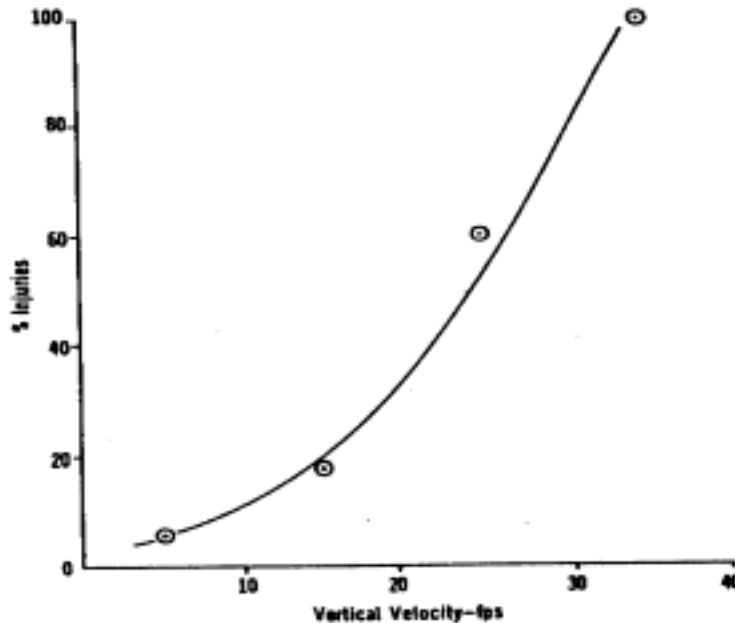


FIGURE 25. Relative Frequency of Spinal Injuries vs. Change in Vertical Velocity

Shanahan concluded that the strongest influence of impact conditions on injuries in potentially survivable crashes was the relationship between vertical velocity change and spinal injuries. The data indicate that significant numbers of back injuries occurred even in impacts of less than 20-ft/sec vertical velocity change. Analysis of the individual cases revealed other factors had an influence on the low impact velocity cases. These other influences included the longitudinal and lateral components of the impact velocity and the occupant's seating position at the time of impact. However, the strongest influence was shown to be the vertical velocity change. Increasing proportions of all occupants received spinal injuries as the impact exceeded the reserve energy sink speed of the aircraft's landing gear (12 ft/sec). The OH-58 mishap data indicate that ground impact loads are transmitted with minimal reduction through the fuselage and seat to the occupants once the skids have bottomed out.

Energy Absorbing Seats

Several energy-absorbing mechanisms have been developed for use in aircraft seats and for other shock-load applications. The basic function of an energy-absorbing mechanism or structure is simply to limit the forces transmitted through the mechanism by allowing the mechanism or structure to undergo permanent deformation. A load-limiting mechanism or device ensures that a pre-selected load is not exceeded in a structure during an impact. The "limiting" of a load to a pre-selected value is achieved by permitting controlled movement of the restrained mass with respect to the aircraft floor. There are many ways of accomplishing a "load-limiting" function in a restraint system. In order to select an optimum device, ensure that:

JSSG-2010-7

(1) the device provides a predictable force-versus-deformation profile; (2) the rapid loading rates expected in crashes do not cause a significant change in the force-versus-deformation characteristic of the device; (3) the specific energy absorption (SEA) is high; (4) the device is economical; (5) the device is light and small as possible; (6) the device will perform satisfactorily without requiring maintenance throughout the life of the aircraft (10 years minimum); (7) the assembly in which the device is used has the ability to sustain tension and compression (depending on system design, this may be provided either by the use of one or more energy absorbers, or by the basic structure itself); (8) is capable of performing its energy absorbing duties despite multidirectional loading (this is a function of the entire system design); and (9) the device should provide resistance to rebound after stroking.

Energy absorbing crew-seats have been extremely effective in preventing acceleration-induced injury in crashes with predominately vertical force vectors. Experience with these seats in crashes has produced several lessons. First, it is essential that the seat/floor structure anchors have adequate tie down strength so that crash forces do not dislodge them.

Designs that provide multi-axis stroking may not be as effective as those providing single-axis vertical stroking. Consideration must be given to the strike envelope when designing a forward-stroking energy-absorbing seat. Factors that affect this are objects and structures at the boundaries (or within) the strike envelope, uneven weight distribution, and uneven occupancy. Protection must be provided against objects near or within the strike envelope (discussed in strike envelope section) when the stroking of the seat will exacerbate the problem (will the pilot be impaled on the controls or strike them, causing injury?). Seating pitch must be examined to determine whether sufficient room exists for forward-stroking seats. In multi-occupant seats, the effects of uneven weight distribution must be considered. How will this affect seat deformation, strength, and energy absorbing capability and energy transmitted to the occupant(s) (for example, a triple occupant seat with an empty seat on the left, a 5th percentile occupant in the middle, and a 95th percentile on the right)? The uneven distribution will cause uneven deformation. This seat must be designed so that this does not affect the strength. Since, with two occupants, the weight on the seat will be less than with three, consideration must be given on how this (and the uneven deformation) will affect the energy-absorbing stroke. The seat must not bind and it must not transmit greater than tolerable forces. Variable-load energy absorbers may have to be utilized. These affects must also be projected to other directions. Uneven deformation in longitudinal direction must not affect energy absorption in the vertical direction and vice versa (this applies to deformation due to factors other than the stroking of energy absorbers as well).

Uneven occupancy can cause problems for multiple rows of seats (an occupied row in front of three 95th percentile occupants). The affect on the strike envelope in cases like this must be examined. The solution can simply be close control over occupant distribution in the aircraft.

Vertically stroking seats potentially increase the probability of lower extremity contact injuries and cyclic strikes. Finally, the occupant's frame of reference will change due to seat displacement and may adversely affect emergency egress, or the operation of other safety devices such as emergency release mechanisms.

For practical application in seats, the energy absorber must also be efficient, i.e., it must have a relatively high specific energy dissipation per unit weight (refer to Table 4, "Comparison of Load-Limiting Devices for 1000 to 4000-lb. Loads," found in Volume IV of the Aircraft Crash Survival Design Guide). The principal design goal of an energy absorber is to limit the force transmitted through the mechanism to tolerable levels, protecting the seat occupant from injury. Secondly, the energy absorber can reduce structural reaction forces in the seat-airframe

JSSG-2010-7

anchorage, possibly resulting in weight savings and limiting the potential for the seat to become dislodged.

Variability of occupant weight is a design issue with vertical energy absorbing seats. Fixed-load energy absorbers have typically been designed for the 50th percentile male occupant weight under the conditions of a 95th percentile crash (i.e., a crash pulse defined by a triangular-shaped pulse with a 48 G peak, and a 50 fps velocity-change). The static limit-load factor for this military design point has been typically established at 14.5 G (a level of 11.5 G has been established for the 50th percentile male civilian). Occupant weights on either side of the design point theoretically produce less than desirable performance for this configuration. A heavier weight occupant in this seat configuration, subjected to the design crash pulse produces a greater stroke distance, at reduced acceleration levels. Conversely, a lighter weight occupant would not cause the energy absorber to stroke through the full distance available, and he/she would be subjected to higher acceleration levels. Currently, all crew seats in the H-60 rotorcraft family employ "fixed-load" energy absorbers, with the exception of the VH-60 executive cabin seats. *Volume IV (Aircraft Seats, Restraints, Litters, and Cockpit/Cabin Delethalization)* of the Aircraft Crash Survival Design Guide provides a detailed description of the design analysis involved in establishing energy absorber performance parameters.

A second-generation design employing manual adjustment of the limit-load setting is operational in several rotorcraft models, i.e., H-53, H-3, and V-22. The H-3 and H-53 systems were retrofitted into the aircraft during operational safety improvement programs. They use inversion tube technology as the force limiters and provide manual adjustment of the force setting to optimize the system's performance by matching the limit-load to the occupant's weight. Retrofits of this variable-load energy absorber design are planned for the U.S. Army's H-60 helicopter fleet.

The V-22 system is based on a wire-bender principle, and employs a three-stage set of wires with an adjustable roller mechanism to match occupant weights. This system is also operator dependent. Obviously, the requirement for occupant adjustment presents a negative feature to this system with the potential for misuse and impact on pilot workload.

The four load-limiting devices currently operational (1998) in military rotorcraft are listed in table XIII.

Currently, an automatic energy absorber system (AEAS) is under development by the US Navy and Simula Technologies, Inc. The AEAS combines the benefits of the variable force EA with an electronic weighing and adjusting feature that automatically sets the seat stroking parameters. This EA design varies the force as the seat strokes. The force varies in such a way as to anticipate the dynamic response of the human. Initially, the force is lowered to manage the dynamic amplification associated with spinal compression. Once the peak compressive force in the spine has passed, the EA load is increased in order to absorb energy faster and, thus reduce the stroke required to safely decelerate the occupant.

JSSG-2010-7

TABLE XIII. Operational Energy Absorbers

Device Description	Applicable Seats
<ul style="list-style-type: none"> • Strap/Wire-over-Die or roller based on a metal bending and friction process 	<ul style="list-style-type: none"> - H-60 Troop seats - V-22 Crew Seats in a Variable Load Configuration
<ul style="list-style-type: none"> • Inversion Tube based on hoop tension/compression and bending process. 	<ul style="list-style-type: none"> - H-60 Crew Seats - H-53 & H-3 Crew Seats in Variable Load Configuration - VH-60 Executive Cabin Seats in Variable Load Configuration - AH-64 Crew Seats
<ul style="list-style-type: none"> • Rolling Torus based on cyclic compression and bending process 	<ul style="list-style-type: none"> - CH-46 E Crew Seats in Multi-axis Configuration - H-60 Crew Seats (BLACK HAWK models, only)
<ul style="list-style-type: none"> • Tube Expansion based on Hoop Tension and friction process 	<ul style="list-style-type: none"> - V-22 Troop Seats

This concept provides automatic adjustment, reduces required seat stroke to react a given level of impact energy, and provides for a wider range of occupants (i.e., provides equal protection to lighter-weight occupants). Test results indicate that a heavy aviator (220-lb) can receive the same level of protection as in current systems but with a stroke reduction of approximately 4 inches. (*Simula TR-97256, "Development of an Automatic Energy Absorber System For Crashworthy Helicopter Seats", Feb., 1998*).

Troop seats should be designed for the maximum vertical displacement feasible to maximize protection over the larger weight range represented by fully equipped and lightly equipped occupants. Because troops do not have operational functions to perform and troop seats are not armored, more flexibility exists in troop seat design. Use the full 431.8 mm. (17 in.) seat height for the energy-absorbing stroke. As a minimum, size the limit load of the system for the midpoint of the total effective weight of the occupants and equipment. Variable-level load limiters sized as discussed previously are also recommended for troop seats; however, justifiable cost and logistics problems may dictate the single-level, load limiter approach.

As for longitudinal deformation, the same considerations must be applied to vertical energy absorption (strike zone (especially control sticks), uneven weight distribution, and uneven occupancy). Compromises made in attenuation capabilities must not affect the ultimate loads in other directions (i.e., sacrifice forward attenuation for vertical but not at the expense of decreased longitudinal strength that must be at least up to human tolerance limits).

Head Restraint (Headrest).

Attach the headrest to the seat bucket so that it moves with the seat bucket during stroking of the energy absorption mechanism so as to support and protect the head. Contour the headrest and provide energy absorption qualities to minimize whiplash injuries for the desired range of the expected clothed occupant population. Use headrest cushioning material which is resilient,

JSSG-2010-7

durable, comfortable, and will not pack due to use. Ensure that the headrest does not interfere with the ingress or egress of an occupant wearing a back-type parachute.

Seat Orientation.

Due to the human's non-uniform tolerance to force, in some cases it is possible to greatly enhance occupant survivability by proper seat orientation in the aircraft. For non-critical occupants and crewmembers whose duties do not require them to face forward, by far the best choice of seat orientation is rearward facing. This orientation provides the best protection for longitudinally applied accelerations as discussed above. Furthermore, the entire body is completely supported (a high back must be used) providing the largest possible surface area for force distribution.

Forward facing seats with lap belt only restraints should be avoided for any application. Lap belt only restraints provide poor restraint and lead to a host of injuries in – Gx impacts. Not only is there a proclivity towards submarining resulting in spinal fractures (when combined with jack-knifing caused by longitudinal forces) and abdominal injuries, but also chest injuries due to leg and thigh impact and injuries to the head and neck from excessive whipping action.

Side facing seats should also be avoided due to poor human force tolerance and the difficulty in providing adequate restraint. Use of a diagonal shoulder harness in side facing seats (V-22 troop seats employ a diagonal shoulder harness) while reducing the hazard of upper torso contact injuries may not appreciably improve the acceleration injury prevention capability of the side facing seat configuration. The FAA and SAE are currently pursuing interest in the “side impact” crash scenario for commercial aviation applications. Automotive experience with the three-point harness provides insight into the deficiencies of the configuration relative to potential neck injuries.

The Naval Biodynamics Laboratory (NBDL) conducted a series of human volunteer tests to establish maximum volunteer levels of lateral impact response to + Gy impact accelerations. The NBDL tests used a double shoulder harness/lap belt configuration with additional lateral support provided by a seat side panel. NBDL researchers were concerned with potential for carotid artery laceration as well as cervical neck fractures. A summary of the test conditions and results is provided below:

Restraint Employed:

- Double Shoulder Harness (3 inch wide webbing) and Lap Belt.
- Additional Upper Torso Harness (Intended to provide principal lateral restraint).
- Seat Side Panel (Intended to provide minor lateral restraint only).

Impact Parameters:

- Velocity Change ~ 21.3 fps
- Peak Accelerations ~ 4 G at ~ 220 milliseconds up to 12 G for ~ 50 milliseconds.

Results: A peak acceleration level of ~ 21.5 Gy was achieved during the “Contoured” Couch test phase of the study. The test program is explained in more detail in the following two SAE papers: SAE 770928: “Dynamic Response of Human Head & Neck To + Gy Impact Acceleration” and, SAE 780888: “Effect of Initial Position on Human Head and Neck Response to + Gy Impact Acceleration”.

JSSG-2010-7

Although the NBDL tests established limits for well-restrained volunteers, the following references provide data more applicable to the military side-facing troop seat restraints located in the V-22, and proposed for the H-53 helicopter.

SAE 79 1005: *“Response of Belt Restrained Subjects in Simulated Lateral Impact”*, Horsch , Raasch (GM & University of California)

This study evaluated performance of a typical automotive three-point restraint configuration using a Part 572 (i.e., Hybrid II) ATD and human cadavers. The restraint system was anchored in two configurations, i.e., inboard and outboard relative to the impact vector. The impact conditions and results are summarized below:

Impact Conditions:

- 90 Degree Impact Vector, only
- Impact Velocity : ~ 32 fps
- Peak Acceleration: ~10 g's for a 110 milliseconds time base

Results: Neck injuries were found in both anchor configurations. However, injuries were more extensive to the cervical region of those subjects receiving direct neck and/or head loading from the shoulder belt. It was also noted that shoulder belt anchor locations played a role in occupant response & injury potential. The authors speculated that if the restraining force could be shifted from the neck/head region to the thorax, this would reduce the challenge to the cervical region.

SAE 801310: *“Occupant Dynamics as a Function of Impact Angle & Belt Restraint”*, Horsch ; GM

This study investigated the effect of providing additional lateral restraint to the occupant via a thorax support located on the impact side.

Results:

- Lateral support of thorax substantially influences performance of the lap/shoulder belt in oblique and lateral impacts.
- Direct loading of neck and neck shear loads were greatly reduced by lateral support of the thorax.
- Head HIC s and Thorax Gy parameters were not affected, indicating these parameters were not sensitive indicators of potential injury.
- Lateral impacts that displaced the upper body toward the shoulder-belt anchor (-30 to -90 degrees) resulted in direct loading of the head and neck.
- Although the lateral torso restraint restricted the lateral displacement of the lower body, maximum neck shear was similar to comparable tests without pelvic restraint. However, there was a reduced shoulder-belt tension and belt/neck interaction force.

SAE 810370: *“Influence of Lateral Restraint on Occupant Interaction with a Shoulder Belt or Pre-inflated Air Bag in Oblique Impacts”*; Culver & Viano; GM

JSSG-2010-7

The restraint system evaluated in this study was a 3 point lap/shoulder belt supplemented with an Energy Absorbing Seat Wing Lateral Support. It was concluded that a seat wing improves the control of the dummy's dynamics in oblique impacts by directing the occupant's motion more forward into the restraint system. This takes more advantage of the restraining potential of the shoulder belt in controlling the deceleration of the dummy and enhancing the benefit of the restraint system.

US Air Force Investigations. Two U.S. Air Force investigations were conducted in the mid-1960s.

1. "Human Tolerance to Lateral Impact With Lap Belt Only", Albert V. Zaborowski; Captain, USAF, 6571st Aeromedical Research Laboratory (~ 1964)

The restraint system in this study consisted of a single continuous lap belt fabricated with 2 layers of 3-inch wide polyester webbing. The seat was configured with a 30-degree side plate. Thirty-seven AF volunteers were subjected to a series of experiments ranging from ~ 3 Gy to ~ 9 Gy peak levels with an average delta V of ~ 15 fps.

No permanent physiological changes were noted up to the 9.0 Gy average peak @ a 0.1 second impulse duration. It was concluded that some support to restrict lateral flexion would be most helpful.

2. "Lateral Impact Studies ; Lap Belt / Shoulder Harness Investigations", Albert V. Zaborowski; Captain, USAF, 6571st Aeromedical Research Laboratory (~ 1965+)

A double shoulder harness configuration (3-inch wide polyester webbing) with lap belt was used in this study. Fifty-two volunteers were subjected to a total of five series of 20 runs each at the + 4 Gy level, 20 at the + 6 Gy level, 25 at the + 8 Gy level, 20 at the +10 Gy level, and 2 at the + 12 Gy level. Velocity change was kept essentially constant @ a relatively low level of ~ 15 fps. Human tolerance as defined for this study was based on kinematic motion and physiological endpoints.

Volunteers were able to sustain an increase of ~ 30 percent greater peak Gy levels (12 g vs 9 g) with the addition of the double-shoulder harness. The test series was halted at the 12 Gy level when one of the subjects suffered bradycardia (defined as slow heart rate). He complained of nausea, dizziness, and impingement of the left shoulder strap on the left side of the neck.

Dynamic Amplification Factor.

Seat systems incorporating seat cushions and restraint harness materials require design consideration of the dynamic amplification factor, sometimes referred to as the "dynamic overshoot" phenomenon. Amplification of crash forces is directly related to the elastic properties of the harness material and the elastic rebound properties of foam padding, coupled with the human body's naturally compliant characteristics. Dynamic overshoot is defined as the amplification of decelerative crash forces, experienced by the vehicle occupant, above the aircraft floor decelerative force (i.e., ratio of output to input). This amplification is a result of the dynamic response of the system. Overshoot factors of 1.3 to 1.7 times the input peak load

JSSG-2010-7

have typically been measured, but may be much greater. Dynamic overshoot can be attributed to the response of the non-rigid components reacting to the dynamic input pulse. The occupant's body also plays a role in the process. Essentially, the entire system (occupant/seat/restraint) represents a spring-mass-damper, and as such is a function of the natural frequency and damping characteristics of the total system. The Air Force's Dynamic Response Index (DRI) provides a spinal injury criterion based on this principle, which has been used to qualify ejection seats and has also been used to comparatively assess crash resistant energy absorbing seat systems. AFGS-87235 (paragraph 3.2.1.2.2.10 on acceleration limits) and the Biomechanical Protection Branch, AAMRL/BBP, Wright-Patterson AFB OH 45433, should be consulted for current guidance on DRI calculation and human tolerance limits. Since the "zone of safety" and "zone of probable disablement" are separated by a gray area and it is probably rather large depending on the individual and other factors (including the fact that these are considered tolerable levels—survivable without severe incapacitation is probably higher), it is probably better to design the seating system strength on the high side but keep force limitation requirements within limits shown—especially since energy absorbers decrease the force by increasing its duration (an attenuated load over a longer period of time). Further guidance on force tolerance can be obtained in both the U.S. Army Aircraft Crash Survival Design Guide, Volume II, (USARTL-TR-89-D-22B) and AFGS-87235.

The higher deceleration levels resulting from this amplification factor can produce excessive loads on the human body, and can also overload a structural member in the tie-down chain. In addition to causing injury to the occupant, this could cause failure of the restraint system or attachment structure, failure of the seat structure and its attachment fittings, or failure of the floor track and supporting structure. Thus, it is important to design and test the strength of every component in the tie-down chain up to the "amplified" response level to properly address this phenomenon. Figure 26 describes the classic occupant "ride-down" response in terms of a relative velocity differential between the occupant and the aircraft structure resulting in greater decelerations experienced by the occupant.

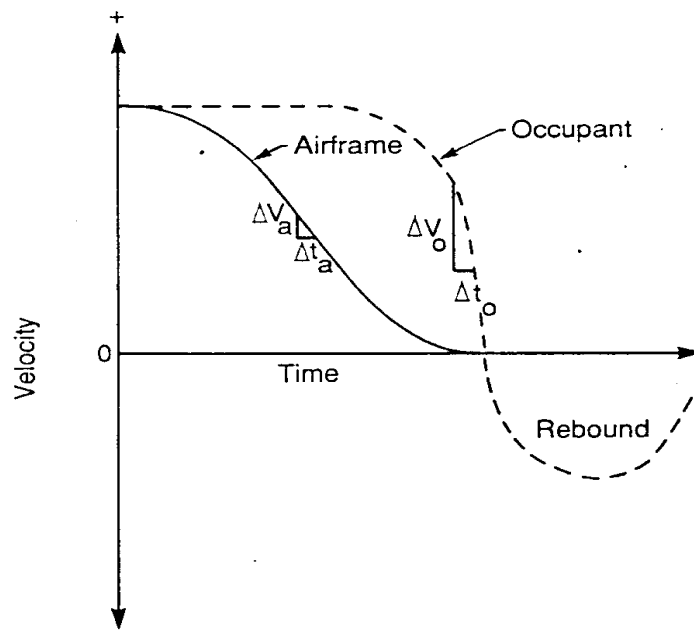


FIGURE 26. Occupant response (ride-down) curve

JSSG-2010-7

Protection of the occupant from excessive vertical or spinal loading was initially specified in MIL-S-58095 by limiting seat acceleration in the vertical direction to the area of acceptable acceleration magnitude-duration specified by the Eiband tolerance curve. Starting with the Black Hawk crew seats, this criteria limited duration of seat accelerations in excess of 23 G's to not more than 0.025 seconds. Figure 27 shows a typical Hybrid III ATD response to a crash pulse of 20 G peak acceleration and 25 ft/sec. velocity change. The amplified response of the ATD's thorax and pelvis are shown for the spinal axial vector (i.e., + Gz, headward). Lumbar force along the spinal axis is also plotted for this test. The data was measured during a study of Hybrid III response to + Gz crash loads (SAE 981215: "Impact Response of Hybrid III Lumbar Spine to + Gz Loads", Schoenbeck, A., et al, 1998 SAE).

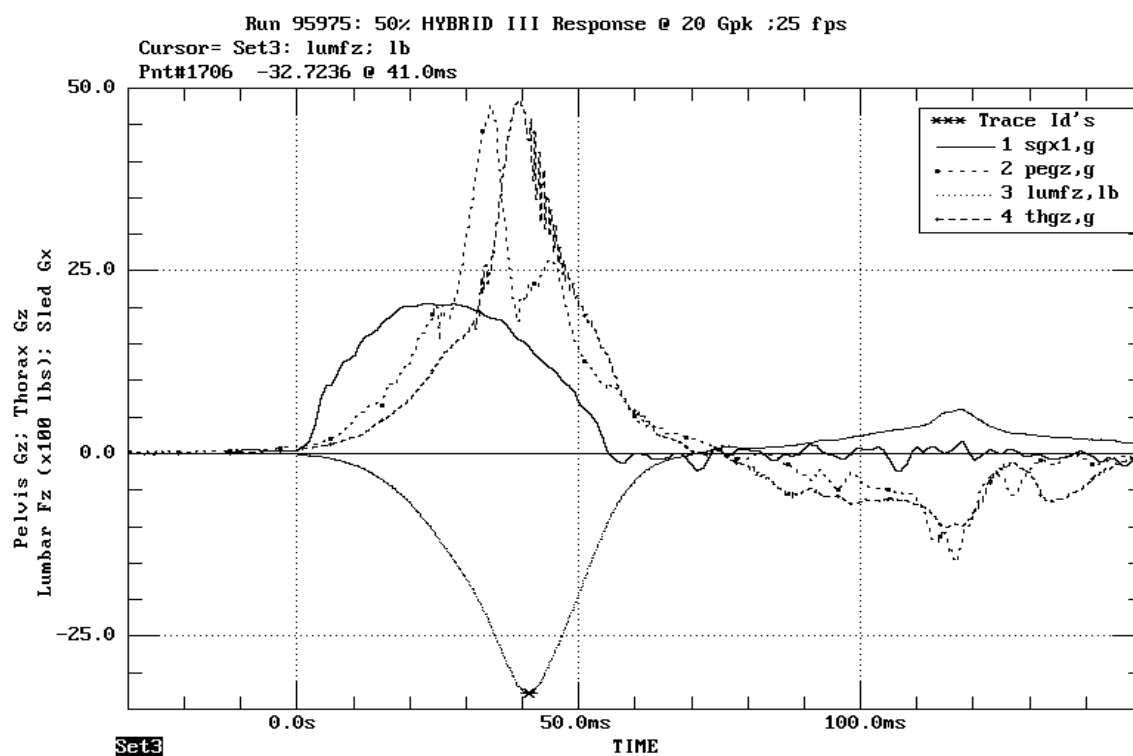


FIGURE 27. Typical Vertical Response Parameters of 50th Percentile Hybrid III ATD at 20 G Peak; 7.625 m/s Velocity Change

Restraints

Tolerance to crash loads is directly influenced by the method of restraint employed. In the forward direction, "eyeballs out", the human body is capable of withstanding about 15 G's with a lap belt only, assuming that the area in front is clear of obstructions. However, the addition of upper torso restraint increases the tolerance in this direction to about 45 G's, a three-fold increase. (*Helicopter Crashworthiness by Roy Fox*)

JSSG-2010-7

The most predominant impact direction for a helicopter occupant is vertical (i.e., “eyeballs downward”). A shoulder harness increases human tolerance without injury for the vertical direction from 4 G’s to 25 G’s, an improvement factor of six. A shoulder harness enhances occupant survivability in the vertical impact scenario because it retains the occupant’s pre-crash position (i.e., upper torso remains essentially upright), keeping the spinal column aligned properly and allowing it to carry much higher crash loads.

Laterally, the shoulder harness increases tolerance by a factor of two.

Although the Inflatable Body and Head Restraint System (IBAHRS) was designed to react -Gx crash loads primarily, it was also recognized that the inflated bladders would provide a mechanism for aligning the upper torso posture during vertical crash loads, and enhance the military aviator’s tolerance to vertically-oriented crash loads.

A special Crashworthiness Project Group recommended to the FAA that a shoulder harness be required for all occupants for future helicopter designs. They also recommended that the torso restraint system specification *SAE AS-8043*, developed by the Society of Automotive Engineers (SAE), be used either in the dual or diagonal shoulder belt configuration. *SAE AS-8043* was compatible with dynamic seat testing recommended by the General Aviation Safety Panel for helicopters and for light-fixed-wing aircraft. The *SAE AS-8043* would double the lap belt loop strength from 3,000 pounds (13,345 newtons) to 6,000 pounds (26,689 newtons), and provide a 2,500 pound (11,121 newtons) shoulder belt. The FAA later created a new *Technical Standard Order, TSO C114, Torso Restraint System*, which included *SAE AS-8043*.

The basic military restraint configuration for crew seats is comprised of a five-point harness configuration (i.e., double shoulder harness, lap belt and tie-down strap) with a quick-disconnect buckle and an inertia reel anchorage for the shoulder harness assembly. The MIL-S-58095 design requirements are provided in Table VI, under 3.7.3.2.2 Requirement Guidance. Detailed design requirements for the MIL-S-58095 restraint system are provided in Volume IV of the Aircraft Crash Survival Design Guide.

Seat Cushions

Like restraints, cushions form the interface between the occupant and the seat, and thus play an important role in the crash performance of the seating system. Seat cushions should not be relied-on to absorb crash energy in the predominant vertical direction for rotorcraft applications. Load-limiting (crushable) seat cushions are undesirable for two reasons:

1. The downward movement of the torso into a crushable seat cushion produces slack in the restraint harness. This slack can produce injury during subsequent longitudinal acceleration in forward facing seats by contributing to dynamic overshoot or by allowing the lap belt to move upward into the soft tissues of the abdomen.
2. A crushable cushion does not make best use of the available stroke distance, since space must be allowed for the crushed material. Crushable cushions are impractical in rotary and light fixed-wing aircraft because of the relatively significant stroking distance required to limit the high vertical loads. For example, approximately 12 inches of stroke are required to attenuate the vertical crash loads in a 42 ft/sec vertically directed crash pulse. Energy

JSSG-2010-7

absorbing seat cushions may be acceptable for transport aircraft applications where the vertical impact energy is essentially reacted by the fuselage crush.

Seat cushions should be designed to fit the contour of the human body. This must be approached with caution, however, since it is difficult to accommodate all humans adequately. The thickness of soft, elastic foam type material used for a comfort cushion should be based on compressions by the range of the weights of the occupants to help prevent dynamic overshoot and "submarining." In the past a requirement has been that the thickness of the foam type material not exceed 12.7 mm (0.5 in.). A net-type seat cushion has been considered acceptable for use provided it prevents contact between the occupant and the seat pan under vertical loading and that its rebound characteristics limit occupant return movement from the point of maximum deformation to 25.4 mm (1.0 in.). If net-type cushions are employed, ensure that they are compatible with any parachutes or survival kits required. Design seat cushions to minimize both occupant "submarining" and dynamic overshoot. Consideration should be given to "rate-sensitive" foam cushions. These cushions have the capability of damping out acceleration spikes without inducing dynamic overshoot. Slow recovery foams such as Temperfoam, Ethafoam, Confor foam, and Ensolite are used in various rotorcraft military crewseats in specific configurations to provide occupant comfort and cushioning the occupant's ischial tuberosities from contact with the seat pan's surface during downward loading. Figure 28 provides recommended stress/strain design corridors for cushion materials (see Crash Survival Design Guide).

The following references provide detailed information and test methods for selecting energy absorption materials relative to their protective characteristics against impact forces:

- "Response of Seated Human Cadaver to Acceleration and Jerk With and Without Seat Cushions", Hodgson, V. R., et al, from Human factors, Journal of Human Factors Society, Oct. 1963.
- "Effect of Seat Cushions on Human Response to + Gz Impact", Hearon, B. F., M.D., and Brinkley, J. W., Aviation, Space, and Environmental Medicine, Feb. 1986, Aerospace Medical Association, Washington, DC
- SAE Paper 861887, "Energy Absorption Material Selection Methodology for Head / A-Pillar", Monk, M. W., Sullivan, L.K.,
- SAE Paper 880397, "Multi-Variable Effects of Side Impact Passive Occupant Protection Materials", Saczalski, k. J., Hannon, P. R., Northern Arizona University.
- SAE Paper 920333, "Geometry, Load Spreading, and Polymeric Foam Energy Absorber Design", Stupak, P.R., and Donovan, J.A., University of Massachusetts, presented at International Congress & Exposition, Feb. 1992.
- SAE Paper 920336,"Polyurethane Foam for Automotive Knee Bolsters", McCullough, D.W., et al, International Congress & Exposition, Feb. 1992.

JSSG-2010-7

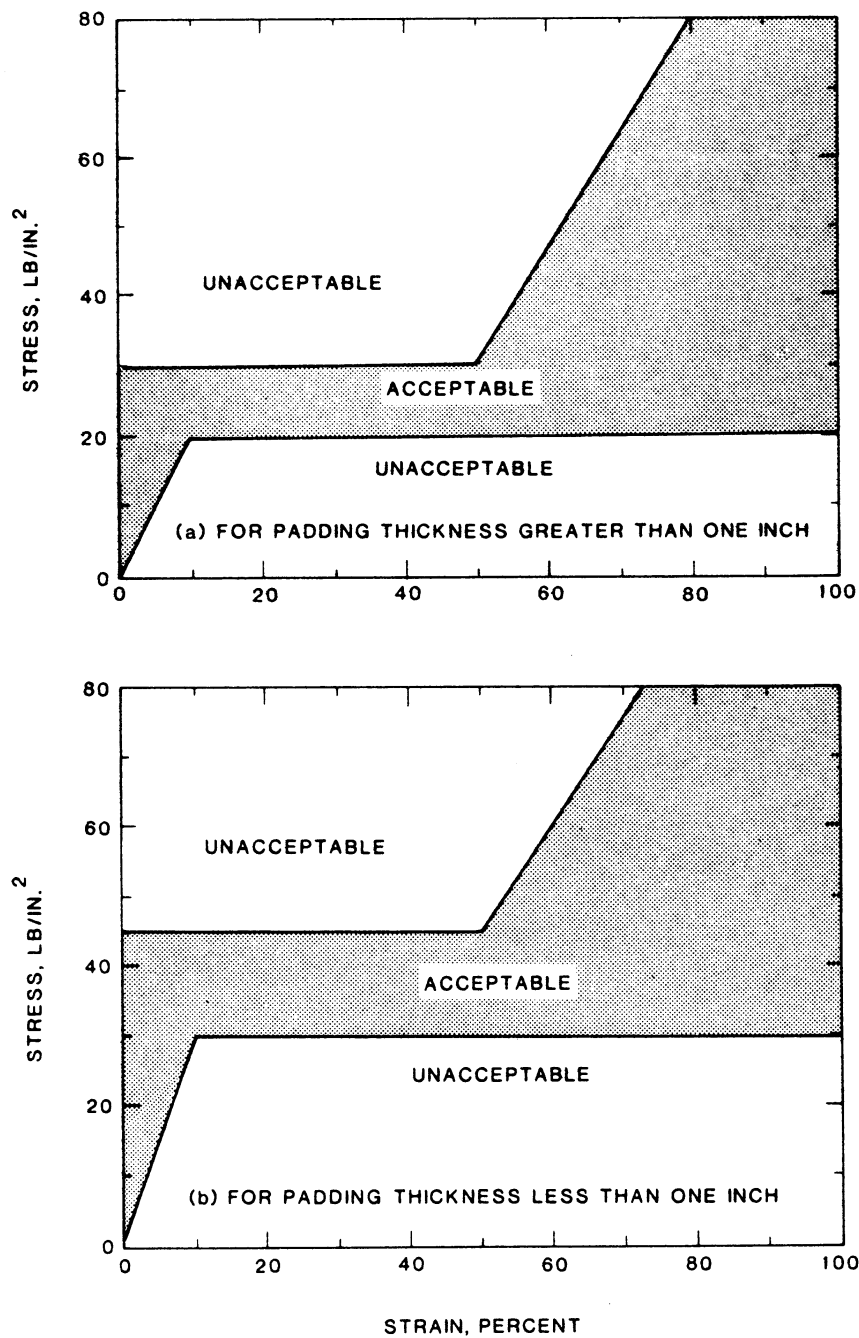


FIGURE 28. Recommended Stress-Strain Corridors for Cushion Materials

JSSG-2010-7

Water Impacts

(Reference: *“An Analysis of the Response of Helicopter Structures to Water Impact”*, by Westland Helicopters Limited)

Other than minimal ditching requirements, the US Navy has no identifiable water impact design criteria and no acceptable water impact methodology with which to address water impact scenarios. Vertical impacts onto water will not receive any benefit from the energy absorption capability of the landing gear, as the water surface will offer little resistance to penetration. In addition, impact forces will be reacted by those areas of the airframe having the largest surface area resulting in possible rupture of the lower fuselage skin panels, and minimal energy absorbing deformation of structure along the primary design load paths. Thus, the type of impact surface can significantly affect the behavior and energy absorption performance of the lower fuselage and can significantly determine the scale of occupant injuries.

For forward speed impacts onto water, e.g. fly-in impacts, response of the aircraft is dependent on the resistance to forward motion through the water. A low drag structure will, for example, generate lower fore-aft deceleration loads than one with a higher resistance. The ability of the aircraft to hydroplane, thereby allowing part of the structure to rise out of the water, will also reduce fore-aft decelerations by reducing the area of the structure in contact with the water. The response of the aircraft is dependent on the integrity of the forward and lower fuselage. Any structural distortion or failure of this structure that results in increased drag, will generate higher fore-aft deceleration loads in the lower fuselage as the aircraft moves through the water. Increased loads in the lower fuselage can lead to greater structural distortion and failure and further increase drag. The result of these rapidly increasing loads can lead to catastrophic destruction of the forward fuselage and break up of the airframe. The response of aircraft structures to impact with water can, therefore, be shown to be highly dependent on structural shape and geometry and the integrity of the lower fuselage panels. These criteria, however, have not received adequate consideration in past crashworthiness designs.

(Reference: *“Airframe Water Impact Analysis Using A Combined MSC/DYTRAN - DRI/KRASH Approach”*, Gil Wittlin, et al, presented at American Helicopter Society 53rd Annual Forum, 1997).

This paper describes a current (~ 1997) Naval Air Systems Command-sponsored project (under the direction of NAWC, PAX River) to investigate water impact crash scenarios. A complementary approach using both a nonlinear finite-element code (MSC/DYTRAN)[™] and a hybrid crash impact code (DRI/KRASH) was used to demonstrate the potential for airframe water impact analysis. Several water impact conditions were analyzed comprising various combinations of forward velocity and sink speed. The following “long-range” program objectives were noted:

- Develop a viable validated methodology with which to evaluate rotary-wing aircraft structural performance in severe but survivable water impacts.
- Establish crash design criteria that will ensure a level of safety consistent with potentially survivable water impact scenarios.
- Consider potential design concepts that will enhance airframe resistance to water impacts.

[™] MSC/DYTRAN is a registered trademark of the MacNeal-Schwendler Corporation, Los Angeles, California.

JSSG-2010-7

The reader is referred to the referenced paper for a detailed discussion of the program. (Complementary reference: “*Naval Rotorcraft Water Impact Crash Simulation Using Program KRASH*”, Witllin, G., Rapaport, M., presented at 49th AHS Annual Forum, May ‘93). Although, the program is ongoing and validation water impact tests of representative structures are planned, the results presented showed good correlation to scale model tests and representative accident data. A sampling of simulation results along with test data are provided with regard to fuselage underside pressure contours, floor accelerations, airframe-water interactive forces, response comparisons and trends. The authors concluded that the hybrid analysis employed allows analytical simulation of the entire crash scenario, beyond initial impact and rapid evaluation of many different parameters such as the effects of landing gear extended or retracted, or the effects of various sea states. It is anticipated that viable water impact design criteria will eventually evolve from this program.

REQUIREMENT LESSONS LEARNED (3.7.3.3)

The three locations where vertical energy absorbing capability may be integrated into aircraft design, are the landing gear, floor structure, and seats. As an example, the U.S. Army Black Hawk and Apache helicopters rely heavily on landing gear and seats to provide the required attenuation of loads for the MIL-STD-1290 vertical design pulse. The gear alone were designed to handle over half the total occupant energy in a crash with the floor and seats absorbing the rest. This system has proven to be very effective since fatalities have been reduced for vertical impacts up to approximately 15.2 m/sec (50 ft/sec) in these helicopters. The main disadvantage of this energy management system is that it is heavily dependent on having an extended landing gear, and that the impact point must provide a reactive surface for the landing gear. Obviously, landing gear provide minimal contribution to the aircraft’s energy management system for impacts into water or soft soil. Since there has been a general trend of increased over water operations for all services and because new rotorcraft will maximize low-observable technology including retractable landing gear, future military helicopters should not place a significant amount of vertical energy management into the landing gear. A greater emphasis should be placed on managing vertical energy through the design of airframe’s sub-floor structure. This should include consideration of water impact.

Brooks analyzed civil and military helicopters involved in ditching and found that fatality rates ranged between 15 and 45 percent. The report (“*Escape and Survival from Helicopter Ditchings*”, Captain Brooks, C. J., *Canadian Defense & Civil Institute of Environmental Medicine for NATO Advisory Group for Aerospace Research & Development*) identifies numerous hazards associated with such water impacts. Brooks found that the most common reason for death in survivable water impacts was injury occurring before escape was initiated. Recommendations relative to enhancing occupant survival during these events included crashworthy seats and four-point seat restraints for all occupants. Drowning was the greatest threat to survival if crewmembers survived the initial impact without disabling injuries. The report further discusses helicopter equipment and operating procedures relative to post crash emergency egress.

4.7.3.3 Acceleration Injury Prevention Verification

The crash protection system shall be incrementally verified throughout its development cycle for compliance with the requirement to control acceleration-induced injury potentials for each

JSSG-2010-7

aircraft occupant during crash impacts of the type and severity defined herein. Verification shall consist of analyses, simulation modeling, and dynamic testing (using anthropomorphic test devices, ATDs) to assure that the system provides adequate means to control acceleration-induced injuries within the injury tolerance levels specified in 3.7.2. The following incremental verifications shall be accomplished prior to the specified review:

a. System Requirements Review (SRR) - Verify that contractor documentation [i.e., specifications, systems engineering master schedule (SEMS), contract work breakdown structure (WBS), and contract SOW] include the necessary analyses, trade studies, computer simulations, and tests to demonstrate the crash protection system's capability to meet the acceleration injury prevention requirements of 3.7.3.3.

b. System Functional Requirements Review (SFR) - Review the contractor's specifications, crash simulation analyses, and design trade studies to verify that a systems approach was used to develop an energy management system to control acceleration-induced injury. Verify that the crash protection system's functional design addresses energy management contributions from the airframe structure, landing gear and seating systems, respectively.

c. Preliminary Design Review (PDR) - Verify that the contractor's preliminary design (consisting of specifications, preliminary engineering drawings, trade studies of alternate design approaches and developmental testing of subsystems and components) complies with the requirements of 3.7.3.3 to control acceleration-induced injury within the injury tolerance levels specified in 3.7.2. The system's energy management design shall be verified by appropriate computer modeling techniques to assess its transient response to the impact parameters of the specified crash profile.

d. Critical Design Review (CDR) - Review contractor's final design documentation (i.e., specifications, final design engineering drawings, component, subsystem and system test plans, and qualification test results) to verify that the crash protection system and its interfaces comply with the requirement to control acceleration-induced injuries to the levels specified in 3.7.2. Dynamic crash loads testing shall be employed to verify the crash protection system's compliance to the requirements of paragraphs 3.7.3.3 and 3.7.1.

e. System Verification Review (SVR) - Review contractor's production configuration documentation (i.e., product specifications, production drawings, and qualification test reports) to verify compliance of the crash protection system and its interfaces to the requirements of 3.7.3.3.

VERIFICATION RATIONALE (4.7.3.3)

Occupant protection from acceleration-induced injuries in a crash impact scenario must be verified by analyses and tests that are capable of simulating the "impulsive" characteristics of the crash loads associated with aircraft mishaps. Typically, the major impact pulse is represented by an acceleration-time curve with a time base in the range of 50 to 200 milliseconds in duration. Although the crash protection system's verification requires significant static loads testing to properly evaluate its structural capacity, the ultimate assessment of its performance must be based on dynamic analyses and crash loads tests. In the past, the tendency in crash resistant seat testing was to conduct two or three dynamic tests at the cited impact conditions and assess the system's performance based on these limited data. In contrast, ejection seat test programs incorporate a comprehensive set of tests at various test

JSSG-2010-7

conditions with appropriate replications to evaluate escape systems. Occupant crash protection systems should be assessed on an equivalent basis.

VERIFICATION GUIDANCE (4.7.3.3)

The verification process may use computer models such as SOM-LA, SOM-TA, KRASH, etc, extensively to validate the occupant protection system. A fundamental issue, however, is approving the proper balance between a validated simulation program and actual testing of hardware to support a verification decision. Test plans in support of the verification process should consider the operational environment to which the occupant protection system will be exposed and the associated systems requiring integration. This handbook and the appropriate references provide dynamic test guidance in the areas of test impact parameters, injury criteria, instrumentation requirements (i.e., SAE J-211), dynamic test procedures, anthropomorphic test dummies (ATDs), data analysis and the statistical significance of test results.

VERIFICATION LESSONS LEARNED (4.7.3.3)

Several examples can be cited to emphasize the importance of verifying the occupant protection system with realistic and operationally based test procedures. Identification of the MA-6 inertia reel's design deficiency is an excellent case study. The original version of the MIL-R-8236 inertia reel specification did not require system tests of the reel under typical dynamic crash loads. For many years, this inertia reel configuration was flown as part of a total retention system, but never dynamically tested with the restraint/seat system to assess its system performance. Test procedures for new crash resistant seat/restraint systems incorporated the government furnished equipment (GFE) reel into the test configuration with the stipulation that it was to be tested in the "manually locked" mode. This requirement evolved because the reel was on the qualified product list (QPL) and independently tested. Although several isolated failures of the MA-6 inertia reel were documented during dynamic testing where the reel was set to the automatic mode, the first record of consistent dynamic failures of this reel was in conjunction with IBAHRS crash testing. IBAHRS was the first test program to require that the MA-6 inertia reel be set to the automatic lock mode during crash testing. The failures were random during the initial series of IBAHRS development tests, but were later identified as consistent with a 50 percent failure rate when a comprehensive test series was conducted. The dynamic failures experienced during these tests were somewhat insidious since often reels would function properly post-test, only to be identified during analysis of high speed photography. The concern was that this condition could also exist in the field. The revised MIL-R-8236 now requires full system tests and extensive dynamic component testing to evaluate reliability.

3.7.3.3.1 Impact Energy Management

The crash protection system shall incorporate crash energy management techniques to reduce accelerations and limit loads sustained by air vehicle occupants during crash impacts of the

JSSG-2010-7

severity specified in 3.7.1. The energy management system shall be integrated into the air vehicle structure and its subsystems to function as a total system with allocated energy absorption percentages assigned to the structure, landing gear and seating systems, respectively.

Performance requirements for the airframe structure and landing gear affecting the crash protection shall be in accordance with the Airframe Specification Guide and the Vehicle Subsystems Specification Guide.

REQUIREMENT RATIONALE (3.7.3.3.1)

This requirement was first cited within MIL-STD-1290. However, the basic concept of an energy management system is derived from a systems design approach, which logically allocates specific portions of the energy absorption process to the various subsystems. Recent experience has shown that this requirement requires vigilance by program managers throughout the system's development cycle to assure its implementation.

REQUIREMENT GUIDANCE (3.7.3.3.1)

Implementing the energy management system requirement begins with a comprehensive analysis and trade study to quantify the performance, weight penalties, and cost factors for the various options under consideration. An excellent example of a crashworthiness trade study to determine the optimum design configuration is given by Cronkhite and Tanner in "Tilt Rotor Crashworthiness", and presented at the 41st Annual Forum of the American Helicopter Society, Fort Worth, TX, May 15-17, 1985. A systems approach to crashworthiness was used by the authors in the V-22 design to assure a high level of occupant crash protection for minimum weight. An estimated 90th percentile level (i.e., 36.5 ft/sec vertical velocity change) of crash protection was found to be most cost-effective for the advanced development model V-22 with a total crashworthiness weight impact of 1.4 percent DGW compared to 6 percent DGW for a MIL-STD-1290, 95th percentile (i.e., 42 ft/sec vertical velocity change) design. Figure 29 provides a flow diagram of the trade study approach taken.

JSSG-2010-7

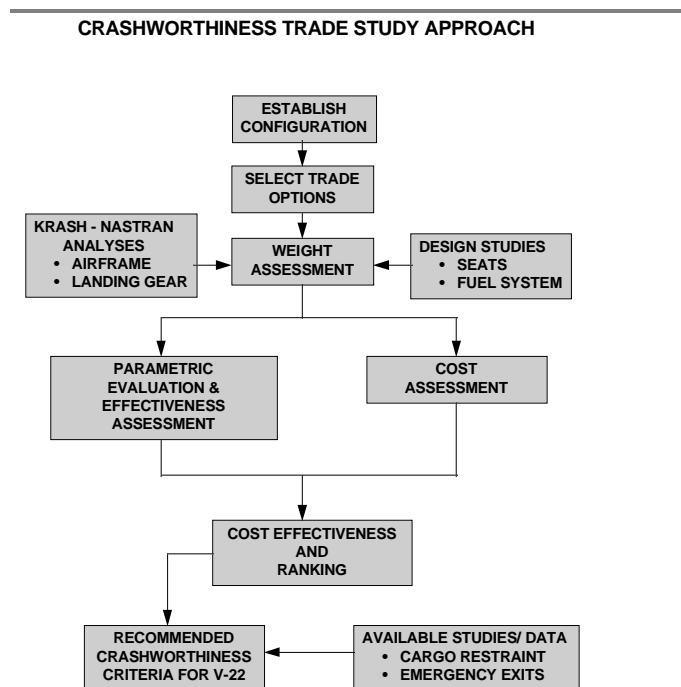


FIGURE 29. V-22 Crashworthiness Trade Study Approach

JSSG-2010-7

Table XIV identifies the trade options assessed during the study.

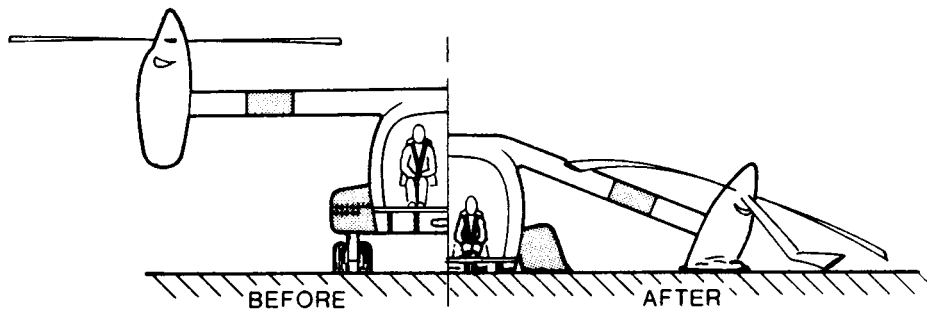
TABLE XIV. V-22 Crashworthiness Trade Options

Trade Subsystem	Description
Airframe -	12 ft/sec (Non-CW)
Vertical Impact	30 ft/sec
	36.5 ft/sec
	42 ft/sec
	36.5 ft/sec with roll/pitch (MIL-STD-1290)
Landing Gear -	12 ft/sec (Non- CW)
Vertical Impact	16 ft/sec
(No fuselage contact)	20 ft/sec
	30 ft/sec
	20 ft/sec with roll/pitch (MIL-STD-1290)
Crew Seats	Non -CW
	Military CW
Troop Seats	Non - CW
	Lightweight CW
	Military CW
Longitudinal	Inherent
	15/40 ft/sec , (3.4 / 9.2 G, protect crew/troops)

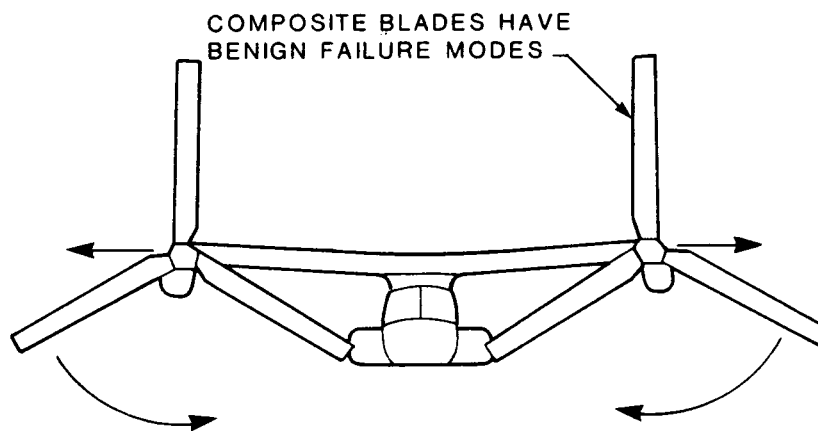
REQUIREMENT LESSONS LEARNED (3.7.3.3.1)

The V-22 Tilt Rotor aircraft provides a unique example of impact energy management utilizing “mass shedding”. By allowing the wings to fail in a controlled manner (i.e., the frames are 15 percent stronger than wing), weight savings can be achieved. The V-22 design reduces the aircraft mass 40 percent by shedding the wings and pylons, thereby, reducing the crash loads and requiring less material in the fuselage structure to absorb the reduced aircraft kinetic energy. To maintain a habitable occupant compartment area, the fuselage is designed stronger than the wings and the wings are stronger than the pylon. In addition, prop-rotor direction of rotation is directed away from occupied areas in the event of rotor ground strikes. Figure 30 provides a schematic diagram of the V-22’s energy management system.

JSSG-2010-7



CONTROLLED WING FAILURE ALLOWS MASS RELIEF.
PREVENTS FUSELAGE COLLAPSE.



DIRECTION OF ROTATION CAUSES PYLONS/ROTORS
TO BE DRIVEN AWAY FROM FUSELAGE SHOULD
BLADE STRIKE OCCUR.

FIGURE 30. Schematic of V-22 Energy Management System

4.7.3.3.1 Impact Energy Management Verification

Verification of the energy management system's performance associated with occupant crash protection requirements shall be conducted by analyses, dynamic crash modeling and simulation of the total system, subsystem static and dynamic tests of components and subsystems, and a full-scale drop test of a representative airframe. Specific performance verification of the airframe and landing gear contributions shall be conducted in accordance with the requirements of the Airframe and Subsystems Specification Guides.

JSSG-2010-7

Prior to the preliminary design review (PDR), verification of the proposed energy management system shall be accomplished by review of structural analyses, preliminary engineering drawings of all subsystems, and an assessment of the dynamic crash simulation results.

Prior to the system verification review (SVR), verification of the final design configuration shall be accomplished by review of the production documentation. All qualification test reports and test data of dynamic and static crash loads testing conducted on components, subsystems and the total system shall be verified to comply with the occupant crash protection requirements of this Specification Guide.

VERIFICATION RATIONALE (4.7.3.3.1)

Verification that an energy management design concept has been considered in the crash protection system's design can be accomplished by the paper studies and analyses identified above. However, the final determination of the energy management system's capability to prevent acceleration-induced injuries must be accomplished through dynamic crash testing as required herein.

VERIFICATION GUIDANCE (4.7.3.3.1)

ADS-11 (*Reference: ADS-11B, "Aeronautical Design Standard: Survivability Program, Rotary Wing", Directorate For Engineering, U.S. Army Aviation Systems Command, May 1987*) provides a quantitative methodology to evaluate the level of crashworthiness attained in a given aircraft design. Table XV below shows the enhanced level of crashworthiness capability incorporated within the Army's Black Hawk (UH-60A) as compared to the H-1 airframe, which was a pre- MIL-STD-1290 design .

TABLE XV. Rotorcraft Crashworthiness Comparison

Factor	Max. Score ADS-11A	UH-1H Score	H-60A Score	Weight Penalty (lbs)
• Crew Retention System	125	50 (40%)	125 (100%)	64 *
• Troop Retention System	125	40 (32%)	102 (82%)	72 **
• Postcrash Fire Potential	255	200 (78%)	226 (89%)	9
• Basic Airframe Crashworthiness	100	37 (37%)	81 (81%)	
• Landing Gear	25	10 (40%)	25 (100%)	620
• Evacuation	60	45 (75%)	40 (67%)	-
• Injurious Environment	30	17 (57%)	22 (73%)	-
TOTAL:	720	399 (55%)	621 (86%)	765

* 2 Seats

** 12 Seats

JSSG-2010-7

VERIFICATION LESSONS LEARNED (4.7.3.3.1)

A good example to demonstrate the importance of verifying the energy management system's capability throughout the development cycle can be found in the V-22's crash protection system's design. The V-22 trade study conducted during the preliminary design phase recommended a 90th-percentile vertical velocity impact severity level (i.e., 36.5 fps, based on rigid surface impact). This was to be achieved by the combined design of an energy absorbing (EA) landing gear system with 20 fps EA capability and an energy absorbing under-floor structure capable of reacting a 30 fps crash pulse,

i.e., Total Aircraft EA Capability = $[\text{LG } (20 \text{ fps}^2) + \text{Floor } (30 \text{ fps}^2)]^{1/2} = 36 \text{ fps}$.

The sub-floor design consisted of Kevlar honeycomb, capable of delivering a 10 inch controlled crush. However, during the full-scale development phase, it was determined that the Kevlar honeycomb EA design was not feasible in the V-22 configuration floor structure. Graphite laminate was substituted, but was not considered a "crushable" design since its EA capability was unknown. Therefore, the EA capability of the landing gear was increased to 24 fps (approximately a 44 percent increase over the preliminary design value) to account for some of the lost capability. Both the crew and troop seats retained their vertical energy absorbing capability. However, since the EA capability of the graphite laminate floor structure was unknown, the total energy absorption capability of the V-22 crash protection system could not be quantified. In addition, it was not possible to estimate soft soil impact capability because the crash impact computer model codes available at that time, such as KRASH 85 were not capable of assessing soft soil or water impact scenarios.

3.7.3.4 Post-Crash Injury Protection

The crash protection system shall prevent post-crash environmental hazards that could seriously injure occupants, or it shall protect aircraft occupants from exposure to those hazards which cannot be prevented. Potential post-crash environmental hazards include, but are not limited to fire, toxic fumes, and submersion.

Detailed performance requirements for crash resistant fuel systems and aircraft floatation systems are found in the Vehicle Subsystems Specification Guide.

Detailed performance requirements for personal protection systems such as flame/heat resistant garments and breathing air devices for aircraft occupants are found elsewhere in the Crew Systems Specification Guide.

REQUIREMENT RATIONALE (3.7.3.4)

The casualty rate in survivable crashes involving fire or rapid submersion is significantly greater than in those mishaps where fire or submersion does not occur. Numerous aircraft accident victims survive the initial impact, only to succumb to post crash fire or drowning.

JSSG-2010-7

REQUIREMENT GUIDANCE (3.7.3.4)

Volume V (USAAVSCOM, TR 89-D-22E) of the Aircraft Crash Survival Design Guide provides appropriate design and performance requirements for crash resistant fuel systems, interior materials that are flame resistant and reduce toxic fumes, and ditching provisions.

Burn Injury Prevention

Regulations and criteria for prevention of the post-crash fire hazards are well established. Requirements are contained in MIL-F-87168, AFSC DH 1-6, AFSC DH 2-1, and MIL-HDBK-221.

The system should prevent or minimize burn injuries to occupants that result from flame, heat and radiation throughout the entire crash sequence, including the necessary time period for emergency egress specified in 3.7.3.5. Burn injury prevention shall be accomplished by containment of flammable fluids, ignition prevention, flame suppression, heat/flame shielding, or any combination of the three. The requirements shall apply as long as necessary for all occupants to safely escape the burn injury hazard.

The approach for preventing burn injuries may be to either eliminate or control the hazard at the source and to provide for more rapid egress. Designs for reducing the potential for fire and explosion should be, at minimum, applied to aircraft fuels and other flammable fluids' design and location, electrical system design and location, material selection, high temperature systems/equipment location, component failure modes and effects. Requirements and criteria for the prevention of post-crash fire are well established. Many of these can be found in *MIL-STD-1290, MIL-STD-1807, MIL-T-27422, MIL-F-87168, AFSC DH 1-6, AFSC DH 2-1, MIL-HDBK-221, Aircraft Crash Survival Design Guide USAAVSCOM TR 89 -D-22 and FAR Parts 25, 27, and 29.*

The air vehicle subsystems and equipment should control, to the fullest extent practicable, the potential for the hazards of fire, explosion, and smoke to personnel on board the crashed air vehicle. Issues for consideration are described in the following paragraphs:

a. **Fluid Systems.** Fire hazard reduction provisions and capabilities should be provided to the fuel, oil, hydraulic, and any other flammable fluid systems by considering fluid containment, flammable fluid component, and alteration of the fuel.

(ref: MIL-HDBK-221)

The highly volatile nature of fuel causes rapid burning, making control of the fire difficult and casualties likely. Prevention of fuel burning can be accomplished by several methods, such as fuel containment and alteration of fuel characteristics. The last method, still in the research stage, involves changing the characteristics of the fuel to modify its dispersion properties and consequently reducing its susceptibility to ignition and sustained burning during the initial impact/deceleration phase. The following paragraphs contain some safety guidelines to be

JSSG-2010-7

employed to give an aircraft inherent resistance to postcrash fire hazards caused by fuels and other flammable fluids.

Flammable fluid containment: Containment of aircraft engine fuel is the most significant means of minimizing or preventing fire fatalities to occupants who have survived a moderate to severe crash. Fuel containment designs that will result in crash hazards to the aircraft occupants or permit fuel tanks to be easily damaged must be avoided. Consideration should be given to tank location, shape, materials, fittings, and attachments. Spillage of fuel through the vents during a rollover mishap or at any adverse attitude condition should be prevented. Apply the designs noted in the guidance for separation in *MIL-F-87168*, such as not locating permanent fuel tanks in personnel or cargo compartments. Consider the fuel containment design criteria contained in *U.S. Army Crash Survival Design Guide, Vol V*, and the documents listed therein. Other recommended documents are *FAA ADS-24* and *SAE ARP 496*.

Good initial fuel containment design features can complement the primary strength of the structure and eliminate the need for modifications which add needless weight and cost.

Flammable fluid components and lines: Locate components and accessories containing flammable fluids where they will not contact the ground in a crash environment. Ensure flammable fluid lines are protected by structure upon impact. Avoid locating fuel or hydraulic lines in the wing leading edge section and utilize flexible lines with ample slack in areas where crash deformation is likely. Use breakaway, self-sealing couplings or impact operated shutoff valves in high hazard areas which justify their complexity. Shutoff valves are required in the tank-to-engine lines and consideration must be given to their location and operation. Containment is lost if the shutoff valves are carried away with detached pod, pylon, or fuel line. Ideally, locate the valves inside the tank at the outlets. Maintainability considerations may preclude this location and a location immediately outside the tank may be required. Shutoff valve operation from the cockpit is usually manual. However, unanticipated emergencies require that more consideration be given to adequate automatic valve operation.

Fuel alteration: Studies are now being made regarding the feasibility of using anti-mist additives to alter the dynamic dispersion of low volatility fuel in a manner which negates the mist fire/explosion hazards associated with the fuel. The additives generally consist of high molecular weight polymers which dramatically affect the number and relative size of fuel droplets formed under dynamic crash or gunfire impact conditions. The combination of a low volatility fuel with this additive provides an excellent approach for minimizing both the fuel vapor and mist fire and explosion threats. Fuel alteration compatibility studies and experimental efforts are presented in the literature. *Some of the relative reports are AGARD CP-84-17, Army Contract DAA 005-73-C-0249 Report 9130-73-112, FAA-ADS-62, and USAAVLABS-TR-65-18.*

Integrated system: Combine the above elements into an integrated system that provides for prevention of the dispersion of flammables at the moment of crash. The utilization of phenomena peculiar to the crash environment (excessive displacement, structural break, etc.) to activate automatic fuel containment measures should be considered.

b. **Interior Materials.** Interior materials used in the aircraft should be fire resistant or retardant and have properties that result in low smoke generation and low toxic gas emission. An excellent source of guidance in choosing acceptable military aircraft interior materials is *AFSC DH 1-7, Aerospace Materials*. This design handbook should be consulted before choosing the interior materials to be used. The bulk of information presented in this section, however, comes from the FAA commercial aircraft industry, especially *Federal Aviation Regulation Part 25.853, including amendments 25-59 and 25-61*. This information should be

JSSG-2010-7

considered in conjunction with AFSC DH 1-7. Another possible source of information is the *U.S. Army Crash Survival Design Guide, Vol. V, Aircraft Postcrash Survival*.

Examples of the interior components which should be considered include aircraft panels, privacy curtains, foams in seat pads and cushions, personnel and cargo retention belts and straps, fabrics (coated and uncoated), flooring, cargo liners, transparencies, insulation, and any other components of the aircraft interior. Properties of the material which may be measured to assess its flammability include ease of ignition, flame spread rate, total and maximum peak heat release rates, and flash-fire/flashover potential. The limiting of maximum peak heat release safeguards against the use of materials which have relatively low levels of total heat release but which, nevertheless, emit a large amount of heat over a short duration. The use of such materials could allow fire to spread rapidly through a cabin.

According to FAA Amendment 25-61, the primary purpose of the FAA flammability standards is to ensure that interior materials with large outer surface areas will not become involved rapidly and contribute to a fire when exposed to flames. The internal structure of galleys and storage bins were exempted from the proposed standards because such structures would not be exposed to an external flame until well after flashover occurs—when further egress is unlikely. Transparent or translucent components, such as lenses used in interior lights and illuminated signs, and window anti-scratch panels, are exempt because of the lack of materials which will meet the flammability standards and still have the light transmissibility characteristics which are vital in emergency situations. Because of their relatively small volume and surface area, small parts (e.g., door and window molding, seat trays, arm rests, etc.), are also exempt from the new flammability standards. For the same reason, small detail parts of the passenger service units are exempt.

Since many aircraft interiors consist primarily of a variety of polymeric materials, the performance of these materials in the fire scenario can determine occupant escape time. In a 1980 study of post-crash fires in general aviation accidents during 1974-1978, the NTSB found that 77.4 percent of the 1038 fatalities involving post-crash fire should have been survivable had there been no post-crash fire. As an example of the effort to reduce post-crash fire hazards, FAA rule making now requires the use of seat fire-blocking layers, which have been quantitatively tied to the time to flashover. Seat fire-blocking layers delay flashover by slowing down the heat release rate of burning seat materials and decreasing ease of ignition, thereby increasing the available escape time, perhaps by as much as 50 percent. However, this may only be a solution for one component of the aircraft interior. The use of fire retardant coatings may be a solution for other components. Unfortunately, while these may indeed slow the spread of post-crash fire, they may generate unacceptable levels of smoke causing more rapid light obscuration or emit unacceptable levels of toxic gases. In oxygen-enriched environments, fire retardants may have little or no effect. Also, some materials that would be expected to protect occupants from fires outside the aircraft actually increase the danger. For example, insulation of the aircraft skin actually speeds burn-through, since the insulation does not allow heat to dissipate. Trade-off studies should be performed to determine which materials meet the flammability requirement, while also meeting requirements for smoke and toxic gas generation, as well as any requirements for comfort and durability.

c. **Oxygen systems.** The functional and installation requirements for aircraft oxygen systems should effectively limit fire and explosion hazards associated with survivable crashes.

JSSG-2010-7

d. **Ignition Sources.** Reduction of ignition sources (to include hot surfaces, friction sparks, and electrical ignition sources) should be accomplished to the fullest extent practicable.

The system shall minimize or eliminate ignition sources and flammable materials; or it shall isolate flammable materials from all potential ignition sources. Time to ignition of any materials shall exceed _____ when exposed to the following conditions _____.

Controlling the occurrence of ignition sources is important to reducing the chances for fire, explosion, and smoke, thereby preventing burn, eye and respiratory injuries. Reduction of ignition sources (to include hot surfaces, friction sparks, and electrical ignition sources) should be accomplished to the fullest extent practicable. Fire hazard reduction provisions and capabilities should be provided to the fuel, oil, hydraulic, and any other flammable fluid systems by considering fluid containment, flammable fluid component, and alteration of the fuel. Interior materials used in the aircraft should be fire resistant or retardant and have properties which result in low smoke generation and low toxic gas emission.

Generally, the ignition sources which must be considered during a crash episode are varied and include hot surfaces, friction sparks struck from metal impact, sparks from electrical sources (broken electrical components and circuits), and flames. Protective measures may be provided by active systems and passive designs for ignition source suppression. The following paragraphs contain some safety guidelines to be employed to give an aircraft inherent resistance to post-crash fire hazards.

Hot Surfaces: Locate landing lights where they will not be exposed to direct crash impact. The incandescent filament in a landing light is hot enough to provide fuel ignition for a period of 0.75 to 1.50 seconds after the bulb has been broken. Since crash tests using simulated fuels have shown massive fuel spillage in progress as early as 0.20 seconds after impact, it is readily apparent that this ignition source deserves careful attention for a crashworthy design.

Friction sparks: Use metals which have low friction sparking tendencies where ground contact can occur during a crash landing. Hot surface hazards and primary sparking will develop as a result of friction between contacting surfaces during a crash. If the abrading metal produces sparks of high enough thermal energy, ignition is possible. The thermal energy of the spark is a function of bearing pressure, slide speed of the metal, hardness of the metal, and the temperature at which the metal particles will burn.

See Table VI of USAAVSCOM TR 89-D-22E provides minimum conditions under which certain abrading metals will ignite combustible mist. A reduction of the friction spark ignition hazard can best be achieved by selecting materials of the lowest possible sparking characteristics, particularly for those areas of predictable crash damage (*see NACA TN 4024 and NACA TN 2996*).

Electrical ignition sources: Since the vehicle electrical system extends to virtually every part of the vehicle and the minimum electrical energy required for ignition is so small (about 0.15 millijoule under ideal conditions), it constitutes an excellent ignition source. Therefore, there must be a method for quickly de-energizing electrical ignition sources, such as batteries, generators, and inverters. Provide for either a pilot or a crash activated system with adequate precautions included to prevent inadvertent operation. Ensure that the activation time does not exceed 0.20 second. All nonessential busses should be de-energized and only the emergency DC circuits needed to operate minimum lighting, communication, and crash fire prevention systems remain energized. Route and protect electrical power lines required for emergency systems to minimize the possibility of crash damage and ignition of any combustible material.

JSSG-2010-7

In addition, locate the elements listed below outside of the areas of anticipated impact and away from flammable fluid sources:

- Batteries, generators, and other electrical components should be mounted to the aircraft with structural attachments capable of withstanding the static ultimate load factors specified in 3.7.3.2.3 (Cargo and Ancillary Equipment Retention).
- Wire bundles should be installed in accordance with the following design considerations:
 - Route along heavier structural members of the airframe wherever possible.
 - Support at frequent intervals along their length by frangible attachments where appropriate to the aircraft structure.
 - Route above or away from flammable fluid lines and do not closely space between outer skin and fuel lines.
 - Wire bundles routed near flammable fluid tanks should be shrouded to prevent arcing.
 - Wires should exit components on their least vulnerable side. Wire lengths should be sized to accommodate structural deformations.

Integrated system: Combine the above elements into an integrated system that provides for rapid inerting of ignition sources (engine and electrical). Design electrical circuitry so that a single operation deactivates all circuits which are not necessary for crash fire emergency operation. Circuits can be designed to include any level of automatic and manual inter-relationship. Every redundancy adds complexity and only an engineering analysis of a given situation can provide a basis for final selection of a circuit.

e. **Fire Extinguishing.** A fire extinguishing system should be provided for protection of the personnel on board the aircraft. The system should remain operable both during and after a survivable crash. Flame detection and suppression should be provided if ignition occurs. Preventing the occurrence of a fire (ignition prevention) is the first line of defense in preventing burn injuries. Faced with the realization that this may not always be possible, a method for suppressing flames will be necessary to avoid a hazardous fire situation from escalating. Flame suppression can also extend the time personnel have to escape the aircraft or to be rescued.

This requirement establishes the basis for providing a fire detection and suppression system to protect personnel during crash and post crash conditions, and establishes the requirements for the system. The basis for providing a system may evolve from the aircraft design, mission or crew requirements. Fire suppression systems for habitable compartments are described in MIL-F-87168. Additional guidance and requirements can be found in MIL-HDBK-221 and FAA Airworthiness Standards Parts 25, 27 and 29. Additional guidance may be found in the following documents:

MIL-F-7872 Fire and Overheat Warning System, Continuous, Aircraft: Test and Installation of

MIL-C-22284 Container, Aircraft Fire Extinguishing System, Bromotrifluoromethane

MIL-E-52031 Extinguishing, Fire, Vaporizing-Liquid

MIL-F-23447 Fire Warning Systems, Aircraft, Radiation Sensing Type; Test and Installation of

JSSG-2010-7

MIL-C-22285 Extinguishing System, Fire, Aircraft, High Rate Discharge Type, Installation and Test of

In light of the atmospheric ozone problem, and the controls being imposed on chlorofluorocarbons, continued use of Halons may be not be possible.

f. **Explosion Suppression.** An explosion suppression system should be provided to prevent the involvement of intact fuel systems in any fire occurring during crash or post-crash conditions.

g. **Heat/Flame Shielding (isolation).** The system shall provide protection from heat and flames by either isolating occupants from the hazard or providing personal protective equipment sufficient to minimize the hazard. This requirement is needed to provide occupants with protection from heat and flames in situations where the occurrence of a fire is possible and fire suppression methods would not be effective or possible in providing the necessary protection.

As part of the aircraft design process designers should identify primary fire zones or a compartment adjacent to a fire zone that does not have sufficient separation to minimize flame propagation. A fire zone is defined to be a compartment which contains flammable fluid components with potential leakage and ignition sources. These areas include the placement of engines, fuel system components and storage of flammable fluids for example. Design guidance for this process can be found in *MIL-HDBK-221* and *MIL-STD-1290*. This handbook and military specification establishes a fire protection performance baseline that describes specific systems, their design parameters and installation requirements.

Smoke and Toxic Gas

The system shall eliminate or minimize injuries due to smoke and toxic gas hazards produced during the crash. Complete burning of any organic material yields gaseous combustion products such as carbon monoxide, carbon dioxide, and water. However, complete burning seldom occurs in an actual fire, and fragments of charred material are swept along in the expanding combustion gases. These solid particles, which make breathing difficult and obscure vision, are what is commonly called smoke. Since large quantities of smoke make evacuation of a burning aircraft extremely difficult, select aircraft materials which produce the least amount of smoke possible as well as possess self-extinguishing properties. Extensive burn tests have been conducted on aircraft materials to determine their smoke production. In general, the smoke factor increases with increasing thickness and weight of the material as well as with increasing flammability. Sheets, films, and laminates have a much higher smoke density than fabrics, and vinyl coated fabrics show smoke factors twice those of uncoated fabrics. Materials containing vinyls or other plastics produce greater quantities of smoke than do cellulose-derived materials of the same flammability range. Among the synthetic cellular polymers, rubbers and polyvinyl chloride exhibit the highest smoke density while phenolic and polyethylene polymers are lowest.

Avoid the use of materials that give off toxic gases other than carbon monoxide. Although the common products of carbon monoxide and carbon dioxide cannot be avoided when burning an organic material, several other gases may also be generated, depending on the material being burned. These gases, although not produced in the same quantities as carbon monoxide, are a definite threat to the escaping occupant because of their high toxicity to human beings.

JSSG-2010-7

The interior materials should be evaluated for smoke generation. Smoke generation is commonly measured in terms of optical density that depends on the thickness and density of the material involved, and optical density will depend on the volume of the cabin and the light path length.

The interior components should be evaluated for toxic gas emission. Some toxic gases which should be considered include carbon monoxide (CO), hydrogen cyanide (HCN), hydrogen chloride (HCL), carbon dioxide (CO₂), sulphur dioxide (SO₂), and nitrogen dioxide (NO₂), as well as any other potentially toxic gases which may form. When measuring toxic gas levels and their generation rates, both the individual gases as well as the combined gases should be evaluated for physiological effects. The amount of any particular gas produced and the generation rate strongly depend on the temperature and oxygen concentration in the post-crash environment, as well as the amount of material consumed and the air ventilation rate. Standards for toxicity may be especially difficult to establish because levels of human tolerance to typical post-crash fire toxicants have not been adequately defined.

The generation of smoke by smoldering or flaming interior materials presents both physical and physiological hazards by reducing visibility and irritating the eyes, nose, throat, and lungs. Severe smoke inhalation will deprive the body of oxygen and eventually leading to death. Also, smoke may hinder rapid escape from the aircraft.

Electrical Shock

The system shall prevent or minimize injuries due to electrical shock in all crash environments specified herein.

Chemical Hazards

The system shall eliminate or minimize sources of injuries due to chemical hazards produced during the crash.

Drowning

The U.S. Navy's mission involving over-water operations results in a significant percentage of water impacts and drownings. One survey of the Navy crash environment ("Evaluation of the Crash Environment and Injury-Causing Hazards in U.S. Navy Helicopters", Coltman, J. W., et al, published in SAFE JOURNAL, Spring Quarter, 1986) reported that 26.4 percent of survivable Navy helicopter crashes occurred into water.

The most effective countermeasure against drowning is to prevent occupied areas of the aircraft from being submerged during the period of time that emergency egress must be performed. To achieve this goal, aircraft can either be designed with inherent water buoyancy and stability which remain after impact, or be equipped with supplemental floatation systems which can be deployed after a water impact. In helicopter applications, supplemental floatation systems are often utilized because, without such devices, helicopters will invert and sink rapidly due to their high center of gravity and poor stability in roll due to the lack of wings. The U.S. Navy has developed floatation systems that are utilized on some of their helicopter types. The FAA requires floatation systems on civil helicopters used for over water operations. Requirements for civil floatation systems can be found in the Federal Aviation Regulations. In the V-22 tilt rotor, inherent water buoyancy was designed into the aircraft, and the wings provide stability against roll over in water.

JSSG-2010-7

As a secondary level of protection, supplemental breathing air provides a significant increase in the probability of successful emergency egress when submersion of the cockpit and cabin is considered inevitable. Supplemental breathing air devices are used by aircrew and trained passengers aboard U.S. Navy and Marine Helicopters when flying over water, and have been found to be highly effective at reducing drownings. The success of supplemental breathing devices has also been demonstrated in civil helicopter applications such as in flights to and from off-shore oil rigs. However, the limitation of this protective approach is that occupants must be conscious and relatively uninjured after impact to effectively use the devices. If the aircraft can remain afloat and upright for even a few minutes the probability of successful escape is greatly increased.

The U.S. Navy's underwater egress training has also proven to be highly effective at reducing drownings associated with emergency egress underwater. Through the combined use of an underwater egress training device and class room curriculum, occupants of Naval aircraft are prepared to overcome obstacles and maximize their chances for survival.

Additional guidance on the subject of drowning prevention is provided in the guidance section under 3.7.3.5 "Emergency Egress System," and its three sub-tier paragraphs.

REQUIREMENT LESSONS LEARNED (3.7.3.4)

The rapid obstruction of vision by smoke has been reported by many survivors of aircraft post-crash fires. For example, a commercial airline aircraft carrying 78 passengers and 7 crew-members crashed on landing. From an account by a survivor as given to the NTSB investigators: "There was thick, black smoke churning all around me, causing me to choke and fight for each breath of air. I couldn't see a thing even if it was inches in front of me". The Smoke Research Station in Great Britain conducted tests in which they ignited 88 pounds of plastic foam. Visibility fell to about 3 feet within 2 minutes and within the next few seconds, the visibility was completely obscured. Loss of visual reference in such a short amount of time not only slows escape, but may compound the problem by inducing panic in many aircraft occupants. Therefore, the reduction of smoke generation by aircraft interior materials may have a major impact on survival in a post-crash scenario.

The toxic gases predominantly generated by aircraft interior materials include CO, HCN, HCL, CO₂, SO₂, and NO₂. In a 1977 report on inhalation toxicology, a determination of the relative toxic hazards of 75 aircraft materials was made (Crane, Sanders, and Endecott, Mar 77). The material exhibiting the greatest toxic hazard of those examined was modacrylic, which is used in drapery fabric. The second most hazardous material was Federal Regulation Wool, which is used in upholstery material. However, note that according to AFSC DH 1-7, DN 2D1, wool is prohibited from use in military aircraft interiors. On the other hand, four different materials were equally ranked as least hazardous. These are (1) PVF/Fiberglas-Epoxy/PVF used as a cargo liner, (2) Silicone-treated Phenolic-Fiberglas used as fuselage insulation, (3) Polymethyl Methacrylate used in window panes, and (4) Fiberglas-Epoxy/Asbestos also used as a cargo liner. However, caution must be used in applying this data to the materials being evaluated. Since the majority of materials give off more than one gas, and since many interior components are actually combinations of materials, the relative toxicity of any component must be determined in a manner that assesses the total effect of the toxic gases given off. The importance of this can be seen in FAA testing in which one material (76 percent wool, 24 percent PVC) showed a much higher than expected toxicity. This toxicity could not be explained on the basis of HCN concentrations or a simple synergistic response due to the combination of PVC and wool. One possible explanation for the observed toxicity was the interaction of the

JSSG-2010-7

zirconium fluoride flame-retardant treatment that the material had received and the material itself. According to a 1985 report by the Air Force Wright Aeronautical Laboratories, most fatalities in aircraft fires result from asphyxiation attributable to insufficient oxygen, excessive concentrations of toxic gases, and/or excessive heat. Another example of the importance of evaluating toxic gas emission is an Air Canada DC-9 crash involving 23 fatalities. A majority of these fatalities were caused by the synergistic effect of toxic gases. The lethal level of CO in humans is 67.5 percent hemoglobin saturation. All 23 fatalities had CO levels between 20 and 63 percent, which is less than the lethal dose. The lethal level of HCN in humans is 3.5 micrograms per milliliter of blood. However, all but five of the 23 fatalities had levels below the lethal level. It has been determined that fractionally effective doses of CO and HCN are additive. Therefore, ¹@ the lethal level of CO and ²@ the lethal level of HCN to which these victims were exposed had the additive effect of a lethal dose. Another important reason to evaluate toxic gas emission in a postcrash fire scenario is that the combination of below lethal levels of blood agents like HCN and an oxygen depleted environment can also prove to be fatal. Blood agents affect body functions through action on the enzyme, cytochrome oxidase, thus preventing the normal utilization of oxygen by the cells and causing rapid damage to body tissue. In other words, any blood agents present will prevent the use of an already limited supply of oxygen, thereby causing the victims to become partially incapacitated and hindering timely egress, as a minimum.

The U.S. Army's success in reducing injuries and fatalities associated with post crash fires is well documented. Figure 31 compares the percentages of thermal injuries associated with Army, Navy and Civilian helicopters configured with non-crashworthy fuel systems against Army aircraft retrofit with crashworthy fuel systems (CWFS).

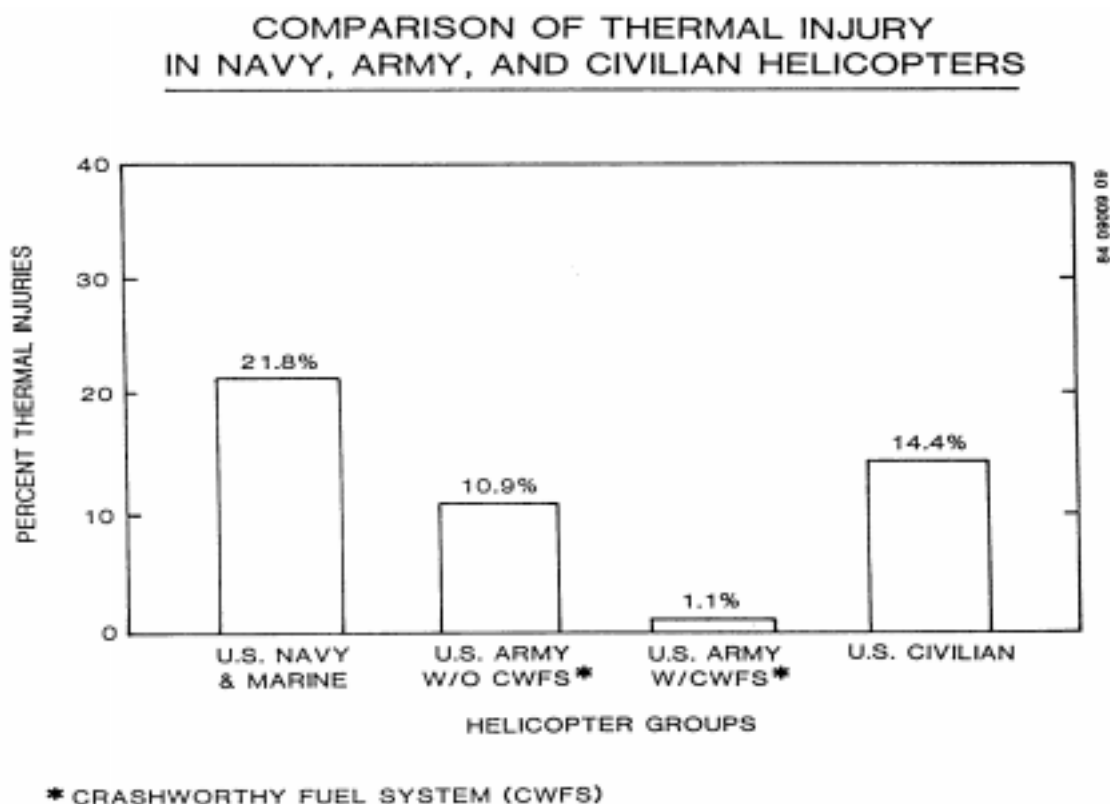


FIGURE 31. Comparison of Fuel System Injury Patterns

JSSG-2010-7

A comparison of crash resistant fuel systems' (CRFS) materials is provided in table XVI below.

TABLE XVI. Crash Resistant Fuel System Materials Comparison

Test Description	Standard Bladder US-566RL	Safety Cell US-770	<u>CIVIL CRFS</u> Safety Cell US-756	FPT CR.615	<u>MILITARY</u> MIL-T-27422B US-751
Drop Height (ft) (No Spillage)	NA	50 80% (full)	50 80% (full)	65 (full)	65 (full)
Constant rate tear (ft-lb)	NA	400	210	42	400
Tensile strength (lb) Warp	140	168	1717	NA	NA
Fill	120	158	1128	NA	NA
Impact penetration (5 lb chisel) Drop Height (ft) Parallel / Warp	NA	1.2	8.5	10.5	15
45 degree Warp	NA		8.5		15
Screwdriver (lb)	25	333-446	370.5	NA	NA
Material weight (lb/ft ²)	.12	.36	.40	.55	1.04
Weight Increase factor	1.0x	3.0x	3.3x	4.6x	8.7x

Coltman reports ("Evaluation of the Crash Environment and Injury-Causing Hazards in U.S. Navy Helicopters", Coltman, J. W., et al, published in SAFE JOURNAL, Spring Quarter, 1986) that, even though all of the aircraft series had mishaps occurring both on land and water, in most cases, one was predominant due to the basic mission requirements. Figure 32 demonstrates this point for Navy helicopters prior to fleet introduction of the SH-60 B Seahawk. Terrain at the impact site was tabulated for the significant survivable accidents and the distribution of categories was found to be:

- 26.4 percent occurred on water
- 51.4 percent occurred on flat ground
- 22.2 percent occurred in or through trees, or onto uneven ground.

JSSG-2010-7

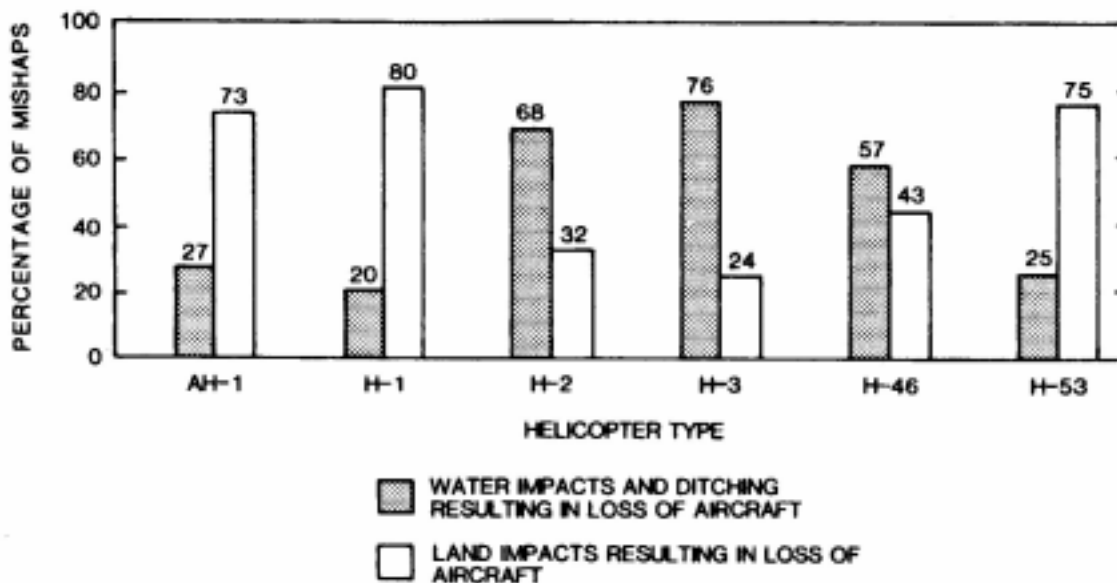


FIGURE 32. Distribution of Flight Mishaps According to Helicopter Series

4.7.3.4 Post-Crash Injury Protection Verification

Compliance with the requirement for prevention of post-crash injuries specified in 3.7.3.4 shall be verified incrementally at the program milestones shown in 4.7. Identification of potential injury sources and protective approaches shall be accomplished prior to the System Functional Review (SFR). Verification that the protective approaches prevent serious injuries be accomplished throughout the development cycle.

VERIFICATION RATIONALE (4.7.3.4)

Verification is necessary to show that no post-crash hazards exist that could prevent aircraft occupants from successfully egressing an aircraft after a survivable crash.

VERIFICATION GUIDANCE (4.7.3.4)

Verification of the requirement to protect against post-crash hazards shall be accomplished incrementally at each system review as specified in 4.7. Specific verifications required for “other injury sources” are specified below:

- a. System Functional Review (SFR) - Verify that the requirement for “other sources of injury” prevention is specified and that its impact on the air vehicle, support and training systems is captured in lower tier specifications. Verify that all functional requirements imposed on other aircraft systems, such as the fuel and flotation systems are identified by means of a detailed task analysis.

JSSG-2010-7

- b. Preliminary Design Review (PDR) - Verify that the trade study concepts address the prevention of hazardous environmental conditions against the need for supplemental protective equipment such as thermal/flame protective garments, emergency breathing devices, etc.
- c. Critical Design Review (CDR) - Verify the contractor's final design configuration relative to required supplemental protective equipment. Verify the "interface" performance of specified protective equipment to the requirements of 3.7.3.5.3.
- d. System Verification Review (SVR) - Verify that the air vehicle production representative hardware complies with all aspects of "other sources of injury" prevention requirements.

MIL-D-8708 Demonstration Requirements For Airplanes

MIL-D-23222 Demonstration Requirements For Helicopters

Volume V (USAAVSCOM, TR 89-D-22E) of the Aircraft Crash Survival Design Guide recommends consideration be given to conducting a crash test with the complete crash-resistant fuel system in enough of the airframe to create a realistic situation. Recommended design velocity changes are listed in Table XVII below.

TABLE XVII. Summary of Design Velocities for Rotary and Light Fixed Wing Aircraft

Impact Direction	Velocity Change (ft/sec)
Longitudinal	50
Vertical	42
Lateral *	25
Lateral **	30

* Light fixed-wing aircraft, attack and cargo helicopters

** Other helicopters

VERIFICATION LESSONS LEARNED (4.7.3.4)

TBD

JSSG-2010-7

3.7.3.5 Emergency Egress System

An emergency egress system shall be integrated into the aircraft which insures that all occupants can rapidly evacuate the aircraft during non-crash ground emergencies, and after survivable crash conditions specified in 3.7.1. The full complement of aircraft occupants, including aircrew, troops, and passengers, shall be capable of egressing the aircraft without assistance in a time period not to exceed _____ seconds when all exits are functional, and _____ seconds when only half of the exits are functional. For aircraft susceptible to post-impact rollover, such as helicopters, provisions shall also be included to permit occupants to egress within specified times when the aircraft is on its side and inverted, as well as upright.

REQUIREMENT RATIONALE (3.7.3.5)

The survival of aircraft occupants following a crash or ground emergency is often dependant upon the ability of occupants to rapidly evacuate the aircraft before the local environmental conditions (i.e. post-crash fire, toxic gasses, water immersion, etc.) cause injury. Therefore, the aircraft must include an emergency egress system that enables all occupants to perform their own escape before being overcome by threatening post-crash environmental conditions.

REQUIREMENT GUIDANCE (3.7.3.5)

The top-level requirement most often used to specify overall performance of an emergency egress system is the total time required to evacuate the aircraft under emergency conditions. For a specific aircraft application, the actual time to be specified for emergency evacuation should be determined by an analysis of specific emergency egress needs and threats. The analysis should take into consideration factors such as anticipated post-impact environmental hazards (i.e. fire, toxic gasses, submersion) and their associated time dependencies and life-threat relationships. An example showing factors to be included in a time-line analysis for underwater egress from a helicopter is shown in Figure 33.

JSSG-2010-7

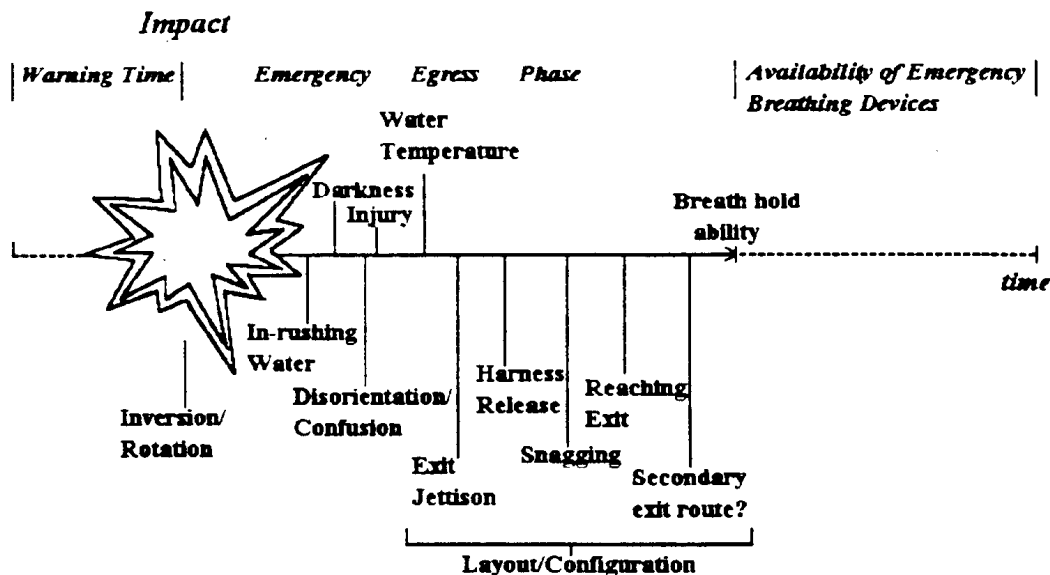


FIGURE 33. Factors to be Included in a Time-line Analysis for Underwater Emergency Egress from a Helicopter

Allowable time periods specified in the past for emergency egress can be found in MIL-STD-1472, the Federal Aviation Regulations (FAR), and the now cancelled SD-24 of the Navy. These allowed time periods, assuming half of the exits are inoperative, range from as little as 30 seconds in the Navy's SD-24, to 90 seconds in the FAR for commercial transport aircraft.

Actual design of the emergency egress system should flow down from the top-level time requirement. Key design parameters include the ratio of the number of exits to the number of occupants, exit sizes and geometry, exit release mechanisms, distance to exits, and a breakdown of the tasks required by occupants to utilize the emergency egress system. The functions of an emergency egress system are also affected by the performance of other aircraft systems and equipment. For example, aircraft deformation can jam emergency exits, and intrusion of aircraft structure can block escape paths. Because of these and other interrelationships, the emergency egress system must be designed using a systems engineering approach taking into account the various aircraft elements identified as having a functional impact on emergency egress. The allocation of specific systems and equipment to facilitate emergency egress should be based upon the results of an emergency egress trade study that is part of the overall aircraft design trade study.

REQUIREMENT LESSONS LEARNED (3.7.3.5)

In the past, the requirements established for emergency egress systems have not adequately addressed the whole spectrum of realistic emergency egress scenarios. The emergency egress system must be able to facilitate rapid evacuation of the aircraft not only in ideal "on the ramp" ground emergencies, but also after the aircraft has sustained structural damage from a

JSSG-2010-7

survivable crash. Other adverse conditions under which emergency egress systems must remain effective include aircraft rollover, fire, submersion, poor internal visibility, and panic.

4.7.3.5 Emergency Egress System Verification

Verification that the emergency egress system meets performance requirements of 3.7.3.5 shall be accomplished incrementally as part of the aircraft system reviews specified below. Initial risk reduction tests and demonstrations shall be conducted using aircraft mock-ups, and final qualification demonstrations shall be conducted using pre-production aircraft. The emergency egress demonstrations shall be conducted using a full complement of aircraft test subjects under simulated emergency egress scenarios appropriate for the aircraft type. The emergency egress demonstrations shall also include simulations of adverse conditions specified in 3.7.3.5, including poor visibility, post-crash roll angles deemed appropriate for the aircraft type, and submersion. To verify emergency egress in water mishaps, tests can be conducted using U.S. Navy underwater training devices (or civil equivalents) modified to simulate localized aspects of the aircraft's emergency egress configuration relevant to submerged escape. The verification process for underwater egress shall include consideration for post-impact stability of the aircraft in water, including aircraft sink rates and roll / pitch attitudes.

a. System Functional Review (SFR): Verify that all functional requirements for emergency egress specified in 3.7.3.5 and its sub-tier paragraphs are included in the system specification. Also insure that a human factors analysis of the emergency egress configuration is included as part of the aircraft development process.

b. Preliminary Design Review (PDR): Verify that the aircraft preliminary design includes an emergency egress configuration consistent with the requirements of 3.7.3.5 and its sub-tier paragraphs.

c. Critical Design Review (CDR): Verify that the contractor's design of emergency egress system is consistent with the approved preliminary design configuration, and that all component level and mock-up testing of the emergency egress system was successfully accomplished.

d. System Verification Review (SFR): Verify that the final design configuration (i.e. production representative hardware) complies with all the emergency egress requirements and that system level emergency egress testing was successfully accomplished.

VERIFICATION RATIONALE (4.7.3.5)

The emergency egress system is an integral part of aircraft's design and has a significant impact on its structural configuration (i.e. hatch openings, floatation bag integration, etc.). Therefore, it's critical that assessment of the emergency egress system begin at the earliest stages of aircraft design, while opportunities still exist for changes. As the aircraft design matures, risk reduction tests of components and mock-ups are needed verify that design assumptions are accurate. Finally, full scale tests of the complete emergency egress system are needed because these tests are the only realistic means to determine if the emergency egress system meets specification requirements. Simulated adverse conditions must be included in the test series to assess the impact of "real world" demands on the system.

JSSG-2010-7

VERIFICATION GUIDANCE (4.7.3.5)

The team assessing the emergency egress system should be experienced in both the science and “art” of emergency egress, and have a working knowledge of fleet field experience with emergency egress systems of similar class aircraft. When verifying the system performance, careful attention must be given to observing test subject interaction with the system during emergency egress tests, due to strong human factors dependencies in emergency egress. Minor and moderate difficulties observed by test subjects during egress tests conducted in relatively ideal test conditions could actually represent potentially serious problems in actual mishaps where other complications exist. Therefore, assessment of the emergency egress system will often require astute observation and judgement on the part of the testers. Furthermore, the assessment criteria should leave room for vital inputs and feedback of fleet test subjects to supplement the more simplistic time-to-egress criteria”. Finally, and perhaps most importantly, success of the test program is dependant on the degree of realism included in the actual tests. The test matrix should include tests with blocked exits, simulated darkness, and tests of critical elements of the egress system using underwater egress devices when appropriate.

VERIFICATION LESSONS LEARNED (4.7.3.5)

TBD

3.7.3.5.1 Emergency Exits

The emergency egress system shall include emergency exits which permit evacuation of the aircraft’s full complement of aircrew, troops, and passengers within the time periods and conditions specified in 3.7.3.5. Each exit shall be capable of being opened by a single person using one hand, and shall require no more than a total of two separate actions to actuate and fully open the exit. Exits shall be clearly marked and provided with automatic emergency illumination so that they can be visually identified at night, in smoke conditions, and underwater. Additionally, the exit sizes, geometry, and locations relative to escape paths shall be configured so that all occupants within the required anthropometric range can effectively use the exits. At least _____ percent of the emergency exits shall be capable of being opened from the outside the aircraft by rescue personnel. Emergency exits designated for rescue personnel entry shall be clearly marked to facilitate rapid identification and operation by personnel unfamiliar with the aircraft.

REQUIREMENT RATIONALE (3.7.3.5.1)

A sufficient number of exits must be provided in order for all occupants to quickly evacuate the aircraft during a ground emergency or after a survivable crash. The number of exits, their sizes, geometry, location, and ease of opening have a direct affect on an occupant’s ability to egress rapidly in an emergency before becoming overcome by post-crash environmental conditions such as fire, toxic fumes, and submersion.

JSSG-2010-7

REQUIREMENT GUIDANCE (3.7.3.5.1)

Exit types and sizes for various categories of commercial aircraft can be found in the Federal Aviation Regulations (FAR). Additional general guidance is provided below for establishing the emergency exit requirement.

- a. A maximum occupant-to-exit ratio should not exceed a threshold value determined for the specific aircraft type being developed. This ratio should take into account the size, geometry, and location of each exit.
- b. If analysis shows that aircraft could come to rest on its side, then additional exits should be provided in floor and/or overhead areas.
- c. Exits on opposite sides of narrow aircraft cabins should be staggered fore/aft to minimize crowding at exits.
- d. Exits must be sufficiently large and geometrically shaped to allow egress of required anthropometric size range including all body borne equipment.
- e. For aircraft susceptible to roll over, such as helicopters, exits should be located midway up the side wall in most cases to allow for a consistent step-up height to the lower sill of the exit in both the upright and inverted positions.

REQUIREMENT LESSONS LEARNED (3.7.3.5.1)

Helicopters with relatively wide fuselages pose egress difficulties in situations where the helicopter comes to rest on its side, because in that orientation the ground blocks the exits on one side (now down), and the exits on the other side (now up) can be out of reach. To correct this problem it would be extremely valuable to have exits in the aircraft's ceiling and/or floor.

Pyrotechnically opened exits have been found to have advantages of being able to reliably open even after sustaining impact deformation that can jam conventional mechanical release mechanisms. Also, pyrotechnically opened exits have been found to have weight advantages, and were for that reason selected for the especially weight sensitive V-22 tilt rotor. In addition to using pyrotechnics to open conventional hatches, line charges can be used to cut open exits in other areas of aircraft structure.

4.7.3.5.1 Emergency Exits Verification

Verification that emergency exits meet the performance requirements specified in 3.7.3.5.1 shall be accomplished incrementally at each aircraft system review specified in 4.7.3.5. Adequacy of the number of exits, their locations, sizes, and ease of opening shall be verified both by analyses and emergency egress demonstrations.

VERIFICATION RATIONALE (4.7.3.5.1)

Acceptability of emergency exits must be verified to insure that they are properly designed and integrated into the aircraft's overall emergency egress system.

JSSG-2010-7

VERIFICATION GUIDANCE (4.7.3.5.1)

Analyses and demonstration tests of the emergency egress system should include assessment of the following aspects of emergency exits.

- a. Opening and use of exits after airframe deformation and hatch deformation due to crash loads.
- b. Opening and use of exits after submersion.
- c. Effectiveness of exit emergency illumination.
- d. Exit usage with aircraft post-crash roll angles appropriate for the aircraft type and anticipated stability.
- e. Acceptability of the number, size, and location of exits based on a full complement of aircraft occupants performing emergency egress on land and underwater.
- f. Ergonomics of actuation handles.

VERIFICATION LESSONS LEARNED (4.7.3.5.1)

TBD

3.7.3.5.2 Emergency Egress Routes

The system shall provide functional escape routes from all occupied locations to primary and secondary emergency exits during a ground emergency, or after a survivable crash. The aircraft structure, together with its systems, shall maintain intact and unobstructed escape routes after an impact within the crash protection envelope specified in 3.7.1. Egress routes shall be provided that are visually identifiable, accessible, and usable from all occupant seating stations in any anticipated post-crash conditions including darkness, roll over, and submersion.

REQUIREMENT RATIONALE (3.7.3.5.2)

This requirement is necessary to ensure that each occupant of the aircraft is provided with an effective, structurally intact egress route from their pre-impact location in the aircraft to primary and secondary emergency exits.

REQUIREMENT GUIDANCE (3.7.3.5.2)

Specific definition of the required escape route configuration depends on the aircraft type, its seating layout with respect to emergency exits, and on the anticipated post-crash conditions of the aircraft. The following examples provide guidance as to how egress routes need to be tailored for different applications.

For large fixed-wing transport category aircraft, egress usually occurs while the aircraft is oriented in a primarily upright attitude. In this case, design of the emergency egress route configuration focuses primarily on providing unobstructed and orderly access to primary and secondary exits in such a way that individual exits do not become over crowded. However, it is common for helicopters to come to rest on their side, or inverted, after a land impact.

JSSG-2010-7

Emergency exits which are located on the aircraft sides may not be accessible in cases where an aircraft has rolled onto its side. In these cases, special hand-holds may be required to provide access to the exits. Alternately, or additionally, emergency exits can be installed in the aircraft ceiling and/or floor to provide better access.

Design of these egress routes that will be used for underwater escape must take into account that fact that the occupants will be essentially swimming, pushing, and pulling themselves underwater to their exits. It is vital that hand-holds be interspersed throughout the entire escape path so that occupants can maintain a grip on aircraft structure at all times; from the time they depart their seat until they are outside an aircraft emergency exit. The hand-holds serve the dual purpose of providing fixed points from which occupants can pull themselves through the aircraft interior, and providing critically needed reference points to maintain spatial orientation. In some cases the hand-holds can be continuous guide bars spanning the entire length of the cabin. To assist in darkness, the guide bars can be either self-illuminating, or lighted from an external source. Guide bars can also have tactile indicators to identify when an exit has been reached. When a series of single point hand-holds are used, they should also be illuminated with emergency lighting.

Egress path lighting is desired for all cabin egress routes, regardless of the aircraft type. The lighting is essential for occupants to locate escape paths in darkness, smoke conditions, and underwater conditions.

REQUIREMENT LESSONS LEARNED (3.7.3.5.2)

TBD

4.7.3.5.2 Emergency Egress Routes Verification

Verification that egress routes meet the performance requirements specified in 3.7.3.5.2 shall be accomplished incrementally at each aircraft system review specified in 4.7.3.5. Adequacy of the egress routes shall be verified both by analyses and emergency egress demonstrations.

VERIFICATION RATIONALE (4.7.3.5.2)

Acceptability of the egress routes must be verified to insure that they are properly designed and integrated into the aircraft's overall emergency egress system.

VERIFICATION GUIDANCE (4.7.3.5.2)

Analyses and demonstration tests of the emergency egress system should include assessment of the following aspects of emergency egress routes.

- a. Egress routes provided to both primary and secondary emergency exits.
- b. Egress routes provided with effective emergency illumination.
- c. Egress routes capable of being used both on land and underwater throughout range of anticipated post-crash roll angles appropriate for specific aircraft types.

JSSG-2010-7

- d. Hand-holds or guide bars provided throughout escape path to assist in underwater egress.
- e. Egress routes maintain structural integrity after aircraft impacts specified in 3.7.1.

VERIFICATION LESSONS LEARNED (4.7.3.5.2)

TBD

3.7.3.5.3 Localized Entrapment Prevention

The emergency egress system shall be free of physical restrictions that could prevent occupants from rapidly releasing from their restraint systems, departing their seats, traversing egress routes, and passing through emergency exits.

REQUIREMENT RATIONALE (3.7.3.5.3)

This requirement is intended to insure that occupants who have survived a mishap can effectively utilize the emergency egress system without becoming entrapped at any point while attempting to exit the aircraft. Entrapment could be caused either by aircraft structure impinging upon an occupant's body, or by an occupant's clothes or equipment becoming snagged on interior objects.

REQUIREMENT GUIDANCE (3.7.3.5.3)

Years of military mishap experience have revealed many ways that impact survivors have been entrapped within an aircraft and then killed by post-crash environmental conditions such as fire, toxic gasses, and submersion. An effective emergency egress system must be developed with an understanding of these real world hazards and include design mitigation strategies. Entrapment is often not caused by a single obstacle to egress, but by the combined affect of several partial restrictions.

First, occupant seating positions should be designed to preclude structural intrusion that could trap occupants in their seats due to crash conditions specified in 3.7.1. Additionally, seats, escape routes, and exits should be free of projections and equipment that could become obstacles and snag hazards during emergency egress. For aircraft carrying cargo, the cargo should be sufficiently restrained so that it does not break free of attachments creating injury and entrapment hazards. Cargo restraint requirements are specified in the Subsystems Specification Guide, and are summarized in 3.7.3.2.3 of this Specification Guide.

The design of crewstations, including flight controls and surrounding aircraft structure, must take into consideration the dynamic response of the occupant and his interaction with the aircraft interior during impact. For example, a pilot's legs can be forced forward by the sudden deceleration of impact, causing feet to be forced under rudder pedals, resulting in injury and entrapment. The problem can be more pronounced when energy absorbing seats are used which stroke downward, thus decreasing the distance from the occupant's hips to the rudder pedals. With proper attention to design detail, rudder pedals can be designed to prevent foot

JSSG-2010-7

entrapment, and a suggested protective geometry for rudder pedal design is shown in the U.S. Army Crash Survival Design Guide.

Another example relates to the copilot's collective control in helicopters, which can also become an obstacle to egress in mishaps. In the left hand seating position, an elevated collective control can protrude between the seat and the egress hatch, partially blocking the exit and/or its release actuation handle. As with rudder pedals discussed above, the problem with the collective can increase when energy absorbing seats are used that stroke downward. This problem can be solved with telescoping collective controls that can retract for emergency egress.

Pilot seats are often equipped with side armor panels that must be retracted in order to provide escape path clearance between seated occupants and their side exits. The side armor panels should be designed so pilots can rapidly retract the panels or swing them away with a single action using a single hand. If the side armor panel is attached to the non-stroking portion of an energy absorbing seat, the release mechanism should be located so that the occupant can reach and actuate the armor release mechanism regardless of the amount of seat stroke induced during the crash. The most desirable approach is for the armor panel to be released from a fixed point on the stroking seat bucket so that identical action is required by the occupant regardless of the amount of seat stroke. One approach is to integrate an emergency egress handle onto the seat bucket, which is designed and pulled in a manner similar to that of an ejection seat initiator handle. The same handle can also perform additional functions such as releasing the occupant's restraint and hatches. Handles of this type have been developed for canopy removal on the upgraded AH-1W helicopter and RAH-66 helicopter.

Seat restraint systems should also be designed so that all straps are quickly released by a single action using a single hand. Additionally, the force required to release the buckle shall not become excessive when the seat is inverted and the strap / buckle fittings are tensioned by the occupant's weight. The restraint harness configuration, webbing, and fittings should be designed so that they are not susceptible to becoming snag hazards for occupants attempting to rapidly exit their seats.

REQUIREMENT LESSONS LEARNED (3.7.3.5.3)

TBD

4.7.3.5.3 Localized Entrapment Prevention Verification

Verification that entrapment hazards are prevented as required in 3.7.3.5.3 shall be accomplished incrementally at each aircraft system review specified in 4.7.3.5. Adequacy of entrapment prevention shall be verified both by analyses and emergency egress demonstrations.

VERIFICATION RATIONALE (4.7.3.5.3)

Acceptability of aspects of the emergency egress system associated with entrapment prevention must be verified to insure that they are properly designed and integrated into the aircraft's overall emergency egress system.

JSSG-2010-7

VERIFICATION GUIDANCE (4.7.3.5.3)

Analyses and demonstration tests of the emergency egress system should include assessment of the following aspects of entrapment prevention:

- a. Structural intrusion is limited so occupants are not entrapped at their seating stations in crashes up to the severity specified in 3.7.1.
- b. Restraints are released by a single action using one hand, and occupants can move free from their seats without becoming entangled in restraint straps and associated fittings.
- c. Seat side armor can be released and retracted by a single action using one hand.
- d. Escape paths are free from projections and equipment that could become obstacles and snag hazards during emergency egress.
- e. Flight controls such as rudder pedals and collective are designed to avoid entrapment potential.

VERIFICATION LESSONS LEARNED (4.7.3.5.3)

TBD

3.7.3.6 Crash Data Recording

The system shall employ a means for measuring impact crash forces and recording the acceleration-time profiles defining the crash event for post crash analysis. The crash recording system shall be electronically integrated with other crash protection systems such as the air bag crash sensor and flight data recorder. It shall be installed within a protective container capable of withstanding crash forces and other environmental hazards such as fire and water pressures.

REQUIREMENT RATIONALE (3.7.3.6)

The crash recorder will provide crash investigators invaluable access to specific operational crash impact parameters. These data are currently estimated by crash investigators from the mishap scene's wreckage. Availability of actual crash impact data will provide an accurate data base from which advancements to aircraft crashworthiness can evolve with the subsequent payoff in reduced injuries and lives saved.

REQUIREMENT GUIDANCE (3.7.3.6)

Current development of the military air bag system for helicopter crew stations includes a requirement that the crash sensing system also provide a measurement and recording capability of the impact parameters for post crash analysis. Automotive research with Indy race cars employs crash recording systems, and this technology has recently been incorporated within several passenger vehicles of the General Motors line. The following references describe the racing car crash recorder technology:

JSSG-2010-7

- SAE 942482: “Racing Car Restraint System Frontal Crash Performance Testing”, Melvin, J. W., et al, General Motors Corp.
- SAE 962522: “Investigation of Indy Car Crashes Using Impact Recorders”, Melvin, J.W., et al, General Motors R & D Center; General Motors Motor-sports; CART Safety Team.

REQUIREMENT LESSONS LEARNED (3.7.3.6)

TBD

4.7.3.6 Crash Data Recording Verification

The crash data recording requirement specified in 3.7.3.6 shall be incrementally verified at specific program milestones throughout the development cycle. The following incremental verifications shall be accomplished prior to the specified review:

- a. System Requirements Review (SRR) - Verify that a requirement for a crash data recording system exists in the air vehicle specification and that appropriate demonstration tests of the system’s performance are scheduled during the aircraft’s development.
- b. System Functional Review (SFR) - Verify that the functional requirements of the crash data recording system specified in 3.7.3.6 have been clearly defined within the contractor’s development specification.
- c. Preliminary Design Review (PDR) - Verify that the system complies with the development specification by a review of the contractor’s preliminary engineering drawings, design analyses and prototype design dynamic test data.
- d. Critical Design Review (CDR) - Verify the crash data recording system’s design by a review of final design drawings, product specifications, and pre-production crash impact test data.
- e. System Verification Review (SVR) - Verify that the production configuration complies with the requirements of 3.7.3.6 by a review of the air vehicle’s qualification test report.

VERIFICATION RATIONALE (4.7.3.6)

Incremental verification will assure that the crash recorder has been electronically integrated within other appropriate crash protection systems.

VERIFICATION GUIDANCE (4.7.3.6)

Crash recorder verifications must be conducted in conjunction with other crash protection subsystems’ testing, such as dynamic crash loads tests of air bag sensors and crash-resistant seats.

VERIFICATION LESSONS LEARNED (4.7.3.6)

TBD

JSSG-2010-7

3.7.3.7 Aircraft Integration and System Interfaces

The occupant crash protection system and its interfaces shall be integrated into the air vehicle design. Integration and system interface requirements are cited in appropriate sections of the Crew Systems Specification Guide, the Vehicle Subsystems Specification Guide, and the Airframe Specification Guide.

In addition to crash survivability requirements, the Crew Systems Specification Guide defines performance requirements for post-crash survival and rescue systems, personal protective equipment, emergency egress training and crew-station integration requirements which effect overall crash safety.

The Vehicle Subsystems Specification Guide includes detailed functional requirements for crashworthy fuel systems, energy absorbing landing gear, aircraft floatation systems, and crashworthy cargo restraint systems.

The Airframe Specification Guide includes detailed functional requirements for the overall crash resistant capability of the airframe as well as structural interfaces with crash survival subsystems such as seating, landing gear, cargo restraint, and aircraft floatation systems.

REQUIREMENT RATIONALE (3.7.3.7)

The occupant crash protection system shall be compatible with all other sections of the Aircrew System Guide Specification that define crew station requirements for normal operations, as well as requirements for post-crash emergency egress, survival, and rescue. It shall also comply with and be compatible with the other Air Vehicle Specification Guides that set forth performance requirements in areas such as airframe structural resistance to crash impacts, crashworthy fuel systems, crashworthy cargo restraint, and aircraft floatation systems.

- a) Emergency Egress - The aircraft emergency egress systems shall function following a crash of the severity up to and including the level specified herein. Furthermore, the emergency egress system shall not interfere with or compromise crashworthiness requirements.
- b) Survival and Rescue - The crashworthiness system shall allow occupants to egress with all necessary survival and rescue equipment designated by the Survival and Rescue sections of the Aircrew Systems Specification Guide. All Survival and Rescue equipment shall be protected during the crash such that they fulfill Survival and Rescue requirements.
- c) Aircraft Structure - In addition to its applicable flight-worthy requirements, the aircraft structure shall comply with applicable crashworthiness requirements.
- d) Fuel System - In addition to its applicable flight requirements, the aircraft fuel system shall fulfill crashworthiness requirements. Specifically, the fuel system shall comply with the requirements of burn injury protection, gaseous hazards injury protection, and chemical hazards injury protection, provided in 3.7.3.4 (Other Injury Sources).

JSSG-2010-7

- e) Engines - In addition to its applicable flight requirements, the aircraft engines shall fulfill crashworthiness requirements. Specifically, the engines shall comply with the requirements of contact injury protection (3.7.3.2) and burn injury protection (3.7.3.4).
- f) Electrical System - In addition to its applicable flight requirements, the aircraft electrical system shall fulfill crashworthiness requirements. Specifically, the electrical system shall incorporate the requirements of ignition prevention (3.7.3.4) and electrical shock protection (3.7.3.4).

REQUIREMENT GUIDANCE (3.7.3.7)

The requirement for occupant crash protection affects nearly all of an aircraft's major elements and subsystems. It is essential that the overall crash protection approach is properly integrated into the aircraft to avoid gaps in protection, as well as conflicting requirements.

REQUIREMENT LESSONS LEARNED (3.7.3.7)

TBD

4.7.3.7 Aircraft Integration And System Interfaces Verification.

Verification of system integration shall be accomplished through assessment of contractor functional allocations during SRR, SFR, PDR, CDR, and SVR, and by analysis of all testing conducted on the occupant crash protection system.

VERIFICATION RATIONALE (4.7.3.7)

Verifications must be performed to assure that the crash protection system is successfully integrated into the aircraft.

VERIFICATION GUIDANCE (4.7.3.7)

Verification that the crash protection system has been properly integrated into the aircraft shall be conducted incrementally during the program reviews defined in 4.7. Performance validation of the specific subsystems involved shall be conducted in accordance with the requirements of the appropriate specification guides. Integration verification shall include, but need not be limited to the following functional areas.

- a. Aircraft Structure
- b. Aircraft Fuel System
- c. Aircraft Propulsion System
- d. Landing Gear
- e. Cargo Restraints
- f. Aircraft Flotation System

JSSG-2010-7

- g. Survival and Rescue Systems
- h. Personal Protection Equipment

VERIFICATION LESSONS LEARNED (4.7.3.7)

TBD

4. VERIFICATIONS (see REQUIREMENTS)

5. DEFINITIONS

The following definitions provide biomedical guidance on terms used throughout this handbook:

- a. Injury. Physical disturbance, damage, or destruction to a biological structure which impairs or prevents its normal functioning.
- b. Injury level. A rating of trauma's severity relative to its threat to life or physical or functional impairment, for example, the Abbreviated Injury Scale (AIS).
- c. Injury criterion. A numerical relationship between measurable engineering parameters and injury level.
- d. Tolerance level. The magnitude of loading which produces a specific injury level.
- e. Tolerance specification- An impact level that is taken as the maximum (or minimum) allowable condition for design purposes.

6. NOTES

(This section contains information of a general or explanatory nature that may be helpful, but is not mandatory.)

6.1 Intended use.

This document is intended to provide the rationale, guidance, and lessons learned for the performance requirements and verification for occupant crash protection and for the crash protective aspects of seating, restraint, and crew station and passenger/troop station design.

6.2 Supersession data.

This document supersedes MIL-STD-1776A(USAF), dated 25 February 1994; MIL-STD-1290A, dated 26 September 1988; MIL-STD-1807, dated 1 June 1990; MIL-S-58095A(AV), dated 31 January 1986; MIL-S-81771A(AS), dated 30 April 1975 with Amendment 1, dated 20 April 1996; and MIL-S-85510(AS), dated 19 November 1981.

JSSG-2010-7

6.3 Subject term (key word) listing.

acceleration injuries

contact injuries

crash protection

crash survivability

enemy evasion

post-crash survival

CONCLUDING MATERIAL

Custodians:

Army - AV

Navy - AS

Air Force - 11

Preparing activity:

Air Force - 11

(Project No. 15GP-0013-7)

STANDARDIZATION DOCUMENT IMPROVEMENT PROPOSALINSTRUCTIONS

1. The preparing activity must complete blocks 1, 2, 3, and 8. In block 1, both the document number and revision letter should be given.
2. The submitter of this form must complete blocks 4, 5, 6, and 7.
3. The preparing activity must provide a reply within 30 days from receipt of the form.
NOTE: This form may not be used to request copies of documents, nor to request waivers, or clarification of requirements on current contracts. Comments submitted on this form do not constitute or imply authorization to waive any portion of the referenced document(s) or to amend contractual requirements.

I RECOMMEND A CHANGE:

1. DOCUMENT NUMBER

JSSG-2010-7

2. DOCUMENT DATE (YYMMDD)

981030

3. DOCUMENT TITLE

Crew Systems Crash Protection Handbook

4. NATURE OF CHANGE (Identify paragraph number and include proposed rewrite, if possible. Attach extra sheets as needed.)

5. REASON FOR RECOMMENDATION

6. SUBMITTER

a. NAME (Last, Middle Initial)

b. ORGANIZATION

c. ADDRESS (include Zip Code)

d. TELEPHONE (Include Area Code
(1) Commerciale. DATE SUBMITTED
(YYMMDD)(2) AUTOVON
(If applicable)

8. PREPARING ACTIVITY

a. NAME

ASC/ENSI (AF-11)

b. TELEPHONE (Include Area Code

(1) Commercial
(937)255-6281(2) AUTOVON
785-6281

c. ADDRESS (Include Zip Code)

BLDG 560
2530 LOOP ROAD W
WRIGHT-PATTERSON AFB OH 45433-7101

IF YOU DO NOT RECEIVE A REPLY WITHIN 45 DAYS, CONTACT:

Defense Quality and Standardization Office
5203 Leesburg Pike, Suite 1403, Falls Church, VA 22041-3466
Telephone (703) 756-2340 AUTOVON 289-2340