

# Curved Drapery Track Template Instructions

Please read through all of these instructions before beginning your template.

## ▪ Important Note:

Lutron provides standard curved drapery tracks to fit around 90 degree bends. These tracks will have a bend radius of 20 inches. ***This solution does not require the creation of a template***, and can be found as a drapery track option in the Shade Configuration Tool (SCT). To specify, select the *Line Items* tab in the SCT, then click on the *Add Line Item* dropdown where you will select *Standard Curved Drapery Track*.

Standard Curved Drapery Track

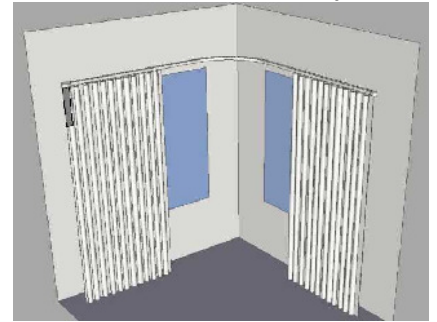

- Lutron drapery track can be bent to fit a curved wall, bay window, and many other special applications.
- “S” bends can only be achieved by splicing two bends together.

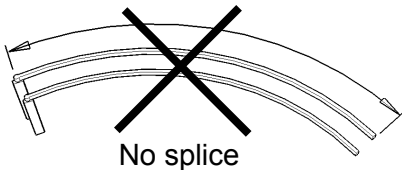

## Important Note:

Splices cannot be made on a curve. A splice can only be made on a straight portion of track that is at least 18 inches long.

- A paper template is the only way to ensure accurate curving of the drapery track.
- A checklist is included on pages 9 and 10 to help you provide Lutron with all the information needed to make the curved track with a minimum amount of delay. Please be sure to use the checklist and attach it to your template prior to shipping template to Lutron.
- **More information is always better than not enough information.** Digital photographs help Lutron to see the application area for the curtain track. Email photos to [shadingquotes@lutron.com](mailto:shadingquotes@lutron.com).

Before beginning with a curved track order, you must obtain a “COM” number to identify the materials that you are forwarding to us for review. This number will be used to track your order throughout the process and it is important that it appears on the template and your documentation. Without a COM number, your template will be rejected.

**To obtain your COM number, either call the Lutron Shading Quotes department at 1 (800) 446-1503 or e-mail [shadingquotes@lutron.com](mailto:shadingquotes@lutron.com)**

Do not begin a template or ask for a COM# until the job is sold. To obtain a rough budgetary estimate, submit your quote, with necessary notes, via the SCT or email the Lutron Shading Quotes department and give them measurements and details of track (such as constant or variable radius, single/dual/tandem track, and splice or no splice.).

**Before starting template, please be aware of some limitations for Lutron curved drapery track:**

- Maximum track length is 18 feet without a splice joint.
- With a splice joint, track may be up to 36 feet long.
- Splices can only occur in **straight** sections of drapery track. Splice must occur on a straight length of track at least 18 inches long.
- Tight bends more than 90° (i.e. where the two ends of the track bend in towards each other as shown below) are not possible.

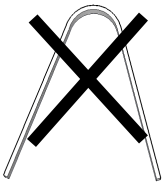

Tight bends are not possible.

- Tracks have to have a minimum bend radius of 20 inches.
- Minimum spacing for dual tracks is 5 ½ inches center-to-center.
- Finished track may vary  $\pm \frac{3}{4}$  inches from template.

18 feet maximum without splice, 30 feet with splice. Splice can only be located in straight sections.

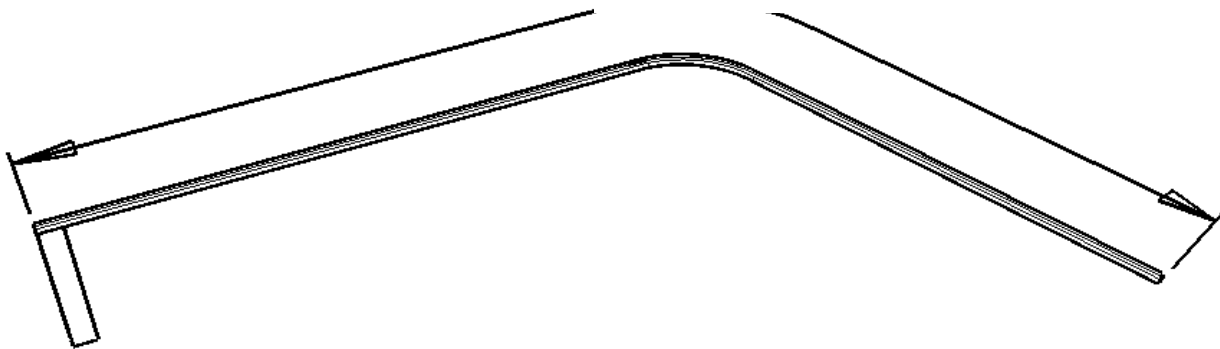

18 feet maximum

Splices not permitted on curves

5½ inches minimum center-to-center

**Other things to consider:**

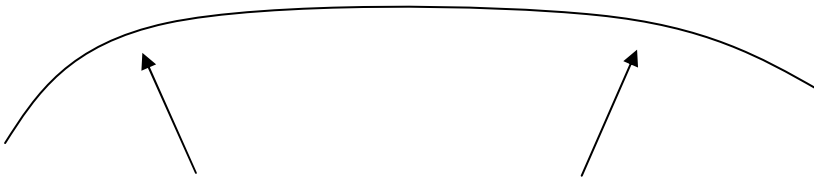

In the above picture, the bend on the left is tighter than that on the right. Multiple bends like this on one track are very difficult to make. If the track can be a single radius, it can be made more accurately.

Note: A splice cannot be used in this example as there is no straight portion of track available.

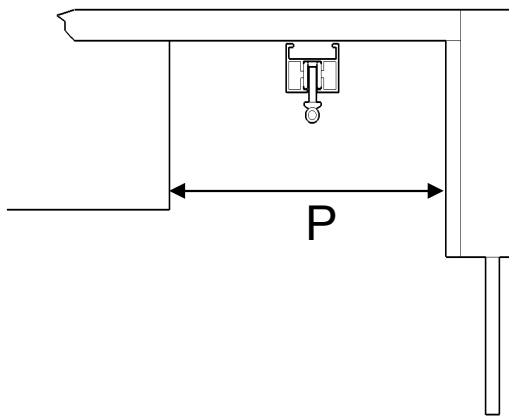

Pockets should allow ample room for the track and drapery.

Recommended Dimension	Wall Mount	Ceiling Mount	Dual Track
P	7 inches	6 inches	14 inches

Allow 1/2 inch between ends of drapery track and walls

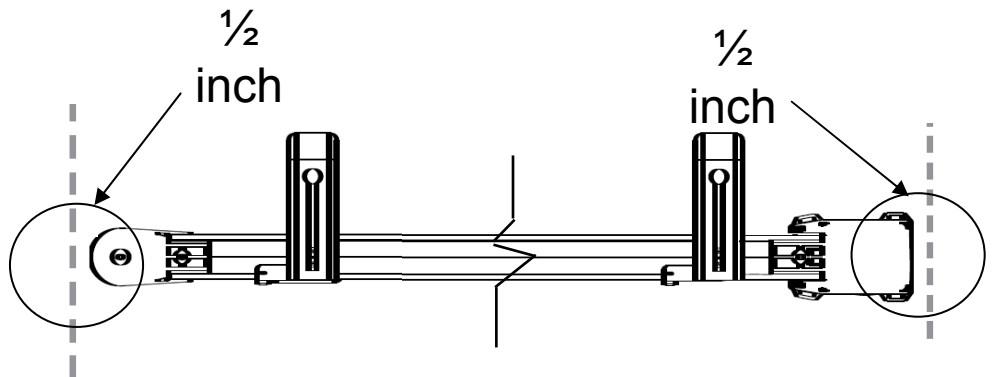

**Required tools:**

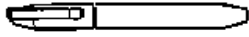

sharpie black marker

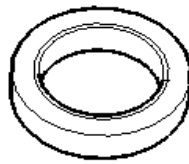

2" or 3" wide masking tape

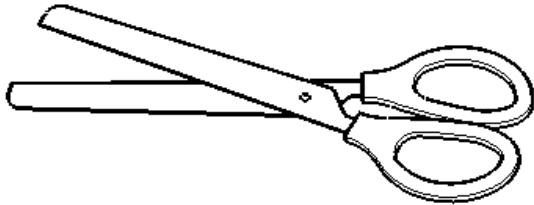

scissors



tape measure

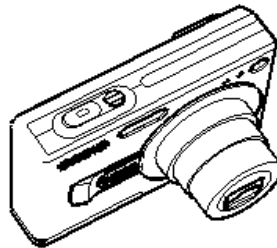

digital camera

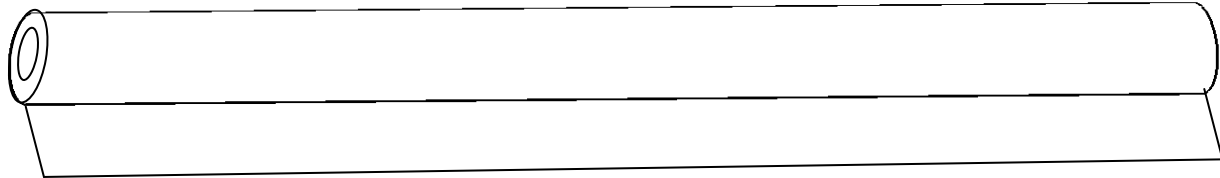

roll of contractor paper\*

\*Anything other than contractor paper or poster paper will be rejected.

**Helpful tool, not required:**



compass/divider

Useful to scribe centerline of track at a set distance from the wall.

**Begin by taping contractor paper together close to wall surface.  
Use the floor or the ceiling, whichever follows the curvature best.**

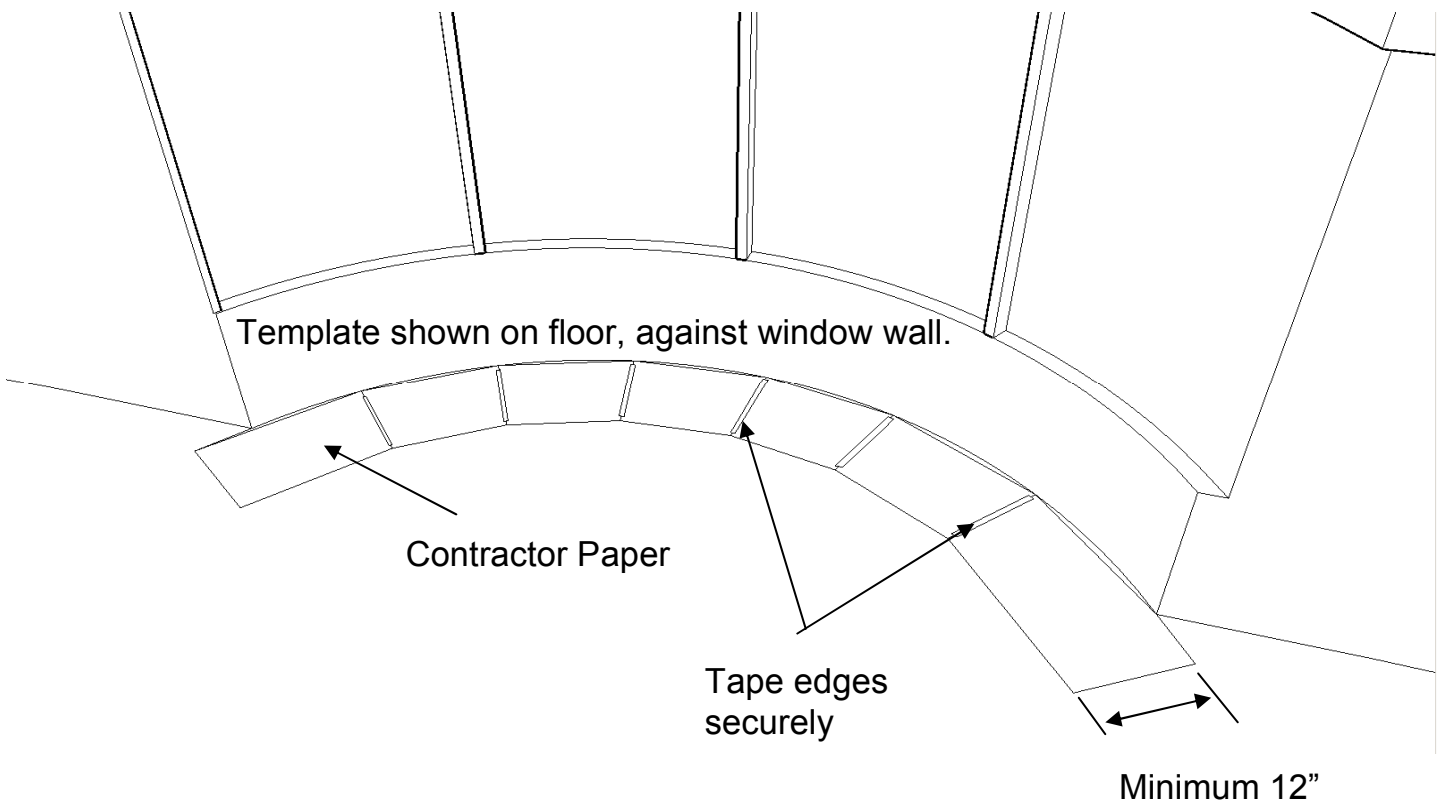

Using a compass or similar tool, follow wall profile to trace track centerline onto paper. After completing the trace, go over the pencil line with the black marker.

The typical distance for wall mounted track is 3½ inches from wall surface, however, your distance may be greater for the curtain to clear things like handles, window sills, columns, vents, etc.

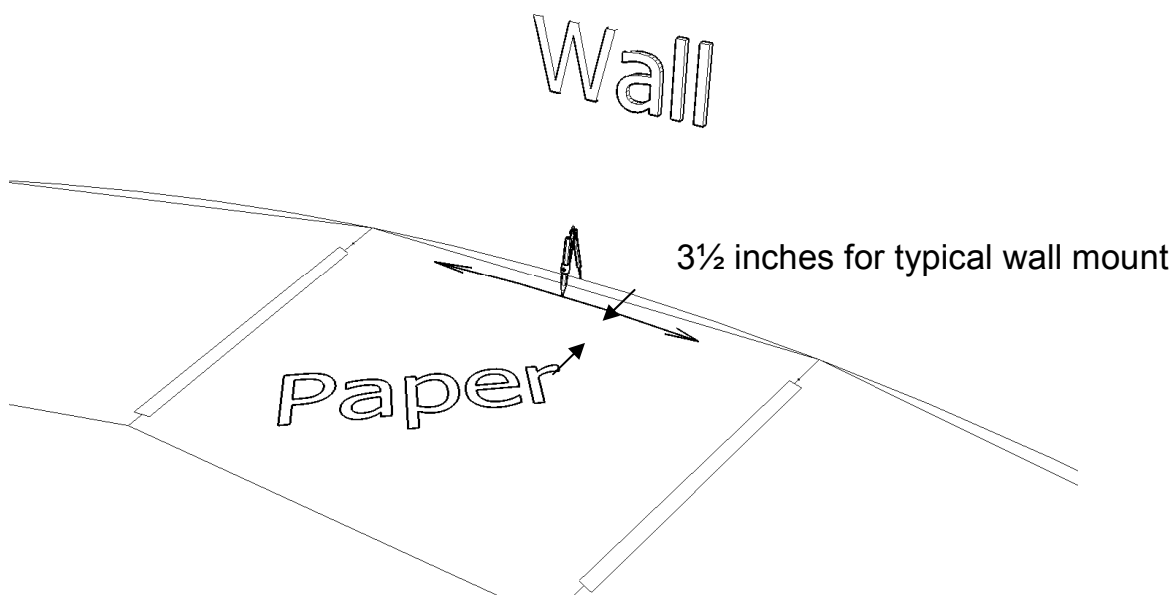

Once track centerline has been traced, be sure to mark the additional features needed to build the track. Be sure to write down what each mark signifies.

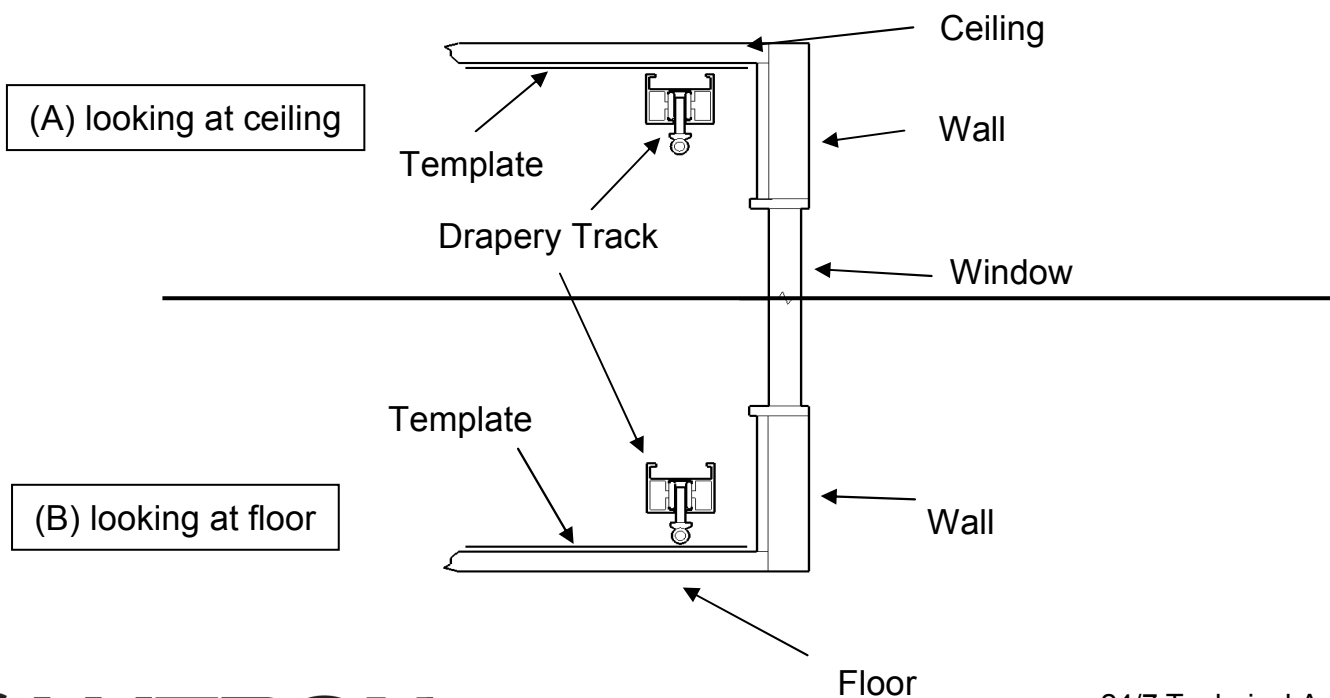
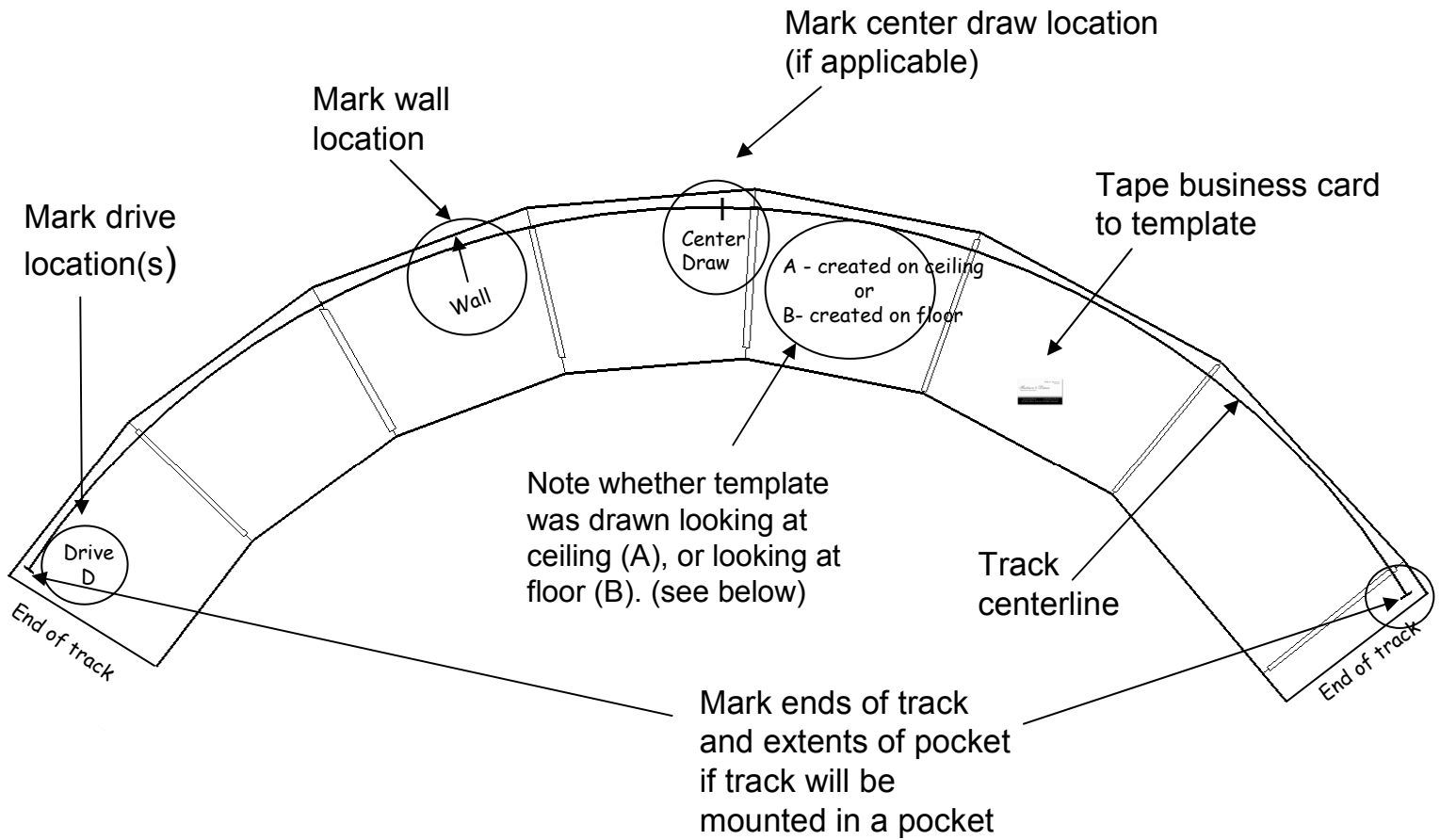

Take a digital photo of the finished template in place.  
 Take several photos of the area where the curtain track will be mounted.  
 Email photos to [shadingquotes@lutron.com](mailto:shadingquotes@lutron.com)

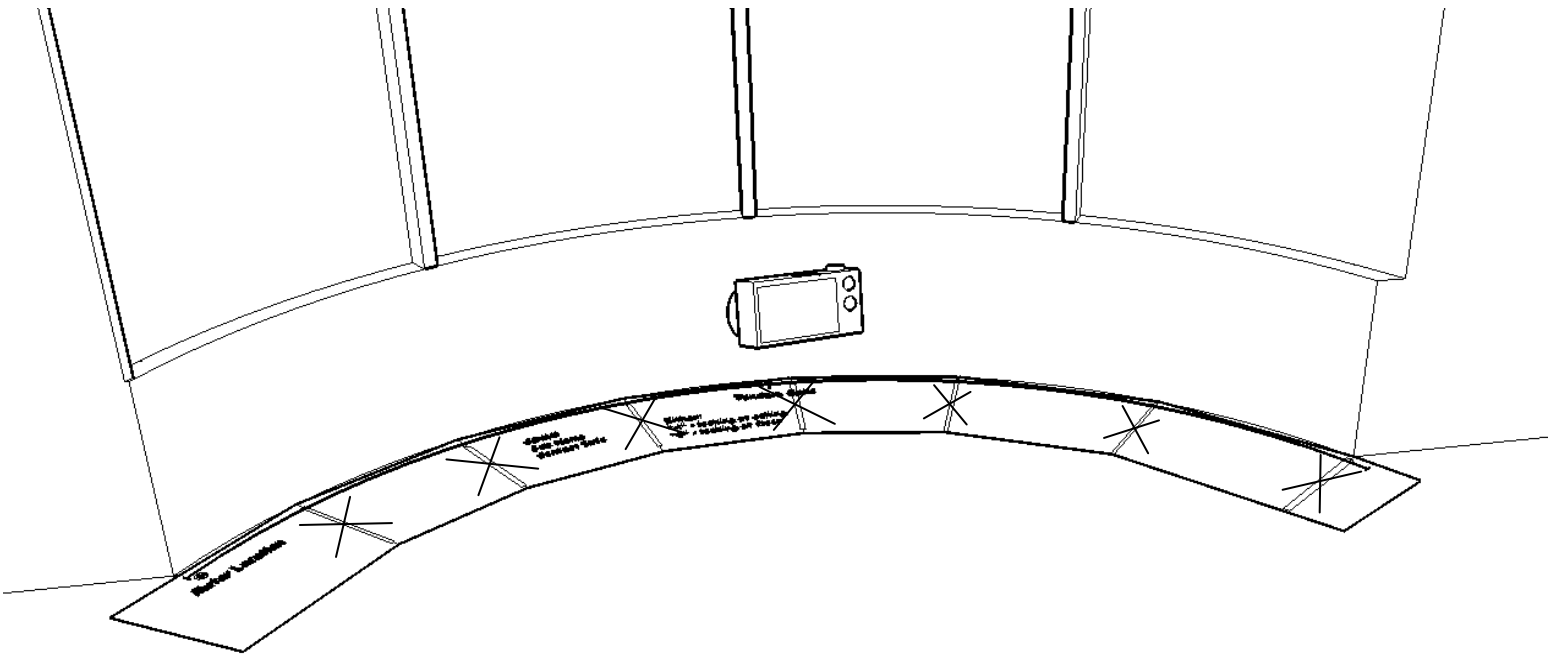

- Be sure that the template is taped together in one piece. Mark an “X” over each seam of paper so that if template shifts in shipping, Lutron will have a reference as to where to join those pieces. Note: Separate pieces will be rejected.
- Each curved track should have its own template. The only exception is dual tracks, which can be on the same template.

Write COM # on template.

Tape both pages of the checklist to the template (pages 9 and 10)

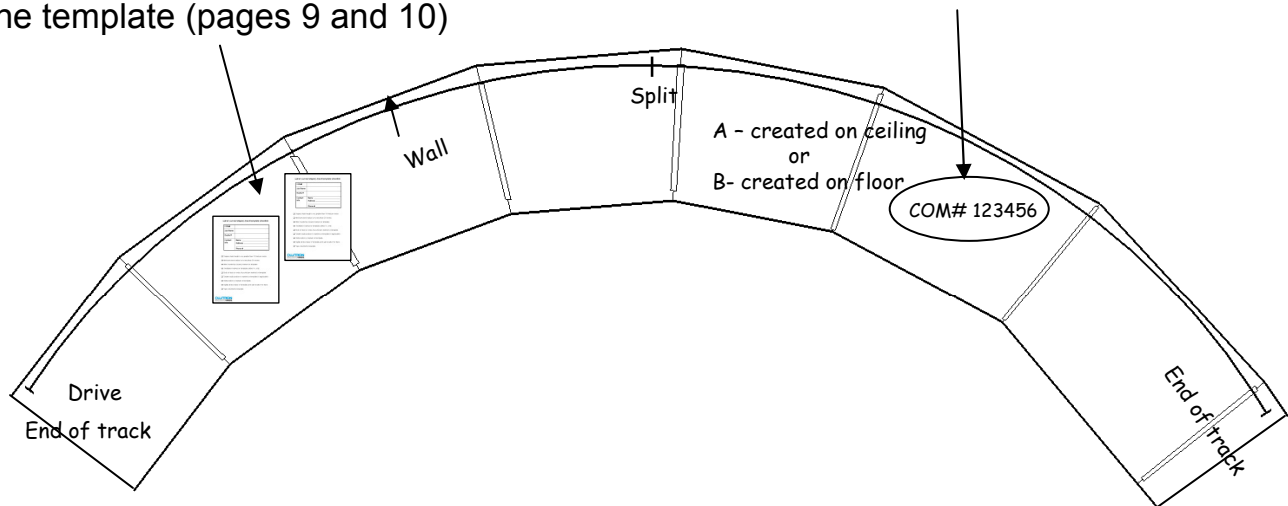

**Carefully roll template (DO NOT FOLD\*) and place into a sturdy shipping tube.**

\* Folding makes it difficult to lay flat, which may distort the true size and shape of curve.

Write your COM#, Quote #, Job Name, and Job info on the outside of the tube.

Ship to:

Lutron Shading Solutions  
11520 Sun Shade Lane  
Ashland, VA 23005  
ATTN: *Your COM #*

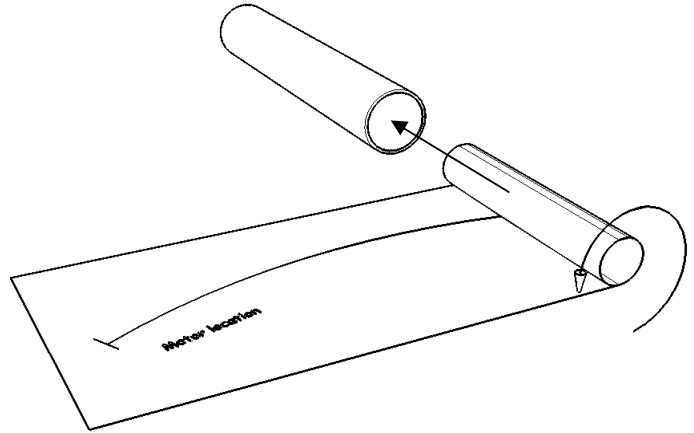

It is of the highest importance that all items requested in the instructions be followed. A production engineer will review the template and advise if it is approved or if additional information/revisions are needed.

If all information was provided correctly and meets the requirements, your curved track layout will be approved for manufacture. Production of the track will begin after approval of the template and receipt of a purchase order. Lead time for shipment of the completed track(s) begins after receipt of the order and approval of the template.





