



CUSTOM PRECAST CONCRETE



TABLE OF CONTENTS

- CONCRETE COLORS..... 06**
- ACID WASH..... 07
- PREMIUM GROUND AND POLISHED..... 08
- LIGHT GRIND..... 09
- WEATHERSTONE..... 09
- CONCRETE SEAT WALLS..... 10**
- TREAD & RISERS..... 14**
- SELF-SUPPORTING TREAD & RISERS..... 15
- FULLY-SUPPORTED TREAD & RISERS..... 16
- POOL COPING..... 18**
- PERIMETER SECURITY..... 20**
- STREETSCAPES & CURBING FORMS..... 22**
- CUSTOM SIGNS..... 24**
- CUSTOM COLUMNS..... 26**
- TREE GRATES..... 28**
- PHOTO INDEX..... 31**



WHO WE ARE

In 1953, Edward Creske founded Wausau Tile with a simple formula for success: quality and service. With Ed's unwavering commitment to quality and personalized customer service, Wausau Tile has forged lasting partnerships with many architects, designers and companies worldwide. Our company has never wavered from Ed's founding values which has ensured that the name Wausau Tile is synonymous with American craftsmanship, dependability and innovation.

Throughout the past six decades, Wausau Tile has grown to become the preeminent manufacturer of architectural concrete, terrazzo and metal products. We were the first American manufacturer of cementitious terrazzo tile and among the first domestic producers of hydraulically pressed concrete pavers. Today we are a leader in innovative sustainable manufacturing practices, using recycled materials and green technology, and our products are found in virtually every community in the United States.

Wausau Tile is the trusted choice for many of the world's leading designers, engineers and building professionals. Whether they're creating projects on Main Street U.S.A. or at iconic destinations such as Time Square or Cleveland Public Square, they choose to partner with our collaborative, creative and responsive team time and time again.

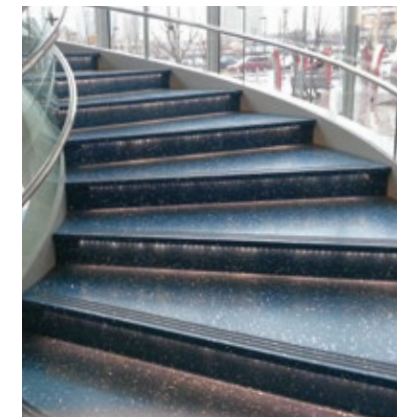

OUR CUSTOM PRECAST CONCRETE

Big ideas start with a blank canvas and Wausau Tile's custom precast concrete provides the palette for painting a masterpiece. Concrete wall panels, columns, seat walls, coping and tree grates are just a glimpse in to Wausau Tile's capabilities. From stunning streetscapes to cascading stairs to contoured curbing, the applications are endless. Wausau Tile has the experience to solve your complex custom concrete design challenges.

Turn big ideas into bold and beautiful showstoppers with custom concrete installations by Wausau Tile.



OUR COMPLEMENTARY PRODUCTS



SITE FURNISHINGS

Our vast selection of benches, chairs, tables, bollards, planters, waste and recycling containers and other furnishings guarantee durability, functionality and affordability. Explore our diverse offerings, which are built to weather the rigors of any environment and stand the test of time.

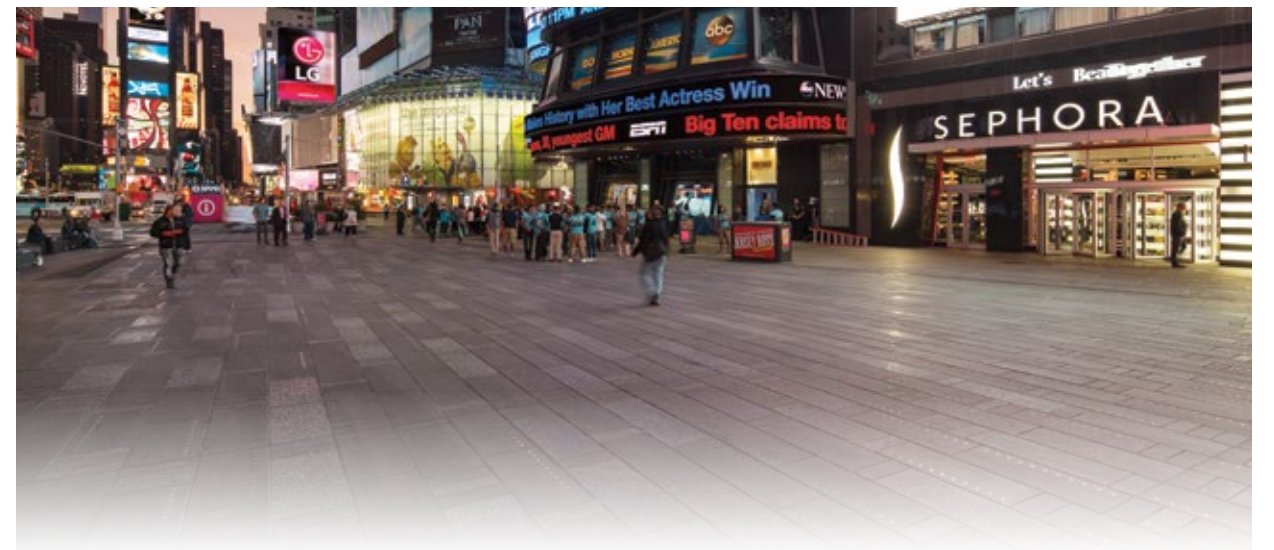

ARCHITECTURAL PAVERS

Choose from numerous colors, sizes, shapes and textures to find the right fit for your walkway, deck, pool area, rooftop and more. Keep pedestrians safe with detectable warning pavers or navigate the challenges of a pitched surface or rooftop with our pedestal system.



WAUSAU TILE CONCRETE COLORS



Marie Gabrielle Gardens | Dallas, TX | Custom Precast Concrete Planters

CUSTOM COLORS

At Wausau Tile, we have a large selection of colors for you to choose from to fit any space. However, we know that sometimes our customers are looking for an exact color match to an existing piece or something extra special. With our free sample process, Wausau Tile offers you the ability to create custom colors from scratch or match existing products. The quickest way to achieve a custom match is to provide us with a physical sample. If you are looking to create a custom color, provide us with a Benjamin Moore, Sherwin Williams or Pantone color and we will go to work.



Battle Creek | Battle Creek, MI | Custom Precast Concrete Benches and Planters

ACID WASH





Minnesota Children's Museum | Saint Paul, MN | Custom Precast Concrete Bollards

PREMIUM GROUND AND POLISHED

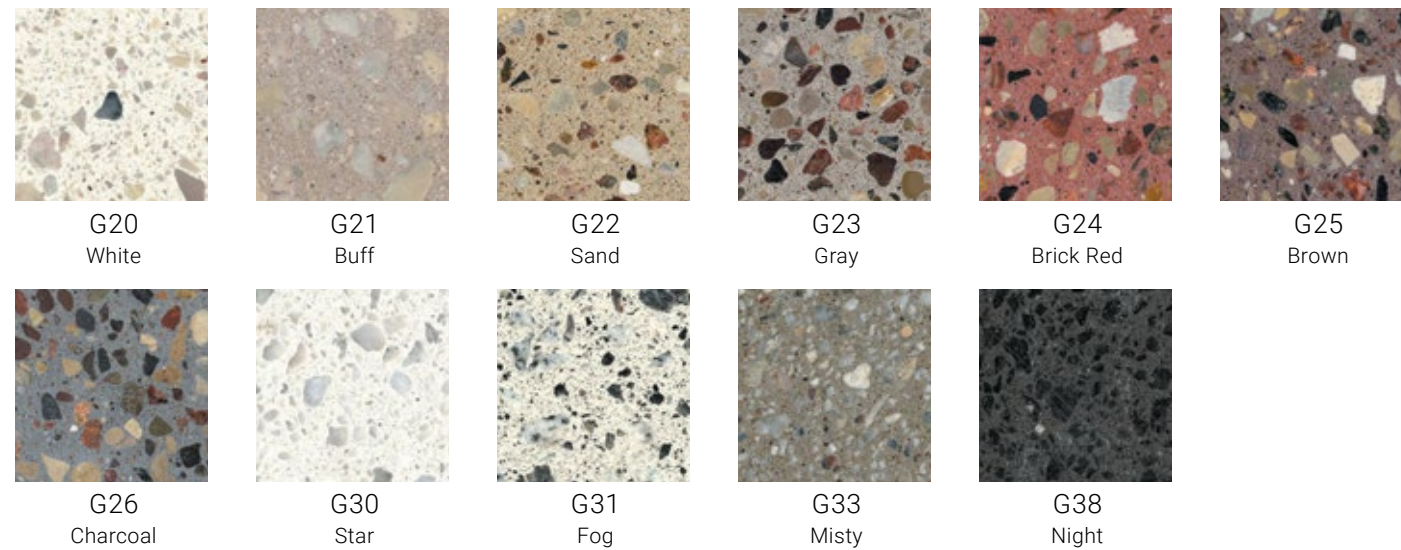

LIGHT GRIND

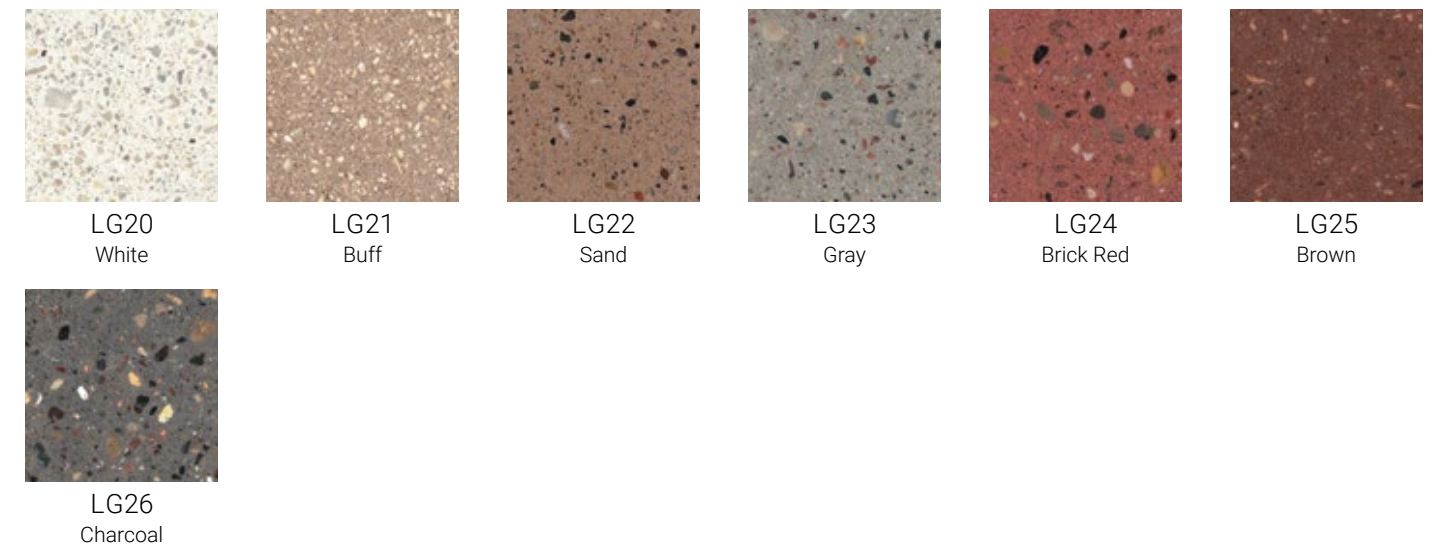

WEATHERSTONE

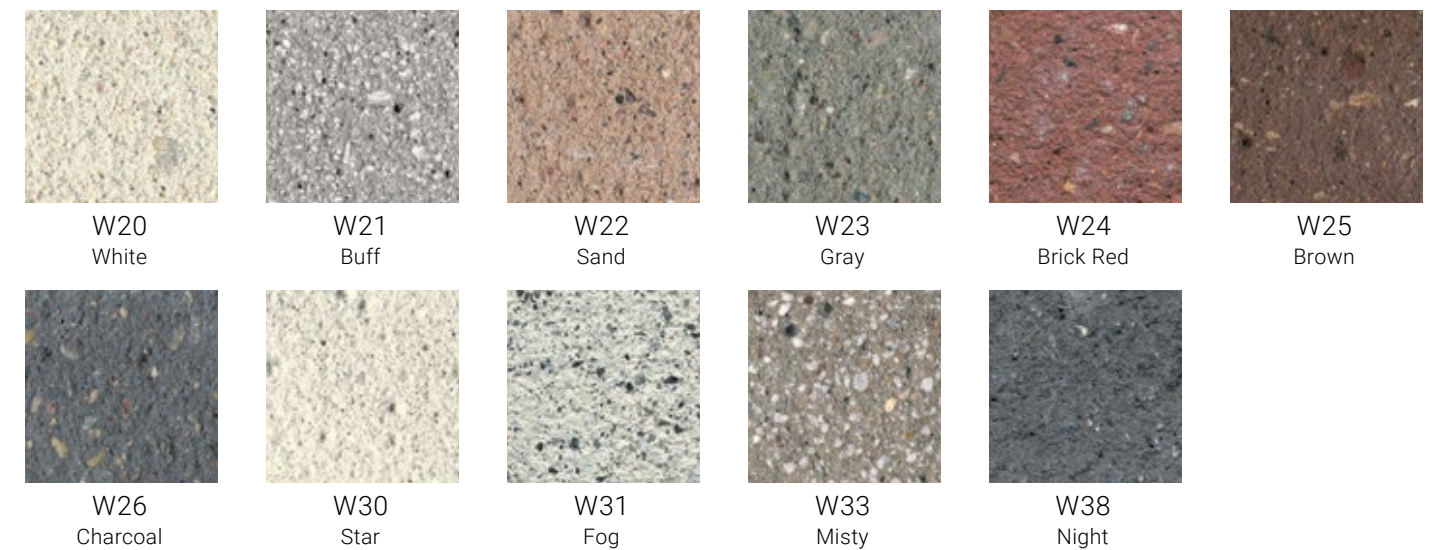



WAUSAU TILE CONCRETE SEAT WALLS



Cleveland Public Square | Cleveland, OH | Custom Precast Concrete Seat Walls

PRECAST CONCRETE SEAT WALLS

Custom precast concrete seat walls, planter walls and other wall panels add a touch of sophistication while serving as both continuous bench space and abstract works of art.

- Different profiles available from block style to tapered
- Can have recesses or reveals for lighting
- Shapes can be radial or straight
- Undulating heights and widths
- Wood can be attached
- Engineering for attachment available



Wacker Dr. | Chicago, IL | Custom Precast Concrete Planter Walls

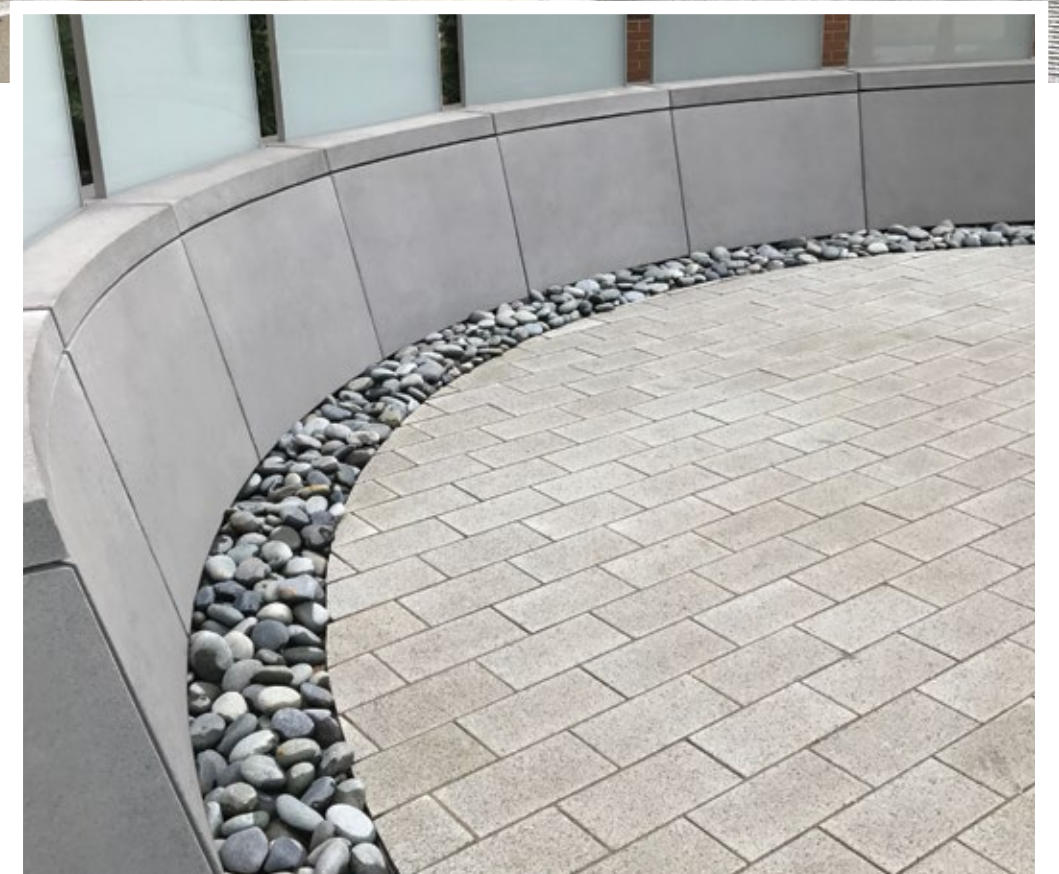

College of Pharmacy | St. Louis, MO | Custom Precast Concrete Wall Panels and Wall Caps



Vista Apartments | Fitchburg, WI | Custom Precast Concrete Walls & Planters, Stoney Creek Pavers, Custom Precast Terrazzo Countertops

VISTA APARTMENTS

The outdoor courtyard and entertaining space at the Vista Apartment complex in Fitchburg, WI showcases Wausau Tile's full line of products. Custom precast concrete walls were created with a woodgrain look to tie into the aesthetic of the Vista courtyard. Our custom precast terrazzo was used as countertops at the grilling stations as well as on the top of the custom metal bench. Several precast concrete planters were placed throughout the courtyard to bring in some greenery to the neutral earth tones of this outdoor space. Finally, Stoney Creek pavers were used throughout the entire Vista Apartment courtyard to bring in a natural stone look to tie in the look and feel of the coordinating Wausau Tile products.





WAUSAU TILE TREAD & RISERS



Damen Ave. | Chicago, IL | Custom Precast Concrete Fully-Supported Tread and Risers

TREAD AND RISERS

Wausau Tile makes a variety of treads, coping and bases to give your next project the style and strength it needs. Our precast concrete tread and risers are reinforced with fiber or rebar. Our base and coping complete the finished look around the base of our column covers, wall panels and other surfaces. Let Wausau Tile complement or match any existing concrete floors or indoor stairs with ease.



Epic Headquarters | Verona, WI | Custom Precast Concrete Self-Supporting Treads

SELF-SUPPORTING TREAD AND RISERS

Wausau Tile's self-supporting treads have a 4" minimum thickness and can span from stringer to stringer with weld plates. Treads can be radial or straight and can have tapered ends per your design. Engineering is available.

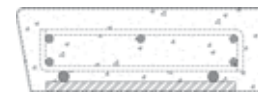

C60
SELF-SUPPORTING
FLAT TREAD

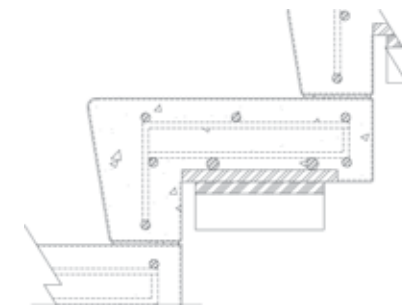

C70
SELF-SUPPORTING
TREAD & RISER

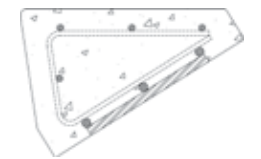

TEARDROP
SELF-SUPPORTING



Harvey Milk Photo Center | San Francisco, CA | Custom Precast Concrete Fully-Supported Tread and Risers

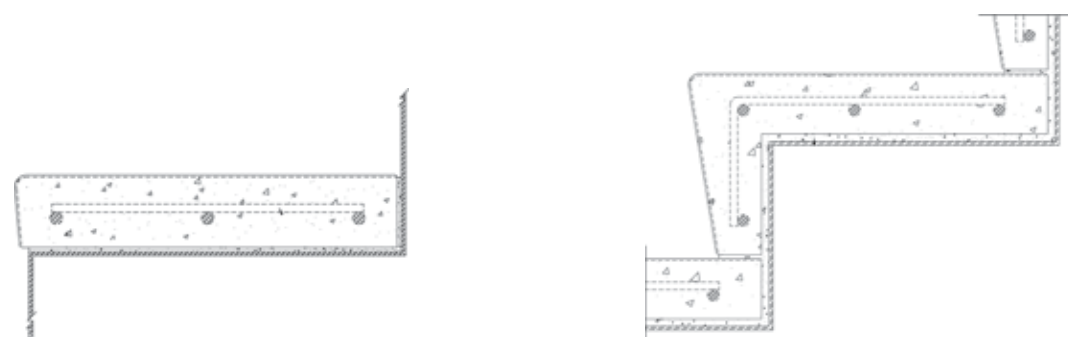

Photo © Ed Massery

Art Climb | Cincinnati, OH | Custom Precast Concrete Fully-Supported Tread and Risers

FULLY-SUPPORTED TREAD AND RISERS

Wausau Tile's fully-supported treads have a 2" minimum thickness and must be fully supported on a full concrete substrate or pan. Treads can be radial or straight and can have tapered ends per your design.



C30 FLAT TREAD

C31 TREAD & RISER

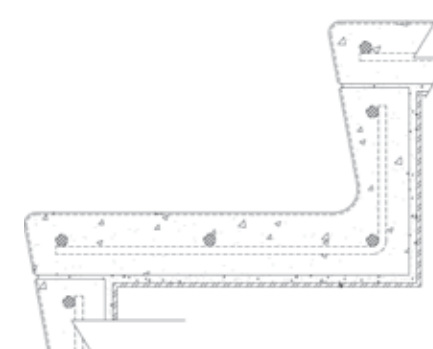

C36 REVERSE TREAD & RISER

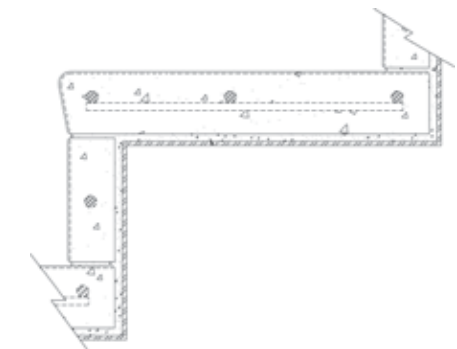

C40 SEPARATE TREAD & RISER



C51 BLOCK TREAD (SLANTED NOSE DESIGN)

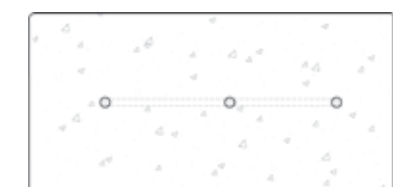

C51 BLOCK TREAD (SQUARE NOSE DESIGN)



WAUSAU TILE POOL COPING



Brownwood Hotel & Spa | The Villages, FL | Custom Precast Concrete Pool Coping

POOL COPING

Wausau Tile's pool coping is available in single bullnose, double bullnose, safety edge and eased edge styles. Shapes can be radial or straight per your design.



Brownwood Hotel & Spa | The Villages, FL | Custom Precast Concrete Pool Coping



WAUSAU TILE PERIMETER SECURITY



Loyola University | Chicago, IL | Custom Precast Concrete Planter Barriers

PERIMETER SECURITY

Controlling access to buildings with strength and security has never been more important. Our selection of custom concrete forms - including original reinforced bollards, planters and sleek and sturdy barriers - are trusted around the world at sites that demand added perimeter security, from the U.S. State Department and military forts to professional sports facilities. Whether your site requires controlled access, regulated traffic flow or simply the added look of serious strength, we're here to protect while providing aesthetic value and peace of mind. Wausau Tile's custom concrete forms can also be prepped for a K-rated system.



Rochester International Airport | Rochester, MN | Precast Concrete Wall Barrier





WAUSAU TILE STREETSCAPES & CURBING FORMS



Maple Ave. | Evanston, IL | Custom Precast Concrete Streetscape

STREETSCAPES AND CURBING FORMS

Custom concrete streetscapes have the ability to transform urban settings from blasé to beautiful. Wausau Tile helps designers create more walkable, livable and inviting spaces with custom precast concrete formations that frame, route and accent city streets. There's no project too big. Let's turn your bold vision into a showstopper.

- Block style or tapered profiles
- Radial or straight pieces



Maple Ave. | Evanston, IL | Custom Precast Concrete Streetscape



WAUSAU TILE CUSTOM SIGNS



Town of Glenrock | Glenrock, WY | Custom Precast Concrete Sign

CUSTOM SIGNS

Convey your message in style with Wausau Tile's custom signs. Complement cast-in, embossed or metal lettering with plaques, silkscreen logos and a variety of other customizable materials for unique expressions.



Veterans Memorial Park | Elgin, IL | Custom Precast Concrete Formation



WAUSAU TILE

CUSTOM COLUMNS



Schofield Ave. | Weston, WI | Custom Precast Concrete Columns

CUSTOM COLUMNS

Wausau Tile's columns and formations are the perfect finishing touch to any architectural or landscape project. Complement cast-in, embossed or metal lettering with plaques, silkscreen logos and a variety of other customizable materials for unique expressions. Or protect building columns with covers that offer elegant form and essential function. Cladding or solid concrete columns available per your design.

- COLUMN COVERS
- COLUMN BASE
- COLUMN AND WALL CAPS



Leighton Plaza | South Bend, IN | Custom Precast Concrete Columns and Formations



WAUSAU TILE TREE GRATES



Christian Science | Boston, MA | Custom Precast Concrete Tree Grates

TREE GRATES

Wausau Tile's decorative tree grates are the perfect blend of form and function. Available with recesses and drainage slots.



Christian Science | Boston, MA | Custom Precast Concrete Tree Grates

PHOTO INDEX



Veterans Honor Park | Chesterfield, MO
Custom Precast Concrete Signs and Benches

#	PROJECT NAME	CITY	STATE	PRODUCT	PAGE
1	Atlanta Financial Center (Designed by Perkins and Will)	Atlanta	GA	Custom Precast Concrete Seat Walls	Cover
2	University of Michigan	Ann Arbor	MI	Custom Precast Concrete Seat Walls	2
3	Cleveland Public Square	Cleveland	OH	Custom Precast Concrete Seat Walls	4
4	Marie Gabrielle Gardens	Dallas	TX	Custom Precast Concrete Planters	6
5	Battle Creek	Battle Creek	MI	Custom Precast Concrete Benches and Planters	7
6	Minnesota Children's Museum	Saint Paul	MN	Custom Precast Concrete Bollards	9
7	Cleveland Public Square	Cleveland	OH	Custom Precast Concrete Seat Walls	10
8	Wacker Dr.	Chicago	IL	Custom Precast Concrete Planter Walls	11
9	College of Pharmacy	St. Louis	MO	Custom Precast Concrete Wall Panels and Wall Caps	11
10	Vista Apartments	Fitchburg	WI	Custom Precast Concrete Walls & Planters, Stoney Creek Pavers, Custom Precast Terrazzo Countertops	12
11	Vista Apartments	Fitchburg	WI	Custom Precast Concrete Walls & Planters, Stoney Creek Pavers, Custom Precast Terrazzo Countertops	13
12	Damen Ave.	Chicago	IL	Custom Precast Concrete Fully-Supported Tread and Risers	14
13	Epic Headquarters	Verona	WI	Custom Precast Concrete Self-Supporting Treads	15
14	Harvey Milk Photo Center	San Francisco	CA	Custom Precast Concrete Fully-Supported Tread and Risers	16
15	Art Climb	Cincinnati	OH	Custom Precast Concrete Fully-Supported Tread and Risers	17
16	Brownwood Hotel and Spa	The Villages	FL	Custom Precast Concrete Pool Coping	18
17	Brownwood Hotel and Spa	The Villages	FL	Custom Precast Concrete Pool Coping	19
18	Loyola University	Chicago	IL	Custom Precast Concrete Planter Barrier	20
19	Rochester International University	Rochester	MN	Precast Concrete Wall Barrier	20
20	Maple Ave.	Evanston	IL	Custom Precast Concrete Streetscape	22
21	Maple Ave.	Evanston	IL	Custom Precast Concrete Streetscape	23
22	Town of Glenrock	Glenrock	WY	Custom Precast Concrete Sign	24
23	Veterans Memorial Park	Elgin	IL	Custom Precast Concrete Formations	25
24	Schofield Ave.	Weston	WI	Custom Precast Concrete Columns	26
25	Leighton Plaza	South Bend	IN	Custom Precast Concrete Columns and Formations	27
26	Christian Science	Boston	MA	Custom Precast Concrete Tree Grates	28
27	Christian Science	Boston	MA	Custom Precast Concrete Tree Grates	29
28	Veterans Honor Park	Chesterfield	MO	Custom Precast Concrete Signs and Benches	30
29	Atlanta Financial Center (Designed by Perkins and Will)	Atlanta	GA	Custom Precast Concrete Seat Walls	BACK Cover

TO PURCHASE THE PRODUCTS IN THIS CATALOG CONTACT:



PO Box 1520 | Wausau, WI 54402-1520
wtile@wausautile.com | 800.388.8728

Wausau Tile reserves the right to alter, modify or discontinue any product, finish or color at any time for any reason without notice.



SITE FURNISHINGS

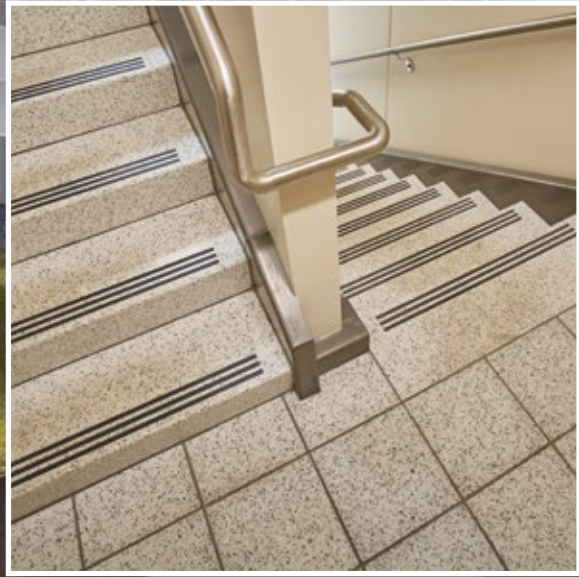

CUSTOM PRECAST TERRAZZO

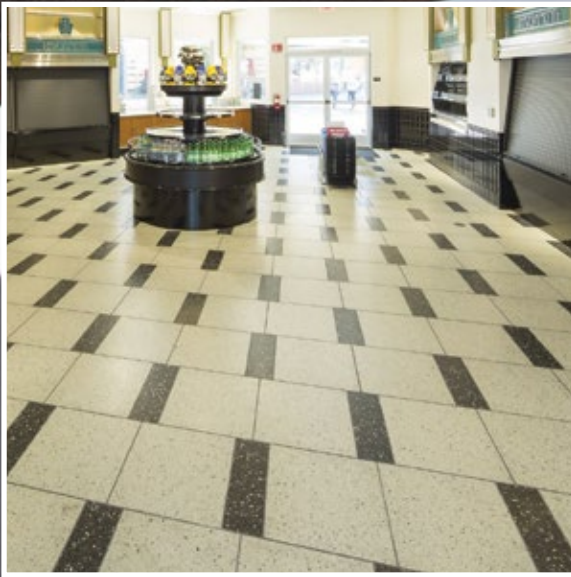

TERRAZZO TILE



ARCHITECTURAL PAVERS

TO VIEW OUR ENTIRE PRODUCT LINE VISIT WAUSAUTILE.COM