

EARTHWISE[™]
The Clean Air Choice



OPERATOR'S MANUAL

ELECTRIC CONVERTIBLE 2 IN 1 POLE SAW / CHAIN SAW

This product is covered by U.S. patents and other international patents

Copyright. All Rights Reserved.

CVPS41008

CVPS41010

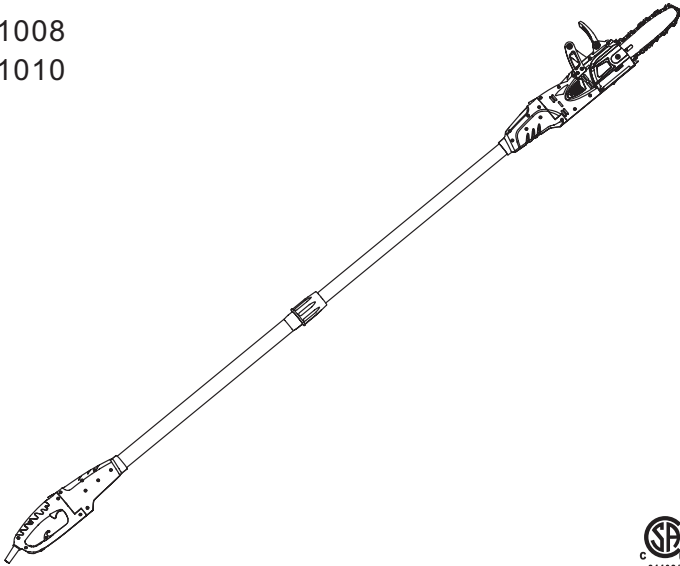

This product has been engineered and manufactured to our high standard for dependability, ease of operation, and operator safety. Properly cared for, it will give you years of rugged, trouble-free performance.



WARNING: To reduce the risk of injury, the user must read and understand the operator's manual before using this product.

Thank you for your purchase.

DO NOT RETURN THIS PRODUCT TO THE STORE. OPERATING, ASSEMBLY, PARTS, SERVICE QUESTIONS? CALL 1-800-313-5111 BETWEEN 7:30AM- 4:30PM EST FOR ASSISTANCE.

SAVE THIS MANUAL FOR FUTURE REFERENCE

⚠ IMPORTANT SAFETY WARNINGS ⚠

TO REDUCE RISK OF INJURY:

Before any use, be sure everyone using this tool reads and understands all safety instructions and other information contained in this manual.

- ⚠ **CAUTION:** Wear appropriate personal hearing protection during use. Under some conditions and duration of use, noise from this product may contribute to hearing loss.

AVOID DANGEROUS ENVIRONMENTS – Don't use the saw in rain, damp or wet locations. Do not operate the saw in gaseous or explosive atmospheres. Motors in these tools normally spark, and the sparks might ignite fumes.

DRESS PROPERLY – Don't wear loose clothing or jewelry. Wear protective hair covering to contain long hair. They can be caught in moving parts. Use of rubber gloves and substantial footwear is recommended when working outdoors.

USE SAFETY GLASSES – Wear safety glasses with side shields or goggles that are marked to comply with ANSI Z87.1 standard when operating this product. Use face or dust mask if environment is dusty.

- ⚠ **DANGER:** Risk of cut. Keep hands away from chain. Keep both hands securely on pole and/or handles when power is on.

USE RIGHT APPLIANCE – Do not use appliance for any job except that for which it is intended.

GROUND FAULT CIRCUIT INTERRUPTER (GFCI) protection should be provided on the circuit (s) or outlet (s) to be used. Receptacles are available having built-in GFCI protection and may be used.

EXTENSION CORD. Make sure your extension cord is in good condition. When using an extension cord be sure it is heavy enough to carry the current your product will draw. An undersized extension cord will cause a drop in line voltage resulting in loss of power and overheating. The following table shows the correct size to use depending on cord length and nameplate ampere rating. If in doubt, use the next heavier gage. The smaller the gage number, the heavier the cord.

Minimum Gage for Cord Sets		Total Length of cord in Feet			
Volts		0-25	26-50	51-100	101-150
120V					
Ampere Rating		American wire Gage			
More Than	Not More Than				
0	- 6	18	16	16	14
6	- 10	18	16	14	12
10	- 12	16	16	14	12

- ⚠ **WARNING:** Use outdoor extension cords marked SW-A, SOW-A, STW-A, STOW-A, SJW-A, SJTW-A, or SJTOWA. These cords are rated for outdoor use and reduce the risk of electric shock.

DOUBLE INSULATION – Double Insulation is a concept in safety in electric power tools, which eliminates the need for the usual three-wire grounded power cord. All exposed metal parts are isolated from the internal metal motor components with protecting insulation. Double insulated tools do not need to be grounded.

NOTE: The double insulated system is intended to protect the user from shock resulting from a break in the tool's internal insulation. Observe all normal safety precautions to avoid electrical shock.

USE HEAD AND FACE PROTECTION: Wear a safety hard hat with a full face shield that meets the ANSI Standards ANSI Z89.1 or CE Standards while operating chain saws.

Save these instructions and review frequently prior to use and in instructing others.

- ⚠ **WARNING:** When using electric gardening appliances, basic safety precautions should always be followed to reduce risk of fire, electric shock, and personal injury.

READ ALL INSTRUCTIONS

ELECTRICAL

- ⚠ **CAUTION:** Never stand under the limb being trimmed. Position yourself out of the way of falling debris

It is possible to tie the extension cord and power cord in a knot to prevent them from becoming disconnected during use. Make the knot as shown, then connect the plug end of the power cord into the receptacle end of the extension cord. This method can also be used to tie two extension cords together.



DISCONNECT from the power supply when not in use or when servicing or cleaning. Do not leave unattended.

AVOID UNINTENTIONAL STARTING – Don't carry saw with finger on switch. Be sure switch is off before plugging in.

CAUTION: Never carry pole saw with one hand. Doing so could cause saw to become unbalanced and damage may occur. Failure to heed this warning can result in serious personal injury.

- ⚠ **CAUTION:** Never use guard as a handle. Never grasp the unit by the guard. Failure to heed this warning can result in serious personal injury.

KEEP CHILDREN AWAY - All visitors, children and pets should stay at a safe distance from the work area. Never allow children to operate the saw.

STORE IDLE SAW INDOORS – When not in use, the saw should be stored indoors in a dry and high or locked-up place, out of reach of children.

DO NOT ATTEMPT to remove cut material or hold material to be cut when saw is on and the chain is moving. Make sure switch is off when clearing jammed material from chain. Do not grasp the exposed cutting edges when picking up or holding the saw.

- ⚠ **CAUTION:** Chain coasts after turned off.

DON'T FORCE SAW – It will do the job better and with less likelihood of a risk of injury at the rate for which it was designed.

STAY ALERT – Watch what you are doing. Use common sense. Do not operate saw when you are tired or under the influence of medications, drugs or alcohol.

- ⚠ **DANGER:** If chain jams on any electrical cord or line, DO NOT TOUCH THE BAR AND CHAIN! THEY CAN BECOME ELECTRICALLY LIVE AND VERY DANGEROUS. Release the unit in the safest manner possible. Disconnect the damaged electrical cord or line from the power source. If possible, do so safely. If in doubt, call an electrician or the electrical contractor for assistance. Failure to heed this Danger will result in serious personal injury and possible death.

LIGHTING - Only operate saw in daylight or good artificial light.

DON'T OVERREACH – Keep proper footing and balance at all times.

Make sure power source is removed when clearing jammed material from chain.

CHECK DAMAGED PARTS – Before further use of the pole saw, any part that is damaged should be carefully checked to determine that it will operate properly and perform its intended function. Check for alignment of moving parts, binding of moving parts, breakage of parts, mounting and any other condition that may affect its operation. Any part that is damaged should be properly repaired or replaced. Call our customer service help line at 1- 800- 313- 5111 for assistance.

GENERAL SAFETY

Always wear ear plugs or muffs to protect your hearing. Regular users should have hearing checked regularly as chain saw noise can damage hearing.

MAINTAIN SAW WITH CARE – Keep cutters sharp and clean for best performance and to reduce the risk of injury. Keep pole and handle dry, clean and free from oil and grease.

⚠ WARNING: To protect yourself from electrocution maintain a min. distance of 10ft (3m) from all electrical lines.

⚠ POLARIZED PLUGS – To reduce the risk of electric shock, this equipment has a polarized plug (one blade is wider than the other). This equipment must be used with a suitable polarized 2 wire or 3 wire extension cord. Polarized connections will fit together only one way. Make sure that the receptacle end of the extension cord has large and small blade slot widths. If the plug does not fit fully into the extension cord, reverse the plug. If it still does not fit, obtain a suitable extension cord. If the extension cord does not fit fully into the outlet, contact a qualified electrician to install the proper outlet. Do not change the tool plug or extension cord in any way.

⚠ WARNING: Some dust and debris created by the use of this tool could contain chemicals known to the State of California to cause cancer and birth defects or other reproductive harm. Some examples of these chemicals are:

- * chemicals in fertilizers
- * compounds in insecticides, herbicides and pesticides
- * arsenic and chromium from chemically treated lumber.

Your risk from exposure to these chemicals varies, depending on how often you do this type of work. To reduce your exposure, work in a well-ventilated area and with approved safety equipment, such as dust masks that are specially designed to filter out microscopic particles.

⚠ WARNING: California Proposition 65:
This product contains chemicals known to the State of California to cause cancer, birth defects or other reproductive harm.

ASSEMBLY

UNPACKING

This product requires assembly.

Carefully remove the product and any accessories from the box. Make sure that all items listed in the packing list are included.

Inspect the product carefully to make sure no breakage or damage occurred during shipping.

Do not discard the packing material until you have carefully inspected and satisfactorily operated the product.

PACKING LIST

- Chain saw w/chain and bar
- Telescoping pole
- Instruction Manual
- Blade cover

⚠ WARNING: If any parts are damaged or missing do not operate this product until the parts are replaced. Failure to heed this warning could result in serious personal injury. Call 1-800-313-5111 for assistance.

POLE ASSEMBLY:

Remove rubber caps from the upper and lower pole sections. Hold the two sections of the pole as shown with the arrows facing up. Insert the upper pole section into the connector on the lower pole section until you hear the sections click together. Make sure the two sections are securely assembled by stretching the pole out and drawing it back several times.

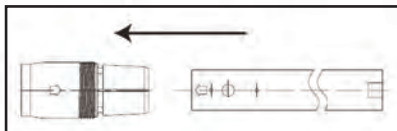

CONVERTING FROM CHAIN SAW TO POLE SAW.

Pull the release latch located on the handle assembly backwards in the direction of the handle. (see Fig 1.) Slide the handle downwards. (Fig. 2). Connect the handle to the rear of the telescopic pole and the cutting head to the front end of the pole. Make sure the release latch snaps in to lock the parts securely.



Fig. 1

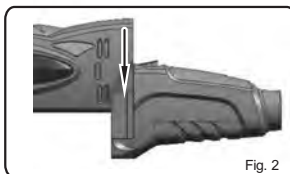

Fig. 2

CONVERTING FROM POLE SAW TO CHAIN SAW.

The electric chainsaw is a separate operating unit when not assembled to the telescopic pole.

Disconnect handle and cutting head from ends of telescopic pole as per the instructions provided.

Connect the handle directly to the cutting head by aligning the grooves and pulling upward. The release latch must snap in, firmly and securely locking the parts together.

ADJUSTING LENGTH OF TELESCOPIC POLE

To adjust the telescoping pole disconnect the saw from the power supply. Rotate the collar counterclockwise to loosen. Extend the pole to the desired length.

NOTE: Only extend the pole to minimum length required to reach the limb to be cut.

Lock the pole in position by turning the collar clockwise until firmly hand tight. Do not use wrench or pliers to over tighten the collar. Damage to collar and/or pole may result.

⚠ WARNING: Failure to lock telescopic pole collars as directed could result in personal injury.

INSTALLING/REPLACING THE GUIDE BAR AND CHAIN

⚠ DANGER: Never start the motor before installing the guide bar, chain and chain cover. Without all these parts in place, the clutch can fly off or explode, exposing the user to possible serious injury.

⚠ WARNING: To avoid serious personal injury, read and understand all the safety instructions provided.

⚠ WARNING: Before performing any maintenance, make sure the tool is unplugged from the power supply. Failure to heed this warning could result in serious personal injury.

⚠ CAUTION: Always wear gloves when handling the bar and chain; these components are sharp and may contain burrs.

⚠ WARNING: Never touch or adjust the chain while the motor is running. The saw chain is very sharp; always wear protective gloves when performing maintenance to the chain to avoid possible serious lacerations.

NOTE: When replacing the guide bar and chain, use only identical replacement parts.

- Disconnect pole saw from power supply
- Loosen the guide bar screw. (1)
- Remove the chain cover. (2)
- Remove the bar and chain from the mounting surface. (3)
- Remove the old chain from the bar.
- Lay out the new saw chain in a loop and straighten any kinks. The cutters should face in the direction of the chain rotation. If they face backwards, turn the loop over. (4)
- Place the chain drive links into the bar groove.

⚠ NOTE: Make certain of the direction of chain.

- Position the chain so there is a loop at the back of the bar. (5)
- Hold the chain in position on the bar and place the loop around the sprocket.

- Fit the bar flush against the mounting surface so that the bar studs are in the long slot of the bar. (6)

NOTE: When placing the bar on the bar studs, ensure that the adjusting pin is in the chain tension pin hole.

- Tighten the chain tensioner. (7)

- Replace the chain cover.

- Tighten the guide bar screw, but leave the bar free to move for tension adjustment. (8)

- Remove all slack from the chain by turning the chain tensioner clockwise until the chain seats snugly against the bar with the drive links in the bar groove. (9)

- Tighten the guide bar screw. (10)

The chain is correctly tensioned when there is no sag on the underside of the guide bar, the chain is snug, but it can be turned by hand without binding.

NOTE: If chain is too tight, it will not rotate. Loosen the guide bar screw slightly and turn the chain tensioner 1/4 turn counterclockwise. Lift the tip of the guide bar up and retighten the guide bar screw. Ensure that the chain will rotate without binding.

NOTE: A new chain tends to stretch, check chain tension frequently and tension as required.

INSTALLING/REPLACING THE GUIDE BAR AND CHAIN

Step 1



Step 2



Step 3



Step 4

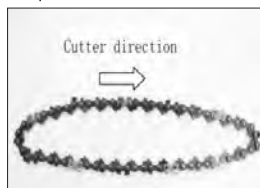

Step 5



Step 6



Step 7



Step 8



Step 9



Step 10



OPERATING

CHAIN TENSION AND MAINTENANCE

CHAIN TENSION

Stop the motor before setting the chain tension. Make sure the guide bar screw is loosened to finger tight, turn the chain tensioner clockwise to tension the chain. A cold chain will be correctly tensioned when there is no slack on the underside of the guide bar, the chain is snug, but it can be turned by hand without binding.

Chain must be re-tensioned whenever the flats on the drive links hang out of the bar groove.

During normal saw operation, the temperature of the chain will increase. The drive links of a correctly tensioned warm chain will hang approximately .050 in. (1.25mm) out of the bar groove. Be aware that chain tensioned while warm, may be too tight upon cooling. Check the "cold tension" before next use.

NOTE: A new chain tends to stretch, check chain tension frequently and tension as required.



CHAIN MAINTENANCE

CAUTION: Disconnect from the power supply and make sure the chain has stopped before you do any work on the saw.

For smooth and fast cutting, chain needs to be maintained properly. The chain requires sharpening when the wood chips are small and powdery, the chain must be forced through the wood during cutting, or the chain cuts to one side. During maintenance of your chain remember:

- Improper filing angle of the side plate can increase the risk of severe kickback.
- Raker (depth gauge) clearance.
- Too low increases the potential for kickback.
- Not low enough decreases cutting ability.
- If cutter teeth have hit hard objects such as nails and stones, or have been abraded by mud or sand on the wood, have service dealer sharpen chain.

NOTE: Inspect the drive sprocket for wear or damage when replacing the chain. If signs of wear or damage are present in the areas indicated, have the drive sprocket replaced by an authorized service dealer.

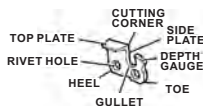

HOW TO SHARPEN THE CUTTERS

Be careful to file all cutters to the specified angles and to the same length, as fast cutting can be obtained only when all cutters are uniform.

Wear gloves for protection. Properly tension the chain prior to sharpening. Refer to "Chain Tension Section" earlier in this manual. Do all of your filing at the midpoint of the bar.

Use a 5/32 in. diameter round file and holder.

Keep the file level with the top plate of the tooth. Do not let the file dip or rock. Using light but firm pressure, stroke towards the front corner of the tooth.

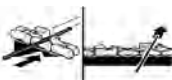

Lift file away from the steel on each return stroke.

Put a few firm strokes on every tooth. File all left hand cutters in one direction. Then move to the other side and file the right hand cutters in the opposite direction. Occasionally remove filings from the file with a wire brush.



WARNING: Improper chain sharpening increases the potential of kickback.

WARNING: Failure to replace or repair damaged chain can cause serious injury.

WARNING: The saw chain is very sharp, always wear protective gloves when performing maintenance to the chain.

TOP PLATE FILING ANGLE

Correct 30 degrees – File holders are marked with guide marks to align file properly to produce top plate angle.

Less than 30 degrees – for cross cutting.

More than 30 degrees – feathered edge dulls quickly.

SIDE PLATE ANGLE

Correct – 80 degrees produced automatically if correct diameter file is used in file holder.

Hook – "Grabs" and dulls quickly. Increases potential of kickback. Results from using a file with a diameter too small, or file held to low.

Backward Slope – Needs too much feed pressure, causes excessive wear to bar and chain. Results from using a file with a diameter too large, or file held too high.

DEPTH GAUGE CLEARANCE

The depth gauge should be maintained at a clearance of .025 in. (0.6 mm). Use a depth gauge tool for checking the depth gauge clearances.

Every time the chain is filed, check the depth gauge clearance.

Use a flat file and a depth gauge jointer to lower all gauges uniformly. Depth gauge jointers are available in .020 in. to .035 in. (0.5 mm to 0.9 mm). Use a .025 in. (0.6 mm) depth gauge jointer. After lowering each depth gauge, restore original shape by rounding the front. Be careful not to damage adjoining drive links with the edge of the file.

Depth gauges must be adjusted with the flat file in the same direction the adjoining cutter was filed with the round file. Use care not to contact cutter face with flat file when adjusting depth gauges.

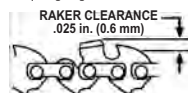
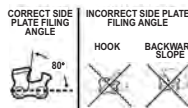
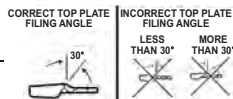

OPERATING

Before you start the unit, make sure the chain and bar are not contacting any object.

TO TURN THE TOOL ON

Push the lock off button in with your thumb and then squeeze the trigger with your fingers. (Once the tool is running, you can release the lock off button.) To turn the tool OFF, release the trigger.

DO NOT PULL the trigger until you are ready to make a cut.

- ⚠ WARNING:** To guard against injury, observe the following: Read instruction manual before using, save instruction manual. Keep hands away from chain. Keep hands on handles. Don't overreach.

A good, firm grip on the pole and/or handles with both hands will help you maintain control. When using the chain saw place your right hand on the rear handle and your left hand on the front handle with your thumbs and fingers encircling the chain saw handles. A firm grip together with a stiff left arm will help you maintain control of the saw if kickback occurs. When using as a pole saw place one hand on the pole and your other hand on the moked handle with your thumbs and fingers encircling the pole and handle. A firm grip together with positioning handle against your body will help you maintain control of the saw. Don't let go.

- ⚠ WARNING:** Do not operate saw in a tree, on a ladder, or on a scaffold; this is extremely dangerous.

- ⚠ CAUTION:** Chain coasts after turned off. Do not use under wet conditions.

Use extreme caution when cutting small size brush, saplings or limbs under tension, because slender and tense material may catch the saw and be whipped toward you, pull you off balance or spring back.

Do not use saw to cut vines and/or small underbrush.

- ⚠ WARNING:** Do not allow familiarity with this type of tool to make you careless. Remember that a careless fraction of a second is sufficient to inflict serious injury.

- ⚠ WARNING:** Do not cut trees near electrical wires or buildings.

- ⚠ CAUTION:** Failure to lubricate the chain will cause damage to the bar and chain. Use only a good quality bar and chain oil, or if unavailable, unused SAE 30 weight motor oil may be substituted. One minute of use will consume approx. 0.15 fl. oz. (5ml) of oil.

NOTE: It is normal for oil to seep from the saw when not in use. To prevent seepage, empty the oil tank after each use. When storing the unit for a long period of time (3 months or longer) be sure the chain is lightly lubricated; this will prevent rust on the chain and bar sprocket.

- ⚠ WARNING:** Do Not use the saw with any type of accessory or attachment. Such usage might be hazardous.

- ⚠ WARNING:** Be aware of the cord while operating the saw. Keep the cord away from the chain. Be careful not to trip over the extension cord.

- ⚠ WARNING:** Kickback may occur when the moving chain contacts an object at the upper portion of the tip of the guide bar or when the wood closes in and pinches the chain saw in the cut. Contact at the upper portion of the tip of the guide bar can cause the chain to dig into the object and stop the chain for an instant. The result is a lightning fast, reverse reaction which kicks the guide bar up and back toward the operator. If the chain saw is pinched along the top of the guide bar, the guide bar can be driven rapidly back toward the operator. Either of these reactions can cause loss of saw control which can cause the operator to be thrown off balance and result in serious injury. Do not rely exclusively upon the safety devices built into the saw. As a user, you should take several precautions to keep your cutting jobs free from accident or injury.

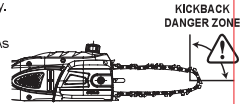

OPERATING INSTRUCTIONS

The following precautions should be followed to minimize kickback:

1. Always grip the pole and/or handles firmly with both hands when unit is running. When using the chain saw place your right hand on the rear handle and your left hand on the front handle with your thumbs and fingers encircling the chain saw handles. When using as a pole saw place one hand on the pole and your other hand on the molded handle with your thumbs and fingers encircling the pole and handle. A firm grip together with positioning handle against your body will help you maintain control of the saw if kickback occurs.
2. Make sure that the area in which you are cutting is free from obstructions. Do not let the nose of the guide bar contact a log, branch, fence or any other obstruction that could be hit while you are operating the saw.
3. Always cut with the unit running at full speed. Fully squeeze the throttle trigger and maintain a steady cutting speed.
4. To protect yourself from electrocution, do not operate within 50ft. of overhead power lines.
5. Wear non-slip gloves for maximum grip and protection.

Proper Cutting Stance

Weight should be balanced with both feet on solid ground.

Keep left arm with elbow locked in a "straight arm" position to withstand any kickback force when using pole saw. Your right hand should be gripping the handle and positioned firmly against your body for added support.

Your body should always be to the left of the chain line.

Basic Cutting Procedure

Do not use the pole saw to fell saplings. Use the chain saw without the pole attachment.

Small trees up to 6-7 inches in diameter are usually cut in a single cut. Large tree limbs require notch cuts. Notch cuts determine the direction the tree will fall.

⚠ WARNING: If the tree limb starts to fall in the wrong direction, or if the saw gets caught or hung up during the fall, leave the saw and save yourself.

⚠ WARNING: Periodically glance at the top of the tree during the back-cut to assure the tree limb is going to fall in the desired direction.

Practice cutting a few small limbs using the following technique to get the "feel" of using the saw before you begin a major sawing operation.

Take the proper stance in front of the wood with the saw in the "off" position.

Squeeze the trigger and let the chain accelerate to full speed before entering the cut.

Always hold the saw firmly with both hands.

Keep the unit running the entire time you are cutting, maintain a steady speed.

Allow the chain to cut for you; exert only light downward pressure. If you force the cut, damage to the bar, chain, or unit can result.

Do not put pressure on the saw at the end of the cut.

When felling the top of a small tree, keep everyone a safe distance from the cutting area. During felling operations, the safe distance should be at least twice the height of the largest trees in the felling area. If the tree makes contact with any utility line, the utility company should be notified immediately.

Always cut with both feet on solid ground to prevent being pulled or knocked off balance.

Do not extend arms above shoulder level when operating the pole saw.

Do not cut above chest height when using the chain saw.

FELLING A TREE

When bucking and felling operations are being performed by two or more persons, at the same time, the felling operation should be separated from the bucking operation by a distance of at least twice the height of the tree being felled. Trees should not be felled in a manner that would endanger any person, strike any utility line or cause any property damage. If the tree does make contact with any utility line, the utility company should be notified immediately.

⚠ WARNING: Check the tree for damaged or dead branches that could fall and hit you during felling.

Before any cuts are started, pick your escape route (or routes in case the intended route is blocked); clear the immediate area around the tree and make sure there are no obstructions in your planned path of retreat. A clear path of safe retreat is approximately 135 degrees from planned line of fall. The retreat path should extend back and diagonally to the rear of the expected line of fall.

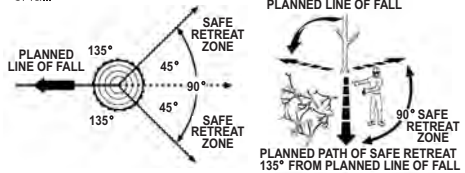

Before felling is started, consider the force and direction of the wind, the lean and balance of the tree, and the location of large limbs. These things influence the direction in which the tree will fall. Do not try to fell a tree along a line different from its natural line of fall.

The saw operator should keep on the uphill side of the terrain as the tree is likely to roll or slide downhill after it is felled.

Remove dirt, stones, loose bark, nails, staples, and wire from the tree where felling cuts are to be made.

NOTCHED UNDERCUT – Cut a notch about 1/3 diameter of the tree, perpendicular to the direction of the fall. Make the cuts of the notch so they intersect at a right angle to the line of fall. This notch should be cleaned out to leave a straight line. To keep the weight of the wood off the saw, always make the lower cut of the notch before the upper cut.

⚠ WARNING: Do not fell trees during periods of high wind or heavy precipitation. Wait to do your cutting until the hazard has ended.

⚠ WARNING: Do not cut down trees having an extreme lean or large trees that have rotten limbs, loose bark, or hollow trunks. Have these trees pushed or dragged down with heavy equipment, then cut them up.

FELLING BACK-CUT

The back-cut is always made level and horizontal, and at a minimum of 2 inches (5cm) above the horizontal cut of the notch.

Never cut through to the notch. Always leave a band of wood between the notch and back-cut (approximately 2 inches (5cm) or 1/10 the diameter of the tree). This is called "hinge" or "hinge wood." It controls the fall of the tree and prevents slipping or twisting or shoot-back of the tree off the stump.

This saw is not designed to fell large diameter tree tops, or tree trunks.

OPERATING

CUTTING INSTRUCTIONS

As the tree limb starts to fall, stop the saw and immediately retreat along the cleared path. Watch the action in case something falls your way. Be alert for overhead limbs or branches that may fall and watch your footing.

- ⚠ WARNING:** Never cut through to the notch when making a back-cut. The hinge controls the fall of the tree, this is a section of wood between the notch and back-cut.



BUCKING

Bucking is the term used for cutting a fallen tree to the desired log length.

Always make sure your footing is secure and your weight is distributed evenly on both feet.

Cut only one log at a time. Support small logs on a saw horse or another log while bucking.

Keep a clear cutting area. Make sure that no objects can contact the guide bar nose and chain during cutting, this can cause kickback.

When bucking on a slope, always stand on the uphill side of the log. When "cutting through," to maintain complete control of the pole saw, release the cutting pressure near the end of the cut without relaxing your grip on the pole saw handles. Do not let the chain contact the ground. After completing the cut, wait for the saw chain to stop before you move the pole saw. Always stop the motor before moving from tree to tree.

BUCKING LOGS UNDER STRESS

When the log is supported along its entire length, it should be cut from the top or over-bucking.

When the log is supported on one end, cut 1/3 diameter from the underside or under-bucking. Then make the finishing cut by over-bucking to meet the first cut.

As the log is being cut, it will tend to bend. The saw can become pinched or hung in the log if you make the first cut deeper than 1/3 of the diameter of the log.

Give special attention to logs under stress to prevent the bar and chain from pinching.

OVERBUCKING – Begin on the top side of the log with the bottom of the saw against the log; exert light pressure downward. Note that the saw will tend to pull away from you.

UNDER-BUCKING – Begin on the under side of the log with the top of the saw against the log; exert light pressure upward. During under-bucking, the saw will tend to push back at you. Be prepared for this reaction and hold the saw firmly to maintain control.

LIMBING

Limbing is removing branches from a fallen tree.

Work slowly, keeping both hands on the pole saw with a firm grip. Always make sure your footing is secure and your weight is distributed evenly on both feet.

Leave the larger support limbs under the tree to keep the tree off the ground while cutting.

Limbs should be cut one at a time. Remove the cut limbs from the work area often to help keep the work area clean and safe.

Branches under tension should be cut from the bottom up to avoid binding the pole saw.

Keep the tree between you and the pole saw while limbing. Cut from the side of the tree opposite the branch you are cutting.

- ⚠ WARNING:** Never climb into a tree to limb or prune. Do not stand on ladders, platforms, a log, or in any position which can cause you to lose your balance or control of the saw.

LIMBING



CUT LIMBS ONE AT A TIME AND LEAVE SUPPORT LIMBS UNDER TREE UNTIL LOG IS CUT

PRUNING

Pruning is trimming limbs from a live tree.

Work slowly, keep both hands on the pole saw with a firm grip and the handle positioned firmly against your body for added control and ease of handling. Always make sure your footing is secure and your weight is distributed evenly on both feet.

PRUNING

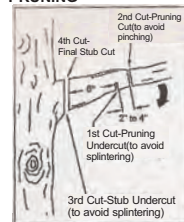

When pruning trees it is important not to make the finishing cut next to the main limb or trunk until you have cut off the limb further out to reduce the weight. This prevents stripping the bark from the main member.

Make first cut six inches from tree trunk on underside of limb. Use top of guide bar to make this cut. (Cut 1/3 through diameter of limb.)

Move two to four inches farther out on limb. Make second cut from above limb. Continue cut until you cut limb off.

Make third cut as close to tree trunk as possible on underside of limb stub. Use top of guide bar to make this cut. Cut 1/3 through diameter of stub.

Make fourth cut directly above third cut. Cut down to meet third cut. This will remove limb stub.

SPRINGPOLES

A springpole is branch, or sapling which is bent under tension by other wood so that it springs back if the wood holding it is cut or removed.

- ⚠ WARNING:** Watch out for springpoles, they are dangerous. They could result in severe or fatal injury.

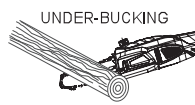
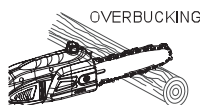

MAINTENANCE

⚠ BEFORE USING: Fill oil well with new quality bar and chain oil, or if unavailable, unused SAE 30 weight motor oil may be substituted.

If you drop the pole saw, carefully inspect it for damage. If the blade is bent, housing cracked, or handles broken or if you see any other condition that may affect the saw's operation, contact our customer service help line at 1-800-313-5111 for assistance.

Make sure the unit is disconnected from the power supply, then use only mild soap and a damp cloth to clean the tool. Never let any liquid get inside the tool; never immerse any part of the tool into a liquid.

After cleaning, apply a light coat of oil to the chain and guide bar to prevent rusting.

⚠ IMPORTANT: To assure product SAFETY and RELIABILITY, repairs, maintenance and adjustment should be performed by a qualified individual, always using identical replacement parts.

⚠ CAUTION: Do not at any time let brake fluids, gasoline, petroleum based products, penetrating oils, etc., come in contact with plastic parts. They contain chemicals that can damage, weaken or destroy plastic.

Ensure that the plastic blade cover is in place when storing.

Fertilizers and other garden chemicals contain agents which greatly accelerate the corrosion of metals. Do not store the tool on or adjacent to fertilizers or chemicals.

For smooth and fast cutting, chain needs to be maintained properly. The chain requires sharpening when the wood chips are small and powdery, the chain must be forced through the wood during cutting, or the chain cuts to one side. Refer to instructions earlier in this manual for instructions on properly sharpening the chain.

LUBRICATION SYSTEM

The chain is automatically lubricated.

Use only new bar and chain oil or unused SAE 30 weight motor oil may be substituted. Never use wasted oil, low quality oil, or insufficient oil. This could damage the pump; the bar and the chain which may result in serious personal injury.

Check oil level before each work session, refill if less than ¼ full.

If the lubrication system does not work properly, check the oil filter and that all oilways are clean and free from obstructions. If it is still not working, contact our customer service help line at 1-800-313-5111 for assistance.

GUIDE BAR MAINTENANCE

When the guide bar shows signs of wear, reverse it on the saw to distribute the wear for maximum bar life. The bar should be cleaned every day of use and checked for wear and damage.

Feathering or burring of the bar rails is a normal process of bar wear. Such faults should be smoothed with a file as soon as they occur.

A bar with any of the following faults should be replaced.

- Wear inside the bar rails which permits the chain to lay over sideways.
- Bent guide bar
- Cracked or broken rails
- Spread rails

In addition, guide bars with a sprocket at their tip must be lubricated weekly with a grease syringe to extend the guide bar life. Using a grease syringe, lubricate weekly in the lubricating hole.

Turn the guide bar and check that the lubrication holes and chain groove are free from impurities.

TROUBLESHOOTING

Problem	Possible Cause	Possible Solution
<ul style="list-style-type: none"> - Unit does not run 	<ul style="list-style-type: none"> - Extension cord not connected to the plug - Cord not connected to power source - Trigger switch not operational 	<ul style="list-style-type: none"> - Check extension cord is fully connected to tool - Check extension cord is fully connected to a live receptacle - Check that lock off button is fully depressed prior to engaging trigger switch
<ul style="list-style-type: none"> - Bar and chain running hot and smoking 	<ul style="list-style-type: none"> - Check tension for over-tight condition - Chain oil tank empty - Chain installed backwards 	<ul style="list-style-type: none"> - Adjust chain tension - Fill tank with chain oil - Reverse chain so that cutters face the right direction
<ul style="list-style-type: none"> - Motor runs but chain is not rotating 	<ul style="list-style-type: none"> - Chain tension too tight - Check guide bar and chain for damage 	<ul style="list-style-type: none"> - Adjust chain tension - Replace damaged bar and chain with identical replacement parts.

CALL US FIRST !!

Call us first with questions about operating or maintaining your pole saw at 1.800.313.5111 between 7:30 a.m. – 4:30 p.m. Eastern Standard Time, or send emails to earthwise@reelin.com.

FEATURES

PRODUCT SPECIFICATIONS

CVPS41008

Input. 120 Volt, 60 Hz, 6.5 Amp
Bar Length. 8" Oregon Bar
Weight. 8.20 lbs
Total Extended Length. 2.75m (9 ft)

CVPS41010

Input. 120 Volt, 60 Hz, 6.5 Amp
Bar Length. 10" Oregon Bar
Weight. 8.40 lbs
Total Extended Length. 2.8m (9 ft 2 in)

-Telescopic Pole-Automatic Bar and Chain Oiling

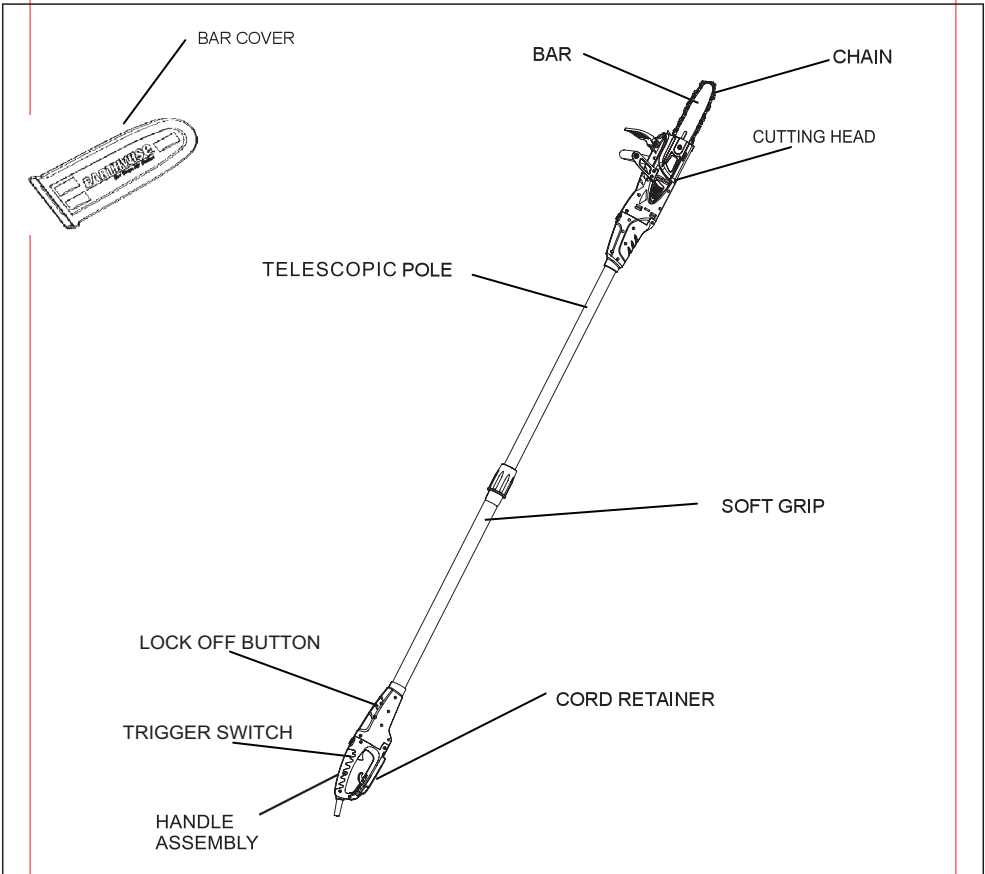

WARRANTY

LIMITED WARRANTY FOR CORDED ELECTRIC MODELS

This product is manufactured for The Great States Corporation/American Lawn Mower Company. The Great States Corporation/American Lawn Mower Company, Shelbyville, Indiana, has been making lawn mowers for over 100 years and it warrants to the original owner that each new product and service part is free from defects in material and workmanship and agrees to repair or replace under this warranty any defective product or part from the original date of purchase for two (2) years except for the conditions and circumstances listed below. Proof of purchase (original dated sales receipt) must accompany all warranty claims.

THIS WARRANTY IS NOT TRANSFERABLE AND DOES NOT COVER:

Products sold damaged or incomplete, sold "as is", sold reconditioned, or used as rental equipment.

Delivery, installation, or normal adjustments explained in the operator's manual.

Damage or liability caused by shipping, improper handling, improper installation, incorrect voltage or improper wiring, improper maintenance, improper modification, or the use of accessories and/or attachments not specifically recommended.

Repairs necessary because of operator abuse or negligence, or the failure to install, operate, maintain, or store the product according to the instructions in the operator's manual.

Damage caused by cold, heat, rain, excessive humidity, corrosive environments and materials, or other contaminants.

Expendable items that become worn during normal use.

Cosmetic defects that do not interfere with tool functionality.

Freight costs from customer to vendor.

Repair and transportation costs of products or parts determined not to be defective.

ANY INCIDENTAL, INDIRECT, OR CONSEQUENTIAL LOSS, DAMAGE, OR EXPENSE THAT MAY RESULT FROM ANY DEFECT, FAILURE, OR MALFUNCTION OF THE PRODUCT. Some states do not allow the exclusion or limitation on how long an implied warranty lasts, so the above limitations may not apply to you.

ANY NON-RESIDENTIAL USE OR COMMERCIAL USE VOIDS ALL WARRANTIES.



The Great States Corporation
American Lawn Mower Company
830 Webster Street
Shelbyville, IN 46176
Phone 1-800-313-5111
www.americanlawnmower.com

In a continued commitment to improve quality, the Manufacturer reserves the right to make component changes or design changes when necessary.