

# DOREL ASIA

---

*Eddie Bauer*  
FIRSTADVENTURE

## Hayworth Crib

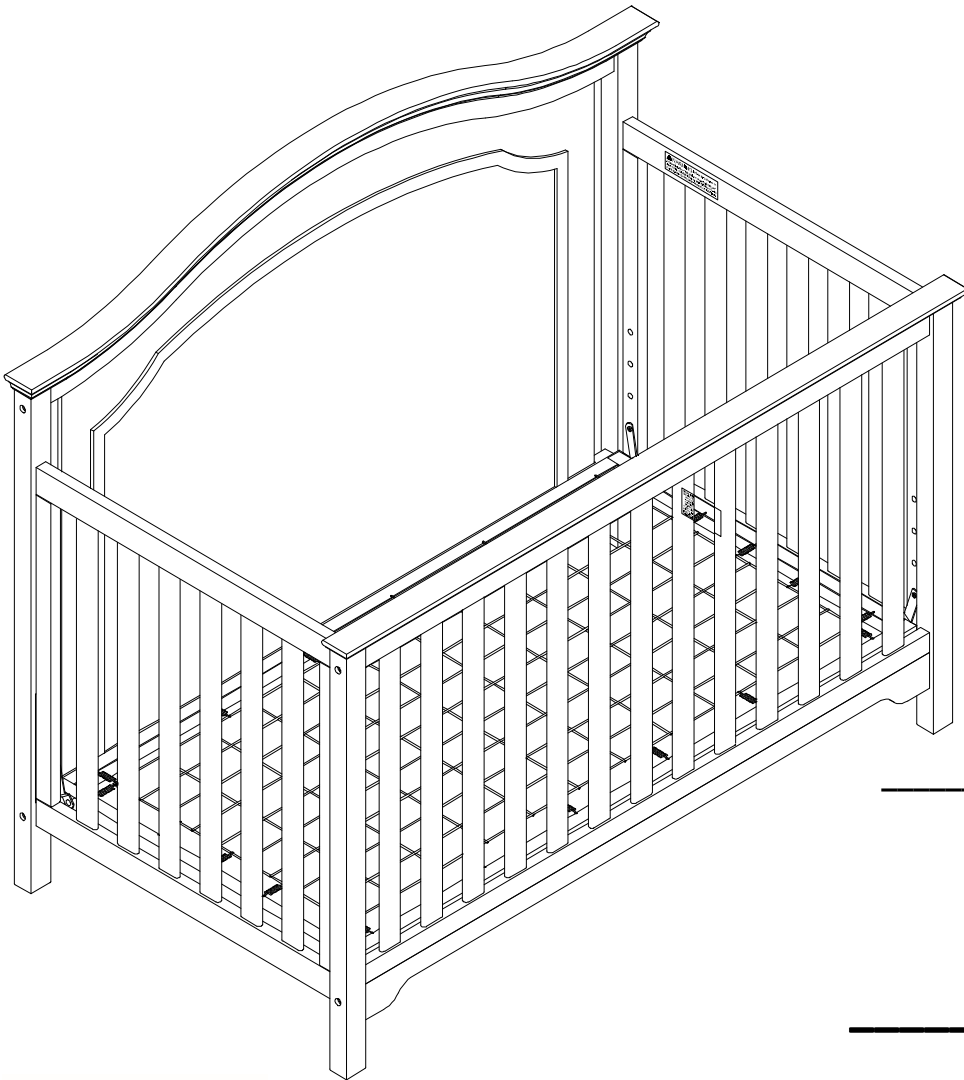

**Model No:**

DA7249 (Weathered Walnut)

DA7249W (White)

**UPC CODE:**

0-65857-16963-8

0-65857-16965-2

**DPCI#:**

030-08-2599

030-08-2602

**Lot number:**

(TAKEN FROM CARTON)

**Date of purchase:**

\_\_\_\_ / \_\_\_\_ / \_\_\_\_

**DO NOT RETURN PRODUCT TO THE STORE.**  
If a part is missing or damaged, contact our customer service department. We will replace the part **FREE** of charge.



Tel #: 1-800-295-1980

E-Mail: [das@dorel.com](mailto:das@dorel.com)

Fax #: 514-353-7819



## CUSTOMER SERVICE

If you are missing parts or have any questions about this product, contact our customer service representative first!



**CALL 1-800-295-1980**

You can also order parts by writing to the address listed below. Please include the product model number, color and a detailed description of the part.

**Customer Service Department No. 413  
12345 Albert-Hudon Boulevard, Suite 100  
Montreal, Quebec  
Canada, H1G 3L1**

**E-MAIL: [das@dorel.com](mailto:das@dorel.com)**



## WARNING

- \* Failure to follow these warnings and assembly instructions could result in serious injury or
- \* Read all instructions before assembling crib. **KEEP INSTRUCTIONS FOR FUTURE USE.**
- \* Check this product for damaged hardware, loose joints, loose bolts or other fasteners, missing parts or sharp edges before assembly and frequently during use. Securely tighten loose bolts and other fasteners. **DO NOT** use crib if any parts are missing, damaged or broken. Contact a customer service representative at 1-800-295-1980 for replacement parts and instructional literature if needed. **DO NOT** substitute parts.
- \* Infants can suffocate on soft bedding. Never add a pillow or comforter. Never place additional padding under an infant.
- \* Stop using crib when child begins to climb out or reaches the height of 35 inches (89 cm).
- \* To reduce the risk of SIDS, pediatricians recommend healthy infants be placed on their backs to sleep, unless otherwise advised by your physician.
- \* **DO NOT** place crib near window where cords from blinds or drapes may strangle a child.
- \* Strings can cause strangulation! **DO NOT** place crib with a string around a child's neck, such as hood strings or pacifier cords. **DO NOT** suspend strings over a crib or attach strings to toys.
- \* To help prevent strangulation tighten all fasteners. A child can trap parts of the body or clothing on loose fasteners.
- \* If refinishing, use a non-toxic finish specified for children's products.
- \* When child is able to pull to standing position, set mattress to lowest position and remove bumper pads, large toys and other objects that could serve as steps for climbing out.
- \* Never use plastic shipping bags or other plastic film as mattress covers because they can cause suffocation.
- \* Replace teething rail if damaged or loose (if teething rail is provided for this model).
- \* **CAUTION: ANY MATTRESS USED IN THIS CRIB MUST BE AT LEAST 27-1/4 INCHES BY 51-5/8 INCHES (69CM BY 131CM) WITH A THICKNESS NOT EXCEEDING 6 INCHES (15CM).**
- \* Infants can suffocate in gaps between crib sides and a mattress that is too small.
- \* The **TODDLER BED** or **DAY BED** is not intended for children under 15 months of age or over 50 pounds (22.7kgs).
- \* If guardrails are used as the mattress containment means, guardrail(s) provided must be used to avoid the formation of a gap between the mattress and the bed that could cause an entrapment (when product is used as a **TODDLER BED** or **DAY BED**).
- \* **CAUTION: ENTRAPMENT HAZARD.** To avoid dangerous gaps, any mattress used on this bed shall be a full-size crib mattress at least 51-5/8 inches (1310 mm) in length, 27-1/4 inches (690 mm) in width, and a max thickness of 6 inches (150 mm).
- \* Follow warnings on all products in a crib.

# NOTES

- \* Ensure all parts and components are present before beginning assembly.
- \* Assemble on a soft, smooth surface to prevent damage to product finish.
- \* Phillips head screwdriver is not included.
- \* **DO NOT** use power tools.
- \* **CAUTIONS:** Adult assembly required.
- \* Assembly will require two people.
- \* Estimated assembly time: 30 minutes.

## CARE AND CLEANING

Dust regularly with a soft, lint-free cloth to prevent soil build-up. A damp cloth may be used occasionally to clean surface. Dry immediately. Do not use any abrasives that may damage finish. Excessive exposure to sunlight and extreme changes in temperature and moisture can damage wood furniture.

## MAINTENANCE

Check bolts/screws periodically and tighten them if necessary.

## LIMITED WARRANTY

DOREL ASIA warrants its product to be free from defects in material and workmanship and agrees to remedy any such defect. This warranty covers 1 year from the date of original purchase. This warranty is valid only upon presentation of proof of purchase. This is solely limited to the repair or replacement of defective furniture components and no assembly labor is included. This warranty does not apply to any product which has been improperly assembled, subjected to misuse or abuse or which has been altered or repaired in any way. This warranty gives you specific legal rights and you may also have other rights which vary from State to State.







**WARNING: Should this product become damaged, and/or components are broken or missing, DO NOT USE.**

# Hayworth Crib

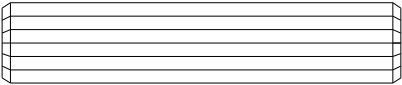
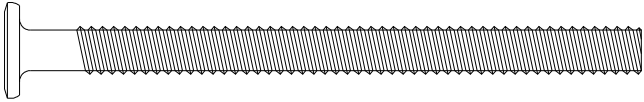
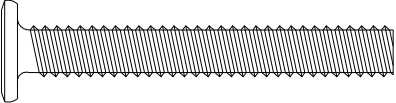
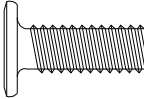

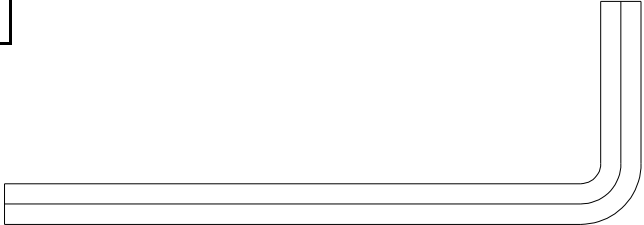

## DA7249 / DA7249W

### HARDWARE LIST

1	 Ø10mm x 50mm <b>WOOD DOWEL</b> <b>20 PCS</b>	2	 Ø1/4" x 3-1/8" <b>BOLT</b> <b>12 PCS</b>
3	 Ø1/4" x 1-3/4" <b>BOLT</b> <b>6 PCS</b>	4	 Ø1/4" x 1/2" <b>MATTRESS SUPPORT BOLT</b> <b>16 PCS</b>
5	 Ø6mm x 10mm x 1.2mm <b>SPRING WASHER</b> <b>16 PCS</b>	6	 4mm <b>ALLEN KEY</b> <b>1 PC</b>
7	 Ø8mm x 13mm x 1.5mm <b>SPRING WASHER</b> <b>18 PCS</b>		

# Hayworth Crib DA7249 / DA7249W

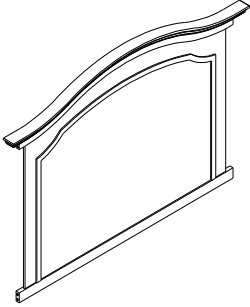
## PARTS LIST

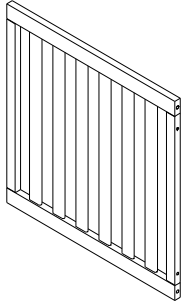
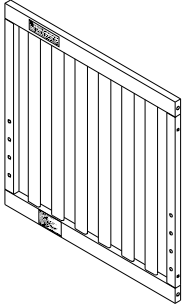
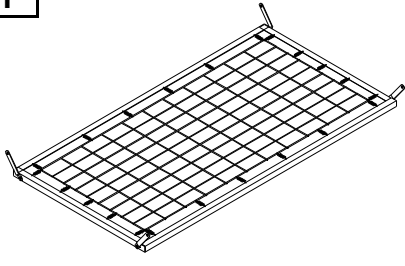
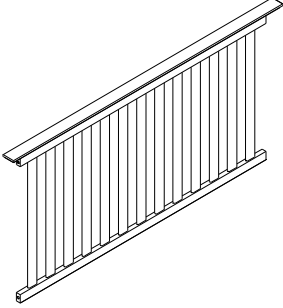
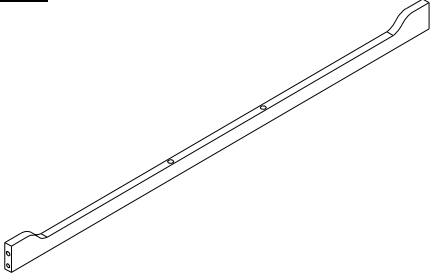
<p><b>A</b></p> 	<p><b>B</b></p> 	<p><b>C</b></p> 
<p><b>LEFT BACK POST 1 PC</b></p>	<p><b>RIGHT BACK POST 1 PC</b></p>	<p><b>BACK PANEL 1 PC</b></p>
<p><b>D</b></p> 	<p><b>E</b></p> 	<p><b>F</b></p> 
<p><b>LEFT FRONT POST 1 PC</b></p>	<p><b>RIGHT FRONT POST 1 PC</b></p>	<p><b>LEFT SIDE PANEL 1 PC</b></p>
<p><b>G</b></p> 	<p><b>H</b></p> 	<p><b>I</b></p> 
<p><b>RIGHT SIDE PANEL 1 PC</b></p>	<p><b>MATTRESS SUPPORT 1 PC</b></p>	<p><b>FRONT PANEL 1 PC</b></p>
<p><b>J</b></p>  <p><b>FRONT RAIL 1 PC</b></p>		

# Hayworth Crib DA7249 / DA7249W

## STEP 1:

Insert the wood dowels (1) into the back panel (C).  
Attach the left and right back posts (A & B) to the back panel (C) with bolts (2) and spring washers (7) as shown. Use Allen key (6) to tighten the bolts.

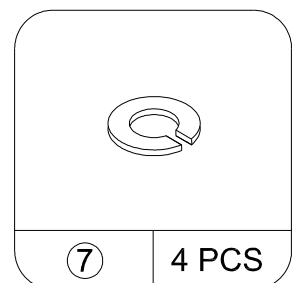
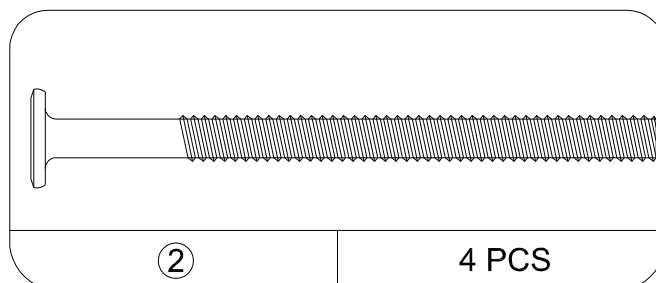
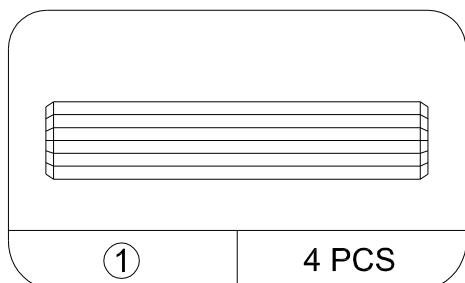
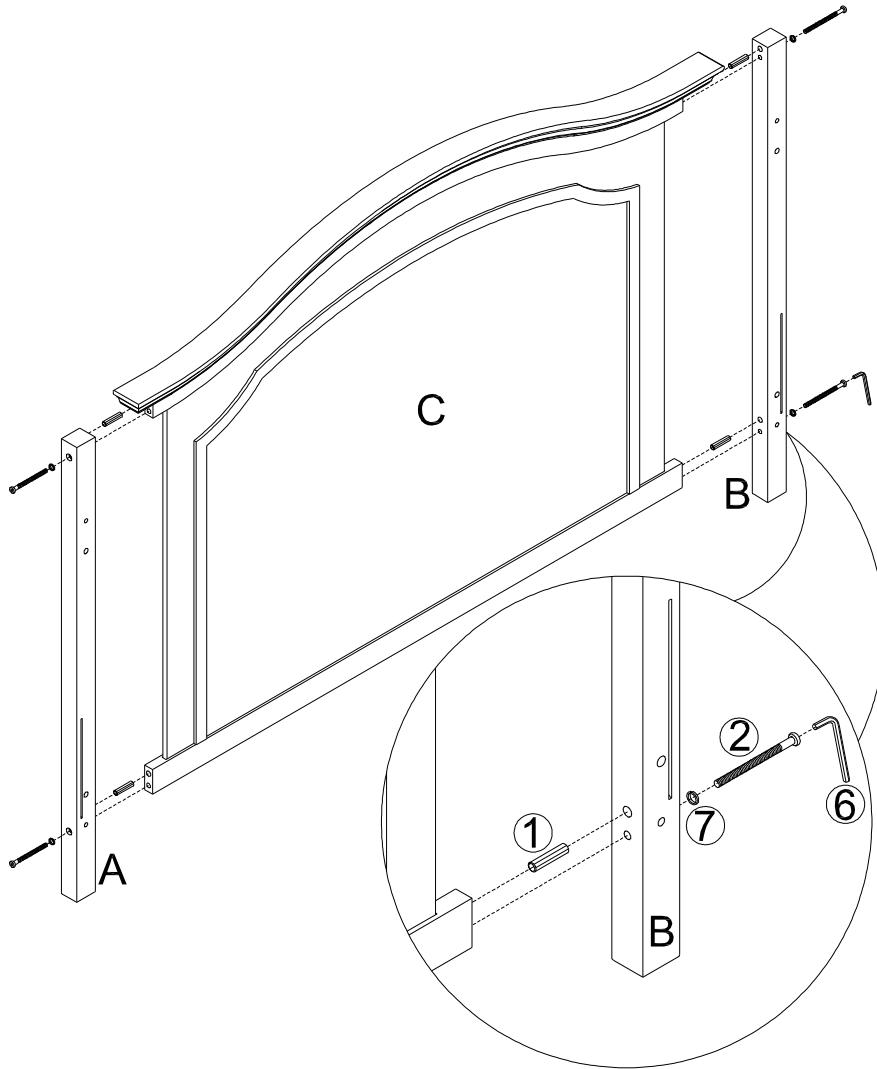

# Hayworth Crib DA7249 / DA7249W

## STEP 2:

Insert the wood dowels (1) into the left and right side panels (F & G). Attach the left and right front posts (D & E) to the side panels (F & G) with bolts (3) and spring washers (7) as shown. Use Allen key (6) to tighten the bolts.

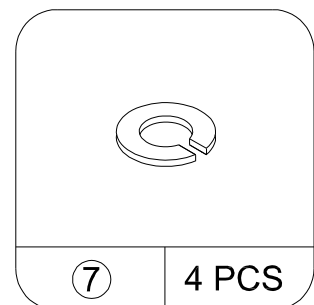
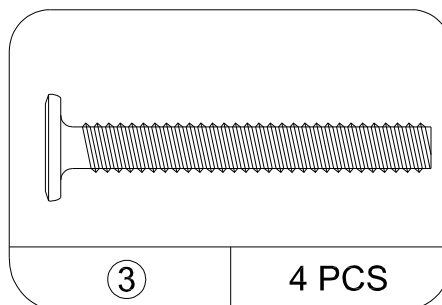
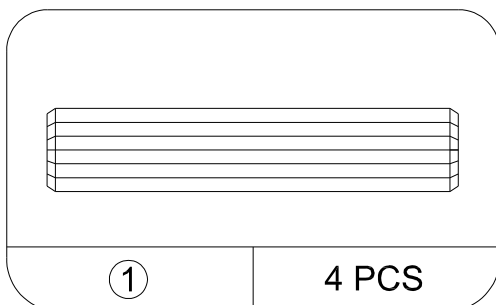
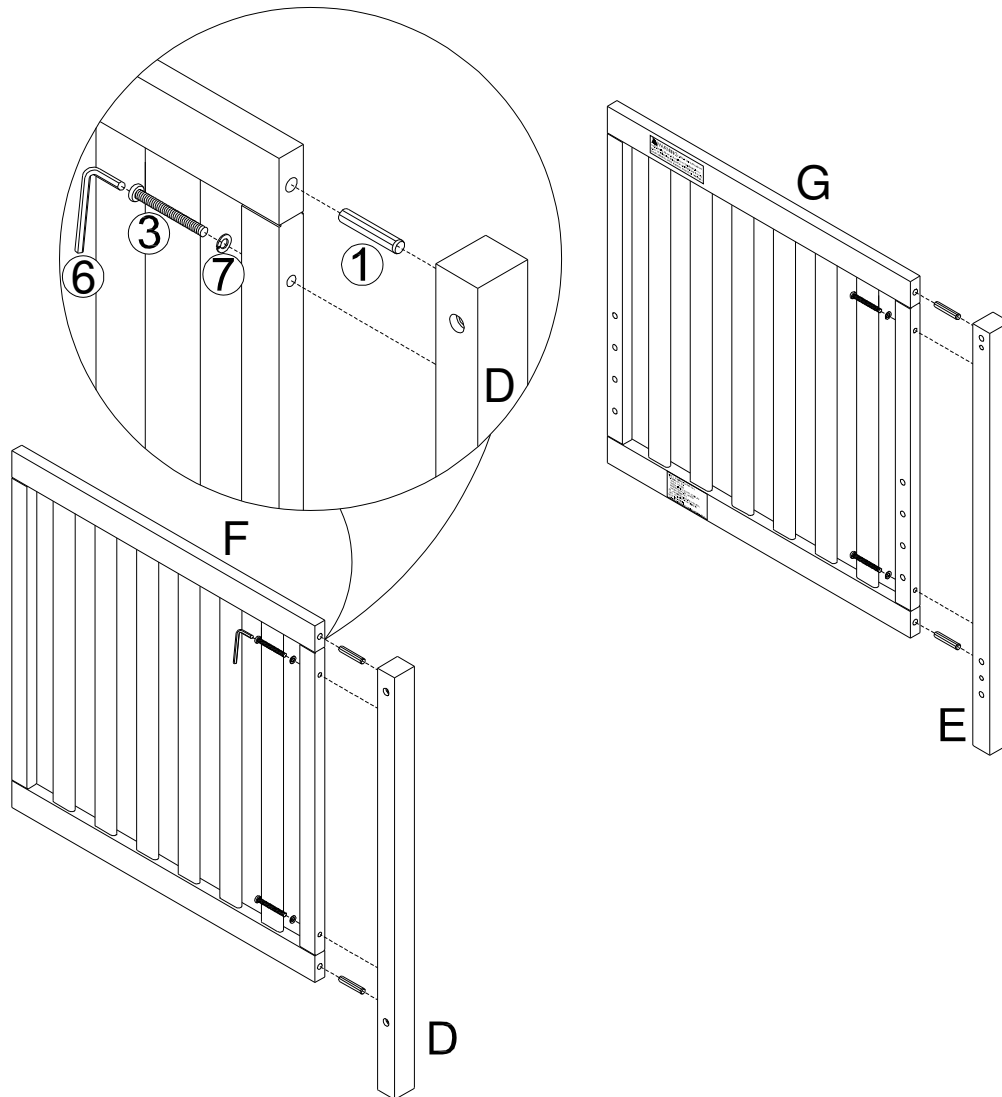

# Hayworth Crib DA7249 / DA7249W

## STEP 3:

Insert wood dowels (1) into the left side panel (F).

Attach the left side panel (F) to the back panel (C) with bolts (2) and spring washers (7) as shown. Use Allen key (6) to tighten the bolts.

Repeat this step to attach the right side panel (G) to back panel (C) as shown.

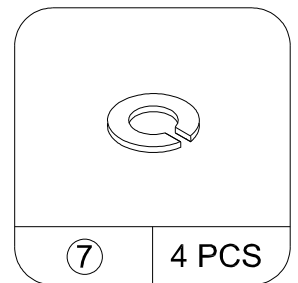
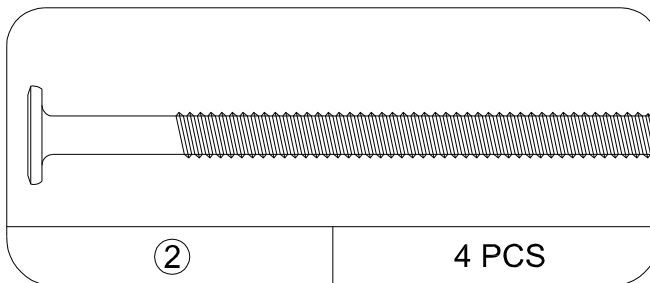
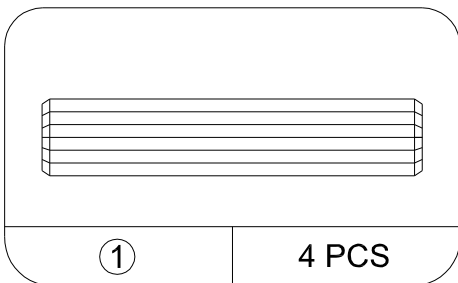
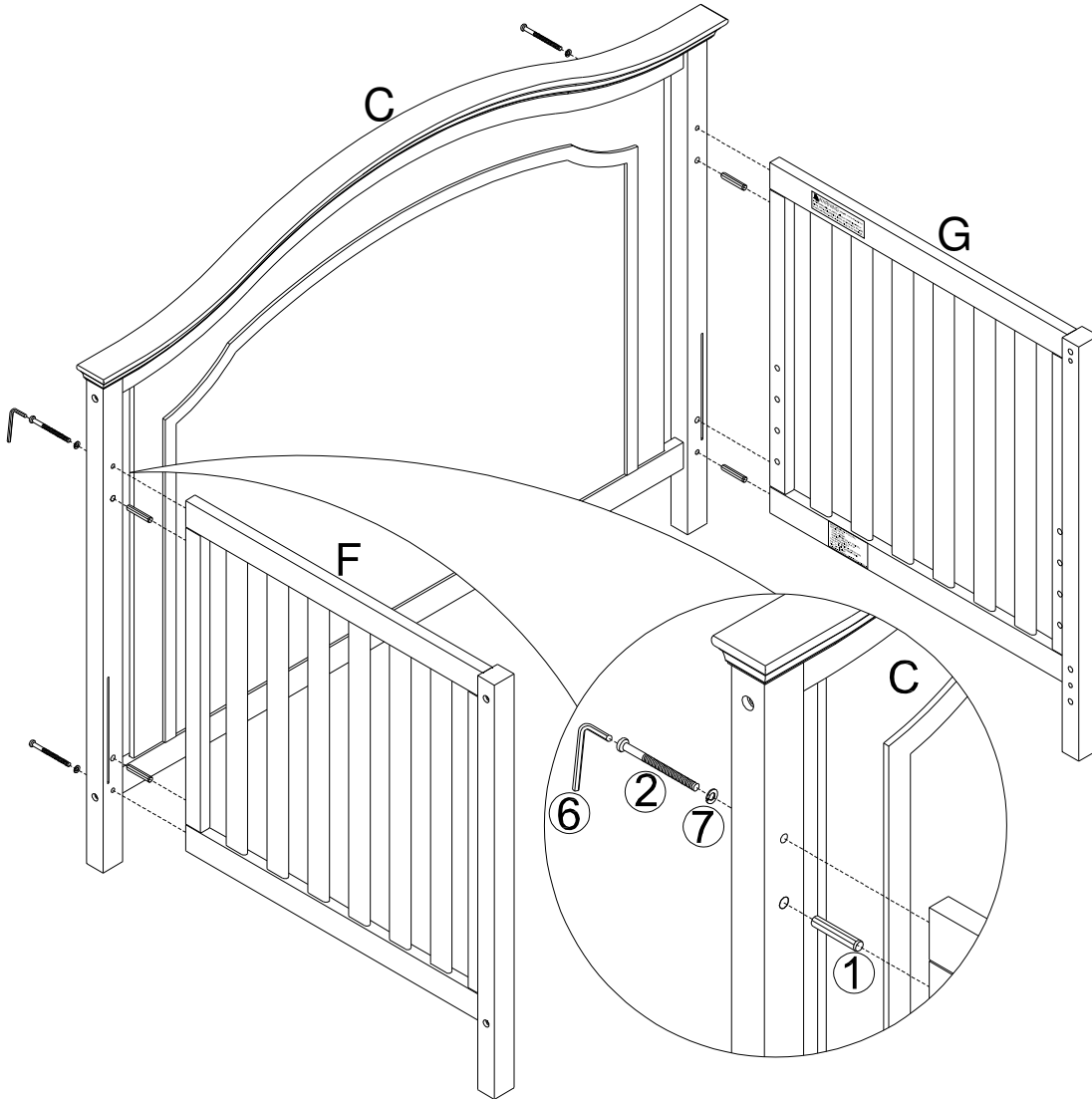



# Hayworth Crib DA7249 / DA7249W

## STEP 4:

Attach the mattress support (H) to the left and right side panels (F & G) with mattress support bolts (4) and spring washers (5). Use Allen key (6) to tighten the bolts.

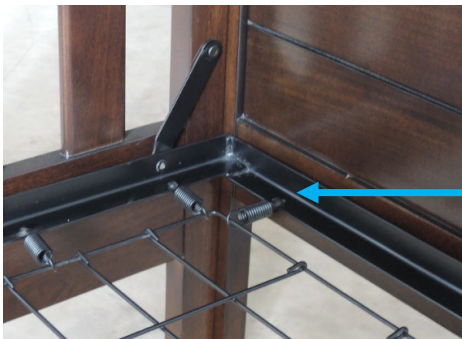
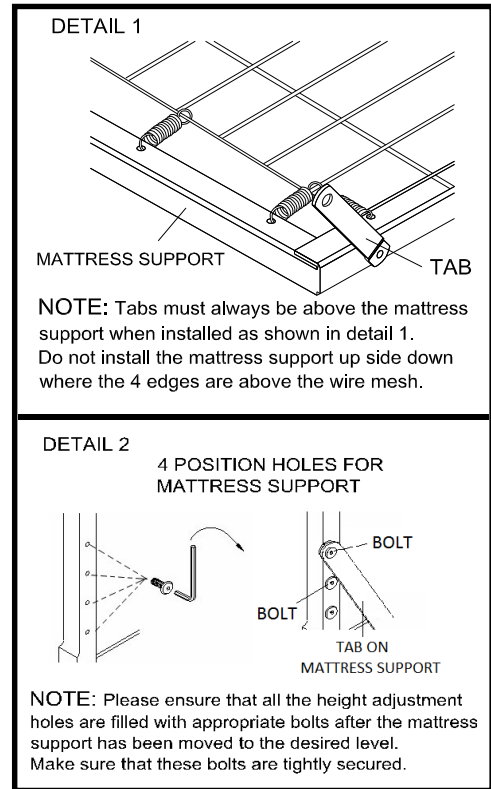
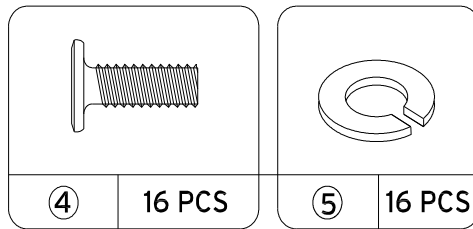
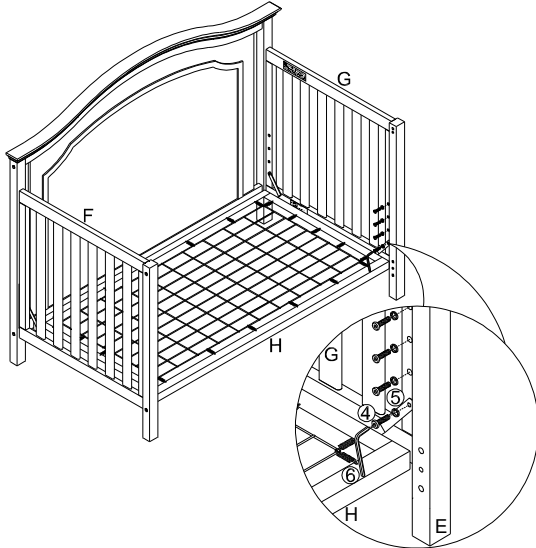

**INCORRECT-**  
Raised edge should face down -this photo shows mattress support is upside down.



**INCORRECT-**  
Tabs on corners of mattress support should point up.



**CORRECT** ✓

- \* Tabs to point UP.
- \* Flat surface of mattress support to face up - mattress must sit on flat surface.
- \* "THIS SIDE UP" label shows which side to face upward.

**NOTE:** The above photos and drawings showing how to properly attach the mattress support are for reference only. Crib styles and colors will vary.

# Hayworth Crib DA7249 / DA7249W

## STEP 5:

Insert wood dowels (1) into the front rail (J).

Attach the front rail (J) to the front panel (I) with bolts (3) and spring washers (7) as shown. Use Allen key (6) to tighten the bolts.

**NOTE: The curved edge of front rail (J) must face towards the ground.**

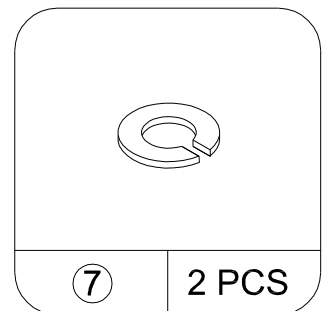
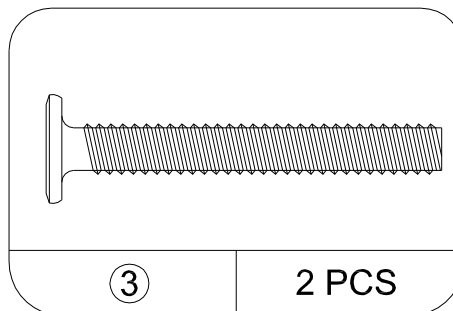
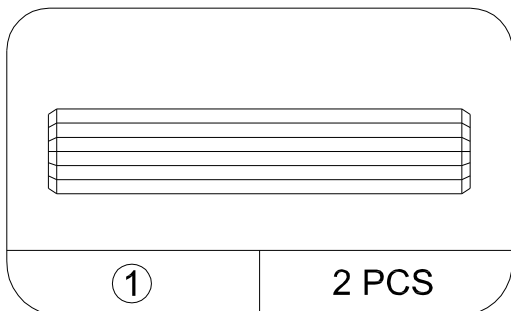
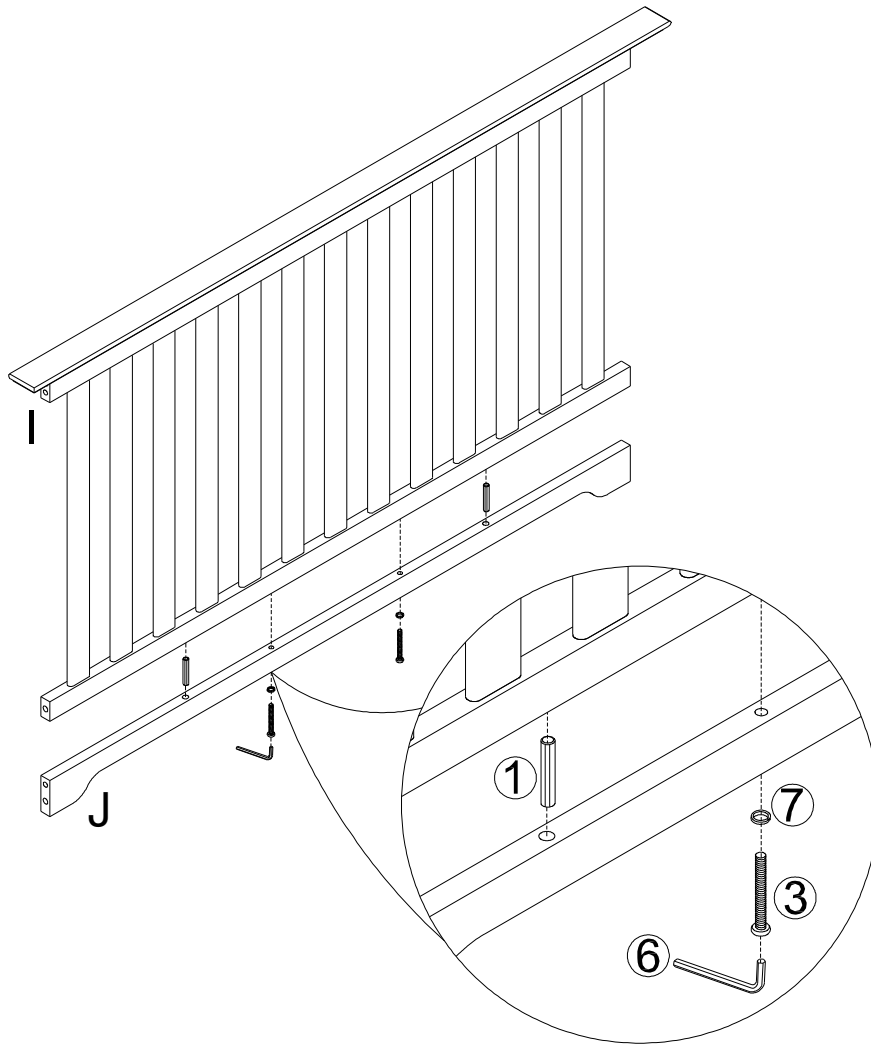

# Hayworth Crib DA7249 / DA7249W

## STEP 6:

Attach the assembled front panel (done in step 5) to left and right front posts (D & E) with wood dowels (1), bolts (2) and spring washers (7) as shown. Use Allen key (6) to tighten the bolts.

**NOTE:** When the child is able to stand on his/her own, place the mattress support at its lowest position.

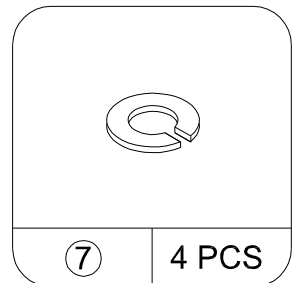
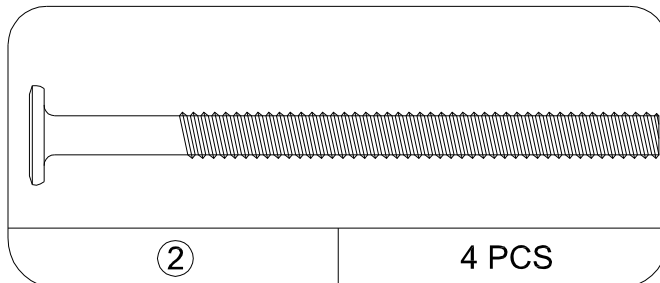
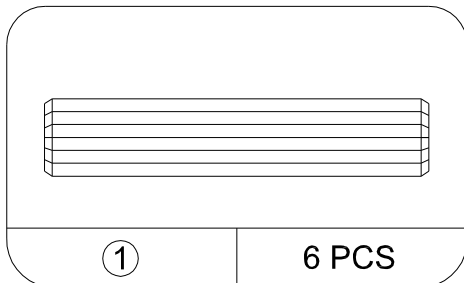
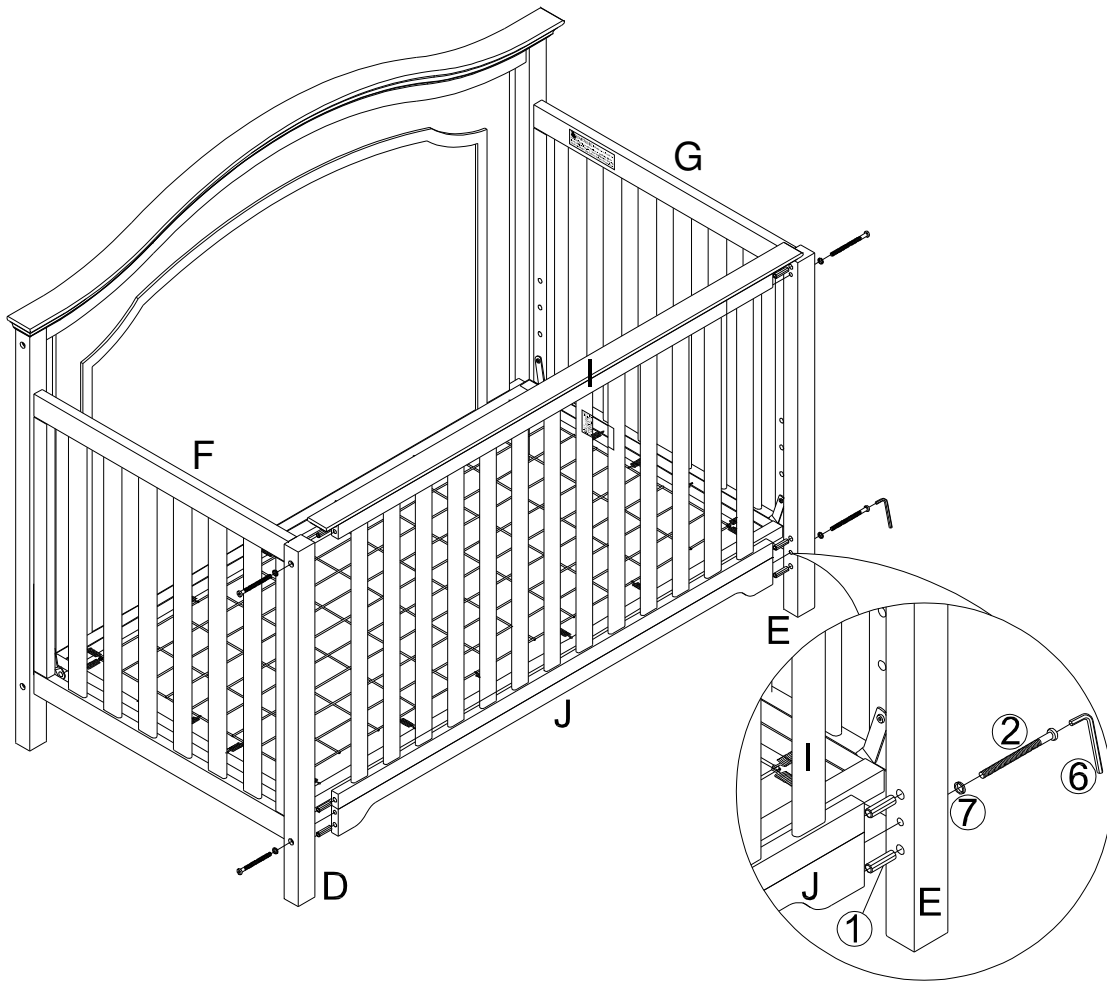

# Hayworth Crib

## DA7249 / DA7249W

### DAY BED ASSEMBLY INSTRUCTION

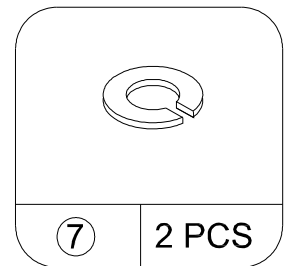
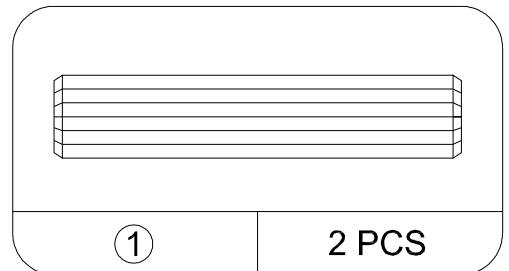
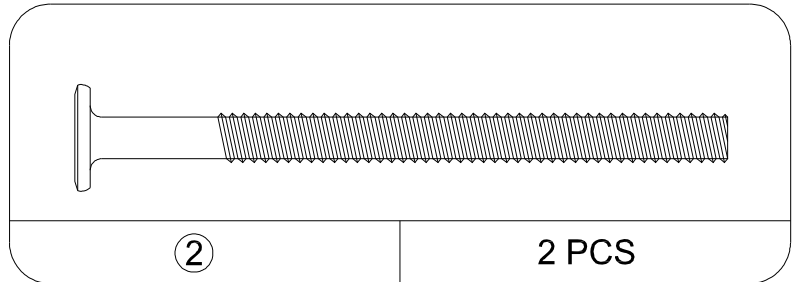
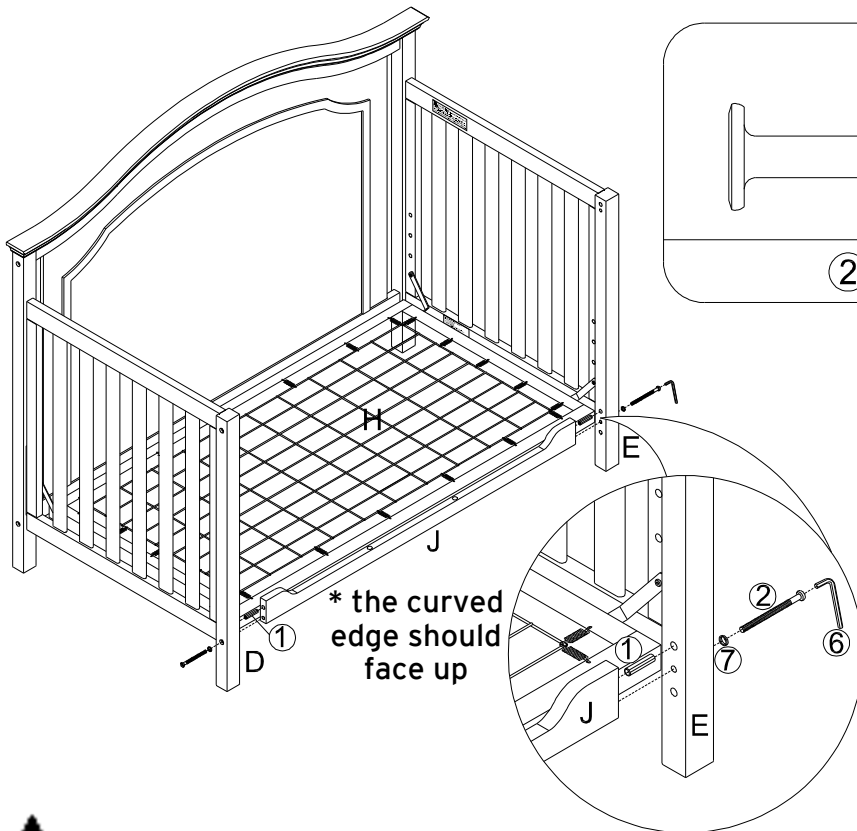

#### WARNINGS:

- \* Any mattress used in this crib must be at least 27-1/4 inches by 51-5/8 inches (69cm by 131cm) with a thickness not exceeding 6 inches (15cm).
- \* The day bed is not intended for children under 15 months of age or over 50 pounds (22.7 kgs).

#### DAY BED ASSEMBLY INSTRUCTION: STARTING FROM CRIB

- STEP 1:** Detach the assembled front panel (I) from the side posts (D & E) with Allen key (6).
- STEP 2:** Detach the front rail (J) from front panel (I) with Allen key (6).
- STEP 3:** Move the mattress support (H) to the lowest position by unscrewing bolts (4) with Allen key (6).
- STEP 4:** Attach the front rail (J) (the curved edge should face up) to the side front posts (D & E) with bolts (2), wood dowels (1), spring washers (7) and Allen key (6).

#### DAY BED ASSEMBLY INSTRUCTION: STARTING FROM SCRATCH

- STEP 1:** Follow steps 1 to 3 of the crib assembly instruction.
- STEP 2:** Follow steps 3 and 4 for the day bed assembly instruction located above (starting from crib).

# Hayworth Crib DA7249 / DA7249W

## FULL SIZE BED ASSEMBLY INSTRUCTION (HEADBOARD ONLY)

FULL SIZE CONVERSION RAILS AND LEGS ARE NOT INCLUDED. DIAGRAMS ARE FOR REFERENCE ONLY. BED RAILS MAY DIFFER FROM ILLUSTRATION.

STEP 1: Attach the full size conversion rails (not included) to the back panel (C) .

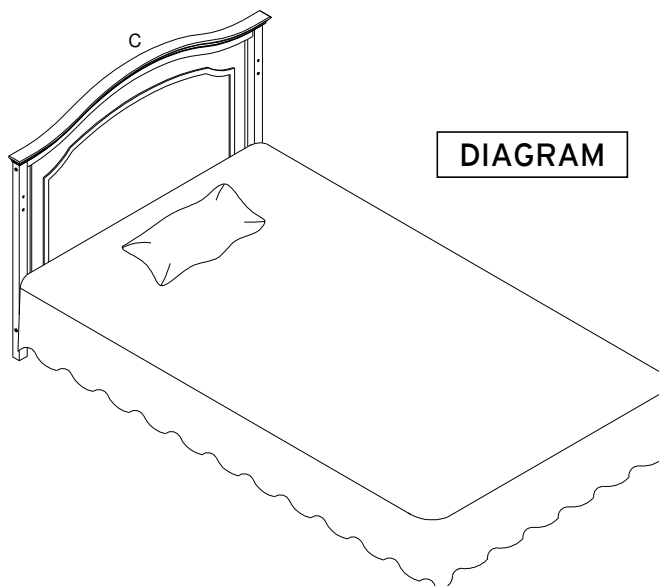
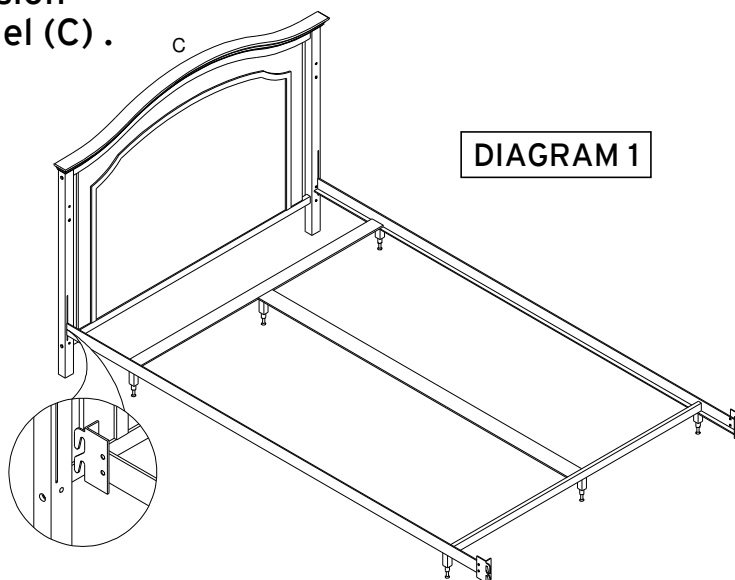

**IMPORTANT:** Store unused parts of "crib", "day bed" or "full size bed" for future use. ALWAYS STORE THE ASSEMBLY INSTRUCTIONS IN THE POUCH ATTACHED TO THE MATTRESS SUPPORT (H).

# Hayworth Crib DA7249 / DA7249W

## FULL SIZE BED ASSEMBLY INSTRUCTION (HEADBOARD AND FOOTBOARD ONLY)

FULL SIZE CONVERSION RAILS AND LEGS ARE NOT INCLUDED. DIAGRAMS ARE FOR REFERENCE ONLY. BED RAILS MAY DIFFER FROM ILLUSTRATION.

STEP 1: Attach the full size conversion rails (not included) to the back panel (C) and assembled front panel (D, E, I & J).

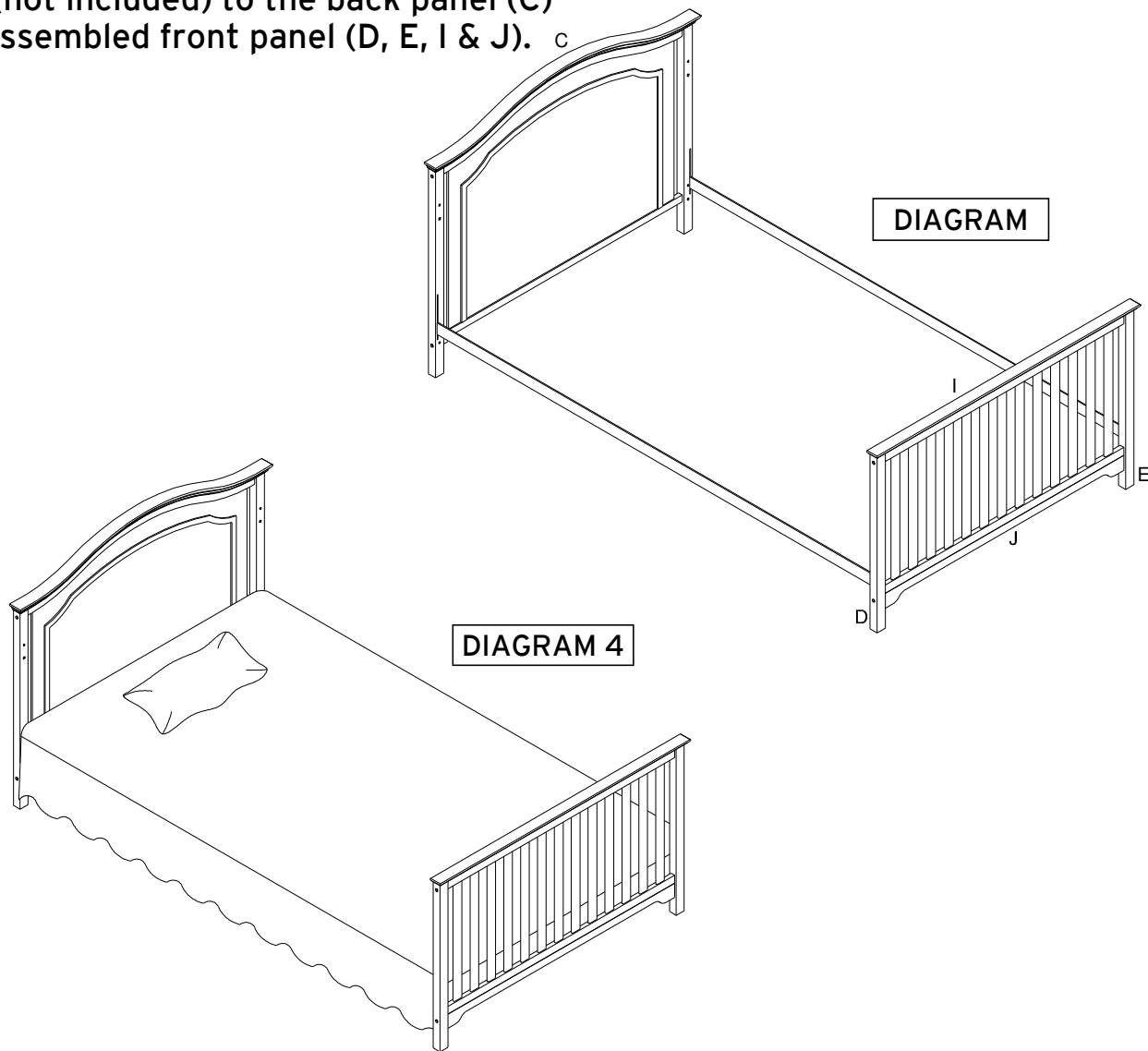

**IMPORTANT:** Store unused parts of "crib", "day bed" or "full size bed" for future use. ALWAYS STORE THE ASSEMBLY INSTRUCTIONS IN THE POUCH ATTACHED TO THE MATTRESS SUPPORT (H).

# Hayworth Crib

## DA7249 / DA7249W



**CAUTION:** This unit is intended for use only with the products and/or maximum weights indicated. Use with other products and/or products heavier than the maximum weights indicated may result in instability or cause possible injury.

ANY MATTRESS USED IN THIS CRIB MUST BE AT LEAST 27-1/4 INCHES BY 51-5/8 INCHES (69CM BY 131CM) WITH A THICKNESS NOT EXCEEDING 6 INCHES (15CM).

Stop using crib when child begins to climb out or reaches the height of 35.4 in. (90 cm).

Maximum weight not to exceed 50 pounds when used as a crib.

The DAY BED is not intended for children under 15 months of age or over 50 pounds.

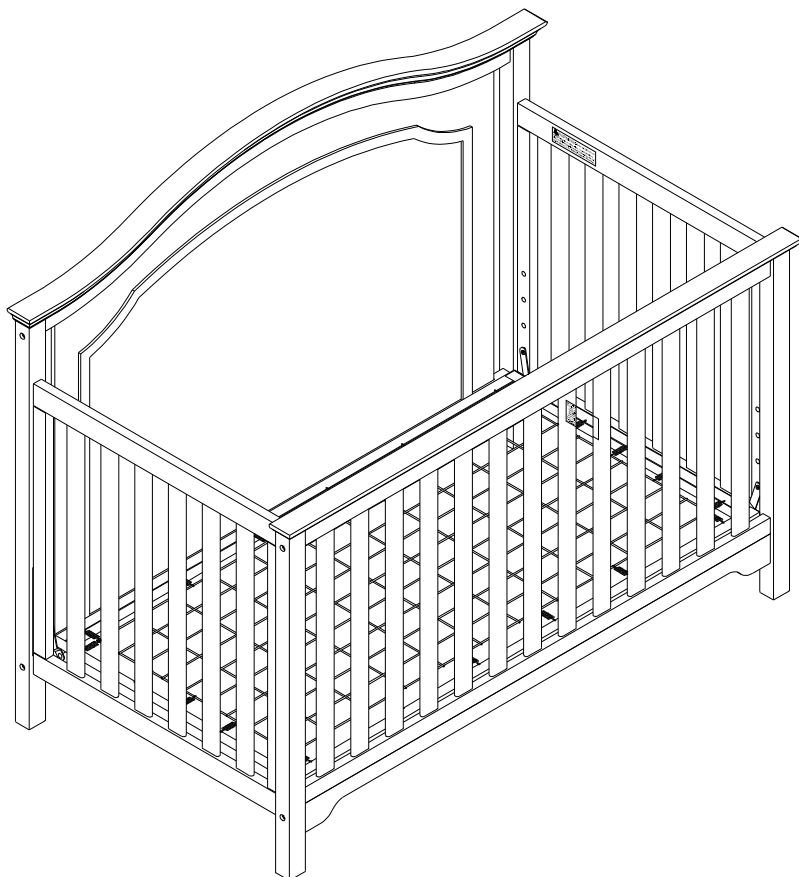

**That's it ! You've finished assembling your Hayworth Crib.**

**DO NOT RETURN PRODUCT TO THE STORE.**  
If a part is missing or damaged, contact our customer service department. We will replace the part FREE of charge.



Tel #: 1-800-295-1980  
E-Mail: [das@dorel.com](mailto:das@dorel.com)  
Fax #: 514-353-7819

# Customer Service

**PLEASE DO NOT RETURN THIS PRODUCT TO THE STORE**

**PLEASE CONTACT CUSTOMER SERVICE REPRESENTATIVES AT THE FOLLOWING NUMBERS SHOULD THERE BE ANY MISSING OR DEFECTIVE PART(S).**

Customer Service Phone Number 1-800-295-1980

Email: [das@dorel.com](mailto:das@dorel.com)

Customer Service Fax Number 514-353-7819

Request Date:

Name:

Shipping Address:

Street & Number:

City & State:

Zip Code:

Day Time Phone Number:   
(including area code)

Date & Place of Purchase:

Part(s) description and quantity (Please be sure to list model number or SKN number):

Customer Service Representative Mailing Address:

Customer Service Department No. 413, 12345 Albert-Hudon Boulevard, Suite 100, Montreal, QC, Canada, H1G 3L1